

MOOG[®]
STEERING & SUSPENSION

F3810

June 2011 | juin 2011 | junio 2011

Supersedes F3810 dated November 2001

Remplace F3810 daté de novembre 2001

Reemplaza a F3810 fecha: noviembre 2001

2011 Commercial Vehicle Master Chassis Catalog

Catalogue 2011 principal de pièces pour
châssis de véhicules commerciaux

Catálogo maestro de piezas de chasis
para vehículos comerciales 2011



THE PROBLEM SOLVER[®]

**FEDERAL
MOGUL**



MOOG HEAVY DUTY CHASSIS PARTS

With proven, lasting performance, MOOG® heavy duty chassis parts keep over-the-road and off-road vehicles going strong mile after mile. The precision engineering and advanced technology built into MOOG products provide reliable steering and chassis solutions for Class 4-8 vocations.

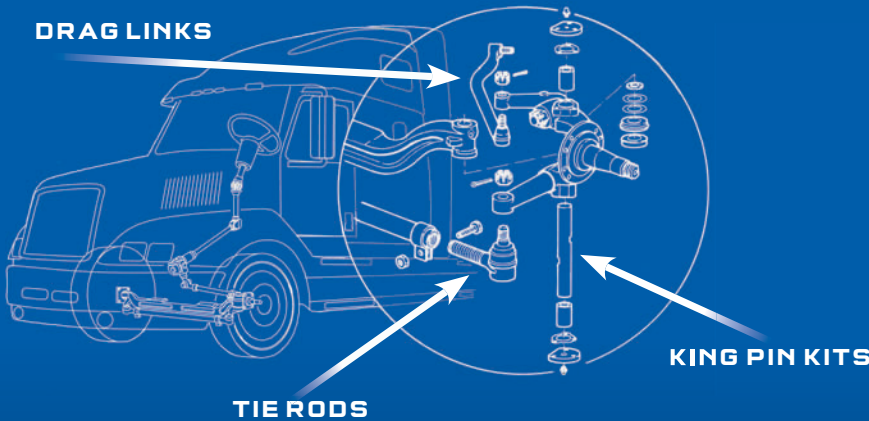

- HEAVY DUTY**
- Alignment Wedges
 - Drag Links
 - King Pin Sets
 - Steering Stabilizers
 - Tandem Alignment Shims
 - Tie Rod Ends
- MEDIUM DUTY**
- Ball Joints
 - Drag Links
 - Tie Rod Ends

Steering parts that endure.

<p>TIE ROD ENDS</p> 	<p>KING PIN KITS</p> 	<p>DRAG LINKS</p> 	<p>ALIGNMENT PRODUCTS</p> 
---	---	---	--

THE PROBLEM SOLVER®

MOOG®

STEERING & SUSPENSION



TIE ROD ENDS

A product of the MOOG® Problem Solver® heritage, MOOG heavy duty tie rod ends provide fleet-proven performance, delivering years of consistent steering effort in a strong, durable component that is engineered to install easily.

- Gusher-style lower bearing provides better lubrication to bearing surfaces for smoother steering.
- Precision-fit boot protects against dirt, road salt and other contaminants.
- Self-adjusting preload automatically reduces lash.



KING PIN KITS

MOOG king pin kits reflect our commitment to quality and innovation. These components are specifically engineered to work together, to improve original equipment technologies, and to solve real OE problems, delivering extended service life and consistent alignment.

- Quality engineered bearings deliver maximum load-carrying capabilities that meet or exceed OE.
- Case-hardened and precision-ground pins offer strength and durability.
- Bushings feature special grease patterns for improved lubrication and extended service life.
- Extra shims ensure proper alignment.



DRAG LINKS

Engineered for maximum strength and durability, MOOG drag links improve handling and reduce tire wear. Their innovative features and problem-solving design make them the perfect choice for technicians and fleet managers.

- Centering groove in lower bearing keeps preload spring centered to ensure even and consistent spring pressure.
- Thicker preloaded spring with 3x more pressure keeps ball stud seated and reduces deflection.
- Made from high-strength tubular steel or forged from solid steel for maximum strength.
- Non-adjustable and adjustable designs allow for proper toe adjustment, improving handling and reducing tire wear.
- Precision-fit boot protects against dirt, road salt and other contaminants.

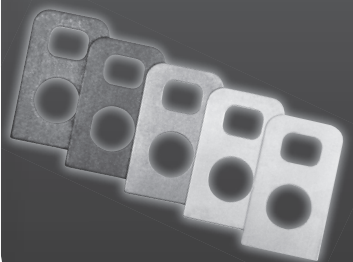

ALIGNMENT PRODUCTS

Alignment work presents challenges for technicians – problems that a generic assortment of “will-fit” parts cannot always solve. MOOG alignment shims give you the quality, engineering and experience it takes to perform proper alignments.

- Uni-wedge truck caster shims
- Truck caster shims
- Tandem shims



Abex[®]
COMMERCIAL GRADE FRICTION™



Abex Brake Offering

Linings

- Utilize the same materials, processes and quality standards required by OE customers
- The first choice of demanding, quality-conscious fleets
- Engineered for superior stopping power, optimum lining life and minimal drum wear
- Deliver the most efficient cost-per-mile braking in the industry



Lined Shoes

- Strength and integrity relined shoes can't provide
- Available in the most popular applications
- Manufactured with proprietary technology — preventing concavity and convexity after welding
- Electro-coated with a high gloss finish for superior corrosion protection



Stop Box Kits

- The complete braking solution — eliminates guesswork and parts hunting
- All-in-one packages feature two new OEM quality lined shoes, OEM approved brake lining and a complete heavy duty hardware kit



Air Brake Commercial Vehicle Brake Pads

- High performance under most temperatures and conditions
- Patented cast iron backplates and an integrally molded V-groove design greatly improves heat dispersal and eliminates excessive material stress
- Stops faster with enhanced durability for long lasting performance
- Compatible with ABS/ESP systems

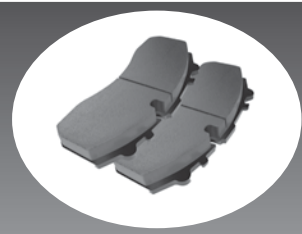

TABLE OF CONTENTS

Guide to Catalog Use	I
Abbreviations	IV
New Number List	IV
Alignment Products	V
Steering Stabilizers	IX
HD EZ Wheel & Brake Drum Centering Sleeves and Tool Set	XI
Application Listing	
Autocar	1
Blue Bird	4
Brockway	8
Chevrolet Truck	11
Clark Axle	42
Dana/Spicer Axle	43
Diamond T	53
Divco	54
Dodge Truck	55
Eaton	70
F1850	74
Fabco	75
Ford Truck	76
Freightliner	125
GMC Truck	133
Hendrickson	156
Hino	157
Isuzu	158
Kenworth	160
Mack	171
Marmon	183
Mitsubishi	185
Navistar/IHC Truck	186
Peterbilt	228
Rockwell	232
Sterling Truck	241
Thomas Built	244
Volvo/White/GMC	247
Western Star	251
Westport Axle	252
White Truck	254
Workhorse	260
Appendices	
Numerical List/Buyers Guide	261
King Pin Sets	283
King Pin Bushing	289
King Pin Bushing to King Pin Crossover	291
King Pin Illustrated	293
Tie Rod Ends	301
Tie Rod Illustrated	305
Drag Links	311
Drag Links Illustrated	315
Interchanges	325

GUIDE TO CATALOG USE

GUIDE D'UTILISATION DU CATALOGUE

GUÍA PARA EL USO DEL CATÁLOGO

Follow these easy steps to find the king pin sets you need:

1. Locate manufacturer — see table of contents for page number
2. Locate model or axle number.
3. Determine the correct axle rating and years, then refer to the correct commodity section (i.e., King Pin Sets).
4. Additional information is available in the form of size, OEM number and remarks.
5. For king pin sets, choose the desired bushing type.
6. The required part number may also be found by OEM interchanges or progressive size charts.

Example/Exemple/Ejemplo:

Be sure to determine bushing type.
Assurez-vous de déterminer le genre de coussinet.
Tenga en cuenta que debe determinar el tipo de buje.

CHEVROLET

T5500								
King Bolt Sets								
Axle Lbs. Rating	Code	Year	Diameter (inches)	Length (Inches)	Pin Type	Bushing	Notes	King Pin Set No.
8,100	(FL1)	1997-2000	1.614	8.035	8	Metal	w/Hydraulic Brakes	8659B
11,000	(FL2)	1997-2000	1.892	9.203	8	Metal		8660B
12,000	(FS7)	1997-2000	1.892	9.604	8	Metal		8661B
14,000	(FH0)	1997-2000	1.892	9.604	8	Metal		8661B
14,500	(FL3)	1997-2000	1.892	9.604	8	Metal		8661B
14,600	(FL3)	1997-2000	1.892	9.604	8	Metal		8661B
16,000	(PH4)	1997-2000	1.870	9.970	1	Composite		8633C
16,000	(PH4)	1997-2000	1.870	9.970	1	Metal		8633B

Suivre les étapes faciles pour trouver les ensembles de pivots centraux dont vous avez besoin:

1. Localiser le fabricant — consulter l'index ci-dessus qui contient la liste par ordre alphabétique.
2. Trouver le modèle ou le numéro d'essieu.
3. Déterminer les caractéristiques nominales et l'année de l'essieu puis consulter la section des items variés variés (ex. Ensembles de pivots centraux).
4. Des informations additionnelles sont disponibles sur les dimensions, le numéro du fabricant d'origine et des remarques.
5. Pour trouver les ensembles de pivots centraux, choisissez le type de coussinet désiré.
6. Le numéro de pièce recherché peut aussi être trouvé par les numéros d'échange du fabricant d'origine ou du tableau avec dimension progressives.

Siga estos fáciles pasos para encontrar los juegos de pivotes que necesita:

1. Localice el fabricante; vea el número de página en el índice.
2. Localice el modelo o el número del eje.
3. Determine la correcta especificación y años del eje, y luego consulte la sección de artículos que corresponda (es decir: Juegos de pivotes).
4. Existe información adicional sobre tamaño y número del fabricante de equipo original (OEM), y comentarios.
5. Para los juegos de pivotes, elija el tipo de buje que desea.
6. El número de pieza requerido puede encontrarse también en los cuadros de intercambios de fabricantes de equipo original (OEM) o de tamaños progresivos.

GUIDE TO CATALOG USE (CON'T.)

GUIDE D'UTILISATION DU CATALOGUE

GUÍA PARA EL USO DEL CATÁLOGO

Follow these easy steps to find the tie rod ends you need:

1. Locate manufacturer — see table of contents for page number
2. Locate model or axle number.
3. Determine the correct axle rating and years, then refer to the correct commodity section (i.e., Tie Rod Ends).
4. Additional information is available in the form of size, OEM number and remarks.
5. For tie rod ends, determine if the part number is needed for the driver's side or the passenger side.
6. The required part number may also be found

Example/Exemple/Ejemplo:

Be sure to determine if part is for the driver's or passenger's side. Assurez-vous de déterminer le genre de coussinet. Tenga en cuenta que debe determinar el tipo de buje.

Tie Rod Ends					Tie Rod End Part No.	
Axle Lbs. Rating	Code	Year	Length (Inches)	Notes	Drivers Side	Passenger Side
8,100	(FL1)	1997-2000	5.44		ES3270L	ES3271R
11,000	(FL2)	1997-2000	5.44		ES3274L	ES3275R
12,000	(FS7)	1997-2000	5.44		ES3274L	ES3275R
14,000	(FH0)	1997-2000	5.44		ES3274L	ES3275R
14,500	(FL3)	1997-2000	5.44		ES3274L	ES3275R
14,600	(FL3)	1997-2000	5.44		ES3274L	ES3275R
16,000	(FH4)	1997-2000	7.37		ES2090L	ES2091R

Suivre les étapes faciles pour trouver embouts de biellettes de direction dont vous avez besoin:

1. Localiser le fabricant — consulter l'index ci-dessus qui contient la liste par ordre alphabétique.
2. Trouver le modèle ou le numéro d'essieu.
3. Déterminer les caractéristiques nominales et l'année de l'essieu puis consulter la section des items variés (ex. Embout de biellette de direction).
4. Des informations additionnelles sont disponibles sur les dimensions, le numéro du fabricant d'origine et des remarques.
5. Pour les embouts de biellettes de direction, déterminer si le numéro de pièce requis est pour le côté conducteur ou passager.
6. Le numéro de pièce recherché peut aussi être trouvé par les numéros d'échange du fabricant d'origine ou du tableau avec dimension progressives.

Siga estos fáciles pasos para encontrar las rótulas de barra de acoplamiento que necesita:

1. Localice el fabricante; vea los números de página en el índice.
2. Localice el modelo o el número del eje.
3. Determine la correcta especificación y años del eje, y luego consulte la sección de artículos que corresponda (es decir: Rótulas de barra de acoplamiento).
4. Existe información adicional sobre tamaño y número del fabricante de equipo original (OEM), y comentarios.
5. Para las rótulas de barra de acoplamiento, determine si el número de pieza necesario corresponde al lado del conductor o al lado del pasajero.
6. El número de pieza requerido puede encontrarse también en los cuadros de intercambios de fabricantes de equipo original (OEM) o de tamaños progresivos.

GUIDE TO CATALOG USE (CON'T.)

GUIDE D'UTILISATION DU CATALOGUE

GUÍA PARA EL USO DEL CATÁLOGO

Follow these easy steps to find the drag links you need:

1. Locate manufacturer — see table of contents for page number
2. Locate model or axle number.
3. Determine the correct axle rating and years, then refer to the correct commodity section (i.e., Drag Links).
4. Additional information is available in the form of size, OEM number and remarks.
5. The required part number may also be found by OEM interchanges or progressive size charts.

Example/Exemple/Ejemplo:

Drag Links					
Axle Lbs. Rating	Code	Year	Length (inches)	Notes	Drag Link No.
8.100	(FL1)	1997-2000	20.28	w/Air Brakes	DS1277
8.100	(FL1)	1997-2000	20.65	w/Hydraulic Brakes	DS1216
11.000	(FL2)	1997-2000	17.48	w/Ross Steering Gear	DS1217
11.000	(FL2)	1997-2000	20.28	w/Air Brakes and Saginaw Steering	DS1277
11.000	(FL2)	1997-2000	20.65	w/Hydraulic Brakes and Saginaw Steering	DS1216
12.000	(FS7)	1997-2000	16.85	w/Air Brakes	DS1278
12.000	(FS7)	1997-2000	17.48	w/Hydraulic Brakes 1997-98	DS1217
14.600	(FL3)	1997-2000	16.85		DS1278

Cinq étapes faciles pour trouver les pièces dont vous avez besoin:

1. Localiser le fabricant — consulter l'index ci-dessus qui contient la liste par ordre alphabétique.
2. Trouver le modèle ou le numéro d'essieu.
3. Déterminer les caractéristiques nominales et l'année de l'essieu puis consulter la section des items variés (ex. barres d'accouplement).
4. Des informations additionnelles sont disponibles sur les dimensions, le numéro du fabricant d'origine et des remarques.
5. Le numéro de pièce recherché peut aussi être trouvé par les numéros d'échange du fabricant d'origine ou du tableau avec dimension progressives.

Siga estos fáciles pasos para encontrar las bielas de dirección que necesita:

1. Localice el fabricante; vea el número de página en el índice.
2. Localice el modelo o el número del eje.
3. Determine la correcta especificación y años del eje, y luego consulte la sección de artículos que corresponda (es decir: Bielas de dirección).
4. Existe información adicional sobre tamaño y número del fabricante de equipo original (OEM), y comentarios.
5. El número de pieza requerido puede encontrarse también en los cuadros de intercambios de fabricantes de equipo original (OEM) o de tamaños progresivos.

New Part Number List

Liste De Nouveaux Numeros De Pieces

New Part Numbers/Nouveaux Numeros De Pieces

<p>1/16" TANDEM SHIMS K100032 K100035</p> <p>1/16" VANHOOL SHIMS K100041 K100044</p> <p>1/32" TANDEM SHIMS K100031 K100034</p> <p>1/32" VANHOOL SHIMS K100040 K100043</p> <p>1/8" TANDEM SHIMS K100033 K100036</p> <p>1/8" VANHOOL SHIMS K100042 K100045</p> <p>Caster Shim 1/16" K100075 K100078</p> <p>Caster Shim 1/32" K100074 K100077</p> <p>Caster Shim 1/8" K100076 K100079</p>	<p>Drag Link Assembly DS300001 DS300002</p> <p>FREIGHTLINER TORQUE ARM SHIM K100028</p> <p>FREIGHTLINER TORQUE ARM SHIMS K100029 K100030</p> <p>HENDRICKSON WALKING BEAM SHIM KIT K100027</p> <p>IHC TORQUE ARM SHIM 1/16 K100038</p> <p>IHC TORQUE ARM SHIMS 1/32 K100037</p> <p>IHC TORQUE ARM SHIMS 1/8" K100039</p> <p>King Bolt Sets 8001C 8002C 8003C 8004C</p>	<p>8005C 8006C 8007C 8008C</p> <p>Thrust Line/Bogey Shim 1/16" K100081</p> <p>Thrust Line/Bogey Shim 1/32" K100080</p> <p>Thrust Line/Bogey Shim 1/8" K100082</p> <p>Tie Rod Assembly ES800420 ES800421 ES800422 ES800423 ES800424 ES800425</p> <p>Wheel and Drum Centering Sleeves K100051 K100052 K100053</p> <p>Wheel Centering Tool Set T40005</p>
---	---	--

ABBREVIATIONS/ABRÉVIATIONS/ABREVIATURAS

Abbr.	English	Français	Español	Abbr.	English	Français	Español
Alum.	Aluminum	Aluminium	Aluminio	No.	Number	Numero	Número
Assy.	Assembly	Ensemble	Conjunto	O.E.M.	Original Equipment Manufacturer	Equipement Manufactureur d'origine	Fabricante de equipo original
Brks.	Brakes	Freins	Frenos	lb.	Pound	Livre	Libra
BBC	Bumper to Back of Cab	Du pare-chocs a l'arriere de l'habitacle	Distancia desde el parachoques hasta la cara posterior de la cabina	Pwr.	Power	Puissance	Potencia
Bush.	Bushing	Coussinet	Buje	P.S.	Power Steering	Direction	Dirección
Dim.	Dimension	Dimension	Dimensión	R/B:	Replaced by:	Remplace par:	Reemplazado por:
Exc.	Except	Excepté	Excepto	RH	Right Hand	Côté droit	Lado derecho
HD	Heavy Duty	Extra-robuste	Servicio pesado	Std.	Standard	Régulier	Estándar
Hyd.	Hydraulic	Hydraulique	Hidráulico	Strg.	Steering	Volant	Dirección
LH	Left Hand	Côté gauche	Lado izquierdo	&	Superseded	Perime	Sustituido
Man.	Manual	Manuel	Manual	u/	Use	Utiliser	usen
M.S.	Manual Steering	Direction standard	Dirección manual	W.B.	Wheel Base	Empattement	Distancia entre ejes
				W/	With	Avec	Con
				W/O	Without	Sans	Sin

ALIGNMENT WEDGES

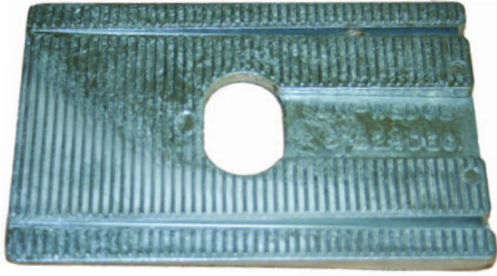

Truck Caster Wedges

"Uni-Wedge"

"3-in-1" Truck Caster Adjustment Wedges

- One shim covers three spring widths by breaking off from 4" to 3-1/2" or 3"
- Made of special heavy-duty zinc alloy for durable service

Part No.	Width	Degree	Std. Qty.
K8910	3", 3-1/2", 4"	1/2°	1 ea.
K8911	3", 3-1/2", 4"	1°	1 ea.
K8912	3", 3-1/2", 4"	1-1/2°	1 ea.
K8913	3", 3-1/2", 4"	2°	1 ea.
K8914	3", 3-1/2", 4"	2-1/2°	1 ea.
K8915	3", 3-1/2", 4"	3°	1 ea.
K8916	3", 3-1/2", 4"	3-1/2°	1 ea.
K8917	3", 3-1/2", 4"	4°	1 ea.



Manganese Bronze Wedges

Heavy Duty Bronze Caster Wedges

- The toughest material available for super heavy-duty service

Part No.	Width	Degree	Std. Qty.	Part No.	Width	Degree	Std. Qty.
K8878	2-1/2"	1/2°	1 ea.	K8880	3-1/2"	1/2°	1 ea.
K8882	2-1/2"	1°	1 ea.	K8884	3-1/2"	1°	1 ea.
K8886	2-1/2"	1-1/2°	1 ea.	K8888	3-1/2"	1-1/2°	1 ea.
K8890	2-1/2"	2°	1 ea.	K8892	3-1/2"	2°	1 ea.
K8894	2-1/2"	2-1/2°	1 ea.	K8896	3-1/2"	2-1/2°	1 ea.
K8898	2-1/2"	3°	1 ea.	K8900	3-1/2"	3°	1 ea.
K8902	2-1/2"	3-1/2°	1 ea.	K8904	3-1/2"	3-1/2°	1 ea.
K8906	2-1/2"	4°	1 ea.	K8908	3-1/2"	4°	1 ea.
K8879	3"	1/2°	1 ea.	K8881	4"	1/2°	1 ea.
K8883	3"	1°	1 ea.	K8885	4"	1°	1 ea.
K8887	3"	1-1/2°	1 ea.	K8889	4"	1-1/2°	1 ea.
K8891	3"	2°	1 ea.	K8893	4"	2°	1 ea.
K8895	3"	2-1/2°	1 ea.	K8897	4"	2-1/2°	1 ea.
K8899	3"	3°	1 ea.	K8901	4"	3°	1 ea.
K8903	3"	3-1/2°	1 ea.	K8905	4"	3-1/2°	1 ea.
K8907	3"	4°	1 ea.	K8909	4"	4°	1 ea.

KING PIN SHIM ASSORTMENTS



Organize Your King Pin Shims

Now for those King Pin replacement jobs that require extra shims... order individual bags (20 shims each) from 18 different shim sizes, or the organizer assortment which allows for easy and efficient access to a wide range of shim sizes.

Assortment No. RS 600 contains one bag of the following shims (20 Shims per bag).

Part No.	I.D.	O.D.	Thickness	Part No.	I.D.	O.D.	Thickness
RS505	.840"	1.437"	.005"	RS529	1.281"	1.875"	.010"
RS565	.906"	1.500"	.005"	RS590	1.390"	2.230"	.005"
RS500	.953"	1.500"	.010"	RS502	1.500"	2.375"	.005"
RS501	1.156"	1.750"	.010"	RS573	1.625"	2.688"	.005"
RS589	1.200"	1.940"	.005"	RS587	1.805"	2.500"	.005"
RS531	1.270"	2.010"	.005"	RS503	1.875"	2.812"	.005"
				RS504	2.010"	3.250"	.005"

TANDEM ALIGNMENT SHIMS

Heavy Duty Truck Alignment Assortment

K8918 CONTAINS: 6 each of the 1/32", 1/16" & 1/8" shims from the IHC, Peterbilt, Freightliner Airglide, Freightliner Airleaf, Freightliner 1990, Volvo/White and Wilson series as well as 2 of each size Kenworth "8 bagger" spacers (1", 3/4", 1/2", 1/4", 1/8", 1/16", and 1/32").

Truck & Trailer alignment specification and sturdy metal storage case included! 140 shims and spacers in all!



Wilson Tandem Shim Hutchins Suspension

Part No.	Thickness	Quantity
K8919	1/32"	12
K8920	1/16"	12
K8921	1/8"	12



Peterbilt Air Leaf Adjustment Shim

Part No.	Thickness	Quantity
K8922	1/32"	12
K8923	1/16"	12
K8924	1/8"	12



TANDEM ALIGNMENT SHIMS



1990 Freightliner Shim

Single Slot for '90-up Air Ride Suspension

Part No.	Thickness	Quantity
K8925	1/32"	12
K8926	1/16"	12
K8927	1/8"	12



Freightliner Adjusting Shim

For Air-Ride Suspension thru '89

Part No.	Thickness	Quantity
K8928	1/32"	12
K8929	1/16"	12
K8930	1/8"	12



Freightliner Air Glide Shim

Part No.	Thickness	Quantity
K8931	1/32"	12
K8932	1/16"	12
K8933	1/8"	12



Volvo/White Tandem Shim

Part No.	Thickness	Quantity
K8934	1/32"	12
K8935	1/16"	12
K8936	1/8"	12



IHC Torque Arm Shim

Part No.	Thickness	Quantity
K8937	1/32"	12
K8938	1/16"	12
K8939	1/8"	12

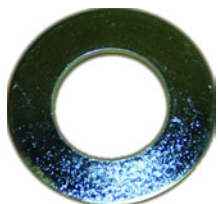

Kenworth Air Glide "8 Bagger" Spacers

Part No.	Thickness	Quantity
K8940	1/32"	6
K8941	1/16"	6
K8942	1/8"	6
K8943	1/4"	6
K8944	1/2"	6
K8945	3/4"	6
K8946	1"	6

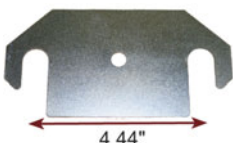

Freightliner Torque Arm Shims

Part No.	Thickness	Quantity
K100028	1/32"	12
K100029	1/16"	12
K100030	1/8"	12

NEW ALIGNMENT PARTS

Hendrickson Heavy Duty Axles-Walking Beam Shim Kit

Part No.

K100027



Peterbilt/Kenworth Tandem Axle

Part No.

Thickness

Quantity

K100031

1/32"

12

K100032

1/16"

12

K100033

1/8"

12



Peterbilt/Kenworth Low Air Shims

Part No.

Thickness

Quantity

K100034

1/32"

12

K100035

1/16"

12

K100036

1/8"

12

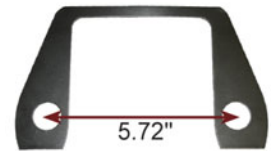

International Trk Torque Arm Shims

Part No.

Thickness

Quantity

K100037

1/32"

12

K100038

1/16"

12

K100039

1/8"

12



Vanhool Shim Lower Control Arm and Bogey Axle

Part No.

Thickness

Quantity

Slot Length

Slot Width

K100040

1/32"

12

1

5/8

K100041

1/16"

12

1

5/8

K100042

1/8"

12

1

5/8

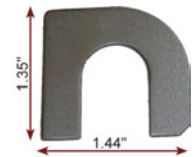

Vanhool Shim Upper Control Arm and Drive Axle

Part No.

Thickness

Quantity

Slot Length

Slot Width

K100043

1/32"

12

1

3/4

K100044

1/16"

12

1

3/4

K100045

1/8"

12

1

3/4

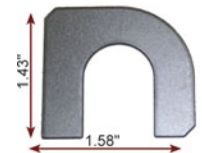

Prevost Bus

Part No.

Thickness

Quantity

Slot Length

Slot Width

K100074

1/32"

12

4-1/8

1-1/4

K100075

1/16"

12

4-1/8

1-1/4

K100076

1/8"

12

4-1/8

1-1/4

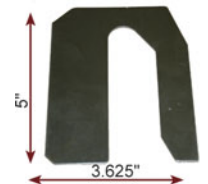

Prevost Bus H & XL Series Steer Axle

Part No.

Thickness

Quantity

Slot Length

Slot Width

K100077

1/32"

12

1-1/4

5/6

K100078

1/16"

12

1-1/4

5/6

K100079

1/8"

12

1-1/4

5/6

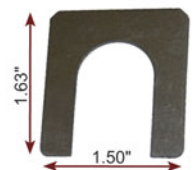

Prevost Bus H & XL Series Drive Axle & Bogey Axle Scrub

Part No.

Thickness

Quantity

Slot Length

Slot Width

K100080

1/32"

12

4-1/2

1

K100081

1/16"

12

4-1/2

1

K100082

1/8"

12

4-1/2

1

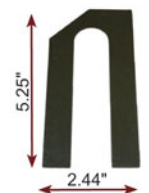

STEERING STABILIZERS

Universal Kits Fit Class 7 and Up – Chevrolet, Ford, Navistar GMC, Mack, Kenworth, Peterbilt, etc. 9,000 to 20,000 Pound Front Axle (Fits the large Rockwell, Timken, Eaton and Mack Front Axles)

Bracket Kit + Cylinder + Bellows Kit = Complete Kit

Application Specifications	Bracket Kit No.	Stabilizer Cylinder No.	Bellows Kit No.
Kit for Tie Rod 1-1/2" to 1-3/4" diameter and 3/4" diameter Spring Hanger U-Bolts (Dim. "A"). Fits Dim. "B" – Minimum 2-9/16", Maximum 4-1/4"	SSD39	SSD43*	SSD114 Black
Kit for Tie Rod 2" to 2-1/2" diameter and 3/4" diameter Spring Hanger U-Bolts (Dim. "A"). Fits Dim. "B" – Minimum 2-9/16", Maximum 4-1/8" w	SSD40	SSD43*	SSD114 Black
Kit for Tie Rod 2" to 2-1/2" diameter and 7/8" diameter Spring Hanger U-Bolts (Dim. "A"). Fits Dim. "B" – Minimum 2-9/16", Maximum 4" w	SSD115	SSD43*	SSD114 Black
Kit for Tie Rod 1-1/4" to 1-3/4" diameter and 7/8" diameter Spring Hanger U-Bolts (Dim. "A"). Fits Dim. "B" – Minimum 2-7/16", Maximum 4" w	SSD116	SSD43*	SSD114 Black
Kit for Tie Rod 1-1/2" to 1-3/4" diameter and 7/8" diameter Spring Hanger U-Bolts (Dim. "A"). Fits Dim. "B" – Minimum 3-7/8", Maximum 5-3/8" w	SSD117	SSD43*	SSD114 Black
Kit for Tie Rod 2" to 2-1/2" diameter and 7/8" diameter Spring Hanger U-Bolts (Dim. "A"). Fits Dim. "B" – Minimum 3-7/8", Maximum 5-3/8" w	SSD118	SSD43*	SSD114 Black
Kit for I.H. Axle No. FA-339 and Dana No. 1-120. Fits 1-1/4" to 1-3/4" tie rod diameter.	SSD119	SSD43*	SSD114 Black

* Do not install on vehicles with the rod end movement over 12-1/2!"

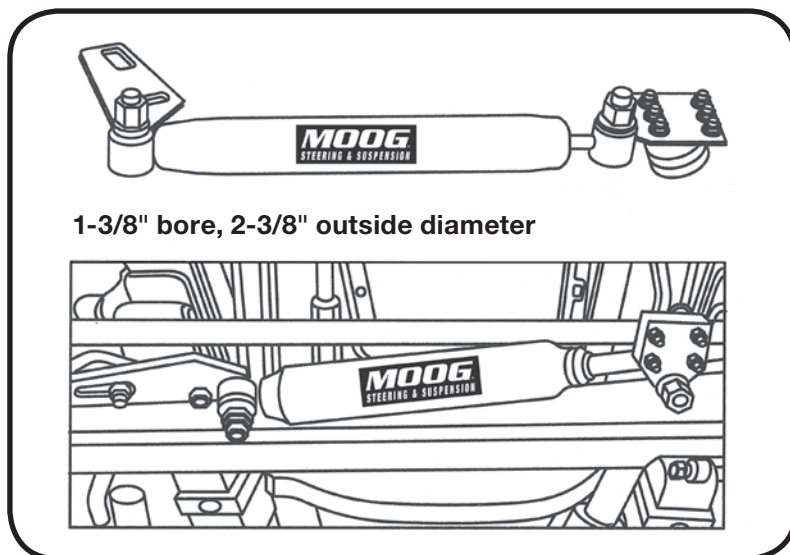
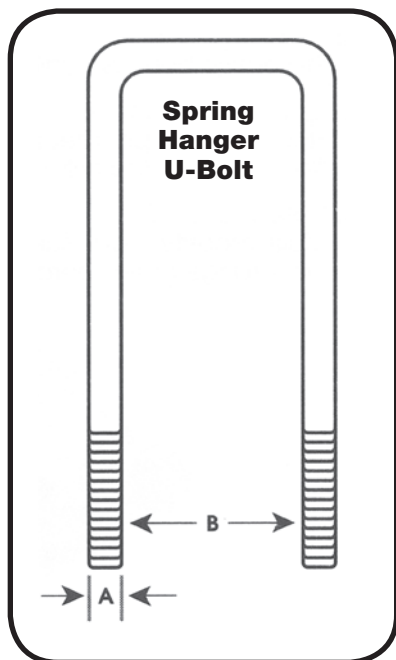

STEERING STABILIZERS

1. **Premium Rubber Bushings**
Prevents binding when suspension travel and steering linkage movement is extreme.
2. **Bellows**
Protective bellows available in black.
3. **Spring-Loaded Seal**
Heavy duty wiping seal prevents contaminants from entering the cylinder.
4. **Rated to -50° F**
Multi-viscosity shock fluid for performance over a wide range of temperatures.
5. **Nitrogen Gas Cell**
Low pressure cell prevents air from entering cylinder, eliminating fluid foaming and erratic operation.
6. **“E” coating**
Electrically applied coating provides long-lasting corrosion resistance. The E-coat process is environmentally friendly.
7. **Chrome Rod**
9/16" high carbon steel piston rod, hardened to prevent breakage and chrome-plated for corrosion resistance.

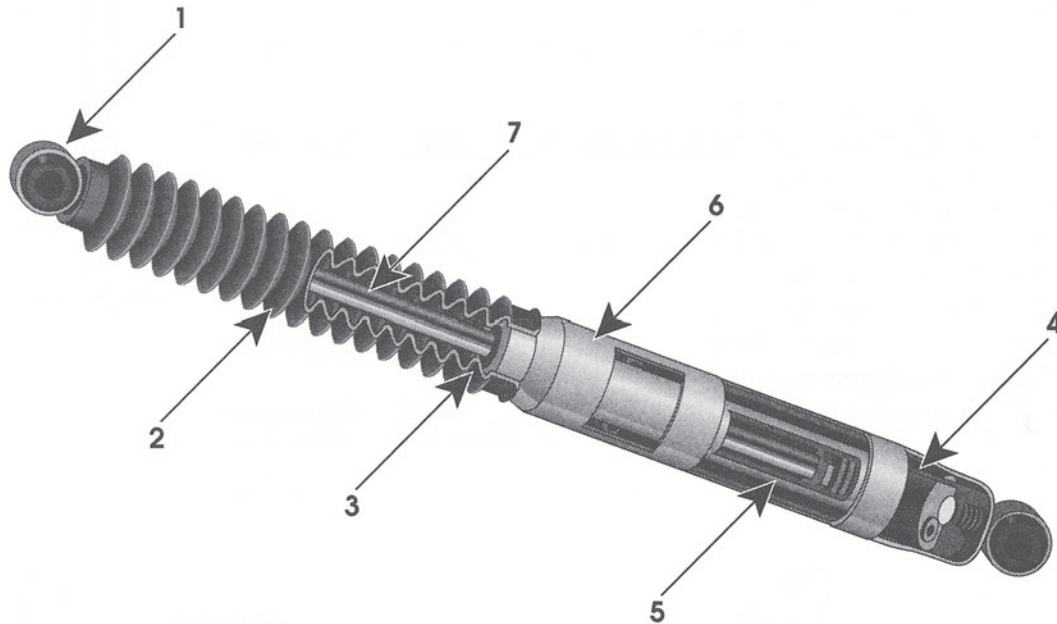

SCHOOL BUS STEERING STABILIZERS

Year	Model & Description	Part No.
1950-2010	Chevrolet, Dodge, Ford, GMC, International Chassis – Standard I Beam Axle up to 7,000 pounds rating. Fits axles up to 3-3/4" x 4" high. Tie rod up to 1-5/8" (Do not install on vehicles with tie rod movement over 9-1/4".)	SSD16*
1950-2010	Standard I Beam Axle up to 9,000 pounds rating. Fits axles up to 3-3/4" x 4" high. Tie rod up to 1-5/8" diameter. Includes 1-1/2 to 2-1/2 ton school bus chassis. (Do not install on vehicles with tie rod movement over 11".)	
	ORDER CYLINDER	SSD102*
	ORDER BRACKET	SSD103*

* Excluding vehicles with slave cylinder power steering.

HD EZ WHEEL & BRAKE DRUM CENTERING SLEEVES AND TOOL SET

HD EZ WHEEL & BRAKE DRUM CENTERING SLEEVES (6 SLEEVES)

PART NO. K100051, K100052, K100053

These sets center both Steer Axle HD wheels and brake drums to minimize wheel vibrations, brake pedal pulsations and wheel hop. Simply slide the sleeves over the 22mm wheel studs and seat against the face of the hub at the 12, 4 and 8 o'clock positions. Reinstall the cast brake drum and mount the wheel over the studs and onto the protruding diameter of the sleeve. Install lug nuts and torque in the proper sequence, using the recommended manufacturer's torque specifications.



22mm Steer Wheel Brake Drum Type	Dimensions	Wheel Type	Part No.	Qty.
Gunite 3573X, 3596X, 3597X, 3598X, 3686X, 3687X, 3710X, 3721AX, 3726X, 3758X, 3774X, 3800X	1.25" hole/ .5" depth	Alum.	K100051*	6
Webb 61528B, 65548B Arvin Meritor 53-123448-002, 53-123567-002, 53123568-002	.25" depth	Steel	K100052*	6
Gunite 9000X, 9001X, 9035X Motor Wheel Centrifuse 89870BK, 90089BK, 90174BK Arvin Meritor 53-123512-002, 53-123542-002	1.25" hole/ .25" depth to .3125" depth	Alum.	K100053*	6

* T40005 Centering Tool Set required to install.

HD EZ WHEEL CENTERING TOOL SET (3 PIECE)

PART NO. T40005

The new T40005 Heavy Duty Wheel Centering Tool Set corrects off-center wheel/stud combinations that can cause wheel hop, vibrations and premature tire wear. When remounting the wheel/tire assembly onto a hub piloted mount, the wheel rests on the upper pilot. This can produce a gap on the other pilots, causing the off-centered condition. Simply slide the three centering tapered tools over the wheel studs at the 12, 8 and 4 o'clock positions, then mount the wheel and add lug nuts. Remove the tools and replace remaining lug nuts, torquing to manufacturer's specifications. The wheel is now completely centered.



AUTOCAR TRUCK MODEL FINDING INDEX			
Model	Model	Model	Model
A42	A64	C10364S	C85
C85T	C87	C87D	C9564
C9764	C9764S	CK64	CK64ST
D87-OH	DC102T	DC10364	DC10364S
DC103T	DC10464	DC10464S	DC42
DC64	DC87T	DC9364	DC9564
DC9764	DC9964	DK64	K42
K64	KL64	KM42	KM64
KMS64F	KS42	KS64	S42
S64			

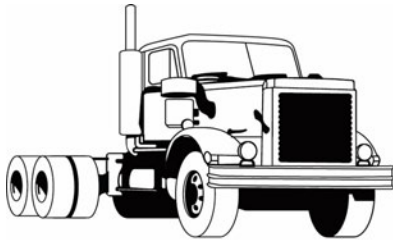

A-S Series



K Series

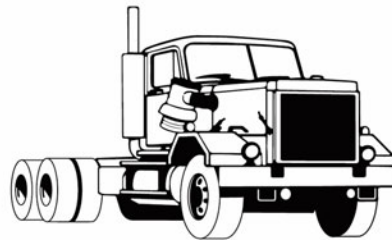

D C Series

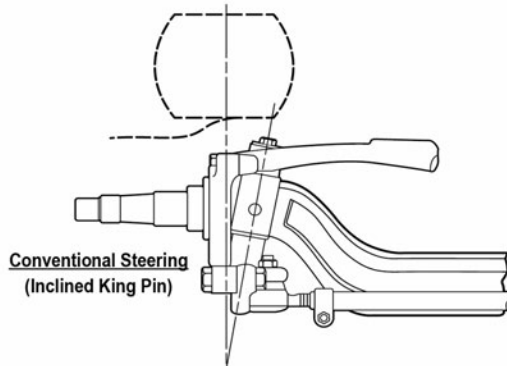

**Conventional Steering
(Inclined King Pin)**

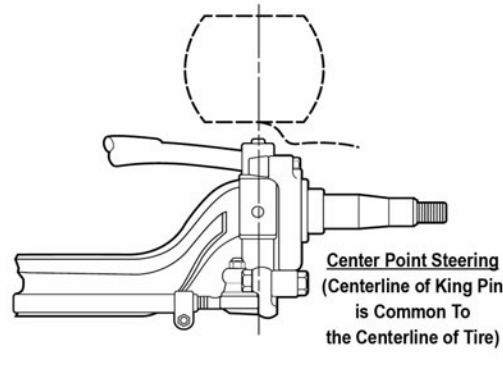

**Center Point Steering
(Centerline of King Pin
is Common To
the Centerline of Tire)**

A42, S42, A64, S64

King Bolt Sets

Axle Lbs. Rating	Code	Year	Diameter (inches)	Length (Inches)	Pin Type	Bushing	Notes	King Pin Set No.
11,000	(FE900)	1970-1980	1.309/1.607"	9.750"	7	Metal		8386B
	(FE900)	1970-1980	1.309/1.607"	9.750"	7	Nylon		8386N
12,000	(FE970)	1970-1980	1.607"	8.812"	2	Metal		8514B
	(FE970)	1970-1980	1.607"	8.812"	2	Nylon		8514N
	(FF901)	1970-1980	1.794"	9.120"	2	Metal		8489B
	(FF901)	1970-1980	1.794"	9.120"	2	Nylon		8489N
	(FF921)	1970-1980	1.794"	10.392"	2	Metal		8553B

Tie Rod Ends

Axle Lbs. Rating	Code	Year	Length (Inches)	Notes	Tie Rod End Part No.	
					Drivers Side	Passenger Side

A42, S42, A64, S64 (Cont'd)

Tie Rod Ends (Cont'd)

Axle Lbs. Rating	Code	Year	Length (Inches)	Notes	Tie Rod End Part No.	
					Drivers Side	Passenger Side
11,000	(FE900)	1970-1980	4.88"		ES187L	ES187R
	(FE900)	1970-1980	5.75"		ES431L	ES431R
12,000	(FE970)	1970-1980	10.50"	Repair kit Will Retrofit Older Axles	ESK371	ESK371
	(FE970)	1970-1980			ES2200L	ES2201R
	(FE970)	1970-1980	4.88"	ES187L	ES187R	
	(FE970)	1970-1980	5.75"	ES431L	ES431R	
	(FF901)	1970-1980	4.88"	ES187L	ES187R	
	(FF901)	1970-1980	5.75"	ES346L	ES346R	
	(FF901)	1970-1980	5.75"	ES431L	ES431R	
	(FF921)	1970-1980	5.44"	1-1/8"-18 Optional Thread	ES3312R	ES3312R
	(FF921)	1970-1980	5.44"		ES423L	ES423R

C85, C85T, C87, C87D, D87-OH, DC102T, DC103T, C9564, DC9564, C9764, C9764S, DC9764, C10364S, DC10364S, DC10464, DC10464S

King Bolt Sets

Axle Lbs. Rating	Code	Year	Diameter (inches)	Length (Inches)	Pin Type	Bushing	Notes	King Pin Set No.
16,000	(FG900)	1958-1960	1.400/1.794"	10.688"	7	Metal		8474B

Tie Rod Ends

Axle Lbs. Rating	Code	Year	Length (Inches)	Notes	Tie Rod End Part No.	
					Drivers Side	Passenger Side
16,000	(FG900)	1958-1960	4.88"		ES187L	ES187R

CK64, CK64ST

King Bolt Sets

Axle Lbs. Rating	Code	Year	Diameter (inches)	Length (Inches)	Pin Type	Bushing	Notes	King Pin Set No.
16,000	(FH901)	1970-1975	1.999"	11.040"	2	Metal		8518B
	(FH901)	1970-1975	1.999"	11.040"	2	Nylon		8518N
18,000	(FL901)	1970-1975	1.999"	11.040"	2	Metal		8518B
	(FL901)	1970-1975	1.999"	11.040"	2	Nylon		8518N
20,000	(FL931)	1970-1975	1.999"	11.212"	2	Metal		8571B

Tie Rod Ends

Axle Lbs. Rating	Code	Year	Length (Inches)	Notes	Tie Rod End Part No.	
					Drivers Side	Passenger Side
16,000	(FH901)	1970-1975	5.75"		ES431L	ES431R
18,000	(FL901)	1970-1975	5.75"		ES431L	ES431R
20,000	(FL931)	1970-1975	12.69"		ES3031L	ES3030R
	(FL931)	1970-1975	5.44"		ES423L	ES423R
	(FL931)	1970-1975	5.75"		ES431L	ES431R
	(FL931)	1970-1975	7.37"		ES2090L	ES2091R

DC42, K42, KM42, KS42, DC64, DK64, K64, KL64, KM64, KS64, KMS64F

King Bolt Sets

Axle Lbs. Rating	Code	Year	Diameter (inches)	Length (Inches)	Pin Type	Bushing	Notes	King Pin Set No.
16,000	(FH901)	1978-1980	1.999"	11.040"	2	Metal		8518B
	(FH901)	1978-1980	1.999"	11.040"	2	Nylon		8518N
18,000	(FL901)	1978-1980	1.999"	11.040"	2	Metal		8518B
	(FL901)	1978-1980	1.999"	11.040"	2	Nylon		8518N
20,000	(FL931)	1978-1980	1.999"	11.212"	2	Metal		8571B

Tie Rod Ends

Axle Lbs. Rating	Code	Year	Length (Inches)	Notes	Tie Rod End Part No.	
					Drivers Side	Passenger Side
16,000	(FH901)	1978-1980	5.75"		ES431L	ES431R
18,000	(FL901)	1978-1980	5.75"		ES431L	ES431R
20,000	(FL931)	1978-1980	12.69"		ES3031L	ES3030R
	(FL931)	1978-1983	5.44"		ES423L	ES423R
	(FL931)	1978-1980	5.75"		ES431L	ES431R

DC42, K42, KM42, KS42, DC64, DK64, K64, KL64, KM64, KS64, KMS64F (Cont'd)

Tie Rod Ends (Cont'd)

Axle Lbs. Rating	Code	Year	Length (Inches)	Notes	Tie Rod End Part No.	
					Drivers Side	Passenger Side
20,000	(FL931)	1978-1980	7.37"		ES2090L	ES2091R

DC87T, DC9364, DC9964, DC10364

King Bolt Sets

Axle Lbs. Rating	Code	Year	Diameter (inches)	Length (Inches)	Pin Type	Bushing	Notes	King Pin Set No.
16,000	(FH901)	1970-1980	1.999"	11.040"	2	Metal		8518B
	(FH901)	1970-1980	1.999"	11.040"	2	Nylon		8518N
18,000	(FL901)	1970-1980	1.999"	11.040"	2	Metal		8518B
	(FL901)	1970-1980	1.999"	11.040"	2	Nylon		8518N
20,000	(FL931)	1970-1980	1.999"	11.212"	2	Metal		8571B

Tie Rod Ends

Axle Lbs. Rating	Code	Year	Length (Inches)	Notes	Tie Rod End Part No.	
					Drivers Side	Passenger Side
16,000	(FH901)	1970-1980	5.75"		ES431L	ES431R
18,000	(FL901)	1970-1980	5.75"		ES431L	ES431R
20,000	(FL931)	1970-1980	12.69"		ES3031L	ES3030R
	(FL931)	1970-1980	5.44"		ES423L	ES423R
	(FL931)	1970-1980	5.75"		ES431L	ES431R
	(FL931)	1970-1980	7.37"		ES2090L	ES2091R

BLUE BIRD TRUCK MODEL FINDING INDEX			
Model	Model	Model	Model
Airtek Suspension	All American	All American FE	Express Commuter Coach
SCHOOL BUS - Various Thread	Softek Suspension	Ultra FL	Vision
Wander Lodge 450LXI	Wander Lodge M380	Xcel 102	

All American FE

King Bolt Sets								
Axle Lbs. Rating	Code	Year	Diameter (inches)	Length (Inches)	Pin Type	Bushing	Notes	King Pin Set No.
13,200	(FF932)		1.794"	10.392"	2	Metal		8590B

Tie Rod Ends						
Axle Lbs. Rating	Code	Year	Length (Inches)	Notes	Tie Rod End Part No.	
					Drivers Side	Passenger Side
13,200	(FF982)		5.44"		ES423L	ES423R
	(FF984)		5.44"		ES423L	ES423R
	(FF986)		5.44"		ES423L	ES423R

All American, Airtek Suspension

Tie Rod Ends						
Axle Lbs. Rating	Code	Year	Length (Inches)	Notes	Tie Rod End Part No.	
					Drivers Side	Passenger Side
12,000			8.12"	1 1/4" -12 Thread	ES3298L	ES3297R
14,600			8.12"	1 1/4" -12 Thread	ES3298L	ES3297R

All American, Softek Suspension

Tie Rod Ends						
Axle Lbs. Rating	Code	Year	Length (Inches)	Notes	Tie Rod End Part No.	
					Drivers Side	Passenger Side
13,200			8.12"	1 1/4" -12 Thread	ES3298L	ES3297R
14,600			8.12"	1 1/4" -12 Thread	ES3298L	ES3297R

Express Commuter Coach

King Bolt Sets								
Axle Lbs. Rating	Code	Year	Diameter (inches)	Length (Inches)	Pin Type	Bushing	Notes	King Pin Set No.
16,000	(FL931)		1.999"	11.212"	2	Metal		8571B
	(FL933)		1.999"	11.212"	2	Metal		8571B
	(FL941)		1.999"	11.212"	2	Metal		8571B
	(FL943)		1.999"	11.212"	2	Metal		8571B
	(FL951)		1.999"	11.212"	2	Metal		8571B

Tie Rod Ends						
Axle Lbs. Rating	Code	Year	Length (Inches)	Notes	Tie Rod End Part No.	
					Drivers Side	Passenger Side
16,000	(FL931)		12.69"		ES3031L	ES3030R
	(FL931)		5.75"		ES431L	ES431R
	(FL931)		7.37"		ES2090L	ES2091R
	(FL933)		12.69"		ES3031L	ES3030R
	(FL933)		5.75"		ES431L	ES431R
	(FL933)		7.37"		ES2090L	ES2091R
	(FL941)		12.69"		ES3031L	ES3030R
	(FL941)		5.75"		ES431L	ES431R
	(FL941)		7.37"		ES2090L	ES2091R
	(FL943)		12.69"		ES3031L	ES3030R
	(FL943)		5.75"		ES431L	ES431R
	(FL943)		7.37"		ES2090L	ES2091R
	(FL951)		12.69"		ES3031L	ES3030R
	(FL951)		5.75"		ES431L	ES431R
	(FL951)		7.37"		ES2090L	ES2091R

SCHOOL BUS - Various Thread

Tie Rod Ends

Axle Lbs. Rating	Code	Year	Length (Inches)	Notes	Tie Rod End Part No.	
					Drivers Side	Passenger Side
12,000	(FF933)		5.44"	1-1/8"-18 Optional Thread		ES3312R
	(FF934)		5.44"	1-1/8"-18 Optional Thread		ES3312R
	(FF941)		5.44"	1-1/8"-18 Optional Thread		ES3312R
	(FF942)		5.44"	1-1/8"-18 Optional Thread		ES3312R
	(FF943)		5.44"	1-1/8"-18 Optional Thread		ES3312R
	(FF944)		5.44"	1-1/8"-18 Optional Thread		ES3312R
13,200	(FF932)		5.44"	1-1/8"-18 Optional Thread	ES423L	ES3312R
	(FF932)		5.44"	1-1/8"-18 Optional Thread		ES423R
14,600	(FG931)		5.44"	1-1/8"-18 Optional Thread		ES3312R
	(FG933)		5.44"	1-1/8"-18 Optional Thread		ES3312R
	(FG941)		5.44"	1-1/8"-18 Optional Thread		ES3312R
	(FG943)		5.44"	1-1/8"-18 Optional Thread		ES3312R

Ultra FL

King Bolt Sets

Axle Lbs. Rating	Code	Year	Diameter (inches)	Length (Inches)	Pin Type	Bushing	Notes	King Pin Set No.
10,000	(FD961)		1.790"	10.390"	2	Composite		80063C
	(FD961)		1.790"	10.390"	2	Metal		80063B

Tie Rod Ends

Axle Lbs. Rating	Code	Year	Length (Inches)	Notes	Tie Rod End Part No.	
					Drivers Side	Passenger Side
10,000	(FD961)		5.44"		ES423L	ES423R

Vision, Airtek Suspension

Tie Rod Ends

Axle Lbs. Rating	Code	Year	Length (Inches)	Notes	Tie Rod End Part No.	
					Drivers Side	Passenger Side
12,000			10.32"	1 1/4 " -12 Thread	ES800421	ES800420
12,500			10.32"	1 1/4 " -12 Thread	ES800421	ES800420

Vision, Softek Suspension

Tie Rod Ends

Axle Lbs. Rating	Code	Year	Length (Inches)	Notes	Tie Rod End Part No.	
					Drivers Side	Passenger Side
8,000			10.32"	1 1/4 " -12 Thread	ES800421	ES800420
10,000			10.32"	1 1/4 " -12 Thread	ES800421	ES800420

Wander Lodge 450LXI

King Bolt Sets

Axle Lbs. Rating	Code	Year	Diameter (inches)	Length (Inches)	Pin Type	Bushing	Notes	King Pin Set No.	
14,000	(FG931)		1.790"	10.390"	2	Composite		8635C	
	(FG931)		1.790"	10.390"	2	Metal		8611B	
	(FG933)		1.790"	10.390"	2	Composite		8635C	
	(FG933)		1.790"	10.390"	2	Metal		8611B	
	(FG941)		1.790"	10.390"	2	Composite		8635C	
	(FG941)		1.790"	10.390"	2	Metal		8611B	
	(FG943)		1.790"	10.390"	2	Composite		8635C	
	(FG943)		1.790"	10.390"	2	Metal		8611B	
	(I-140SA)		1.859"	10.77"	9	Composite		8006C	
	(I-146SA)		1.859"	10.77"	9	Composite		8006C	
	14,600	(I-140SA)		1.859"	10.77"	9	Composite		8006C
		(I-146SA)		1.859"	10.77"	9	Composite		8006C

Tie Rod Ends

Axle Lbs. Rating	Code	Year	Length (Inches)	Notes	Tie Rod End Part No.	
					Drivers Side	Passenger Side

Wander Lodge 450LXI (Cont'd)

Tie Rod Ends (Cont'd)

Axle Lbs. Rating	Code	Year	Length (Inches)	Notes	Tie Rod End Part No.	
					Drivers Side	Passenger Side
14,000	(FG931)		5.44"		ES423L	ES423R
	(FG933)		5.44"		ES423L	ES423R
	(FG941)		5.44"		ES423L	ES423R
	(FG943)		5.44"		ES423L	ES423R
	(I140SA)		5.75"		ES431L	ES431R
	(I-140SA)		5.44"		ES423L	ES423R
	(I-146SA)		5.44"		ES423L	ES423R
14,600	(FG931)		5.44"		ES423L	ES423R
	(FG933)		5.44"		ES423L	ES423R
	(FG941)		5.44"		ES423L	ES423R
	(FG943)		5.44"		ES423L	ES423R
	(I-140SA)		5.44"		ES423L	ES423R
	(I146SA)		12.69"		ES3031L	ES3030R
	(I-146SA)		5.44"		ES423L	ES423R

Wander Lodge M380

King Bolt Sets

Axle Lbs. Rating	Code	Year	Diameter (inches)	Length (Inches)	Pin Type	Bushing	Notes	King Pin Set No.	
12,000	(FF931)		1.794"	10.390"	2	Composite		8616C	
	(FF931)		1.794"	10.392"	2	Metal		8590B	
	(FF932)		1.794"	10.390"	2	Composite		8616C	
	(FF932)		1.794"	10.392"	2	Metal		8590B	
	(FF933)		1.794"	10.390"	2	Composite		8616C	
	(FF933)		1.794"	10.392"	2	Metal		8590B	
	(FF934)		1.794"	10.390"	2	Composite		8616C	
	(FF934)		1.794"	10.392"	2	Metal		8590B	
	(FF941)		1.794"	10.390"	2	Composite		8616C	
	(FF941)		1.794"	10.392"	2	Metal		8590B	
	(FF942)		1.794"	10.390"	2	Composite		8616C	
	(FF942)		1.794"	10.392"	2	Metal		8590B	
	(FF943)		1.794"	10.390"	2	Composite		8616C	
	(FF943)		1.794"	10.392"	2	Metal		8590B	
	(FF944)		1.794"	10.390"	2	Composite		8616C	
	(FF944)		1.794"	10.392"	2	Metal		8590B	
	(I-120SA)			1.859"	10.77"	9	Composite		8006C

Xcel 102

King Bolt Sets

Axle Lbs. Rating	Code	Year	Diameter (inches)	Length (Inches)	Pin Type	Bushing	Notes	King Pin Set No.
12,000	(FF931)		1.794"	10.390"	2	Composite		8616C
	(FF931)		1.794"	10.392"	2	Metal		8590B
	(FF932)		1.794"	10.390"	2	Composite		8616C
	(FF932)		1.794"	10.392"	2	Metal		8590B
	(FF933)		1.794"	10.390"	2	Composite		8616C
	(FF933)		1.794"	10.392"	2	Metal		8590B
	(FF934)		1.794"	10.390"	2	Composite		8616C
	(FF934)		1.794"	10.392"	2	Metal		8590B
	(FF941)		1.794"	10.390"	2	Composite		8616C
	(FF941)		1.794"	10.392"	2	Metal		8590B
	(FF942)		1.794"	10.390"	2	Composite		8616C
	(FF942)		1.794"	10.392"	2	Metal		8590B
	(FF943)		1.794"	10.390"	2	Composite		8616C
	(FF943)		1.794"	10.392"	2	Metal		8590B
	(FF944)		1.794"	10.390"	2	Composite		8616C
	(FF944)		1.794"	10.392"	2	Metal		8590B

Tie Rod Ends

Axle Lbs. Rating	Code	Year	Length (Inches)	Notes	Tie Rod End Part No.	
					Drivers Side	Passenger Side
12,000	(FF931)		5.44"		ES423L	ES423R
	(FF932)		5.44"		ES423L	ES423R
	(FF933)		5.44"		ES423L	ES423R
	(FF934)		5.44"		ES423L	ES423R
	(FF941)		5.44"		ES423L	ES423R

Xcel 102 (Cont'd)

Tie Rod Ends (Cont'd)

Axle Lbs. Rating	Code	Year	Length (Inches)	Notes	Tie Rod End Part No.	
					Drivers Side	Passenger Side
12,000	(FF942)		5.44"		ES423L	ES423R
	(FF943)		5.44"		ES423L	ES423R
	(FF944)		5.44"		ES423L	ES423R
	(FF981)		5.44"		ES423L	ES423R
	(FF983)		5.44"		ES423L	ES423R
	(FF986)		5.44"		ES423L	ES423R
	(I-120SA)		12.69"		ES3031L	ES3030R
	(I-120SA)		5.44"		ES423L	ES423R
	(I-120SA)		5.75"		ES431L	ES431R

Xcel 103

King Bolt Sets

Axle Lbs. Rating	Code	Year	Diameter (inches)	Length (Inches)	Pin Type	Bushing	Notes	King Pin Set No.
12,000	(I-120SA)		1.859"	10.77"	9	Composite		8006C

BROCKWAY TRUCK MODEL FINDING INDEX			
Model	Model	Model	Model
SERIES 147WL	SERIES 148SLD	SERIES 148WD	SERIES 155W
SERIES 257	SERIES 260	SERIES 2606L	SERIES 358
SERIES 359	SERIES 360	SERIES 361	SERIES 450
SERIES 450C	SERIES 527	SERIES 550	SERIES 550C
SERIES 700	SERIES 700C	SERIES F260L	SERIES F260LF
SERIES F260LQ	SERIES F260T	SERIES H257T	SERIES H260L
SERIES H260LF	SERIES N257T	SERIES N260L	SERIES N260LF
SERIES N260LQ	SERIES N260T		



350 & 360 Series



450 Series



700 Series

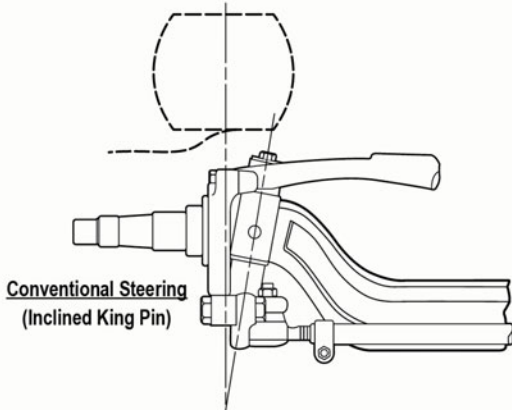

**Conventional Steering
(Inclined King Pin)**

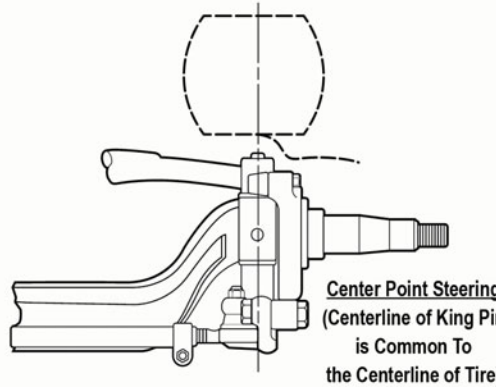

**Center Point Steering
(Centerline of King Pin
is Common To
the Centerline of Tire)**

SERIES 147WL, 148WD, 148SLD, 155W, 257, 260

King Bolt Sets

Axle Lbs. Rating	Code	Year	Diameter (inches)	Length (Inches)	Pin Type	Bushing	Notes	King Pin Set No.
		1958-1959	1.434"	8.500"	2	Metal		8519B
		1958-1959	1.444"	8.500"	2	Metal		8519B010
		1958-1959	1.434"	8.500"	2	Nylon		8519N

Tie Rod Ends

Axle Lbs. Rating	Code	Year	Length (Inches)	Notes	Tie Rod End Part No.	
					Drivers Side	Passenger Side
		1958-1959	4.88"		ES187L	ES187R

SERIES 358, 359, 360, 361, 527

King Bolt Sets

Axle Lbs. Rating	Code	Year	Diameter (inches)	Length (Inches)	Pin Type	Bushing	Notes	King Pin Set No.
12,000	(FE970)	1965-1974	1.607"	8.812"	2	Metal		8514B
	(FE970)	1965-1974	1.607"	8.812"	2	Nylon		8514N
	(FF901)	1965-1974	1.794"	9.120"	2	Metal		8489B
	(FF901)	1965-1974	1.794"	9.120"	2	Nylon		8489N
	(FF921)	1965-1974	1.794"	10.392"	2	Metal		8553B
	(FF931)	1965-1974	1.794"	10.392"	2	Metal		8590B
16,000	(FH901)	1965-1974	1.999"	11.040"	2	Metal		8518B
	(FH901)	1965-1974	1.999"	11.040"	2	Nylon		8518N
18,000	(FL901)	1965-1974	1.999"	11.040"	2	Metal		8518B
	(FL901)	1965-1974	1.999"	11.040"	2	Nylon		8518N
20,000	(FL931)	1965-1974	1.999"	11.212"	2	Metal		8571B

Tie Rod Ends

Axle Lbs. Rating	Code	Year	Length (Inches)	Notes	Tie Rod End Part No.	
					Drivers Side	Passenger Side
12,000	(FE970)	1965-1974	10.50"	Will Retrofit Older Axles Anti-Tilt Seal Type 1-1/8"-18 Optional Thread	ES2200L	ES2201R
	(FE970)	1965-1974	4.88"		ES187L	ES187R
	(FE970)	1965-1974	5.75"		ES431L	ES431R
	(FF901)	1965-1974	4.88"		ES187L	ES187R
	(FF901)	1965-1974	5.75"		ES431L	ES431R
	(FF901)	1965-1974	5.75"		ES346L	ES346R
	(FF921)	1965-1974	5.44"			ES3312R
	(FF921)	1965-1974	5.44"			ES423L
	(FF931)	1965-1974	5.44"			ES423R
	(FF931)	1965-1974	5.44"		1-1/8"-18 Optional Thread	ES423L
16,000	(FH901)	1965-1974	5.75"		ES431L	ES431R
18,000	(FL901)	1965-1974	5.75"		ES431L	ES431R
20,000	(FL931)	1965-1974	12.69"		ES3031L	ES3030R
	(FL931)	1965-1974	5.44"		ES423L	ES423R
	(FL931)	1965-1974	5.75"		ES431L	ES431R
	(FL931)	1965-1974	7.37"		ES2090L	ES2091R

SERIES 450, 450C, 550, 550C, 700, 700C

King Bolt Sets

Axle Lbs. Rating	Code	Year	Diameter (inches)	Length (Inches)	Pin Type	Bushing	Notes	King Pin Set No.
12,000	(FE970)	1965-1974	1.607"	8.812"	2	Metal		8514B
	(FE970)	1965-1974	1.607"	8.812"	2	Nylon		8514N
	(FF901)	1965-1974	1.794"	9.120"	2	Metal		8489B
	(FF901)	1965-1974	1.794"	9.120"	2	Nylon		8489N
	(FF921)	1965-1974	1.794"	10.392"	2	Metal		8553B
	(FF931)	1965-1974	1.794"	10.392"	2	Metal		8590B
16,000	(FH901)	1965-1974	1.999"	11.040"	2	Metal		8518B
	(FH901)	1965-1974	1.999"	11.040"	2	Nylon		8518N
18,000	(FL901)	1965-1974	1.999"	11.040"	2	Metal		8518B
	(FL901)	1965-1974	1.999"	11.040"	2	Nylon		8518N
20,000	(FL931)	1965-1974	1.999"	11.212"	2	Metal		8571B

Tie Rod Ends

Axle Lbs. Rating	Code	Year	Length (Inches)	Notes	Tie Rod End Part No.	
					Drivers Side	Passenger Side
12,000	(FE970)	1965-1974		Repair kit Will Retrofit Older Axles Anti-Tilt Seal Type 1-1/8"-18 Optional Thread	ESK371	ESK371
	(FE970)	1965-1974	10.50"		ES2200L	ES2201R
	(FE970)	1965-1974	4.88"		ES187L	ES187R
	(FE970)	1965-1974	5.75"		ES431L	ES431R
	(FF901)	1965-1974	4.88"		ES187L	ES187R
	(FF901)	1965-1974	5.75"		ES431L	ES431R
	(FF901)	1965-1974	5.75"		ES346L	ES346R
	(FF921)	1965-1974	5.44"			ES3312R
	(FF921)	1965-1974	5.44"			ES423L
	(FF931)	1965-1974	5.44"			ES423R
16,000	(FH901)	1965-1974	5.75"		ES431L	ES431R
18,000	(FL901)	1965-1974	5.75"		ES431L	ES431R
20,000	(FL931)	1965-1974	12.69"		ES3031L	ES3030R

BROCKWAY



SERIES 450, 450C, 550, 550C, 700, 700C (Cont'd)

Tie Rod Ends (Cont'd)

Axle Lbs. Rating	Code	Year	Length (Inches)	Notes	Tie Rod End Part No.	
					Drivers Side	Passenger Side
20,000	(FL931)	1965-1977	5.44"		ES423L	ES423R
	(FL931)	1965-1974	5.75"		ES431L	ES431R
	(FL931)	1965-1974	7.37"		ES2090L	ES2091R

SERIES F260L, F260LF, F260LQ, F260T, H260L, H260LF, H257T, N257T, N260L, N260LF, N260LQ, N260T, 2606L

King Bolt Sets

Axle Lbs. Rating	Code	Year	Diameter (inches)	Length (Inches)	Pin Type	Bushing	Notes	King Pin Set No.
16,000	(FG900)	1958-1960	1.400/1.794"	10.688"	7	Metal		8474B

Tie Rod Ends

Axle Lbs. Rating	Code	Year	Length (Inches)	Notes	Tie Rod End Part No.	
					Drivers Side	Passenger Side
16,000	(FG900)	1958-1960	4.88"		ES187L	ES187R

Heavy Duty Trucks

CHEVROLET TRUCK MODEL FINDING INDEX			
Model	Model	Model	Model
10 Series	4A	4B	4C
5A	5B	5C	6A (Regular)
6B	6C (Heavy Duty)	6E (Heavy Duty)	6J
6K	7	8	9
A60	A80	B60	B6P
B7T	Bison	Bruin	C
C40	C50	C5500	C5D
C5H	C60	C65	C6D
C6H	C70	C7D	C80
COE	COE & School Bus	COE(1955 1st Series)	D50
D60	D90	E80	F
F90	H70	H80	H90
J70	J80	J90	Kodiak
L	L50	L60	L80
M	M Series Heavy Duty	M Series School Bus	M50
M60	M65	M80	M90
N	N50	N60	N80
O Series except Heavy Duty	O Series Heavy Duty	O Series School Bus	P (First Series)
P (Second Series)	P Series except Heavy Duty	P Series Heavy Duty	P40
P50	P60	P6S	Q50
Q60	Q80	QJ	QK
R (First Series)	R (Second Series)	Regular and School Bus	Regular School Bus 6A
Regular School Bus 6B	Regular School Bus 6C	Regular School Bus 6D	Regular School Bus 6E(except Heavy Duty)
RJ	RK	S50	S60
S70	S7T	School Bus 6D	Series COE
SJ	SK	SL	Standard
T50	T5500	T60	T65
T6500	T70	T7500	T80
T8500	T90	Titan	TJ
TK	TL	U80	UJ
UK	UL	V60	V80
VJ	VK	VL	W60
W6N	W70	W7N	W80
W90	X60	Y	Y Series School Bus
Y60			

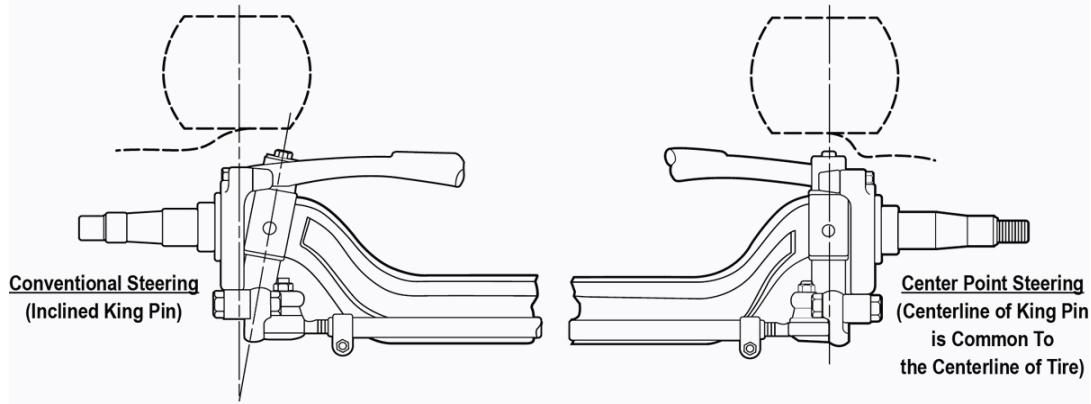

6A (Regular),6B,6C (Heavy Duty)

Tie Rod Ends							
Axle Lbs. Rating	Code	Year	Length (Inches)	Notes	Tie Rod End Part No.		
					Drivers Side	Passenger Side	
		1958-1959	3.75"		ES176L	ES176R	

7,8,9 & 10 SERIES

King Bolt Sets								
Axle Lbs. Rating	Code	Year	Diameter (inches)	Length (Inches)	Pin Type	Bushing	Notes	King Pin Set No.
9,000		1958-1959	1.434"	8.500"	2	Metal		8519B
		1958-1959	1.434"	8.500"	2	Nylon		8519N

Tie Rod Ends							
Axle Lbs. Rating	Code	Year	Length (Inches)	Notes	Tie Rod End Part No.		
					Drivers Side	Passenger Side	
9,000		1958-1959	4.88"		ES187L	ES187R	

A60

King Bolt Sets								
Axle Lbs. Rating	Code	Year	Diameter (inches)	Length (Inches)	Pin Type	Bushing	Notes	King Pin Set No.
7,000		1965-1965	1.249"	7.890"	1	Metal		8491B
		1965-1965	1.259"	7.890"	1	Metal		8491B010
		1965-1965	1.249"	7.890"	1	Nylon		8491N
9,000		1965-1965	1.186/1.434"	8.750"	7	Metal		8462B
		1965-1965	1.186/1.434"	8.750"	7	Nylon		8462N
11,000		1965-1965	1.309/1.607"	9.750"	7	Metal		8386B

A60 (Cont'd)

King Bolt Sets (Cont'd)

Axle Lbs. Rating	Code	Year	Diameter (inches)	Length (Inches)	Pin Type	Bushing	Notes	King Pin Set No.
11,000		1965-1965	1.309/1.607"	9.750"	7	Nylon		8386N

Tie Rod Ends

Axle Lbs. Rating	Code	Year	Length (Inches)	Notes	Tie Rod End Part No.	
					Drivers Side	Passenger Side
7,000		1965-1965	6.50"		ES332L	ES332R
9,000		1965-1965	3.75"		ES176L	ES176R
11,000		1965-1965	5.50"	Internal Threads	ES325L	ES325R

A80, N80, Q80, V80

King Bolt Sets

Axle Lbs. Rating	Code	Year	Diameter (inches)	Length (Inches)	Pin Type	Bushing	Notes	King Pin Set No.
7,000		1965-1965	1.249"	7.890"	1	Metal		8491B
		1965-1965	1.259"	7.890"	1	Metal		8491B010
		1965-1965	1.249"	7.890"	1	Nylon		8491N
9,000		1965-1965	1.186/1.434"	8.750"	7	Metal		8462B
		1965-1965	1.186/1.434"	8.750"	7	Nylon		8462N
11,000		1965-1965	1.309/1.607"	9.750"	7	Metal		8386B
		1965-1965	1.309/1.607"	9.750"	7	Nylon		8386N

Tie Rod Ends

Axle Lbs. Rating	Code	Year	Length (Inches)	Notes	Tie Rod End Part No.	
					Drivers Side	Passenger Side
7,000		1965-1965	6.50"		ES332L	ES332R
9,000		1965-1965	3.75"		ES176L	ES176R
11,000		1965-1965	5.50"	Internal Threads	ES325L	ES325R

B60, B6P

King Bolt Sets

Axle Lbs. Rating	Code	Year	Diameter (inches)	Length (Inches)	Pin Type	Bushing	Notes	King Pin Set No.
6,000	(F070D)	1979-1982	1.249"	7.890"	1	Metal		8491B
	(F070D)	1979-1982	1.259"	7.890"	1	Metal		8491B010
	(F070D)	1979-1982	1.249"	7.890"	1	Nylon		8491N
7,000	(F070)	1979-1991	1.249"	7.890"	1	Metal		8491B
	(F070)	1979-1991	1.259"	7.890"	1	Metal		8491B010
	(F070)	1979-1991	1.249"	7.890"	1	Nylon		8491N
7,500	(F070)	1979-1991	1.249"	7.890"	1	Metal		8491B
	(F070)	1979-1991	1.259"	7.890"	1	Metal		8491B010
	(F070)	1979-1991	1.249"	7.890"	1	Nylon		8491N
8,100	(F090)	1983-1987	1.186/1.434"	8.750"	7	Metal		8462B
	(F090)	1983-1987	1.186/1.434"	8.750"	7	Nylon		8462N
9,000	(F090)	1979-1982	1.186/1.434"	8.750"	7	Metal		8462B
	(F090)	1983-1988	1.745"	9.380"	1	Metal		8613B
	(F090)	1979-1982	1.186/1.434"	8.750"	7	Nylon		8462N
	(F120D)	1979-1992	1.745"	9.380"	1	Metal		8613B
12,000	(F120)	1983-1992	1.745"	9.380"	1	Metal		8613B

Tie Rod Ends

Axle Lbs. Rating	Code	Year	Length (Inches)	Notes	Tie Rod End Part No.	
					Drivers Side	Passenger Side
6,000	(F070D)	1979-1982	4.93"		ES2061L	ES2062R
7,000	(F070)	1988-1992	10.80"		ES3026L	ES3027R
	(F070)	1983-1992	4.93"		ES2061L	ES2062R
	(F070)	1979-1992	4.93"		ES2061L	ES2062R
7,500	(F070)	1988-1992	10.80"		ES3026L	ES3027R
	(F070)	1983-1992	4.93"		ES2061L	ES2062R
8,100	(F090)	1983-1992	4.88"		ES405L	ES405R
9,000	(F090)	1980-1982	4.88"		ES405L	ES405R
	(F090)	1979-1992	4.88"		ES405L	ES405R
	(F120D)	1979-1992	4.88"		ES405L	ES405R
12,000	(F120)	1983-1992	4.88"		ES405L	ES405R
	(F120)	1980-1982	4.88"		ES405L	ES405R

CHEVROLET TRUCK



B60, B6P (Cont'd)

Drag Links

Axle Lbs. Rating	Code	Year	Length (inches)	Notes	Drag Link No.
6.000	(F070D)	1979-1982	17.00"		DS1064
7.000	(F070)	1979-1991 1988-1991	17.00" 17.53"		DS1064 DS1198
7.500	(F070)	1979-1991 1988-1991	17.00" 17.53"		DS1064 DS1198
8.100	(F090D)	1983-1988	17.96"		DS987
9.000	(F090) (F120) (F120D)	1979-1988 1979-1991 1988-1991	17.96" 18.50"		DS987 DS1199
12.000	(F120D)	1979-1991	17.96"		DS987

B7T

King Bolt Sets

Axle Lbs. Rating	Code	Year	Diameter (inches)	Length (Inches)	Pin Type	Bushing	Notes	King Pin Set No.
8,100	(FL1)	1993-1999	1.614"	8.035"	8	Metal	(3675 kg)	8659B
9,000	(F090)	1993-1999	1.892"	9.203"	8	Metal		8660B
11,000	(FL2)	1993-1999	1.892"	9.203"	8	Metal	(5000 kg)	8660B

Tie Rod Ends

Axle Lbs. Rating	Code	Year	Length (Inches)	Notes	Tie Rod End Part No.	
					Drivers Side	Passenger Side
8,000	(FL1)	1993-1994	5.02"	First Design; (3675 kg)	ES3268L	ES3269R
	(FL1)	1993-1999	5.44"	Second Design	ES3270L	ES3271R
9,000	(F090)	1993-1994	5.44"		ES3274L	ES3275R
11,000	(FL2)	1993-1999	5.44"	(5000 kg)	ES3274L	ES3275R

Drag Links

Axle Lbs. Rating	Code	Year	Length (inches)	Notes	Drag Link No.
8.000	(FL1)	1993-1994	17.48" 20.65"	w/Ross Gear. From 1997	DS1217 DS1216
9.000	(F090)	1993-1994	20.65"		DS1216
11.000	(FL2)	1993-1994	17.48" 20.65"	w/Ross Gear. From 1997	DS1217 DS1216

Bison

King Bolt Sets

Axle Lbs. Rating	Code	Year	Diameter (inches)	Length (Inches)	Pin Type	Bushing	Notes	King Pin Set No.
9,000	(F120D)	1979-1980	1.745"	9.380"	1	Metal		8613B
10,860	(F120D)	1979-1979	1.745"	9.380"	1	Metal		8613B
12,000	(F120)	1975-1987	1.745"	9.380"	1	Metal		8613B
	(FF931)	1979-1987	1.794"	10.392"	2	Metal		8590B
	(FF933)	1979-1980	1.794"	10.392"	2	Metal		8590B
16,000	(FL931)	1977-1987	1.999"	11.212"	2	Metal		8571B
18,000	(FL931)	1979-1987	1.999"	11.212"	2	Metal		8571B
	(FL941)	1979-1987	1.999"	11.212"	2	Metal		8571B

Tie Rod Ends

Axle Lbs. Rating	Code	Year	Length (Inches)	Notes	Tie Rod End Part No.	
					Drivers Side	Passenger Side
9,000	(F120D)	1979-1980	4.88"		ES405L	
10,860	(F120D)	1979-1979	4.88"		ES405L	ES405R
12,000	(F120)	1977-1987	4.88"	Use w/2015558, 2015559, 2015580; 2019775, 2030613 Axles 1-1/8"-18 Optional Thread Use w/2015558, 2015559, 2015580; 2019775, 2030613 Axles Use w/2013302 Axle	ES405L	ES405R
	(F120)	1977-1987	4.88"		ES405L	ES405R
	(FF931)	1979-1987	5.44"		ES423L	ES423R
	(FF931)	1979-1987	5.44"			ES3312R
	(FF933)	1979-1980	4.88"		ES405L	ES405R
	(FF933)	1977-1980	4.88"		ES405L	ES405R
	(FF933)	1977-1980	5.44"		ES423L	ES423R
16,000	(FL931)	1979-1988	12.69"		ES3031L	ES3030R
	(FL931)	1979-1988	5.75"		ES431L	ES431R

Bison (Cont'd)

Tie Rod Ends (Cont'd)

Axle Lbs. Rating	Code	Year	Length (Inches)	Notes	Tie Rod End Part No.	
					Drivers Side	Passenger Side
16,000	(FL931)	1979-1988	7.37"		ES2090L	ES2091R
18,000	(FL931)	1979-1988	12.69"		ES3031L	ES3030R
	(FL931)	1979-1988	5.75"		ES431L	ES431R
	(FL931)	1979-1988	7.37"		ES2090L	ES2091R
	(FL941)	1979-1987	12.69"		ES3031L	ES3030R
	(FL941)	1979-1987	5.75"		ES431L	ES431R
	(FL941)	1979-1987	7.37"		ES2090L	ES2091R

Drag Links

Axle Lbs. Rating	Code	Year	Length (inches)	Notes	Drag Link No.
9,000	(F120D)	1979-1980	17.70"	w/Power Steering	DS910
			17.90"	w/Manual Steering	DS988
10,860	(F120D)	1979-1979	17.70"	w/Power Steering	DS910
			17.90"	w/Manual Steering	DS988
12,000	(F120)	1977-1987	16.89"	w/Ross or Sheppard Power Steering 1983-87	DS1044
			17.70"	w/Saginaw Power Steering	DS910
			17.90"	w/Manual Steering	DS988
	(FF931)	1979-1987	16.89"	w/Ross or Sheppard Power Steering 1983-87	DS1044
			17.70"	w/Power Steering	DS910
			17.90"	w/Manual Steering	DS988
(FF933)	1977-1984	17.70"	w/Power Steering	DS910	
		17.70"	w/Power Steering	DS910	
		17.90"	w/Manual Steering	DS988	
16,000	(FL931)	1977-1987	16.89"	w/Ross or Sheppard Power Steering 1983-87	DS1044
			17.70"	w/Power Steering-LH w/Power Steering-RH	DS910 DS941
18,000	(FL931)	1979-1987	16.89"	w/Ross or Sheppard Power Steering 1983-87	DS1044
			17.70"	w/Power Steering-LH w/Power Steering-RH	DS910 DS941
	(FL941)	1977-1984	16.89"	w/Ross or Sheppard Power Steering-LH w/Ross or Sheppard Power Steering-RH	DS1044 DS1067
			17.70"	w/Saginaw Power Steering-LH	DS910

Bruin

King Bolt Sets

Axle Lbs. Rating	Code	Year	Diameter (inches)	Length (Inches)	Pin Type	Bushing	Notes	King Pin Set No.
7,000	(F070)	1979-1988	1.249"	7.890"	1	Metal		8491B
	(F070)	1979-1988	1.259"	7.890"	1	Metal		8491B010
	(F070)	1979-1988	1.249"	7.890"	1	Nylon		8491N
9,000	(F090)	1979-1988	1.186/1.434"	8.750"	7	Metal		8462B
	(F090)	1979-1988	1.186/1.434"	8.750"	7	Nylon		8462N
	(F120D)	1979-1988	1.745"	9.380"	1	Metal		8613B
10,860	(F120D)	1979-1988	1.745"	9.380"	1	Metal		8613B
12,000	(F120)	1979-1988	1.745"	9.380"	1	Metal		8613B
	(FF941)	1979-1988	1.794"	10.392"	2	Metal		8590B
13,200	(FF932)	1979-1988	1.794"	10.392"	2	Metal		8590B
16,000	(FL931)	1979-1988	1.999"	11.212"	2	Metal		8571B
18,000	(FL931)	1979-1988	1.999"	11.212"	2	Metal		8571B
	(FL941)	1979-1988	1.999"	11.212"	2	Metal		8571B

Tie Rod Ends

Axle Lbs. Rating	Code	Year	Length (Inches)	Notes	Tie Rod End Part No.	
					Drivers Side	Passenger Side
7,000	(F070)	1979-1988	4.93"		ES2061L	ES2062R
9,000	(F090)	1979-1988	4.88"		ES405L	ES405R
	(F120D)	1979-1988	4.88"		ES405L	ES405R
10,860	(F120D)	1979-1988	4.88"		ES405L	ES405R
12,000	(F120)	1979-1988	4.88"		ES405L	ES405R
	(FF941)	1979-1988	5.44"		ES423L	ES423R
	(FF941)	1979-1988	5.44"	1-1/8"-18 Optional Thread		ES3312R
13,200	(FF932)	1979-1988	5.44"		ES423L	ES423R
	(FF932)	1979-1988	5.44"	1-1/8"-18 Optional Thread		ES3312R
16,000	(FL931)	1979-1988	12.69"		ES3031L	ES3030R
	(FL931)	1979-1988	5.75"		ES431L	ES431R
	(FL931)	1979-1988	7.37"		ES2090L	ES2091R
18,000	(FL931)	1979-1988	12.69"		ES3031L	ES3030R

CHEVROLET TRUCK



Heavy Duty Trucks

Bruin (Cont'd)

Tie Rod Ends (Cont'd)

Axle Lbs. Rating	Code	Year	Length (Inches)	Notes	Tie Rod End Part No.	
					Drivers Side	Passenger Side
18,000	(FL931)	1979-1988	5.75"		ES431L	ES431R
	(FL931)	1979-1988	7.37"		ES2090L	ES2091R
	(FL941)	1979-1988	12.69"		ES3031L	ES3030R
	(FL941)	1979-1988	5.75"		ES431L	ES431R
	(FL941)	1979-1988	7.37"		ES2090L	ES2091R

Drag Links

Axle Lbs. Rating	Code	Year	Length (inches)	Notes	Drag Link No.
9,000	(F090) (F120D)	1979-1988	17.70"	w/Power Steering	DS910
			17.90"	w/Manual Steering	DS988
			17.70"	w/Power Steering	DS910
			17.90"	w/Manual Steering	DS988
10,860	(F120D)	1979-1988	17.70"	w/Power Steering	DS910
			17.90"	w/Manual Steering	DS988
12,000	(F120)	1979-1988	16.89"	w/Ross Power Steering	DS1044
			17.70"	w/Power Steering	DS910
			17.90"	w/Manual Steering	DS988
13,200	(FF932)	1979-1988	17.70"	w/Power Steering-RH	DS941
				w/Power Steering-LH	DS910
16,000	(FL931)	1979-1988	17.70"	w/Power Steering-RH	DS941
				w/Power Steering-LH	DS910
18,000	(FL931) (FL941)	1979-1988	17.70"	w/Power Steering-LH	DS910
				w/Power Steering-RH	DS941

C40

King Bolt Sets

Axle Lbs. Rating	Code	Year	Diameter (inches)	Length (Inches)	Pin Type	Bushing	Notes	King Pin Set No.
4,000	(F040)	1967-1970	0.921"	5.640"	1	Metal		8445B
5,000	(F050)	1964-1972	1.109"	6.344"	1	Metal	Thrust Washer Design	8484T
	(F050)	1964-1972	1.109"	6.344"	1	Metal	Thrust Bearing Design	8492B
	(F050)	1964-1972	1.109"	6.344"	1	Nylon	Thrust Bearing Design	8492N
7,000	(F070)	1967-1970	0.921"	5.640"	1	Metal		8445B
	(F070)	1971-1972	1.249"	7.890"	1	Metal		8491B
	(F070)	1971-1972	1.259"	7.890"	1	Metal		8491B010
	(F070)	1967-1970	0.921"	5.640"	1	Nylon		8445N
	(F070)	1971-1972	1.249"	7.890"	1	Nylon		8491N

Tie Rod Ends

Axle Lbs. Rating	Code	Year	Length (Inches)	Notes	Tie Rod End Part No.	
					Drivers Side	Passenger Side
5,000	(F050)	1964-1972	5.86"		ES330L	ES330R
7,000	(F070)	1971-1972	6.50"		ES332L	ES332R

Drag Links

Axle Lbs. Rating	Code	Year	Length (inches)	Notes	Drag Link No.
5,000	(F050)	1968-1972	16.75"		DS835

C50, C5D, C5H, C5500, Kodiak

King Bolt Sets

Axle Lbs. Rating	Code	Year	Diameter (inches)	Length (Inches)	Pin Type	Bushing	Notes	King Pin Set No.
4,000		1963-1966	0.921"	5.640"	1	Metal		8445B
5,000	(F050)	1964-1964	1.109"	6.344"	1	Metal	Thrust Washer Design	8484T
		1965-1975	1.109"	6.344"	1	Metal	Thrust Washer Design	8484T
		1973-1975	1.109"	6.344"	1	Metal	To 1975 First Design	8490T
		1964-1964	1.109"	6.344"	1	Metal	Second Design w/Thrust Bearing	8492B
		1965-1975	1.109"	6.344"	1	Metal	Thrust Bearing Design	8492B
		1964-1964	1.109"	6.344"	1	Nylon	Second Design w/Thrust Bearing	8492N
		1965-1975	1.109"	6.344"	1	Nylon	Thrust Bearing Design	8492N
		1975-1992	1.179"	6.360"	1	Metal	From 1975 Second Design	8570B
		1975-1992	1.189"	6.360"	1	Metal		8570B010
		1975-1992	1.179"	6.360"	1	Nylon	From 1975 Second Design	8570N

C50, C5D, C5H, C5500, Kodiak (Cont'd)

King Bolt Sets (Cont'd)

Axle Lbs. Rating	Code	Year	Diameter (inches)	Length (Inches)	Pin Type	Bushing	Notes	King Pin Set No.
7,000	(F070)	1971-1990	1.249"	7.890"	1	Metal		8491B
	(F070)	1971-1990	1.259"	7.890"	1	Metal		8491B010
	(F070)	1971-1990	1.249"	7.890"	1	Nylon		8491N
8,100	(FL1)	1990-1999	1.614"	8.035"	8	Metal	(3785 kg)	8659B
9,000		1971-1972	1.186/1.434"	8.750"	7	Metal		8462B
		1971-1972	1.186/1.434"	8.750"	7	Nylon		8462N
11,000		1967-1970	1.309/1.607"	9.750"	7	Metal		8386B
		1967-1970	1.309/1.607"	9.750"	7	Nylon		8386N

C50, C5D, Kodiak

Tie Rod Ends

Axle Lbs. Rating	Code	Year	Length (Inches)	Notes	Tie Rod End Part No.	
					Drivers Side	Passenger Side
5,000	(F050)	1963-1977	5.86"		ES330L	ES330R
		1978-1990	4.93"		ES2061L	ES2062R
7,000	(F070)	1971-1975	6.50"		ES332L	ES332R
		1988-1990	10.80"		ES3026L	ES3027R
		1975-1990	4.93"		ES2061L	ES2062R
8,000	(FL1)	1990-1994	5.02"	1st.Design; (3675 kg)	ES3268L	ES3269R
		1994-1999	5.44"	2nd.Design; (3675 kg)	ES3270L	ES3271R
9,000		1971-1972	3.75"	Except Tilt Cab	ES176L	ES176R
		1971-1972	4.88"	Tilt Cab	ES405L	ES405R
11,000		1967-1970	4.88"	Tilt Cab	ES405L	ES405R

Drag Links

Axle Lbs. Rating	Code	Year	Length (inches)	Notes	Drag Link No.
5,000	(F050)	1967-1972	16.75"		DS929
		1973-1975		To 1975 First Design	DS835
		1975-1990	17.00"	From 1975 Second Design	DS1064
7,000	(F070)	1975-1980	17.00"		DS1064
8,000	(FL1)	1990-1999	20.28"	w/Air Brakes	DS1277
			20.65"	w/Hydraulic Brakes	DS1216
11,000	(FL2)	1990-1999	20.28"	w/Air Brakes	DS1277
			20.65"	w/Hydraulic Brakes	DS1216

C60, C6D, C6H, Kodiak

King Bolt Sets

Axle Lbs. Rating	Code	Year	Diameter (inches)	Length (Inches)	Pin Type	Bushing	Notes	King Pin Set No.
5,000		1964-1972	1.109"	6.344"	1	Metal	Thrust Washer Design	8484T
		1973-1975	1.109"	6.344"	1	Metal	Before 1975 Second Design	8490T
		1964-1972	1.109"	6.344"	1	Metal		8492B
		1964-1972	1.109"	6.344"	1	Nylon	Thrust Bearing Design	8492N
	(F050)	1975-1990	1.179"	6.360"	1	Metal	From 1975 Second Design	8570B
	(F050)	1975-1990	1.189"	6.360"	1	Metal	From 1975 Second Design	8570B010
	(F050)	1975-1990	1.179"	6.360"	1	Nylon		8570N
7,000	(F070)	1964-1990	1.249"	7.890"	1	Metal	From 1964 Second Design	8491B
	(F070)	1964-1990	1.259"	7.890"	1	Metal	From 1964 Second Design	8491B010
	(F070)	1964-1990	1.249"	7.890"	1	Nylon	From 1964 Second Design	8491N
8,100	(FL1)	1990-1999	1.614"	8.035"	8	Metal	(3675 kg)	8659B
	(FL1)	1990-1999	1.614"	8.035"	8	Metal	(3675 kg)	8659B
9,000		1971-1972	1.186/1.434"	8.750"	7	Metal		8462B
		1984-1992	1.745"	9.380"	1	Metal		8613B
		1971-1972	1.186/1.434"	8.750"	7	Nylon		8462N
	(F090)	1963-1988	1.186/1.434"	8.750"	7	Metal		8462B
	(F090)	1963-1988	1.186/1.434"	8.750"	7	Nylon		8462N
	(F120D)	1979-1992	1.745"	9.380"	1	Metal		8613B
11,000		1967-1970	1.309/1.607"	9.750"	7	Metal		8386B
		1967-1970	1.309/1.607"	9.750"	7	Nylon		8386N
12,000	(F120)	1982-1992	1.745"	9.380"	1	Metal		8613B

CHEVROLET TRUCK



C60, C6D, Kodiak

Tie Rod Ends

Axle Lbs. Rating	Code	Year	Length (Inches)	Notes	Tie Rod End Part No.	
					Drivers Side	Passenger Side
5,000	(F050)	1963-1977	5.86"		ES330L	ES330R
		1978-1992	4.93"		ES2061L	ES2062R
7,000	(F070)	1963-1977	6.50"		ES332L	ES332R
		1988-1990	10.80"		ES3026L	ES3027R
		1978-1990	4.93"		ES2061L	ES2062R
8,000	(FL1)	1994-1995	5.02"	1st Design	ES3268L	ES3269R
		1990-1993	5.02"	2nd Design w/Swedge Rod End; for Clamp Retention	ES3268L	ES3269R
		1994-1999	5.44"		ES3270L	ES3271R
8,100	(F090)	1984-1992	4.88"		ES405L	ES405R
9,000	(F090)	1963-1975	3.75"		ES176L	ES176R
		1975-1982	4.88"		ES405L	ES405R
		1983-1992	4.88"		ES405L	ES405R
		1983-1992	4.88"		ES405L	ES405R
		1979-1982	4.88"		ES405L	ES405R
12,000	(F120)	1979-1982	4.88"		ES405L	ES405R
		1983-1992	4.88"		ES405L	ES405R

Drag Links

Axle Lbs. Rating	Code	Year	Length (inches)	Notes	Drag Link No.	
5,000	(F050)	1973-1975	16.75"	Before 1975 Second Design	DS835	
		1975-1992	17.00"	From 1975 Second Design	DS1064	
7,000	(F070)	1973-1975	16.75"	Before 1975 Second Design	DS835	
		1975-1990	17.00"	1983-88 w/Power Steering Exc. Saginaw From 1975 Second Design	DS1064	
		1988-1990	17.53"	w/Saginaw Power Steering	DS1198	
8,000	(FL1)	1990-1999	20.28"	w/Air Brakes	DS1277	
			20.65"	w/Hydraulic Brakes	DS1216	
9,000	(F090)	1979-1988	17.96"		DS987	
						(F120D)
11,000	(FL2)	1990-1999	20.28"	w/Air Brakes	DS1277	
			20.65"	w/Hydraulic Brakes	DS1216	
12,000	(F120)	1979-1990	17.93"	w/Power Steering & Ram Cyl.	DS986	
			18.58"	Except Ram Cylinder	DS1200	
			1988-1990		17.96"	DS987
			1983-1990		18.50"	DS1199

C65

King Bolt Sets

Axle Lbs. Rating	Code	Year	Diameter (inches)	Length (Inches)	Pin Type	Bushing	Notes	King Pin Set No.
7,000	(F070)	1973-1978	1.249"	7.890"	1	Metal		8491B
			1.259"	7.890"	1	Metal		8491B010
			1.249"	7.890"	1	Nylon		8491N
9,000	(F090)	1973-1978	1.186/1.434"	8.750"	7	Metal		8462B
			1.186/1.434"	8.750"	7	Nylon		8462N
			1.745"	9.380"	1	Metal		8613B
12,000	(F120)	1973-1975	1.309/1.607"	9.750"	7	Metal		8386B
			1.745"	9.380"	1	Metal		8613B
			1.309/1.607"	9.750"	7	Nylon		8386N

Tie Rod Ends

Axle Lbs. Rating	Code	Year	Length (Inches)	Notes	Tie Rod End Part No.	
					Drivers Side	Passenger Side
7,000	(F070)	1973-1978	6.50"		ES332L	ES332R
9,000	(F090)	1973-1974	3.75"		ES176L	ES176R
		1975-1978	4.88"		ES405L	ES405R
		1975-1978	4.88"		ES405L	ES405R
12,000	(F120)	1975-1978	4.88"	w/718934, 718936, 718937; 719597; 2000763; 2002084, 2002085, 2002086, 2002087 Axles	ES405L	ES405R
		1973-1978	4.88"		ES405L	ES405R

Drag Links

Axle Lbs. Rating	Code	Year	Length (inches)	Notes	Drag Link No.

C65 (Cont'd)

Drag Links (Cont'd)

Axle Lbs. Rating	Code	Year	Length (inches)	Notes	Drag Link No.
7.000	(F070)	1975-1978	17.00"	From 1975 Second Design	DS1064
9.000	(F090)	1973-1978	17.20" 3.12"	w/Power Steering Power Steering Cylinder End	DS982 ES2030R
		1973-1975 1975-1978	17.96" 3.12"	From 1975 Second Design Power Steering Cylinder End	DS987 ES2030R
	(F120D)		17.00" 17.96"	From 1975 Second Design; CD65-1978 Only	DS1064 DS987
			17.00" 3.12"	Power Steering Cylinder End	ES2030R
12.000	(F120)	1973-1978	3.12"	Power Steering Cylinder End	ES2030R
		1975-1978	17.00" 17.96" 3.12"	From 1975 Second Design *CD65-1978 Only Power Steering Cylinder End	DS1064 DS987 ES2030R

C70, C7D, Kodiak

King Bolt Sets

Axle Lbs. Rating	Code	Year	Diameter (inches)	Length (Inches)	Pin Type	Bushing	Notes	King Pin Set No.
7,000	(F070)	1979-1990	1.249"	7.890"	1	Metal		8491B
	(F070)	1979-1990	1.259"	7.890"	1	Metal		8491B010
	(F070)	1979-1990	1.249"	7.890"	1	Nylon		8491N
8,000	(FL1)	1990-1999	1.614"	8.035"	8	Metal	(3675 kg)	8659B
	(FL1)	1990-1999	1.614"	8.035"	8	Metal	(3675 kg)	8659B
8,100	(F090D)	1984-1992	1.745"	9.380"	1	Metal		8613B
9,000	(F090)	1979-1987	1.186/1.434"	8.750"	7	Metal		8462B
	(F090)	1979-1987	1.186/1.434"	8.750"	7	Nylon		8462N
	(F120D)	1979-1990	1.745"	9.380"	1	Metal		8613B
11,000	(FL2)	1990-1999	1.892"	9.203"	8	Metal	(5000 kg)	8660B
12,000	(F120)	1979-1990	1.745"	9.380"	1	Metal		8613B
	(FS7)	1990-1999	1.892"	9.203"	8	Metal	w/Hydraulic Brakes; (5450 kg)	8660B
	(FS7)	1991-1999	1.892"	9.604"	8	Metal	w/Air Brakes; (5450 kg)	8661B
14,000	(FH0)	1990-1994	1.892"	9.604"	8	Metal		8661B
14,600	(FL3)	1990-1999	1.892"	9.604"	8	Metal		8661B
16,000	(FH4)	1993-1999	1.870"	9.970"	1	Composite	(7275 kg)	8633C
	(FH4)	1993-1999	1.870"	9.970"	1	Metal	(7275 kg)	8633B

Tie Rod Ends

Axle Lbs. Rating	Code	Year	Length (Inches)	Notes	Tie Rod End Part No.	
					Drivers Side	Passenger Side
7,000	(F070)	1988-1990	10.80"		ES3026L	ES3027R
	(F070)	1979-1990	4.93"		ES2061L	ES2062R
8,000	(FL1)	1994-1995	5.02"	1st Design w/Bead Clamp Retainer	ES3268L	ES3269R
	(FL1)	1990-1993	5.02"		ES3268L	ES3269R
	(FL1)	1994-1999	5.44"	2nd Design w/Swedge Rod End for Clamp Retention; (3675 kg)	ES3270L	ES3271R
8,100	(F090D)	1983-1987	4.93"		ES2061L	ES2062R
9,000	(F090)	1983-1992	4.88"	For 2035126 Axle Assy.w/3 Piece Grease Retainer	ES405L	ES405R
	(F090)	1975-1982	4.88"	Exc. 2035126 Axle Assy.w/Rubber Dust Boot	ES405L	ES405R
	(F120D)	1983-1992	4.88"		ES405L	ES405R
	(F120D)	1980-1985	4.88"		ES405L	ES405R
11,000	(FL2)	1990-1999	5.44"	(5000 kg)	ES3274L	ES3275R
12,000	(F120)	1983-1992	4.88"		ES405L	ES405R
	(F120)	1979-1982	4.88"		ES405L	ES405R
	(FS7)	1990-1999	5.44"	(5450 kg)	ES3274L	ES3275R
14,000	(FH0)	1990-1994	5.44"	(6360 kg)	ES3274L	ES3275R
14,600	(FL3)	1991-1999	5.44"	(6610 kg)	ES3274L	ES3275R
16,000	(FH4)	1993-1999	7.37"	(7275 kg)	ES2090L	ES2091R

Drag Links

Axle Lbs. Rating	Code	Year	Length (inches)	Notes	Drag Link No.
7.000		1979-1982	17.00"		DS1064
		1983-1988		w/Saginaw Power Steering	
	(F070)	1988-1992 1988-1990	17.53"	w/Power Steering Exc. Saginaw w/Saginaw Power Steering	DS1198
8.000	(FL1)	1990-1999	20.28"	w/Air Brakes	DS1277
			20.65"	w/Hydraulic Brakes	DS1216
8.100	(F090D)	1983-1987	17.96"		DS987
9.000	(F090)	1979-1988	17.96"		DS987

CHEVROLET TRUCK



C70, C7D, Kodiak (Cont'd)

Drag Links (Cont'd)

Axle Lbs. Rating	Code	Year	Length (inches)	Notes	Drag Link No.
9,000	(F120D)	1979-1990	17.96"	Exc. Saginaw Power Steering	DS987
		1988-1990	18.50"	w/Saginaw Power Steering	DS1199
11,000	(FL2)	1990-1999	17.48"	w/Ross Gear	DS1217
			20.28"	w/Air Brakes and Saginaw Steering	DS1277
			20.65"	w/Hydraulic Brakes and Saginaw Steering	DS1216
12,000	(F120)	1979-1990	17.93"	Models w/Power Steering use Power Ram Cylinder	DS986
		1988-1992	18.58"		DS1200
	(FS7)	1990-1999	16.85"	w/Air brakes	DS1278
			17.48"	W/Hydraulic Brakes, 1991-98	DS1217
14,000	(FH0)	1990-1994	16.85"		DS1278
14,500	(FL3)	1991-1999	16.85"		DS1278

C80, E80, L80, M80, U80

King Bolt Sets

Axle Lbs. Rating	Code	Year	Diameter (inches)	Length (Inches)	Pin Type	Bushing	Notes	King Pin Set No.
5,000		1965-1966	1.109"	6.344"	1	Metal	Thrust Washer Design	8484T
		1965-1966	1.109"	6.344"	1	Metal	Thrust Bearing Design	8492B
		1965-1966	1.109"	6.344"	1	Nylon	Thrust Bearing Design	8492N
7,000		1964-1966	1.249"	7.890"	1	Metal	From 1964 Second Design	8491B
		1964-1966	1.259"	7.890"	1	Metal	From 1964 Second Design	8491B010
		1964-1966	1.249"	7.890"	1	Nylon	From 1964 Second Design	8491N
9,000		1963-1966	1.186/1.434"	8.750"	7	Metal		8462B
		1963-1966	1.186/1.434"	8.750"	7	Nylon		8462N
11,000		1963-1966	1.309/1.607"	9.750"	7	Metal		8386B
		1963-1966	1.309/1.607"	9.750"	7	Nylon		8386N

Tie Rod Ends

Axle Lbs. Rating	Code	Year	Length (Inches)	Notes	Tie Rod End Part No.	
					Drivers Side	Passenger Side
5,000		1965-1966	5.86"		ES330L	ES330R
7,000		1963-1966	6.50"		ES332L	ES332R
9,000		1963-1966	3.75"		ES176L	ES176R
11,000		1963-1966	5.50"	Internal Threads	ES325L	ES325R

D50

King Bolt Sets

Axle Lbs. Rating	Code	Year	Diameter (inches)	Length (Inches)	Pin Type	Bushing	Notes	King Pin Set No.
4,000		1965-1966	0.921"	5.640"	1	Metal		8445B
		1965-1966	0.921"	5.640"	1	Nylon		8445N
5,000		1965-1966	1.109"	6.344"	1	Metal	Thrust Washer Design	8484T
		1965-1966	1.109"	6.344"	1	Metal	Thrust Bearing Design	8492B
		1965-1966	1.109"	6.344"	1	Nylon	Thrust Bearing Design	8492N

Tie Rod Ends

Axle Lbs. Rating	Code	Year	Length (Inches)	Notes	Tie Rod End Part No.	
					Drivers Side	Passenger Side
5,000		1965-1966	5.86"		ES330L	ES330R

D60

King Bolt Sets

Axle Lbs. Rating	Code	Year	Diameter (inches)	Length (Inches)	Pin Type	Bushing	Notes	King Pin Set No.
5,000		1964-1970	1.109"	6.344"	1	Metal	Thrust Washer Design	8484T
		1964-1970	1.109"	6.344"	1	Metal	Thrust Bearing Design from 1964	8492B
		1964-1970	1.109"	6.344"	1	Nylon	Thrust Bearing Design from 1964	8492N
7,000		1964-1970	1.249"	7.890"	1	Metal	From 1964 Second Design	8491B
		1964-1970	1.259"	7.890"	1	Metal	From 1964 Second Design	8491B010
		1964-1970	1.249"	7.890"	1	Nylon	From 1964 Second Design	8491N
9,000		1963-1970	1.186/1.434"	8.750"	7	Metal		8462B
		1963-1970	1.186/1.434"	8.750"	7	Nylon		8462N
11,000		1965-1970	1.309/1.607"	9.750"	7	Metal		8386B
		1965-1970	1.309/1.607"	9.750"	7	Nylon		8386N

D60 (Cont'd)

Tie Rod Ends

Axle Lbs. Rating	Code	Year	Length (Inches)	Notes	Tie Rod End Part No.	
					Drivers Side	Passenger Side
5,000		1963-1970	5.86"		ES330L	ES330R
7,000		1963-1970	6.50"		ES332L	ES332R
9,000		1963-1970	3.75"		ES176L	ES176R
11,000		1965-1970	5.50"	Internal Threads	ES325L	ES325R

D90

King Bolt Sets

Axle Lbs. Rating	Code	Year	Diameter (inches)	Length (Inches)	Pin Type	Bushing	Notes	King Pin Set No.
12,000	(F120)	1970-1974	1.309/1.607"	9.750"	7	Metal		8386B
	(F120)	1975-1978	1.745"	9.380"	1	Metal		8613B
	(F120)	1970-1974	1.309/1.607"	9.750"	7	Nylon		8386N
	(FE900)	1970-1974	1.309/1.607"	9.750"	7	Metal		8386B
	(FE900)	1970-1974	1.309/1.607"	9.750"	7	Nylon		8386N
16,000	(F160)	1970-1972	1.400/1.794"	10.688"	7	Metal		8474B
	(FL901)	1970-1978	1.999"	11.040"	2	Metal		8518B
	(FL901)	1970-1978	1.999"	11.040"	2	Nylon		8518N
	(FL931)	1973-1978	1.999"	11.212"	2	Metal		8571B

Tie Rod Ends

Axle Lbs. Rating	Code	Year	Length (Inches)	Notes	Tie Rod End Part No.	
					Drivers Side	Passenger Side
12,000	(F120)	1975-1978	4.88"	From 1975 Second Design Before 1975 Second Design	ES405L	ES405R
	(F120)	1970-1975	4.88"		ES405L	ES405R
	(FE900)	1970-1972	4.88"		ES187L	ES187R
16,000	(F160)	1970-1972	4.88"		ES405L	ES405R
	(FL901)	1973-1978	5.75"		ES431L	ES431R

Drag Links

Axle Lbs. Rating	Code	Year	Length (inches)	Notes	Drag Link No.
12,000	(All)	1973-1978	17.90"	Color Coded White	DS988
			18.20"	Color Coded Blue	DS991
16,000	(All)	1973-1978	17.90"	Color Coded White	DS988
			18.20"	Color Coded Blue	DS991

F90

King Bolt Sets

Axle Lbs. Rating	Code	Year	Diameter (inches)	Length (Inches)	Pin Type	Bushing	Notes	King Pin Set No.
12,000	(F120)	1970-1974	1.309/1.607"	9.750"	7	Metal		8386B
	(F120)	1975-1978	1.745"	9.380"	1	Metal		8613B
	(F120)	1970-1974	1.309/1.607"	9.750"	7	Nylon		8386N
	(FE900)	1970-1974	1.309/1.607"	9.750"	7	Metal		8386B
	(FE900)	1970-1974	1.309/1.607"	9.750"	7	Nylon		8386N

Tie Rod Ends

Axle Lbs. Rating	Code	Year	Length (Inches)	Notes	Tie Rod End Part No.	
					Drivers Side	Passenger Side
12,000	(F120)	1975-1978	4.88"	From 1975 Second Design Before 1975 Second Design	ES405L	ES405R
	(F120)	1970-1975	4.88"		ES405L	ES405R
	(FE900)	1970-1972	4.88"		ES187L	ES187R

Drag Links

Axle Lbs. Rating	Code	Year	Length (inches)	Notes	Drag Link No.
12,000	(All)	1973-1978	17.90"	Color Coded White	DS988
			18.20"	Color Coded Blue	DS991

H70

King Bolt Sets

Axle Lbs. Rating	Code	Year	Diameter (inches)	Length (Inches)	Pin Type	Bushing	Notes	King Pin Set No.
------------------	------	------	-------------------	-----------------	----------	---------	-------	------------------

CHEVROLET TRUCK



H70 (Cont'd)

King Bolt Sets (Cont'd)

Axle Lbs. Rating	Code	Year	Diameter (inches)	Length (Inches)	Pin Type	Bushing	Notes	King Pin Set No.
7,000	(F070)	1966-1978	1.249"	7.890"	1	Metal		8491B
	(F070)	1966-1978	1.259"	7.890"	1	Metal		8491B010
	(F070)	1966-1978	1.249"	7.890"	1	Nylon		8491N
9,000	(F090)	1966-1978	1.186/1.434"	8.750"	7	Metal		8462B
	(F090)	1966-1978	1.186/1.434"	8.750"	7	Nylon		8462N
11,000	(F110)	1966-1972	1.309/1.607"	9.750"	7	Metal		8386B
	(F110)	1966-1972	1.309/1.607"	9.750"	7	Nylon		8386N
12,000	(F120)	1966-1974	1.309/1.607"	9.750"	7	Metal		8386B
	(F120)	1975-1978	1.745"	9.380"	1	Metal		8613B
	(F120)	1966-1974	1.309/1.607"	9.750"	7	Nylon		8386N
16,000	(FL901)	1966-1972	1.999"	11.040"	2	Metal		8518B
	(FL901)	1966-1972	1.999"	11.040"	2	Nylon		8518N

Tie Rod Ends

Axle Lbs. Rating	Code	Year	Length (Inches)	Notes	Tie Rod End Part No.	
					Drivers Side	Passenger Side
7,000	(F070)	1978-1978	4.93"	Use w/6V-53 Engine and 465018 Axle	ES2061L	ES2062R
	(F070)	1966-1978	6.50"		ES332L	ES332R
9,000	(F090)	1973-1978	3.75"	w/688568" Axle Only Exc. 688561; 688568; 2000765, 2000767, 2000768; 2002081, 2002083 Axles	ES176L	ES176R
	(F090)	1966-1972	3.75"		ES176L	ES176R
	(F090)	1973-1978	4.88"		ES405L	ES405R
11,000	(F110)	1966-1972	5.50"	Internal Threads	ES325L	ES325R
12,000	(F110)	1966-1972	5.50"	Internal Threads Exc. 688561; 688568; 2000765, 2000767, 2000768; 2002081, 2002083 Axles	ES325L	ES325R
	(F120)	1973-1978	4.88"		ES405L	ES405R
16,000	(FL901)	1966-1972	5.75"		ES431L	ES431R

Drag Links

Axle Lbs. Rating	Code	Year	Length (inches)	Notes	Drag Link No.
7,000	(F070)	1973-1978	17.90"	w/Manual Steering	DS988
9,000	(F090)	1973-1978	17.70"	w/Power Steering	DS910
			17.90"	w/Manual Steering	DS988
			17.70"	w/Power Steering	DS910
			17.90"	w/Manual Steering	DS988
12,000	(F120)	1973-1978	17.70"	w/Power Steering	DS910
			17.90"	w/Manual Steering	DS988

H80

King Bolt Sets

Axle Lbs. Rating	Code	Year	Diameter (inches)	Length (Inches)	Pin Type	Bushing	Notes	King Pin Set No.
7,000	(F070)	1973-1978	1.249"	7.890"	1	Metal		8491B
	(F070)	1973-1978	1.259"	7.890"	1	Metal		8491B010
	(F070)	1973-1978	1.249"	7.890"	1	Nylon		8491N
9,000	(F090)	1973-1978	1.186/1.434"	8.750"	7	Metal		8462B
	(F090)	1973-1978	1.186/1.434"	8.750"	7	Nylon		8462N
12,000	(F120)	1973-1974	1.309/1.607"	9.750"	7	Metal		8386B
	(F120)	1975-1978	1.745"	9.380"	1	Metal		8613B
	(F120)	1973-1974	1.309/1.607"	9.750"	7	Nylon		8386N

Tie Rod Ends

Axle Lbs. Rating	Code	Year	Length (Inches)	Notes	Tie Rod End Part No.	
					Drivers Side	Passenger Side
7,000		1979-1983	4.93"		ES2061L	ES2062R
	(F070)	1973-1978	6.50"		ES332L	ES332R
9,000	(F090)	1973-1978	4.88"	Exc. 688561; 688568; 2000765, 2000767, 2000768; 2002081, 2002083 Axles	ES405L	ES405R
12,000	(F120)	1973-1978	4.88"	Exc. 688561; 688568; 2000765, 2000767, 2000768; 2002081, 2002083 Axles	ES405L	ES405R

Drag Links

Axle Lbs. Rating	Code	Year	Length (inches)	Notes	Drag Link No.
------------------	------	------	-----------------	-------	---------------

H80 (Cont'd)

Drag Links (Cont'd)

Axle Lbs. Rating	Code	Year	Length (inches)	Notes	Drag Link No.
7,000	(F070)	1973-1978	17.90"	w/Manual Steering	DS988
9,000	(F090)	1973-1978	17.70"	w/Power Steering	DS910
			17.90"	w/Manual Steering	DS988
12,000	(F120)	1973-1978	17.70"	w/Power Steering	DS910
			17.90"	w/Manual Steering	DS988

H90

King Bolt Sets

Axle Lbs. Rating	Code	Year	Diameter (inches)	Length (Inches)	Pin Type	Bushing	Notes	King Pin Set No.
9,000	(F090)	1970-1978	1.186/1.434"	8.750"	7	Metal		8462B
	(F090)	1970-1978	1.186/1.434"	8.750"	7	Nylon		8462N
	(F120D)	1975-1978	1.745"	9.380"	1	Metal		8613B
12,000	(F120)	1970-1974	1.309/1.607"	9.750"	7	Metal		8386B
	(F120)	1975-1978	1.745"	9.380"	1	Metal		8613B
	(F120)	1970-1974	1.309/1.607"	9.750"	7	Nylon		8386N
	(FE900)	1970-1974	1.309/1.607"	9.750"	7	Metal		8386B
	(FE900)	1970-1974	1.309/1.607"	9.750"	7	Nylon		8386N

Tie Rod Ends

Axle Lbs. Rating	Code	Year	Length (Inches)	Notes	Tie Rod End Part No.	
					Drivers Side	Passenger Side
9,000	(F090)	1970-1978	4.88"		ES405L	ES405R
	(F120D)	1975-1978	4.88"		ES405L	ES405R
12,000	(F120)	1975-1978	4.88"	From 1975 Second Design Before 1975 Second Design	ES405L	ES405R
	(F120)	1970-1975	4.88"		ES405L	ES405R
	(FE900)	1970-1972	4.88"		ES187L	ES187R

Drag Links

Axle Lbs. Rating	Code	Year	Length (inches)	Notes	Drag Link No.
9,000	(F090)	1970-1978	17.70"	w/Power Steering	DS910
			17.90"	w/Manual Steering	DS988
12,000	(F120)	1970-1978	17.70"	w/Power Steering	DS910
			17.90"	w/Manual Steering	DS988

J70

King Bolt Sets

Axle Lbs. Rating	Code	Year	Diameter (inches)	Length (Inches)	Pin Type	Bushing	Notes	King Pin Set No.
7,000	(F070)	1966-1978	1.249"	7.890"	1	Metal		8491B
	(F070)	1966-1978	1.259"	7.890"	1	Metal		8491B010
	(F070)	1966-1978	1.249"	7.890"	1	Nylon		8491N
9,000	(F090)	1966-1978	1.186/1.434"	8.750"	7	Metal		8462B
	(F090)	1966-1978	1.186/1.434"	8.750"	7	Nylon		8462N
	(F120D)	1975-1978	1.745"	9.380"	1	Metal		8613B
11,000	(F110)	1966-1972	1.309/1.607"	9.750"	7	Metal		8386B
	(F110)	1966-1972	1.309/1.607"	9.750"	7	Nylon		8386N
12,000	(F120)	1966-1974	1.309/1.607"	9.750"	7	Metal		8386B
	(F120)	1975-1978	1.745"	9.380"	1	Metal		8613B
	(F120)	1966-1974	1.309/1.607"	9.750"	7	Nylon		8386N
16,000	(FL901)	1966-1978	1.999"	11.040"	2	Metal		8518B
	(FL901)	1966-1978	1.999"	11.040"	2	Nylon		8518N
	(FL931)	1973-1978	1.999"	11.212"	2	Metal		8571B

Tie Rod Ends

Axle Lbs. Rating	Code	Year	Length (Inches)	Notes	Tie Rod End Part No.	
					Drivers Side	Passenger Side
7,000	(F070)	1978-1978	4.93"	Use w/6V-53 Engine and 465018 Axle	ES2061L	ES2062R
	(F070)	1966-1978	6.50"		ES332L	ES332R
9,000	(F090)	1973-1978	3.75"	w/688568" Axle Only	ES176L	ES176R
	(F090)	1966-1978	3.75"		ES176L	ES176R
	(F090)	1966-1972	3.75"		ES176L	ES176R
	(F090)	1973-1978	4.88"		ES405L	ES405R
				Exc. 688561, 688568; 2000765, 2000767, 2000768; 2002081, 2002083 Axles		

J70 (Cont'd)

Tie Rod Ends (Cont'd)

Axle Lbs. Rating	Code	Year	Length (Inches)	Notes	Tie Rod End Part No.	
					Drivers Side	Passenger Side
9,000	(F120D)	1974-1978	4.88"	Exc. 688561, 688568; 2000765, 2000767, 2000768; 2002081, 2002083 Axles	ES405L	ES405R
11,000	(F110)	1966-1972	5.50"	Internal Threads	ES325L	ES325R
12,000	(F120)	1973-1978	4.88"	Exc. 688561, 688568; 2000765, 2000767, 2000768; 2002081, 2002083 Axles	ES405L	ES405R
16,000	(FL901)	1966-1978	5.75"	Use w/718314; 719708; 719831; 2025882; 2025886 Axles	ES431L	ES431R
	(FL931)	1973-1978	12.69"		ES3031L	ES3030R
	(FL931)	1973-1978	5.75"		ES431L	ES431R
	(FL931)	1973-1978	7.37"		ES2090L	ES2091R

Drag Links

Axle Lbs. Rating	Code	Year	Length (inches)	Notes	Drag Link No.
7,000	(F070)	1973-1978	17.90"	w/Manual Steering	DS988
9,000	(F090)	1973-1978	17.70"	w/Power Steering	DS910
			17.90"	w/Manual Steering	DS988
	(F120D)	17.70"	w/6V-53;432;478M Engines	DS910	
			w/Power Steering	DS988	
12,000	(F120)	1973-1978	17.70"	w/Power Steering	DS910
			17.90"	w/Manual Steering	DS988
16,000	(F091)	1973-1978	17.82"	w/Power Steering Right Hand	DS938
			17.90"	w/Power Steering-LH	DS939
	(FL931)	17.90"	w/Manual Steering	DS988	
			17.70"	w/Power Steering-RH	DS941
			17.70"	w/Power Steering-LH	DS910

J80

King Bolt Sets

Axle Lbs. Rating	Code	Year	Diameter (inches)	Length (Inches)	Pin Type	Bushing	Notes	King Pin Set No.
9,000	(F090)	1973-1978	1.186/1.434"	8.750"	7	Metal		8462B
	(F090)	1973-1978	1.186/1.434"	8.750"	7	Nylon		8462N
12,000	(F120)	1973-1974	1.309/1.607"	9.750"	7	Metal		8386B
	(F120)	1975-1978	1.745"	9.380"	1	Metal		8613B
	(F120)	1973-1974	1.309/1.607"	9.750"	7	Nylon		8386N
16,000	(FL901)	1973-1974	1.999"	11.040"	2	Metal		8518B
	(FL901)	1973-1974	1.999"	11.040"	2	Nylon		8518N
	(FL931)	1973-1983	1.999"	11.212"	2	Metal		8571B

Tie Rod Ends

Axle Lbs. Rating	Code	Year	Length (Inches)	Notes	Tie Rod End Part No.	
					Drivers Side	Passenger Side
9,000	(F090)	1973-1978	4.88"	Exc. 688561, 688568; 2000765, 2000767, 2000768; 2002081, 2002083 Axles	ES405L	ES405R
12,000	(F120)	1973-1978	4.88"	Exc. 688561, 688568; 2000765, 2000767, 2000768; 2002081, 2002083 Axles	ES405L	ES405R
16,000	(FL901)	1973-1974	5.75"		ES431L	ES431R

Drag Links

Axle Lbs. Rating	Code	Year	Length (inches)	Notes	Drag Link No.
9,000	(F090)	1973-1974	17.70"	w/Power Steering	DS910
			17.90"	w/Manual Steering	DS988
12,000	(F120)	1973-1974	17.70"	Use w/6V-53, 432, 478M Engines	DS910
			17.90"	w/Manual Steering	DS988
16,000	(FL901)	1973-1974	17.82"	w/Power Steering-LH	DS939
			17.90"	w/Power Steering Right Hand	DS938
			17.90"	Use w/6V-53, 432, 478M Engines	DS988

J90

King Bolt Sets

Axle Lbs. Rating	Code	Year	Diameter (inches)	Length (Inches)	Pin Type	Bushing	Notes	King Pin Set No.
9,000	(F090)	1970-1978	1.186/1.434"	8.750"	7	Metal		8462B

J90 (Cont'd)

King Bolt Sets (Cont'd)

Axle Lbs. Rating	Code	Year	Diameter (inches)	Length (Inches)	Pin Type	Bushing	Notes	King Pin Set No.
9,000	(F090)	1970-1978	1.186/1.434"	8.750"	7	Nylon		8462N
12,000	(F120)	1970-1974	1.309/1.607"	9.750"	7	Metal		8386B
	(F120)	1970-1974	1.309/1.607"	9.750"	7	Nylon		8386N
16,000	(F160)	1970-1972	1.400/1.794"	10.688"	7	Metal		8474B
	(FL901)	1970-1978	1.999"	11.040"	2	Metal		8518B
	(FL901)	1970-1978	1.999"	11.040"	2	Nylon		8518N
	(FL931)	1973-1978	1.999"	11.212"	2	Metal		8571B

Tie Rod Ends

Axle Lbs. Rating	Code	Year	Length (Inches)	Notes	Tie Rod End Part No.	
					Drivers Side	Passenger Side
9,000	(F090)	1970-1978	4.88"		ES405L	ES405R
12,000	(F120)	1975-1978	4.88"	From 1975 Second Design Before 1975 Second Design	ES405L	ES405R
	(F120)	1970-1975	4.88"		ES405L	ES405R
	(FE900)	1970-1972	4.88"		ES187L	ES187R
16,000	(F160)	1970-1972	4.88"	Use w/718314, 719708, 719831, 2025882, 2025886 Axles	ES405L	ES405R
	(FL901)	1973-1978	5.75"		ES431L	ES431R
	(FL931)	1973-1978	7.37"		ES2090L	ES2091R

Drag Links

Axle Lbs. Rating	Code	Year	Length (inches)	Notes	Drag Link No.
9,000	(F090)	1970-1978	17.70"	w/Power Steering	DS910
			17.90"	w/Manual Steering	DS988
12,000	(F120)	1970-1978	17.70"	w/Power Steering	DS910
			17.90"	w/Manual Steering	DS988
16,000	(FL901)	1973-1978	17.82"	w/Power Steering-LH	DS939
				w/Power Steering Right Hand	DS938
	17.70"		w/Power Steering-RH	DS941	
			w/Power Steering-LH	DS910	

L,C,F,5A,5B,5C,Standard,F,C,6J,6K

King Bolt Sets

Axle Lbs. Rating	Code	Year	Diameter (inches)	Length (Inches)	Pin Type	Bushing	Notes	King Pin Set No.
		1955-1959	1.109"	6.343"	1	Metal		8343B

L50

King Bolt Sets

Axle Lbs. Rating	Code	Year	Diameter (inches)	Length (Inches)	Pin Type	Bushing	Notes	King Pin Set No.
4,000		1963-1966	0.921"	5.640"	1	Metal		8445B
		1963-1966	0.921"	5.640"	1	Nylon		8445N
5,000		1965-1970	1.109"	6.344"	1	Metal	Thrust Washer Design	8484T
		1964-1964	1.109"	6.344"	1	Metal	Thrust Washer Design	8484T
		1965-1970	1.109"	6.344"	1	Metal	Thrust Bearing Design	8492B
		1964-1964	1.109"	6.344"	1	Metal	Second Design w/Thrust Bearing	8492B
		1965-1970	1.109"	6.344"	1	Nylon	Thrust Bearing Design	8492N
		1964-1964	1.109"	6.344"	1	Nylon	Second Design w/Thrust Bearing	8492N
7,000		1965-1970	1.249"	7.890"	1	Metal		8491B
		1965-1970	1.259"	7.890"	1	Metal		8491B010
		1965-1970	1.249"	7.890"	1	Nylon		8491N
9,000		1965-1970	1.186/1.434"	8.750"	7	Metal		8462B
		1965-1970	1.186/1.434"	8.750"	7	Nylon		8462N
11,000		1965-1970	1.309/1.607"	9.750"	7	Metal		8386B
		1965-1970	1.309/1.607"	9.750"	7	Nylon		8386N

Tie Rod Ends

Axle Lbs. Rating	Code	Year	Length (Inches)	Notes	Tie Rod End Part No.	
					Drivers Side	Passenger Side
5,000		1963-1966	5.86"		ES330L	ES330R
7,000		1965-1970	6.50"		ES332L	ES332R
9,000		1965-1970	3.75"		ES176L	ES176R
11,000		1965-1970	5.50"	Internal Threads	ES325L	ES325R

L60

King Bolt Sets

Axle Lbs. Rating	Code	Year	Diameter (inches)	Length (Inches)	Pin Type	Bushing	Notes	King Pin Set No.
5,000		1965-1966	1.109"	6.344"	1	Metal	Thrust Washer Design	8484T
		1965-1966	1.109"	6.344"	1	Metal	Thrust Bearing Design	8492B
		1965-1966	1.109"	6.344"	1	Nylon	Thrust Bearing Design	8492N
7,000		1964-1966	1.249"	7.890"	1	Metal	From 1964 Second Design	8491B
		1964-1966	1.259"	7.890"	1	Metal	From 1964 Second Design	8491B010
		1964-1966	1.249"	7.890"	1	Nylon	From 1964 Second Design	8491N
9,000		1963-1966	1.186/1.434"	8.750"	7	Metal		8462B
		1963-1966	1.186/1.434"	8.750"	7	Nylon		8462N
11,000		1963-1966	1.309/1.607"	9.750"	7	Metal		8386B
		1963-1966	1.309/1.607"	9.750"	7	Nylon		8386N

Tie Rod Ends

Axle Lbs. Rating	Code	Year	Length (Inches)	Notes	Tie Rod End Part No.	
					Drivers Side	Passenger Side
5,000		1965-1966	5.86"		ES330L	ES330R
7,000		1963-1966	6.50"		ES332L	ES332R
9,000		1963-1966	3.75"		ES176L	ES176R
11,000		1963-1966	5.50"	Internal Threads	ES325L	ES325R

M50

King Bolt Sets

Axle Lbs. Rating	Code	Year	Diameter (inches)	Length (Inches)	Pin Type	Bushing	Notes	King Pin Set No.
5,000		1967-1970	1.109"	6.344"	1	Metal	Thrust Washer Design	8484T
		1967-1970	1.109"	6.344"	1	Metal	Thrust Bearing Design	8492B
		1967-1970	1.109"	6.344"	1	Nylon	Thrust Bearing Design	8492N
7,000		1967-1972	1.249"	7.890"	1	Metal		8491B
		1967-1972	1.259"	7.890"	1	Metal		8491B010
		1967-1972	1.249"	7.890"	1	Nylon		8491N
9,000		1967-1970	1.186/1.434"	8.750"	7	Metal		8462B
		1967-1970	1.186/1.434"	8.750"	7	Nylon		8462N

Tie Rod Ends

Axle Lbs. Rating	Code	Year	Length (Inches)	Notes	Tie Rod End Part No.	
					Drivers Side	Passenger Side
5,000		1967-1970	5.86"		ES330L	ES330R
7,000		1967-1973	6.50"		ES332L	ES332R
9,000		1967-1970	3.75"		ES176L	ES176R
		1970-1970	4.88"	Tilt Cab	ES405L	ES405R

M60

King Bolt Sets

Axle Lbs. Rating	Code	Year	Diameter (inches)	Length (Inches)	Pin Type	Bushing	Notes	King Pin Set No.
5,000		1964-1970	1.109"	6.344"	1	Metal	Thrust Washer Design	8484T
		1964-1970	1.109"	6.344"	1	Metal	From 1964 Second Design; Thrust Bearing	8492B
		1964-1970	1.109"	6.344"	1	Nylon	From 1964 Second Design; Thrust Bearing	8492N
7,000		1964-1978	1.249"	7.890"	1	Metal	From 1964 Second Design	8491B
		1964-1978	1.259"	7.890"	1	Metal	From 1964 Second Design	8491B010
		1964-1978	1.249"	7.890"	1	Nylon	From 1964 Second Design	8491N
9,000		1963-1978	1.186/1.434"	8.750"	7	Metal		8462B
		1963-1978	1.186/1.434"	8.750"	7	Nylon		8462N
11,000		1965-1970	1.309/1.607"	9.750"	7	Metal		8386B
		1965-1970	1.309/1.607"	9.750"	7	Nylon		8386N
12,000	(F120)	1973-1975	1.309/1.607"	9.750"	7	Metal		8386B
		1973-1975	1.309/1.607"	9.750"	7	Nylon		8386N
		1975-1978	1.745"	9.380"	1	Metal		8613B

Tie Rod Ends

Axle Lbs. Rating	Code	Year	Length (Inches)	Notes	Tie Rod End Part No.	
					Drivers Side	Passenger Side
5,000		1963-1970	5.86"		ES330L	ES330R
7,000		1973-1978	4.93"	w/465005, 474376 Axles	ES2061L	ES2062R

M60 (Cont'd)

Tie Rod Ends (Cont'd)

Axle Lbs. Rating	Code	Year	Length (Inches)	Notes	Tie Rod End Part No.	
					Drivers Side	Passenger Side
7,000		1963-1978	6.50"	w/348136, 348142; 349041, 349042, 349044, 349046, 349047, 349048, 349052, 349053, 349059, 349060, 45977 Axles	ES332L	ES332R
9,000		1963-1974	3.75"		ES176L	ES176R
		1975-1978	4.88"		ES405L	ES405R
11,000		1965-1970	5.50"	Internal Threads	ES325L	ES325R
12,000		1973-1978	4.88"		ES405L	ES405R

Drag Links

Axle Lbs. Rating	Code	Year	Length (inches)	Notes	Drag Link No.
7,000		1978-1978	17.00"		DS1064
9,000		1978-1978	17.00"		DS1064
12,000		1978-1978	17.00"		DS1064

M65

King Bolt Sets

Axle Lbs. Rating	Code	Year	Diameter (inches)	Length (Inches)	Pin Type	Bushing	Notes	King Pin Set No.
7,000	(F070)	1973-1978	1.249"	7.890"	1	Metal		8491B
	(F070)	1973-1978	1.259"	7.890"	1	Metal		8491B010
	(F070)	1973-1978	1.249"	7.890"	1	Nylon		8491N
9,000	(F090)	1973-1978	1.186/1.434"	8.750"	7	Metal		8462B
	(F090)	1973-1978	1.186/1.434"	8.750"	7	Nylon		8462N
	(F120D)	1975-1978	1.745"	9.380"	1	Metal		8613B
12,000	(F120)	1973-1975	1.309/1.607"	9.750"	7	Metal		8386B
	(F120)	1975-1978	1.745"	9.380"	1	Metal		8613B
	(F120)	1973-1975	1.309/1.607"	9.750"	7	Nylon		8386N

Tie Rod Ends

Axle Lbs. Rating	Code	Year	Length (Inches)	Notes	Tie Rod End Part No.	
					Drivers Side	Passenger Side
7,000	(F070)	1973-1978	6.50"		ES332L	ES332R
9,000	(F090)	1973-1974	3.75"		ES176L	ES176R
	(F090)	1975-1978	4.88"		ES405L	ES405R
	(F120D)	1975-1978	4.88"		ES405L	ES405R
12,000	(F120)	1975-1978	4.88"	w/718934, 718936, 718937; 719597; 2000763; 2002084, 2002085, 2002086, 2002087 Axles	ES405L	ES405R
	(F120)	1973-1978	4.88"		ES405L	ES405R

Drag Links

Axle Lbs. Rating	Code	Year	Length (inches)	Notes	Drag Link No.
7,000	(F070)	1975-1978	17.00"	From 1975 Second Design	DS1064
9,000	(F090)	1973-1978	17.20"	w/Power Steering	DS982
			3.12"	Power Steering Cylinder End	ES2030R
	(F120D)	1975-1978	17.96"	From 1975 Second Design	DS987
			3.12"	Power Steering Cylinder End	ES2030R
			17.00"	From 1975 Second Design	DS1064
			17.96"		DS987
12,000	(F120)	1973-1978	3.12"	Power Steering Cylinder End	ES2030R

M90

King Bolt Sets

Axle Lbs. Rating	Code	Year	Diameter (inches)	Length (Inches)	Pin Type	Bushing	Notes	King Pin Set No.
9,000	(F090)	1970-1978	1.186/1.434"	8.750"	7	Metal		8462B
	(F090)	1970-1978	1.186/1.434"	8.750"	7	Nylon		8462N
	(F120D)	1975-1978	1.745"	9.380"	1	Metal		8613B
12,000	(F120)	1970-1974	1.309/1.607"	9.750"	7	Metal		8386B
	(F120)	1975-1978	1.745"	9.380"	1	Metal		8613B
	(F120)	1970-1974	1.309/1.607"	9.750"	7	Nylon		8386N
	(FE900)	1970-1974	1.309/1.607"	9.750"	7	Metal		8386B
	(FE900)	1970-1974	1.309/1.607"	9.750"	7	Nylon		8386N
	(F160)	1970-1972	1.400/1.794"	10.688"	7	Metal		8474B

CHEVROLET TRUCK



Heavy Duty Trucks

M90 (Cont'd)

King Bolt Sets (Cont'd)

Axle Lbs. Rating	Code	Year	Diameter (inches)	Length (Inches)	Pin Type	Bushing	Notes	King Pin Set No.
16,000	(FL901)	1970-1978	1.999"	11.040"	2	Metal		8518B
	(FL901)	1970-1978	1.999"	11.040"	2	Nylon		8518N
	(FL931)	1973-1978	1.999"	11.212"	2	Metal		8571B

Tie Rod Ends

Axle Lbs. Rating	Code	Year	Length (Inches)	Notes	Tie Rod End Part No.	
					Drivers Side	Passenger Side
9,000	(F090)	1970-1978	4.88"		ES405L	ES405R
	(F120D)	1975-1978	4.88"		ES405L	ES405R
12,000	(F120)	1975-1978	4.88"	From 1975 Second Design Before 1975 Second Design	ES405L	ES405R
	(F120)	1970-1975	4.88"		ES405L	ES405R
	(FE900)	1970-1972	4.88"		ES187L	ES187R
16,000	(F160)	1970-1972	4.88"		ES405L	ES405R
	(FL901)	1973-1978	5.75"		ES431L	ES431R
	(FL931)	1973-1978	12.69"		ES3031L	ES3030R
	(FL931)	1973-1978	5.75"		ES431L	ES431R
	(FL931)	1973-1978	7.37"		ES2090L	ES2091R

Drag Links

Axle Lbs. Rating	Code	Year	Length (inches)	Notes	Drag Link No.
9,000	(F090)	1970-1978	17.70"	w/Power Steering	DS910
			17.90"	w/Manual Steering	DS988
12,000	(F120)	1970-1978	17.70"	w/Power Steering	DS910
			17.90"	w/Manual Steering	DS988
16,000	(FL901)	1973-1978	17.82"	w/Power Steering-LH	DS939
				w/Power Steering Right Hand	DS938
			17.70"	w/Power Steering-RH	DS941
				w/Power Steering-LH	DS910

N,P (First Series)

King Bolt Sets

Axle Lbs. Rating	Code	Year	Diameter (inches)	Length (Inches)	Pin Type	Bushing	Notes	King Pin Set No.
		1953-1955	1.109"	6.343"	1	Metal		8343B
		1953-1955	0.921"	5.640"	1	Metal		8428B

Tie Rod Ends

Axle Lbs. Rating	Code	Year	Length (Inches)	Notes	Tie Rod End Part No.	
					Drivers Side	Passenger Side
		1953-1955	3.55"		ES26L	ES26R

N,P (Second Series),4A,4B

Tie Rod Ends

Axle Lbs. Rating	Code	Year	Length (Inches)	Notes	Tie Rod End Part No.	
					Drivers Side	Passenger Side
		1955-1959	3.55"		ES26L	ES26R

Drag Links

Axle Lbs. Rating	Code	Year	Length (inches)	Notes	Drag Link No.
		1955-1959	15.50"	w/Manual Steering	DS584

N,P(Second Series),4A,4B

King Bolt Sets

Axle Lbs. Rating	Code	Year	Diameter (inches)	Length (Inches)	Pin Type	Bushing	Notes	King Pin Set No.
		1955-1959	0.921"	5.640"	1	Metal		8445B
		1955-1959	0.921"	5.640"	1	Nylon		8445N

N50								
King Bolt Sets								
Axle Lbs. Rating	Code	Year	Diameter (inches)	Length (Inches)	Pin Type	Bushing	Notes	King Pin Set No.
7,000		1965-1966	1.249"	7.890"	1	Metal		8491B
		1965-1966	1.259"	7.890"	1	Metal		8491B010
		1965-1966	1.249"	7.890"	1	Nylon		8491N
9,000		1965-1966	1.186/1.434"	8.750"	7	Metal		8462B
		1965-1966	1.186/1.434"	8.750"	7	Nylon		8462N
Tie Rod Ends								
Axle Lbs. Rating	Code	Year	Length (Inches)	Notes	Tie Rod End Part No.			
					Drivers Side	Passenger Side		
7,000		1965-1966	6.50"		ES332L	ES332R		
9,000		1965-1966	3.75"		ES176L	ES176R		
		1965-1966	4.88"	Tilt Cab	ES405L	ES405R		
N60, Y60								
King Bolt Sets								
Axle Lbs. Rating	Code	Year	Diameter (inches)	Length (Inches)	Pin Type	Bushing	Notes	King Pin Set No.
7,000		1965-1966	1.249"	7.890"	1	Metal		8491B
		1965-1966	1.259"	7.890"	1	Metal		8491B010
		1965-1966	1.249"	7.890"	1	Nylon		8491N
9,000		1965-1966	1.186/1.434"	8.750"	7	Metal		8462B
		1965-1966	1.186/1.434"	8.750"	7	Nylon		8462N
11,000		1965-1966	1.309/1.607"	9.750"	7	Metal		8386B
		1965-1966	1.309/1.607"	9.750"	7	Nylon		8386N
Tie Rod Ends								
Axle Lbs. Rating	Code	Year	Length (Inches)	Notes	Tie Rod End Part No.			
					Drivers Side	Passenger Side		
7,000		1965-1966	6.50"		ES332L	ES332R		
9,000		1965-1966	3.75"		ES176L	ES176R		
11,000		1965-1966	5.50"	Internal Threads	ES325L	ES325R		
P40								
King Bolt Sets								
Axle Lbs. Rating	Code	Year	Diameter (inches)	Length (Inches)	Pin Type	Bushing	Notes	King Pin Set No.
5,000	(F050)	1979-1990	1.179"	6.360"	1	Metal		8570B
	(F050)	1979-1990	1.179"	6.360"	1	Nylon		8570N
7,000	(F070)	1979-1984	1.249"	7.890"	1	Metal		8491B
	(F070)	1979-1984	1.259"	7.890"	1	Metal		8491B010
	(F070)	1979-1984	1.249"	7.890"	1	Nylon		8491N
Tie Rod Ends								
Axle Lbs. Rating	Code	Year	Length (Inches)	Notes	Tie Rod End Part No.			
					Drivers Side	Passenger Side		
5,000	(F050)	1979-1990	4.93"		ES2061L	ES2062R		
7,000	(F070)	1979-1984	4.93"		ES2061L	ES2062R		
Drag Links								
Axle Lbs. Rating	Code	Year	Length (inches)	Notes	Drag Link No.			
5,000	(F050)	1982-1990	24.12"	w/Hydraulic Brakes	DS1195			
7,000	(F070)	1979-1982	24.12"	w/Hydraulic Brakes	DS1196			
P50								
King Bolt Sets								
Axle Lbs. Rating	Code	Year	Diameter (inches)	Length (Inches)	Pin Type	Bushing	Notes	King Pin Set No.
4,000		1965-1966	0.921"	5.640"	1	Metal		8445B
		1965-1966	0.921"	5.640"	1	Nylon		8445N
5,000		1965-1966	1.109"	6.344"	1	Metal	Thrust Washer Design	8484T
		1965-1966	1.109"	6.344"	1	Metal	Thrust Bearing Design	8492B

CHEVROLET TRUCK



P50 (Cont'd)

King Bolt Sets (Cont'd)

Axle Lbs. Rating	Code	Year	Diameter (inches)	Length (Inches)	Pin Type	Bushing	Notes	King Pin Set No.
5,000		1965-1966	1.109"	6.344"	1	Nylon	Thrust Bearing Design	8492N

Tie Rod Ends

Axle Lbs. Rating	Code	Year	Length (Inches)	Notes	Tie Rod End Part No.	
					Drivers Side	Passenger Side
5,000		1965-1966	5.86"		ES330L	ES330R

P60

King Bolt Sets

Axle Lbs. Rating	Code	Year	Diameter (inches)	Length (Inches)	Pin Type	Bushing	Notes	King Pin Set No.
5,000	(F050)	1983-1990	1.179"	6.360"	1	Metal		8570B
	(F050)	1983-1990	1.179"	6.360"	1	Nylon		8570N
7,000	(F070)	1983-1990	1.249"	7.890"	1	Metal		8491B
	(F070)	1983-1990	1.259"	7.890"	1	Metal		8491B010
	(F070)	1983-1990	1.249"	7.890"	1	Nylon		8491N
8,000	(FL1)	1992-1996	1.614"	8.035"	8	Metal		8659B
9,000	(F090)	1984-1990	1.745"	9.380"	1	Metal		8613B
11,000	(FL2)	1992-1996	1.892"	9.203"	8	Metal		8660B
12,000	(F120)	1984-1990	1.745"	9.380"	1	Metal		8613B

Tie Rod Ends

Axle Lbs. Rating	Code	Year	Length (Inches)	Notes	Tie Rod End Part No.	
					Drivers Side	Passenger Side
5,000	(F050)	1983-1990	4.93"		ES2061L	ES2062R
7,000	(F070)	1988-1990	10.80"		ES3026L	ES3027R
	(F070)	1983-1987	4.93"		ES2061L	ES2062R
8,000	(FL1)	1992-1994	5.02"	First Design	ES3268L	ES3269R
	(FL1)	1994-1996	5.44"	Second Design	ES3270L	ES3271R
9,000	(F090)	1983-1990	4.88"		ES405L	ES405R
11,000	(FL2)	1992-1996	5.44"		ES3274L	ES3275R
12,000	(F120)	1984-1990	4.88"		ES405L	ES405R

Drag Links

Axle Lbs. Rating	Code	Year	Length (inches)	Notes	Drag Link No.
5,000	(F050)	1983-1990	17.00"		DS1064
7,000	(F070)	1983-1990	17.00"	Exc. Motor Home Applications	DS1064
		1984-1990	17.62"	Motor Home Application w/Hydraulic Brakes	DS1197
		1988-1990	17.53"		DS1198
8,000	(FL1)	1992-1996	20.65"		DS1216
9,000	(F120D)	1983-1990	17.96"	w/Saginaw Power Steering & Hydraulic Brakes	DS987
		1988-1990	18.50"		DS1199
11,000	(FL2)	1992-1996	20.65"		DS1216
12,000	(F120)	1984-1990	17.96"		DS987

P6S

King Bolt Sets

Axle Lbs. Rating	Code	Year	Diameter (inches)	Length (Inches)	Pin Type	Bushing	Notes	King Pin Set No.
8,000		1992-1996	1.614"	8.035"	8	Metal	(3675 kg)	8659B
11,000	(FL2)	1992-1996	1.892"	9.203"	8	Metal	(5000 kg)	8660B

Tie Rod Ends

Axle Lbs. Rating	Code	Year	Length (Inches)	Notes	Tie Rod End Part No.	
					Drivers Side	Passenger Side
8,000	(FL1)	1992-1994	5.02"	First Design	ES3268L	ES3269R
	(FL1)	1994-1996	5.44"	Second Design	ES3270L	ES3271R
11,000	(FL2)	1992-1996	5.44"	(5000 kg)	ES3274L	ES3275R

Drag Links

Axle Lbs. Rating	Code	Year	Length (inches)	Notes	Drag Link No.
------------------	------	------	-----------------	-------	---------------

P6S (Cont'd)

Drag Links (Cont'd)

Axle Lbs. Rating	Code	Year	Length (inches)	Notes	Drag Link No.
8,000	(FL1)		20.65"		DS1216
11,000	(FL2)		20.65"		DS1216

Q60, V60, X60

King Bolt Sets

Axle Lbs. Rating	Code	Year	Diameter (inches)	Length (Inches)	Pin Type	Bushing	Notes	King Pin Set No.
5,000		1965-1966	1.109"	6.344"	1	Metal	Thrust Washer Design	8484T
		1965-1966	1.109"	6.344"	1	Metal	Thrust Bearing Design	8492B
		1965-1966	1.109"	6.344"	1	Nylon	Thrust Bearing Design	8492N
7,000		1965-1966	1.249"	7.890"	1	Metal		8491B
		1965-1966	1.259"	7.890"	1	Metal		8491B010
		1965-1966	1.249"	7.890"	1	Nylon		8491N
9,000		1965-1966	1.186/1.434"	8.750"	7	Metal		8462B
		1965-1966	1.186/1.434"	8.750"	7	Nylon		8462N

Tie Rod Ends

Axle Lbs. Rating	Code	Year	Length (Inches)	Notes	Tie Rod End Part No.	
					Drivers Side	Passenger Side
5,000		1965-1966	5.86"		ES330L	ES330R
7,000		1965-1966	6.50"		ES332L	ES332R
9,000		1965-1966	3.75"		ES176L	ES176R

QJ, QK, RJ, RK, SJ, SK, TJ, TK

King Bolt Sets

Axle Lbs. Rating	Code	Year	Diameter (inches)	Length (Inches)	Pin Type	Bushing	Notes	King Pin Set No.
		1947-1950	0.921"	5.125"	1	Metal		8207B

Tie Rod Ends

Axle Lbs. Rating	Code	Year	Length (Inches)	Notes	Tie Rod End Part No.	
					Drivers Side	Passenger Side
		1947-1950	3.55"		ES26L	ES26R

R (Second Series), 4C

King Bolt Sets

Axle Lbs. Rating	Code	Year	Diameter (inches)	Length (Inches)	Pin Type	Bushing	Notes	King Pin Set No.
		1955-1959	1.109"	6.343"	1	Metal		8343B

Drag Links

Axle Lbs. Rating	Code	Year	Length (inches)	Notes	Drag Link No.
		1955-1959	15.50"	w/Manual Steering	DS584

Regular and School Bus, COE

King Bolt Sets

Axle Lbs. Rating	Code	Year	Diameter (inches)	Length (Inches)	Pin Type	Bushing	Notes	King Pin Set No.
		1947-1951	1.109"	6.343"	1	Metal		8343B

Regular and School Bus, COE(1955 1st Series)

King Bolt Sets

Axle Lbs. Rating	Code	Year	Diameter (inches)	Length (Inches)	Pin Type	Bushing	Notes	King Pin Set No.
		1951-1959	1.109"	6.343"	1	Metal		8343B

Regular School Bus 6A, 6B, 6C, 6D, 6E(except Heavy Duty)

King Bolt Sets

Axle Lbs. Rating	Code	Year	Diameter (inches)	Length (Inches)	Pin Type	Bushing	Notes	King Pin Set No.

CHEVROLET TRUCK



Regular School Bus 6A,6B,6C,6D,6E(except Heavy Duty) (Cont'd)

King Bolt Sets (Cont'd)

Axle Lbs. Rating	Code	Year	Diameter (inches)	Length (Inches)	Pin Type	Bushing	Notes	King Pin Set No.
		1955-1959	1.109"	6.343"	1	Metal		8343B

Drag Links

Axle Lbs. Rating	Code	Year	Length (inches)	Notes	Drag Link No.
		1955-1959	15.50"	w/Manual Steering	DS584

S50, Q50

King Bolt Sets

Axle Lbs. Rating	Code	Year	Diameter (inches)	Length (Inches)	Pin Type	Bushing	Notes	King Pin Set No.
4,000		1965-1966	0.921"	5.640"	1	Metal		8445B
		1965-1966	0.921"	5.640"	1	Nylon		8445N
5,000		1965-1975	1.109"	6.344"	1	Metal	Thrust Washer Design	8484T
		1964-1964	1.109"	6.344"	1	Metal	Thrust Washer Design	8484T
		1965-1975	1.109"	6.344"	1	Metal	Thrust Bearing Design	8492B
		1964-1964	1.109"	6.344"	1	Metal	Second Design w/Thrust Bearing	8492B
		1965-1975	1.109"	6.344"	1	Nylon	Thrust Bearing Design	8492N
		1964-1964	1.109"	6.344"	1	Nylon	Second Design w/Thrust Bearing	8492N
7,000		1964-1975	1.249"	7.890"	1	Metal	From 1964 Second Design	8491B
		1964-1975	1.259"	7.890"	1	Metal	From 1964 Second Design	8491B010
		1964-1975	1.249"	7.890"	1	Nylon	From 1964 Second Design	8491N
9,000		1963-1972	1.186/1.434"	8.750"	7	Metal		8462B
		1963-1972	1.186/1.434"	8.750"	7	Nylon		8462N

Tie Rod Ends

Axle Lbs. Rating	Code	Year	Length (Inches)	Notes	Tie Rod End Part No.	
					Drivers Side	Passenger Side
5,000		1963-1975	5.86"		ES330L	ES330R
7,000		1963-1975	6.50"		ES332L	ES332R
9,000		1962-1972	3.75"		ES176L	ES176R

Drag Links

Axle Lbs. Rating	Code	Year	Length (inches)	Notes	Drag Link No.
5,000		1967-1967 1968-1971	16.75"		DS929 DS835

S60

King Bolt Sets

Axle Lbs. Rating	Code	Year	Diameter (inches)	Length (Inches)	Pin Type	Bushing	Notes	King Pin Set No.
5,000		1964-1969	1.109"	6.344"	1	Metal	From 1964 Second Design; Thrust Washer	8484T
		1964-1969	1.109"	6.344"	1	Metal	From 1964 Second Design; Thrust Bearing	8492B
		1964-1969	1.109"	6.344"	1	Nylon	From 1964 Second Design; Thrust Bearing	8492N
5,500		1973-1975	1.109"	6.344"	1	Metal	Before 1975 Second Design; Thrust Washer	8484T
		1973-1975	1.109"	6.344"	1	Metal	Before 1975 Second Design	8492B
		1975-1979	1.179"	6.360"	1	Metal	From 1975 Second Design	8570B
		1973-1975	1.109"	6.344"	1	Nylon	Before 1975 Second Design	8492N
		1975-1979	1.179"	6.360"	1	Nylon	From 1975 Second Design	8570N
7,000		1973-1979	1.249"	7.890"	1	Metal		8491B
		1964-1969	1.249"	7.890"	1	Metal	From 1964 Second Design	8491B
		1964-1969	1.259"	7.890"	1	Metal	From 1964 Second Design	8491B010
		1973-1979	1.259"	7.890"	1	Metal		8491B010
		1964-1969	1.249"	7.890"	1	Nylon	From 1964 Second Design	8491N
9,000		1965-1969	1.186/1.434"	8.750"	7	Metal		8462B
		1973-1979	1.186/1.434"	8.750"	7	Metal	Exc. F120D Axle	8462B
		1973-1979	1.186/1.434"	8.750"	7	Nylon	Exc. F120D Axle	8462N
		1965-1969	1.186/1.434"	8.750"	7	Nylon		8462N

Tie Rod Ends

Axle Lbs. Rating	Code	Year	Length (Inches)	Notes	Tie Rod End Part No.	
					Drivers Side	Passenger Side
5,000		1963-1969	5.86"		ES330L	ES330R
5,500		1973-1979	5.86"		ES330L	ES330R

Heavy Duty Trucks

S60 (Cont'd)

Tie Rod Ends (Cont'd)

Axle Lbs. Rating	Code	Year	Length (Inches)	Notes	Tie Rod End Part No.	
					Drivers Side	Passenger Side
7,000		1978-1979	4.93"		ES2061L	ES2062R
		1963-1969	6.50"		ES332L	ES332R
9,000		1973-1974	3.75"		ES176L	ES176R
		1963-1969	3.75"		ES176L	ES176R
		1975-1979	4.88"		ES405L	ES405R

Drag Links

Axle Lbs. Rating	Code	Year	Length (inches)	Notes	Drag Link No.
5.500		1973-1975	16.75"	Before 1975 Second Design From 1975 Second Design	DS835
		1975-1979	17.00"		DS1064
7.000		1973-1975	16.75"	Before 1975 Second Design From 1975 Second Design	DS835
		1975-1979	17.00"		DS1064

S70, S7T

King Bolt Sets

Axle Lbs. Rating	Code	Year	Diameter (inches)	Length (Inches)	Pin Type	Bushing	Notes	King Pin Set No.
12,000	(F120)	1983-1990	1.745"	9.380"	1	Metal		8613B
13,200	(FG943)	1987-1990	1.794"	10.392"	2	Metal	Kit 1307	8590B

Tie Rod Ends

Axle Lbs. Rating	Code	Year	Length (Inches)	Notes	Tie Rod End Part No.	
					Drivers Side	Passenger Side
9,000	(F120)	1983-1990	4.88"		ES405L	ES405R
	(F120D)	1983-1990	4.88"		ES405L	ES405R
12,000	(F120)	1983-1990	4.88"		ES405L	ES405R
	(F120D)	1983-1990	4.88"		ES405L	ES405R
13,200	(FG943)	1987-1990	5.44"		ES423L	ES423R

Drag Links

Axle Lbs. Rating	Code	Year	Length (inches)	Notes	Drag Link No.
9.000	(F120)	1983-1984	17.70"	w/Power Steering	DS910
12.000	(F120)	1983-1984	17.70"	w/Power Steering	DS910
13.200	(FF932)	1983-1984	17.70"	w/Power Steering	DS910

School Bus 6D,6E (Heavy Duty)

Tie Rod Ends

Axle Lbs. Rating	Code	Year	Length (Inches)	Notes	Tie Rod End Part No.	
					Drivers Side	Passenger Side
		1957-1959	3.75"		ES176L	ES176R

Drag Links

Axle Lbs. Rating	Code	Year	Length (inches)	Notes	Drag Link No.
		1957-1959	15.50"	w/Manual Steering	DS584

SL,TL,UL,VL,R (First Series)

King Bolt Sets

Axle Lbs. Rating	Code	Year	Diameter (inches)	Length (Inches)	Pin Type	Bushing	Notes	King Pin Set No.
		1949-1955	1.109"	6.343"	1	Metal		8343B

T50

King Bolt Sets

Axle Lbs. Rating	Code	Year	Diameter (inches)	Length (Inches)	Pin Type	Bushing	Notes	King Pin Set No.
5,000		1965-1972	1.109"	6.344"	1	Metal	Thrust Washer Design	8484T
		1965-1972	1.109"	6.344"	1	Metal	Thrust Bearing Design	8492B
		1965-1972	1.109"	6.344"	1	Nylon	Thrust Bearing Design	8492N
7,000		1965-1972	1.249"	7.890"	1	Metal		8491B

CHEVROLET TRUCK



Heavy Duty Trucks

T50 (Cont'd)

King Bolt Sets (Cont'd)

Axle Lbs. Rating	Code	Year	Diameter (inches)	Length (Inches)	Pin Type	Bushing	Notes	King Pin Set No.
7,000		1965-1972	1.259"	7.890"	1	Metal		8491B010
		1965-1972	1.249"	7.890"	1	Nylon		8491N
9,000		1965-1972	1.186/1.434"	8.750"	7	Metal		8462B
		1965-1972	1.186/1.434"	8.750"	7	Nylon		8462N
11,000		1965-1972	1.309/1.607"	9.750"	7	Metal		8386B
		1965-1972	1.309/1.607"	9.750"	7	Nylon		8386N

Tie Rod Ends

Axle Lbs. Rating	Code	Year	Length (Inches)	Notes	Tie Rod End Part No.	
					Drivers Side	Passenger Side
5,000		1965-1972	5.86"		ES330L	ES330R
7,000		1965-1972	6.50"		ES332L	ES332R
9,000		1965-1970	3.75"		ES176L	ES176R
		1970-1972	4.88"		ES405L	ES405R
11,000		1965-1972	5.50"	Internal Threads	ES325L	ES325R

T5500

King Bolt Sets

Axle Lbs. Rating	Code	Year	Diameter (inches)	Length (Inches)	Pin Type	Bushing	Notes	King Pin Set No.
8,000	(FL1)	1997-1999	1.614"	8.035"	8	Metal	(3675 kg)	8659B
	(FL1)	1997-1999	1.614"	8.035"	8	Metal	(3675 kg)	8659B
8,100	(FL1)	1997-2000	1.614"	8.035"	8	Metal		8659B
11,000	(FL2)	1997-2000	1.892"	9.203"	8	Metal	(5000 kg)	8660B
12,000	(FS7)	1997-2000	1.892"	9.203"	8	Metal	w/Hydraulic Brakes; (5450 kg)	8660B
14,000	(FH0)	1997-2000	1.892"	9.604"	8	Metal		8661B
14,600	(FL3)	1997-2000	1.892"	9.604"	8	Metal		8661B
	(FL3)	1997-2000	1.892"	9.604"	8	Metal		8661B
16,000	(FH4)	1997-2000	1.870"	9.970"	1	Composite	(7275 kg)	8633C
	(FH4)	1997-2000	1.870"	9.970"	1	Composite		8633C
	(FH4)	1997-2000	1.870"	9.970"	1	Metal	(7275 kg)	8633B
	(FH4)	1997-2000	1.870"	9.970"	1	Metal		8633B

Tie Rod Ends

Axle Lbs. Rating	Code	Year	Length (Inches)	Notes	Tie Rod End Part No.	
					Drivers Side	Passenger Side
8,000	(FL1)	1997-2000	5.44"		ES3270L	ES3271R
11,000	(FL2)	1997-2000	5.44"		ES3274L	ES3275R
12,000	(FS7)	1997-2000	5.44"		ES3274L	ES3275R
14,000	(FH0)	1997-2000	5.44"		ES3274L	ES3275R
14,600	(FL3)	1997-2000	5.44"		ES3274L	ES3275R
16,000	(FH4)	1997-2000	7.37"		ES2090L	ES2091R

Drag Links

Axle Lbs. Rating	Code	Year	Length (inches)	Notes	Drag Link No.
8,000	(FL1)	1997-2000	20.28"	w/Air Brakes	DS1277
			20.65"	w/Hydraulic Brakes	DS1216
11,000	(FL2)	1997-2000	17.48"	w/Ross Gear	DS1217
			20.28"	w/Air Brakes and Saginaw Steering	DS1277
			20.65"	w/Hydraulic Brakes and Saginaw Steering	DS1216
12,000	(FS7)	1997-2000	16.85"	w/Air brakes	DS1278
			17.48"	w/Hydraulic Brakes, 1991-98	DS1217
14,600	(FL3)	1997-2000	16.85"		DS1278

T60

King Bolt Sets

Axle Lbs. Rating	Code	Year	Diameter (inches)	Length (Inches)	Pin Type	Bushing	Notes	King Pin Set No.
7,000		1964-1978	1.249"	7.890"	1	Metal	From 1964 Second Design	8491B
		1964-1978	1.259"	7.890"	1	Metal	From 1964 Second Design	8491B010
		1964-1978	1.249"	7.890"	1	Nylon	From 1964 Second Design	8491N
9,000		1963-1978	1.186/1.434"	8.750"	7	Metal		8462B
		1963-1978	1.186/1.434"	8.750"	7	Nylon		8462N
11,000		1963-1969	1.309/1.607"	9.750"	7	Metal		8386B

T60 (Cont'd)

King Bolt Sets (Cont'd)

Axle Lbs. Rating	Code	Year	Diameter (inches)	Length (Inches)	Pin Type	Bushing	Notes	King Pin Set No.
11,000		1963-1969	1.309/1.607"	9.750"	7	Nylon		8386N
12,000		1970-1972	1.309/1.607"	9.750"	7	Metal		8386B
		1970-1972	1.309/1.607"	9.750"	7	Nylon		8386N

Tie Rod Ends

Axle Lbs. Rating	Code	Year	Length (Inches)	Notes	Tie Rod End Part No.	
					Drivers Side	Passenger Side
7,000		1978-1978	4.93"		ES2061L	ES2062R
		1963-1977	6.50"		ES332L	ES332R
9,000		1963-1975	3.75"	Before 1975 Second Design From 1975 Second Design	ES176L	ES176R
		1975-1978	4.88"		ES405L	ES405R
11,000		1963-1969	5.50"	Internal Threads	ES325L	ES325R
12,000		1970-1972	4.88"		ES405L	ES405R

T65

King Bolt Sets

Axle Lbs. Rating	Code	Year	Diameter (inches)	Length (Inches)	Pin Type	Bushing	Notes	King Pin Set No.
7,000	(F070)	1973-1978	1.249"	7.890"	1	Metal		8491B
	(F070)	1973-1978	1.259"	7.890"	1	Metal		8491B010
	(F070)	1973-1978	1.249"	7.890"	1	Nylon		8491N
9,000	(F090)	1973-1978	1.186/1.434"	8.750"	7	Metal		8462B
	(F090)	1973-1978	1.186/1.434"	8.750"	7	Nylon		8462N
	(F120D)	1975-1978	1.745"	9.380"	1	Metal		8613B
12,000	(F120)	1973-1975	1.309/1.607"	9.750"	7	Metal		8386B
	(F120)	1975-1978	1.745"	9.380"	1	Metal		8613B
	(F120)	1973-1975	1.309/1.607"	9.750"	7	Nylon		8386N

Tie Rod Ends

Axle Lbs. Rating	Code	Year	Length (Inches)	Notes	Tie Rod End Part No.	
					Drivers Side	Passenger Side
7,000	(F070)	1973-1978	6.50"		ES332L	ES332R
9,000	(F090)	1973-1974	3.75"		ES176L	ES176R
	(F090)	1975-1978	4.88"		ES405L	ES405R
	(F120D)	1975-1978	4.88"		ES405L	ES405R
12,000	(F120)	1975-1978	4.88"	w/718934, 718936, 718937; 719597; 2000763; 2002084, 2002085, 2002086, 2002087 Axles	ES405L	ES405R
	(F120)	1973-1978	4.88"		ES405L	ES405R

Drag Links

Axle Lbs. Rating	Code	Year	Length (inches)	Notes	Drag Link No.
7,000	(F070)	1978-1978	32.22"	TE65 Only	DS983

T6500

King Bolt Sets

Axle Lbs. Rating	Code	Year	Diameter (inches)	Length (Inches)	Pin Type	Bushing	Notes	King Pin Set No.
8,000	(FL1)	1997-2000	1.614"	8.035"	8	Metal	(3675 kg)	8659B
	(FL1)	1997-2000	1.614"	8.035"	8	Metal	(3675 kg)	8659B
11,000	(FL2)	1997-2000	1.892"	9.203"	8	Metal	(5000 kg)	8660B
12,000	(FS7)	1997-2000	1.892"	9.203"	8	Metal	w/Hydraulic Brakes; (5450 kg)	8660B
14,000	(FH0)	1997-2000	1.892"	9.604"	8	Metal		8661B
14,600	(FL3)	1997-2000	1.892"	9.604"	8	Metal		8661B
	(FL3)	1997-2000	1.892"	9.604"	8	Metal		8661B
16,000	(FH4)	1997-2000	1.870"	9.970"	1	Composite	(7275 kg)	8633C
	(FH4)	1997-2000	1.870"	9.970"	1	Metal	(7275 kg)	8633B

Tie Rod Ends

Axle Lbs. Rating	Code	Year	Length (Inches)	Notes	Tie Rod End Part No.	
					Drivers Side	Passenger Side
8,000	(FL1)	1997-1999	5.44"	(3675 kg)	ES3270L	ES3271R
11,000	(FL2)	1997-1999	5.44"	(5000 kg)	ES3274L	ES3275R

CHEVROLET TRUCK



T6500 (Cont'd)

Tie Rod Ends (Cont'd)

Axle Lbs. Rating	Code	Year	Length (Inches)	Notes	Tie Rod End Part No.	
					Drivers Side	Passenger Side
12,000	(FS7)	1997-1999	5.44"	(5450 kg)	ES3274L	ES3275R
14,000	(FH0)	1997-2000	5.44"		ES3274L	ES3275R
14,600	(FL3)	1997-1999	5.44"	(6610 kg)	ES3274L	ES3275R
16,000	(FH4)	1997-1999	7.37"	(7275 kg)	ES2090L	ES2091R

Drag Links

Axle Lbs. Rating	Code	Year	Length (inches)	Notes	Drag Link No.
8,000	(FL1)	1997-1999	20.28"	w/Air Brakes	DS1277
			20.65"	w/Hydraulic Brakes	DS1216
11,000	(FL2)	1997-1999	17.48"	w/Ross Gear	DS1217
			20.28"	w/Air Brakes and Saginaw Steering	DS1277
			20.65"	w/Hydraulic Brakes and Saginaw Steering	DS1216
12,000	(FS7)	1997-1999	16.85"	w/Air brakes	DS1278
			17.48"	W/Hydraulic Brakes, 1991-98	DS1217
14,600	(FL3)	1997-1999	16.85"		DS1278

T70

King Bolt Sets

Axle Lbs. Rating	Code	Year	Diameter (inches)	Length (Inches)	Pin Type	Bushing	Notes	King Pin Set No.
7,000	(F070)	1966-1978	1.249"	7.890"	1	Metal		8491B
	(F070)	1966-1978	1.259"	7.890"	1	Metal		8491B010
	(F070)	1966-1978	1.249"	7.890"	1	Nylon		8491N
9,000	(F090)	1966-1978	1.186/1.434"	8.750"	7	Metal		8462B
	(F090)	1966-1978	1.186/1.434"	8.750"	7	Nylon		8462N
11,000	(F110)	1966-1972	1.309/1.607"	9.750"	7	Metal		8386B
	(F110)	1966-1972	1.309/1.607"	9.750"	7	Nylon		8386N
12,000	(F120)	1966-1974	1.309/1.607"	9.750"	7	Metal		8386B
	(F120)	1975-1978	1.745"	9.380"	1	Metal		8613B
	(F120)	1966-1974	1.309/1.607"	9.750"	7	Nylon		8386N

Tie Rod Ends

Axle Lbs. Rating	Code	Year	Length (Inches)	Notes	Tie Rod End Part No.	
					Drivers Side	Passenger Side
7,000	(F070)	1978-1978	4.93"	Use w/6V-53 Engine and 465018 Axle	ES2061L	ES2062R
		1973-1978	6.50"		ES332L	ES332R
9,000	(F090)	1973-1978	3.75"	w/688568 Axle Only	ES176L	ES176R
		1966-1972	3.75"		ES176L	ES176R
		1972-1978	4.88"		ES405L	ES405R
12,000	(F120)	1973-1978	4.88"	Exc. 688561, 688568; 2000765, 2000767, 2000768; 2002081, 2002083 Axles	ES405L	ES405R
		1973-1978	5.50"		Internal Threads; w/688561 Axle	ES325L

T7500

King Bolt Sets

Axle Lbs. Rating	Code	Year	Diameter (inches)	Length (Inches)	Pin Type	Bushing	Notes	King Pin Set No.
8,000	(FL1)	1997-2000	1.614"	8.035"	8	Metal	(3675 kg)	8659B
11,000	(FL2)	1997-2000	1.892"	9.203"	8	Metal	(5000 kg)	8660B
12,000	(FS7)	1997-2000	1.892"	9.203"	8	Metal	w/Hydraulic Brakes; (5450 kg)	8660B
14,000	(FH0)	1997-2000	1.892"	9.604"	8	Metal		8661B
14,600	(FL3)	1997-2000	1.892"	9.604"	8	Metal		8661B
16,000	(FH4)	1997-2000	1.870"	9.970"	1	Composite	(7275 kg)	8633C
	(FH4)	1997-2000	1.870"	9.970"	1	Composite		8633C
	(FH4)	1997-2000	1.870"	9.970"	1	Metal	(7275 kg)	8633B
	(FH4)	1997-2000	1.870"	9.970"	1	Metal		8633B

Tie Rod Ends

Axle Lbs. Rating	Code	Year	Length (Inches)	Notes	Tie Rod End Part No.	
					Drivers Side	Passenger Side
8,000	(FL1)	1997-1999	5.44"	(3675 kg)	ES3270L	ES3271R
11,000	(FL2)	1997-1999	5.44"	(5000 kg)	ES3274L	ES3275R

T7500 (Cont'd)

Tie Rod Ends (Cont'd)

Axle Lbs. Rating	Code	Year	Length (Inches)	Notes	Tie Rod End Part No.	
					Drivers Side	Passenger Side
12,000	(FS7)	1997-1999	5.44"	(5450 kg)	ES3274L	ES3275R
14,000	(FH0)	1997-2000	5.44"		ES3274L	ES3275R
14,600	(FL3)	1997-1999	5.44"	(6610 kg)	ES3274L	ES3275R
16,000	(FH4)	1997-2000	7.37"	(7275 kg)	ES2090L	ES2091R
	(FH4)	1997-1999	7.37"		ES2090L	ES2091R

Drag Links

Axle Lbs. Rating	Code	Year	Length (inches)	Notes	Drag Link No.
8,000	(FL1)	1997-2000	20.28"	w/Air Brakes	DS1277
			20.65"	w/Hydraulic Brakes	DS1216
11,000	(FL2)	1997-2000	17.48"	w/Ross Gear	DS1217
			20.28"	w/Air Brakes and Saginaw Steering	DS1277
			20.65"	w/Hydraulic Brakes and Saginaw Steering	DS1216
12,000	(FS7)	1997-2000	16.85"	w/Air brakes	DS1278
			17.48"	W/Hydraulic Brakes, 1991-98	DS1217
14,600	(FL3)	1997-2000	16.85"		DS1278

T80

King Bolt Sets

Axle Lbs. Rating	Code	Year	Diameter (inches)	Length (Inches)	Pin Type	Bushing	Notes	King Pin Set No.
7,000		1964-1966	1.249"	7.890"	1	Metal	From 1964 Second Design	8491B
		1964-1966	1.259"	7.890"	1	Metal	From 1964 Second Design	8491B010
		1964-1966	1.249"	7.890"	1	Nylon	From 1964 Second Design	8491N
9,000	(F090)	1963-1978	1.186/1.434"	8.750"	7	Metal		8462B
		1963-1978	1.186/1.434"	8.750"	7	Nylon		8462N
11,000	(F110)	1963-1966	1.309/1.607"	9.750"	7	Metal		8386B
		1963-1966	1.309/1.607"	9.750"	7	Nylon		8386N
12,000	(F120)	1973-1978	1.309/1.607"	9.750"	7	Metal		8386B
		1973-1978	1.309/1.607"	9.750"	7	Nylon		8386N

Tie Rod Ends

Axle Lbs. Rating	Code	Year	Length (Inches)	Notes	Tie Rod End Part No.	
					Drivers Side	Passenger Side
7,000		1963-1966	6.50"		ES332L	ES332R
9,000	(F090)	1963-1966	3.75"	Exc. 688561, 688568; 2000765, 2000767, 2000768; 2002081, 2002083 Axles	ES176L	ES176R
		1973-1978	4.88"		ES405L	ES405R
11,000		1963-1966	5.50"	Internal Threads	ES325L	ES325R
12,000		1973-1978	4.88"	Exc. 688561, 688568; 2000765, 2000767, 2000768; 2002081, 2002083 Axles	ES405L	ES405R

T8500

King Bolt Sets

Axle Lbs. Rating	Code	Year	Diameter (inches)	Length (Inches)	Pin Type	Bushing	Notes	King Pin Set No.
8,000	(FL1)	1997-2000	1.614"	8.035"	8	Metal	(3675 kg)	8659B
		1997-2000	1.614"	8.035"	8	Metal	(3675 kg)	8659B
8,100	(FL1)	1997-2000	1.614"	8.035"	8	Metal		8659B
11,000	(FL2)	1997-2000	1.892"	9.203"	8	Metal	(5000 kg)	8660B
		1997-2000	1.892"	9.203"	8	Metal		8660B
12,000	(FS7)	1997-2000	1.892"	9.203"	8	Metal	w/Hydraulic Brakes; (5450 kg)	8660B
		1997-2000	1.892"	9.604"	8	Metal	w/Hydraulic Brakes	8661B
14,000	(FH0)	1997-2000	1.892"	9.604"	8	Metal		8661B
14,500	(FL3)	1997-2000	1.892"	9.604"	8	Metal		8661B
14,600	(FL3)	1997-2000	1.892"	9.604"	8	Metal		8661B
		1997-2000	1.892"	9.604"	8	Metal		8661B
		1997-2000	1.892"	9.604"	8	Metal		8661B
16,000	(FH4)	1997-2000	1.870"	9.970"	1	Composite	(7275 kg)	8633C
		1997-2000	1.870"	9.970"	1	Composite		8633C
		1997-2000	1.870"	9.970"	1	Metal		8633B
		1997-2000	1.870"	9.970"	1	Metal		8633B

CHEVROLET TRUCK



T8500 (Cont'd)

Tie Rod Ends

Axle Lbs. Rating	Code	Year	Length (Inches)	Notes	Tie Rod End Part No.	
					Drivers Side	Passenger Side
8,000	(FL1)	1997-2000	5.44"	(3675 kg)	ES3270L	ES3271R
11,000	(FL2)	1997-2000	5.44"	(5000 kg)	ES3274L	ES3275R
12,000	(FS7)	1997-2000	5.44"	(5450 kg)	ES3274L	ES3275R
14,000	(FH0)	1997-2000	5.44"		ES3274L	ES3275R
14,600	(FL3)	1997-2000	5.44"	(6610 kg)	ES3274L	ES3275R
16,000	(FH4)	1997-2000	7.37"	(7275 kg)	ES2090L	ES2091R
	(FH4)	1997-2000	7.37"		ES2090L	ES2091R

Drag Links

Axle Lbs. Rating	Code	Year	Length (inches)	Notes	Drag Link No.
8,000	(FL1)	1997-2000	20.28"	w/Air Brakes	DS1277
			20.65"	w/Hydraulic Brakes	DS1216
11,000	(FL2)	1997-2000	17.48"	w/Ross Gear	DS1217
			20.28"	w/Air Brakes and Saginaw Steering	DS1277
			20.65"	w/Hydraulic Brakes and Saginaw Steering	DS1216
12,000	(FS7)	1997-2000	16.85"	w/Air brakes	DS1278
			17.48"	W/Hydraulic Brakes,1991-98	DS1217
14,600	(FL3)	1997-2000	16.85"		DS1278

T90

King Bolt Sets

Axle Lbs. Rating	Code	Year	Diameter (inches)	Length (Inches)	Pin Type	Bushing	Notes	King Pin Set No.
12,000	(F120)	1970-1978	1.309/1.607"	9.750"	7	Metal		8386B
	(F120)	1970-1978	1.309/1.607"	9.750"	7	Nylon		8386N

Tie Rod Ends

Axle Lbs. Rating	Code	Year	Length (Inches)	Notes	Tie Rod End Part No.	
					Drivers Side	Passenger Side
12,000	(F120)	1970-1978	4.88"		ES405L	ES405R

Titan

King Bolt Sets

Axle Lbs. Rating	Code	Year	Diameter (inches)	Length (Inches)	Pin Type	Bushing	Notes	King Pin Set No.
12,000	(F120)	1979-1982	1.745"	9.380"	1	Metal		8613B
	(FF931)	1979-1988	1.794"	10.392"	2	Metal		8590B
	(FF971)	1979-1980	1.607"	9.380"	2	Metal		8612B
16,000	(FL931)	1979-1982	1.999"	11.212"	2	Metal		8571B

Tie Rod Ends

Axle Lbs. Rating	Code	Year	Length (Inches)	Notes	Tie Rod End Part No.	
					Drivers Side	Passenger Side
12,000	(F120)	1979-1982	4.88"	1-1/8"-18 Optional Thread	ES405L	ES405R
	(FF931)	1979-1988	5.44"		ES423L	ES3312R
	(FF931)	1979-1988	5.44"		ES2200L	ES423R
	(FF971)	1979-1980	10.50"		ES2201R	ES2201R
16,000	(FL931)	1979-1982	12.69"		ES3031L	ES3030R
	(FL931)	1979-1982	5.75"		ES431L	ES431R
	(FL931)	1979-1982	7.37"		ES2090L	ES2091R
18,000	(FL941)	1983-1983	7.37"		ES2090L	ES2091R

Drag Links

Axle Lbs. Rating	Code	Year	Length (inches)	Notes	Drag Link No.
12,000	(F120)	1979-1982	16.89"	w/Ross Gear Power Strg	DS1044
		1979-1983	17.90"	Color Coded White	DS988
			18.20"	Color Coded Blue	DS991
			16.89"	w/Sheppard Power Steering-LH	DS1044
	(FF931)	1984-1987	17.90"		DS988
		1983-1984	17.90"		DS988
		1983-1983	18.20"		DS991
		1983-1984	17.90"		DS988
	(FF941)	1983-1984	18.20"		DS991

Titan (Cont'd)

Drag Links (Cont'd)

Axle Lbs. Rating	Code	Year	Length (inches)	Notes	Drag Link No.
12,000	(FF971)	1983-1983	17.90"		DS988
			18.20"		DS991
16,000	(FL931)	1979-1982	17.90"	Color Coded White	DS988
			18.20"	Color Coded Blue	DS991
18,000	(FL941)	1983-1984	17.90"	w/Sheppard Power Steering-LH	DS988
		1983-1983	18.20"		DS991
		1984-1987	16.89"		DS1044

UJ,UK,VJ,VK

King Bolt Sets

Axle Lbs. Rating	Code	Year	Diameter (inches)	Length (Inches)	Pin Type	Bushing	Notes	King Pin Set No.
		1951-1952	1.109"	6.343"	1	Metal		8343B

W60, W6N

King Bolt Sets

Axle Lbs. Rating	Code	Year	Diameter (inches)	Length (Inches)	Pin Type	Bushing	Notes	King Pin Set No.
7,000	(F070)	1979-1980	1.249"	7.890"	1	Metal		8491B
	(F070)	1979-1980	1.259"	7.890"	1	Metal		8491B010
	(F070)	1979-1980	1.249"	7.890"	1	Nylon		8491N
9,000	(F090)	1979-1980	1.186/1.434"	8.750"	7	Metal		8462B
	(F090)	1979-1980	1.186/1.434"	8.750"	7	Nylon		8462N

Tie Rod Ends

Axle Lbs. Rating	Code	Year	Length (Inches)	Notes	Tie Rod End Part No.	
					Drivers Side	Passenger Side
7,000	(F070)	1979-1980	4.93"		ES2061L	ES2062R
9,000	(F090)	1979-1980	4.88"		ES405L	ES405R

W60,W6N

Drag Links

Axle Lbs. Rating	Code	Year	Length (inches)	Notes	Drag Link No.
7,000	(F070)	1979-1983	32.22"		DS983

W70, W7N

King Bolt Sets

Axle Lbs. Rating	Code	Year	Diameter (inches)	Length (Inches)	Pin Type	Bushing	Notes	King Pin Set No.
7,000	(F070)	1979-1980	1.249"	7.890"	1	Metal		8491B
	(F070)	1979-1980	1.259"	7.890"	1	Metal		8491B010
	(F070)	1979-1980	1.249"	7.890"	1	Nylon		8491N
9,000	(F090)	1979-1980	1.186/1.434"	8.750"	7	Metal		8462B
	(F090)	1970-1974	1.186/1.434"	8.750"	7	Metal		8462B
	(F090)	1979-1980	1.186/1.434"	8.750"	7	Nylon		8462N
	(F090)	1970-1974	1.186/1.434"	8.750"	7	Nylon		8462N
	(F120)	1975-1980	1.745"	9.380"	1	Metal		8613B
	(F120D)	1975-1980	1.745"	9.380"	1	Metal		8613B
12,000	(F120)	1970-1974	1.309/1.607"	9.750"	7	Metal		8386B
	(F120)	1975-1980	1.745"	9.380"	1	Metal		8613B
	(F120)	1970-1974	1.309/1.607"	9.750"	7	Nylon		8386N
	(F120D)	1975-1980	1.745"	9.380"	1	Metal		8613B
16,000	(FL901)	1971-1974	1.999"	11.040"	2	Metal		8518B
	(FL901)	1971-1974	1.999"	11.040"	2	Nylon		8518N

Tie Rod Ends

Axle Lbs. Rating	Code	Year	Length (Inches)	Notes	Tie Rod End Part No.	
					Drivers Side	Passenger Side
7,000	(F070)	1979-1980	4.93"		ES2061L	ES2062R
9,000	(F090)	1970-1974	3.75"	w/688568 Axle	ES176L	ES176R
	(F090)	1979-1980	4.88"		ES405L	ES405R

CHEVROLET TRUCK



W70, W7N (Cont'd)

Tie Rod Ends (Cont'd)

Axle Lbs. Rating	Code	Year	Length (Inches)	Notes	Tie Rod End Part No.	
					Drivers Side	Passenger Side
9,000	(F090)	1972-1974	4.88"	Exc. 688561, 688568; 2000765, 2000767, 2000768; 2002081, 2002083 Axles	ES405L	ES405R
	(F120D)	1979-1980	4.88"		ES405L	ES405R
12,000	(F120)	1979-1980	4.88"	Exc. 688561, 688568; 2000765, 2000767, 2000768; 2002081, 2002083 Axles	ES405L	ES405R
	(F120)	1973-1974	4.88"		ES405L	ES405R
	(F120)	1970-1970	4.88"		ES405L	ES405R
	(F120)	1971-1972	5.50"		Internal Threads	ES325L
16,000	(FL901)	1971-1974	5.75"		ES431L	ES431R

W70,W7N

Drag Links

Axle Lbs. Rating	Code	Year	Length (inches)	Notes	Drag Link No.
7,000	(F070)	1979-1980	32.22"		DS983

W80

King Bolt Sets

Axle Lbs. Rating	Code	Year	Diameter (inches)	Length (Inches)	Pin Type	Bushing	Notes	King Pin Set No.
7,000		1964-1965	1.249"	7.890"	1	Metal	From 1964 Second Design	8491B
		1964-1965	1.259"	7.890"	1	Metal	From 1964 Second Design	8491B010
		1964-1965	1.249"	7.890"	1	Nylon	From 1964 Second Design	8491N
9,000		1964-1965	1.186/1.434"	8.750"	7	Metal		8462B
		1964-1965	1.186/1.434"	8.750"	7	Nylon		8462N
	(F090)	1973-1978	1.186/1.434"	8.750"	7	Metal		8462B
	(F090)	1973-1978	1.186/1.434"	8.750"	7	Nylon		8462N
11,000		1964-1965	1.309/1.607"	9.750"	7	Metal		8386B
		1964-1965	1.309/1.607"	9.750"	7	Nylon		8386N
12,000	(F120)	1973-1978	1.309/1.607"	9.750"	7	Metal		8386B
	(F120)	1973-1978	1.309/1.607"	9.750"	7	Nylon		8386N

Tie Rod Ends

Axle Lbs. Rating	Code	Year	Length (Inches)	Notes	Tie Rod End Part No.	
					Drivers Side	Passenger Side
7,000		1964-1965	6.50"		ES332L	ES332R
9,000	(F090)	1964-1965	3.75"	Exc. 688561, 688568; 2000765, 2000767, 2000768; 2002081, 2002083 Axles	ES176L	ES176R
		1973-1978	4.88"		ES405L	ES405R
11,000		1964-1965	5.50"	Internal Threads	ES325L	ES325R
12,000	(F120)	1973-1978	4.88"	Exc. 688561, 688568; 2000765, 2000767, 2000768; 2002081, 2002083 Axles	ES405L	ES405R

W90

King Bolt Sets

Axle Lbs. Rating	Code	Year	Diameter (inches)	Length (Inches)	Pin Type	Bushing	Notes	King Pin Set No.
12,000	(F120)	1970-1978	1.309/1.607"	9.750"	7	Metal		8386B
	(F120)	1970-1978	1.309/1.607"	9.750"	7	Nylon		8386N

Tie Rod Ends

Axle Lbs. Rating	Code	Year	Length (Inches)	Notes	Tie Rod End Part No.	
					Drivers Side	Passenger Side
12,000	(F120)	1970-1978	4.88"		ES405L	ES405R

Y,M,O,P Series except Heavy Duty,COE& School Bus

King Bolt Sets

Axle Lbs. Rating	Code	Year	Diameter (inches)	Length (Inches)	Pin Type	Bushing	Notes	King Pin Set No.
		1941-1946	0.921"	5.125"	1	Metal		8207B

Heavy Duty Trucks

Y,M,O,P Series except Heavy Duty,COE& School Bus (Cont'd)

Tie Rod Ends

Axle Lbs. Rating	Code	Year	Length (Inches)	Notes	Tie Rod End Part No.	
					Drivers Side	Passenger Side
		1941-1946	3.55"		ES26L	ES26R

Y,M,O,P Series Heavy Duty

King Bolt Sets

Axle Lbs. Rating	Code	Year	Diameter (inches)	Length (Inches)	Pin Type	Bushing	Notes	King Pin Set No.
		1941-1946	1.109"	6.812"	1	Metal		8336B

Y,M, Series COE & Y,M,O Series School Bus

King Bolt Sets

Axle Lbs. Rating	Code	Year	Diameter (inches)	Length (Inches)	Pin Type	Bushing	Notes	King Pin Set No.
		1941-1946	1.109"	6.812"	1	Metal		8336B

CLARK AXLE TRUCK MODEL FINDING INDEX			
Model	Model	Model	Model
F-553			

F-553

King Bolt Sets

Axle Lbs. Rating	Code	Year	Diameter (inches)	Length (Inches)	Pin Type	Bushing	Notes	King Pin Set No.
7,000			1.234"	7.666"	5	Metal		8375B

Tie Rod Ends

Axle Lbs. Rating	Code	Year	Length (Inches)	Notes	Tie Rod End Part No.	
					Drivers Side	Passenger Side
			3.75"		ES235L	ES235R

DANA/SPICER AXLE TRUCK MODEL FINDING INDEX			
Model	Model	Model	Model
02ADA	02ADB	02ADC	02ADD
02ADE	02ADG	D2000F	D2200F
D600	D600N	D700	D700F
D700N	D800	D800F	D800N
D850	D850F	D850N	E1001I
E1002I	E1200I	E1202I	E1320I
E1322I	E1460I	E1460I/w axle model	E1462I
EFA110F4	EFA12F4	EFA13F5	I100S
I100SA	I100SG	I100W	I108
I120	I120S	I120SA	I120SG
I120W	I132	I132SG	I140S
I140SA	I140SG	I140W	I146SA
I160S	I160SG	I161	I180S
I180SG	I200S	I200SG	I50
I60	I60S	I75	I80
I80S	I90		

Front Axle Model Number Identification

The front non-drive steering axles are identified with a tag located between the spring pads, on the front side of the center beam section.

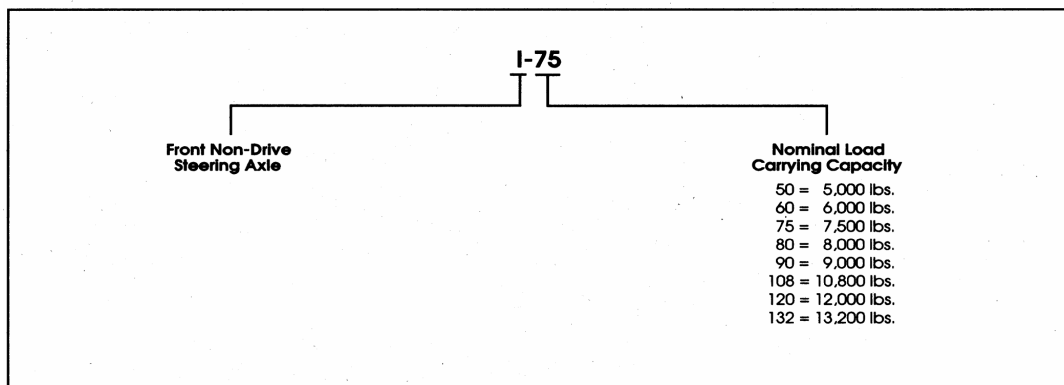
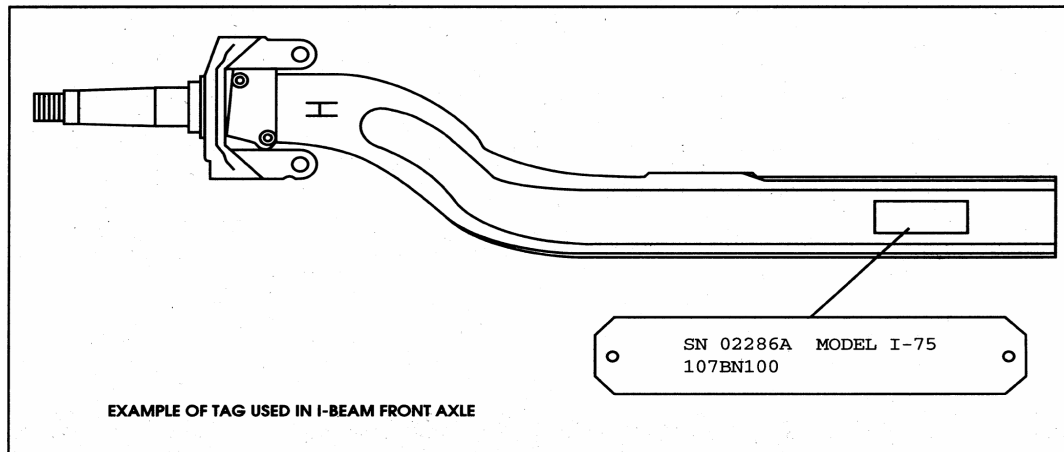

02ADA

King Bolt Sets

Axle Lbs. Rating	Code	Year	Diameter (inches)	Length (Inches)	Pin Type	Bushing	Notes	King Pin Set No.
6,000	(02ADA)		1.359"	7.970"	1	Composite		8577C
	(02ADA)		1.361"	7.970"	1	Composite		8577C002
	(02ADA)		1.360"	7.970"	2	Composite		8637C

DANA/SPICER AXLE



Heavy Duty Trucks

02ADA (Cont'd)

King Bolt Sets (Cont'd)

Axle Lbs. Rating	Code	Year	Diameter (inches)	Length (Inches)	Pin Type	Bushing	Notes	King Pin Set No.
6,000	(02ADA)		1.359"	7.970"	1	Metal		8577B
	(02ADA)		1.369"	7.970"	1	Metal		8577B010
	(02ADA)		1.360"	7.970"	2	Metal		8637B

Tie Rod Ends

Axle Lbs. Rating	Code	Year	Length (Inches)	Notes	Tie Rod End Part No.	
					Drivers Side	Passenger Side
6,000	(02ADA)		11.89"		ES3204L	ES3205R

02ADB

King Bolt Sets

Axle Lbs. Rating	Code	Year	Diameter (inches)	Length (Inches)	Pin Type	Bushing	Notes	King Pin Set No.
8,000	(02ADB)		1.359"	7.970"	1	Composite		8577C
	(02ADB)		1.361"	7.970"	1	Composite		8577C002
	(02ADB)		1.360"	7.970"	2	Composite		8637C
	(02ADB)		1.359"	7.970"	1	Metal		8577B
	(02ADB)		1.369"	7.970"	1	Metal		8577B010
	(02ADB)		1.360"	7.970"	2	Metal		8637B

Tie Rod Ends

Axle Lbs. Rating	Code	Year	Length (Inches)	Notes	Tie Rod End Part No.	
					Drivers Side	Passenger Side
8,000	(02ADB)		11.89"		ES3204L	ES3205R

02ADC

King Bolt Sets

Axle Lbs. Rating	Code	Year	Diameter (inches)	Length (Inches)	Pin Type	Bushing	Notes	King Pin Set No.
10,000	(02ADC)		2.046"	11.000"	2	Composite		80075C
	(02ADC)		1.921"	9.870"	2	Composite		8655C
	(02ADC)		2.046"	11.000"	2	Metal		80074B
	(02ADC)		1.921"	9.870"	2	Metal		8655B

Tie Rod Ends

Axle Lbs. Rating	Code	Year	Length (Inches)	Notes	Tie Rod End Part No.	
					Drivers Side	Passenger Side
10,000	(02ADC)		12.69"		ES3031L	ES3030R
	(02ADC)		5.44"		ES423L	ES423R
	(02ADC)		5.75"		ES431L	ES431R
	(02ADC)		9.18"		ES411L	ES411R

02ADD

King Bolt Sets

Axle Lbs. Rating	Code	Year	Diameter (inches)	Length (Inches)	Pin Type	Bushing	Notes	King Pin Set No.
12,000	(02ADD)		2.046"	11.000"	2	Composite		80075C
	(02ADD)		1.921"	9.870"	2	Composite		8655C
	(02ADD)		2.046"	11.000"	2	Metal		80074B
	(02ADD)		1.921"	9.870"	2	Metal		8655B

Tie Rod Ends

Axle Lbs. Rating	Code	Year	Length (Inches)	Notes	Tie Rod End Part No.	
					Drivers Side	Passenger Side
12,000	(02ADD)		12.69"		ES3031L	ES3030R
	(02ADD)		5.44"		ES423L	ES423R
	(02ADD)		5.75"		ES431L	ES431R
	(02ADD)		9.18"		ES411L	ES411R

02ADE

King Bolt Sets

Axle Lbs. Rating	Code	Year	Diameter (Inches)	Length (Inches)	Pin Type	Bushing	Notes	King Pin Set No.
13,200	(02ADE)		2.046"	10.120"	2	Composite Metal		80070C 8657B
	(02ADE)		2.046"	10.120"	2			

Tie Rod Ends

Axle Lbs. Rating	Code	Year	Length (Inches)	Notes	Tie Rod End Part No.	
					Drivers Side	Passenger Side
13,200	(02ADE)		12.69"		ES3031L	ES3030R
	(02ADE)		5.44"		ES423L	ES423R
	(02ADE)		5.75"		ES431L	ES431R
	(02ADE)		6.00"		ES3477	ES3476
	(02ADE)		9.18"		ES411L	ES411R

02ADG

King Bolt Sets

Axle Lbs. Rating	Code	Year	Diameter (Inches)	Length (Inches)	Pin Type	Bushing	Notes	King Pin Set No.
14,000	(02ADG)		2.046"	10.120"	2	Composite Metal		80070C 80074B 8657B
	(02ADG)		2.046"	11.000"	2			
	(02ADG)		2.046"	10.120"	2			

Tie Rod Ends

Axle Lbs. Rating	Code	Year	Length (Inches)	Notes	Tie Rod End Part No.	
					Drivers Side	Passenger Side
14,000	(02ADG)		12.69"		ES3031L	ES3030R
	(02ADG)		5.44"		ES423L	ES423R
	(02ADG)		5.75"		ES431L	ES431R
	(02ADG)		6.00"		ES3477	ES3476
	(02ADG)		9.18"		ES411L	ES411R

D2000F

Tie Rod Ends

Axle Lbs. Rating	Code	Year	Length (Inches)	Notes	Tie Rod End Part No.	
					Drivers Side	Passenger Side
20,000	(D2000F)		12.69"	w/5" Drop Assembly	ES3031L	ES3030R

D2200F

Tie Rod Ends

Axle Lbs. Rating	Code	Year	Length (Inches)	Notes	Tie Rod End Part No.	
					Drivers Side	Passenger Side
22,000	(D2200F)		12.69"		ES3031L	ES3030R

D600, 700, 800, 850;

E1001I,1002I,1200I,1202I,E1320I,1322I,1460I,1462I,EFA10F4,12F4,13F5

Tie Rod Ends

Axle Lbs. Rating	Code	Year	Length (Inches)	Notes	Tie Rod End Part No.	
					Drivers Side	Passenger Side
6,000	D600		9.26"		ES800423	ES800422
7,000	D700		9.26"		ES800423	ES800422
8,000	D800		9.26"		ES800423	ES800422
8,500	D850		9.26"		ES800423	ES800422
10,000	E1001I		9.26"		ES800423	ES800422
	E1002I		9.26"		ES800423	ES800422
	EFA10F4		9.26"		ES800423	ES800422
12,000	E1200I		9.26"		ES800423	ES800422
	E1202I		9.26"		ES800423	ES800422
	EFA12F4		9.26"		ES800423	ES800422
13,200	E1320I		9.26"		ES800423	ES800422
	E1322I		9.26"		ES800423	ES800422
	EFA13F5		9.26"		ES800423	ES800422
14,600	E1460I		9.26"		ES800423	ES800422

DANA/SPICER AXLE



D600, 700, 800, 850;

E1001I,1002I,1200I,1202I,E1320I,1322I,1460I,1462I,EFA10F4,12F4,13F5 (Cont'd)

Tie Rod Ends (Cont'd)

Axle Lbs. Rating	Code	Year	Length (Inches)	Notes	Tie Rod End Part No.	
					Drivers Side	Passenger Side
14,600	E1462I		9.26"		ES800423	ES800422

D600N

King Bolt Sets

Axle Lbs. Rating	Code	Year	Diameter (inches)	Length (Inches)	Pin Type	Bushing	Notes	King Pin Set No.
6,000	(D600N)		1.359"	8.07"	9	Composite		8001C

Tie Rod Ends

Axle Lbs. Rating	Code	Year	Length (Inches)	Notes	Tie Rod End Part No.	
					Drivers Side	Passenger Side
6,000	(D600N)		6.00"		ES3477	ES3476

D700F

King Bolt Sets

Axle Lbs. Rating	Code	Year	Diameter (inches)	Length (Inches)	Pin Type	Bushing	Notes	King Pin Set No.
7,000	(D700F)		1.359"	8.07"	9	Composite		8001C

Tie Rod Ends

Axle Lbs. Rating	Code	Year	Length (Inches)	Notes	Tie Rod End Part No.	
					Drivers Side	Passenger Side
7,000	(D700F)		6.00"		ES3477	ES3476

D700N

King Bolt Sets

Axle Lbs. Rating	Code	Year	Diameter (inches)	Length (Inches)	Pin Type	Bushing	Notes	King Pin Set No.
7,000	(D700N)		1.359"	8.07"	9	Composite		8001C

Tie Rod Ends

Axle Lbs. Rating	Code	Year	Length (Inches)	Notes	Tie Rod End Part No.	
					Drivers Side	Passenger Side
7,000	(D700N)		6.00"		ES3477	ES3476

D800F

King Bolt Sets

Axle Lbs. Rating	Code	Year	Diameter (inches)	Length (Inches)	Pin Type	Bushing	Notes	King Pin Set No.
8,000	(D800F)		1.359"	8.07"	9	Composite	From 9/18/02	8001C
	(D800F)		1.360"	7.970"	2	Composite	To 9/18/02	8637C
	(D800F)		1.360"	7.970"	2	Metal	To 9/18/02	8637B

Tie Rod Ends

Axle Lbs. Rating	Code	Year	Length (Inches)	Notes	Tie Rod End Part No.	
					Drivers Side	Passenger Side
8,000	(D800F)		6.00"		ES3477	ES3476

D800N

King Bolt Sets

Axle Lbs. Rating	Code	Year	Diameter (inches)	Length (Inches)	Pin Type	Bushing	Notes	King Pin Set No.
8,000	(D800N)		1.359"	8.07"	9	Composite	From 9/18/02	8001C
	(D800N)		1.360"	7.970"	2	Composite	To 9/18/02	8637C
	(D800N)		1.360"	7.970"	2	Metal	To 9/18/02	8637B

Tie Rod Ends

Axle Lbs. Rating	Code	Year	Length (Inches)	Notes	Tie Rod End Part No.	
					Drivers Side	Passenger Side

D800N (Cont'd)

Tie Rod Ends (Cont'd)

Axle Lbs. Rating	Code	Year	Length (Inches)	Notes	Tie Rod End Part No.	
					Drivers Side	Passenger Side
8,000	(D800N)		6.00"		ES3477	ES3476

D850F

King Bolt Sets

Axle Lbs. Rating	Code	Year	Diameter (inches)	Length (Inches)	Pin Type	Bushing	Notes	King Pin Set No.
8,500	(D850F)		1.359"	8.07"	9	Composite		8001C

Tie Rod Ends

Axle Lbs. Rating	Code	Year	Length (Inches)	Notes	Tie Rod End Part No.	
					Drivers Side	Passenger Side
8,500	(D850F)		9.26"		ES800423	ES800422

D850N

King Bolt Sets

Axle Lbs. Rating	Code	Year	Diameter (inches)	Length (Inches)	Pin Type	Bushing	Notes	King Pin Set No.
8,500	(D850N)		1.359"	8.07"	9	Composite		8001C

Tie Rod Ends

Axle Lbs. Rating	Code	Year	Length (Inches)	Notes	Tie Rod End Part No.	
					Drivers Side	Passenger Side
8,500	(D850N)		9.26"		ES800423	ES800422

E1460i/w axle model

Tie Rod Ends

Axle Lbs. Rating	Code	Year	Length (Inches)	Notes	Tie Rod End Part No.	
					Drivers Side	Passenger Side
14,600	(E1460I/W)		7.61"		ES800425	ES800424

I100S, I120S

King Bolt Sets

Axle Lbs. Rating	Code	Year	Diameter (inches)	Length (Inches)	Pin Type	Bushing	Notes	King Pin Set No.
10,000	I100S		1.921"	9.870"	2	Composite		8655C
	I100S		1.921"	9.870"	2	Metal		8655B
12,000	I120S		1.921"	9.870"	2	Composite		8655C
	I120S		1.921"	9.870"	2	Metal		8655B

Tie Rod Ends

Axle Lbs. Rating	Code	Year	Length (Inches)	Notes	Tie Rod End Part No.	
					Drivers Side	Passenger Side
10,000	I100S		5.44"		ES423L	ES423R
	I100S		9.18"		ES411L	ES411R
12,000	I120S		5.44"		ES423L	ES423R
	I120S		9.18"		ES411L	ES411R

I100SA

Tie Rod Ends

Axle Lbs. Rating	Code	Year	Length (Inches)	Notes	Tie Rod End Part No.	
					Drivers Side	Passenger Side
10,000	(I100SA)		12.69"	w/Dropped Tie Rod Assy.	ES3031L	ES3030R
	(I100SA)		5.44"		ES423L	ES423R
	(I100SA)		5.75"		ES431L	ES431R
	(I100SA)		9.18"		ES411L	ES411R

I100SG

King Bolt Sets

Axle Lbs. Rating	Code	Year	Diameter (inches)	Length (Inches)	Pin Type	Bushing	Notes	King Pin Set No.
10,000	(I100SG)		1.921"	9.870"	2	Composite		8655C
	(I100SG)		2.046"	11.000"	2	Metal		80074B
	(I100SG)		1.921"	9.870"	2	Metal		8655B

Tie Rod Ends

Axle Lbs. Rating	Code	Year	Length (Inches)	Notes	Tie Rod End Part No.	
					Drivers Side	Passenger Side
10,000	(I100SG)		12.69"		ES3031L	ES3030R
	(I100SG)		5.44"		ES423L	ES423R
	(I100SG)		5.75"		ES431L	ES431R
	(I100SG)		9.18"		ES411L	ES411R

I100W

King Bolt Sets

Axle Lbs. Rating	Code	Year	Diameter (inches)	Length (Inches)	Pin Type	Bushing	Notes	King Pin Set No.
10,000	(I100W)		2.046"	10.12"	9	Composite		8002C

Tie Rod Ends

Axle Lbs. Rating	Code	Year	Length (Inches)	Notes	Tie Rod End Part No.	
					Drivers Side	Passenger Side
10,000	(I100W)		7.37"		ES2090L	ES2091R

I108, I120, I132

King Bolt Sets

Axle Lbs. Rating	Code	Year	Diameter (inches)	Length (Inches)	Pin Type	Bushing	Notes	King Pin Set No.
10,800	I108		1.609"	9.160"	2	Composite	No Ream, Double Drawkey	8610C
	I108		1.609"	9.660"	2	Metal	Double Drawkey	8617B
	I108		1.609"	9.660"	1	Nylon	No Ream, Single Drawkey	8581N
	I108		1.611"	9.660"	1	Nylon	No Ream, Single Drawkey	8581N002
12,000	I120		1.609"	9.160"	2	Composite	No Ream, Double Drawkey	8610C
	I120		1.609"	9.660"	2	Metal	Double Drawkey	8617B
	I120		1.609"	9.660"	1	Nylon	No Ream, Single Drawkey	8581N
	I120		1.611"	9.660"	1	Nylon	No Ream, Single Drawkey	8581N002
13,200	I132		1.609"	9.160"	2	Composite	No Ream, Double Drawkey	8610C
	I132		1.609"	9.660"	2	Metal	Double Drawkey	8617B
	I132		1.609"	9.660"	1	Nylon	No Ream, Single Drawkey	8581N
	I132		1.611"	9.660"	1	Nylon	No Ream, Single Drawkey	8581N002

Tie Rod Ends

Axle Lbs. Rating	Code	Year	Length (Inches)	Notes	Tie Rod End Part No.	
					Drivers Side	Passenger Side
10,800	I108		5.44"	Drop-End Type	ES2613L	ES2614R
	I108		9.18"	For Straight I-Beam	ES411L	ES411R
12,000	I120		5.44"	Drop-End Type	ES2613L	ES2614R
	I120		9.18"	For Straight I-Beam	ES411L	ES411R
13,200	I132		5.44"	Drop-End Type	ES2613L	ES2614R
	I132		9.18"	For Straight I-Beam	ES411L	ES411R

I120SA

King Bolt Sets

Axle Lbs. Rating	Code	Year	Diameter (inches)	Length (Inches)	Pin Type	Bushing	Notes	King Pin Set No.
12,000	(I120SA)		1.859"	10.77"	9	Composite		8006C

Tie Rod Ends

Axle Lbs. Rating	Code	Year	Length (Inches)	Notes	Tie Rod End Part No.	
					Drivers Side	Passenger Side
12,000	(I120SA)		12.69"	w/Dropped Tie Rod Assy.	ES3031L	ES3030R
	(I120SA)		5.44"		ES423L	ES423R
	(I120SA)		5.75"		ES431L	ES431R

I120SG								
King Bolt Sets								
Axle Lbs. Rating	Code	Year	Diameter (inches)	Length (Inches)	Pin Type	Bushing	Notes	King Pin Set No.
12,000	(I120SG)		1.921"	9.870"	2	Composite		8655C
	(I120SG)		2.046"	11.000"	2	Metal		80074B
	(I120SG)		1.921"	9.870"	2	Metal		8655B
Tie Rod Ends								
Axle Lbs. Rating	Code	Year	Length (Inches)	Notes	Tie Rod End Part No.			
					Drivers Side	Passenger Side		
12,000	(I120SG)		12.69"					
	(I120SG)		5.44"					ES3031L ES3030R
	(I120SG)		5.75"					ES423L ES423R ES431L ES431R
I120W								
King Bolt Sets								
Axle Lbs. Rating	Code	Year	Diameter (inches)	Length (Inches)	Pin Type	Bushing	Notes	King Pin Set No.
12,000	(I120W)		2.046"	10.12"	9	Composite		8002C
Tie Rod Ends								
Axle Lbs. Rating	Code	Year	Length (Inches)	Notes	Tie Rod End Part No.			
					Drivers Side	Passenger Side		
12,000	(I120W)		7.37"					ES2090L ES2091R
I132SG								
King Bolt Sets								
Axle Lbs. Rating	Code	Year	Diameter (inches)	Length (Inches)	Pin Type	Bushing	Notes	King Pin Set No.
13,200	(I132SG)		2.046"	10.120"	2	Composite		80070C
	(I132SG)		2.046"	10.120"	2	Metal		8657B
Tie Rod Ends								
Axle Lbs. Rating	Code	Year	Length (Inches)	Notes	Tie Rod End Part No.			
					Drivers Side	Passenger Side		
13,200	(I132SG)		5.44"					ES423L ES423R
	(I132SG)		5.75"					ES431L ES431R
	(I132SG)		6.00"					ES3477 ES3476
	(I132SG)		9.18"					ES411L ES411R
I140S								
King Bolt Sets								
Axle Lbs. Rating	Code	Year	Diameter (inches)	Length (Inches)	Pin Type	Bushing	Notes	King Pin Set No.
14,000	I140S		2.046"	10.120"	2	Composite		80070C
	I140S		2.046"	10.120"	2	Metal		8657B
Tie Rod Ends								
Axle Lbs. Rating	Code	Year	Length (Inches)	Notes	Tie Rod End Part No.			
					Drivers Side	Passenger Side		
14,000	I140S		5.44"					ES3217L ES3218R
	I140S		9.43"					ES3219L ES3220R
I140SA, I146SA								
Tie Rod Ends								
Axle Lbs. Rating	Code	Year	Length (Inches)	Notes	Tie Rod End Part No.			
					Drivers Side	Passenger Side		
14,000	I140SA		5.44"					ES3217L ES3218R
	I140SA		9.43"					ES3219L ES3220R
	I146SA		5.44"					ES3217L ES3218R
	I146SA		9.43"					ES3219L ES3220R

I140SG

King Bolt Sets

Axle Lbs. Rating	Code	Year	Diameter (inches)	Length (Inches)	Pin Type	Bushing	Notes	King Pin Set No.
14,000	(I140SG)		2.046"	10.120"	2	Composite		80070C
	(I140SG)		2.046"	11.000"	2	Metal		80074B
	(I140SG)		2.046"	10.120"	2	Metal		8657B

Tie Rod Ends

Axle Lbs. Rating	Code	Year	Length (Inches)	Notes	Tie Rod End Part No.	
					Drivers Side	Passenger Side
14,000	(I140SG)		5.44"		ES423L	ES423R
	(I140SG)		5.75"		ES431L	ES431R
	(I140SG)		6.00"		ES3477	ES3476
	(I140SG)		9.18"		ES411L	ES411R

I140W

King Bolt Sets

Axle Lbs. Rating	Code	Year	Diameter (inches)	Length (Inches)	Pin Type	Bushing	Notes	King Pin Set No.
14,000	(I140W)		2.046"	10.12"	9	Composite		8002C

Tie Rod Ends

Axle Lbs. Rating	Code	Year	Length (Inches)	Notes	Tie Rod End Part No.	
					Drivers Side	Passenger Side
14,000	(I140W)		7.37"		ES2090L	ES2091R

I160S, I180S, I200S

King Bolt Sets

Axle Lbs. Rating	Code	Year	Diameter (inches)	Length (Inches)	Pin Type	Bushing	Notes	King Pin Set No.
16,000	I160S		2.046"	11.000"	2	Composite		80075C
	I160S		2.046"	11.000"	2	Composite		80075C
	I160S		2.046"	11.000"	2	Metal		80074B
18,000	I180S		2.046"	11.000"	2	Composite		80075C
	I180S		2.046"	11.000"	2	Composite		80075C
	I180S		2.046"	11.000"	2	Metal		80074B
20,000	I200S		2.046"	11.000"	2	Composite		80075C
	I200S		2.046"	11.000"	2	Metal		80074B

Tie Rod Ends

Axle Lbs. Rating	Code	Year	Length (Inches)	Notes	Tie Rod End Part No.	
					Drivers Side	Passenger Side
16,000	I160S		12.69"		ES3031L	ES3030R
			5.75"		ES431L	ES431R
18,000	I180S		12.69"		ES3031L	ES3030R
			5.75"		ES431L	ES431R
20,000	I200S		12.69"		ES3031L	ES3030R
			5.75"		ES431L	ES431R

I160SG

Tie Rod Ends

Axle Lbs. Rating	Code	Year	Length (Inches)	Notes	Tie Rod End Part No.	
					Drivers Side	Passenger Side
16,000	(I160SG)		5.75"		ES431L	ES431R

I160W

King Bolt Sets

Axle Lbs. Rating	Code	Year	Diameter (inches)	Length (Inches)	Pin Type	Bushing	Notes	King Pin Set No.
16,000	(I160W)		2.046"	11.00"	9	Composite		8003C

I161									
Tie Rod Ends									
Axle Lbs. Rating	Code	Year	Length (Inches)	Notes	Tie Rod End Part No.				
					Drivers Side	Passenger Side			
16,000	(I161)		5.75"	Neoplan Bus	ES431L ES431R				

I180SG									
Tie Rod Ends									
Axle Lbs. Rating	Code	Year	Length (Inches)	Notes	Tie Rod End Part No.				
					Drivers Side	Passenger Side			
18,000	(I180SG)		5.75"		ES431L ES431R				

I200SG									
Tie Rod Ends									
Axle Lbs. Rating	Code	Year	Length (Inches)	Notes	Tie Rod End Part No.				
					Drivers Side	Passenger Side			
20,000	(I200SG)		5.75"		ES431L ES431R				

I50									
King Bolt Sets									
Axle Lbs. Rating	Code	Year	Diameter (inches)	Length (Inches)	Pin Type	Bushing	Notes	King Pin Set No.	
5,000	I50		1.359"	7.970"	1	Composite	No Ream, Single Drawkey	8577C	
	I50		1.361"	7.970"	1	Composite	No Ream, Single Drawkey	8577C002	
	I50		1.360"	7.970"	2	Composite	No Ream, Double Drawkey	8637C	
	I50		1.359"	7.970"	1	Metal	Single Drawkey	8577B	
	I50		1.360"	7.970"	2	Metal	Double Drawkey	8637B	

Tie Rod Ends									
Axle Lbs. Rating	Code	Year	Length (Inches)	Notes	Tie Rod End Part No.				
					Drivers Side	Passenger Side			
5,000	I50		4.45"		ES373L ES373R				

I60									
King Bolt Sets									
Axle Lbs. Rating	Code	Year	Diameter (inches)	Length (Inches)	Pin Type	Bushing	Notes	King Pin Set No.	
6,000	I60		1.359"	7.970"	1	Composite	No Ream, Single Drawkey	8577C	
	I60		1.361"	7.970"	1	Composite	No Ream, Single Drawkey	8577C002	
	I60		1.360"	7.970"	2	Composite	No Ream, Double Drawkey	8637C	
	I60		1.359"	7.970"	1	Metal	Single Drawkey	8577B	
	I60		1.360"	7.970"	2	Metal	Double Drawkey	8637B	

Tie Rod Ends									
Axle Lbs. Rating	Code	Year	Length (Inches)	Notes	Tie Rod End Part No.				
					Drivers Side	Passenger Side			
6,000	I60		4.45"		ES373L ES373R				

I60S									
King Bolt Sets									
Axle Lbs. Rating	Code	Year	Diameter (inches)	Length (Inches)	Pin Type	Bushing	Notes	King Pin Set No.	
6,000	I60S		1.359"	7.970"	1	Composite	No Ream, Single Drawkey	8577C	
	I60S		1.361"	7.970"	1	Composite	No Ream, Single Drawkey	8577C002	
	I60S		1.360"	7.970"	2	Composite	No Ream, Double Drawkey	8637C	
	I60S		1.360"	7.970"	2	Metal	Double Drawkey	8637B	

Tie Rod Ends									
Axle Lbs. Rating	Code	Year	Length (Inches)	Notes	Tie Rod End Part No.				
					Drivers Side	Passenger Side			
6,000	I60S		11.89"		ES3205R ES3204L				

175

King Bolt Sets								
Axle Lbs. Rating	Code	Year	Diameter (inches)	Length (Inches)	Pin Type	Bushing	Notes	King Pin Set No.
7,500	I75		1.359"	7.970"	1	Composite	No Ream, Single Drawkey	8577C
	I75		1.361"	7.970"	1	Composite	No Ream, Single Drawkey	8577C002
	I75		1.360"	7.970"	2	Composite	No Ream, Double Drawkey	8637C
	I75		1.359"	7.970"	1	Metal	Single Drawkey	8577B
	I75		1.360"	7.970"	2	Metal	Double Drawkey	8637B

Tie Rod Ends					Tie Rod End Part No.	
Axle Lbs. Rating	Code	Year	Length (Inches)	Notes	Drivers Side	Passenger Side
7,500	I75		4.45"		ES373L	ES373R

180

King Bolt Sets								
Axle Lbs. Rating	Code	Year	Diameter (inches)	Length (Inches)	Pin Type	Bushing	Notes	King Pin Set No.
8,000	I80		1.359"	7.970"	1	Composite	No Ream, Single Drawkey	8577C
	I80		1.361"	7.970"	1	Composite	No Ream, Single Drawkey	8577C002
	I80		1.360"	7.970"	2	Composite	No Ream, Double Drawkey	8637C
	I80		1.359"	7.970"	1	Metal	Single Drawkey	8577B
	I80		1.360"	7.970"	2	Metal	Double Drawkey	8637B

Tie Rod Ends					Tie Rod End Part No.	
Axle Lbs. Rating	Code	Year	Length (Inches)	Notes	Drivers Side	Passenger Side
8,000	I80		4.45"		ES373L	ES373R

180S

King Bolt Sets								
Axle Lbs. Rating	Code	Year	Diameter (inches)	Length (Inches)	Pin Type	Bushing	Notes	King Pin Set No.
8,000	I80S		1.359"	7.970"	1	Composite	No Ream, Single Drawkey	8577C
	I80S		1.361"	7.970"	1	Composite	No Ream, Single Drawkey	8577C002
	I80S		1.360"	7.970"	2	Composite	No Ream, Double Drawkey	8637C
	I80S		1.360"	7.970"	2	Metal	Double Drawkey	8637B

Tie Rod Ends					Tie Rod End Part No.	
Axle Lbs. Rating	Code	Year	Length (Inches)	Notes	Drivers Side	Passenger Side
8,000	I80S		11.89"		ES3205R	ES3204L

190

King Bolt Sets								
Axle Lbs. Rating	Code	Year	Diameter (inches)	Length (Inches)	Pin Type	Bushing	Notes	King Pin Set No.
9,000	I90		1.609"	9.160"	2	Composite	No Ream, Double Drawkey	8610C
	I90		1.609"	9.160"	2	Metal	Double Drawkey Before 8/81	8610B
	I90		1.609"	9.160"	1	Nylon	Single Drawkey	8583N
	I90		1.611"	9.160"	1	Nylon	No Ream, Single Drawkey	8583N002

Tie Rod Ends					Tie Rod End Part No.	
Axle Lbs. Rating	Code	Year	Length (Inches)	Notes	Drivers Side	Passenger Side
9,000	I90		5.44"	For Dropped I-Beam	ES2613L	ES2614R
	I90		9.18"	For Straight I-Beam	ES411L	ES411R

DIAMOND T TRUCK MODEL FINDING INDEX			
Model	Model	Model	Model
27460	27465 W/TIMPKEN AXLE	720C	730C
830C	901	910	910N
910R	911N	920	950
951	952		

720C, 730C, 830C, 901, 910, 910N, 910R, 911N, 920, 952;27460,27465 W/TIMPKEN AXLE

Tie Rod Ends

Axle Lbs. Rating	Code	Year	Length (Inches)	Notes	Tie Rod End Part No.	
					Drivers Side	Passenger Side
		1948-1955	4.88"	for Curved rods		ES187R
		1948-1955	4.88"	External Threads for straight rods	ES187L	ES187R

950, 951

King Bolt Sets

Axle Lbs. Rating	Code	Year	Diameter (inches)	Length (Inches)	Pin Type	Bushing	Notes	King Pin Set No.
	FG900	1958-1959	1.400/1.794"	10.688"	7	Metal		8474B

DIVCO TRUCK MODEL FINDING INDEX			
Model	Model	Model	Model
100A	100AX	100B	100BX
100C	100CX	10A	10B
10C	11	114	12
124	13	134	15
154	200A	200B	200C
214	224	300A	300B
300C	300D	300E	334
344	364374	UMB8	UML11
UML12	UML13	UML14	UML15, 21, 22, 31, 33, 34, 36, 37
UML21	UML22	UML31	UML33
UML34	UML36	UML37	UML8

10A, B, C, 11, 12, 13, 15, 100A, B, C, AX, BX, CX, 114, 124, 134, 154, 200A, B, C, 214, 224, 300A, B, C, D, E, 334, 344, 364374

King Bolt Sets

Axle Lbs. Rating	Code	Year	Diameter (inches)	Length (Inches)	Pin Type	Bushing	Notes	King Pin Set No.
		1961-1962	1.109"	6.812"	1	Metal		8336B

UMB8, UML8, 11, 12, 13, 14, 15, 21, 22, 31, 33, 34, 36, 37

King Bolt Sets

Axle Lbs. Rating	Code	Year	Diameter (inches)	Length (Inches)	Pin Type	Bushing	Notes	King Pin Set No.
		1950-1954	1.109"	6.812"	1	Metal		8336B

Tie Rod Ends

Axle Lbs. Rating	Code	Year	Length (Inches)	Notes	Tie Rod End Part No.	
					Drivers Side	Passenger Side
		1950-1954	4.44"		ES2083L	ES2082R

DODGE TRUCK MODEL FINDING INDEX			
Model	Model	Model	Model
ALL (Except W500 4 WD)	ALL (Except W500 4WD)	C1000	C500
C600	C700	C800	C850
C900	CN800	CN900	CNT800
CNT900	CT700	CT800	CT900
D1000	D400	D500	D600
D700	D800	DC700	DL400
DN1000	DNT1000	F	FL
FN	FNL	FS	G
GA	H	HM	J
JM	K	KM	L600
L700	LN1000	LNT1000	LS1000
LT1000	LV1000	LVT1000	M400
M500	M600	NC1000	NC900
NCT1000	NCT900	NL1000	NLT1000
P400	PC500	PC600	PD500
PD600	PL400	R	R400
R500	RA	RAL	RL
RS	S500	S600	S700
T	TA	TAL	TL
V	VA	VAL	VL
VL1000	VLT1000	Y	YA
YAL			

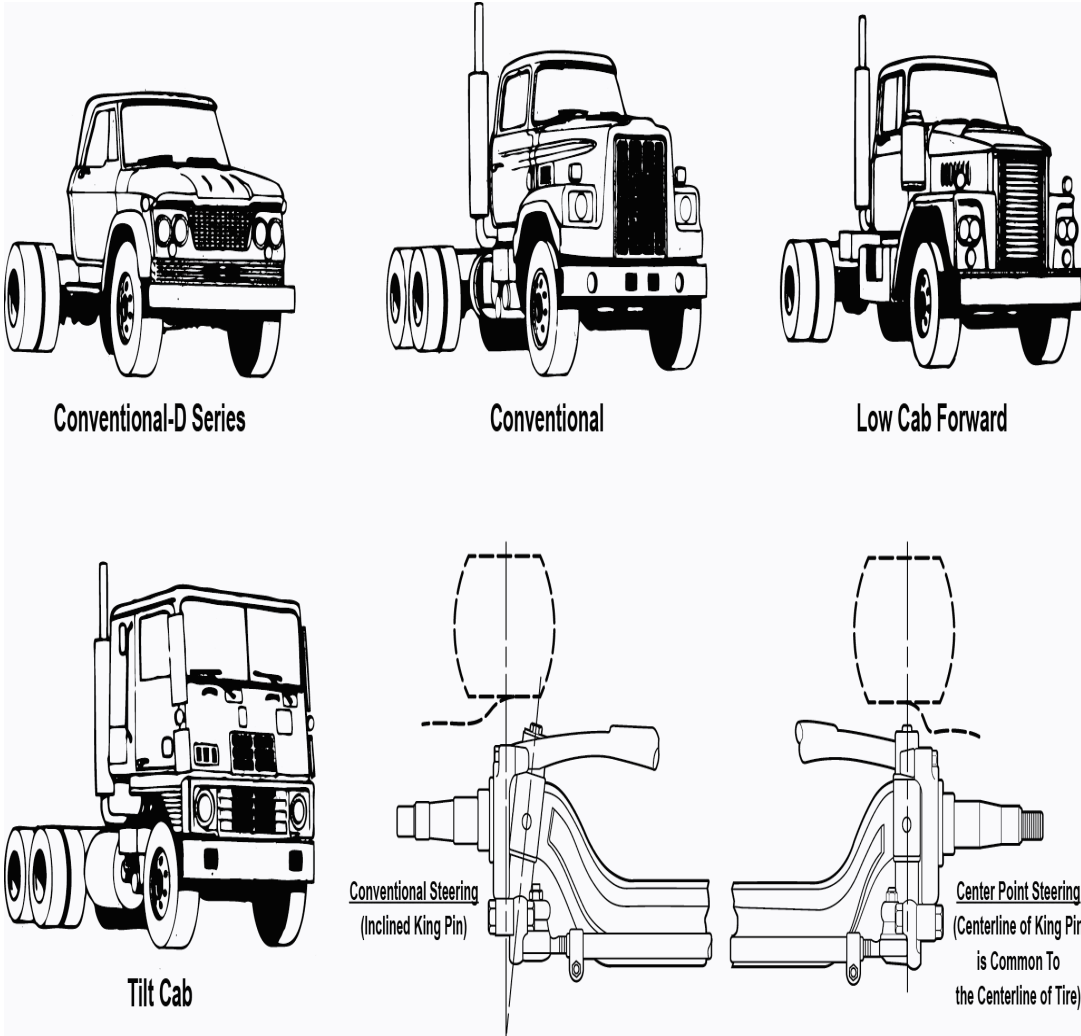

ALL (Except W500 4 WD)

ALL (Except W500 4 WD)

Tie Rod Ends

Axle Lbs. Rating	Code	Year	Length (Inches)	Notes	Tie Rod End Part No.	
					Drivers Side	Passenger Side
4,000		1957-1959	3.41"		ES158L	ES158R
4,700		1957-1959	3.75"		ES194L	ES194R
5,000		1957-1959	3.75"		ES194L	ES194R
6,000		1957-1959	3.75"		ES194L	ES194R
7,000		1957-1959	3.90"		ES304L	ES304R
9,000		1957-1959	4.88"		ES187L	ES187R

ALL (Except W500 4WD)

King Bolt Sets

Axle Lbs. Rating	Code	Year	Diameter (inches)	Length (Inches)	Pin Type	Bushing	Notes	King Pin Set No.
4,000		1957-1959	0.937"	6.469"	1	Metal		8454B
		1957-1959	0.937"	6.469"	1	Nylon		8454N
4,700		1957-1959	1.124"	7.190"	2	Metal		8456B
5,000		1957-1959	1.124"	7.190"	2	Metal		8456B
7,000		1957-1959	1.234"	7.440"	2	Metal		8479B
		1957-1959	1.234"	7.440"	2	Nylon		8479N
9,000		1957-1959	1.434"	8.500"	2	Metal		8519B
		1957-1959	1.434"	8.500"	2	Nylon		8519N

C1000

King Bolt Sets

Axle Lbs. Rating	Code	Year	Diameter (inches)	Length (Inches)	Pin Type	Bushing	Notes	King Pin Set No.
7,000		1960-1976	1.234"	7.440"	2	Metal		8479B
		1960-1976	1.244"	7.440"	2	Metal		8507B010
		1960-1976	1.234"	7.440"	2	Nylon		8479N
9,000		1960-1976	1.434"	8.500"	2	Metal		8519B
		1960-1976	1.444"	8.500"	2	Metal		8519B010
		1960-1976	1.434"	8.500"	2	Nylon		8519N
12,000		1960-1973	1.794"	9.120"	2	Metal		8489B
		1960-1973	1.794"	9.120"	2	Nylon		8489N
15,000		1960-1973	1.400/1.794"	10.688"	7	Metal		8474B

Tie Rod Ends

Axle Lbs. Rating	Code	Year	Length (Inches)	Notes	Tie Rod End Part No.	
					Drivers Side	Passenger Side
7,000		1960-1976	3.90"		ES304L	ES304R
9,000		1960-1976	4.88"		ES187L	ES187R
12,000		1960-1973	4.88"		ES187L	ES187R
15,000		1960-1973	4.88"		ES187L	ES187R

C500

King Bolt Sets

Axle Lbs. Rating	Code	Year	Diameter (inches)	Length (Inches)	Pin Type	Bushing	Notes	King Pin Set No.
5,000		1957-1971	1.124"	7.190"	2	Metal		8456B
		1972-1973	1.234"	6.960"	1	Metal		8560B
		1972-1973	1.234"	6.960"	1	Nylon		8560N
7,000		1957-1973	1.234"	7.440"	2	Metal		8479B
		1957-1973	1.234"	7.440"	2	Metal		8479B
		1957-1973	1.244"	7.440"	2	Metal		8507B010
		1957-1973	1.234"	7.440"	2	Nylon		8479N
		1957-1973	1.234"	7.440"	2	Nylon		8479N

Tie Rod Ends

Axle Lbs. Rating	Code	Year	Length (Inches)	Notes	Tie Rod End Part No.	
					Drivers Side	Passenger Side
5,000		1957-1973	4.44"		ES2083L	ES2082R
7,000		1957-1973	3.90"		ES304L	ES304R

C600

King Bolt Sets

Axle Lbs. Rating	Code	Year	Diameter (inches)	Length (Inches)	Pin Type	Bushing	Notes	King Pin Set No.
5,000		1961-1971	1.124"	7.190"	2	Metal		8456B
		1972-1973	1.234"	6.960"	1	Metal		8560B
		1972-1973	1.234"	6.960"	1	Nylon		8560N
7,000		1969-1973	1.234"	7.440"	2	Metal		8479B
		1969-1973	1.234"	7.440"	2	Metal		8479B
		1969-1973	1.244"	7.440"	2	Metal		8507B010
		1969-1973	1.234"	7.440"	2	Nylon		8479N
		1969-1973	1.234"	7.440"	2	Nylon		8479N

Tie Rod Ends

Axle Lbs. Rating	Code	Year	Length (Inches)	Notes	Tie Rod End Part No.	
					Drivers Side	Passenger Side
5,000		1961-1973	4.44"		ES2083L	ES2082R
7,000		1969-1973	3.90"		ES304L	ES304R

C700

King Bolt Sets

Axle Lbs. Rating	Code	Year	Diameter (inches)	Length (Inches)	Pin Type	Bushing	Notes	King Pin Set No.
7,000		1961-1969	1.234"	7.440"	2	Metal		8479B
		1961-1969	1.234"	7.440"	2	Metal		8479B
		1961-1969	1.244"	7.440"	2	Metal		8507B010
		1961-1969	1.234"	7.440"	2	Nylon		8479N
		1961-1969	1.234"	7.440"	2	Nylon		8479N
9,000		1961-1969	1.434"	8.500"	2	Metal		8519B
		1961-1969	1.444"	8.500"	2	Metal		8519B010
		1961-1969	1.434"	8.500"	2	Nylon		8519N
12,000		1963-1969	1.794"	9.120"	2	Metal		8489B
		1963-1969	1.794"	9.120"	2	Nylon		8489N

Tie Rod Ends

Axle Lbs. Rating	Code	Year	Length (Inches)	Notes	Tie Rod End Part No.	
					Drivers Side	Passenger Side
7,000		1961-1969	3.90"		ES304L	ES304R
9,000		1961-1969	4.88"		ES187L	ES187R
11,000		1963-1968	4.88"		ES187L	ES187R
12,000		1963-1969	4.88"		ES187L	ES187R

C800

King Bolt Sets

Axle Lbs. Rating	Code	Year	Diameter (inches)	Length (Inches)	Pin Type	Bushing	Notes	King Pin Set No.
7,000		1960-1977	1.234"	7.440"	2	Metal		8479B
		1960-1977	1.234"	7.440"	2	Metal		8479B
		1960-1977	1.244"	7.440"	2	Metal		8507B010
		1960-1977	1.234"	7.440"	2	Nylon		8479N
		1960-1977	1.234"	7.440"	2	Nylon		8479N
9,000		1960-1977	1.434"	8.500"	2	Metal		8519B
		1960-1977	1.444"	8.500"	2	Metal		8519B010
		1960-1977	1.434"	8.500"	2	Nylon		8519N
12,000		1969-1977	1.794"	9.120"	2	Metal		8489B
		1969-1977	1.794"	9.120"	2	Nylon		8489N
15,000		1960-1971	1.234"	7.440"	2	Metal		8479B
		1960-1971	1.234"	7.440"	2	Nylon		8479N
16,000		1974-1977	1.999"	11.040"	2	Metal		8518B
		1974-1977	1.999"	11.040"	2	Nylon		8518N

Tie Rod Ends

Axle Lbs. Rating	Code	Year	Length (Inches)	Notes	Tie Rod End Part No.	
					Drivers Side	Passenger Side
7,000		1960-1977	3.90"		ES304L	ES304R
9,000		1960-1977	4.88"		ES187L	ES187R
12,000		1960-1973	4.88"	To Serial No. 3T001936 (1973)	ES187L	ES187R
		1974-1977	5.44"	After Serial No. 3T001936 (1973)	ES423L	ES423R

C800 (Cont'd)

Tie Rod Ends (Cont'd)

Axle Lbs. Rating	Code	Year	Length (Inches)	Notes	Tie Rod End Part No.	
					Drivers Side	Passenger Side
16,000		1972-1977	5.75"	After Serial No. 3T001936 (1973)		ES2040R

C850

King Bolt Sets

Axle Lbs. Rating	Code	Year	Diameter (inches)	Length (Inches)	Pin Type	Bushing	Notes	King Pin Set No.
7,000		1960-1976	1.234"	7.440"	2	Metal		8479B
		1960-1976	1.244"	7.440"	2	Metal		8507B010
		1960-1976	1.234"	7.440"	2	Nylon		8479N
9,000		1960-1976	1.434"	8.500"	2	Metal		8519B
		1960-1976	1.444"	8.500"	2	Metal		8519B010
		1960-1976	1.434"	8.500"	2	Nylon		8519N
12,000		1960-1973	1.794"	9.120"	2	Metal		8489B
		1960-1973	1.794"	9.120"	2	Nylon		8489N
15,000		1960-1973	1.400/1.794"	10.688"	7	Metal		8474B

Tie Rod Ends

Axle Lbs. Rating	Code	Year	Length (Inches)	Notes	Tie Rod End Part No.	
					Drivers Side	Passenger Side
7,000		1960-1976	3.90"		ES304L	ES304R
9,000		1960-1976	4.88"		ES187L	ES187R
12,000		1960-1973	4.88"	To Serial No. 3T001936 (1973)	ES187L	ES187R
15,000		1960-1973	4.88"		ES187L	ES187R

C900

King Bolt Sets

Axle Lbs. Rating	Code	Year	Diameter (inches)	Length (Inches)	Pin Type	Bushing	Notes	King Pin Set No.
7,000		1961-1968	1.234"	7.440"	2	Metal		8479B
		1961-1968	1.244"	7.440"	2	Metal		8507B010
		1961-1968	1.234"	7.440"	2	Nylon		8479N
9,000		1961-1977	1.434"	8.500"	2	Metal		8519B
		1961-1977	1.444"	8.500"	2	Metal		8519B010
		1961-1977	1.434"	8.500"	2	Nylon		8519N
12,000		1961-1977	1.794"	9.120"	2	Metal		8489B
		1961-1977	1.794"	9.120"	2	Nylon		8489N
15,000		1961-1977	1.400/1.794"	10.688"	7	Metal		8474B

Tie Rod Ends

Axle Lbs. Rating	Code	Year	Length (Inches)	Notes	Tie Rod End Part No.	
					Drivers Side	Passenger Side
7,000		1961-1968	3.90"		ES304L	ES304R
9,000		1961-1977	4.88"		ES187L	ES187R
12,000		1972-1973	4.88"	Gas Engine (To Serial No. 3T001936)	ES187L	ES187R
		1972-1973	4.88"	Diesel Engine (To Serial No. 3T002246)	ES187L	ES187R
		1961-1971	4.88"		ES187L	ES187R
		1974-1977	5.44"		ES423L	ES423R
		1972-1973	5.44"	Gas Engine (From Serial No. 3T001936)	ES423L	ES423R
		1972-1973	5.44"	Diesel Engine (From Serial No. 3T002246)	ES423L	ES423R
15,000		1961-1971	4.88"		ES187L	ES187R
16,000		1974-1977	5.75"			ES2040R

CN800, CNT800

King Bolt Sets

Axle Lbs. Rating	Code	Year	Diameter (inches)	Length (Inches)	Pin Type	Bushing	Notes	King Pin Set No.
9,000		1974-1975	1.434"	8.500"	2	Metal		8519B
		1974-1975	1.444"	8.500"	2	Metal		8519B010
		1974-1975	1.434"	8.500"	2	Nylon		8519N
12,000		1974-1975	1.794"	9.120"	2	Metal		8489B
		1974-1975	1.794"	9.120"	2	Nylon		8489N
16,000		1974-1975	1.999"	11.040"	2	Metal		8518B
		1974-1975	1.999"	11.040"	2	Nylon		8518N

CN800, CNT800 (Cont'd)

Tie Rod Ends

Axle Lbs. Rating	Code	Year	Length (Inches)	Notes	Tie Rod End Part No.	
					Drivers Side	Passenger Side
9,000		1974-1975	4.88"		ES187L	ES187R
12,000		1974-1975	5.44"	After Serial No. 3T001936 To Serial No. 3T001936	ES423L	ES423R
		1974-1975	5.75"		ES431L	ES431R

CN900

King Bolt Sets

Axle Lbs. Rating	Code	Year	Diameter (inches)	Length (Inches)	Pin Type	Bushing	Notes	King Pin Set No.
9,000		1969-1976	1.434"	8.500"	2	Metal		8519B
		1969-1976	1.444"	8.500"	2	Metal		8519B010
		1969-1976	1.434"	8.500"	2	Nylon		8519N
12,000		1969-1975	1.794"	9.120"	2	Metal		8489B
		1969-1975	1.794"	9.120"	2	Nylon		8489N
15,000		1969-1973	1.400/1.794"	10.688"	7	Metal		8474B
16,000		1972-1975	1.999"	11.040"	2	Metal		8518B
		1972-1975	1.999"	11.040"	2	Nylon		8518N

Tie Rod Ends

Axle Lbs. Rating	Code	Year	Length (Inches)	Notes	Tie Rod End Part No.	
					Drivers Side	Passenger Side
9,000		1969-1976	4.88"		ES187L	ES187R
12,000		1969-1975	4.88"		ES187L	ES187R
15,000		1969-1973	4.88"		ES187L	ES187R
16,000		1972-1975	5.75"		ES431L	ES431R

CNT900

King Bolt Sets

Axle Lbs. Rating	Code	Year	Diameter (inches)	Length (Inches)	Pin Type	Bushing	Notes	King Pin Set No.
9,000		1969-1975	1.434"	8.500"	2	Metal		8519B
		1969-1975	1.444"	8.500"	2	Metal		8519B010
		1969-1975	1.434"	8.500"	2	Nylon		8519N
12,000		1969-1975	1.794"	9.120"	2	Metal		8489B
		1969-1975	1.794"	9.120"	2	Nylon		8489N
15,000		1969-1973	1.400/1.794"	10.688"	7	Metal		8474B
16,000		1972-1975	1.999"	11.040"	2	Metal		8518B
		1972-1975	1.999"	11.040"	2	Nylon		8518N

Tie Rod Ends

Axle Lbs. Rating	Code	Year	Length (Inches)	Notes	Tie Rod End Part No.	
					Drivers Side	Passenger Side
9,000		1969-1976	4.88"		ES187L	ES187R
12,000		1969-1975	4.88"		ES187L	ES187R
15,000		1969-1973	4.88"		ES187L	ES187R
16,000		1972-1975	5.75"		ES431L	ES431R

CT700

King Bolt Sets

Axle Lbs. Rating	Code	Year	Diameter (inches)	Length (Inches)	Pin Type	Bushing	Notes	King Pin Set No.
7,000		1960-1971	1.234"	7.440"	2	Metal		8479B
		1960-1971	1.234"	7.440"	2	Metal		8479B
		1960-1971	1.244"	7.440"	2	Metal		8507B010
		1960-1971	1.234"	7.440"	2	Nylon		8479N
		1960-1971	1.234"	7.440"	2	Nylon		8479N
9,000		1960-1971	1.434"	8.500"	2	Metal		8519B
		1960-1971	1.444"	8.500"	2	Metal		8519B010
		1960-1971	1.434"	8.500"	2	Nylon		8519N
12,000		1960-1971	1.794"	9.120"	2	Metal		8489B
		1960-1971	1.794"	9.120"	2	Nylon		8489N

CT700 (Cont'd)

Tie Rod Ends

Axle Lbs. Rating	Code	Year	Length (Inches)	Notes	Tie Rod End Part No.	
					Drivers Side	Passenger Side
7,000		1960-1971	3.90"		ES304L	ES304R
9,000		1960-1971	4.88"		ES187L	ES187R
11,000		1969-1970	4.88"		ES187L	ES187R
12,000		1960-1969	4.88"		ES187L	ES187R

CT800

King Bolt Sets

Axle Lbs. Rating	Code	Year	Diameter (inches)	Length (Inches)	Pin Type	Bushing	Notes	King Pin Set No.
7,000		1960-1976	1.234"	7.440"	2	Metal		8479B
		1960-1970	1.234"	7.440"	2	Metal		8479B
		1960-1976	1.244"	7.440"	2	Metal		8507B010
		1960-1970	1.234"	7.640"	1	Metal		8562B
		1960-1976	1.234"	7.440"	2	Nylon		8479N
9,000		1960-1976	1.434"	8.500"	2	Metal		8519B
		1960-1976	1.444"	8.500"	2	Metal		8519B010
		1960-1976	1.434"	8.500"	2	Nylon		8519N
12,000		1960-1975	1.794"	9.120"	2	Metal		8489B
		1960-1975	1.794"	9.120"	2	Nylon		8489N
15,000		1960-1973	1.400/1.794"	10.688"	7	Metal		8474B
16,000		1972-1973	1.999"	11.040"	2	Metal		8518B
		1972-1973	1.999"	11.040"	2	Nylon		8518N

Tie Rod Ends

Axle Lbs. Rating	Code	Year	Length (Inches)	Notes	Tie Rod End Part No.	
					Drivers Side	Passenger Side
7,000		1960-1976	3.90"		ES304L	ES304R
9,000		1960-1976	4.88"		ES187L	ES187R
12,000		1960-1973	4.88"	To Serial No. 3T001936	ES187L	ES187R
		1974-1975	5.44"	After Serial No. 3T001936	ES423L	ES423R
15,000		1960-1973	4.88"		ES187L	ES187R
16,000		1974-1975	5.75"		ES376L	ES376R

CT900

King Bolt Sets

Axle Lbs. Rating	Code	Year	Diameter (inches)	Length (Inches)	Pin Type	Bushing	Notes	King Pin Set No.
9,000		1969-1976	1.434"	8.500"	2	Metal		8519B
		1969-1976	1.444"	8.500"	2	Metal		8519B010
		1969-1976	1.434"	8.500"	2	Nylon		8519N
12,000		1969-1975	1.794"	9.120"	2	Metal		8489B
		1969-1975	1.794"	9.120"	2	Nylon		8489N
15,000		1969-1973	1.400/1.794"	10.688"	7	Metal		8474B
16,000		1972-1975	1.999"	11.040"	2	Metal		8518B
		1972-1975	1.999"	11.040"	2	Nylon		8518N

Tie Rod Ends

Axle Lbs. Rating	Code	Year	Length (Inches)	Notes	Tie Rod End Part No.	
					Drivers Side	Passenger Side
9,000		1969-1976	4.88"		ES187L	ES187R
12,000		1969-1975	4.88"		ES187L	ES187R
15,000		1969-1973	4.88"		ES187L	ES187R
16,000		1972-1975	5.75"		ES376L	ES376R

D1000

King Bolt Sets

Axle Lbs. Rating	Code	Year	Diameter (inches)	Length (Inches)	Pin Type	Bushing	Notes	King Pin Set No.
9,000		1972-1977	1.434"	8.500"	2	Metal		8519B
		1972-1977	1.444"	8.500"	2	Metal		8519B010
		1972-1977	1.434"	8.500"	2	Nylon		8519N
12,000		1972-1977	1.794"	9.120"	2	Metal		8489B
		1972-1977	1.794"	9.120"	2	Nylon		8489N
16,000		1972-1977	1.999"	11.040"	2	Metal		8518B

D1000 (Cont'd)

King Bolt Sets (Cont'd)

Axle Lbs. Rating	Code	Year	Diameter (inches)	Length (Inches)	Pin Type	Bushing	Notes	King Pin Set No.
16,000		1972-1977	1.999"	11.040"	2	Nylon		8518N

Tie Rod Ends

Axle Lbs. Rating	Code	Year	Length (Inches)	Notes	Tie Rod End Part No.	
					Drivers Side	Passenger Side
9,000		1972-1977	4.88"		ES187L	ES187R
12,000		1972-1977	4.88"		ES187L	ES187R
16,000		1972-1977	5.75"		ES431L	ES431R

D400

King Bolt Sets

Axle Lbs. Rating	Code	Year	Diameter (inches)	Length (Inches)	Pin Type	Bushing	Notes	King Pin Set No.
4,000		1960-1971	0.937"	6.469"	1	Metal		8454B
		1960-1971	0.937"	6.469"	1	Nylon		8454N
5,000		1960-1971	1.124"	7.190"	2	Metal		8456B
		1972-1977	1.234"	6.960"	1	Nylon		8560N

Tie Rod Ends

Axle Lbs. Rating	Code	Year	Length (Inches)	Notes	Tie Rod End Part No.	
					Drivers Side	Passenger Side
4,000		1960-1971	3.41"		ES158L	ES158R
5,000		1960-1971	4.44"		ES2083L	ES2082R

D500

King Bolt Sets

Axle Lbs. Rating	Code	Year	Diameter (inches)	Length (Inches)	Pin Type	Bushing	Notes	King Pin Set No.
4,000		1972-1973	0.937"	6.469"	1	Metal		8454B
		1972-1973	0.937"	6.469"	1	Nylon		8454N
5,000		1961-1971	1.124"	7.190"	2	Metal		8456B
		1972-1977	1.234"	6.960"	1	Nylon		8560N
7,000		1961-1973	1.234"	7.440"	2	Metal		8479B
		1961-1973	1.234"	7.440"	2	Metal		8479B
		1961-1973	1.244"	7.440"	2	Metal		8507B010
		1961-1973	1.234"	7.440"	2	Nylon		8479N
		1961-1973	1.234"	7.440"	2	Nylon		8479N

Tie Rod Ends

Axle Lbs. Rating	Code	Year	Length (Inches)	Notes	Tie Rod End Part No.	
					Drivers Side	Passenger Side
4,000		1972-1973	3.41"		ES158L	ES158R
5,000		1961-1977	4.44"		ES2083L	ES2082R
7,000		1961-1973	3.90"		ES304L	ES304R

Drag Links

Axle Lbs. Rating	Code	Year	Length (inches)	Notes	Drag Link No.
5,000		1974-1977	25.82"		DS867
5,500		1974-1977	25.82"		DS867
7,000		1974-1977	26.05"	w/Power Steering	DS880

D600

King Bolt Sets

Axle Lbs. Rating	Code	Year	Diameter (inches)	Length (Inches)	Pin Type	Bushing	Notes	King Pin Set No.
5,000		1957-1971	1.124"	7.190"	2	Metal		8456B
		1972-1977	1.234"	6.960"	1	Metal		8560B
		1972-1977	1.234"	6.960"	1	Nylon		8560N
7,000		1957-1973	1.234"	7.440"	2	Metal		8479B
		1957-1973	1.234"	7.440"	2	Metal		8479B
		1957-1973	1.244"	7.440"	2	Metal		8507B010
		1974-1977	1.234"	7.640"	1	Metal		8562B
		1957-1973	1.234"	7.440"	2	Nylon		8479N

DODGE TRUCK



D600 (Cont'd)

King Bolt Sets (Cont'd)

Axle Lbs. Rating	Code	Year	Diameter (inches)	Length (Inches)	Pin Type	Bushing	Notes	King Pin Set No.
7,000		1957-1973	1.234"	7.440"	2	Nylon		8479N
		1974-1977	1.234"	7.640"	1	Nylon		8562N

Tie Rod Ends

Axle Lbs. Rating	Code	Year	Length (Inches)	Notes	Tie Rod End Part No.	
					Drivers Side	Passenger Side
5,000		1957-1977	4.44"		ES2083L	ES2082R
7,000		1957-1973	3.90"		ES304L	ES304R

Drag Links

Axle Lbs. Rating	Code	Year	Length (inches)	Notes	Drag Link No.
5,000		1974-1977	25.82"		DS867
5,500		1974-1977	25.82"		DS867
7,000		1974-1977	26.05"	w/Power Steering	DS880

D700

King Bolt Sets

Axle Lbs. Rating	Code	Year	Diameter (inches)	Length (Inches)	Pin Type	Bushing	Notes	King Pin Set No.
5,000		1961-1971	1.124"	7.190"	2	Metal	Double Key Way	8456B
		1975-1977	1.234"	6.960"	1	Metal		8560B
		1975-1977	1.234"	6.960"	1	Nylon		8560N
5,500		1975-1977	1.234"	6.960"	1	Metal		8560B
		1975-1977	1.234"	6.960"	1	Nylon		8560N
7,000		1961-1971	1.234"	7.440"	2	Metal	Double Key Way	8479B
		1961-1971	1.244"	7.440"	2	Metal		8507B010
		1975-1977	1.234"	7.640"	1	Metal	8562B	
		1961-1971	1.234"	7.440"	2	Nylon	Double Key Way	8479N
		1975-1977	1.234"	7.640"	1	Nylon		8562N
9,000		1960-1971	1.234"	7.440"	2	Metal		8479B
		1960-1971	1.234"	7.440"	2	Metal		8479B
		1963-1971	1.434"	8.500"	2	Metal		8519B
		1963-1971	1.444"	8.500"	2	Metal		8519B010
		1963-1971	1.434"	8.500"	2	Nylon		8519N

Tie Rod Ends

Axle Lbs. Rating	Code	Year	Length (Inches)	Notes	Tie Rod End Part No.	
					Drivers Side	Passenger Side
5,000		1961-1977	4.44"		ES2083L	ES2082R
5,500		1975-1977	4.44"		ES2083L	ES2082R
7,000		1961-1977	3.90"		ES304L	ES304R
9,000		1963-1971	3.75"		ES176L	ES176R
		1963-1971	4.88"		ES187L	ES187R

Drag Links

Axle Lbs. Rating	Code	Year	Length (inches)	Notes	Drag Link No.
5,000		1974-1977	25.82"		DS867
5,500		1974-1977	25.82"		DS867
7,000		1974-1977	26.05"		DS880

D800

King Bolt Sets

Axle Lbs. Rating	Code	Year	Diameter (inches)	Length (Inches)	Pin Type	Bushing	Notes	King Pin Set No.
7,000		1963-1977	1.234"	7.440"	2	Metal		8479B
		1963-1977	1.244"	7.440"	2	Metal		8507B010
		1963-1977	1.234"	7.440"	2	Nylon		8479N
9,000		1963-1975	1.434"	8.500"	2	Metal	w/o Anti-Skid Axle	8519B
		1963-1975	1.444"	8.500"	2	Metal		8519B010
		1963-1975	1.434"	8.500"	2	Nylon		8519N
11,000		1963-1968	1.309/1.607"	9.750"	7	Metal		8386B
		1963-1968	1.309/1.607"	9.750"	7	Nylon		8386N

D800 (Cont'd)

Tie Rod Ends

Axle Lbs. Rating	Code	Year	Length (Inches)	Notes	Tie Rod End Part No.	
					Drivers Side	Passenger Side
7,000		1963-1977	3.90"		ES304L	ES304R
9,000		1963-1977	4.88"		ES187L	ES187R
11,000		1963-1968	4.88"		ES187L	ES187R

Drag Links

Axle Lbs. Rating	Code	Year	Length (inches)	Notes	Drag Link No.
7,000		1974-1977	26.05"	w/Power Steering	DS880

DC700

King Bolt Sets

Axle Lbs. Rating	Code	Year	Diameter (inches)	Length (Inches)	Pin Type	Bushing	Notes	King Pin Set No.
5,000		1969-1971	1.124"	7.190"	2	Metal		8456B
7,000		1969-1971	1.234"	7.440"	2	Metal		8479B
		1969-1971	1.244"	7.440"	2	Metal		8507B010
		1969-1971	1.234"	7.440"	2	Nylon		8479N

Tie Rod Ends

Axle Lbs. Rating	Code	Year	Length (Inches)	Notes	Tie Rod End Part No.	
					Drivers Side	Passenger Side
5,000		1969-1971	4.44"		ES2083L	ES2082R
7,000		1961-1971	3.90"		ES304L	ES304R

DL400, P400, PL400

King Bolt Sets

Axle Lbs. Rating	Code	Year	Diameter (inches)	Length (Inches)	Pin Type	Bushing	Notes	King Pin Set No.
4,000		1957-1973	0.937"	6.469"	1	Metal		8454B
		1957-1973	0.937"	6.469"	1	Nylon		8454N
5,000		1961-1971	1.124"	7.190"	2	Metal	P400 Only DL400 & PL400 Only	8456B
		1957-1959	1.124"	7.190"	2	Metal		8456B
		1972-1973	1.234"	6.960"	1	Nylon		8560N

Tie Rod Ends

Axle Lbs. Rating	Code	Year	Length (Inches)	Notes	Tie Rod End Part No.	
					Drivers Side	Passenger Side
4,000		1957-1973	3.41"		ES158L	ES158R
5,000		1961-1973	4.44"	P400 Only	ES2083L	ES2082R
		1957-1959	4.44"	DL400 & PL400 Only	ES2083L	ES2082R

Drag Links

Axle Lbs. Rating	Code	Year	Length (inches)	Notes	Drag Link No.
5,000		1961-1973	25.82"	P400 Model Only	DS867

DN1000, DNT1000

King Bolt Sets

Axle Lbs. Rating	Code	Year	Diameter (inches)	Length (Inches)	Pin Type	Bushing	Notes	King Pin Set No.
12,000		1973-1975	1.794"	9.120"	2	Metal		8489B
		1973-1975	1.794"	9.120"	2	Nylon		8489N
16,000		1973-1975	1.999"	11.040"	2	Metal		8518B
		1973-1975	1.999"	11.040"	2	Nylon		8518N

Tie Rod Ends

Axle Lbs. Rating	Code	Year	Length (Inches)	Notes	Tie Rod End Part No.	
					Drivers Side	Passenger Side
12,000		1973-1975	4.88"		ES187L	ES187R
16,000		1973-1975	5.75"		ES376L	ES376R

F,FL,FN,FNL,FS,G,GA SERIES

King Bolt Sets

Axle Lbs. Rating	Code	Year	Diameter (inches)	Length (Inches)	Pin Type	Bushing	Notes	King Pin Set No.
4,500		1954-1956	1.124"	7.190"	2	Metal		8456B
4,700		1954-1956	1.124"	7.190"	2	Metal		8456B
5,000		1954-1956	1.124"	7.190"	2	Metal		8456B

Tie Rod Ends

Axle Lbs. Rating	Code	Year	Length (Inches)	Notes	Tie Rod End Part No.	
					Drivers Side	Passenger Side
3,750		1954-1956	3.41"		ES158L	ES158R
4,000		1954-1956	3.41"		ES158L	ES158R
4,500		1954-1956	3.75"		ES194L	ES194R
4,700		1954-1956	3.75"		ES194L	ES194R
5,000		1954-1956	3.75"		ES194L	ES194R

H,HM,J,JM,K,KM SERIES

King Bolt Sets

Axle Lbs. Rating	Code	Year	Diameter (inches)	Length (Inches)	Pin Type	Bushing	Notes	King Pin Set No.
4,500		1954-1956	1.124"	7.190"	2	Metal		8456B
4,700		1954-1956	1.124"	7.190"	2	Metal		8456B
5,000		1954-1956	1.124"	7.190"	2	Metal		8456B

Tie Rod Ends

Axle Lbs. Rating	Code	Year	Length (Inches)	Notes	Tie Rod End Part No.	
					Drivers Side	Passenger Side
4,500		1954-1956	3.75"		ES194L	ES194R
4,700		1954-1956	3.75"		ES194L	ES194R
5,000		1954-1956	3.75"		ES194L	ES194R

L600

King Bolt Sets

Axle Lbs. Rating	Code	Year	Diameter (inches)	Length (Inches)	Pin Type	Bushing	Notes	King Pin Set No.
5,000		1963-1971	1.124"	7.190"	2	Metal		8456B
7,000		1963-1971	1.234"	7.440"	2	Metal		8479B
		1963-1971	1.234"	7.440"	2	Metal		8479B
		1963-1971	1.244"	7.440"	2	Metal		8507B010
		1963-1971	1.234"	7.440"	2	Nylon		8479N
		1963-1971	1.234"	7.440"	2	Nylon		8479N

Tie Rod Ends

Axle Lbs. Rating	Code	Year	Length (Inches)	Notes	Tie Rod End Part No.	
					Drivers Side	Passenger Side
5,000		1967-1971	4.44"		ES2083L	ES2082R
7,000		1967-1971	3.90"		ES304L	ES304R

L700

King Bolt Sets

Axle Lbs. Rating	Code	Year	Diameter (inches)	Length (Inches)	Pin Type	Bushing	Notes	King Pin Set No.
7,000		1963-1971	1.234"	7.440"	2	Metal		8479B
		1963-1970	1.234"	7.440"	2	Metal		8479B
		1963-1971	1.244"	7.440"	2	Metal		8507B010
		1963-1971	1.234"	7.440"	2	Nylon		8479N
		1963-1970	1.234"	7.440"	2	Nylon		8479N
9,000		1966-1971	1.434"	8.500"	2	Metal		8519B
		1966-1971	1.444"	8.500"	2	Metal		8519B010
		1966-1971	1.434"	8.500"	2	Nylon		8519N
11,000		1963-1968	1.309/1.607"	9.750"	7	Metal		8386B
		1963-1968	1.309/1.607"	9.750"	7	Nylon		8386N
12,000		1969-1971	1.794"	9.120"	2	Metal		8489B
		1969-1971	1.794"	9.120"	2	Nylon		8489N

L700 (Cont'd)

Tie Rod Ends

Axle Lbs. Rating	Code	Year	Length (Inches)	Notes	Tie Rod End Part No.	
					Drivers Side	Passenger Side
7,000		1966-1971	3.90"		ES304L	ES304R
9,000		1969-1971	4.88"		ES187L	ES187R
11,000		1963-1968	4.88"		ES187L	ES187R
12,000		1966-1971	4.88"		ES187L	ES187R

LN1000

King Bolt Sets

Axle Lbs. Rating	Code	Year	Diameter (inches)	Length (Inches)	Pin Type	Bushing	Notes	King Pin Set No.
9,000		1963-1973	1.434"	8.500"	2	Metal		8519B
		1963-1973	1.444"	8.500"	2	Metal		8519B010
		1963-1973	1.434"	8.500"	2	Nylon		8519N
11,000		1963-1968	1.309/1.607"	9.750"	7	Metal		8386B
		1963-1968	1.309/1.607"	9.750"	7	Nylon		8386N
12,000		1969-1973	1.794"	9.120"	2	Metal		8489B
		1969-1973	1.794"	9.120"	2	Nylon		8489N
15,000		1963-1973	1.400/1.794"	10.688"	7	Metal		8474B

Tie Rod Ends

Axle Lbs. Rating	Code	Year	Length (Inches)	Notes	Tie Rod End Part No.	
					Drivers Side	Passenger Side
9,000		1963-1971	4.88"		ES187L	ES187R
11,000		1963-1968	4.88"		ES187L	ES187R
12,000		1969-1971	4.88"		ES187L	ES187R
15,000		1963-1973	4.88"		ES187L	ES187R

LNT1000, LV1000, LVT1000

King Bolt Sets

Axle Lbs. Rating	Code	Year	Diameter (inches)	Length (Inches)	Pin Type	Bushing	Notes	King Pin Set No.
9,000		1963-1973	1.434"	8.500"	2	Metal		8519B
		1963-1973	1.444"	8.500"	2	Metal		8519B010
		1963-1973	1.434"	8.500"	2	Nylon		8519N
11,000		1963-1968	1.309/1.607"	9.750"	7	Metal		8386B
		1963-1968	1.309/1.607"	9.750"	7	Nylon		8386N
12,000		1969-1973	1.794"	9.120"	2	Metal		8489B
		1969-1973	1.794"	9.120"	2	Nylon		8489N
15,000		1963-1973	1.400/1.794"	10.688"	7	Metal		8474B

Tie Rod Ends

Axle Lbs. Rating	Code	Year	Length (Inches)	Notes	Tie Rod End Part No.	
					Drivers Side	Passenger Side
9,000		1963-1971	4.88"		ES187L	ES187R
11,000		1963-1968	4.88"		ES187L	ES187R
12,000		1969-1971	4.88"		ES187L	ES187R
15,000		1963-1973	4.88"		ES187L	ES187R

LS1000, LT1000

King Bolt Sets

Axle Lbs. Rating	Code	Year	Diameter (inches)	Length (Inches)	Pin Type	Bushing	Notes	King Pin Set No.
9,000		1972-1975	1.434"	8.500"	2	Metal		8519B
		1972-1975	1.444"	8.500"	2	Metal		8519B010
		1972-1975	1.434"	8.500"	2	Nylon		8519N
12,000		1972-1975	1.794"	9.120"	2	Metal		8489B
		1972-1975	1.794"	9.120"	2	Nylon		8489N
16,000		1972-1975	1.999"	11.040"	2	Metal		8518B
		1972-1975	1.999"	11.040"	2	Nylon		8518N

Tie Rod Ends

Axle Lbs. Rating	Code	Year	Length (Inches)	Notes	Tie Rod End Part No.	
					Drivers Side	Passenger Side
9,000		1972-1975	4.88"		ES187L	ES187R

DODGE TRUCK



LS1000, LT1000 (Cont'd)

Tie Rod Ends (Cont'd)

Axle Lbs. Rating	Code	Year	Length (Inches)	Notes	Tie Rod End Part No.	
					Drivers Side	Passenger Side
12,000		1972-1975	4.88"		ES187L	ES187R
16,000		1972-1975	5.75"		ES376L	ES376R

M400, R400

King Bolt Sets

Axle Lbs. Rating	Code	Year	Diameter (inches)	Length (Inches)	Pin Type	Bushing	Notes	King Pin Set No.
5,000		1974-1978	1.124"	7.190"	1	Metal		8587B
		1974-1978	1.124"	7.190"	2	Metal		8587N
		1979-1981	1.234"	6.960"	1	Nylon		8560N
		1972-1973	1.234"	6.960"	1	Nylon		8560N
		1969-1972	0.937"	6.469"	1	Metal		8454B
		1973-1973	1.124"	7.190"	2	Metal		8456B
		1979-1981	1.234"	6.960"	1	Metal		8560B
		1969-1972	0.937"	6.469"	1	Nylon		8454N

Tie Rod Ends

Axle Lbs. Rating	Code	Year	Length (Inches)	Notes	Tie Rod End Part No.	
					Drivers Side	Passenger Side
		1979-1981	4.44"		ES2083L	ES2082R

Drag Links

Axle Lbs. Rating	Code	Year	Length (inches)	Notes	Drag Link No.
		1974-1978	23.78"	w/4500 lbs. Axle	DS881
		1979-1981	24.80"		DS930

M500, R500

King Bolt Sets

Axle Lbs. Rating	Code	Year	Diameter (inches)	Length (Inches)	Pin Type	Bushing	Notes	King Pin Set No.
		1974-1978	1.124"	7.190"	1	Metal		8587B
		1974-1978	1.124"	7.190"	2	Metal		8587N
		1979-1981	1.234"	6.960"	1	Nylon		8560N
		1972-1973	1.234"	6.960"	1	Nylon		8560N

Tie Rod Ends

Axle Lbs. Rating	Code	Year	Length (Inches)	Notes	Tie Rod End Part No.	
					Drivers Side	Passenger Side
		1972-1981	4.44"		ES2083L	ES2082R

Drag Links

Axle Lbs. Rating	Code	Year	Length (inches)	Notes	Drag Link No.
		1972-1973	23.78"	w/4500 lbs. Axle	DS881
		1974-1978			DS930
		1979-1981	24.80"		

M600

King Bolt Sets

Axle Lbs. Rating	Code	Year	Diameter (inches)	Length (Inches)	Pin Type	Bushing	Notes	King Pin Set No.
5,000		1976-1981	1.234"	6.960"	1	Nylon		8560N
		1976-1981	1.234"	6.960"	1	Metal		8560B

Tie Rod Ends

Axle Lbs. Rating	Code	Year	Length (Inches)	Notes	Tie Rod End Part No.	
					Drivers Side	Passenger Side
		1976-1977	3.75"		ES194L	ES194R
		1978-1981	4.44"		ES2083L	ES2082R

NC1000, NCT1000, NL1000, NLT1000, VL1000, VLT1000

King Bolt Sets								
Axle Lbs. Rating	Code	Year	Diameter (inches)	Length (Inches)	Pin Type	Bushing	Notes	King Pin Set No.
9,000		1963-1968	1.434"	8.500"	2	Metal		8519B
		1963-1968	1.444"	8.500"	2	Metal		8519B010
		1963-1968	1.434"	8.500"	2	Nylon		8519N
11,000		1963-1968	1.309/1.607"	9.750"	7	Metal		8386B
		1963-1968	1.309/1.607"	9.750"	7	Nylon		8386N
15,000		1963-1968	1.400/1.794"	10.688"	7	Metal		8474B

Tie Rod Ends						
Axle Lbs. Rating	Code	Year	Length (Inches)	Notes	Tie Rod End Part No.	
					Drivers Side	Passenger Side
9,000		1963-1968	4.88"		ES187L	ES187R
11,000		1963-1968	4.88"		ES187L	ES187R
15,000		1963-1968	4.88"		ES187L	ES187R

NC900, NCT900

King Bolt Sets								
Axle Lbs. Rating	Code	Year	Diameter (inches)	Length (Inches)	Pin Type	Bushing	Notes	King Pin Set No.
9,000		1960-1968	1.434"	8.500"	2	Metal		8519B
		1960-1968	1.444"	8.500"	2	Metal		8519B010
		1960-1968	1.434"	8.500"	2	Nylon		8519N
11,000		1963-1968	1.309/1.607"	9.750"	7	Metal		8386B
		1963-1968	1.309/1.607"	9.750"	7	Nylon		8386N
15,000		1960-1968	1.400/1.794"	10.688"	7	Metal		8474B

Tie Rod Ends						
Axle Lbs. Rating	Code	Year	Length (Inches)	Notes	Tie Rod End Part No.	
					Drivers Side	Passenger Side
9,000		1960-1968	4.88"		ES187L	ES187R
11,000		1963-1968	4.88"		ES187L	ES187R
15,000		1960-1968	4.88"		ES187L	ES187R

PC500, PD500, PC600, PD600

King Bolt Sets								
Axle Lbs. Rating	Code	Year	Diameter (inches)	Length (Inches)	Pin Type	Bushing	Notes	King Pin Set No.
5,000		1961-1968	1.124"	7.190"	2	Metal		8456B
7,000		1961-1969	1.234"	7.440"	2	Metal		8479B
		1961-1969	1.234"	7.440"	2	Nylon		8479N

Tie Rod Ends						
Axle Lbs. Rating	Code	Year	Length (Inches)	Notes	Tie Rod End Part No.	
					Drivers Side	Passenger Side
5,000		1961-1968	4.44"		ES2083L	ES2082R
7,000		1961-1969	3.90"		ES304L	ES304R

R, RA, RAL, RL, RS Series

King Bolt Sets								
Axle Lbs. Rating	Code	Year	Diameter (inches)	Length (Inches)	Pin Type	Bushing	Notes	King Pin Set No.
4,500		1954-1956	1.124"	7.190"	2	Metal		8456B
4,700		1954-1956	1.124"	7.190"	2	Metal		8456B
5,000		1954-1956	1.124"	7.190"	2	Metal		8456B

Tie Rod Ends						
Axle Lbs. Rating	Code	Year	Length (Inches)	Notes	Tie Rod End Part No.	
					Drivers Side	Passenger Side
4,500		1954-1956	3.75"		ES194L	ES194R
4,700		1954-1956	3.75"		ES194L	ES194R
5,000		1954-1956	3.75"		ES194L	ES194R
5,500		1954-1956	3.75"	7/8" Thread	ES194L	ES194R

R,RA,RAL,RL,RS Series (Cont'd)

Tie Rod Ends (Cont'd)

Axle Lbs. Rating	Code	Year	Length (Inches)	Notes	Tie Rod End Part No.	
					Drivers Side	Passenger Side
5,500		1954-1956	3.75"	1" Thread	ES176L	ES176R
6,000		1954-1956	3.75"	7/8" Thread	ES194L	ES194R
		1954-1956	3.75"	1" Thread	ES176L	ES176R

S500

King Bolt Sets

Axle Lbs. Rating	Code	Year	Diameter (inches)	Length (Inches)	Pin Type	Bushing	Notes	King Pin Set No.
5,000		1957-1971	1.124"	7.190"	2	Metal		8456B
		1972-1973	1.234"	6.960"	1	Metal		8560B
		1972-1973	1.234"	6.960"	1	Nylon		8560N
7,000		1957-1973	1.234"	7.440"	2	Metal		8479B
		1957-1973	1.234"	7.440"	2	Metal		8479B
		1957-1973	1.244"	7.440"	2	Metal		8507B010
		1957-1973	1.234"	7.440"	2	Nylon		8479N
		1957-1973	1.234"	7.440"	2	Nylon		8479N

Tie Rod Ends

Axle Lbs. Rating	Code	Year	Length (Inches)	Notes	Tie Rod End Part No.	
					Drivers Side	Passenger Side
5,000		1957-1973	4.44"		ES2083L	ES2082R
7,000		1957-1973	3.90"		ES304L	ES304R

S600

King Bolt Sets

Axle Lbs. Rating	Code	Year	Diameter (inches)	Length (Inches)	Pin Type	Bushing	Notes	King Pin Set No.
5,000		1961-1971	1.124"	7.190"	2	Metal		8456B
		1972-1977	1.234"	6.960"	1	Metal		8560B
		1972-1977	1.234"	6.960"	1	Nylon		8560N
5,500		1974-1977	1.234"	6.960"	1	Metal		8560B
		1974-1977	1.234"	6.960"	1	Nylon		8560N
7,000		1961-1973	1.234"	7.440"	2	Metal		8479B
		1961-1973	1.234"	7.440"	2	Metal		8479B
		1961-1973	1.244"	7.440"	2	Metal		8507B010
		1974-1977	1.234"	7.640"	1	Metal		8562B
		1961-1973	1.234"	7.440"	2	Nylon		8479N
		1961-1973	1.234"	7.440"	2	Nylon		8479N
		1974-1977	1.234"	7.640"	1	Nylon		8562N

Tie Rod Ends

Axle Lbs. Rating	Code	Year	Length (Inches)	Notes	Tie Rod End Part No.	
					Drivers Side	Passenger Side
5,000		1961-1977	4.44"		ES2083L	ES2082R
5,500		1974-1977	4.44"		ES2083L	ES2082R
7,000		1974-1977	3.75"		ES176L	ES176R
		1961-1973	3.90"		ES304L	ES304R

Drag Links

Axle Lbs. Rating	Code	Year	Length (inches)	Notes	Drag Link No.
5,500		1974-1974	25.82"	w/Manual Steering	DS867
7,000		1974-1977	26.05"	w/Power Steering	DS880

S700

King Bolt Sets

Axle Lbs. Rating	Code	Year	Diameter (inches)	Length (Inches)	Pin Type	Bushing	Notes	King Pin Set No.
5,000		1974-1977	1.234"	6.960"	1	Metal		8560B
		1974-1977	1.234"	6.960"	1	Nylon		8560N
5,500		1974-1977	1.234"	6.960"	1	Metal		8560B
		1974-1977	1.234"	6.960"	1	Nylon		8560N
7,000		1974-1977	1.234"	7.640"	1	Metal		8562B
		1974-1977	1.234"	7.640"	1	Nylon		8562N

S700 (Cont'd)

Tie Rod Ends

Axle Lbs. Rating	Code	Year	Length (Inches)	Notes	Tie Rod End Part No.	
					Drivers Side	Passenger Side
5,000		1974-1977	4.44"		ES2083L	ES2082R
5,500		1974-1977	4.44"		ES2083L	ES2082R
7,000		1974-1977	3.75"		ES176L	ES176R

Drag Links

Axle Lbs. Rating	Code	Year	Length (inches)	Notes	Drag Link No.
7,000		1974-1977	26.05"	w/Power Steering	DS880

T, TA, TAL, TL, V, VA, VAL, VL, Y, YA, YAL, YL SERIES

King Bolt Sets

Axle Lbs. Rating	Code	Year	Diameter (inches)	Length (Inches)	Pin Type	Bushing	Notes	King Pin Set No.
9,000		1954-1956	1.434"	8.500"	2	Metal		8519B
		1954-1956	1.434"	8.500"	2	Nylon		8519N

Tie Rod Ends

Axle Lbs. Rating	Code	Year	Length (Inches)	Notes	Tie Rod End Part No.	
					Drivers Side	Passenger Side
5,500		1954-1956	3.75"	7/8" Thread	ES194L	ES194R
		1954-1956	3.75"	1" Thread	ES176L	ES176R
6,000		1954-1956	3.75"	7/8" Thread	ES194L	ES194R
		1954-1956	3.75"	1" Thread	ES176L	ES176R
8,000		1954-1956	4.88"		ES187L	ES187R
9,000		1954-1956	4.88"		ES187L	ES187R

EATON TRUCK MODEL FINDING INDEX			
Model	Model	Model	Model
E-1000I	E1000W	E-1200I	E1200W
E1201W	E1202I	E1202W	E1203I
E1320I	E-1320I	E1320W	E1322I
E1322W	E-1460I	E1460W	EFA-12F3
EFA-12F4	EFA-13F3	EFA-13F5	EFA-18F3
EFA-20F4	EFA-22T2	EFA-22T5	EFA-24T2
EFA-24T5			

Front Axle Model Number Identification

Location and Identification of Eaton Axle Specifications

Model Numbers describe the axle specifications.

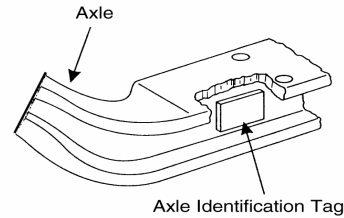

Example of Tag Used in I-Beam Front Axle

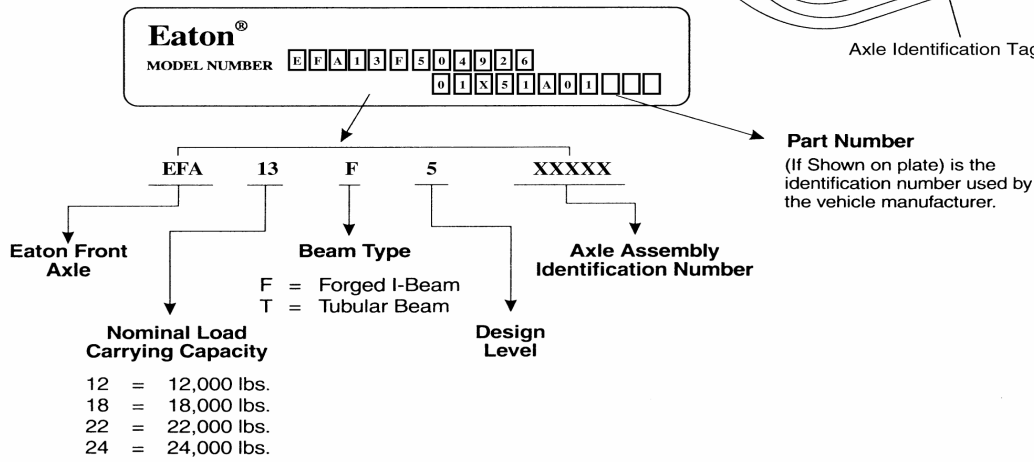

Integral Arm Steer Axle

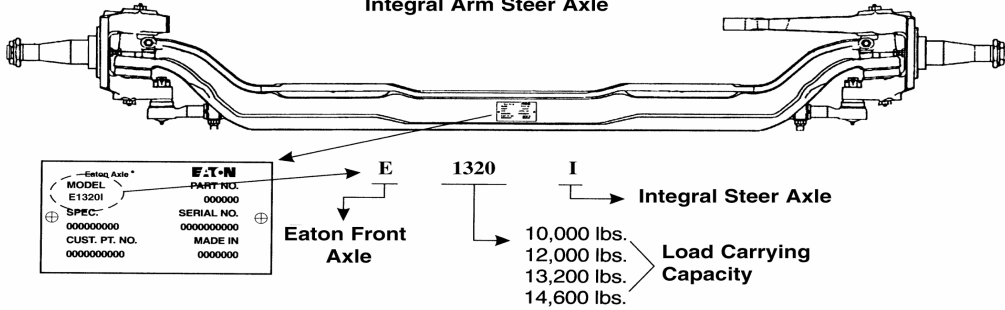

E-1000I, E-1200I, E-1320I, E-1460I

King Bolt Sets

Axle Lbs. Rating	Code	Year	Diameter (inches)	Length (Inches)	Pin Type	Bushing	Notes	King Pin Set No.
10,000	E-1000I		1.794"	9.060"	1	Metal		80076B
12,000	E-1200I		1.794"	9.060"	1	Metal		80076B
13,200	E-1320I		1.794"	9.060"	1	Metal		80076B
14,600	E-1460I		1.872"	9.060"	1	Composite		80078C
	E-1460I		1.872"	9.060"	1	Metal		80077B

Tie Rod Ends

Axle Lbs. Rating	Code	Year	Length (Inches)	Notes	Tie Rod End Part No.	
					Drivers Side	Passenger Side
10,000	E-1000I		6.00"		ES3477	ES3476
12,000	E-1200I		6.00"		ES3477	ES3476
13,200	E-1320I		6.00"		ES3477	ES3476
14,600	E-1460I		7.37"		ES2090L	ES2091R

E1000W

King Bolt Sets

Axle Lbs. Rating	Code	Year	Diameter (inches)	Length (Inches)	Pin Type	Bushing	Notes	King Pin Set No.
10,000	(E1000W)		1.794"	9.060"	1	Metal		80076B

Tie Rod Ends

Axle Lbs. Rating	Code	Year	Length (Inches)	Notes	Tie Rod End Part No.	
					Drivers Side	Passenger Side
10,000	(E1000W)		6.00"		ES3477	ES3476

E1002I

King Bolt Sets

Axle Lbs. Rating	Code	Year	Diameter (inches)	Length (Inches)	Pin Type	Bushing	Notes	King Pin Set No.
10,000	(E1002I)		1.873"	9.06"	9	Composite		8004C

E1002W

King Bolt Sets

Axle Lbs. Rating	Code	Year	Diameter (inches)	Length (Inches)	Pin Type	Bushing	Notes	King Pin Set No.
10,000	(E1002W)		1.873"	9.06"	9	Composite		8004C

E1200W

King Bolt Sets

Axle Lbs. Rating	Code	Year	Diameter (inches)	Length (Inches)	Pin Type	Bushing	Notes	King Pin Set No.
12,000	(E1200W)		1.794"	9.060"	1	Metal		80076B

Tie Rod Ends

Axle Lbs. Rating	Code	Year	Length (Inches)	Notes	Tie Rod End Part No.	
					Drivers Side	Passenger Side
12,000	(E1200W)		6.00"		ES3477	ES3476

E1201W

Tie Rod Ends

Axle Lbs. Rating	Code	Year	Length (Inches)	Notes	Tie Rod End Part No.	
					Drivers Side	Passenger Side
12,000	(E1201W) (E1201W)		6.00" 9.26"		ES3477 ES800423A	ES3476 ES800422A

E1202I

King Bolt Sets

Axle Lbs. Rating	Code	Year	Diameter (inches)	Length (Inches)	Pin Type	Bushing	Notes	King Pin Set No.
12,000	(E1202I)		1.873"	9.06"	9	Composite		8004C

Tie Rod Ends

Axle Lbs. Rating	Code	Year	Length (Inches)	Notes	Tie Rod End Part No.	
					Drivers Side	Passenger Side
10,000	(E1202I)		6.00"		ES3477	ES3476

E1202W

King Bolt Sets

Axle Lbs. Rating	Code	Year	Diameter (inches)	Length (Inches)	Pin Type	Bushing	Notes	King Pin Set No.
12,000	(E1202W)		1.873"	9.06"	9	Composite		8004C

Tie Rod Ends

Axle Lbs. Rating	Code	Year	Length (Inches)	Notes	Tie Rod End Part No.	
					Drivers Side	Passenger Side

E1202W (Cont'd)

Tie Rod Ends (Cont'd)

Axle Lbs. Rating	Code	Year	Length (Inches)	Notes	Tie Rod End Part No.	
					Drivers Side	Passenger Side
12,000	(E1202W)		6.00"		ES3477	ES3476

E1203I

King Bolt Sets

Axle Lbs. Rating	Code	Year	Diameter (inches)	Length (Inches)	Pin Type	Bushing	Notes	King Pin Set No.
12,000	(E1203I)		1.794"	9.06"	9	Composite		8005C

Tie Rod Ends

Axle Lbs. Rating	Code	Year	Length (Inches)	Notes	Tie Rod End Part No.	
					Drivers Side	Passenger Side
12,000	(E1203I)		6.00"		ES3477	ES3476

E1320I

Tie Rod Ends

Axle Lbs. Rating	Code	Year	Length (Inches)	Notes	Tie Rod End Part No.	
					Drivers Side	Passenger Side
13,200	(E1320I)		9.26"		ES800423A	ES800422A

E1320W

King Bolt Sets

Axle Lbs. Rating	Code	Year	Diameter (inches)	Length (Inches)	Pin Type	Bushing	Notes	King Pin Set No.
13,200	(E1320W)		1.794"	9.060"	1	Metal		80076B

Tie Rod Ends

Axle Lbs. Rating	Code	Year	Length (Inches)	Notes	Tie Rod End Part No.	
					Drivers Side	Passenger Side
13,200	(E1320W)		6.00"		ES3477	ES3476
	(E1320W)		7.37"		ES2090L	ES2091R

E1322I

King Bolt Sets

Axle Lbs. Rating	Code	Year	Diameter (inches)	Length (Inches)	Pin Type	Bushing	Notes	King Pin Set No.
13,200	(E1322I)		1.873"	9.06"	9	Composite		8004C

Tie Rod Ends

Axle Lbs. Rating	Code	Year	Length (Inches)	Notes	Tie Rod End Part No.	
					Drivers Side	Passenger Side
13,200	(E1322I)		6.00"		ES3477	ES3476

E1322W

King Bolt Sets

Axle Lbs. Rating	Code	Year	Diameter (inches)	Length (Inches)	Pin Type	Bushing	Notes	King Pin Set No.
13,200	(E1322W)		1.873"	9.06"	9	Composite		8004C

Tie Rod Ends

Axle Lbs. Rating	Code	Year	Length (Inches)	Notes	Tie Rod End Part No.	
					Drivers Side	Passenger Side
13,200	(E1322W)		7.37"		ES2090L	ES2091R

E1460W

King Bolt Sets

Axle Lbs. Rating	Code	Year	Diameter (inches)	Length (Inches)	Pin Type	Bushing	Notes	King Pin Set No.
14,600	(E1460W)		1.870"	9.970"	1	Composite		8633C
	(E1460W)		1.870"	9.970"	1	Metal		8633B

E1460W (Cont'd)

Tie Rod Ends

Axle Lbs. Rating	Code	Year	Length (Inches)	Notes	Tie Rod End Part No.	
					Drivers Side	Passenger Side
14,600	(E1460W)		7.37"		ES800425A	ES2090R
	(E1460W)		9.26"			ES2091R
	(E1460W)				ES2090L	ES800424A

E1462I

King Bolt Sets

Axle Lbs. Rating	Code	Year	Diameter (inches)	Length (Inches)	Pin Type	Bushing	Notes	King Pin Set No.
14,600	(E1462I)		1.873"	9.06"	9	Composite		8004C

E1462W

King Bolt Sets

Axle Lbs. Rating	Code	Year	Diameter (inches)	Length (Inches)	Pin Type	Bushing	Notes	King Pin Set No.
14,000	(E1462W)		1.873"	9.06"	9	Composite		8004C

EFA-12F3, EFA-13F3, EFA-12F4, EFA-13F5, EFA-18F3, EFA-20F4, EFA-22T2, EFA-22T5, EFA-24T2, EFA-24T5

King Bolt Sets

Axle Lbs. Rating	Code	Year	Diameter (inches)	Length (Inches)	Pin Type	Bushing	Notes	King Pin Set No.
12,000	EFA-12F3		1.630"	9.200"	1	Composite		8631C
	EFA-12F3		1.625"	9.195"	1	Metal		8631B
	EFA-12F4		1.630"	9.200"	1	Composite		8618C
	EFA-12F4		1.625"	9.200"	1	Metal		8647B
13,200	EFA-13F3		1.630"	9.200"	1	Composite		8631C
	EFA-13F3		1.625"	9.195"	1	Metal		8631B
	EFA-13F5		1.630"	9.200"	1	Composite		8618C
	EFA-13F5		1.625"	9.200"	1	Metal		8647B
18,000	EFA-18F3		1.870"	9.970"	1	Composite		8633C
	EFA-18F3		1.870"	9.970"	1	Metal		8633B
20,000	EFA-20F4		1.870"	9.970"	1	Composite		8633C
	EFA-20F4		1.870"	9.970"	1	Metal		8633B
22,000	EFA-22T2		1.870"	9.970"	1	Composite		8633C
	EFA-22T2		1.870"	9.970"	1	Metal		8633B
	EFA-22T5		1.870"	9.970"	1	Composite		8633C
	EFA-22T5		1.870"	9.970"	1	Metal		8633B

Tie Rod Ends

Axle Lbs. Rating	Code	Year	Length (Inches)	Notes	Tie Rod End Part No.		
					Drivers Side	Passenger Side	
12,000	EFA-12F3 EFA-12F3 EFA-12F4 EFA-12F4		5.44"		ES423L	ES423R	
			8.12"			ES3298L	ES3297R
			5.44"			ES423L	ES423R
			8.12"			ES3298L	ES3297R
13,200	EFA-13F3 EFA-13F3 EFA-13F5 EFA-13F5		5.44"		ES423L	ES423R	
			8.12"			ES3298L	ES3297R
			5.44"			ES423L	ES423R
			8.12"			ES3298L	ES3297R
18,000	EFA-18F3		7.37"		ES2090L	ES2091R	
20,000	EFA-20F4		7.37"		ES2090L	ES2091R	
22,000	EFA-22T2		7.37"		ES2090L	ES2091R	
	EFA-22T5		7.37"		ES2090L	ES2091R	
24,000	EFA-24T2		7.37"		ES2090L	ES2091R	
	EFA-24T5		7.37"		ES2090L	ES2091R	

F1850 TRUCK MODEL FINDING INDEX

Model	Model	Model	Model
6A (Regular) 6B,6C Heavy Duty			

6A (Regular) 6B,6C Heavy Duty

Drag Links					
Axle Lbs. Rating	Code	Year	Length (inches)	Notes	Drag Link No.
		1958-1959	15.50"	w/Manual Steering	DS584

FABCO TRUCK MODEL FINDING INDEX			
Model	Model	Model	Model
SDA12, SDA14, SDA16, SDA18, SDA21, SDA23			

SDA12, SDA14, SDA16, SDA18, SDA21, SDA23

Tie Rod Ends						
Axle Lbs. Rating	Code	Year	Length (Inches)	Notes	Tie Rod End Part No.	
					Drivers Side	Passenger Side
12,000	SDA12		4.88"		ES187L	ES187R
14,000	SDA14		4.88"		ES187L	ES187R
16,000	SDA16		4.88"		ES187L	ES187R
18,000	SDA18		5.75"		ES431R	ES431L
21,000	SDA21		5.75"		ES431R	ES431L
23,000	SDA23		5.75"		ES431R	ES431L

Heavy Duty Trucks

FORD TRUCK MODEL FINDING INDEX			
Model	Model	Model	Model
A85	A95	Aeromax Series	All
AT85	AT95	B500	B600
B6000	B700	B7000	C1000
C1100	C500	C550	C600
C700	C7000	C750	C800
C8000	C850	C900	C9000
C950	CF600	CF700	CF800
CFT800	CL900	CL9000	CLT900
CLT9000	CT600	CT700	CT800
CT8000	CT850	CT900	CT950
F1000	F1100	F4	F500
F600	F700	F750	F800
F8000	F850	F900	F950
FT600	FT700	FT800	FT900
FT950	H1000	HT950	L800
L8000	L900	L9000	LA800
LA900	LCFC450	LCFC550	LL900
LLA900	LLS900	LN500	LN600
LN700	LN800	LN8000	LN900
LN9000	LNT800	LNT8000	LNT880
LNT900	LNT9000	Louisville Series L85	Louisville Series L95
Louisville Series LT85	Louisville Series LT95	LS800	LS900
LS9000	LT800	LT8000	LT880
LT900	LT9000	LTA 900	LTL800
LTL900	LTL9000	LTLA900	LTLS900
LTS800	LTS8000	LTS900	LTS9000
M400 Motor Home Chassis	N1000	N1100	N500
N600	N6000	N8000	N850
N950	NT850	NT950	P400
P500	P600	T800	T850
T950	W1000	W900	W9000
WT1000	WT900	WT9000	

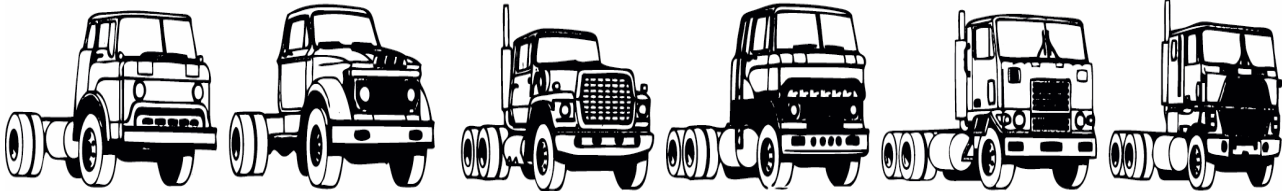

C & CT500-8000 N & NT500-1000 L, LN, LNT, LT500-9000 H & HT1000 W & WT1000 CL & CLT1000

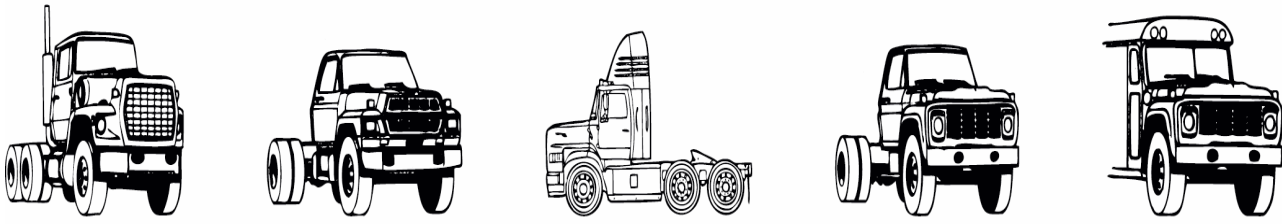

LTS900-9000 F600-850 (From 1980) AEROMAX F600-850 (To 1979) B500-700

Aeromax Series, A85, AT85, A95, AT95

King Bolt Sets

Axle Lbs. Rating	Code	Year	Diameter (inches)	Length (Inches)	Pin Type	Bushing	Notes	King Pin Set No.
9,000		1997-1998	1.610"	9.080"	2	Composite		8641B
10,000		1997-1998	1.794"	10.070"	2	Composite	w/Steel Axle	80071C
12,000		1997-1998	1.794"	10.070"	2	Composite	w/Steel Axle	80071C
		1997-1998	1.794"	10.070"	2	Composite	w/Aluminum Axle	80073C
		1997-1998	1.794"	10.070"	2	Metal	w/Aluminum Axle	80072B
13,000		1997-1998	1.794"	10.070"	2	Composite		80071C
18,000		1996-1998	1.999"	11.212"	2	Metal		8571B
20,000		1996-1998	1.999"	11.212"	2	Metal		8571B

Tie Rod Ends

Axle Lbs. Rating	Code	Year	Length (Inches)	Notes	Tie Rod End Part No.	
					Drivers Side	Passenger Side
9,000		1997-1998	7.18"		ES3284L	ES3283R
10,000		1997-1998	7.38"		ES3443L	ES3442R
12,000		1997-1998	7.38"		ES3443L	ES3442R
13,000		1997-1998	7.38"		ES3443L	ES3442R
18,000		1996-1998	6.00"		ES3177L	ES3176R
20,000		1996-1998	6.00"		ES3177L	ES3176R

Drag Links

Axle Lbs. Rating	Code	Year	Length (inches)	Notes	Drag Link No.
10,000		1997-1998	26.83"	W/60" Taper Springs	DS1443
12,000		1997-1998	26.83"	W/60" Taper Springs	DS1443
13,000		1997-1998	18.24"		DS1442
			26.83"	W/60" Taper Springs	DS1443
14,600		1997-1998	18.42"	W/54" Taper Spring	DS1446
			18.65"	Highway Tractor	DS1445
			27.45"		DS1444
16,000		1997-1998	18.42"	W/54" Taper Spring	DS1446
18,000		1997-1998	18.21"		DS1448
					DS1447
20,000		1997-1998	18.21"		DS1448
					DS1447

All

King Bolt Sets

Axle Lbs. Rating	Code	Year	Diameter (inches)	Length (Inches)	Pin Type	Bushing	Notes	King Pin Set No.
16,000		1942-1947	0.822"	5.860"	1	Metal		8440B

Tie Rod Ends

Axle Lbs. Rating	Code	Year	Length (Inches)	Notes	Tie Rod End Part No.	
					Drivers Side	Passenger Side
16,000		1942-1947	3.22"		ES416L	ES416R

B500, F500

King Bolt Sets

Axle Lbs. Rating	Code	Year	Diameter (inches)	Length (Inches)	Pin Type	Bushing	Notes	King Pin Set No.
5,000		1957-1962	1.129"	7.670"	4	Metal		8459B
		1957-1962	1.129"	7.670"	4	Metal		8471B
		1961-1977	1.231"	7.860"	4	Metal		8488B
		1961-1977	1.241"	7.860"	4	Metal		8488B010
		1961-1977	1.231"	7.860"	1	Metal	Heavy Duty	8609B

Tie Rod Ends

Axle Lbs. Rating	Code	Year	Length (Inches)	Notes	Tie Rod End Part No.	
					Drivers Side	Passenger Side
5,000		1953-1966	3.50"	w/Manual Steering	ES150L	ES150R
		1967-1977	4.45"	Use DS925S Sleeve	ES373L	ES373R

FORD TRUCK

B500, F500 (Cont'd)

Drag Links

Axle Lbs. Rating	Code	Year	Length (inches)	Notes	Drag Link No.	
5,000		1961-1966	15.32"	w/Manual Steering	DS659	DS800
		1967-1977	16.64"			

B600, B6000

King Bolt Sets

Axle Lbs. Rating	Code	Year	Diameter (inches)	Length (Inches)	Pin Type	Bushing	Notes	King Pin Set No.	
4,700		1957-1962	1.129"	7.670"	4	Metal	w/Ball Bearing Type Thrust Brg. w/Multi-washer Type Thrust Brg.	8459B	8471B
		1957-1962	1.129"	7.670"	4	Metal			
5,000		1961-1985	1.231"	7.860"	4	Metal	Heavy Duty	8488B	8488B010 8609B
		1961-1985	1.241"	7.860"	4	Metal			
		1961-1985	1.231"	7.860"	1	Metal			
5,500		1963-1985	1.231"	7.860"	4	Metal	Heavy Duty	8488B	8488B010 8609B
		1963-1985	1.241"	7.860"	4	Metal			
		1963-1985	1.231"	7.860"	1	Metal			
6,000		1961-1966	1.234"	7.500"	1	Metal		8357B	8500B010 8639B 8357N 8500N
		1967-1988	1.231"	8.910"	4	Metal			
		1967-1988	1.241"	8.910"	4	Metal			
		1989-1994	1.300"	7.757"	2	Metal			
		1961-1966	1.234"	7.500"	1	Nylon			
		1967-1988	1.231"	8.910"	4	Nylon			
7,000		1961-1966	1.234"	7.440"	2	Metal	w/Hyd. Brakes To W40,001 w/Hyd. Brakes To W40,001 From W40,001 w/Air Brakes	8479B	8500B 8500B 8500B010 8500B010 8507B010 8568B 8639B 8639B 8479N 8500N 8500N
		1980-1986	1.231"	8.910"	4	Metal			
		1967-1975	1.231"	8.910"	4	Metal			
		1980-1986	1.241"	8.910"	4	Metal			
		1967-1975	1.241"	8.910"	4	Metal			
		1961-1966	1.244"	7.440"	2	Metal			
		1975-1988	1.433"	8.250"	2	Metal			
		1989-1994	1.300"	7.757"	2	Metal			
		1989-1994	1.300"	7.757"	2	Metal			
		1961-1966	1.234"	7.440"	2	Nylon			
		1967-1975	1.231"	8.910"	4	Nylon			
		1980-1986	1.231"	8.910"	4	Nylon			
7,500		1980-1986	1.433"	8.250"	2	Metal	w/Air Brakes	8568B	
8,000		1984-1990	1.433"	8.250"	2	Metal	w/Air Brakes	8568B	
		1991-1994	1.435"	8.240"	2	Metal	From 2/91 w/Air Brakes	8653B	
9,000		1980-1990	1.433"	8.250"	2	Metal	From 2/91 w/Air Brakes	8568B	
		1991-1994	1.435"	8.240"	2	Metal		8653B	
14,600		1994-1994	1.812"	10.542"	2	Metal		80069B	

Tie Rod Ends

Axle Lbs. Rating	Code	Year	Length (Inches)	Notes	Tie Rod End Part No.	
					Drivers Side	Passenger Side
4,700		1957-1962	3.50"		ES150L	ES150R
5,000		1961-1966	3.50"	w/Manual Steering	ES150L	ES150R
		1967-1985	4.45"		ES373L	ES373R
5,500		1963-1966	3.50"	w/Manual Steering	ES150L	ES150R
		1967-1979	4.45"		ES373L	ES373R
6,000		1960-1966	3.75"	w/Hyd. Brakes	ES194L	ES194R
		1961-1966	4.44"		ES2083L	ES2082R
		1967-1989	4.45"		ES373L	ES373R
		1990-1994	4.93"		ES2061L	ES2062R
		1990-1994	5.86"		ES2035L	ES2036R
7,000		1961-1966	3.90"	w/Hyd. Brakes w/Air Brakes To W40,001 w/Air Brakes From W40,001 To 7/93	ES304L	ES304R
		1967-1989	4.45"		ES373L	ES373R
		1973-1975	4.45"		ES373L	ES373R
		1990-1990	4.93"		ES2061L	ES2062R
		1975-1988	5.86"		ES2035L	ES2036R
		1990-1993	5.86"		ES2035L	ES2036R
7,500		1980-1986	5.86"	w/Air Brakes	ES2035L	ES2036R
8,000		1984-1989	5.86"		ES2035L	ES2036R
		1990-1994	5.86"		ES2035L	ES2036R
9,000		1990-1994	5.86"		ES2035L	ES2036R
		1977-1989	5.86"		ES2035L	ES2036R

B600, B6000 (Cont'd)

Drag Links

Axle Lbs. Rating	Code	Year	Length (inches)	Notes	Drag Link No.
4.700		1961-1962	15.32"	w/Manual Steering	DS659
5.000		1961-1966	15.32"	w/Manual Steering	DS659
		1967-1979	16.64"		DS800
5.500		1961-1966	15.32"	w/Manual Steering	DS659
		1967-1969	16.64"		DS800
6.000		1960-1966	16.25"	w/Manual Steering	DS733
		1967-1969	16.16"	w/Power Steering	DS803
		1967-1979	16.64"	w/Manual Steering	DS800
		1980-1987	19.25"	Until 12/1987	DS948
		1987-1988	19.29"	From 12/1987	DS1190
		1989-1992	20.66"		DS1191
		1993-1994	20.44"		DS1259
7.000		1994-1994	21.20"		DS1366
		1961-1966	16.25"	w/Manual Steering	DS733
		1967-1979	16.16"	w/Power Steering	DS803
			16.64"	w/Manual Steering	DS800
		1980-1987	19.25"	Until 12/1987	DS948
		1987-1988	19.29"	From 12/1987	DS1190
		1989-1992	20.66"		DS1191
7.500		1993-1994	20.44"		DS1259
		1994-1994	21.20"		DS1366
8.000		1980-1986	19.25"		DS948
8.000		1980-1987	19.23"		DS949
		1988-1992	20.30"		DS1192
		1992-1993	19.47"	Before 5/1993	DS1271
		1993-1994	19.43"	After 5/1993	DS1369
9.000		1980-1987	19.23"		DS949
		1988-1992	20.30"		DS1192
		1992-1993	19.47"	Before 5/1993	DS1271
		1993-1994	19.43"	After 5/1993	DS1369
10.000		1990-1991	19.23"		DS1204
		1992-1994	19.43"		DS1272
		1995-1995	18.47"	Taper, w/SPR Cap MUL, SPR Cap	DS1370
12.000			19.01"		DS1371
		1990-1991	19.23"		DS1204
		1992-1994	19.43"		DS1272
14.600		1995-1995	18.47"	Taper, w/SPR Cap MUL, SPR Cap	DS1370
			19.01"		DS1371
		1994-1994	18.47"	Drag Link Assy.	DS1370

B700, B7000

King Bolt Sets

Axle Lbs. Rating	Code	Year	Diameter (inches)	Length (Inches)	Pin Type	Bushing	Notes	King Pin Set No.
5,000		1961-1976	1.231"	7.860"	4	Metal		8488B
		1961-1976	1.241"	7.860"	4	Metal		8488B010
		1961-1976	1.231"	7.860"	1	Metal	Heavy Duty	8609B
5,500		1961-1976	1.231"	7.860"	4	Metal		8488B
		1961-1976	1.241"	7.860"	4	Metal		8488B010
		1961-1976	1.231"	7.860"	1	Metal	Heavy Duty	8609B
6,000		1961-1966	1.234"	7.500"	1	Metal		8357B
		1967-1988	1.231"	8.910"	4	Metal		8500B
		1967-1988	1.241"	8.910"	4	Metal		8500B010
		1989-1994	1.300"	7.757"	2	Metal		8639B
		1961-1966	1.234"	7.500"	1	Nylon		8357N
		1967-1988	1.231"	8.910"	4	Nylon		8500N
7,000		1967-1975	1.231"	8.910"	4	Metal	w/Air Brakes	8500B
		1967-1986	1.231"	8.910"	4	Metal	1973-83 w/Hyd. Brakes	8500B
		1967-1975	1.241"	8.910"	4	Metal	w/Air Brakes	8500B010
		1967-1986	1.241"	8.910"	4	Metal	1973-83 w/Hyd. Brakes	8500B010
		1967-1975	1.234"	7.440"	2	Metal		8507B
		1967-1975	1.244"	7.440"	2	Metal		8507B010
		1975-1975	1.433"	8.250"	2	Metal	w/Air Brakes From W40,001	8568B
		1980-1988	1.433"	8.250"	2	Metal	w/Air Brakes	8568B
		1989-1994	1.300"	7.757"	2	Metal	w/Air Brakes	8639B
		1967-1986	1.231"	8.910"	4	Nylon	1973-83 w/Hyd. Brakes	8500N
	1967-1975	1.231"	8.910"	4	Nylon	w/Air Brakes	8500N	
	1967-1975	1.234"	7.440"	2	Nylon		8507N	
7,500		1980-1986	1.433"	8.250"	2	Metal	w/Air Brakes	8568B
8,000		1984-1990	1.433"	8.250"	2	Metal	w/Air Brakes	8568B
		1991-1994	1.435"	8.240"	2	Metal		8653B
9,000		1971-1978	1.434"	8.500"	2	Metal		8519B
		1971-1978	1.444"	8.500"	2	Metal		8519B010

FORD TRUCK



B700, B7000 (Cont'd)

King Bolt Sets (Cont'd)

Axle Lbs. Rating	Code	Year	Diameter (inches)	Length (Inches)	Pin Type	Bushing	Notes	King Pin Set No.
9,000		1977-1990	1.433"	8.250"	2	Metal		8568B
		1991-1994	1.435"	8.240"	2	Metal		8653B
		1971-1978	1.434"	8.500"	2	Nylon		8519N

Tie Rod Ends

Axle Lbs. Rating	Code	Year	Length (Inches)	Notes	Tie Rod End Part No.	
					Drivers Side	Passenger Side
5,000		1967-1976	4.45"		ES373L	ES373R
5,500		1961-1966	3.50"	w/Manual Steering	ES150L	ES150R
		1967-1976	4.45"		ES373L	ES373R
		1967-1976	4.45"	Uses DS925S Sleeve	ES373L	ES373R
6,000		1957-1966	3.75"		ES194L	ES194R
		1961-1969	4.44"		ES2083L	ES2082R
		1967-1989	4.45"		ES373L	ES373R
		1990-1994	4.93"		ES2061L	ES2062R
		1990-1994	5.86"		ES2035L	ES2036R
7,000		1967-1986	4.45"	1973-83 w/Hyd. Brakes	ES373L	ES373R
		1989-1989	4.45"	w/Air Brakes	ES373L	ES373R
		1967-1975	4.45"	w/Air Brakes To W40,001	ES373L	ES373R
		1975-1988	5.86"	w/Air Brakes From W40,001	ES2035L	ES2036R
		1990-1994	5.86"		ES2035L	ES2036R
7,500		1977-1986	5.86"	w/Air Brakes	ES2035L	ES2036R
8,000		1984-1989	5.86"		ES2035L	ES2036R
		1990-1994	5.86"		ES2035L	ES2036R
9,000		1990-1994	5.86"		ES2035L	ES2036R
		1977-1989	5.86"		ES2035L	ES2036R

Drag Links

Axle Lbs. Rating	Code	Year	Length (inches)	Notes	Drag Link No.
5,000		1973-1975	16.64"	w/Manual Steering To W20,001 w/Power Steering To W40,001	DS800
5,500		1973-1975	16.64"	w/Manual Steering w/Power Steering To W40,001	DS800
6,000		1960-1966	16.25"	w/Manual Steering	DS733
		1967-1972	16.64"		DS800
		1967-1968		w/Power Steering	DS803
		1969-1972	16.16"		DS800
		1973-1975	16.64"	w/Manual Steering To W20,001	DS803
		1975-1979	16.16"	w/Air Brakes From W40,001	DS803
		1977-1979	16.64"	w/Hyd. Brakes	DS800
		1980-1987	19.25"	Until 12/1987	DS948
		1987-1988	19.29"	From 12/1987	DS1190
		1989-1992	20.66"		DS1191
1993-1994	20.44"		DS1259		
1994-1994	21.20"		DS1366		
7,000		1961-1966	16.25"	w/Manual Steering	DS733
		1967-1968	16.64"	w/Power Steering	DS800
		1967-1972		w/Manual Steering	
		1969-1972	16.16"	w/Power Steering	DS803
		1973-1975	16.64"	w/Manual Steering To W20,001	DS800
		1975-1979	15.85"	From W40,001	DS945
		1977-1979	16.16"	w/Air Brakes	DS803
		1980-1987	19.25"	Until 12/1987	DS948
		1987-1988	19.29"	From 12/1987	DS1190
		1989-1992	20.66"		DS1191
1993-1994	20.44"		DS1259		
1994-1994	21.20"		DS1366		
7,500		1980-1986	19.25"		DS948
8,000		1980-1987	19.23"		DS949
		1989-1992	20.30"		DS1192
		1992-1993	19.47"	Before 5/1993	DS1271
		1993-1994	19.43"	After 5/1993	DS1369
9,000		1975-1979	16.49"	From W40,001	DS952
		1977-1979	16.64"	w/Hyd. Brakes	DS800
		1980-1987	19.23"		DS949
		1988-1992	20.30"		DS1192
		1992-1993	19.47"	Before 5/1993	DS1271
		1993-1994	19.43"	After 5/1993	DS1369
10,000		1990-1991	19.23"		DS1204
		1992-1994	19.43"		DS1272

B700, B7000 (Cont'd)

Drag Links (Cont'd)

Axle Lbs. Rating	Code	Year	Length (inches)	Notes	Drag Link No.	
12,000		1990-1991	19.23"		DS1204	
		1992-1994	19.43"		DS1272	
14,600		1994-1994	18.47"	Drag Link Assy.	DS1370	

B7000

Tie Rod Ends

Axle Lbs. Rating	Code	Year	Length (Inches)	Notes	Tie Rod End Part No.	
					Drivers Side	Passenger Side
6,000		1997-1998	13.25"		ES3039L	ES3040R
		1995-1999	6.00"		ES3177L	ES3176R
7,000		1990-1997	13.25"		ES3039L	ES3040R
		1990-1994	4.93"		ES2061L	ES2061R
		1995-1999	6.00"		ES3177L	ES3176R
7,500		1990-1997	13.25"		ES3039L	ES3040R
		1990-1994	4.93"		ES2061L	ES2061R
		1995-1999	6.00"		ES3177L	ES3176R
8,000		1995-1999	7.18"		ES3284L	ES3283R
8,500		1984-1988	5.86"		ES2035L	ES2036R
		1995-1999	7.18"		ES3284L	ES3283R
9,000		1973-1979	4.88"	w/Hydraulic Brakes	ES187L	ES187R
		1973-1975	4.88"	w/Air Brakes	ES187L	ES187R
		1995-1998	7.18"		ES3284L	ES3283R

Drag Links

Axle Lbs. Rating	Code	Year	Length (inches)	Notes	Drag Link No.	
10,000		1995-1998	19.01"	w/Multileaf Springs	DS1371	
12,000		1995-1998	18.47"	w/Full Taper Springs	DS1370	

C1100

King Bolt Sets

Axle Lbs. Rating	Code	Year	Diameter (inches)	Length (Inches)	Pin Type	Bushing	Notes	King Pin Set No.	
9,000		1964-1965	1.434"	8.500"	2	Metal		8519B	
		1964-1965	1.444"	8.500"	2	Metal		8519B010	
		1964-1965	1.434"	8.500"	2	Nylon		8519N	
11,000		1964-1965	1.607"	8.812"	2	Metal	(Center Point Steering)	8514B	
		1964-1965	1.607"	8.812"	2	Nylon	(Center Point Steering)	8514N	
12,000		1964-1965	1.794"	9.120"	2	Metal		8489B	
		1964-1965	1.794"	9.120"	2	Nylon		8489N	
15,000		1964-1965	1.400/1.794"	10.688"	7	Metal		8474B	

Tie Rod Ends

Axle Lbs. Rating	Code	Year	Length (Inches)	Notes	Tie Rod End Part No.	
					Drivers Side	Passenger Side
9,000		1964-1965	4.88"		ES187L	ES187R
12,000		1964-1965	5.75"	Anti-Tilt Seal Type	ES346L	ES346R
15,000		1964-1965	5.75"	Anti-Tilt Seal Type	ES346L	ES346R

C500

King Bolt Sets

Axle Lbs. Rating	Code	Year	Diameter (inches)	Length (Inches)	Pin Type	Bushing	Notes	King Pin Set No.	
6,000		1961-1968	1.234"	7.500"	1	Metal		8357B	
		1970-1971	1.231"	8.910"	4	Metal		8500B	
		1970-1971	1.241"	8.910"	4	Metal		8500B010	
		1968-1970	1.234"	7.440"	2	Metal		8507B	
		1961-1968	1.234"	7.500"	1	Nylon		8357N	
		1970-1971	1.231"	8.910"	4	Nylon		8500N	
		1968-1970	1.234"	7.440"	2	Nylon		8507N	

FORD TRUCK

C500 (Cont'd)

Tie Rod Ends

Axle Lbs. Rating	Code	Year	Length (Inches)	Notes	Tie Rod End Part No.	
					Drivers Side	Passenger Side
6,000		1968-1970	3.90"		ES304L	ES304R
		1970-1971	4.45"		ES373L	ES373R

C550

King Bolt Sets

Axle Lbs. Rating	Code	Year	Diameter (inches)	Length (Inches)	Pin Type	Bushing	Notes	King Pin Set No.
6,000		1961-1970	1.234"	7.500"	1	Metal	To C70,001	8357B
		1968-1970	1.234"	7.440"	2	Metal	From C70,001-G90,001	8479B
		1970-1971	1.231"	8.910"	4	Metal	From G90,000	8500B
		1970-1971	1.241"	8.910"	4	Metal	From G90,000	8500B010
		1968-1970	1.244"	7.440"	2	Metal	From C70,001-G90,001	8507B010
		1961-1970	1.234"	7.500"	1	Nylon	To C70,001	8357N
		1968-1970	1.234"	7.440"	2	Nylon	From C70,001-G90,001	8479N
		1970-1971	1.231"	8.910"	4	Nylon	From G90,000	8500N

Tie Rod Ends

Axle Lbs. Rating	Code	Year	Length (Inches)	Notes	Tie Rod End Part No.	
					Drivers Side	Passenger Side
6,000		1961-1970	3.75"	From C70,001-G90,001 To C70,001 From G90,000	ES194L	ES194R
		1968-1970	3.90"		ES304L	ES304R
		1961-1968	4.44"		ES2083L	ES2082R
		1970-1971	4.45"		ES373L	ES373R

C600

King Bolt Sets

Axle Lbs. Rating	Code	Year	Diameter (inches)	Length (Inches)	Pin Type	Bushing	Notes	King Pin Set No.
10,000		1990-1990	1.743"	10.061"	2	Composite		80068C
11,000		1970-1978	1.607"	8.812"	2	Metal		8514B
		1970-1978	1.607"	8.812"	2	Nylon		8514N
12,000		1990-1990	1.743"	10.061"	2	Composite	w/Hydraulic Brakes	80068C
		1964-1979	1.794"	9.120"	2	Metal		8489B
		1970-1978	1.607"	8.812"	2	Metal		8514B
		1964-1979	1.794"	9.120"	2	Nylon		8489N
		1970-1978	1.607"	8.812"	2	Nylon		8514N

Tie Rod Ends

Axle Lbs. Rating	Code	Year	Length (Inches)	Notes	Tie Rod End Part No.	
					Drivers Side	Passenger Side
12,000		1964-1979	5.75"	w/Hydraulic Brakes	ES431L	ES431R
16,000		1964-1975	5.75"		ES431L	ES431R
18,000		1998-1998	7.18"		ES3284L	ES3283R
20,000		1998-1998	7.18"		ES3284L	ES3283R

C600, CT600

King Bolt Sets

Axle Lbs. Rating	Code	Year	Diameter (inches)	Length (Inches)	Pin Type	Bushing	Notes	King Pin Set No.
6,000		1956-1970	1.234"	7.500"	1	Metal	To C70,001	8357B
		1968-1970	1.234"	7.440"	2	Metal	From C70,001-G90,001	8479B
		1970-1979	1.231"	8.910"	4	Metal	From G90,001	8500B
		1970-1979	1.241"	8.910"	4	Metal	From G90,001	8500B010
		1968-1970	1.244"	7.440"	2	Metal	From C70,001-G90,001	8507B010
		1956-1970	1.234"	7.500"	1	Nylon	To C70,001	8357N
		1968-1970	1.234"	7.440"	2	Nylon	From C70,001-G90,001	8479N
		1970-1979	1.231"	8.910"	4	Nylon	From G90,001	8500N
7,000		1959-1970	1.234"	7.440"	2	Metal	To G90,001	8479B
		1970-1975	1.231"	8.910"	4	Metal	w/Air Brakes From G90,001-W40,001	8500B
		1970-1989	1.231"	8.910"	4	Metal	w/Hyd. Brakes From G90,001	8500B
		1970-1975	1.241"	8.910"	4	Metal	w/Air Brakes From G90,001-W40,001	8500B010
		1970-1989	1.241"	8.910"	4	Metal	w/Hyd. Brakes From G90,001	8500B010
		1959-1970	1.244"	7.440"	2	Metal	To G90,001	8507B010
		1975-1989	1.433"	8.250"	2	Metal	w/Air Brakes From W40,001	8568B

C600, CT600 (Cont'd)

King Bolt Sets (Cont'd)

Axle Lbs. Rating	Code	Year	Diameter (inches)	Length (Inches)	Pin Type	Bushing	Notes	King Pin Set No.
7,000		1959-1970	1.234"	7.440"	2	Nylon	To G90,001	8479N
		1970-1989	1.231"	8.910"	4	Nylon	w/Hyd. Brakes From G90,001	8500N
		1970-1975	1.231"	8.910"	4	Nylon	w/Air Brakes From G90,001-W40,001	8500N
9,000		1973-1975	1.434"	8.500"	2	Metal	w/Air Brakes	8519B
		1973-1986	1.434"	8.500"	2	Metal	w/Hyd. Brakes	8519B
		1973-1975	1.444"	8.500"	2	Metal	w/Air Brakes	8519B010
		1973-1986	1.444"	8.500"	2	Metal	w/Hyd. Brakes	8519B010
		1987-1989	1.433"	8.250"	2	Metal	w/Air Brakes	8568B
		1973-1986	1.607"	9.080"	2	Metal	w/Air Brakes From W40,001	8573B
		1973-1986	1.434"	8.500"	2	Nylon	w/Hyd. Brakes	8519N
		1973-1975	1.434"	8.500"	2	Nylon	w/Air Brakes	8519N
12,000		1989-1989	1.790"	10.070"	2	Composite	w/Steel Axle	8643B
		1980-1989	1.794"	10.070"	2	Metal		8572B
16,000		1980-1990	1.999"	11.212"	2	Metal		8571B
18,000		1980-1990	1.999"	11.212"	2	Metal		8571B

Tie Rod Ends

Axle Lbs. Rating	Code	Year	Length (Inches)	Notes	Tie Rod End Part No.	
					Drivers Side	Passenger Side
6,000		1959-1970	3.75"	C70,000 to G90,001 To C70,000 From G90,001	ES194R	ES194L
		1968-1970	3.90"		ES304L	ES304R
		1957-1968	4.44"		ES2083L	ES2082R
		1970-1979	4.45"		ES373L	ES373R
7,000		1959-1970	3.90"	To G90,001	ES304L	ES304R
		1971-1975	4.45"	w/Air Brakes To W40,001	ES373L	ES373R
		1970-1989	4.45"	From G90,001 w/Hyd. Brakes	ES373L	ES373R
		1975-1989	5.86"	w/Air Brakes From W40,001	ES2035L	ES2036R
9,000		1973-1986	4.88"	w/Hyd. Brakes	ES187L	ES187R
		1975-1989	5.86"	w/Air Brakes From W40,001	ES2035L	ES2036R
12,000		1980-1989		Cross Tube Assy. w/ends	DS1367A	
		1980-1989	5.44"		ES423L	ES423R
16,000		1980-1989	5.44"		ES423L	ES423R
18,000		1980-1989	5.44"		ES423L	ES423R

Drag Links

Axle Lbs. Rating	Code	Year	Length (inches)	Notes	Drag Link No.
6,000		1976-1979	31.93"	w/Hyd. Brakes & Air Brakes Integral Power Steering	DS944
7,000		1965-1989	31.93"	w/Hyd. Brakes & Integral Power Steering	DS944
		1976-1976	36.31"	w/Air Brakes & Integral Power Steering	DS943
		1980-1990	35.37"	w/Air Brakes & Power Steering	DS956
		1980-1989	37.07"	w/Air Brakes & Manual Steering	DS1035
		1980-1986	35.61"	w/Hyd. Brakes & Integral Power Steering	DS955
9,000		1980-1989	36.31"	w/Power Steering & Air Brakes	DS943
		1980-1989	37.07"	w/Air Brakes & Manual Steering	DS1035
		1980-1989	35.00"	w/Power Steering	DS1205
12,000		1980-1989	35.00"	w/Power Steering & Air Brakes	DS1205
16,000		1980-1989	35.00"	w/Power Steering & Air Brakes	DS1205
18,000		1980-1989	35.00"	w/Power Steering & Air Brakes	DS1205

C700

King Bolt Sets

Axle Lbs. Rating	Code	Year	Diameter (inches)	Length (Inches)	Pin Type	Bushing	Notes	King Pin Set No.
10,000		1990-1990	1.743"	10.061"	2	Composite		80068C
12,000		1990-1990	1.743"	10.061"	2	Composite		80068C
		1964-1979	1.794"	9.120"	2	Metal	w/Hydraulic Brakes	8489B
		1970-1978	1.607"	8.812"	2	Metal		8514B
		1964-1979	1.794"	9.120"	2	Nylon	w/Hydraulic Brakes	8489N
		1970-1978	1.607"	8.812"	2	Nylon		8514N

Tie Rod Ends

Axle Lbs. Rating	Code	Year	Length (Inches)	Notes	Tie Rod End Part No.	
					Drivers Side	Passenger Side
10,000		1990-1990	5.44"		ES423L	ES423R
12,000		1964-1979	5.75"	w/Hydraulic Brakes	ES431L	ES431R
16,000		1964-1975	5.75"		ES431L	ES431R

FORD TRUCK

C700 (Cont'd)

Tie Rod Ends (Cont'd)

Axle Lbs. Rating	Code	Year	Length (Inches)	Notes	Tie Rod End Part No.	
					Drivers Side	Passenger Side
20,000		1998-1998	7.18"		ES3284L	ES3283R

C700, CT700, C750, C7000

King Bolt Sets

Axle Lbs. Rating	Code	Year	Diameter (inches)	Length (Inches)	Pin Type	Bushing	Notes	King Pin Set No.
7,000		1957-1970	1.234"	7.500"	1	Metal	To G90,001	8357B
		1957-1970	1.234"	7.440"	2	Metal	To G90,001	8479B
		1970-1989	1.231"	8.910"	4	Metal	w/Hyd. Brakes From G90,001	8500B
		1973-1975	1.231"	8.910"	4	Metal	w/Air Brakes To W40,001	8500B
		1973-1975	1.241"	8.910"	4	Metal	w/Air Brakes To W40,001	8500B010
		1970-1989	1.241"	8.910"	4	Metal	w/Hyd. Brakes From G90,001	8500B010
		1957-1970	1.244"	7.440"	2	Metal	To G90,001	8507B010
		1975-1989	1.433"	8.250"	2	Metal	w/Air Brakes From W40,001	8568B
		1957-1970	1.234"	7.500"	1	Nylon	To G90,001	8357N
		1957-1970	1.234"	7.440"	2	Nylon	To G90,001	8479N
		1973-1975	1.231"	8.910"	4	Nylon	w/Air Brakes To W40,001	8500N
		1970-1989	1.231"	8.910"	4	Nylon	w/Hyd. Brakes From G90,001	8500N
9,000		1960-1986	1.434"	8.500"	2	Metal	w/Hyd. Brakes	8519B
		1973-1975	1.434"	8.500"	2	Metal	w/Air Brakes To W40,001	8519B
		1960-1986	1.444"	8.500"	2	Metal	w/Hyd. Brakes	8519B010
		1973-1975	1.444"	8.500"	2	Metal	w/Air Brakes To W40,001	8519B010
		1987-1989	1.433"	8.250"	2	Metal	w/Air Brakes	8568B
		1975-1990	1.607"	9.080"	2	Metal	w/Air Brakes From W40,001	8573B
		1960-1986	1.434"	8.500"	2	Nylon	w/Hyd. Brakes	8519N
		1973-1975	1.434"	8.500"	2	Nylon	w/Air Brakes To W40,001	8519N
12,000		1980-1989	1.794"	10.070"	2	Metal		8572B
16,000		1980-1989	1.999"	11.212"	2	Metal		8571B
18,000		1980-1989	1.999"	11.212"	2	Metal		8571B

Tie Rod Ends

Axle Lbs. Rating	Code	Year	Length (Inches)	Notes	Tie Rod End Part No.	
					Drivers Side	Passenger Side
7,000		1953-1970	3.90"	To G90,001	ES304L	ES304R
		1973-1975	4.45"	w/Air Brakes To W40,001	ES373L	ES373R
		1970-1989	4.45"	w/Hyd. Brakes From G90,001	ES373L	ES373R
		1975-1989	5.86"	w/Air Brakes From W40,001	ES2035L	ES2036R
9,000		1973-1986	4.88"	w/Hyd. Brakes	ES187L	ES187R
		1973-1975	4.88"	w/Air Brakes To W40,001	ES187L	ES187R
		1960-1972	4.88"		ES187L	ES187R
		1975-1989	5.86"	w/Air Brakes From W40,001	ES2035L	ES2036R
12,000		1980-1989	5.44"		ES423L	ES423R
16,000		1980-1989	5.44"		ES423L	ES423R
18,000		1980-1989	5.44"		ES423L	ES423R

Drag Links

Axle Lbs. Rating	Code	Year	Length (inches)	Notes	Drag Link No.
7,000		1976-1989	31.93"	w/Integral Power Steering & Hyd. Brakes	DS944
		1976-1980	36.31"	w/Integral Power Steering & Air Brakes	DS943
		1980-1990	35.37"	w/Power Steering & Air Brakes	DS956
		1980-1989	37.07"	w/Air Brakes & Manual Steering	DS1035
9,000		1976-1980	35.37"	w/Integral Power Steering & Air Brakes	DS956
		1976-1986	35.61"	w/Integral Power Steering & Hyd. Brakes From A85,001	DS955
		1980-1989	36.31"	w/Power Steering & Air Brakes	DS943
			37.07"	w/Air Brakes & Manual Steering	DS1035
12,000		1980-1989	35.00"	w/Power Steering & Air Brakes	DS1205
16,000		1980-1989	35.00"	w/Power Steering & Air Brakes	DS1205
18,000		1980-1989	35.00"	w/Power Steering & Air Brakes	DS1205

C800

King Bolt Sets

Axle Lbs. Rating	Code	Year	Diameter (inches)	Length (Inches)	Pin Type	Bushing	Notes	King Pin Set No.
7,000		1964-1970	1.234"	7.440"	2	Metal		8507B
		1964-1970	1.244"	7.440"	2	Metal		8507B010

C800 (Cont'd)

King Bolt Sets (Cont'd)

Axle Lbs. Rating	Code	Year	Diameter (inches)	Length (Inches)	Pin Type	Bushing	Notes	King Pin Set No.
7,000		1964-1970	1.234"	7.440"	2	Nylon		8507N
10,000		1990-1990	1.743"	10.061"	2	Composite		80068C

Tie Rod Ends

Axle Lbs. Rating	Code	Year	Length (Inches)	Notes	Tie Rod End Part No.	
					Drivers Side	Passenger Side
7,000		1964-1970	3.90"	Before Serial No. G70,001	ES304L	ES304R
16,000		1964-1975	5.75"		ES431L	ES431R
18,000		1998-1998	7.18"		ES3284L	ES3283R
20,000		1998-1998	7.18"		ES3284L	ES3283R

C800, C8000, CT8000

King Bolt Sets

Axle Lbs. Rating	Code	Year	Diameter (inches)	Length (Inches)	Pin Type	Bushing	Notes	King Pin Set No.
7,000		1980-1989	1.231"	8.910"	4	Metal	w/Hyd. Brakes	8500B
		1980-1989	1.241"	8.910"	4	Metal	w/Hyd. Brakes	8500B010
		1980-1990	1.433"	8.250"	2	Metal	w/Air Brakes	8568B
		1980-1989	1.231"	8.910"	4	Nylon	w/Hyd. Brakes	8500N
9,000		1980-1986	1.434"	8.500"	2	Metal	w/Hyd. Brakes	8519B
		1962-1972	1.434"	8.500"	2	Metal		8519B
		1962-1972	1.444"	8.500"	2	Metal		8519B010
		1980-1986	1.444"	8.500"	2	Metal	w/Hyd. Brakes	8519B010
		1987-1989	1.433"	8.250"	2	Metal		8568B
		1980-1986	1.607"	9.080"	2	Metal	w/Air Brakes	8573B
		1990-1990	1.607"	9.080"	2	Metal		8573B
		1962-1972	1.434"	8.500"	2	Nylon		8519N
		1980-1986	1.434"	8.500"	2	Nylon	w/Hyd. Brakes	8519N
11,000		1964-1972	1.607"	8.812"	2	Metal	(Center Point Steering)	8514B
		1964-1972	1.607"	8.812"	2	Nylon	(Center Point Steering)	8514N
12,000		1960-1979	1.794"	9.120"	2	Metal	w/Hyd. Brakes From 1973	8489B
		1973-1975	1.794"	9.120"	2	Metal	w/Air Brakes To W40,001	8489B
		1966-1975	1.607"	8.812"	2	Metal	(Center Point Steering)	8514B
		1980-1990	1.794"	10.070"	2	Metal	Exc. Aluminum Axle	8572B
		1975-1979	1.607"	9.080"	2	Metal	w/Air Brakes From W40,001	8573B
		1960-1979	1.794"	9.120"	2	Nylon	w/Hyd. Brakes From 1973	8489N
		1973-1975	1.794"	9.120"	2	Nylon	w/Air Brakes To W40,001	8489N
		1966-1975	1.607"	8.812"	2	Nylon	(Center Point Steering)	8514N
16,000		1980-1990	1.999"	11.212"	2	Metal		8571B
18,000		1980-1990	1.999"	11.212"	2	Metal		8571B

Tie Rod Ends

Axle Lbs. Rating	Code	Year	Length (Inches)	Notes	Tie Rod End Part No.	
					Drivers Side	Passenger Side
7,000		1980-1989	4.45"	w/Hyd. Brakes	ES373L	ES373R
		1980-1989	5.86"	w/Air Brakes	ES2035L	ES2036R
9,000		1980-1986	4.88"	w/Hyd. Brakes	ES187L	ES187R
		1962-1972	4.88"		ES187L	ES187R
		1980-1989	5.86"	w/Air Brakes	ES2035L	ES2036R
		1990-1990	5.86"		ES2035L	ES2036R
10,000		1990-1990		Cross Tube Assy. w/ends	DS1367A	
		1990-1990	5.44"	w/Aluminum Axle	ES423L	ES423R
12,000		1980-1990		Cross Tube Assy. w/ends	DS1367A	
		1980-1990	5.44"		ES423L	ES423R
		1975-1980	5.44"	w/Air Brakes From W40,001	ES423L	ES423R
		1973-1980	5.75"	w/Hyd. Brakes	ES431L	ES431R
		1973-1975	5.75"	w/Air Brakes To W40,001	ES431L	ES431R
		1962-1970	5.75"	To G70,001	ES431L	ES431R
		1970-1972	5.75"	From G70,001	ES431L	ES431R
15,000		1975-1980	5.44"	W/Air Brakes From W40,001	ES423L	ES423R
		1964-1972	5.75"		ES431L	ES431R
		1973-1975	5.75"	w/Hyd. Brakes	ES431L	ES431R
		1973-1975	5.75"	W/Air Brakes To W40,001	ES431L	ES431R
16,000		1980-1990	5.44"		ES423L	ES423R
18,000		1975-1990	5.44"		ES423L	ES423R

FORD TRUCK

C800, C8000, CT8000 (Cont'd)

Tie Rod Ends (Cont'd)

Axle Lbs. Rating	Code	Year	Length (Inches)	Notes	Tie Rod End Part No.	
					Drivers Side	Passenger Side
20,000		1980-1988	5.44"		ES423R	
		1980-1988	5.75"		ES431L	

Drag Links

Axle Lbs. Rating	Code	Year	Length (inches)	Notes	Drag Link No.
7,000		1980-1990	31.93"	w/Hyd. Brakes & Power Steering	DS944
			35.37"	w/Air Brakes & Power Steering	DS956
			37.07"	w/Air Brakes & Manual Steering	DS1035
9,000		1976-1986	35.37"	w/Integral Power Steering & Air Brakes	DS956
		1980-1986	35.61"	w/Integral Power Steering	DS955
		1980-1989	36.31"	w/Integral Power Steering & Air Brakes	DS943
			37.07"	w/Air Brakes & Manual Steering	DS1035
		1990-1990	35.61"	w/Power Steering	DS1206
12,000		1976-1979	35.00"	w/Integral Power Steering	DS955
		1980-1990	37.07"	w/Integral Power Steering & Air Brakes	DS1205
		1980-1986		35.00"	DS1035
		1990-1990		36.31"	DS943
		16,000		1980-1989	35.00"
18,000		1980-1989	35.00"	w/Air Brakes & Power Steering	DS1205
		1990-1990			

C850

King Bolt Sets

Axle Lbs. Rating	Code	Year	Diameter (inches)	Length (Inches)	Pin Type	Bushing	Notes	King Pin Set No.
9,000		1961-1970	1.434"	8.500"	2	Metal		8519B
		1961-1970	1.444"	8.500"	2	Metal		8519B010
		1961-1970	1.434"	8.500"	2	Nylon		8519N
11,000		1960-1963	1.309/1.607"	9.750"	7	Metal	(Center Point Steering)	8386B
		1964-1965	1.607"	8.812"	2	Metal	(Center Point Steering)	8514B
		1960-1963	1.309/1.607"	9.750"	7	Nylon	(Center Point Steering)	8386N
		1964-1965	1.607"	8.812"	2	Nylon	(Center Point Steering)	8514N
12,000		1961-1970	1.794"	9.120"	2	Metal		8489B
		1966-1970	1.607"	8.812"	2	Metal	(Center Point Steering)	8514B
		1961-1970	1.794"	9.120"	2	Nylon		8489N
		1966-1970	1.607"	8.812"	2	Nylon	(Center Point Steering)	8514N

Tie Rod Ends

Axle Lbs. Rating	Code	Year	Length (Inches)	Notes	Tie Rod End Part No.	
					Drivers Side	Passenger Side
9,000		1961-1970	4.88"		ES187L	ES187R
12,000		1961-1970	5.75"	Anti-Tilt Seal Type	ES346L	ES346R

C900

Tie Rod Ends

Axle Lbs. Rating	Code	Year	Length (Inches)	Notes	Tie Rod End Part No.	
					Drivers Side	Passenger Side
10,000		1990-1990	5.44"		ES423L	ES423R
16,000		1964-1975	5.75"		ES431L	ES431R
18,000		1998-1998	7.18"		ES3284L	ES3283R
20,000		1998-1998	7.18"		ES3284L	ES3283R

C900, CT900, C9000

King Bolt Sets

Axle Lbs. Rating	Code	Year	Diameter (inches)	Length (Inches)	Pin Type	Bushing	Notes	King Pin Set No.
7,000		1980-1989	1.231"	8.910"	4	Metal	w/Hyd. Brakes	8500B
		1980-1989	1.241"	8.910"	4	Metal	w/Hyd. Brakes	8500B010
		1980-1989	1.433"	8.250"	2	Metal	w/Air Brakes	8568B
		1980-1989	1.231"	8.910"	4	Nylon	w/Hyd. Brakes	8500N
9,000		1970-1972	1.231"	8.910"	4	Metal		8500B

C900, CT900, C9000 (Cont'd)

King Bolt Sets (Cont'd)

Axle Lbs. Rating	Code	Year	Diameter (inches)	Length (Inches)	Pin Type	Bushing	Notes	King Pin Set No.
9,000		1973-1981	1.231"	8.910"	4	Metal	w/Hyd. Brakes	8500B
		1970-1972	1.241"	8.910"	4	Metal		8500B010
		1973-1981	1.241"	8.910"	4	Metal	w/Hyd. Brakes	8500B010
		1980-1983	1.434"	8.500"	2	Metal	w/Hyd. Brakes	8519B
		1971-1975	1.434"	8.500"	2	Metal	w/Air Brakes To W40,001	8519B
		1980-1983	1.444"	8.500"	2	Metal	w/Hyd. Brakes	8519B010
		1971-1975	1.444"	8.500"	2	Metal	w/Air Brakes To W40,001	8519B010
		1987-1989	1.433"	8.250"	2	Metal	w/Air Brakes	8568B
		1975-1986	1.607"	9.080"	2	Metal	w/Air Brakes From W40,001	8573B
		1970-1972	1.231"	8.910"	4	Nylon		8500N
		1973-1981	1.231"	8.910"	4	Nylon	w/Hyd. Brakes	8500N
		1971-1975	1.434"	8.500"	2	Nylon	w/Air Brakes To W40,001	8519N
		1980-1983	1.434"	8.500"	2	Nylon	w/Hyd. Brakes	8519N
11,000		1971-1978	1.607"	8.812"	2	Metal	(Center Point Steering)	8514B
		1971-1978	1.607"	8.812"	2	Nylon	(Center Point Steering)	8514N
12,000		1973-1975	1.794"	9.120"	2	Metal	w/Air Brakes To W40,001	8489B
		1973-1979	1.794"	9.120"	2	Metal	w/Hyd. Brakes	8489B
		1970-1972	1.794"	9.120"	2	Metal		8489B
		1970-1978	1.607"	8.812"	2	Metal	(Center Point Steering)	8514B
		1975-1989	1.794"	10.070"	2	Metal	w/Air Brakes From W40,001	8572B
		1973-1975	1.794"	9.120"	2	Nylon	w/Air Brakes To W40,001	8489N
		1973-1979	1.794"	9.120"	2	Nylon	w/Hyd. Brakes	8489N
		1970-1972	1.794"	9.120"	2	Nylon		8489N
		1970-1978	1.607"	8.812"	2	Nylon	(Center Point Steering)	8514N
15,000		1962-1975	1.400/1.794"	10.688"	7	Metal		8474B
		1973-1975	1.400/1.794"	10.688"	7	Metal	w/Air Brakes To W40,001	8474B
		1973-1975	1.400/1.794"	10.688"	7	Metal	w/Hyd. Brakes	8474B
16,000		1975-1989	1.999"	11.212"	2	Metal	w/Air Brakes From W40,001	8571B
18,000		1975-1989	1.999"	11.212"	2	Metal		8571B

Tie Rod Ends

Axle Lbs. Rating	Code	Year	Length (Inches)	Notes	Tie Rod End Part No.	
					Drivers Side	Passenger Side
7,000		1980-1989	4.45"	w/Hyd. Brakes	ES373L	ES373R
		1980-1989	5.86"	w/Air Brakes	ES2035L	ES2036R
9,000		1973-1983	4.88"	w/Hyd. Brakes	ES187L	ES187R
		1973-1975	4.88"	w/Air Brakes To W40,001	ES187L	ES187R
		1970-1972	4.88"		ES187L	ES187R
		1975-1989	5.86"	w/Air Brakes From W40,001	ES2035L	ES2036R
12,000		1975-1989	5.44"	w/Air Brakes From W40,001	ES423L	ES423R
		1973-1979	5.75"	w/Hyd. Brakes	ES431L	ES431R
		1973-1975	5.75"	w/Air Brakes To W40,001	ES431L	ES431R
		1970-1972	5.75"		ES431L	ES431R
15,000		1973-1975	5.75"	w/Hyd. Brakes From W40,001	ES431L	ES431R
		1973-1975	5.75"	w/Air Brakes To W40,001	ES431L	ES431R
		1970-1972	5.75"		ES431L	ES431R
16,000		1975-1989	5.44"	w/Air Brakes From W40,001,1980-81 All Brakes	ES423L	ES423R
18,000		1975-1989	5.44"		ES423L	ES423R

Drag Links

Axle Lbs. Rating	Code	Year	Length (inches)	Notes	Drag Link No.
7,000		1980-1989	31.93"	w/Hyd. Brakes & Power Steering	DS944
			35.37"	w/Air Brakes & Power Steering	DS956
			37.07"	w/Air Brakes & Manual Steering	DS1035
9,000		1976-1979	35.37"	w/Integral Power Steering & Air Brakes	DS956
		1976-1983	35.61"	w/Integral Power Steering & Hyd. Brakes	DS955
		1980-1989	36.31"	w/Air Brakes & Integral Power Steering	DS943
			37.07"	w/Air Brakes & Manual Steering	DS1035
12,000		1976-1989	35.00"	w/Integral Power Steering & Air Brakes	DS1205
		1980-1981	37.07"	w/Air Brakes & Manual Steering	DS1035
16,000		1980-1989	35.00"	w/Air Brakes & Power Steering	DS1205
		1980-1981	37.07"	w/Air Brakes & Manual Steering	DS1035
18,000		1980-1989	35.00"	w/Air Brakes & Power Steering	DS1205

FORD TRUCK

C9000

Tie Rod Ends

Axle Lbs. Rating	Code	Year	Length (Inches)	Notes	Tie Rod End Part No.	
					Drivers Side	Passenger Side
10,000		1990-1990	5.44"		ES423L	ES423R
16,000		1964-1975	5.75"		ES431L	ES431R
18,000		1998-1998	7.18"		ES3284L	ES3283R
20,000		1998-1998	7.18"		ES3284L	ES3283R

C950, C1000

King Bolt Sets

Axle Lbs. Rating	Code	Year	Diameter (inches)	Length (Inches)	Pin Type	Bushing	Notes	King Pin Set No.
9,000		1964-1970	1.434"	8.500"	2	Metal		8519B
		1964-1970	1.444"	8.500"	2	Metal		8519B010
		1964-1970	1.434"	8.500"	2	Nylon		8519N
11,000		1964-1965	1.607"	8.812"	2	Metal	(Center Point Steering)	8514B
		1964-1965	1.607"	8.812"	2	Nylon	(Center Point Steering)	8514N
12,000		1964-1970	1.794"	9.120"	2	Metal	(Center Point Steering)	8489B
		1966-1970	1.607"	8.812"	2	Metal		8514B
		1964-1970	1.794"	9.120"	2	Nylon		8489N
		1966-1970	1.607"	8.812"	2	Nylon		8514N
15,000		1964-1970	1.400/1.794"	10.688"	7	Metal		8474B

Tie Rod Ends

Axle Lbs. Rating	Code	Year	Length (Inches)	Notes	Tie Rod End Part No.	
					Drivers Side	Passenger Side
9,000		1964-1970	4.88"		ES187L	ES187R
12,000		1964-1970	5.75"	Anti-Tilt Seal Type	ES346L	ES346R
15,000		1964-1970	5.75"	Anti-Tilt Seal Type	ES346L	ES346R

CF600

King Bolt Sets

Axle Lbs. Rating	Code	Year	Diameter (inches)	Length (Inches)	Pin Type	Bushing	Notes	King Pin Set No.
9,000		1989-1990	1.610"	9.080"	2	Composite	From 1/1989; w/Screw-in End Caps Until 1/1989	8641B
		1986-1989	1.607"	9.080"	2	Metal		8573B
11,000		1987-1989	1.794"	10.070"	2	Metal		8572B
12,000		1990-1998	1.743"	10.061"	2	Composite	w/Screw-in End Caps	80068C
		1989-1991	1.790"	10.070"	2	Composite		8643B
		1986-1988	1.794"	10.070"	2	Metal		8572B
13,000		1992-1991	1.743"	10.061"	2	Composite	w/Steel Axle	80068C
		1990-1991	1.790"	10.070"	2	Composite		8643B
		1987-1990	1.794"	10.070"	2	Metal		8572B

Tie Rod Ends

Axle Lbs. Rating	Code	Year	Length (Inches)	Notes	Tie Rod End Part No.	
					Drivers Side	Passenger Side
9,000		1990-1991	5.86"	Tube & Clamp Assy.	DS1362S	
		1990-1991			ES2035L	ES2036R
		1995-1998			ES3284L	ES3283R
12,000		1990-1991	5.44"	Tube & Clamp Assy. w/Steel Axle	DS1379S	
		1986-1998			DS1362S	
		1990-1991			ES423L	ES423R
		1986-1998			ES2035L	ES2036R
13,000		1990-1991	5.44"	Cross Tube Assy. w/ends Tube & Clamp Assy. w/Steel Axle	DS1367A	
		1990-1991			DS1367A	
		1990-1991			DS1379S	
		1992-1991			ES423L	ES423R
			6.00"		ES3177L	ES3176R

Drag Links

Axle Lbs. Rating	Code	Year	Length (inches)	Notes	Drag Link No.
9,000		1991-1991	37.13"		DS1234
12,000		1991-1991	37.13"		DS1234
13,000		1991-1991	37.13"		DS1234

CF700

King Bolt Sets

Axle Lbs. Rating	Code	Year	Diameter (inches)	Length (Inches)	Pin Type	Bushing	Notes	King Pin Set No.
9,000		1989-1997	1.610"	9.080"	2	Composite	From 1/1989 Until 1/1989	8641B
		1986-1989	1.607"	9.080"	2	Metal		8573B
11,000		1987-1989	1.794"	10.070"	2	Metal		8572B
12,000		1992-1997	1.743"	10.061"	2	Composite		80068C
		1989-1991	1.790"	10.070"	2	Composite		8643B
		1986-1988	1.794"	10.070"	2	Metal		8572B
13,000		1992-1997	1.743"	10.061"	2	Composite	w/Steel Axle	80068C
		1990-1991	1.790"	10.070"	2	Composite		8643B
		1987-1990	1.794"	10.070"	2	Metal		8572B

Tie Rod Ends

Axle Lbs. Rating	Code	Year	Length (Inches)	Notes	Tie Rod End Part No.	
					Drivers Side	Passenger Side
9,000		1990-1994	5.86" 7.18"	Tube & Clamp Assy.	DS1362S	
		1990-1994			ES2035L	ES2036R
		1995-1997			ES3284L	ES3283R
12,000		1990-1991	5.44" 6.00" 7.38"	Cross Tube Assy. w/ends Tube & Clamp Assy. w/Steel Axle	DS1367A	
		1990-1991			DS1379S	
		1990-1997			ES423L	ES423R
		1992-1994			ES3177L	ES3176R
		1995-1997			ES3443L	ES3442R
13,000		1990-1991	5.44" 6.00"	Cross Tube Assy. w/ends Tube & Clamp Assy. w/Steel Axle Until 7/1993	DS1367A	
		1990-1991			DS1379S	
		1990-1997			ES423L	ES423R
		1992-1993			ES3177L	ES3176R

Drag Links

Axle Lbs. Rating	Code	Year	Length (inches)	Notes	Drag Link No.
9,000		1991-1996	37.13"		DS1234
12,000		1991-1996	37.13"		DS1234
13,000		1991-1996	37.13"		DS1234

CF800, CFT800

King Bolt Sets

Axle Lbs. Rating	Code	Year	Diameter (inches)	Length (Inches)	Pin Type	Bushing	Notes	King Pin Set No.
9,000		1989-1997	1.610"	9.080"	2	Composite	From 1/1989 Until 1/1989	8641B
		1986-1989	1.607"	9.080"	2	Metal		8573B
11,000		1987-1989	1.794"	10.070"	2	Metal		8572B
12,000		1992-1997	1.743"	10.061"	2	Composite	w/Screw-in End Caps	80068C
		1989-1991	1.790"	10.070"	2	Composite		8643B
		1986-1988	1.794"	10.070"	2	Metal		8572B
13,000		1992-1997	1.743"	10.061"	2	Composite	w/Steel Axle	80068C
		1990-1991	1.790"	10.070"	2	Composite		8643B
		1987-1990	1.794"	10.070"	2	Metal		8572B

Tie Rod Ends

Axle Lbs. Rating	Code	Year	Length (Inches)	Notes	Tie Rod End Part No.	
					Drivers Side	Passenger Side
9,000		1990-1994	5.86" 7.18"	Tube & Clamp Assy.	DS1362S	
		1990-1994			ES2035L	ES2036R
		1995-1997			ES3284L	ES3283R
12,000		1990-1991	5.44" 6.00" 7.38"	Tube & Clamp Assy. w/Steel Axle	DS1379S	
		1990-1995			ES423L	ES423R
		1992-1994			ES3177L	ES3176R
		1995-1997			ES3443L	ES3442R
13,000		1990-1991	5.44" 6.00" 7.38"	Cross Tube Assy. w/ends Tube & Clamp Assy. w/Steel Axle	DS1367A	
		1990-1991			DS1379S	
		1990-1997			ES423L	ES423R
		1992-1993			ES3177L	ES3176R
		1995-1997			ES3443L	ES3442R

FORD TRUCK

CF800, CFT800 (Cont'd)

Drag Links

Axle Lbs. Rating	Code	Year	Length (inches)	Notes	Drag Link No.
9,000		1991-1994	37.13"		DS1234
12,000		1991-1994	37.13"		DS1234
13,000		1991-1994	37.13"		DS1234

CL900, CLT900, CL9000, CLT9000

King Bolt Sets

Axle Lbs. Rating	Code	Year	Diameter (inches)	Length (Inches)	Pin Type	Bushing	Notes	King Pin Set No.
11,000		1987-1989	1.794"	10.070"	2	Metal	w/Steel or Aluminum Axle	8572B
12,000		1990-1991	1.743"	10.061"	2	Composite	w/Aluminum Axle	80068C
		1989-1991	1.790"	10.070"	2	Composite	w/Steel Axle & Screw-in End Caps	8643B
		1987-1988	1.794"	10.070"	2	Metal	w/Steel or Aluminum Axle	8572B
		1978-1986	1.794"	10.070"	2	Metal	w/Steel Axle	8572B
		1978-1986	1.794"	10.070"	2	Metal	w/Aluminum Axle	8585B

Tie Rod Ends

Axle Lbs. Rating	Code	Year	Length (Inches)	Notes	Tie Rod End Part No.	
					Drivers Side	Passenger Side
11,000		1987-1989	5.44"	w/Steel & Aluminum Axles	ES423L	ES423R
12,000		1978-1991	5.44"	Cross Tube Assy. w/ends	DS1367A	
		1978-1991		w/Steel & Aluminum Axles	ES423L	ES423R

Drag Links

Axle Lbs. Rating	Code	Year	Length (inches)	Notes	Drag Link No.
11,000		1987-1989	19.88"	w/Steel & Aluminum Axles	DS958
12,000		1978-1991	19.88"	w/Steel & Aluminum Axles	DS958

CT800

King Bolt Sets

Axle Lbs. Rating	Code	Year	Diameter (inches)	Length (Inches)	Pin Type	Bushing	Notes	King Pin Set No.
7,000		1980-1989	1.231"	8.910"	4	Metal	w/Hyd. Brakes	8500B
		1980-1989	1.241"	8.910"	4	Metal		8500B010
		1980-1990	1.433"	8.250"	2	Metal	w/Air Brakes	8568B
		1980-1989	1.231"	8.910"	4	Nylon		8500N
9,000		1962-1972	1.434"	8.500"	2	Metal	w/Hyd. Brakes	8519B
		1980-1983	1.434"	8.500"	2	Metal		8519B
		1962-1972	1.444"	8.500"	2	Metal		8519B010
		1980-1983	1.444"	8.500"	2	Metal	w/Air Brakes	8519B010
		1987-1989	1.433"	8.250"	2	Metal		8568B
		1990-1990	1.607"	9.080"	2	Metal		8573B
		1980-1986	1.607"	9.080"	2	Metal		8573B
		1962-1972	1.434"	8.500"	2	Nylon		8519N
		1980-1983	1.434"	8.500"	2	Nylon		8519N
11,000		1964-1972	1.607"	8.812"	2	Metal	(Center Point Steering)	8514B
		1964-1972	1.607"	8.812"	2	Nylon	(Center Point Steering)	8514N
12,000		1973-1975	1.794"	9.120"	2	Metal	w/Air Brakes To W40,001	8489B
		1962-1979	1.794"	9.120"	2	Metal	w/Hyd. Brakes From 1973	8489B
		1966-1975	1.607"	8.812"	2	Metal	(Center Point Steering)	8514B
		1980-1990	1.794"	10.070"	2	Metal	Exc. Aluminum Axle	8572B
		1975-1979	1.607"	9.080"	2	Metal	w/Air Brakes From W40,001	8573B
		1973-1975	1.794"	9.120"	2	Nylon	w/Air Brakes To W40,001	8489N
		1962-1979	1.794"	9.120"	2	Nylon	w/Hyd. Brakes From 1973	8489N
		1966-1975	1.607"	8.812"	2	Nylon	(Center Point Steering)	8514N
15,000		1973-1975	1.400/1.794"	10.688"	7	Metal	w/Air Brakes; To W40,001	8474B
		1964-1979	1.400/1.794"	10.688"	7	Metal	w/Hyd. Brakes From 1973	8474B
		1975-1979	1.999"	11.212"	2	Metal	w/Air Brakes From W40,001	8571B
16,000		1980-1990	1.999"	11.212"	2	Metal	w/Air Brakes From W40,001	8571B
18,000		1975-1990	1.999"	11.212"	2	Metal		8571B

Tie Rod Ends

Axle Lbs. Rating	Code	Year	Length (Inches)	Notes	Tie Rod End Part No.	
					Drivers Side	Passenger Side
7,000		1980-1989	4.45"	w/Hyd. Brakes	ES373L	ES373R

CT800 (Cont'd)

Tie Rod Ends (Cont'd)

Axle Lbs. Rating	Code	Year	Length (Inches)	Notes	Tie Rod End Part No.	
					Drivers Side	Passenger Side
7,000		1980-1989	5.86"	w/Air Brakes	ES2035L	ES2036R
9,000		1980-1983	4.88"	w/Hyd. Brakes	ES187L	ES187R
		1962-1972	4.88"		ES187L	ES187R
		1980-1989	5.86"	w/Air Brakes	ES2035L	ES2036R
		1990-1990	5.86"		ES2035L	ES2036R
11,000		1990-1990	5.44"	w/Aluminum Axle	ES423L	ES423R
12,000		1980-1990		Cross Tube Assy. w/ends	DS1367A	
		1980-1990	5.44"		ES423L	ES423R
		1975-1979	5.44"	w/Air Brakes From W40,001	ES423L	ES423R
		1962-1970	5.75"	To G70,001	ES346L	ES346R
		1970-1979	5.75"	From G70,001	ES431L	ES431R
		1973-1975	5.75"	w/Air Brakes To W40,001	ES431L	ES431R
15,000		1975-1979	5.44"	w/Air Brakes From W40,001	ES423L	ES423R
		1973-1975	5.75"	w/Hyd. Brakes	ES431L	ES431R
		1973-1975	5.75"	w/Air Brakes To W40,001	ES431L	ES431R
		1964-1972	5.75"		ES431L	ES431R
16,000		1980-1990	5.44"		ES423L	ES423R
18,000		1975-1990	5.44"	From W40,001	ES423L	ES423R

Drag Links

Axle Lbs. Rating	Code	Year	Length (inches)	Notes	Drag Link No.
7,000		1980-1990	31.93"	w/Hyd. Brakes & Power Strg.	DS944
			35.37"	w/Air Brakes & Power Steering	DS956
			37.07"	w/Air Brakes & Manual Steering	DS1035
9,000		1980-1989	36.31"	w/Air Brakes & Power Steering	DS943
		1990-1990	37.07"	w/Air Brakes & Manual Steering	DS1035
			35.61"	w/Power Steering	DS1206 DS955
12,000		1976-1979	35.00"	w/Integral Power Steering	DS1205
		1980-1990		w/Integral Power Steering & Air Brakes	
		1980-1986	37.07"	w/Air Brakes & Manual Steering	DS1035
		1990-1990	35.00"		DS1205
16,000		1976-1979	35.00"	w/Integral Power Steering	DS1205
		1980-1989		w/Integral Power Steering & Air Brakes	
		1980-1986	37.07"	w/Air Brakes & Manual Steering	DS1035
		1990-1990	35.00"		DS1205
18,000		1976-1979	35.00"	w/Integral Power Steering	DS1205
		1980-1989		w/Integral Power Steering & Air Brakes	
		1980-1986	37.07"	w/Air Brakes & Manual Steering	DS1035
		1990-1990	35.00"		DS1205

CT850, CT950

King Bolt Sets

Axle Lbs. Rating	Code	Year	Diameter (inches)	Length (Inches)	Pin Type	Bushing	Notes	King Pin Set No.
9,000		1962-1972	1.434"	8.500"	2	Metal		8519B
		1962-1972	1.444"	8.500"	2	Metal		8519B010
		1962-1972	1.434"	8.500"	2	Nylon		8519N
11,000		1962-1972	1.607"	8.812"	2	Metal	(Center Point Steering)	8514B
		1962-1972	1.607"	8.812"	2	Nylon	(Center Point Steering)	8514N
12,000		1962-1972	1.794"	9.120"	2	Metal		8489B
		1966-1972	1.607"	8.812"	2	Metal	(Center Point Steering)	8514B
		1962-1972	1.794"	9.120"	2	Nylon		8489N
		1966-1972	1.607"	8.812"	2	Nylon	(Center Point Steering)	8514N
15,000		1962-1972	1.400/1.794"	10.688"	7	Metal		8474B

Tie Rod Ends

Axle Lbs. Rating	Code	Year	Length (Inches)	Notes	Tie Rod End Part No.	
					Drivers Side	Passenger Side
9,000		1962-1972	4.88"		ES187L	ES187R
12,000		1970-1972	5.75"	From G70,001	ES431L	ES431R
		1962-1970	5.75"	To G70,001	ES346L	ES346R
15,000		1970-1972	5.75"	From G70,001	ES431L	ES431R
		1962-1970	5.75"	To G70,001	ES346L	ES346R

CT900						
Tie Rod Ends						
Axle Lbs. Rating	Code	Year	Length (Inches)	Notes	Tie Rod End Part No.	
					Drivers Side	Passenger Side
10,000		1990-1990	5.44"		ES423L	ES423R
16,000		1964-1975	5.75"		ES431L	ES431R
18,000		1998-1998	7.18"		ES3284L	ES3283R
20,000		1998-1998	7.18"		ES3284L	ES3283R

F1000								
King Bolt Sets								
Axle Lbs. Rating	Code	Year	Diameter (inches)	Length (Inches)	Pin Type	Bushing	Notes	King Pin Set No.
9,000		1962-1969	1.434"	8.500"	2	Metal		8519B
		1962-1969	1.444"	8.500"	2	Metal		8519B010
		1962-1969	1.434"	8.500"	2	Nylon		8519N
11,000		1964-1965	1.607"	8.812"	2	Metal	(Center Point Steering)	8514B
		1964-1965	1.607"	8.812"	2	Nylon	(Center Point Steering)	8514N
12,000		1962-1969	1.794"	9.120"	2	Metal	(Center Point Steering)	8489B
		1966-1969	1.607"	8.812"	2	Metal		8514B
		1962-1969	1.794"	9.120"	2	Nylon		8489N
		1966-1969	1.607"	8.812"	2	Nylon		8514N
15,000		1962-1969	1.400/1.794"	10.688"	7	Metal		8474B

Tie Rod Ends						
Axle Lbs. Rating	Code	Year	Length (Inches)	Notes	Tie Rod End Part No.	
					Drivers Side	Passenger Side
9,000		1962-1969	4.88"		ES187L	ES187R
12,000		1962-1969	5.75"	Anti-Tilt Seal Type	ES346L	ES346R
15,000		1962-1969	5.75"	Anti-Tilt Seal Type	ES346L	ES346R

F1100								
King Bolt Sets								
Axle Lbs. Rating	Code	Year	Diameter (inches)	Length (Inches)	Pin Type	Bushing	Notes	King Pin Set No.
9,000		1962-1965	1.434"	8.500"	2	Metal		8519B
		1962-1965	1.444"	8.500"	2	Metal		8519B010
		1962-1965	1.434"	8.500"	2	Nylon		8519N
11,000		1964-1965	1.607"	8.812"	2	Metal	(Center Point Steering)	8514B
		1964-1965	1.607"	8.812"	2	Nylon	(Center Point Steering)	8514N
12,000		1962-1965	1.794"	9.120"	2	Metal		8489B
		1962-1965	1.794"	9.120"	2	Nylon		8489N
15,000		1962-1965	1.400/1.794"	10.688"	7	Metal		8474B

Tie Rod Ends						
Axle Lbs. Rating	Code	Year	Length (Inches)	Notes	Tie Rod End Part No.	
					Drivers Side	Passenger Side
9,000		1962-1965	4.88"		ES187L	ES187R
12,000		1962-1965	5.75"	Anti-Tilt Seal Type	ES346L	ES346R
15,000		1962-1965	5.75"	Anti-Tilt Seal Type	ES346L	ES346R

F4								
King Bolt Sets								
Axle Lbs. Rating	Code	Year	Diameter (inches)	Length (Inches)	Pin Type	Bushing	Notes	King Pin Set No.
		1948-1952	1.129"	6.940"	1	Metal		8426B

Tie Rod Ends						
Axle Lbs. Rating	Code	Year	Length (Inches)	Notes	Tie Rod End Part No.	
					Drivers Side	Passenger Side
		1948-1952	3.50"		ES150L	ES150R

F600

King Bolt Sets

Axle Lbs. Rating	Code	Year	Diameter (inches)	Length (Inches)	Pin Type	Bushing	Notes	King Pin Set No.
8,500		2000-2004	1.359"	8.07"	9	Composite	Double Draw Keys on Same Side	8001C
9,000		1973-1975	1.434"	8.500"	2	Metal		8519B
		1973-1975	1.434"	8.500"	2	Nylon		8519N
10,000		1973-1979	1.434"	8.500"	2	Metal		8519B
		1973-1979	1.434"	8.500"	2	Nylon		8519N
12,000		1990-1998	1.743"	10.061"	2	Composite		80068C
14,600		1995-1998	1.812"	10.542"	2	Metal		80069B

Tie Rod Ends

Axle Lbs. Rating	Code	Year	Length (Inches)	Notes	Tie Rod End Part No.	
					Drivers Side	Passenger Side
6,000		1995-1999	6.00"		ES3177L	ES3176R
7,000		1995-1999	6.00"		ES3177L	ES3176R
8,000		1995-1999	7.18"		ES3284L	ES3283R
9,000		1973-1979	4.88"	w/Hydraulic Brakes	ES187L	ES187R
		1973-1975	4.88"	w/Air Brakes	ES187L	ES187R
		1995-1998	7.18"	w/Air Brakes	ES3284L	ES3283R
12,000		1995-1999	7.38"		ES3443L	ES3442R
14,600		1995-1998	6.00"		ES3177L	ES3176R

Drag Links

Axle Lbs. Rating	Code	Year	Length (inches)	Notes	Drag Link No.
10,000		1995-1998	18.47"	w/Full Tapered Springs	DS1370
			19.01"	w/Multileaf Springs	DS1371
12,000		1995-1998	18.47"	w/Full Tapered Springs	DS1370
			19.01"	w/Multileaf Springs	DS1371
14,600		1995-1997	18.47"		DS1370

F600, FT600

King Bolt Sets

Axle Lbs. Rating	Code	Year	Diameter (inches)	Length (Inches)	Pin Type	Bushing	Notes	King Pin Set No.
4,700		1957-1962	1.129"	7.670"	4	Metal	w/Ball Bearing Type Thrust Brg.	8459B
		1957-1962	1.129"	7.670"	4	Metal	w/Multi-washer Type Thrust Brg.	8471B
5,000		1961-1979	1.231"	7.860"	4	Metal		8488B
		1961-1979	1.241"	7.860"	4	Metal		8488B010
		1961-1979	1.231"	7.860"	1	Metal	Heavy Duty	8609B
5,500		1963-1986	1.231"	7.860"	4	Metal		8488B
		1963-1986	1.241"	7.860"	4	Metal		8488B010
		1963-1986	1.231"	7.860"	1	Metal	Heavy Duty	8609B
6,000		1957-1966	1.234"	7.500"	1	Metal		8357B
		1967-1979	1.231"	8.910"	4	Metal		8500B
		1984-1988	1.231"	8.910"	4	Metal		8500B
		1984-1988	1.241"	8.910"	4	Metal		8500B010
		1967-1979	1.241"	8.910"	4	Metal		8500B010
		1989-1994	1.300"	7.757"	2	Metal		8639B
		1957-1966	1.234"	7.500"	1	Nylon		8357N
		1984-1988	1.231"	8.910"	4	Nylon		8500N
		1967-1979	1.231"	8.910"	4	Nylon		8500N
7,000		1961-1966	1.234"	7.440"	2	Metal		8479B
		1980-1988	1.231"	8.910"	4	Metal	w/Hyd. Brakes To W40,001	8500B
		1967-1975	1.231"	8.910"	4	Metal		8500B
		1980-1988	1.241"	8.910"	4	Metal	w/Hyd. Brakes To W40,001	8500B010
		1967-1975	1.241"	8.910"	4	Metal		8500B010
		1961-1966	1.244"	7.440"	2	Metal		8507B010
		1975-1988	1.433"	8.250"	2	Metal	From W40,001 & w/Air Brakes	8568B
		1989-1994	1.300"	7.757"	2	Metal	w/Hyd. Brakes	8639B
		1961-1966	1.234"	7.440"	2	Nylon		8479N
		1980-1988	1.231"	8.910"	4	Nylon	w/Hyd. Brakes To W40,001	8500N
1967-1975	1.231"	8.910"	4	Nylon		8500N		
8,000		1987-1990	1.433"	8.250"	2	Metal	w/Air Brakes	8568B
		1991-1994	1.435"	8.240"	2	Metal		8653B
9,000		1980-1990	1.433"	8.250"	2	Metal	w/Air Brakes	8568B
		1983-1990	1.607"	9.080"	2	Metal	Heavy Duty w/Air Brakes	8573B

FORD TRUCK



F600, FT600 (Cont'd)

King Bolt Sets (Cont'd)

Axle Lbs. Rating	Code	Year	Diameter (inches)	Length (Inches)	Pin Type	Bushing	Notes	King Pin Set No.
9,000		1991-1994	1.435"	8.240"	2	Metal		8653B
10,000		1990-1994	1.743"	10.061"	2	Composite	w/Steel Axle Exc. Alum. Axle	80068C
		1990-1994	1.790"	10.070"	2	Composite		8643B
		1987-1990	1.794"	10.070"	2	Metal		8572B
		1989-1994	1.790"	10.070"	2	Composite		8643B
12,000		1982-1988	1.794"	10.070"	2	Metal	From 3/1982	8572B

Tie Rod Ends

Axle Lbs. Rating	Code	Year	Length (Inches)	Notes	Tie Rod End Part No.	
					Drivers Side	Passenger Side
4,700		1957-1962	3.50"		ES150L	ES150R
5,000		1953-1966	3.50"	w/Manual Steering	ES150L	ES150R
		1967-1979	4.45"		ES373L	ES373R
5,500		1963-1966	3.50"	w/Manual Steering	ES150L	ES150R
		1967-1986	4.45"		ES373L	ES373R
6,000		1990-1993	13.25"	w/Hyd. Brakes & Low Profile Option	ES3039L	ES3040R
		1957-1966	3.75"		ES194L	ES194R
		1961-1966	4.44"		ES2083L	ES2082R
		1967-1990	4.45"		ES373L	ES373R
		1990-1990	4.93"	Exc. Low Profile Option	ES2061L	ES2062R
		1990-1994	5.86"		ES2035L	ES2036R
7,000		1990-1993	13.25"	w/Hyd. Brakes & Low Profile Option	ES3039L	ES3040R
		1961-1966	3.90"		ES304L	ES304R
		1967-1988	4.45"	w/Hyd. Brakes	ES373L	ES373R
		1973-1975	4.45"	w/Air Brakes To W40,001	ES373L	ES373R
		1989-1990	4.45"	Exc. Low Profile Option	ES373L	ES373R
		1975-1988	5.86"	w/Air Brakes From W40,001	ES2036R	ES2035L
		1990-1994	5.86"		ES2035L	ES2036R
8,000		1987-1989	5.86"		ES2035L	ES2036R
		1990-1994	5.86"		ES2035L	ES2036R
9,000		1990-1994	5.86"		ES2035L	ES2036R
		1980-1989	5.86"		ES2035L	ES2036R
10,000		1987-1991		Cross Tube Assy. w/ends	DS1367A	
		1990-1991		Tube & Clamp Assy.	DS1379S	
		1987-1991	5.44"		ES423L	ES423R
		1992-1994	6.00"		ES3177L	ES3176R
12,000		1990-1991		Tube & Clamp Assy.	DS1379S	
		1982-1991		From 3/1982; Cross Tube Assy. w/ends	DS1367A	
		1982-1991	5.44"	From 3/1982	ES423L	ES423R
		1992-1994	6.00"		ES3177L	ES3176R

Drag Links

Axle Lbs. Rating	Code	Year	Length (inches)	Notes	Drag Link No.	
4,700		1961-1962	15.32"	w/Manual Steering	DS659	
5,000		1963-1966	15.32"	w/Manual Steering	DS659	
		1967-1979	16.64"		DS800	
5,500		1963-1966	15.32"	w/Manual Steering	DS659	
		1967-1979	16.64"		DS800	
		1980-1985	19.25"		DS948	
6,000		1960-1966	16.25"	w/Manual Steering	DS733	
		1967-1979	16.16"	w/Power Steering	DS803	
			16.64"	w/Manual Steering	DS800	
		1980-1988	19.25"		DS948	
		1989-1992	20.66"		DS1191	
		1993-1994	20.44"		DS1259	
7,000		1963-1966	16.25"	w/Manual Steering	DS733	
		1967-1979	16.16"	w/Power Steering	DS803	
			16.64"	w/Manual Steering	DS800	
		1975-1979	15.85"	From W40,001	DS945	
		1980-1988	19.25"		DS948	
		1989-1992	20.66"	w/Hyd. Brakes	DS1191	
		1993-1994	20.44"		DS1259	
		1995-1995	21.20"		DS1366	
	8,000		1988-1994	20.30"		DS1192
			1992-1993	19.47"	Before 5/1993	DS1271
		1993-1994	19.43"	After 5/1993	DS1369	
9,000		1980-1987	19.23"		DS949	

F600, FT600 (Cont'd)

Drag Links (Cont'd)

Axle Lbs. Rating	Code	Year	Length (inches)	Notes	Drag Link No.
9,000		1988-1992	20.30"	Before 5/1993 After 5/1993	DS1192
		1992-1993	19.47"		DS1271
		1993-1994	19.43"		DS1369
10,000		1987-1991	19.23"		DS1204
		1992-1994	19.43"		DS1272
12,000		1982-1991	19.23"	From 3/1982	DS1204
		1992-1994	19.43"		DS1272

F700

Tie Rod Ends

Axle Lbs. Rating	Code	Year	Length (Inches)	Notes	Tie Rod End Part No.	
					Drivers Side	Passenger Side
6,000		1995-1999	6.00"		ES3177L	ES3176R
7,000		1995-1999	6.00"		ES3177L	ES3176R
8,000		1995-1999	7.18"		ES3284L	ES3283R
8,500		1995-1999	7.18"		ES3284L	ES3283R
9,000		1995-1998	7.18"		ES3284L	ES3283R

Drag Links

Axle Lbs. Rating	Code	Year	Length (inches)	Notes	Drag Link No.
6,000		1998-1998	19.29"	from Dec. 1987	DS1190
7,000		1998-1998	19.29"		DS1190
9,000		1975-1979	16.64"	w/Hydraulic Brakes	DS800

F700, FT700

King Bolt Sets

Axle Lbs. Rating	Code	Year	Diameter (inches)	Length (Inches)	Pin Type	Bushing	Notes	King Pin Set No.
5,000		1961-1979	1.231"	7.860"	4	Metal	Heavy Duty	8488B
		1961-1979	1.241"	7.860"	4	Metal		8488B010
		1961-1979	1.231"	7.860"	1	Metal		8609B
5,500		1961-1986	1.231"	7.860"	4	Metal	Heavy Duty	8488B
		1961-1986	1.241"	7.860"	4	Metal		8488B010
		1961-1986	1.231"	7.860"	1	Metal		8609B
6,000		1961-1966	1.234"	7.500"	1	Metal	To C70,001	8357B
		1967-1988	1.231"	8.910"	4	Metal	From C70,001	8500B
		1967-1988	1.241"	8.910"	4	Metal	From C70,001	8500B010
		1989-1998	1.300"	7.757"	2	Metal		8639B
		1989-1990	1.300"	7.757"	2	Metal	Heavy Duty	8639B
		1961-1966	1.234"	7.500"	1	Nylon	To C70,001	8357N
		1967-1988	1.231"	8.910"	4	Nylon	From C70,001	8500N
7,000		1948-1959	1.234"	7.500"	1	Metal	To G90,001	8357B
		1960-1970	1.234"	7.440"	2	Metal		8479B
		1970-1988	1.231"	8.910"	4	Metal	w/Hyd. Brakes From G90,001	8500B
		1973-1975	1.231"	8.910"	4	Metal	w/Air Brakes To W40,001	8500B
		1973-1975	1.241"	8.910"	4	Metal	w/Air Brakes To W40,001	8500B010
		1970-1988	1.241"	8.910"	4	Metal	w/Hyd. Brakes From G90,001	8500B010
		1960-1970	1.244"	7.440"	2	Metal	To G90,001	8507B010
		1975-1988	1.433"	8.250"	2	Metal	w/Air Brakes From W40,001	8568B
		1989-1998	1.300"	7.757"	2	Metal		8639B
		1948-1959	1.234"	7.500"	1	Nylon		8357N
		1960-1970	1.234"	7.440"	2	Nylon	To G90,001	8479N
		1970-1988	1.231"	8.910"	4	Nylon	w/Hyd. Brakes From G90,001	8500N
		1973-1975	1.231"	8.910"	4	Nylon	w/Air Brakes To W40,001	8500N
8,000		1987-1990	1.433"	8.250"	2	Metal		8568B
		1991-1998	1.435"	8.240"	2	Metal		8653B
9,000		1968-1979	1.434"	8.500"	2	Metal	w/Hyd. Brakes From 1973	8519B
		1973-1975	1.434"	8.500"	2	Metal	w/Air Brakes To W40,001	8519B
		1968-1979	1.444"	8.500"	2	Metal	w/Hyd. Brakes From 1973	8519B010
		1973-1975	1.444"	8.500"	2	Metal	w/Air Brakes To W40,001	8519B010
		1975-1990	1.433"	8.250"	2	Metal	w/Air Brakes From W40,001; 1980-84 All Br	8568B
		1983-1986	1.607"	9.080"	2	Metal	Heavy Duty w/Air Brakes	8573B
		1991-1998	1.435"	8.240"	2	Metal		8653B
		1973-1975	1.434"	8.500"	2	Nylon	w/Air Brakes To W40,001	8519N
		1968-1979	1.434"	8.500"	2	Nylon	w/Hyd. Brakes From 1973	8519N
10,000		1990-1998	1.743"	10.061"	2	Composite	w/Aluminum Axle	80068C

FORD TRUCK

F700, FT700 (Cont'd)

King Bolt Sets (Cont'd)

Axle Lbs. Rating	Code	Year	Diameter (inches)	Length (Inches)	Pin Type	Bushing	Notes	King Pin Set No.
10,000		1990-1998	1.790"	10.070"	2	Composite	w/Steel Axle	8643B
		1987-1990	1.794"	10.070"	2	Metal		8572B
		1987-1990	1.794"	10.070"	2	Metal	Exc. Aluminum Axle	8572B
12,000		1989-1998	1.790"	10.070"	2	Composite		8643B
		1982-1988	1.794"	10.070"	2	Metal	From 3/1982	8572B
14,600		1995-1998	1.812"	10.542"	2	Metal		80069B

Tie Rod Ends

Axle Lbs. Rating	Code	Year	Length (Inches)	Notes	Tie Rod End Part No.	
					Drivers Side	Passenger Side
5,000		1961-1966	3.50"	w/Manual Steering	ES150L	ES150R
		1967-1979	4.45"		ES373L	ES373R
5,500		1961-1966	3.50"	w/Manual Steering	ES150L	ES150R
		1967-1986	4.45"		ES373L	ES373R
6,000		1995-1998		Tube & Clamp Assy. Use w/ES3284L & ES3283R w/Hyd. Brakes & Low Profile Option	DS1363S	
		1990-1998	13.25"		ES3039L	ES3040R
		1961-1966	4.44"		ES2083L	ES2082R
		1967-1998	4.45"		ES373L	ES373R
		1990-1998	4.93"		ES2061L	ES2062R
		1990-1998	5.86"		ES2035L	ES2036R
7,000		1995-1998	7.18"	Tube & Clamp Assy. Use w/ES3284L & ES3283R w/Hyd. Brakes & Low Profile Option	DS1363S	
		1990-1998	13.25"		ES3039L	ES3040R
		1953-1959	3.75"		ES194L	ES194R
		1961-1966	3.90"		ES304L	ES304R
		1973-1975	4.45"		ES373L	ES373R
		1967-1998	4.45"		ES373L	ES373R
		1975-1988	5.86"		ES2036R	ES2035L
		1990-1998	5.86"		ES2035L	ES2036R
8,000		1987-1989	5.86"		ES2036R	ES2035L
		1990-1998	5.86"		ES2036R	ES2035L
9,000		1968-1979	4.88"	w/Manual Steering w/Hyd. Brakes w/Air Brakes To W40,001	ES187L	ES187R
		1973-1979	4.88"		ES187L	ES187R
		1973-1975	4.88"		ES187L	ES187R
		1968-1972	4.88"		ES187L	ES187R
		1973-1975	4.88"		ES187L	ES187R
		1975-1998	5.86"		ES2036R	ES2035L
10,000		1990-1998		Tube & Clamp Assy.	DS1379S	
		1987-1998	5.44"		ES423L	ES423R
		1992-1998	6.00"		ES3177L	ES3176R
12,000		1990-1991		Tube & Clamp Assy. From 3/1982; Cross Tube Assy. w/ends	DS1379S	
		1982-1995			DS1367A	
		1982-1995	5.44"		ES423L	ES423R
		1992-1998	6.00"		ES3177L	ES3176R
14,600		1995-1998	7.38"	w/Steel Axle	ES3443L	ES3442R
		1995-1998	6.00"		DS1368A	
					ES3177L	ES3176R

Drag Links

Axle Lbs. Rating	Code	Year	Length (inches)	Notes	Drag Link No.
5,000		1967-1979	16.64"		DS800
5,500		1967-1979	16.64"		DS800
		1980-1986	19.25"		DS948
6,000		1967-1968	16.64"	w/Power Steering w/Manual Steering w/Power Steering w/Power Steering To W40,001	DS800
		1967-1972			DS803
		1969-1972	16.16"		
		1973-1975	16.64"		
		1973-1979	16.64"		
		1984-1988	19.25"		
		1989-1992	20.66"		
7,000		1992-1994	20.44"		DS1191
		1995-1995	21.20"		DS1259
7,000		1967-1975	16.64"	w/Manual Steering To W20,001 w/Power Steering	DS1366
		1967-1968			DS800
		1969-1975	16.16"		DS803

F700, FT700 (Cont'd)

Drag Links (Cont'd)

Axle Lbs. Rating	Code	Year	Length (inches)	Notes	Drag Link No.	
					Drivers Side	Passenger Side
7.000		1975-1979	15.85"	From W40,001 w/Manual Steering To W20,001	DS945	
		1980-1990	19.25"		DS948	
		1989-1992	20.66"		DS1191	
		1992-1994	20.44"		DS1259	
		1995-1995	21.20"		DS1366	
8.000		1988-1994	20.30"	Before 5/1993 After 5/1993	DS1192	
		1992-1993	19.47"		DS1271	
		1993-1998	19.43"		DS1369	
9.000		1973-1975	15.37"	w/Power Steering To W40,001 w/Manual Steering To W20,001 From W40,001	DS873	
			17.02"		DS872	
		1975-1979	16.49"		DS952	
		1980-1987	19.23"		DS949	
		1988-1992	20.30"		DS1192	
		1992-1993	19.47"		DS1271	
		1993-1998	19.43"		DS1369	
10.000		1987-1991	19.23"	Taper, w/SPR Cap MUL, SPR Cap	DS1204	
		1992-1994	19.43"		DS1272	
		1995-1995	18.47"		DS1370	
			19.01"		DS1371	
12.000		1982-1991	19.23"	From 3/1982 Taper, w/SPR Cap MUL, SPR Cap	DS1204	
		1992-1994	19.43"		DS1272	
		1995-1995	18.47"		DS1370	
			19.01"		DS1371	
14.600		1995-1995	18.47"	Drag Link Assv.	DS1370	

F750

King Bolt Sets

Axle Lbs. Rating	Code	Year	Diameter (inches)	Length (Inches)	Pin Type	Bushing	Notes	King Pin Set No.	
								Drivers Side	Passenger Side
7,000		1960-1970	1.234"	7.440"	2	Metal	To G90,001	8479B	
		1973-1975	1.231"	8.910"	4	Metal	w/Air Brakes To W40,001	8500B	
		1970-1977	1.231"	8.910"	4	Metal	w/Hyd. Brakes From G90,001	8500B	
		1973-1975	1.241"	8.910"	4	Metal	w/Air Brakes To W40,001	8500B010	
		1970-1977	1.241"	8.910"	4	Metal	w/Hyd. Brakes From G90,001	8500B010	
		1960-1970	1.244"	7.440"	2	Metal	To G90,001	8507B010	
		1960-1970	1.234"	7.440"	2	Nylon	To G90,001	8479N	
		1973-1975	1.231"	8.910"	4	Nylon	w/Air Brakes To W40,001	8500N	
		1970-1977	1.231"	8.910"	4	Nylon	w/Hyd. Brakes From G90,001	8500N	
9,000		1973-1975	1.434"	8.500"	2	Metal	w/Air Brakes To W40,001	8519B	
		1973-1975	1.444"	8.500"	2	Metal	w/Air Brakes To W40,001	8519B010	
		1975-1977	1.433"	8.250"	2	Metal	w/Air Brakes From W40,001	8568B	
		1973-1975	1.434"	8.500"	2	Nylon	w/Air Brakes To W40,001	8519N	

Tie Rod Ends

Axle Lbs. Rating	Code	Year	Length (Inches)	Notes	Tie Rod End Part No.	
					Drivers Side	Passenger Side
7,000		1961-1966	3.90"	w/Air Brakes To W40,001 w/Hyd. Brakes	ES304L	ES304R
		1973-1975	4.45"		ES373L	ES373R
		1967-1977	4.45"		ES373L	ES373R
9,000		1973-1975	4.88"	w/Manual Steering Only w/Air Brakes To W40,001 w/Air Brakes From W40,001	ES187L	ES187R
		1973-1975	4.88"		ES187L	ES187R
		1975-1977	5.86"		ES2036R	ES2035L

Drag Links

Axle Lbs. Rating	Code	Year	Length (inches)	Notes	Drag Link No.	
					Drivers Side	Passenger Side
7.000		1967-1975	16.64"	w/Manual Steering To W20,001 w/Power Steering	DS800	
		1967-1968			DS803	
		1969-1975	16.16"			
9.000		1973-1975	15.37"	w/Power Steering To W40,001 w/Manual Steering To W20,001 From W40,001	DS873	
			17.02"		DS872	
		1975-1977	16.49"		DS952	

F800

Tie Rod Ends

Axle Lbs. Rating	Code	Year	Length (Inches)	Notes	Tie Rod End Part No.	
					Drivers Side	Passenger Side
7,000		1995-1999	6.00"		ES3177L	ES3176R

F800, F8000, FT800

King Bolt Sets

Axle Lbs. Rating	Code	Year	Diameter (inches)	Length (Inches)	Pin Type	Bushing	Notes	King Pin Set No.
5,500		1980-1983	1.231"	7.860"	4	Metal		8488B
		1980-1983	1.241"	7.860"	4	Metal		8488B010
6,000		1984-1990	1.231"	8.910"	4	Metal		8500B
		1984-1990	1.241"	8.910"	4	Metal		8500B010
		1989-1998	1.300"	7.757"	2	Metal		8639B
		1984-1990	1.231"	8.910"	4	Nylon		8500N
7,000		1960-1970	1.234"	7.440"	2	Metal	To G90,001	8479B
		1970-1988	1.231"	8.910"	4	Metal	w/Hyd. Brakes From G90,001	8500B
		1973-1975	1.231"	8.910"	4	Metal	w/Air Brakes To W40,001	8500B
		1970-1988	1.241"	8.910"	4	Metal	w/Hyd. Brakes From G90,001	8500B010
		1973-1975	1.241"	8.910"	4	Metal	w/Air Brakes To W40,001	8500B010
		1960-1970	1.244"	7.440"	2	Metal	To G90,001	8507B010
		1980-1988	1.433"	8.250"	2	Metal	w/Air Brakes	8568B
		1989-1994	1.300"	7.757"	2	Metal		8639B
		1960-1970	1.234"	7.440"	2	Nylon	To G90,001	8479N
		1970-1988	1.231"	8.910"	4	Nylon	w/Hyd. Brakes From G90,001	8500N
1973-1975	1.231"	8.910"	4	Nylon	w/Air Brakes To W40,001	8500N		
8,000		1991-1998	1.435"	8.240"	2	Metal		8653B
9,000		1973-1975	1.434"	8.500"	2	Metal	w/Air Brakes To W40,001	8519B
		1973-1975	1.444"	8.500"	2	Metal	w/Air Brakes To W40,001	8519B010
		1975-1990	1.433"	8.250"	2	Metal	w/Air Brakes From W40,001;1980-83 All Brakes	8568B
		1983-1983	1.607"	9.080"	2	Metal	Heavy Duty w/Air Brakes	8573B
		1991-1998	1.435"	8.240"	2	Metal		8653B
1973-1975	1.434"	8.500"	2	Nylon	w/Air Brakes To W40,001	8519N		
10,000		1992-1998	1.743"	10.061"	2	Composite	w/Steel Axle	80068C
		1990-1998	1.743"	10.061"	2	Composite	w/Aluminum Axle	80068C
		1990-1998	1.790"	10.070"	2	Composite	w/Steel Axle	8643B
		1987-1990	1.794"	10.070"	2	Metal	Exc. Aluminum Axle	8572B
12,000		1989-1994	1.790"	10.070"	2	Composite		8643B
		1983-1988	1.794"	10.070"	2	Metal		8572B
14,600		1995-1998	1.812"	10.542"	2	Metal		80069B

Tie Rod Ends

Axle Lbs. Rating	Code	Year	Length (Inches)	Notes	Tie Rod End Part No.	
					Drivers Side	Passenger Side
5,500		1980-1983	4.45"		ES373L	ES373R
6,000		1995-1998		Tube & Clamp Assy.Use w/ES3284L & ES3283R	DS1363S	
		1990-1993	13.25"	w/Hyd. Brakes & Low Profile Option	ES3039L	ES3040R
		1984-1998	4.45"		ES373L	ES373R
		1990-1998	4.93"	Exc. Low Profile Option	ES2061L	ES2062R
		1990-1990	4.93"	Except Low Profile	ES2061L	ES2062R
		1990-1998	5.86"		ES2035L	ES2036R
7,000		1995-1998	7.18"		ES3284L	ES3283R
		1995-1999		Tube & Clamp Assy.Use w/ES3284L & ES3283R	DS1363S	
		1990-1993	13.25"	w/Hyd. Brakes & Low Profile Option	ES3039L	ES3040R
		1961-1966	3.90"		ES304L	ES304R
		1973-1975	4.45"	w/Air Brakes To W40,001	ES373L	ES373R
		1967-1998	4.45"	w/Hyd. Brakes Exc. Low Profile Option	ES373L	ES373R
		1990-1998	4.93"	Exc. Low Profile Option	ES2061L	ES2062R
		1990-1998	5.86"		ES2035L	ES2036R
		1980-1988	5.86"	w/Air Brakes	ES2036R	ES2035L
1995-1999	7.18"		ES3284L	ES3283R		
8,000		1987-1989	5.86"	w/Air Brakes	ES2035L	ES2036R
		1990-1998	5.86"		ES2035L	ES2036R
		1995-1998	7.18"		ES3284L	ES3283R
9,000		1973-1975	4.88"	w/Air Brakes To W40,001	ES187L	ES187R
		1973-1975	4.88"	w/Manual Steering Only	ES187L	ES187R
		1975-1998	5.86"	w/Air Brakes From W40,001,1980-83 All Brakes	ES2035L	ES2036R
		1995-1999	7.18"		ES3284L	ES3283R
10,000		1990-1998		Tube & Clamp Assy.	DS1379S	
		1987-1998	5.44"		ES423L	ES423R
		1992-1998	6.00"		ES3177L	ES3176R
		1995-1998	7.38"	w/Steel Axle	ES3443L	ES3442R
12,000		1990-1991		Tube & Clamp Assy.	DS1379S	
		1983-1995		Cross Tube Assy. w/ends	DS1367A	

F800, F8000, FT800 (Cont'd)

Tie Rod Ends (Cont'd)

Axle Lbs. Rating	Code	Year	Length (Inches)	Notes	Tie Rod End Part No.	
					Drivers Side	Passenger Side
12,000		1983-1995	5.44"	w/Steel Axle	ES423L	ES423R
		1992-1998	6.00"		ES3177L	ES3176R
14,600		1998-1998	6.00"	Cross Tube Assy. w/ends	DS1368A	
		1998-1998			ES3177L	ES3176R

Drag Links

Axle Lbs. Rating	Code	Year	Length (inches)	Notes	Drag Link No.	
5,500		1980-1983	19.25"		DS948	
6,000		1984-1988	19.25"		DS948	
		1989-1992	20.66"		DS1191	
		1992-1994	20.44"		DS1259	
		1995-1995	21.20"		DS1366	
7,000		1967-1975	16.64"	w/Manual Steering To W20,001	DS800	
		1967-1968	16.16"	w/Power Steering	DS803	
		1969-1975		DS948		
		1976-1988		DS1191		
		1989-1992		DS1259		
		1992-1994		DS1366		
1995-1995	21.20"					
8,000		1988-1994	20.30"	w/Air Brakes	DS1192	
		1992-1993	19.47"	Before 5/1993	DS1271	
		1993-1998	19.43"	After 5/1993	DS1369	
9,000		1973-1975	15.37"	w/Power Steering To W40,001	DS873	
		1975-1979	17.02"	w/Manual Steering To W20,001	DS872	
			16.49"	From W40,001	DS952	
			19.23"		DS949	
			1989-1992	20.30"	w/Air Brakes	DS1192
			1992-1993	19.47"	Before 5/1993	DS1271
1993-1998	19.43"		After 5/1993	DS1369		
10,000		1987-1991	19.23"	Taper, w/SPR Cap MUL, SPR Cap	DS1204	
		1992-1994	19.43"		DS1272	
		1995-1995	18.47"		DS1370	
			19.01"		DS1371	
12,000		1982-1991	19.23"	From 3/1982	DS1204	
		1992-1994	19.43"		DS1272	
		1995-1995	18.47"	Taper, w/SPR Cap	DS1370	
			19.01"	MUL, SPR Cap	DS1371	
14,600		1995-1995	18.47"	Drag Link Assy.	DS1370	

F850, F950

King Bolt Sets

Axle Lbs. Rating	Code	Year	Diameter (inches)	Length (Inches)	Pin Type	Bushing	Notes	King Pin Set No.
6,000		1960-1969	1.234"	7.500"	1	Metal		8357B
		1960-1969	1.234"	7.500"	1	Nylon		8357N
7,000		1961-1969	1.234"	7.440"	2	Metal		8479B
		1961-1969	1.244"	7.440"	2	Metal		8507B010
		1961-1969	1.234"	7.440"	2	Nylon		8479N
9,000		1961-1969	1.434"	8.500"	2	Metal		8519B
		1961-1969	1.444"	8.500"	2	Metal		8519B010
		1961-1969	1.434"	8.500"	2	Nylon		8519N
11,000		1962-1969	1.607"	8.812"	2	Metal	(Center Point Steering)	8514B
		1962-1969	1.607"	8.812"	2	Nylon	(Center Point Steering)	8514N
12,000		1961-1969	1.794"	9.120"	2	Metal	(Center Point Steering)	8489B
		1966-1969	1.607"	8.812"	2	Metal		8514B
		1961-1969	1.794"	9.120"	2	Nylon		8489N
		1966-1969	1.607"	8.812"	2	Nylon		8514N

Tie Rod Ends

Axle Lbs. Rating	Code	Year	Length (Inches)	Notes	Tie Rod End Part No.	
					Drivers Side	Passenger Side
7,000		1961-1969	3.90"		ES304L	ES304R
9,000		1961-1969	4.88"		ES187L	ES187R
12,000		1961-1969	5.75"	Anti-Tilt Seal Type	ES346L	ES346R

F900

King Bolt Sets

Axle Lbs. Rating	Code	Year	Diameter (inches)	Length (Inches)	Pin Type	Bushing	Notes	King Pin Set No.
9,000		1973-1979	1.434"	8.500"	2	Metal	w/Air Brakes	8519B
		1973-1979	1.444"	8.500"	2	Metal	w/Air Brakes	8519B010
		1973-1979	1.434"	8.500"	2	Nylon	w/Air Brakes	8519N
		1973-1975	1.434"	8.500"	2	Nylon	w/Hydraulic Brakes	8519N

F900, FT900

King Bolt Sets

Axle Lbs. Rating	Code	Year	Diameter (inches)	Length (Inches)	Pin Type	Bushing	Notes	King Pin Set No.
5,500		1980-1983	1.790"	10.390"	2	Composite		80063C
6,000		1984-1990	1.231"	8.910"	4	Metal		8500B
		1984-1990	1.241"	8.910"	4	Metal		8500B010
		1990-1998	1.300"	7.757"	2	Metal		8639B
		1984-1990	1.231"	8.910"	4	Nylon		8500N
7,000		1980-1988	1.231"	8.910"	4	Metal	w/Hyd. Brakes	8500B
		1980-1988	1.241"	8.910"	4	Metal	w/Hyd. Brakes	8500B010
		1980-1988	1.433"	8.250"	2	Metal	w/Air Brakes	8568B
		1989-1998	1.300"	7.757"	2	Metal	w/Hyd. Brakes	8639B
		1990-1998	1.300"	7.757"	2	Metal		8639B
		1980-1988	1.231"	8.910"	4	Nylon	w/Hyd. Brakes	8500N
8,000		1987-1990	1.433"	8.250"	2	Metal	w/Air Brakes	8568B
		1991-1998	1.435"	8.240"	2	Metal		8653B
9,000		1980-1990	1.433"	8.250"	2	Metal		8568B
		1983-1983	1.607"	9.080"	2	Metal	Heavy Duty w/Air Brakes	8573B
		1991-1998	1.435"	8.240"	2	Metal		8653B
10,000		1990-1998	1.743"	10.061"	2	Composite	w/Aluminum Axle	80068C
		1990-1998	1.790"	10.070"	2	Composite	w/Steel Axle	8643B
		1987-1990	1.794"	10.070"	2	Metal	Exc. Aluminum Axle	8572B
12,000		1992-1998	1.743"	10.061"	2	Composite	w/Steel Axle	80068C
		1990-1991	1.790"	10.070"	2	Composite	w/Steel Axle	8643B
		1982-1988	1.794"	10.070"	2	Metal	From 3/1982	8572B
14,600		1995-1998	1.812"	10.542"	2	Metal		80069B

Tie Rod Ends

Axle Lbs. Rating	Code	Year	Length (Inches)	Notes	Tie Rod End Part No.	
					Drivers Side	Passenger Side
5,500		1980-1983	4.45"		ES373L	ES373R
6,000		1995-1998		Tube & Clamp Assy. Use w/ES3283R & ES3284L	DS1363S	
		1990-1998	13.25"	w/Hyd. Brakes & Low Profile Option	ES3039L	ES3040R
		1984-1998	4.45"	Exc. Low Profile Option	ES373L	ES373R
		1990-1998	4.93"	Exc. Low Profile Option	ES2061L	ES2062R
		1990-1998	5.86"		ES2035L	ES2036R
7,000		1995-1998	7.18"		ES3284L	ES3283R
		1998-1998		Tube & Clamp Assy. Use w/ES3283R & ES3284L	DS1363S	
		1990-1998	13.25"	w/Hyd. Brakes & Low Profile Option	ES3039L	ES3040R
		1980-1998	4.45"	Exc. Low Profile Option	ES373L	ES373R
		1990-1998	4.93"	Exc. Low Profile Option	ES2061L	ES2062R
		1990-1998	5.86"		ES2035L	ES2036R
8,000		1980-1988	5.86"	w/Air Brakes	ES2035L	ES2036R
		1998-1998	7.18"		ES3284L	ES3283R
		1990-1998	5.86"		ES2035L	ES2036R
9,000		1987-1989	5.86"		ES2035L	ES2036R
		1995-1998	7.18"		ES3284L	ES3283R
		1980-1998	5.86"		ES2035L	ES2036R
10,000		1995-1998	7.18"		ES3284L	ES3283R
		1990-1991		Tube & Clamp Assy.	DS1379S	
		1987-1991		Cross Tube Assy. w/ends	DS1367A	
		1987-1991	5.44"		ES423L	ES423R
12,000		1992-1998	6.00"		ES3177L	ES3176R
		1990-1991		Tube & Clamp Assy.	DS1379S	
		1982-1995		From 3/1982; Cross Tube Assy. w/ends	DS1367A	
		1982-1995	5.44"	From 3/1982; w/steel Axle	ES423L	ES423R
		1992-1994	6.00"		ES3177L	ES3176R
	1995-1998	7.38"	w/steel Axle	ES3443L	ES3442R	

F900, FT900 (Cont'd)

Tie Rod Ends (Cont'd)

Axle Lbs. Rating	Code	Year	Length (Inches)	Notes	Tie Rod End Part No.	
					Drivers Side	Passenger Side
14,600		1995-1998	6.00"	Cross Tube Assy. w/ends	DS1368A	
		1995-1998			ES3177L	ES3176R

Drag Links

Axle Lbs. Rating	Code	Year	Length (inches)	Notes	Drag Link No.
5,500		1980-1983	19.25"		DS948
6,000		1984-1988	19.25"		DS948
		1989-1992	20.66"		DS1191
		1993-1994	20.44"		DS1259
		1995-1995	21.20"		DS1366
7,000		1980-1988	19.25"	w/Hyd. Brakes	DS948
		1989-1992	20.66"		DS1191
		1993-1994	20.44"		DS1259
		1995-1995	21.20"		DS1366
8,000		1988-1991	20.30"	Before 5/1993 After 5/1993	DS1192
		1992-1993	19.47"		DS1271
		1993-1998	19.43"		DS1369
9,000		1980-1987	19.23"	Before 5/1993 After 5/1993	DS949
		1988-1992	20.30"		DS1192
		1992-1993	19.47"		DS1271
		1993-1998	19.43"		DS1369
10,000		1987-1991	19.23"	Taper, w/SPR Cap MUL, SPR Cap	DS1204
		1992-1994	19.43"		DS1272
		1995-1995	18.47"		DS1370
			19.01"		DS1371
12,000		1982-1991	19.23"	From 3/1982 Taper, w/SPR Cap MUL, SPR Cap	DS1204
		1992-1994	19.43"		DS1272
		1995-1995	18.47"		DS1370
			19.01"		DS1371
14,600		1995-1995	18.47"	Drag Link Assy.	DS1370

FT900

Drag Links

Axle Lbs. Rating	Code	Year	Length (inches)	Notes	Drag Link No.
6,000		1973-1979	16.64"	w/Hyd. Brakes & Manual Strg.	DS800
7,000		1973-1979	16.64"	w/Hyd. Brakes & Manual Strg.	DS800
		1998-1998	19.29"	from Dec. 1987	DS1190
9,000		1975-1979	16.64"	w/Hydraulic Brakes	DS800

FT950

King Bolt Sets

Axle Lbs. Rating	Code	Year	Diameter (inches)	Length (Inches)	Pin Type	Bushing	Notes	King Pin Set No.
10,000		1990-1998	1.743"	10.061"	2	Composite		80068C

HT950, H1000

King Bolt Sets

Axle Lbs. Rating	Code	Year	Diameter (inches)	Length (Inches)	Pin Type	Bushing	Notes	King Pin Set No.
9,000		1964-1966	1.434"	8.500"	2	Metal		8519B
		1964-1966	1.444"	8.500"	2	Metal		8519B010
		1964-1966	1.434"	8.500"	2	Nylon		8519N
11,000		1964-1965	1.607"	8.812"	2	Metal	(Center Point Steering)	8514B
		1964-1965	1.607"	8.812"	2	Nylon		8514N
12,000		1964-1966	1.794"	9.120"	2	Metal	(Center Point Steering)	8489B
		1966-1966	1.607"	8.812"	2	Metal		8514B
		1964-1966	1.794"	9.120"	2	Nylon		8489N
		1966-1966	1.607"	8.812"	2	Nylon		8514N
15,000		1964-1966	1.400/1.794"	10.688"	7	Metal		8474B

Tie Rod Ends

Axle Lbs. Rating	Code	Year	Length (Inches)	Notes	Tie Rod End Part No.	
					Drivers Side	Passenger Side
9,000		1964-1966	4.88"		ES187L	ES187R

FORD TRUCK

HT950, H1000 (Cont'd)

Tie Rod Ends (Cont'd)

Axle Lbs. Rating	Code	Year	Length (Inches)	Notes	Tie Rod End Part No.	
					Drivers Side	Passenger Side
12,000		1964-1966	5.75"	Anti-Tilt Seal Type	ES346L	ES346R
15,000		1964-1966	5.75"	Anti-Tilt Seal Type	ES346L	ES346R

L800

King Bolt Sets

Axle Lbs. Rating	Code	Year	Diameter (inches)	Length (Inches)	Pin Type	Bushing	Notes	King Pin Set No.
7,000		1975-1998	1.309/1.607"	9.750"	7	Metal	Tapered Pin; Air Brakes	8386B
		1975-1998	1.309/1.607"	9.750"	7	Nylon	Tapered Pin; Air Brakes	8386N

L800, LA800

King Bolt Sets

Axle Lbs. Rating	Code	Year	Diameter (inches)	Length (Inches)	Pin Type	Bushing	Notes	King Pin Set No.
7,000		1980-1986	1.231"	8.910"	4	Metal	w/Hyd. Brakes	8500B
		1970-1972	1.231"	8.910"	4	Metal		8500B
		1980-1986	1.241"	8.910"	4	Metal		8500B010
		1970-1972	1.241"	8.910"	4	Metal		8500B010
		1980-1986	1.433"	8.250"	2	Metal	w/Air Brakes	8568B
		1987-1988	1.433"	8.250"	2	Metal	w/Hyd. Brakes	8568B
		1989-1990	1.300"	7.757"	2	Metal		8639B
		1990-1997	1.300"	7.757"	2	Metal		8639B
		1970-1972	1.231"	8.910"	4	Nylon		8500N
1980-1986	1.231"	8.910"	4	Nylon		8500N		
9,000		1989-1997	1.610"	9.080"	2	Composite		8641B
		1973-1975	1.434"	8.500"	2	Metal	w/Air Brakes To W40,001	8519B
		1973-1986	1.434"	8.500"	2	Metal	w/Hyd. Brakes	8519B
		1970-1972	1.434"	8.500"	2	Metal		8519B
		1973-1975	1.444"	8.500"	2	Metal	w/Air Brakes To W40,001	8519B010
		1970-1972	1.444"	8.500"	2	Metal		8519B010
		1973-1986	1.444"	8.500"	2	Metal	w/Hyd. Brakes	8519B010
		1987-1988	1.433"	8.250"	2	Metal		8568B
		1990-1997	1.607"	9.080"	2	Metal	w/Steel Axle	8573B
		1975-1986	1.607"	9.080"	2	Metal	w/Air Brakes From W40,001	8573B
		1973-1986	1.434"	8.500"	2	Nylon	w/Hyd. Brakes	8519N
		1970-1972	1.434"	8.500"	2	Nylon		8519N
		1973-1975	1.434"	8.500"	2	Nylon	w/Air Brakes To W40,001	8519N
10,000		1990-1997	1.743"	10.061"	2	Composite	w/Aluminum Axle	80068C
		1990-1997	1.790"	10.070"	2	Composite	w/Steel Axle	8643B
		1987-1991	1.794"	10.070"	2	Metal	w/Steel Axle	8572B
11,000		1987-1989	1.794"	10.070"	2	Metal		8572B
12,000		1990-1997	1.743"	10.061"	2	Composite	w/Aluminum Axle	80068C
		1989-1997	1.790"	10.070"	2	Composite	w/Steel Axle	8643B
		1970-1972	1.794"	9.120"	2	Metal		8489B
		1973-1986	1.794"	9.120"	2	Metal	w/Hyd. Brakes	8489B
		1973-1975	1.794"	9.120"	2	Metal	w/Air Brakes To W40,001	8489B
		1975-1989	1.794"	10.070"	2	Metal	w/Air Brakes From W40,001	8572B
		1973-1986	1.794"	9.120"	2	Nylon	w/Hyd. Brakes	8489N
		1973-1975	1.794"	9.120"	2	Nylon	w/Air Brakes To W40,001	8489N
		1970-1972	1.794"	9.120"	2	Nylon		8489N
16,000		1970-1972	1.999"	11.040"	2	Metal		8518B
		1980-1997	1.999"	11.212"	2	Metal		8571B
		1970-1972	1.999"	11.040"	2	Nylon		8518N
18,000		1980-1997	1.999"	11.212"	2	Metal		8571B
20,000		1980-1997	1.999"	11.212"	2	Metal		8571B

Tie Rod Ends

Axle Lbs. Rating	Code	Year	Length (Inches)	Notes	Tie Rod End Part No.	
					Drivers Side	Passenger Side
7,000		1995-1997		Tube & Clamp Assy.Use w/ES3284L & ES3283R	DS1363S	
		1980-1986	4.45"	w/Hyd. Brakes	ES373L	ES373R
		1970-1972	4.45"		ES373L	ES373R
		1987-1997	4.45"		ES373L	ES373R
		1993-1994	4.93"		ES2061L	ES2062R
		1980-1988	5.86"	w/Air Brakes	ES2036R	ES2035L
		1987-1988	5.86"	w/Hyd. Brakes	ES2036R	ES2035L

L800, LA800 (Cont'd)

Tie Rod Ends (Cont'd)

Axle Lbs. Rating	Code	Year	Length (Inches)	Notes	Tie Rod End Part No.	
					Drivers Side	Passenger Side
7,000		1990-1994	5.86"		ES2036R	ES2035L
		1995-1997	7.18"		ES3284L	ES3283R
9,000		1995-1997		Tube & Clamp Assy. Use w/ES3284L & ES3283R w/Air Brakes To W40,001 w/Hyd. Brakes w/Air Brakes From W40,001	DS1363S	
		1970-1972	4.45"		ES373L	ES373R
		1973-1975	4.45"		ES373L	ES373R
		1973-1986	5.44"		ES423L	ES423R
		1975-1986	5.86"		ES2035L	ES2036R
		1987-1989	5.86"		ES2035L	ES2036R
		1990-1997	5.86"		ES2035L	ES2036R
1995-1997	7.18"	ES3284L	ES3283R			
10,000		1987-1991		Cross Tube Assy. w/ends Tube & Clamp Assy.	DS1367A	
		1990-1991			DS1379S	
		1987-1991	5.44"		ES423L	ES423R
		1992-1997	6.00"		ES3177L	ES3176R
11,000		1987-1989	5.44"	w/Air Brakes	ES423L	ES423R
12,000		1990-1991		Tube & Clamp Assy. w/Air Brakes w/Hyd. Brakes	DS1379S	
		1970-1984	5.44"		ES423L	ES423R
		1970-1983	5.44"		ES423L	ES423R
		1992-1997	6.00"		ES3177L	ES3176R
16,000		1990-1990		Tube & Clamp Assy. Cross Tube Assy. w/ends	DS1380S	
		1994-1997			DS1368A	
		1980-1990	5.44"		ES423L	ES423R
		1970-1972	5.75"		ES431L	ES376R
		1970-1972	5.75"		ES376L	ES376R
1991-1997	6.00"	ES3177L	ES3176R			
18,000		1994-1997		Cross Tube Assy. w/ends Tube & Clamp Assy.	DS1368A	
		1990-1990			DS1380S	
		1980-1990	5.44"		ES423L	ES423R
		1991-1997	6.00"		ES3177L	ES3176R
20,000		1994-1997		Cross Tube Assy. w/ends Tube & Clamp Assy.	DS1368A	
		1990-1990			DS1380S	
		1991-1994	6.00"		ES3177L	ES3176R
		1991-1994	6.00"		ES3177L	ES3176R
		1980-1990	5.44"		ES423L	ES423R

Drag Links

Axle Lbs. Rating	Code	Year	Length (inches)	Notes	Drag Link No.
7,000		1980-1991	18.03"		DS908
		1992-1994	17.91"		DS1270
9,000		1973-1991	18.03"		DS908
		1990-1991	32.62"		DS1207
		1992-1994	17.91"		DS1270
10,000		1980-1991	18.03"		DS908
		1990-1991	32.62"		DS1207
		1990-1997	36.15"		DS1203
		1992-1994	17.91"		DS1270
11,000		1987-1989	18.03"		DS908
12,000		1973-1991	18.03"		DS908
		1990-1991	32.62"		DS1207
		1990-1997	36.15"		DS1203
		1992-1994	17.91"		DS1270
16,000		1980-1991	18.03"	w/L.H. Power Steering Gear w/R.H. Power Steering Gear w/LH Power Steering w/RH Power Steering	DS908
		1990-1997	36.15"		DS1203
		1991-1997	17.53"		DS1265
			32.53"		DS1267
			32.53"		DS1266
1992-1997	17.91"	DS1268			
18,000		1980-1997	18.03"		DS908
		1991-1997	17.53"	w/L.H. Power Steering Gear w/R.H. Power Steering Gear	DS1265
20,000		1980-1991	18.03"	w/L.H. Power Steering Gear w/R.H. Power Steering Gear w/LH Power Steering w/RH Power Steering	DS908
		1990-1997	36.15"		DS1203
		1991-1997	17.53"		DS1265
			32.53"		DS1267
			32.53"		DS1266
1992-1997	17.91"	DS1268			
					DS1270

FORD TRUCK



L900, LA900, LL900, LN900, L9000, LN9000

King Bolt Sets

Axle Lbs. Rating	Code	Year	Diameter (inches)	Length (Inches)	Pin Type	Bushing	Notes	King Pin Set No.
7,000		1973-1986	1.231"	8.910"	4	Metal	w/Hyd. Brakes	8500B
		1970-1972	1.231"	8.910"	4	Metal		8500B
		1973-1975	1.231"	8.910"	4	Metal	w/Air Brakes To W40,001	8500B
		1970-1972	1.241"	8.910"	4	Metal		8500B010
		1973-1986	1.241"	8.910"	4	Metal	w/Hyd. Brakes	8500B010
		1973-1975	1.241"	8.910"	4	Metal	w/Air Brakes To W40,001	8500B010
		1980-1986	1.433"	8.250"	2	Metal	w/Air Brakes From W40,001	8568B
		1987-1988	1.433"	8.250"	2	Metal	w/Hyd. Brakes	8568B
		1989-1990	1.300"	7.757"	2	Metal		8639B
		1990-1997	1.300"	7.757"	2	Metal	From 10/1990	8639B
		1970-1972	1.231"	8.910"	4	Nylon		8500N
		1973-1975	1.231"	8.910"	4	Nylon	w/Air Brakes To W40,001	8500N
	1973-1986	1.231"	8.910"	4	Nylon	w/Hyd. Brakes	8500N	
9,000		1989-1989	1.610"	9.080"	2	Composite		8641B
		1997-1997	1.610"	9.080"	2	Composite		8641B
		1973-1986	1.434"	8.500"	2	Metal	w/Hyd. Brakes	8519B
		1973-1975	1.434"	8.500"	2	Metal	w/Air Brakes To W40,001	8519B
		1970-1972	1.434"	8.500"	2	Metal		8519B
		1970-1972	1.444"	8.500"	2	Metal		8519B010
		1973-1975	1.444"	8.500"	2	Metal	w/Air Brakes To W40,001	8519B010
		1973-1986	1.444"	8.500"	2	Metal	w/Hyd. Brakes	8519B010
		1987-1988	1.433"	8.250"	2	Metal		8568B
		1990-1997	1.607"	9.080"	2	Metal	w/Steel Axle	8573B
		1975-1986	1.607"	9.080"	2	Metal	w/Air Brakes From W40,001	8573B
		1973-1986	1.434"	8.500"	2	Nylon	w/Hyd. Brakes	8519N
		1973-1975	1.434"	8.500"	2	Nylon	w/Air Brakes To W40,001	8519N
		1970-1972	1.434"	8.500"	2	Nylon		8519N
10,000		1990-1997	1.743"	10.061"	2	Composite	w/Aluminum Axle	80068C
		1990-1997	1.790"	10.070"	2	Composite	w/Steel Axle	8643B
		1987-1991	1.794"	10.070"	2	Metal	w/Steel Axle	8572B
11,000		1987-1989	1.794"	10.070"	2	Metal	w/Air Brakes	8572B
12,000		1990-1997	1.743"	10.061"	2	Composite	w/Aluminum Axle	80068C
		1989-1997	1.790"	10.070"	2	Composite	w/Steel Axle	8643B
		1970-1972	1.794"	9.120"	2	Metal		8489B
		1970-1975	1.794"	9.120"	2	Metal	w/Air Brakes To W40,001	8489B
		1973-1983	1.794"	9.120"	2	Metal	w/Hyd. Brakes	8489B
		1975-1989	1.794"	10.070"	2	Metal	w/Air Brakes From W40,001	8572B
		1970-1972	1.794"	9.120"	2	Nylon		8489N
		1970-1975	1.794"	9.120"	2	Nylon	w/Air Brakes To W40,001	8489N
		1973-1983	1.794"	9.120"	2	Nylon	w/Hyd. Brakes	8489N
		1980-1997	1.999"	11.212"	2	Metal		8571B
18,000		1980-1997	1.999"	11.212"	2	Metal		8571B
20,000		1980-1997	1.999"	11.212"	2	Metal		8571B

Tie Rod Ends

Axle Lbs. Rating	Code	Year	Length (Inches)	Notes	Tie Rod End Part No.	
					Drivers Side	Passenger Side
7,000		1995-1998		Tube & Clamp Assy. Use w/ES3283R & ES3284L	DS1363S	
		1973-1975	4.45"	w/Air Brakes To W40,001	ES373L	ES373R
		1970-1997	4.45"	1973-86 w/Hyd. Brakes, 1989-90 All, 1970-72 All Brakes	ES373L	ES373R
		1993-1994	4.93"		ES2061L	ES2062R
		1975-1979	5.86"		ES2035L	ES2036R
		1980-1986	5.86"	w/Air Brakes From W40,001	ES2035L	ES2036R
		1990-1994	5.86"		ES2035L	ES2036R
		1987-1988	5.86"	w/Hyd. Brakes	ES2035L	ES2036R
9,000		1995-1998	7.18"		ES3284L	ES3283R
		1990-1997		Tube & Clamp Assy.	DS1363S	
		1970-1972	5.44"		ES423L	ES423R
		1973-1975	5.44"	w/Air Brakes To W40,001	ES423L	ES423R
		1973-1986	5.44"	w/Hyd. Brakes	ES423L	ES423R
		1975-1986	5.86"	w/Air Brakes From W40,001	ES2035L	ES2036R
		1987-1989	5.86"		ES2035L	ES2036R
		1990-1997	5.86"		ES2035L	ES2036R
10,000		1997-1997	7.18"		ES3284L	ES3283R
		1987-1991		Cross Tube Assy. w/ends	DS1367A	
		1990-1991		Tube & Clamp Assy.	DS1379S	
		1987-1991	5.44"		ES423L	ES423R
	1992-1997	6.00"		ES3177L	ES3176R	

Heavy Duty Trucks

L900, LA900, LL900, LN900, L9000, LN9000 (Cont'd)

Tie Rod Ends (Cont'd)

Axle Lbs. Rating	Code	Year	Length (Inches)	Notes	Tie Rod End Part No.	
					Drivers Side	Passenger Side
11,000		1987-1989	5.44"		ES423L	ES423R
12,000		1990-1991 1970-1991 1992-1997	5.44" 6.00"	Tube & Clamp Assy.	ES423L ES3177L	DS1379S ES423R ES3176R
16,000		1990-1990 1994-1997 1980-1990 1991-1997	5.44" 6.00"	Tube & Clamp Assy. Cross Tube Assy. w/ends	ES423L ES3177L	DS1380S DS1368A ES423R ES3176R
18,000		1990-1990 1994-1997 1980-1990 1991-1997	5.44" 6.00"	Tube & Clamp Assy. Cross Tube Assy. w/ends	ES423L ES3177L	DS1380S DS1368A ES423R ES3176R
20,000		1990-1990 1994-1997 1980-1990 1991-1997	5.44" 6.00"	Tube & Clamp Assy. Cross Tube Assy. w/ends	ES423L ES3177L	DS1380S DS1368A ES423R ES3176R

Drag Links

Axle Lbs. Rating	Code	Year	Length (inches)	Notes	Drag Link No.
7,000		1973-1991 1992-1994	18.03" 17.91"		DS908 DS1270
9,000		1973-1991 1990-1991 1992-1994	18.03" 32.62" 17.91"		DS908 DS1207 DS1270
10,000		1980-1991 1990-1991 1990-1997 1992-1994	18.03" 32.62" 36.15" 17.91"		DS908 DS1207 DS1203 DS1270
11,000		1987-1991	18.03"		DS908
12,000		1973-1991 1990-1991 1990-1997 1992-1994	18.03" 32.62" 36.15" 17.91"		DS908 DS1207 DS1203 DS1270
16,000		1980-1991 1991-1994 1992-1997	18.03" 17.53" 32.53" 17.91"	w/R.H. Power Steering Gear w/L.H. Power Steering Gear LT,LTA,Models w/LH Pwr. Strg. LT,LTA,Models w/RH Pwr. Strg. L, LN, LNT, LT Models	DS908 DS1267 DS1265 DS1266 DS1268 DS1270
18,000		1980-1991 1990-1990 1991-1994 1992-1997	18.03" 36.15" 17.53" 32.53" 17.91"	w/L.H. Power Steering Gear w/R.H. Power Steering Gear LT,LTA,Models w/LH Pwr. Strg. LT,LTA,Models w/RH Pwr. Strg. L, LN, LNT, LT Models	DS908 DS1203 DS1265 DS1267 DS1266 DS1268 DS1270
20,000		1980-1991 1990-1990 1991-1997 1992-1997	18.03" 36.15" 17.53" 32.53" 17.91"	w/L.H. Power Steering Gear w/R.H. Power Steering Gear LT,LTA,Models w/LH Pwr. Strg. LT,LTA,Models w/RH Pwr. Strg. L, LN, LNT, LT Models	DS908 DS1203 DS1265 DS1267 DS1266 DS1268 DS1270

LCFC450

Tie Rod Ends

Axle Lbs. Rating	Code	Year	Length (Inches)	Notes	Tie Rod End Part No.	
					Drivers Side	Passenger Side
		2006-2009	6.00"		ES3477	ES3476

LCFC550

Tie Rod Ends

Axle Lbs. Rating	Code	Year	Length (Inches)	Notes	Tie Rod End Part No.	
					Drivers Side	Passenger Side
		2006-2009	6.00"		ES3477	ES3476

LLA900, LLS900, LTLA900, LTLS900

King Bolt Sets

Axle Lbs. Rating	Code	Year	Diameter (inches)	Length (Inches)	Pin Type	Bushing	Notes	King Pin Set No.
9,000		1997-1997	1.610"	9.080"	2	Composite		8641B
14,600		1991-1997	1.999"	11.212"	2	Metal		8571B
16,000		1991-1997	1.999"	11.212"	2	Metal		8571B
18,000		1991-1997	1.999"	11.212"	2	Metal		8571B
20,000		1991-1997	1.999"	11.212"	2	Metal		8571B

Tie Rod Ends

Axle Lbs. Rating	Code	Year	Length (Inches)	Notes	Tie Rod End Part No.	
					Drivers Side	Passenger Side
9,000		1997-1997		Tube & Clamp Assy. Use w/ES3283R & ES3284L	DS1363S	
		1997-1997	7.18"		ES3284L	ES3283R
14,600		1991-1997	6.00"		ES3177L	ES3176R
16,000		1991-1997	6.00"		ES3177L	ES3176R
18,000		1991-1997	6.00"		ES3177L	ES3176R
20,000		1996-1997	6.00"		ES3177L	ES3176R

Drag Links

Axle Lbs. Rating	Code	Year	Length (inches)	Notes	Drag Link No.
10,000		1992-1997	17.91" 22.61"	(LH) Used With #F1HT-3304ZA (RH) Used With #F1HT-3304VA	DS1270 DS1409 DS1269
12,000		1992-1997	17.91" 22.61"	(RH) Used With #F1HT-3304VA (LH) Used With #F1HT-3304ZA	DS1270 DS1269 DS1409
14,600		1992-1997	17.91" 22.61"	(LH) Used With #F1HT-3304ZA (RH) Used With #F1HT-3304VA	DS1270 DS1409 DS1269
16,000		1992-1997	17.91" 22.61"	(RH) Used With #F1HT-3304VA (LH) Used With #F1HT-3304ZA	DS1270 DS1269 DS1409
18,000		1992-1997	17.91" 22.61"	(RH) Used With #F1HT-3304VA (LH) Used With #F1HT-3304ZA	DS1270 DS1269 DS1409
20,000		1992-1997	17.91"		DS1270

LN500

King Bolt Sets

Axle Lbs. Rating	Code	Year	Diameter (inches)	Length (Inches)	Pin Type	Bushing	Notes	King Pin Set No.
5,000		1967-1972	1.231"	7.860"	4	Metal		8488B
		1967-1972	1.241"	7.860"	4	Metal		8488B010
		1967-1972	1.231"	7.860"	1	Metal	Heavy Duty	8609B

Tie Rod Ends

Axle Lbs. Rating	Code	Year	Length (Inches)	Notes	Tie Rod End Part No.	
					Drivers Side	Passenger Side
5,000		1967-1972	4.45"		ES373L	ES373R

Drag Links

Axle Lbs. Rating	Code	Year	Length (inches)	Notes	Drag Link No.
5,000		1970-1972 1971-1971	19.39" 16.64"		DS845 DS800

LN600

King Bolt Sets

Axle Lbs. Rating	Code	Year	Diameter (inches)	Length (Inches)	Pin Type	Bushing	Notes	King Pin Set No.
5,000		1967-1973	1.231"	7.860"	4	Metal		8488B
		1967-1973	1.241"	7.860"	4	Metal		8488B010
		1967-1973	1.231"	7.860"	1	Metal	Heavy Duty	8609B
5,500		1967-1985	1.231"	7.860"	4	Metal		8488B
		1967-1985	1.241"	7.860"	4	Metal		8488B010

LN600 (Cont'd)

King Bolt Sets (Cont'd)

Axle Lbs. Rating	Code	Year	Diameter (inches)	Length (Inches)	Pin Type	Bushing	Notes	King Pin Set No.
5,500		1967-1985	1.231"	7.860"	1	Metal	Heavy Duty	8609B
6,000		1967-1979	1.231"	8.910"	4	Metal		8500B
		1967-1979	1.241"	8.910"	4	Metal		8500B010
		1967-1979	1.231"	8.910"	4	Nylon		8500N
7,000		1980-1985	1.231"	8.910"	4	Metal	w/Hyd. Brakes	8500B
		1967-1975	1.231"	8.910"	4	Metal	To W40,001	8500B
		1967-1975	1.241"	8.910"	4	Metal	To W40,001	8500B010
		1980-1985	1.241"	8.910"	4	Metal	w/Hyd. Brakes	8500B010
		1975-1985	1.433"	8.250"	2	Metal	From W40,001 w/Air Brakes 1980-83	8568B
		1967-1975	1.231"	8.910"	4	Nylon	To W40,001	8500N
9,000		1980-1985	1.231"	8.910"	4	Nylon	w/Hyd. Brakes	8500N
		1973-1975	1.434"	8.500"	2	Metal	To W40,001	8519B
		1973-1975	1.444"	8.500"	2	Metal	To W40,001	8519B010
		1967-1979	1.433"	8.250"	2	Metal	From W40,001	8568B
		1973-1975	1.434"	8.500"	2	Nylon	To W40,001	8519N

Tie Rod Ends

Axle Lbs. Rating	Code	Year	Length (Inches)	Notes	Tie Rod End Part No.	
					Drivers Side	Passenger Side
5,000		1967-1973	4.45"	Uses DS925S Sleeve	ES373L	ES373R
5,500		1967-1985	4.45"	Uses DS925S Sleeve	ES373L	ES373R
6,000		1967-1979	4.45"		ES373L	ES373R
7,000		1973-1985	4.45"	w/Hyd. Brakes	ES373L	ES373R
		1973-1975	4.45"	w/Air Brakes To W40,001	ES373L	ES373R
		1975-1985	5.86"	w/Air Brakes From W40,001	ES2035L	ES2036R
9,000		1973-1975	4.88"	w/Air Brakes To W40,001	ES187L	ES187R
		1975-1979	5.86"	w/Air Brakes From W40,001	ES2035L	ES2036R

Drag Links

Axle Lbs. Rating	Code	Year	Length (inches)	Notes	Drag Link No.
5,000		1970-1973	19.39"		DS845
5,500		1970-1973	19.39"		DS845
		1980-1985		w/Hyd. Brakes	
6,000		1973-1975	19.39"	To W40,001	DS845
7,000		1973-1975	19.39"	To W40,001	DS845
		1975-1985	18.89"	From W40,001 w/Air Brakes 1980	DS946
		1980-1985	19.39"	w/Hyd. Brakes	DS845
9,000		1975-1997	18.74"	w/Air Brakes	DS954

LN700

King Bolt Sets

Axle Lbs. Rating	Code	Year	Diameter (inches)	Length (Inches)	Pin Type	Bushing	Notes	King Pin Set No.
5,000		1970-1973	1.231"	7.860"	4	Metal		8488B
		1970-1973	1.241"	7.860"	4	Metal		8488B010
		1970-1973	1.231"	7.860"	1	Metal	Heavy Duty	8609B
5,500		1970-1973	1.231"	7.860"	4	Metal		8488B
		1970-1973	1.241"	7.860"	4	Metal		8488B010
		1970-1973	1.231"	7.860"	1	Metal	Heavy Duty	8609B
6,000		1970-1979	1.231"	8.910"	4	Metal		8500B
		1970-1979	1.241"	8.910"	4	Metal		8500B010
		1970-1979	1.231"	8.910"	4	Nylon		8500N
7,000		1970-1986	1.231"	8.910"	4	Metal	w/Hyd. Brakes From 1973	8500B
		1971-1975	1.231"	8.910"	4	Metal	w/Air Brakes To W40,001	8500B
		1971-1975	1.241"	8.910"	4	Metal	w/Air Brakes To W40,001	8500B010
		1970-1986	1.241"	8.910"	4	Metal	w/Hyd. Brakes From 1973	8500B010
		1975-1986	1.433"	8.250"	2	Metal	w/Air Brakes From W40,001	8568B
		1971-1975	1.231"	8.910"	4	Nylon	w/Air Brakes To W40,001	8500N
9,000		1970-1986	1.231"	8.910"	4	Nylon	w/Hyd. Brakes From 1973	8500N
		1997-1997	1.610"	9.080"	2	Composite		8641B
		1970-1983	1.434"	8.500"	2	Metal	w/Hyd. Brakes From 1973	8519B
		1973-1975	1.434"	8.500"	2	Metal	w/Air Brakes To W40,001	8519B
		1970-1983	1.444"	8.500"	2	Metal	w/Hyd. Brakes From 1973	8519B010
		1973-1975	1.444"	8.500"	2	Metal	w/Air Brakes To W40,001	8519B010
		1975-1983	1.433"	8.250"	2	Metal	w/Air Brakes From W40,001	8568B
		1984-1989	1.433"	8.250"	2	Metal		8568B
	1970-1983	1.434"	8.500"	2	Nylon	w/Hyd. Brakes From 1973	8519N	

FORD TRUCK



LN700 (Cont'd)

King Bolt Sets (Cont'd)

Axle Lbs. Rating	Code	Year	Diameter (inches)	Length (Inches)	Pin Type	Bushing	Notes	King Pin Set No.
9,000		1973-1975	1.434"	8.500"	2	Nylon	w/Air Brakes To W40,001	8519N

Tie Rod Ends

Axle Lbs. Rating	Code	Year	Length (Inches)	Notes	Tie Rod End Part No.	
					Drivers Side	Passenger Side
5,000		1970-1973	4.45"		ES373L	ES373R
5,500		1970-1973	4.45"		ES373L	ES373R
6,000		1970-1979	4.45"		ES373L	ES373R
7,000		1973-1986	4.45"	w/Hyd. Brakes	ES373L	ES373R
		1973-1975	4.45"	w/Air Brakes To W40,001	ES373L	ES373R
		1975-1986	5.86"	w/Air Brakes From W40,001	ES2035L	ES2036R
9,000		1997-1997		Tube and clamp Assy.	DS1363S	
		1973-1975	4.88"	w/Air Brakes To W40,001		ES187R
		1973-1975	4.88"	w/Manual Steering	ES187L	
		1970-1986	4.88"	w/Hyd. Brakes		ES187R
		1970-1986	4.88"	w/Manual Steering	ES187L	
		1975-1986	5.86"	w/Air Brakes From W40,001		ES2036R
		1975-1986	5.86"		ES2035L	
	1997-1997	7.18"		ES3284L	ES3283R	

Drag Links

Axle Lbs. Rating	Code	Year	Length (inches)	Notes	Drag Link No.
5,000		1970-1973	19.39"		DS845
5,500		1970-1973 1990-1997	19.39"		DS845
6,000		1970-1975 1990-1997	19.39"	To W40,001	DS845
7,000		1970-1975	19.39"	To W40,001	DS845
		1975-1997	18.89"	From W40,001 & 1980 w/Air Brakes	DS946
		1980-1986	19.39"	w/Hyd. Brakes	DS845
		1990-1997			
9,000		1977-1997	18.74"	w/Air Brakes	DS954

LN800, L8000, LN8000

King Bolt Sets

Axle Lbs. Rating	Code	Year	Diameter (inches)	Length (Inches)	Pin Type	Bushing	Notes	King Pin Set No.
7,000		1980-1986	1.231"	8.910"	4	Metal	w/Hyd. Brakes	8500B
		1967-1973	1.231"	8.910"	4	Metal		8500B
		1980-1986	1.241"	8.910"	4	Metal	w/Hyd. Brakes	8500B010
		1967-1973	1.241"	8.910"	4	Metal		8500B010
		1980-1986	1.433"	8.250"	2	Metal	w/Air Brakes	8568B
		1987-1988	1.433"	8.250"	2	Metal	w/Hyd. Brakes	8568B
		1989-1990	1.300"	7.757"	2	Metal		8639B
		1990-1997	1.300"	7.757"	2	Metal		8639B
		1967-1973	1.231"	8.910"	4	Nylon		8500N
		1980-1986	1.231"	8.910"	4	Nylon	w/Hyd. Brakes	8500N
9,000		1989-1989	1.610"	9.080"	2	Composite		8641B
		1997-1997	1.610"	9.080"	2	Composite		8641B
		1973-1975	1.434"	8.500"	2	Metal	w/Air Brakes To W40,001	8519B
		1973-1986	1.434"	8.500"	2	Metal	w/Hyd. Brakes	8519B
		1970-1972	1.434"	8.500"	2	Metal		8519B
		1973-1975	1.444"	8.500"	2	Metal	w/Air Brakes To W40,001	8519B010
		1973-1986	1.444"	8.500"	2	Metal	w/Hyd. Brakes	8519B010
		1970-1972	1.444"	8.500"	2	Metal		8519B010
		1987-1988	1.433"	8.250"	2	Metal		8568B
		1990-1997	1.607"	9.080"	2	Metal		8573B
		1975-1986	1.607"	9.080"	2	Metal	w/Air Brakes From W40,001	8573B
		1973-1986	1.434"	8.500"	2	Nylon	w/Hyd. Brakes	8519N
		1970-1972	1.434"	8.500"	2	Nylon		8519N
		1973-1975	1.434"	8.500"	2	Nylon	w/Air Brakes To W40,001	8519N
10,000		1990-1997	1.743"	10.061"	2	Composite	w/Aluminum Axle	80068C
		1990-1997	1.790"	10.070"	2	Composite	w/Steel Axle	8643B
		1987-1991	1.794"	10.070"	2	Metal	w/Steel Axle	8572B
11,000		1987-1989	1.794"	10.070"	2	Metal	w/Air Brakes	8572B
12,000		1990-1997	1.743"	10.061"	2	Composite	w/Aluminum Axle	80068C
		1989-1997	1.790"	10.070"	2	Composite	w/Steel Axle	8643B

LN800, L8000, LN8000 (Cont'd)

King Bolt Sets (Cont'd)

Axle Lbs. Rating	Code	Year	Diameter (inches)	Length (Inches)	Pin Type	Bushing	Notes	King Pin Set No.
12,000		1973-1975	1.794"	9.120"	2	Metal	w/Air Brakes To W40,001	8489B
		1973-1986	1.794"	9.120"	2	Metal	w/Hyd. Brakes	8489B
		1970-1972	1.794"	9.120"	2	Metal		8489B
		1975-1989	1.794"	10.070"	2	Metal	w/Air Brakes From W40,001	8572B
		1973-1975	1.794"	9.120"	2	Nylon	w/Air Brakes To W40,001	8489N
		1973-1986	1.794"	9.120"	2	Nylon	w/Hyd. Brakes	8489N
16,000		1970-1975	1.999"	11.040"	2	Metal		8518B
		1975-1997	1.999"	11.212"	2	Metal		8571B
		1970-1975	1.999"	11.040"	2	Nylon		8518N
18,000		1980-1997	1.999"	11.212"	2	Metal		8571B
20,000		1980-1989	1.999"	11.212"	2	Metal		8571B

Tie Rod Ends

Axle Lbs. Rating	Code	Year	Length (Inches)	Notes	Tie Rod End Part No.	
					Drivers Side	Passenger Side
7,000		1967-1973	4.45"	w/Hyd. Brakes	ES373L	ES373R
		1989-1990	4.45"		ES373L	ES373R
		1980-1986	4.45"		ES373L	ES373R
		1990-1994	5.86"	w/Hyd. Brakes	ES2036R	ES2035L
		1987-1988	5.86"		ES2036R	ES2035L
		1980-1988	5.86"		ES2036R	ES2035L
9,000		1990-1997	4.45"	Tube & Clamp Assy. Use w/ES3284L & ES3283R w/Air Brakes To W40,001	DS1363S	
		1973-1975			ES373L	ES373R
		1970-1972			ES373L	ES373R
		1973-1986			ES423L	ES423R
		1975-1989			ES2035L	ES2036R
		1990-1997			ES2035L	ES2036R
10,000		1987-1991	5.44"	Cross Tube Assy. w/ends Tube & Clamp Assy.	DS1367A	
		1990-1991			DS1379S	
		1987-1991			ES423L	ES423R
		1992-1997			ES3177L	ES3176R
11,000		1987-1989	5.44"		ES423L	ES423R
		1990-1991	5.44"	Tube & Clamp Assy. w/Air Brakes	DS1379S	
1970-1984	ES423L	ES423R				
1970-1983	ES423L	ES423R				
1992-1997	ES3177L	ES3176R				
16,000		1990-1990	5.44"	Tube & Clamp Assy.	DS1380S	
		1975-1990	ES423L		ES423R	
		1970-1975	ES431L		ES431R	
18,000		1991-1997	6.00"		ES3177L	ES3176R
		1994-1997	5.44"	Cross Tube Assy. w/ends Tube & Clamp Assy.	DS1368A	
		1990-1990			DS1380S	
1980-1990	ES423L	ES423R				
20,000		1991-1997	6.00"		ES3177L	ES3176R
		1994-1997	5.44"	Cross Tube Assy. w/ends Tube & Clamp Assy.	DS1368A	
		1990-1990			DS1380S	
1980-1990	ES423L	ES423R				
		1991-1997	6.00"		ES3177L	ES3176R

Drag Links

Axle Lbs. Rating	Code	Year	Length (inches)	Notes	Drag Link No.
7,000		1980-1991	18.03"		DS908
9,000		1973-1991	18.03"		DS908
		1990-1990	32.62"		DS1207
10,000		1987-1991	18.03"		DS908
		1990-1990	32.62"		DS1207
11,000		1987-1989	18.03"		DS908
12,000		1973-1991	18.03"		DS908
		1990-1990	32.62"		DS1207
16,000		1973-1990	18.03"	w/L.H. Power Steering Gear w/R.H. Power Steering Gear L, LN, LNT, LT Models	DS908
		1991-1997	17.53"		DS1265
		1992-1997	17.91"		DS1267
18,000		1980-1990	18.03"		DS1270
					DS908

FORD TRUCK

LN800, L8000, LN8000 (Cont'd)

Drag Links (Cont'd)

Axle Lbs. Rating	Code	Year	Length (inches)	Notes	Drag Link No.	
					Drivers Side	Passenger Side
18,000		1991-1997	17.53"	w/L.H. Power Steering Gear w/R.H. Power Steering Gear	DS1265	
		1992-1997	17.91"	L, LN, LNT, LT Models	DS1267	
20,000		1980-1990	18.03"	w/L.H. Power Steering Gear w/R.H. Power Steering Gear L, LN, LNT, LT Models	DS1265	
		1991-1997	17.53"		DS1267	
		1992-1997	17.91"		DS1270	

LN8000

Drag Links

Axle Lbs. Rating	Code	Year	Length (inches)	Notes	Drag Link No.	
					Drivers Side	Passenger Side
7,000		1992-1997	17.91"		DS1270	
9,000		1992-1997	17.91"		DS1270	
10,000		1992-1997	17.91"		DS1270	
12,000		1992-1997	17.91"		DS1270	

LNT800

King Bolt Sets

Axle Lbs. Rating	Code	Year	Diameter (inches)	Length (Inches)	Pin Type	Bushing	Notes	King Pin Set No.	
								Drivers Side	Passenger Side
7,000		1967-1973	1.231"	8.910"	4	Metal		8500B	
		1967-1973	1.241"	8.910"	4	Metal		8500B010	
		1967-1973	1.231"	8.910"	4	Nylon		8500N	
9,000		1997-1997	1.610"	9.080"	2	Composite		8641B	
		1989-1989	1.610"	9.080"	2	Composite		8641B	
		1970-1972	1.434"	8.500"	2	Metal		8519B	
		1973-1975	1.434"	8.500"	2	Metal	w/Air Brakes To W40,001	8519B	
		1973-1986	1.434"	8.500"	2	Metal	w/Hyd. Brakes	8519B	
		1970-1972	1.444"	8.500"	2	Metal		8519B010	
		1973-1975	1.444"	8.500"	2	Metal	w/Air Brakes To W40,001	8519B010	
		1973-1986	1.444"	8.500"	2	Metal	w/Hyd. Brakes	8519B010	
		1987-1988	1.433"	8.250"	2	Metal		8568B	
		1975-1986	1.607"	9.080"	2	Metal	w/Air Brakes From W40,001	8573B	
		1990-1997	1.607"	9.080"	2	Metal	w/Steel Axle	8573B	
		1970-1986	1.434"	8.500"	2	Nylon		8519N	
		1973-1975	1.434"	8.500"	2	Nylon	w/Air Brakes To W40,001	8519N	
10,000		1990-1997	1.743"	10.061"	2	Composite	w/Aluminum Axle	80068C	
		1990-1997	1.790"	10.070"	2	Composite	w/Steel Axle	8643B	
		1987-1991	1.794"	10.070"	2	Metal	w/Steel Axle	8572B	
11,000		1987-1989	1.794"	10.070"	2	Metal	w/Air Brakes	8572B	
12,000		1990-1997	1.743"	10.061"	2	Composite	w/Aluminum Axle	80068C	
		1989-1997	1.790"	10.070"	2	Composite	w/Steel Axle	8643B	
		1970-1972	1.794"	9.120"	2	Metal		8489B	
		1973-1984	1.794"	9.120"	2	Metal	w/Hyd. Brakes	8489B	
		1973-1975	1.794"	9.120"	2	Metal	w/Air Brakes To W40,001	8489B	
		1975-1989	1.794"	10.070"	2	Metal	w/Air Brakes From W40,001	8572B	
		1970-1972	1.794"	9.120"	2	Nylon		8489N	
		1973-1984	1.794"	9.120"	2	Nylon	w/Hyd. Brakes	8489N	
		1973-1975	1.794"	9.120"	2	Nylon	w/Air Brakes To W40,001	8489N	
16,000		1970-1975	1.999"	11.040"	2	Metal		8518B	
		1975-1997	1.999"	11.212"	2	Metal		8571B	
		1970-1975	1.999"	11.040"	2	Nylon		8518N	
18,000		1980-1997	1.999"	11.212"	2	Metal		8571B	
20,000		1980-1997	1.999"	11.212"	2	Metal		8571B	

Tie Rod Ends

Axle Lbs. Rating	Code	Year	Length (Inches)	Notes	Tie Rod End Part No.	
					Drivers Side	Passenger Side
7,000		1967-1973	4.45"		ES373L	ES373R
9,000		1997-1997	4.45"	Tube & Clamp Assy. Use w/ES3284L & ES3283R	DS1363S	
		1973-1975	4.45"	w/Air Brakes To W40,001	ES373L	ES373R
		1970-1972	4.45"		ES373L	ES373R
		1973-1986	5.44"	w/Hyd. Brakes	ES423L	ES423R
		1990-1997	5.86"	w/Steel Axle	ES2035L	ES2036R
		1975-1989	5.86"	1980-86 w/Air Brakes From W40,001, 1987-89 All	ES2035L	ES2036R
1997-1997	7.18"		ES3284L	ES3283R		

LNT800 (Cont'd)

Tie Rod Ends (Cont'd)

Axle Lbs. Rating	Code	Year	Length (Inches)	Notes	Tie Rod End Part No.	
					Drivers Side	Passenger Side
10,000		1987-1991	5.44" 6.00"	Cross Tube Assy. w/ends Tube & Clamp Assy.	DS1367A DS1379S	
		1987-1991			ES423L	ES423R
		1992-1997			ES3177L	ES3176R
11,000		1987-1989	5.44"	w/Air Brakes	ES423L	ES423R
12,000		1990-1991	5.44" 5.44" 6.00"	Tube & Clamp Assy. w/Hyd. Brakes w/Air Brakes to 1984	DS1379S	
		1970-1983			ES423L	ES423R
		1970-1991			ES423L	ES423R
		1992-1997			ES3177L	ES3176R
16,000		1990-1990	5.44" 5.75" 6.00"	Tube & Clamp Assy.	DS1380S	
		1975-1990			ES423L	ES423R
		1970-1975			ES431L	ES431R
		1991-1997			ES3177L	ES3176R
18,000		1994-1997	5.44" 6.00"	Cross Tube Assy. w/ends Tube & Clamp Assy.	DS1368A DS1380S	
		1990-1990			ES423L	ES423R
		1980-1990			ES3177L	ES3176R
		1991-1994				
20,000		1994-1997	5.44" 6.00"	Cross Tube Assy. w/ends Tube & Clamp Assy.	DS1368A DS1380S	
		1990-1990			ES423L	ES423R
		1980-1990			ES3177L	ES3176R
		1991-1997				

Drag Links

Axle Lbs. Rating	Code	Year	Length (inches)	Notes	Drag Link No.
9,000		1973-1991	18.03"	18.03" Stud Center to Stud Center	DS908
		1990-1990	32.62"		DS1207
		1992-1997	17.91"		DS1270
10,000		1987-1991	18.03"		DS908
		1990-1990	32.62"		DS1207
		1992-1997	17.91"		DS1270
11,000		1987-1989	18.03"	w/Air Brakes	DS908
		1992-1997	17.91"		DS1270
12,000		1973-1991	18.03"		DS908
		1990-1990	32.62"		DS1207
		1992-1997	17.91"		DS1270
16,000		1973-1991	18.03"		DS908
		1992-1997	17.91"		DS1270
18,000		1980-1991	18.03"		DS908
		1992-1997	17.91"		DS1270
20,000		1980-1991	18.03"		DS908
		1992-1997	17.91"		DS1270

LNT880, LT880

King Bolt Sets

Axle Lbs. Rating	Code	Year	Diameter (inches)	Length (Inches)	Pin Type	Bushing	Notes	King Pin Set No.
7,000		1972-1977	1.231"	8.910"	4	Metal		8500B
		1972-1977	1.241"	8.910"	4	Metal		8500B010
		1972-1977	1.231"	8.910"	4	Nylon		8500N
9,000		1972-1977	1.434"	8.500"	2	Metal		8519B
		1972-1977	1.444"	8.500"	2	Metal		8519B010
		1972-1977	1.434"	8.500"	2	Nylon		8519N
12,000		1972-1977	1.794"	9.120"	2	Metal		8489B
		1972-1977	1.794"	9.120"	2	Nylon		8489N

Tie Rod Ends

Axle Lbs. Rating	Code	Year	Length (Inches)	Notes	Tie Rod End Part No.	
					Drivers Side	Passenger Side
7,000		1972-1977	4.45"		ES373L	ES373R
9,000		1972-1977	4.45"		ES373L	ES373R
12,000		1972-1977	5.44"		ES423L	ES423R

LNT900, LT900, LNT8000, LT8000, LNT9000, LT9000

King Bolt Sets

Axle Lbs. Rating	Code	Year	Diameter (inches)	Length (Inches)	Pin Type	Bushing	Notes	King Pin Set No.
9,000		1997-1997	1.610"	9.080"	2	Composite		8641B
		1970-1972	1.434"	8.500"	2	Metal		8519B
		1973-1975	1.434"	8.500"	2	Metal	w/Air Brakes To W40,001	8519B
		1973-1986	1.434"	8.500"	2	Metal	w/Hyd. Brakes	8519B
		1970-1972	1.444"	8.500"	2	Metal		8519B010
		1973-1975	1.444"	8.500"	2	Metal	w/Air Brakes To W40,001	8519B010
		1973-1986	1.444"	8.500"	2	Metal	w/Hyd. Brakes	8519B010
		1987-1988	1.433"	8.250"	2	Metal		8568B
		1990-1997	1.607"	9.080"	2	Metal	w/Steel Axle	8573B
		1975-1986	1.607"	9.080"	2	Metal	w/Air Brakes From W40,001	8573B
		1970-1972	1.434"	8.500"	2	Nylon		8519N
		1973-1975	1.434"	8.500"	2	Nylon	w/Air Brakes To W40,001	8519N
		1973-1986	1.434"	8.500"	2	Nylon	w/Hyd. Brakes	8519N
10,000		1990-1997	1.743"	10.061"	2	Composite	w/Aluminum Axle	80068C
		1990-1997	1.790"	10.070"	2	Composite	w/Steel Axle	8643B
		1987-1991	1.794"	10.070"	2	Metal	w/Steel Axle	8572B
11,000		1987-1989	1.794"	10.070"	2	Metal	w/Air Brakes	8572B
12,000		1990-1997	1.743"	10.061"	2	Composite	w/Aluminum Axle	80068C
		1989-1997	1.790"	10.070"	2	Composite	w/Steel Axle	8643B
		1970-1986	1.794"	9.120"	2	Metal	w/Hyd. Brakes	8489B
		1973-1975	1.794"	9.120"	2	Metal	w/Air Brakes To W40,001	8489B
		1975-1989	1.794"	10.070"	2	Metal	w/Air Brakes From W40,001	8572B
		1973-1975	1.794"	9.120"	2	Nylon	w/Air Brakes To W40,001	8489N
		1970-1986	1.794"	9.120"	2	Nylon	w/Hyd. Brakes	8489N
16,000		1980-1986	1.999"	11.040"	2	Metal		8518B
		1970-1979	1.999"	11.040"	2	Metal	w/Hyd. Brakes From 1973-79, 1970-72 All E	8518B
		1973-1975	1.999"	11.040"	2	Metal	w/Air Brakes To W40,001	8518B
		1975-1997	1.999"	11.212"	2	Metal	w/Air Brakes From W40,001	8571B
		1970-1986	1.999"	11.040"	2	Nylon		8518N
		1973-1975	1.999"	11.040"	2	Nylon	w/Air Brakes To W40,001	8518N
18,000		1980-1997	1.999"	11.212"	2	Metal		8571B
20,000		1980-1997	1.999"	11.212"	2	Metal		8571B

Tie Rod Ends

Axle Lbs. Rating	Code	Year	Length (Inches)	Notes	Tie Rod End Part No.	
					Drivers Side	Passenger Side
9,000		1997-1997		Tube & Clamp Assy. Use w/ES3283R & ES3284L	DS1363S	
		1973-1986	5.44"	w/Hyd. Brakes	ES423L	ES423R
		1973-1975	5.44"	w/Air Brakes To W40,001	ES423L	ES423R
		1970-1972	5.44"		ES423L	ES423R
		1990-1997	5.86"	w/Steel Axle	ES2035L	ES2036R
		1987-1988	5.86"		ES2035L	ES2036R
		1975-1986	5.86"	w/Air Brakes From W40,001	ES2035L	ES2036R
		1997-1997	7.18"		ES3284L	ES3283R
10,000		1990-1991	5.44"	Tube & Clamp Assy.	DS1379S	
		1987-1991			ES423L	ES423R
		1992-1997	6.00"		ES3177L	ES3176R
11,000		1987-1989	5.44"		ES423L	ES423R
12,000		1990-1991		Tube & Clamp Assy.	DS1379S	
		1970-1983	5.44"	w/Hyd. Brakes	ES423L	ES423R
		1970-1984	5.44"	w/Air Brakes	ES423L	ES423R
		1992-1997	6.00"		ES3177L	ES3176R
16,000		1990-1990		Tube & Clamp Assy.	DS1380S	
		1994-1997		Cross Tube Assy. w/ends	DS1368A	
		1975-1979	5.44"	w/Air Brakes From W40,001	ES423L	ES423R
		1980-1990	5.44"		ES423L	ES423R
		1973-1975	5.75"	w/Air Brakes To W40,001	ES431L	ES431R
		1973-1979	5.75"	w/Hyd. Brakes	ES431L	ES431R
		1970-1972	5.75"		ES431L	ES431R
		1991-1997	6.00"		ES3177L	ES3176R
18,000		1994-1997		Cross Tube Assy. w/ends	DS1368A	
		1990-1990		Tube & Clamp Assy.	DS1380S	
		1980-1990	5.44"		ES423L	ES423R
		1991-1997	6.00"		ES3177L	ES3176R
20,000		1994-1997		Cross Tube Assy. w/ends	DS1368A	

LNT900, LT900, LNT8000, LT8000, LNT9000, LT9000 (Cont'd)

Tie Rod Ends (Cont'd)

Axle Lbs. Rating	Code	Year	Length (Inches)	Notes	Tie Rod End Part No.	
					Drivers Side	Passenger Side
20,000		1990-1990	5.44"	Tube & Clamp Assy.	DS1380S	
		1980-1990			ES423L	ES423R
		1991-1997			ES3177L	ES3176R

Drag Links

Axle Lbs. Rating	Code	Year	Length (inches)	Notes	Drag Link No.
9,000		1973-1991	18.03"		DS908
		1990-1991	32.62"		DS1207
		1990-1997	36.15"		DS1203
		1992-1997	17.91"		DS1270
10,000		1987-1991	18.03"		DS908
		1990-1991	32.62"		DS1207
		1992-1997	17.91"		DS1270
11,000		1987-1989	18.03"		DS908
		1992-1997	17.91"		DS1270
12,000		1973-1990	18.03"		DS908
		1990-1991	32.62"		DS1207
		1992-1997	17.91"		DS1270
16,000		1980-1990	18.03"	w/R.H. Power Steering Gear w/L.H. Power Steering Gear LT, LTA Models w/Left Hand Power Steering LT, LTA Models w/Right Hand Power Steering	DS908
		1991-1997	17.53"		DS1267
		1991-1994	32.53"		DS1265
					DS1266
1992-1997	17.91"	DS1268			
18,000		1980-1990	18.03"	w/L.H. Power Steering Gear w/R.H. Power Steering Gear LT, LTA Models w/Left Hand Power Steering LT, LTA Models w/Right Hand Power Steering	DS908
		1991-1997	17.53"		DS1265
		1991-1994	32.53"		DS1267
					DS1266
1992-1997	17.91"	DS1268			
20,000		1980-1990	18.03"	w/L.H. Power Steering Gear w/R.H. Power Steering Gear LT, LTA Models w/Left Hand Power Steering LT, LTA Models w/Right Hand Power Steering	DS908
		1991-1997	17.53"		DS1265
		1991-1994	32.53"		DS1267
					DS1266
1992-1997	17.91"	DS1268			

Louisville Series L85

King Bolt Sets

Axle Lbs. Rating	Code	Year	Diameter (inches)	Length (Inches)	Pin Type	Bushing	Notes	King Pin Set No.
10,000		1996-1997	1.794"	10.070"	2	Composite	w/Steel Axle	80071C
12,000		1996-1997	1.794"	10.070"	2	Composite	w/Steel Axle	80071C
		1996-1997	1.794"	10.070"	2	Composite	w/Aluminum Axle	80073C
		1996-1997	1.794"	10.070"	2	Metal	w/Aluminum Axle	80072B
13,200		1996-1997	1.794"	10.070"	2	Composite	Steel Axle	80071C

Tie Rod Ends

Axle Lbs. Rating	Code	Year	Length (Inches)	Notes	Tie Rod End Part No.	
					Drivers Side	Passenger Side
10,000		1996-1998	7.38"		ES3443L	ES3442R
12,000		1996-1998	7.38"		ES3443L	ES3442R
13,200		1996-1998	7.38"		ES3443L	ES3442R

Louisville Series, L85, LT85, L95, LT95

King Bolt Sets

Axle Lbs. Rating	Code	Year	Diameter (inches)	Length (Inches)	Pin Type	Bushing	Notes	King Pin Set No.
9,000		1997-1998	1.610"	9.080"	2	Composite		8641B
18,000		1996-1998	1.999"	11.212"	2	Metal		8571B
20,000		1996-1998	1.999"	11.212"	2	Metal		8571B

Tie Rod Ends

Axle Lbs. Rating	Code	Year	Length (Inches)	Notes	Tie Rod End Part No.	
					Drivers Side	Passenger Side
9,000		1997-1998	7.18"		ES3284L	ES3283R

FORD TRUCK

Louisville Series, L85, LT85, L95, LT95 (Cont'd)

Tie Rod Ends (Cont'd)

Axle Lbs. Rating	Code	Year	Length (Inches)	Notes	Tie Rod End Part No.	
					Drivers Side	Passenger Side
18,000		1996-1998		Cross Tube Assy. w/ends	DS1368A	
		1996-1998	6.00"		ES3177L	ES3176R
		1996-1998	7.38"		ES3443L	ES3442R
20,000		1996-1998		Cross Tube Assy. w/ends	DS1368A	
		1996-1998	6.00"		ES3177L	ES3176R
		1996-1998	7.38"		ES3443L	ES3442R

Drag Links

Axle Lbs. Rating	Code	Year	Length (inches)	Notes	Drag Link No.
9,000		1997-1998	18.21"		DS1447
12,000		1997-1998	26.83"	W/60" Taper Springs	DS1443
13,000		1997-1998	18.24"		DS1442
			26.83"	W/60" Taper Springs	DS1443
14,600		1997-1998	18.42"	W/54" Taper Spring Highway Tractor	DS1446
			18.65"		DS1445
			27.45"		DS1444
					DS1446
16,000		1997-1998	18.42"	W/54" Taper Spring	DS1446
18,000		1997-1998	18.21"		DS1448
					DS1447
20,000		1997-1998	18.21"		DS1448
					DS1447

LS800

King Bolt Sets

Axle Lbs. Rating	Code	Year	Diameter (inches)	Length (Inches)	Pin Type	Bushing	Notes	King Pin Set No.
7,000		1989-1998	1.300"	7.757"	2	Metal		8639B

LS800, LT800, LTL800, LTS800, LTS8000

King Bolt Sets

Axle Lbs. Rating	Code	Year	Diameter (inches)	Length (Inches)	Pin Type	Bushing	Notes	King Pin Set No.
6,000		1967-1975	1.231"	8.910"	4	Metal		8500B
		1967-1975	1.241"	8.910"	4	Metal		8500B010
		1967-1975	1.231"	8.910"	4	Nylon		8500N
7,000		1967-1979	1.231"	8.910"	4	Metal	w/Hyd. Brakes From 1973, 1970-72 All Bra	8500B
		1973-1975	1.231"	8.910"	4	Metal	w/Air Brakes To W40,001	8500B
		1967-1979	1.241"	8.910"	4	Metal	w/Hyd. Brakes From 1973, 1970-72 All Bra	8500B010
		1973-1975	1.241"	8.910"	4	Metal	w/Air Brakes To W40,001	8500B010
		1975-1979	1.433"	8.250"	2	Metal	w/Air Brakes From W40,001	8568B
		1967-1979	1.231"	8.910"	4	Nylon	w/Hyd. Brakes From 1973, 1970-72 All Bra	8500N
		1973-1975	1.231"	8.910"	4	Nylon	w/Air Brakes To W40,001	8500N
9,000		1997-1997	1.610"	9.080"	2	Composite		8641B
		1989-1997	1.610"	9.080"	2	Composite		8641B
		1962-1986	1.434"	8.500"	2	Metal	w/Hyd. Brakes From 1973, 1970-72 All Bra	8519B
		1973-1975	1.434"	8.500"	2	Metal	w/Air Brakes To W40,001	8519B
		1962-1986	1.444"	8.500"	2	Metal	w/Hyd. Brakes From 1973, 1970-72 All Bra	8519B010
		1973-1975	1.444"	8.500"	2	Metal	w/Air Brakes To W40,001	8519B010
		1987-1988	1.433"	8.250"	2	Metal		8568B
		1975-1986	1.607"	9.080"	2	Metal	w/Air Brakes From W40,001	8573B
		1990-1997	1.607"	9.080"	2	Metal	w/Steel Axle	8573B
		1962-1986	1.434"	8.500"	2	Nylon	w/Hyd. Brakes From 1973, 1970-72 All Bra	8519N
1973-1975	1.434"	8.500"	2	Nylon	w/Air Brakes To W40,001	8519N		
10,000		1990-1997	1.743"	10.061"	2	Composite	w/Aluminum Axle	80068C
		1990-1997	1.790"	10.070"	2	Composite	w/Steel Axle	8643B
		1987-1990	1.794"	10.070"	2	Metal	w/Steel Axle	8572B
11,000		1987-1989	1.794"	10.070"	2	Metal	w/Air Brakes	8572B
12,000		1990-1997	1.743"	10.061"	2	Composite	w/Aluminum Axle	80068C
		1989-1997	1.790"	10.070"	2	Composite	w/Steel Axle	8643B
		1973-1975	1.794"	9.120"	2	Metal	w/Air Brakes To W40,001	8489B
		1970-1984	1.794"	9.120"	2	Metal	w/Hyd. Brakes From 1973	8489B
		1975-1989	1.794"	10.070"	2	Metal	w/Air Brakes From W40,001	8572B
		1970-1984	1.794"	9.120"	2	Nylon	w/Hyd. Brakes From 1973	8489N
		1973-1975	1.794"	9.120"	2	Nylon	w/Air Brakes To W40,001	8489N
16,000		1973-1979	1.999"	11.040"	2	Metal	W/Hydraulic Brakes	8518B
		1973-1975	1.999"	11.040"	2	Metal	W/Air Brakes To W40,001	8518B
		1970-1972	1.999"	11.040"	2	Metal		8518B

LS800, LT800, LTL800, LTS800, LTS8000 (Cont'd)

King Bolt Sets (Cont'd)

Axle Lbs. Rating	Code	Year	Diameter (inches)	Length (Inches)	Pin Type	Bushing	Notes	King Pin Set No.
16,000		1980-1997	1.999"	11.212"	2	Metal	W/Hydraulic Brakes	8571B
		1973-1979	1.999"	11.040"	2	Nylon		8518N
		1970-1972	1.999"	11.040"	2	Nylon		8518N
18,000		1970-1975	1.999"	11.040"	2	Metal	To W/40,001	8518B
		1980-1997	1.999"	11.212"	2	Metal		8571B
		1970-1975	1.999"	11.040"	2	Nylon	To W/40,001	8518N
20,000		1970-1975	1.999"	11.040"	2	Metal	To W/40,001	8518B
		1980-1997	1.999"	11.212"	2	Metal		8571B
		1970-1975	1.999"	11.040"	2	Nylon	To W/40,001	8518N

Tie Rod Ends

Axle Lbs. Rating	Code	Year	Length (Inches)	Notes	Tie Rod End Part No.	
					Drivers Side	Passenger Side
6,000		1967-1975	4.45"		ES373L	ES373R
7,000		1973-1975	4.45"	w/Air Brakes To W40,001	ES373L	ES373R
		1973-1979	4.45"	w/Hyd. Brakes	ES373L	ES373R
		1967-1972	4.45"		ES373L	ES373R
		1975-1979	5.86"	w/Air Brakes From W40,001	ES2035L	ES2036R
9,000		1990-1997		Tube & Clamp Assy. Use w/ES3284L & ES3283R	DS1363S	
		1970-1972	4.45"		ES373L	ES373R
		1973-1975	4.45"	w/Air Brakes To W40,001	ES373L	ES373R
		1962-1969	4.88"		ES187L	ES187R
		1973-1986	5.44"	w/Hyd. Brakes	ES423L	ES423R
		1975-1989	5.86"	1980-86 w/Air Brakes From W40,001, 1987-89 All	ES2035L	ES2036R
		1990-1997	5.86"	w/Steel Axle	ES2035L	ES2036R
10,000		1990-1991		Tube & Clamp Assy.	DS1379S	
		1987-1991		Cross Tube Assy. w/ends	DS1367A	
		1987-1991	5.44"		ES423L	ES423R
		1992-1997	6.00"		ES3177L	ES3176R
11,000		1987-1989	5.44"		ES423L	ES423R
12,000		1980-1990		Cross Tube Assy. w/ends	DS1367A	
		1990-1991		Tube & Clamp Assy.	DS1379S	
		1980-1983	5.44"	w/Hyd. Brakes	ES423L	ES423R
		1970-1991	5.44"	After G70,000	ES423L	ES423R
		1980-1984	5.44"	w/Air Brakes	ES423L	ES423R
		1985-1990	5.44"		ES423L	ES423R
16,000		1994-1997		Cross Tube Assy. w/ends	DS1368A	
		1990-1990		Tube & Clamp Assy.	DS1380S	
		1980-1990	5.44"		ES423L	ES423R
18,000		1990-1990		Tube & Clamp Assy.	DS1380S	
		1980-1990	5.44"	From W40,001	ES423L	ES423R
		1970-1975	5.75"	To W40,001	ES376L	ES376R
20,000		1994-1997		Cross Tube Assy. w/ends	DS1368A	
		1990-1990		Tube & Clamp Assy.	DS1380S	
		1980-1990	5.44"	From W40,001	ES423L	ES423R
		1970-1975	5.75"	To W40,001	ES376L	ES376R
		1991-1997	6.00"		ES3177L	ES3176R

Drag Links

Axle Lbs. Rating	Code	Year	Length (inches)	Notes	Drag Link No.
6,000		1973-1975	18.03"		DS908
7,000		1973-1979	18.03"		DS908
9,000		1973-1991	18.03"		DS908
		1980-1987	36.63"	Until 9/1987; LTS Models	DS953
		1987-1997	36.15"	From 9/1987; LS-LTS Models	DS1203
		1990-1991	32.62"	LT-LTL 800 Models	DS1207
		1992-1994	17.91"		DS1270
10,000		1987-1990	18.03"	LT-LTL Models	DS908
		1987-1997	36.15"	From 9/1987; LS-LTS Models	DS1203
		1987-1987	36.63"	LTS Models	DS953
		1990-1991	32.62"	LT-LTS Models	DS1207
		1992-1994	17.91"		DS1270

FORD TRUCK



LS800, LT800, LTL800, LTS800, LTS8000 (Cont'd)

Drag Links (Cont'd)

Axle Lbs. Rating	Code	Year	Length (inches)	Notes	Drag Link No.	
					Drivers Side	Passenger Side
11,000		1987-1989	18.03"	LT-LTL Models From 9/1987; LS-LTS Models LTS Models	DS908	
		1987-1987	36.15"		DS1203	
		1992-1994	36.63" 17.91"		DS953 DS1270	
12,000		1973-1990	18.03"	LT-LTL Models Until 9/1987; LS-LTS Models From 9/1987; LS-LTS-LA-LTA Models LT, LS-LTS Models Exc. w/5400-12,000 lb. Front Spring Capacity (Taper Leaf)	DS908	
		1980-1991	36.63"		DS953	
		1980-1987	36.15"		DS1203	
		1987-1994	32.62"		DS1207	
		1992-1994	17.91"		DS1270	
16,000		1980-1990	18.03"	LT-LTL Models Until 9/1987; LTS Models From 9/1987; LS-LTS Models w/L.H. Power Steering Gear w/R.H. Power Steering Gear w/L.H. Power Steering Gear w/Right Hand Power Steering w/Left Hand Power Steering w/Right Hand Power Steering w/Left Hand Power Steering	DS908	
		1980-1987	36.63"		DS953	
		1987-1990	36.15"		DS1203	
		1991-1997	17.53"		DS1265	
			32.53"		DS1267	
			32.53"		DS1265	
		1992-1994	17.91"		DS1268 DS1266 DS1268 DS1266 DS1270	
18,000		1980-1989	18.03"	LT-LTL Models Until 9/1987; LTS Models From 9/1987; LS-LTS Models w/R.H. Power Steering Gear w/L.H. Power Steering Gear w/Right Hand Power Steering w/Left Hand Power Steering	DS908	
		1980-1987	36.63"		DS953	
		1987-1990	36.15"		DS1203	
		1991-1997	17.53"		DS1267	
			32.53"		DS1265	
		1992-1994	17.91"		DS1268 DS1266 DS1270	
20,000		1980-1989	18.03"	LT-LTL Models Until 9/1987; LTS Models From 9/1987; LS-LTS Models w/R.H. Power Steering Gear w/L.H. Power Steering Gear w/Left Hand Power Steering w/Right Hand Power Steering w/Left Hand Power Steering	DS908	
		1980-1987	36.63"		DS953	
		1987-1997	36.15"		DS1203	
		1991-1997	17.53"		DS1267	
			32.53"		DS1265	
		1992-1994	17.91"		DS1266 DS1268 DS1266 DS1270	

LT800

Tie Rod Ends

Axle Lbs. Rating	Code	Year	Length (Inches)	Notes	Tie Rod End Part No.	
					Drivers Side	Passenger Side
18,000		1991-1998	6.00"		ES3177L	ES3176R

LTL900, LTA 900, LTL9000

King Bolt Sets

Axle Lbs. Rating	Code	Year	Diameter (inches)	Length (Inches)	Pin Type	Bushing	Notes	King Pin Set No.
9,000		1997-1997	1.610"	9.080"	2	Composite		8641B
		1990-1997	1.607"	9.080"	2	Metal		8573B
10,000		1990-1997	1.743"	10.061"	2	Composite	w/Aluminum Axle	80068C
		1990-1997	1.790"	10.070"	2	Composite	w/Steel Axle	8643B
12,000		1990-1997	1.743"	10.061"	2	Composite	w/Aluminum Axle	80068C
		1989-1997	1.790"	10.070"	2	Composite	w/Steel Axle	8643B
		1982-1986	1.794"	9.120"	2	Metal	w/Hyd. Brakes	8489B
		1982-1994	1.794"	10.070"	2	Metal	w/Air Brakes	8572B
		1982-1986	1.794"	9.120"	2	Nylon	w/Hyd. Brakes	8489N
16,000		1982-1997	1.999"	11.212"	2	Metal		8571B
18,000		1982-1997	1.999"	11.212"	2	Metal		8571B
20,000		1982-1997	1.999"	11.212"	2	Metal		8571B

Tie Rod Ends

Axle Lbs. Rating	Code	Year	Length (Inches)	Notes	Tie Rod End Part No.	
					Drivers Side	Passenger Side
9,000		1997-1997		Tube & Clamp Assy. Use w/ES3283R & ES3284L	DS1363S	
		1990-1997	5.86"		ES2035L	ES2036R
		1997-1997	7.18"		ES3284L	ES3283R
10,000		1992-1997	6.00"		ES3177L	ES3176R

Heavy Duty Trucks

LTL900, LTA 900, LTL9000 (Cont'd)

Tie Rod Ends (Cont'd)

Axle Lbs. Rating	Code	Year	Length (Inches)	Notes	Tie Rod End Part No.	
					Drivers Side	Passenger Side
12,000		1982-1991	5.44" 6.00"	Cross Tube Assy. w/ends Tube & Clamp Assy.	DS1367A DS1379S	
		1982-1991			ES423L	ES423R
		1992-1997			ES3177L	ES3176R
16,000		1990-1990	5.44" 6.00"	Tube & Clamp Assy. Cross Tube Assy. w/ends	DS1380S DS1368A	
		1994-1997			ES423L	ES423R
		1982-1990			ES3177L	ES3176R
		1991-1997				
18,000		1994-1997	5.44" 6.00"	Cross Tube Assy. w/ends Tube & Clamp Assy.	DS1368A DS1380S	
		1990-1990			ES423L	ES423R
		1982-1990			ES3177L	ES3176R
		1991-1997				
20,000		1994-1997	5.44" 6.00"	Cross Tube Assy. w/ends Tube & Clamp Assy.	DS1368A DS1380S	
		1990-1990			ES423L	ES423R
		1982-1990			ES3177L	ES3176R
		1991-1997				

Drag Links

Axle Lbs. Rating	Code	Year	Length (inches)	Notes	Drag Link No.
9,000		1990-1997	36.15"		DS1203
10,000		1990-1997	36.15"		DS1203
12,000		1982-1986	18.03" 36.63"		DS908 DS953
		1990-1997	36.15"		DS1203
16,000		1982-1986	18.03" 36.63"	w/L.H. Power Steering Gear w/R.H. Power Steering Gear w/L.H. Power Steering Gear w/R.H. Power Steering Gear	DS908 DS953 DS1265
		1991-1997	17.53"		DS1267 DS1266 DS1268
			32.53"		
18,000		1982-1986	18.03" 36.63"	w/L.H. Power Steering Gear w/R.H. Power Steering Gear w/L.H. Power Steering Gear w/R.H. Power Steering Gear	DS908 DS953 DS1265
		1991-1997	17.53"		DS1267 DS1266 DS1268
			32.53"		
20,000		1982-1986	18.03" 36.63"	w/L.H. Power Steering Gear w/R.H. Power Steering Gear w/L.H. Power Steering Gear w/R.H. Power Steering Gear	DS908 DS953 DS1265
		1991-1997	17.53"		DS1267 DS1266 DS1268
			32.53"		

LTL9000

Drag Links

Axle Lbs. Rating	Code	Year	Length (inches)	Notes	Drag Link No.
9,000		1992-1997	17.91"		DS1270
10,000		1992-1997	17.91"		DS1270
12,000		1992-1997	17.91"		DS1270

LTS900, LS900, LTS9000, LS9000

King Bolt Sets

Axle Lbs. Rating	Code	Year	Diameter (inches)	Length (Inches)	Pin Type	Bushing	Notes	King Pin Set No.
9,000		1989-1989	1.610"	9.080"	2	Composite		8641B
		1997-1997	1.610"	9.080"	2	Composite		8641B
		1970-1972	1.434"	8.500"	2	Metal		8519B
		1973-1986	1.434"	8.500"	2	Metal	w/Hyd. Brakes	8519B
		1973-1975	1.434"	8.500"	2	Metal	w/Air Brakes To W40,001	8519B
		1973-1986	1.444"	8.500"	2	Metal	w/Hyd. Brakes	8519B010
		1973-1975	1.444"	8.500"	2	Metal	w/Air Brakes To W40,001	8519B010
		1970-1972	1.444"	8.500"	2	Metal		8519B010
		1987-1988	1.433"	8.250"	2	Metal		8568B
		1990-1997	1.607"	9.080"	2	Metal	w/Steel Axle	8573B
		1975-1986	1.607"	9.080"	2	Metal	w/Air Brakes From W40,001	8573B

FORD TRUCK



LTS900, LS900, LTS9000, LS9000 (Cont'd)

King Bolt Sets (Cont'd)

Axle Lbs. Rating	Code	Year	Diameter (inches)	Length (Inches)	Pin Type	Bushing	Notes	King Pin Set No.
9,000		1973-1986	1.434"	8.500"	2	Nylon	w/Hyd. Brakes	8519N
		1973-1975	1.434"	8.500"	2	Nylon	w/Air Brakes To W40,001	8519N
		1970-1972	1.434"	8.500"	2	Nylon		8519N
10,000		1990-1997	1.743"	10.061"	2	Composite	w/Aluminum Axle	80068C
		1990-1997	1.790"	10.070"	2	Composite	w/Steel Axle	8643B
		1987-1991	1.794"	10.070"	2	Metal	w/Steel Axle	8572B
11,000		1987-1989	1.794"	10.070"	2	Metal	w/Air Brakes	8572B
12,000		1990-1997	1.743"	10.061"	2	Composite	w/Aluminum Axle	80068C
		1989-1991	1.790"	10.070"	2	Composite	w/Steel Axle	8643B
		1970-1972	1.794"	9.120"	2	Metal		8489B
		1973-1975	1.794"	9.120"	2	Metal	w/Air Brakes To W40,001	8489B
		1973-1983	1.794"	9.120"	2	Metal	w/Hyd. Brakes	8489B
		1970-1989	1.794"	10.070"	2	Metal	w/Air Brakes From W40,001	8572B
		1970-1972	1.794"	9.120"	2	Nylon		8489N
		1973-1975	1.794"	9.120"	2	Nylon	w/Air Brakes To W40,001	8489N
		1973-1983	1.794"	9.120"	2	Nylon	w/Hyd. Brakes	8489N
		16,000		1970-1972	1.999"	11.040"	2	Metal
1973-1975	1.999"			11.040"	2	Metal	w/Air Brakes To W40,001	8518B
1973-1979	1.999"			11.040"	2	Metal	w/Hyd. Brakes	8518B
1975-1997	1.999"			11.212"	2	Metal	w/Air Brakes From W40,001	8571B
1970-1972	1.999"			11.040"	2	Nylon		8518N
1973-1975	1.999"			11.040"	2	Nylon	w/Air Brakes To W40,001	8518N
1973-1979	1.999"			11.040"	2	Nylon	w/Hyd. Brakes	8518N
18,000		1970-1975	1.999"	11.040"	2	Metal	To W40,001	8518B
		1975-1997	1.999"	11.212"	2	Metal	From W40,001"	8571B
		1970-1975	1.999"	11.040"	2	Nylon	To W40,001	8518N
20,000		1970-1975	1.999"	11.040"	2	Metal	To W40,001	8518B
		1975-1997	1.999"	11.212"	2	Metal	From W40,001"	8571B
		1970-1975	1.999"	11.040"	2	Nylon	To W40,001	8518N

Tie Rod Ends

Axle Lbs. Rating	Code	Year	Length (Inches)	Notes	Tie Rod End Part No.	
					Drivers Side	Passenger Side
9,000		1990-1997	5.44"	Tube & Clamp Assy. Use w/ES3283R & ES3284L	DS1363S	
		1973-1981		w/Hyd. Brakes	ES423L	ES423R
		1973-1975		w/Air Brakes To W40,001	ES423L	ES423R
		1970-1972			ES423L	ES423R
		1975-1989		w/Air Brakes From W40,001	ES2035L	ES2036R
		1990-1997		w/Steel Axle	ES2035L	ES2036R
		1990-1997		7.18"		ES3284L
10,000		1990-1991	5.44"	Tube & Clamp Assy.	DS1379S	
		1987-1991		Cross Tube Assy. w/ends	DS1367A	
		1987-1991		Cross Tube Assy. w/ends	DS1367A	
		1987-1991			ES423L	ES423R
		1992-1997		6.00"	ES3177L	ES3176R
11,000		1987-1989	5.44"	w/Air Brakes	ES423L	ES423R
12,000		1990-1991	5.44"	Tube & Clamp Assy.	DS1379S	
		1970-1991			ES423L	ES423R
		1992-1997		6.00"	ES3177L	ES3176R
16,000		1990-1990	5.44"	Tube & Clamp Assy.	DS1380S	
		1994-1997		Cross Tube Assy. w/ends	DS1368A	
		1975-1990		w/Air Brakes From W40,001, 1980-81 All Brakes	ES423L	ES423R
		1973-1975		w/Air Brakes To W40,001	ES431L	ES431R
		1973-1979		w/Hyd. Brakes	ES431L	ES431R
		1970-1972			ES431L	ES431R
		1991-1997		6.00"	ES3177L	ES3176R
18,000		1994-1997	5.44"	Cross Tube Assy. w/ends	DS1368A	
		1990-1990		Tube & Clamp Assy.	DS1380S	
		1975-1990		From W40,001	ES423L	ES423R
		1970-1975		To W40,001	ES431L	ES431R
		1991-1997		6.00"	ES3177L	ES3176R
20,000		1994-1997	5.44"	Cross Tube Assy. w/ends	DS1368A	
		1990-1990		Tube & Clamp Assy.	DS1380S	
		1975-1990		From W40,001	ES423L	ES423R
		1970-1975		To W40,001	ES431L	ES431R
		1991-1997		6.00"	ES3177L	ES3176R

Heavy Duty Trucks

LTS900, LS900, LTS9000, LS9000 (Cont'd)

Drag Links

Axle Lbs. Rating	Code	Year	Length (inches)	Notes	Drag Link No.
9,000		1973-1987 1987-1991 1990-1991	36.63" 36.15" 32.62"	Until 9/1987; LTS Models From 9/1987	DS953 DS1203 DS1207
10,000		1987-1989 1987-1987 1990-1991 1990-1997 1990-1990	36.15" 36.63" 32.62" 36.15"	From 9/1987 Between 1/1987 and 9/1987; LTS Models LS, LTS Models w/Unitized Tractor Application	DS1203 DS953 DS1207 DS1203
11,000		1987-1989 1987-1987	36.15" 36.63"	From 9/1987 LTS Models	DS1203 DS953
12,000		1973-1987 1980-1987 1987-1997 1990-1991	36.63" 36.15" 32.62"	Until 9/1987 From 9/1987 Exc. 5400/12,000 lb. Front Spring Capacity (Taper Leaf)	DS953 DS1203 DS1207
16,000		1973-1987 1987-1997 1991-1997	36.63" 36.15" 32.53"	Until 9/1987 From 9/1987 LS Models w/Left Hand Power Steering LS Models w/Right Hand Power Steering	DS953 DS1203 DS1266 DS1268
18,000		1973-1987 1987-1997 1991-1997	36.63" 36.15" 32.53"	Until 9/1987 From 9/1987 LS Models w/Left Hand Power Steering LS Models w/Right Hand	DS953 DS1203 DS1266 DS1268
20,000		1973-1987 1987-1997 1991-1997	36.63" 36.15" 32.53"	Until 9/1987 From 9/1987 LS Models w/Left Hand LS Models w/Right Hand	DS953 DS1203 DS1266 DS1268

M400 Motor Home Chassis

King Bolt Sets

Axle Lbs. Rating	Code	Year	Diameter (inches)	Length (Inches)	Pin Type	Bushing	Notes	King Pin Set No.
		1973-1976	1.231"	7.860"	4	Metal		8488B
		1973-1976	1.241"	7.860"	4	Metal		8488B010
		1973-1976	1.231"	7.860"	1	Metal	Heavy Duty	8609B

Tie Rod Ends

Axle Lbs. Rating	Code	Year	Length (Inches)	Notes	Tie Rod End Part No.	
					Drivers Side	Passenger Side
		1973-1976	4.45"		ES373L	ES373R

N1100

King Bolt Sets

Axle Lbs. Rating	Code	Year	Diameter (inches)	Length (Inches)	Pin Type	Bushing	Notes	King Pin Set No.
9,000		1964-1965 1964-1965 1964-1965	1.434" 1.444" 1.434"	8.500" 8.500" 8.500"	2 2 2	Metal Metal Nylon		8519B 8519B010 8519N
11,000		1964-1965 1964-1965	1.607" 1.607"	8.812" 8.812"	2 2	Metal Nylon	(Center Point Steering) (Center Point Steering)	8514B 8514N
12,000		1964-1965 1964-1965	1.794" 1.794"	9.120" 9.120"	2 2	Metal Nylon		8489B 8489N

Tie Rod Ends

Axle Lbs. Rating	Code	Year	Length (Inches)	Notes	Tie Rod End Part No.	
					Drivers Side	Passenger Side
9,000		1964-1965	4.88"		ES187L	ES187R
12,000		1964-1965	5.75"	Anti-Tilt Seal Type	ES346L	ES346R

N500

King Bolt Sets

Axle Lbs. Rating	Code	Year	Diameter (inches)	Length (Inches)	Pin Type	Bushing	Notes	King Pin Set No.
5,000		1963-1969 1963-1969 1963-1969	1.231" 1.241" 1.231"	7.860" 7.860" 7.860"	4 4 1	Metal Metal Metal		8488B 8488B010 8609B

FORD TRUCK

N500 (Cont'd)

Tie Rod Ends

Axle Lbs. Rating	Code	Year	Length (Inches)	Notes	Tie Rod End Part No.	
					Drivers Side	Passenger Side
5,000		1963-1966	3.50"		ES150L	ES150R
		1967-1969	4.45"		ES373L	ES373R

N600, N6000

King Bolt Sets

Axle Lbs. Rating	Code	Year	Diameter (inches)	Length (Inches)	Pin Type	Bushing	Notes	King Pin Set No.
5,000		1963-1969	1.231"	7.860"	4	Metal	Heavy Duty	8488B
		1963-1969	1.241"	7.860"	4	Metal		8488B010
		1963-1969	1.231"	7.860"	1	Metal		8609B
5,500		1963-1969	1.231"	7.860"	4	Metal	Heavy Duty	8488B
		1963-1969	1.241"	7.860"	4	Metal		8488B010
		1963-1969	1.231"	7.860"	1	Metal		8609B
6,000		1963-1966	1.234"	7.500"	1	Metal	From C70,001	8357B
		1967-1969	1.231"	8.910"	4	Metal		8500B
		1967-1969	1.241"	8.910"	4	Metal		8500B010
		1963-1966	1.234"	7.500"	1	Nylon		8357N
7,000		1967-1969	1.231"	8.910"	4	Nylon	From C70,001	8500N
		1963-1966	1.234"	7.440"	2	Metal		8479B
		1967-1969	1.231"	8.910"	4	Metal		8500B
		1967-1969	1.241"	8.910"	4	Metal		8500B010
7,000		1963-1966	1.244"	7.440"	2	Metal		8507B010
		1963-1966	1.234"	7.440"	2	Nylon		8479N
		1967-1969	1.231"	8.910"	4	Nylon		8500N

Tie Rod Ends

Axle Lbs. Rating	Code	Year	Length (Inches)	Notes	Tie Rod End Part No.	
					Drivers Side	Passenger Side
5,000		1963-1966	3.50"	w/Manual Steering	ES150L	ES150R
		1967-1969	4.45"		ES373L	ES373R
5,500		1963-1966	3.50"	w/Manual Steering	ES150L	ES150R
		1967-1969	4.45"		ES373L	ES373R
6,000		1963-1969	3.75"		ES194L	ES194R
		1963-1969	4.44"		ES2083L	ES2082R
		1967-1969	4.45"		ES373L	ES373R
7,000		1963-1966	3.90"		ES304L	ES304R
		1967-1969	4.45"		ES373L	ES373R

N8000

King Bolt Sets

Axle Lbs. Rating	Code	Year	Diameter (inches)	Length (Inches)	Pin Type	Bushing	Notes	King Pin Set No.
7,000		1968-1969	1.234"	7.440"	2	Metal		8479B
		1968-1969	1.244"	7.440"	2	Metal		8507B010
		1968-1969	1.234"	7.440"	2	Nylon		8479N
9,000		1968-1969	1.434"	8.500"	2	Metal		8519B
		1968-1969	1.444"	8.500"	2	Metal		8519B010
		1968-1969	1.434"	8.500"	2	Nylon		8519N
12,000		1968-1969	1.794"	9.120"	2	Metal	(Center Point Steering)	8489B
		1968-1969	1.999"	11.040"	2	Metal		8518B
		1968-1969	1.794"	9.120"	2	Nylon		8489N
		1968-1969	1.999"	11.040"	2	Nylon		8518N

Tie Rod Ends

Axle Lbs. Rating	Code	Year	Length (Inches)	Notes	Tie Rod End Part No.	
					Drivers Side	Passenger Side
7,000		1968-1969	3.90"		ES304L	ES304R
9,000		1968-1969	4.88"		ES187L	ES187R
12,000		1968-1969	5.75"	Anti-Tilt Seal Type	ES346L	ES346R

N850, N950

King Bolt Sets

Axle Lbs. Rating	Code	Year	Diameter (inches)	Length (Inches)	Pin Type	Bushing	Notes	King Pin Set No.
7,000		1964-1969	1.234"	7.440"	2	Metal		8479B
		1964-1969	1.244"	7.440"	2	Metal		8507B010
		1964-1969	1.234"	7.440"	2	Nylon		8479N
9,000		1962-1969	1.434"	8.500"	2	Metal		8519B
		1962-1969	1.444"	8.500"	2	Metal		8519B010
		1962-1969	1.434"	8.500"	2	Nylon		8519N
11,000		1962-1969	1.607"	8.812"	2	Metal	(Center Point Steering)	8514B
		1962-1969	1.607"	8.812"	2	Nylon	(Center Point Steering)	8514N
12,000		1962-1969	1.794"	9.120"	2	Metal	(Center Point Steering)	8489B
		1962-1969	1.607"	8.812"	2	Metal		8514B
		1962-1969	1.794"	9.120"	2	Nylon		8489N
		1962-1969	1.607"	8.812"	2	Nylon		(Center Point Steering)

Tie Rod Ends

Axle Lbs. Rating	Code	Year	Length (Inches)	Notes	Tie Rod End Part No.	
					Drivers Side	Passenger Side
7,000		1964-1969	3.90"		ES304L	ES304R
9,000		1968-1969	4.88"	Exc. Power Steering	ES187L	ES187R
		1962-1967	4.88"		ES187L	ES187R
12,000		1962-1969	5.75"	Anti-Tilt Seal Type	ES346L	ES346R

NT850, N1000

King Bolt Sets

Axle Lbs. Rating	Code	Year	Diameter (inches)	Length (Inches)	Pin Type	Bushing	Notes	King Pin Set No.
9,000		1964-1969	1.434"	8.500"	2	Metal		8519B
		1964-1969	1.444"	8.500"	2	Metal		8519B010
		1964-1969	1.434"	8.500"	2	Nylon		8519N
11,000		1964-1965	1.607"	8.812"	2	Metal	(Center Point Steering)	8514B
		1964-1965	1.607"	8.812"	2	Nylon	(Center Point Steering)	8514N
12,000		1964-1969	1.794"	9.120"	2	Metal	(Center Point Steering)	8489B
		1966-1969	1.607"	8.812"	2	Metal		8514B
		1964-1969	1.794"	9.120"	2	Nylon		8489N
		1966-1969	1.607"	8.812"	2	Nylon		(Center Point Steering)
15,000		1964-1969	1.400/1.794"	10.688"	7	Metal		8474B

Tie Rod Ends

Axle Lbs. Rating	Code	Year	Length (Inches)	Notes	Tie Rod End Part No.	
					Drivers Side	Passenger Side
9,000		1964-1969	4.88"		ES187L	ES187R
12,000		1964-1969	5.75"	Anti-Tilt Seal Type	ES346L	ES346R
15,000		1964-1969	5.75"	Anti-Tilt Seal Type	ES346L	ES346R

NT950

King Bolt Sets

Axle Lbs. Rating	Code	Year	Diameter (inches)	Length (Inches)	Pin Type	Bushing	Notes	King Pin Set No.
9,000		1964-1969	1.434"	8.500"	2	Metal		8519B
		1964-1969	1.444"	8.500"	2	Metal		8519B010
		1964-1969	1.434"	8.500"	2	Nylon		8519N
11,000		1964-1965	1.607"	8.812"	2	Metal	(Center Point Steering)	8514B
		1964-1965	1.607"	8.812"	2	Nylon	(Center Point Steering)	8514N
12,000		1964-1969	1.794"	9.120"	2	Metal	(Center Point Steering)	8489B
		1966-1969	1.607"	8.812"	2	Metal		8514B
		1964-1969	1.794"	9.120"	2	Nylon		8489N
		1966-1969	1.607"	8.812"	2	Nylon		(Center Point Steering)
15,000		1964-1969	1.400/1.794"	10.688"	7	Metal		8474B

Tie Rod Ends

Axle Lbs. Rating	Code	Year	Length (Inches)	Notes	Tie Rod End Part No.	
					Drivers Side	Passenger Side
9,000		1964-1969	4.88"		ES187L	ES187R
12,000		1964-1969	5.75"	Anti-Tilt Seal Type	ES346L	ES346R
15,000		1964-1969	5.75"	Anti-Tilt Seal Type	ES346L	ES346R

P400

King Bolt Sets

Axle Lbs. Rating	Code	Year	Diameter (inches)	Length (Inches)	Pin Type	Bushing	Notes	King Pin Set No.
3,800		1957-1978	0.922"	6.990"	4	Metal		8458B
		1957-1978	0.932"	6.990"	4	Metal		8458B010

Tie Rod Ends

Axle Lbs. Rating	Code	Year	Length (Inches)	Notes	Tie Rod End Part No.	
					Drivers Side	Passenger Side
3,800		1957-1978	3.50"		ES150L	ES150R

Drag Links

Axle Lbs. Rating	Code	Year	Length (inches)	Notes	Drag Link No.
3,800		1957-1978	22.47"	w/Manual Steering	DS685

P500

King Bolt Sets

Axle Lbs. Rating	Code	Year	Diameter (inches)	Length (Inches)	Pin Type	Bushing	Notes	King Pin Set No.
4,700		1957-1962	1.129"	7.670"	4	Metal		8459B
		1957-1962	1.129"	7.670"	4	Metal		8471B
		1963-1978	1.231"	7.860"	4	Metal		8488B
		1963-1978	1.241"	7.860"	4	Metal		8488B010
		1963-1978	1.231"	7.860"	1	Metal		Heavy Duty

Tie Rod Ends

Axle Lbs. Rating	Code	Year	Length (Inches)	Notes	Tie Rod End Part No.	
					Drivers Side	Passenger Side
4,700		1957-1978	3.50"		ES150L	ES150R

Drag Links

Axle Lbs. Rating	Code	Year	Length (inches)	Notes	Drag Link No.
4,700		1957-1977	22.47"	1961-62 w/Manual Steering	DS685

P600

King Bolt Sets

Axle Lbs. Rating	Code	Year	Diameter (inches)	Length (Inches)	Pin Type	Bushing	Notes	King Pin Set No.
4,700		1978-1979	1.231"	7.860"	4	Metal		8488B
		1978-1979	1.241"	7.860"	4	Metal		8488B010
		1978-1979	1.231"	7.860"	1	Metal		Heavy Duty
5,000		1978-1979	1.231"	7.860"	4	Metal		8488B
		1978-1979	1.241"	7.860"	4	Metal		8488B010
		1978-1979	1.231"	7.860"	1	Metal		Heavy Duty

Tie Rod Ends

Axle Lbs. Rating	Code	Year	Length (Inches)	Notes	Tie Rod End Part No.	
					Drivers Side	Passenger Side
4,700		1978-1979	3.50"		ES150L	ES150R
5,000		1978-1979	4.45"	Uses DS925S Sleeve	ES373L	ES373R

Drag Links

Axle Lbs. Rating	Code	Year	Length (inches)	Notes	Drag Link No.
4,700		1978-1979	22.47"		DS685

T800

King Bolt Sets

Axle Lbs. Rating	Code	Year	Diameter (inches)	Length (Inches)	Pin Type	Bushing	Notes	King Pin Set No.
6,000		1967-1967	1.234"	7.500"	1	Metal		8357B

T800 (Cont'd)

King Bolt Sets (Cont'd)

Axle Lbs. Rating	Code	Year	Diameter (inches)	Length (Inches)	Pin Type	Bushing	Notes	King Pin Set No.
6,000		1967-1967	1.234"	7.500"	1	Nylon		8357N
7,000		1967-1969	1.234"	7.440"	2	Metal		8479B
		1967-1969	1.244"	7.440"	2	Metal		8507B010
		1967-1969	1.234"	7.440"	2	Nylon		8479N
9,000		1964-1969	1.434"	8.500"	2	Metal		8519B
		1964-1969	1.444"	8.500"	2	Metal		8519B010
		1964-1969	1.434"	8.500"	2	Nylon		8519N
11,000		1964-1965	1.607"	8.812"	2	Metal	(Center Point Steering)	8514B
		1964-1965	1.607"	8.812"	2	Nylon	(Center Point Steering)	8514N
12,000		1964-1969	1.794"	9.120"	2	Metal		8489B
		1964-1969	1.794"	9.120"	2	Nylon		8489N
15,000		1964-1969	1.400/1.794"	10.688"	7	Metal		8474B

Tie Rod Ends

Axle Lbs. Rating	Code	Year	Length (Inches)	Notes	Tie Rod End Part No.	
					Drivers Side	Passenger Side
6,000		1967-1967	4.44"		ES2083L	ES2082R
7,000		1967-1969	3.90"		ES304L	ES304R
9,000		1967-1969	4.88"		ES187L	ES187R
12,000		1964-1969	5.75"	Anti-Tilt Seal Type	ES346L	ES346R
		1964-1969	5.75"	Anti-Tilt Seal Type	ES346L	ES346R

T850, T950

King Bolt Sets

Axle Lbs. Rating	Code	Year	Diameter (inches)	Length (Inches)	Pin Type	Bushing	Notes	King Pin Set No.
9,000		1961-1969	1.434"	8.500"	2	Metal		8519B
		1961-1969	1.444"	8.500"	2	Metal		8519B010
		1961-1969	1.434"	8.500"	2	Nylon		8519N
11,000		1962-1969	1.607"	8.812"	2	Metal	(Center Point Steering)	8514B
		1962-1969	1.607"	8.812"	2	Nylon	(Center Point Steering)	8514N
12,000		1962-1969	1.794"	9.120"	2	Metal		8489B
		1966-1969	1.607"	8.812"	2	Metal	(Center Point Steering)	8514B
		1962-1969	1.794"	9.120"	2	Nylon		8489N
		1966-1969	1.607"	8.812"	2	Nylon	(Center Point Steering)	8514N
15,000		1962-1969	1.400/1.794"	10.688"	7	Metal		8474B
18,000		1964-1969	1.999"	11.040"	2	Metal		8518B
		1964-1969	1.999"	11.040"	2	Nylon		8518N

Tie Rod Ends

Axle Lbs. Rating	Code	Year	Length (Inches)	Notes	Tie Rod End Part No.	
					Drivers Side	Passenger Side
9,000		1961-1969	4.88"		ES187L	ES187R
12,000		1962-1969	5.75"	Anti-Tilt Seal Type	ES346L	ES346R
15,000		1962-1969	5.75"	Anti-Tilt Seal Type	ES346L	ES346R
18,000		1964-1969	5.75"	Anti-Tilt Seal Type	ES346L	ES346R

W1000, WT1000

King Bolt Sets

Axle Lbs. Rating	Code	Year	Diameter (inches)	Length (Inches)	Pin Type	Bushing	Notes	King Pin Set No.
12,000		1966-1970	1.794"	9.120"	2	Metal		8489B
		1966-1970	1.607"	8.812"	2	Metal	(Center Point Steering)	8514B
		1966-1970	1.794"	9.120"	2	Nylon		8489N
		1966-1970	1.607"	8.812"	2	Nylon	(Center Point Steering)	8514N
15,000		1966-1970	1.400/1.794"	10.688"	7	Metal		8474B

Tie Rod Ends

Axle Lbs. Rating	Code	Year	Length (Inches)	Notes	Tie Rod End Part No.	
					Drivers Side	Passenger Side
12,000		1966-1970	5.75"	Anti-Tilt Seal Type	ES346L	ES346R
15,000		1966-1970	5.75"	Anti-Tilt Seal Type	ES346L	ES346R

W900, WT900, W9000, WT9000

King Bolt Sets

Axle Lbs. Rating	Code	Year	Diameter (inches)	Length (Inches)	Pin Type	Bushing	Notes	King Pin Set No.
12,000		1970-1975	1.794"	9.120"	2	Metal	To W40,001 (Center Point Steering) From W40,001"	8489B
		1970-1975	1.607"	8.812"	2	Metal		8514B
		1975-1977	1.794"	10.070"	2	Metal		8572B
		1970-1975	1.794"	9.120"	2	Nylon		8489N
		1970-1975	1.607"	8.812"	2	Nylon		8514N
15,000		1973-1974	1.400/1.794"	10.688"	7	Metal		8474B

Tie Rod Ends

Axle Lbs. Rating	Code	Year	Length (Inches)	Notes	Tie Rod End Part No.	
					Drivers Side	Passenger Side
12,000		1975-1977	4.00"	From W40,001	ES323L	ES323R
		1970-1975	5.75"	To W40,001	ES431L	ES431R
15,000		1973-1974	5.75"		ES431L	ES431R

FREIGHTLINER TRUCK MODEL FINDING INDEX

Model	Model	Model	Model
ALL MODELS	C112	C120 Century Class	Columbia
Conventional Cab	FCCC	FL106 Business Class	FL70
FL80	FLA Series Cab-Over-Engine	FLB Series Cab-Over-Engine	FLC 112 Series
FLC112SD Severe-Duty	FLD 112 Conventional Cab, Medium, Aluminun	FLD 112SD	FLD 120 Conventional Cab, Long, Aluminun
FLD 120SD Conventional cab, Severe Duty	FLD 132 Classic XL, Conventional Cab	FLP Series Cab-Over-Engine	FLT Series Cab-Over-Engine
M2 106 CONVENTIONAL	M2 112 CONVENTIONAL	MB70	MB80
MOTORHOME	OTHER MODELS Conventional and Cab-Over-Engine		

**Note: Freightliner Trucks use Rockwell or Eaton Axles.
For further information, see axle Manufacturer**

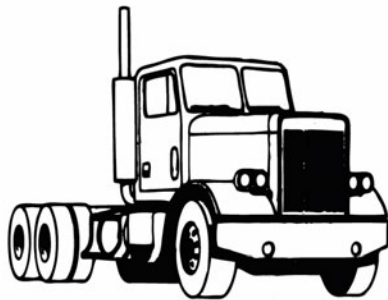

Conventional (FLC)



COE (FLP, FLT)

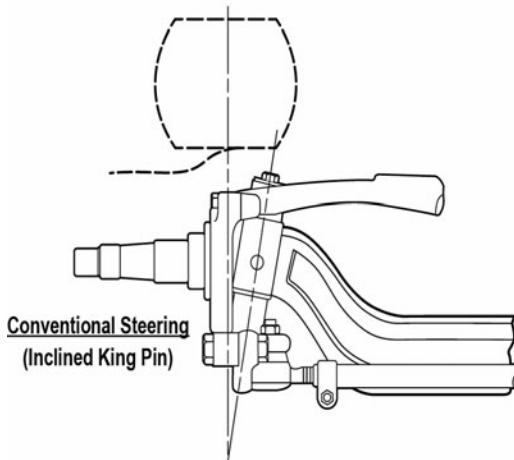

**Conventional Steering
(Inclined King Pin)**

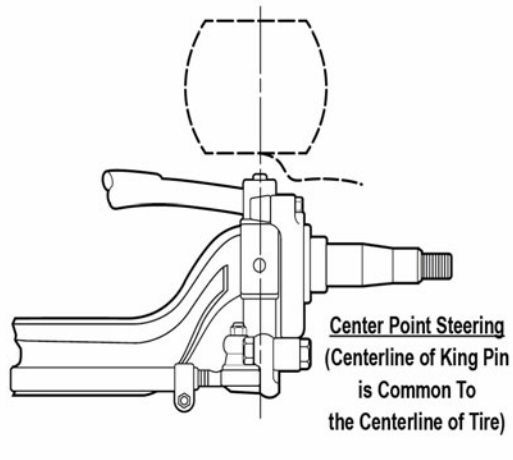

**Center Point Steering
(Centerline of King Pin
is Common To
the Centerline of Tire)**

ALL MODELS

Drag Links

Axle Lbs. Rating	Code	Year	Length (inches)	Notes	Drag Link No.	
12,000-14,600	(All)		34.62"	943 w/TAS65 Ross Strg. Gear. w/Sheppard M100 Strg.	DS1344	
9,000-14,600			18.72"			DS1340
All			15.75"			DS1273
			18.72"			DS1340
			18.83"			DS1220
			28.87"			DS1218
			29.38"			DS1219
			29.44"			DS1276
			32.03"			DS1275
			32.58"			DS1274
16,000-20,000	FL931		32.61"	w/fixed Ends	DS1221	
			13.00"	w/Shepard M100 Strg.	DS1136	
			28.87"		DS1218	
			31.50"		DS1350	
12,000	(All)			Drag Link End-RH Thread	ES2113R	

ALL MODELS (Cont'd)

Drag Links (Cont'd)

Axle Lbs. Rating	Code	Year	Length (inches)	Notes	Drag Link No.
12,000	(All)		23.44" 13.00"	Drag Link End-RH Thread Drag Link End-LH Thread	ES431R ES434L DS999 DS1136 ES431R
	(FF931) (FF941 & FF943)			31.85"	w/fixed Ends Drag Link End Assembly
16,000	(All)		23.44"	Drag Link End-LH Thread Drag Link End-RH Thread	ES434L ES431R ES2113R DS999
				Drag Link End-RH Thread Drag Link End-LH Thread	ES2113R ES431R ES434L DS999

C112, C120 CENTURY CLASS, CONVENTIONAL CAB

King Bolt Sets

Axle Lbs. Rating	Code	Year	Diameter (inches)	Length (Inches)	Pin Type	Bushing	Notes	King Pin Set No.
12,000	(E-12001)		1.794"	9.060"	1	Metal		80076B
	(FF961)		1.790"	10.390"	2	Composite		80063C
14,600	(FG941)		1.790"	10.390"	2	Metal		8611B

Tie Rod Ends

Axle Lbs. Rating	Code	Year	Length (Inches)	Notes	Tie Rod End Part No.	
					Drivers Side	Passenger Side
12,000	(E-12001) (FF961) (FF961)	2000-2002 2005-2007	5.44"	1-1/8"-18 Optional Thread	ES423L	ES423R
			6.00"		ES3477	ES3476
		5.44"	ES3477		ES3476	
		5.44"	ES423L		ES423R	
14,600	(FG941) (FG941)		5.44"	1-1/8"-18 Optional Thread	ES423L	ES3312R
			5.44"			ES423R

Drag Links

Axle Lbs. Rating	Code	Year	Length (inches)	Notes	Drag Link No.
		1997-2007 1997-2004	31.47"		DS300002

Columbia

Tie Rod Ends

Axle Lbs. Rating	Code	Year	Length (Inches)	Notes	Tie Rod End Part No.	
					Drivers Side	Passenger Side
		2001-2007 2005-2007	5.44"		ES423L	ES423R
			7.37"		ES2090L	ES2091R

Drag Links

Axle Lbs. Rating	Code	Year	Length (inches)	Notes	Drag Link No.
		2001-2007	31.47"		DS300002

FCCC, MOTORHOME

Tie Rod Ends

Axle Lbs. Rating	Code	Year	Length (Inches)	Notes	Tie Rod End Part No.	
					Drivers Side	Passenger Side
9,000			6.00"		ES3477	ES3476
10,000			6.00"		ES3477	ES3476

FL70, MB70, FL80, MB80, FL106 Business Class, Conventional Cab

King Bolt Sets

Axle Lbs. Rating	Code	Year	Diameter (inches)	Length (Inches)	Pin Type	Bushing	Notes	King Pin Set No.
10,000	(FD961)		1.790"	10.390"	2	Composite		80063C
12,000	(FF961)		1.790"	10.390"	2	Composite		80063C

FL70, MB70, FL80, MB80, FL106 Business Class, Conventional Cab

Tie Rod Ends

Axle Lbs. Rating	Code	Year	Length (Inches)	Notes	Tie Rod End Part No.	
					Drivers Side	Passenger Side
10,000	(FD961)		5.44"	1-1/8"-18 Optional Thread	ES423L	ES3312R
	(FD961)		5.44"			ES423R
12,000	(FF961)		5.44"	1-1/8"-18 Optional Thread	ES423L	ES3312R
	(FF961)		5.44"			ES423R

FLA, FLP, FLT Series Cab-Over-Engine

King Bolt Sets

Axle Lbs. Rating	Code	Year	Diameter (inches)	Length (Inches)	Pin Type	Bushing	Notes	King Pin Set No.
12,000	(FF961)		1.790"	10.390"	2	Composite		80063C
14,600	(FG941)		1.790"	10.390"	2	Metal		8611B

Tie Rod Ends

Axle Lbs. Rating	Code	Year	Length (Inches)	Notes	Tie Rod End Part No.	
					Drivers Side	Passenger Side
12,000	(FF961)		5.44"	1-1/8"-18 Optional Thread	ES423L	ES3312R
	(FF961)		5.44"			ES423R
14,600	(FG941)		5.44"	1-1/8"-18 Optional Thread	ES423L	ES3312R
	(FG941)		5.44"			ES423R

FLB, FLL Series Cab-Over-Engine

King Bolt Sets

Axle Lbs. Rating	Code	Year	Diameter (inches)	Length (Inches)	Pin Type	Bushing	Notes	King Pin Set No.
12,000	(FF943)		1.794"	10.392"	2	Metal		8590B
	(FF961)		1.790"	10.390"	2	Composite		80063C
14,600	(FG941)		1.790"	10.390"	2	Metal		8611B
	(FG943)		1.790"	10.390"	2	Metal		8611B
16,000	(FL941)		1.999"	11.212"	2	Metal		8571B
18,000	(FL941)		1.999"	11.212"	2	Metal		8571B
20,000	(FL941)		1.999"	11.212"	2	Metal		8571B
24,000	(FF961) Dual Axles		1.790"	10.390"	2	Composite		80063C
32,000	(FL941) Dual Axles		1.999"	11.212"	2	Metal		8571B
36,000	(FL941) Dual Axles		1.999"	11.212"	2	Metal		8571B
40,000	(FL941) Dual Axles		1.999"	11.212"	2	Metal		8571B

Tie Rod Ends

Axle Lbs. Rating	Code	Year	Length (Inches)	Notes	Tie Rod End Part No.	
					Drivers Side	Passenger Side
12,000	(FF943)		5.44"	1-1/8"-18 Optional Thread	ES423L	ES3312R
	(FF943)		5.44"			ES423R
	(FF961)		5.44"			ES423R
	(FF961)		5.44"			ES3312R
14,600	(FG941)		5.44"	1-1/8"-18 Optional Thread	ES423L	ES423R
	(FG941)		5.44"			ES3312R
	(FG943)		5.44"			ES423R
	(FG943)		5.44"			ES3312R
16,000	(FL941)		12.69"		ES3031L	ES3030R
	(FL941)		5.75"			ES431R
	(FL941)		7.37"			ES2091R
18,000	(FL941)		12.69"		ES3031L	ES3030R
	(FL941)		5.75"			ES431R

FLB, FLL Series Cab-Over-Engine (Cont'd)

Heavy Duty Trucks

Tie Rod Ends (Cont'd)

Axle Lbs. Rating	Code	Year	Length (Inches)	Notes	Tie Rod End Part No.	
					Drivers Side	Passenger Side
18,000	(FL941)		7.37"		ES2090L	ES2091R
20,000	(FL941)		12.69"		ES3031L	ES3030R
	(FL941)		5.75"		ES431L	ES431R
	(FL941)		7.37"		ES2090L	ES2091R
24,000	(FF961) Dual Axles		5.44"	1-1/8"-18 Optional Thread	ES423L	ES423R
	(FF961) Dual Axles		5.44"			ES3312R
32,000	(FL941) Dual Axles		12.69"		ES3031L	ES3030R
	(FL941) Dual Axles		5.75"		ES431L	ES431R
	(FL941) Dual Axles		7.37"		ES2090L	ES2091R
36,000	(FL941) Dual Axles		12.69"		ES3031L	ES3030R
	(FL941) Dual Axles		5.75"		ES431L	ES431R
	(FL941) Dual Axles		7.37"		ES2090L	ES2091R
40,000	(FL941) Dual Axles		12.69"		ES3031L	ES3030R
	(FL941) Dual Axles		5.75"		ES431L	ES431R
	(FL941) Dual Axles		7.37"		ES2090L	ES2091R

FLC 112 Series

King Bolt Sets

Axle Lbs. Rating	Code	Year	Diameter (inches)	Length (Inches)	Pin Type	Bushing	Notes	King Pin Set No.
10,000	(FD961)		1.790"	10.390"	2	Composite		80063C
12,000	(E-12001)		1.794"	9.060"	1	Metal		80076B
	(FF943)		1.794"	10.392"	2	Metal		8590B
	(FF961)		1.790"	10.390"	2	Composite		80063C
14,600	(FG941)		1.790"	10.390"	2	Metal		8611B
	(FG943)		1.790"	10.390"	2	Metal		8611B

Tie Rod Ends

Axle Lbs. Rating	Code	Year	Length (Inches)	Notes	Tie Rod End Part No.	
					Drivers Side	Passenger Side
10,000	(FD961)		5.44"	1-1/8"-18 Optional Thread		ES3312R
	(FD961)		5.44"		ES423L	ES423R
12,000	(E-12001)		6.00"	1-1/8"-18 Optional Thread	ES3477	ES3476
	(FF943)		5.44"			ES3312R
	(FF943)		5.44"		ES423L	ES423R
	(FF961)		5.44"			ES3312R
14,600	(FF961)		5.44"	1-1/8"-18 Optional Thread	ES423L	ES423R
	(FG941)		5.44"			ES3312R
	(FG941)		5.44"		ES423L	ES423R
	(FG943)		5.44"			ES3312R
	(FG943)		5.44"		ES423L	ES423R

FLC112SD Severe-Duty

King Bolt Sets

Axle Lbs. Rating	Code	Year	Diameter (inches)	Length (Inches)	Pin Type	Bushing	Notes	King Pin Set No.
14,600	(FG941)		1.790"	10.390"	2	Metal		8611B
16,000	(FL941)		1.999"	11.212"	2	Metal		8571B
18,000	(FL941)		1.999"	11.212"	2	Metal		8571B
20,000	(FL941)		1.999"	11.212"	2	Metal		8571B

Tie Rod Ends

Axle Lbs. Rating	Code	Year	Length (Inches)	Notes	Tie Rod End Part No.	
					Drivers Side	Passenger Side

FLC112SD Severe-Duty (Cont'd)

Tie Rod Ends (Cont'd)

Axle Lbs. Rating	Code	Year	Length (Inches)	Notes	Tie Rod End Part No.	
					Drivers Side	Passenger Side
14,600	(FG941)		5.44"	1-1/8"-18 Optional Thread	ES423L	ES3312R
	(FG941)		5.44"			ES423R
16,000	(FL941)		12.69"		ES3031L ES431L ES2090L	ES3030R
	(FL941)		5.75"			ES431R
	(FL941)		7.37"			ES2091R
18,000	(FL941)		12.69"		ES3031L ES431L ES2090L	ES3030R
	(FL941)		5.75"			ES431R
	(FL941)		7.37"			ES2091R
20,000	(FL941)		12.69"		ES3031L ES431L ES2090L	ES3030R
	(FL941)		5.75"			ES431R
	(FL941)		7.37"			ES2091R

FLD 112 Conventional Cab, Medium, Aluminum

King Bolt Sets

Axle Lbs. Rating	Code	Year	Diameter (inches)	Length (Inches)	Pin Type	Bushing	Notes	King Pin Set No.
12,000	(E-12001)		1.794"	9.060"	1	Metal		80076B
	(FF943)		1.794"	10.392"	2	Metal		8590B
13,200	(E-13201)		1.794"	9.060"	1	Metal		80076B
14,600	(FG941)		1.790"	10.390"	2	Metal		8611B
	(FG943)		1.790"	10.390"	2	Metal		8611B

Tie Rod Ends

Axle Lbs. Rating	Code	Year	Length (Inches)	Notes	Tie Rod End Part No.	
					Drivers Side	Passenger Side
12,000	(E-12001)		6.00"	1-1/8"-18 Optional Thread	ES3477	ES3476
	(FF943)		5.44"			ES3312R
	(FF943)		5.44"			ES423L
13,200	(E-13201)		6.00"		ES3477	ES3476
14,600	(FG941)		5.44"	1-1/8"-18 Optional Thread	ES423L	ES3312R
	(FG941)		5.44"	1-1/8"-18 Optional Thread		ES423R
	(FG943)		5.44"			ES3312R
	(FG943)		5.44"	ES423L		ES423R

FLD 112SD, FLD 120SD Conventional cab, Severe Duty

King Bolt Sets

Axle Lbs. Rating	Code	Year	Diameter (inches)	Length (Inches)	Pin Type	Bushing	Notes	King Pin Set No.
12,000	(E-12001)		1.794"	9.060"	1	Metal		80076B
	(FF961)		1.790"	10.390"	2	Composite		80063C
13,200	(E-13201)		1.794"	9.060"	1	Metal		80076B
14,600	(FG941)		1.790"	10.390"	2	Metal		8611B
	(FG943)		1.790"	10.390"	2	Metal		8611B
16,000	(FL941)		1.999"	11.212"	2	Metal		8571B
18,000	(FL941)		1.999"	11.212"	2	Metal		8571B
20,000	(FL941)		1.999"	11.212"	2	Metal		8571B

Tie Rod Ends

Axle Lbs. Rating	Code	Year	Length (Inches)	Notes	Tie Rod End Part No.	
					Drivers Side	Passenger Side
12,000	(E-12001)		6.00"	1-1/8"-18 Optional Thread	ES3477	ES3476
	(FF961)		5.44"			ES3312R
	(FF961)		5.44"			ES423L
13,200	(E-13201)		6.00"		ES3477	ES3476
14,600	(FG941)		5.44"	1-1/8"-18 Optional Thread	ES423L	ES3312R
	(FG941)		5.44"	1-1/8"-18 Optional Thread		ES423R
	(FG943)		5.44"			ES3312R
	(FG943)		5.44"	ES423L		ES423R
16,000	(FL941)		12.69"		ES3031L ES431L ES2090L	ES3030R
	(FL941)		5.75"			ES431R
	(FL941)		7.37"			ES2091R
18,000	(FL941)		12.69"		ES3031L ES431L	ES3030R
	(FL941)		5.75"			ES431R

FLD 112SD, FLD 120SD Conventional cab, Severe Duty (Cont'd)

Tie Rod Ends (Cont'd)

Axle Lbs. Rating	Code	Year	Length (Inches)	Notes	Tie Rod End Part No.	
					Drivers Side	Passenger Side
18,000	(FL941)		7.37"		ES2090L	ES2091R
20,000	(FL941)		12.69"		ES3031L	

FLD 120 Conventional Cab, Long, Aluminum

King Bolt Sets

Axle Lbs. Rating	Code	Year	Diameter (inches)	Length (Inches)	Pin Type	Bushing	Notes	King Pin Set No.
12,000	(FF943)		1.794"	10.392"	2	Metal		8590B
	(FF961)		1.790"	10.390"	2	Composite		80063C
	EFA-12F4		1.630"	9.200"	1	Composite		8618C
14,600	(FG941)		1.790"	10.390"	2	Metal		8611B
	(FG943)		1.790"	10.390"	2	Metal		8611B
16,000	(FL941)		1.999"	11.212"	2	Metal		8571B
18,000	(FL941)		1.999"	11.212"	2	Metal		8571B
20,000	(FL941)		1.999"	11.212"	2	Metal		8571B

Tie Rod Ends

Axle Lbs. Rating	Code	Year	Length (Inches)	Notes	Tie Rod End Part No.	
					Drivers Side	Passenger Side
12,000	(FF943)		5.44"	1-1/8"-18 Optional Thread	ES423L	ES3312R
	(FF943)		5.44"			ES423R
	(FF961)		5.44"			ES423R
	(FF961)		5.44"	1-1/8"-18 Optional Thread	ES423L	ES3312R
	EFA-12F4		5.44"	ES423R		
	EFA-12F4		8.12"	ES3297R		
14,600	(FG941)		5.44"	1-1/8"-18 Optional Thread	ES423L	ES423R
	(FG941)		5.44"			ES3312R
	(FG943)		5.44"	1-1/8"-18 Optional Thread	ES423L	ES3312R
	(FG943)		5.44"	ES423R		
16,000	(FL941)		12.69"		ES3031L	ES3030R
	(FL941)		5.75"		ES431L	ES431R
	(FL941)		7.37"		ES2090L	ES2091R
18,000	(FL941)		12.69"		ES3031L	ES3030R
	(FL941)		5.75"		ES431L	ES431R
	(FL941)		7.37"		ES2090L	ES2091R
20,000	(FL941)		12.69"		ES3031L	ES3030R
	(FL941)		5.75"		ES431L	ES431R
	(FL941)		7.37"		ES2090L	ES2091R

FLD 132 Classic XL, Conventional Cab

King Bolt Sets

Axle Lbs. Rating	Code	Year	Diameter (inches)	Length (Inches)	Pin Type	Bushing	Notes	King Pin Set No.
12,000	(E-12001)		1.794"	9.060"	1	Metal		80076B
	(FF943)		1.794"	10.392"	2	Metal		8590B
	(FF961)		1.790"	10.390"	2	Composite		80063C
13,200	(E-13201)		1.794"	9.060"	1	Metal		80076B
14,600	(FG941)		1.790"	10.390"	2	Metal		8611B
	(FG943)		1.790"	10.390"	2	Metal		8611B
16,000	(FL941)		1.999"	11.212"	2	Metal		8571B
18,000	(FL941)		1.999"	11.212"	2	Metal		8571B
20,000	(FL941)		1.999"	11.212"	2	Metal		8571B

Tie Rod Ends

Axle Lbs. Rating	Code	Year	Length (Inches)	Notes	Tie Rod End Part No.	
					Drivers Side	Passenger Side
12,000	(E-12001)		6.00"	1-1/8"-18 Optional Thread	ES3477	ES3476
	(FF943)		5.44"			ES423R
	(FF943)		5.44"			ES3312R
	(FF961)		5.44"	1-1/8"-18 Optional Thread	ES423L	ES423R
	(FF961)		5.44"			ES3312R
	(FF961)		5.44"			ES3312R
13,200	(E-13201)		6.00"		ES3477	ES3476
14,600	(FG941)		5.44"		ES423L	ES423R

FLD 132 Classic XL, Conventional Cab (Cont'd)

Tie Rod Ends (Cont'd)

Axle Lbs. Rating	Code	Year	Length (Inches)	Notes	Tie Rod End Part No.	
					Drivers Side	Passenger Side
14,600	(FG941)		5.44"	1-1/8"-18 Optional Thread	ES423L	ES3312R
	(FG943)		5.44"			ES3312R
	(FG943)		5.44"			ES423R
16,000	(FL941)		12.69"		ES3031L	ES3030R
	(FL941)		5.75"		ES431L	ES431R
	(FL941)		7.37"		ES2090L	ES2091R
18,000	(FL941)		12.69"		ES3031L	ES3030R
	(FL941)		5.75"		ES431L	ES431R
	(FL941)		7.37"		ES2090L	ES2091R
20,000	(FL941)		12.69"		ES3031L	ES3030R
	(FL941)		5.75"		ES431L	ES431R
	(FL941)		7.37"		ES2090L	ES2091R

M2 106, 112, CONVENTIONAL

Tie Rod Ends

Axle Lbs. Rating	Code	Year	Length (Inches)	Notes	Tie Rod End Part No.	
					Drivers Side	Passenger Side
		2004-2007	5.44"		ES423L	ES423R

M2 112, CONVENTIONAL

Tie Rod Ends

Axle Lbs. Rating	Code	Year	Length (Inches)	Notes	Tie Rod End Part No.	
					Drivers Side	Passenger Side
		2004-2006	7.37"		ES2090L	ES2091R

OTHER MODELS Conventional and Cab-Over-Engine

King Bolt Sets

Axle Lbs. Rating	Code	Year	Diameter (inches)	Length (Inches)	Pin Type	Bushing	Notes	King Pin Set No.
11,000	(FE900)		1.309/1.607"	9.750"	7	Metal		8386B
	(FE900)		1.309/1.607"	9.750"	7	Nylon		8386N
12,000	(FE970)		1.607"	8.812"	2	Metal		8514B
	(FE970)		1.607"	8.812"	2	Nylon		8514N
	(FF901)		1.794"	9.120"	2	Metal		8489B
	(FF901)		1.794"	9.120"	2	Nylon		8489N
	(FF921)		1.794"	10.392"	2	Metal		8553B
	(FF931)		1.794"	10.392"	2	Metal		8590B
	(FF971)		1.607"	9.380"	2	Metal		(Center Point Steering)
16,000	(FH901)		1.999"	11.040"	2	Metal		8518B
	(FH901)		1.999"	11.040"	2	Nylon		8518N
	(FL931)		1.999"	11.212"	2	Metal		8571B
18,000	(FL901)		1.999"	11.040"	2	Metal		8518B
	(FL901)		1.999"	11.040"	2	Nylon		8518N

Tie Rod Ends

Axle Lbs. Rating	Code	Year	Length (Inches)	Notes	Tie Rod End Part No.	
					Drivers Side	Passenger Side
11,000	(FE900)		4.88"		ES187L	ES187R
	(FE900)		5.75"		ES431L	ES431R
12,000	(FE970)		10.50"	Will Retrofit Older Axles	ES2200L	ES2201R
	(FE970)		4.88"		ES187L	ES187R
	(FE970)		5.75"	ES431L	ES431R	
	(FE971)		10.50"	(Center Point Steering)	ES2200L	ES2201R
	(FF901)		4.88"	Anti-Tilt Seal Type	ES187L	ES187R
	(FF901)		5.75"		ES346L	ES346R
	(FF901)		5.75"		ES431L	ES431R
	(FF921)		5.44"	1-1/8"-18 Optional Thread	ES423L	ES423R
	(FF921)		5.44"		ES423L	ES3312R
	(FF931)		5.44"		ES423L	ES423R
16,000	(FH901)		5.75"		ES431L	ES431R
	(FL931)		12.69"		ES3031L	ES3030R

OTHER MODELS Conventional and Cab-Over-Engine (Cont'd)

Tie Rod Ends (Cont'd)

Axle Lbs. Rating	Code	Year	Length (Inches)	Notes	Tie Rod End Part No.	
					Drivers Side	Passenger Side
16,000	(FL931)		5.75"		ES431L	ES431R
	(FL931)		7.37"		ES2090L	ES2091R
18,000	(FL901)		5.75"		ES431L	ES431R

GMC TRUCK MODEL FINDING INDEX			
Model	Model	Model	Model
Astro	B6000	B6P	B7T
Brigadier	C4500	C5000	C5500
C5D	C6000	C6500	C6D
C7500	C7D	C9500	D9500
D9K	D9L	E4500	E5500
E6500	F9500	General	H5500
H7500	H8500	H9500	J7500
J8500	J8C	J9500	J9C
M6000	M6500	M9500	N9E
N9F	P4500	P6000	P6S
R8500	S5500	S6000	S7500
S7T	T5500	T6000	T6500
T7500	T8500	T9500	Topkick
W4	W7500	W8500	W9500

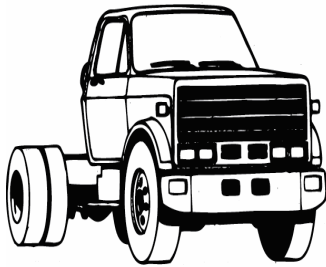

**5000, 6000, 7500 Series
(Fiberglass Hood)**



School Bus

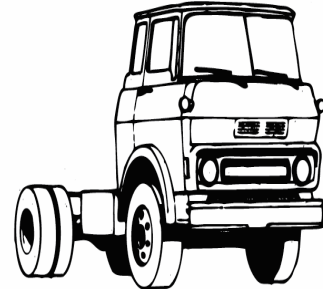

Steel Tilt Cab

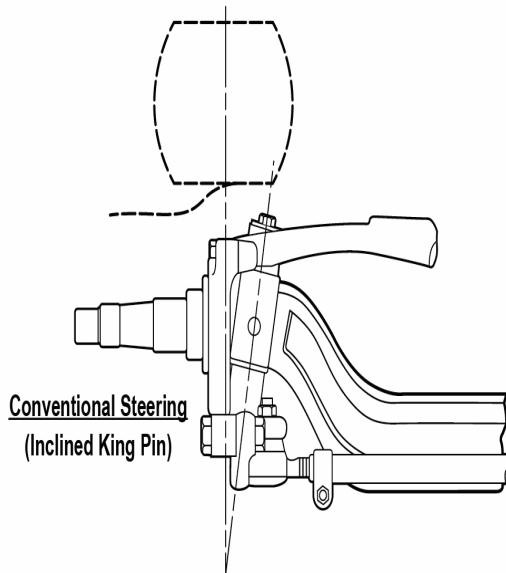

**Conventional Steering
(Inclined King Pin)**

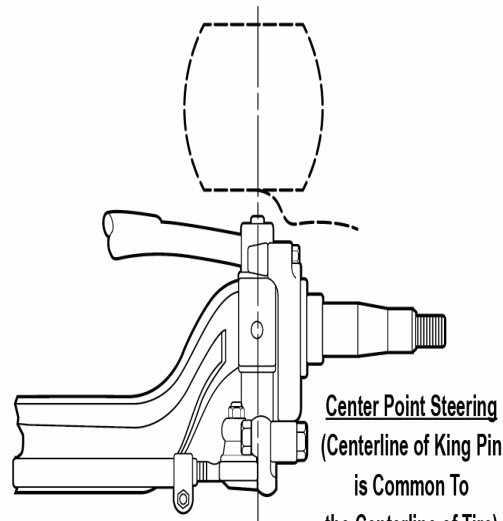

**Center Point Steering
(Centerline of King Pin
is Common To
the Centerline of Tire)**

Astro, D9K, D9L

King Bolt Sets

Axle Lbs. Rating	Code	Year	Diameter (inches)	Length (Inches)	Pin Type	Bushing	Notes	King Pin Set No.
9,000	(F120D)	1981-1982	1.745"	9.380"	1	Metal		8613B
12,000	(F120)	1979-1985	1.745"	9.380"	1	Metal		8613B
	(FF941)	1979-1988	1.794"	10.392"	2	Metal		8590B
16,000	(FL931)	1979-1982	1.999"	11.212"	2	Metal		8571B
18,000	(FL941)	1983-1987	1.999"	11.212"	2	Metal		8571B

Astro, D9K, D9L (Cont'd)

Tie Rod Ends

Axle Lbs. Rating	Code	Year	Length (Inches)	Notes	Tie Rod End Part No.	
					Drivers Side	Passenger Side
12,000	(F120)	1979-1987	4.88"	1-1/8"-18 Optional Thread A3144N534	ES405L	ES405R
	(FF931)	1983-1987	5.44"			
	(FF931)	1983-1987	5.44"			
	(FF971)	1983-1983	10.50"			
16,000	(FL931)	1979-1983	12.69"		ES3031L	ES3030R
	(FL931)	1979-1983	5.75"			
	(FL931)	1979-1983	7.37"			
18,000	(FL941)	1983-1983	12.69"		ES3031L	ES3030R
	(FL941)	1983-1983	5.75"			
	(FL941)	1983-1983	7.37"			

Drag Links

Axle Lbs. Rating	Code	Year	Length (inches)	Notes	Drag Link No.		
12,000	(F120)	1979-1983	17.90"	Color Coded White	DS988 DS991 DS1044 DS988 DS991 DS988 DS991 DS1044 DS988 DS991		
			18.20"	Color Coded Blue			
	(FF931)	1984-1987	16.89"	w/Ross or Sheppard Power Steering			
			1983-1984	17.90"		Color Coded White	
	(FF941)	1983-1983	18.20"	Color Coded Blue			
			1983-1984	17.90"		Color Coded White	
			18.20"	Color Coded Blue			
			16.89"	w/Sheppard Power Steering			
			(FF971)	1983-1983		17.90"	Color Coded White
						18.20"	Color Coded Blue
16,000	(FL931)	1979-1983	17.90"	Color Coded White	DS988 DS991 DS1044 DS1067		
			18.20"	Color Coded Blue			
			1984-1987	16.89"		w/Sheppard Power Steering-LH w/Sheppard Power Steering-RH	
18,000	(FL941)	1983-1984	17.90"	Color Coded White	DS988 DS991 DS1067 DS1044		
			1983-1983	18.20"		Color Coded Blue	
			1984-1987	16.89"		w/Sheppard Power Steering-RH	
				16.89"		w/Sheppard Power Steering-LH	

B6000, B6P

King Bolt Sets

Axle Lbs. Rating	Code	Year	Diameter (inches)	Length (Inches)	Pin Type	Bushing	Notes	King Pin Set No.
6,000	(F070D)	1979-1982	1.249"	7.890"	1	Metal		8491B
	(F070D)		1.259"	7.890"	1	Metal		8491B010
	(F070D)		1.249"	7.890"	1	Nylon		8491N
7,000	(F070)	1979-1982	1.249"	7.890"	1	Metal		8491B
	(F070)	1983-1991	1.249"	7.890"	1	Metal		8491B
	(F070)	1979-1982	1.259"	7.890"	1	Metal		8491B010
	(F070)	1983-1991	1.259"	7.890"	1	Metal		8491B010
	(F070)	1983-1991	1.249"	7.890"	1	Nylon		8491N
	(F070)	1979-1982	1.249"	7.890"	1	Nylon		8491N
7,500	(F070)	1983-1991	1.249"	7.890"	1	Metal		8491B
	(F070)	1983-1991	1.259"	7.890"	1	Metal		8491B010
	(F070)	1983-1991	1.249"	7.890"	1	Nylon		8491N
8,100	(F090D)	1983-1987	1.186/1.434"	8.750"	7	Metal		8462B
	(F090D)		1.186/1.434"	8.750"	7	Nylon		8462N
9,000	(F090)	1979-1982	1.186/1.434"	8.750"	7	Metal		8462B
	(F090)	1983-1988	1.745"	9.380"	1	Metal		8613B
	(F090)	1979-1982	1.186/1.434"	8.750"	7	Nylon		8462N
	(F120D)	1979-1990	1.745"	9.380"	1	Metal		8613B
12,000	(F120)	1983-1992	1.745"	9.380"	1	Metal		8613B
	(F120)	1983-1992	1.745"	9.380"	1	Metal		8613B

Tie Rod Ends

Axle Lbs. Rating	Code	Year	Length (Inches)	Notes	Tie Rod End Part No.	
					Drivers Side	Passenger Side
6,000	(F070D)	1979-1982	4.93"		ES2061L	ES2062R
7,000	(F070)	1988-1992	10.80"		ES3026L	ES3027R
	(F070)	1983-1992	4.93"		ES2061L	ES2062R
	(F070)	1979-1992	4.93"		ES2061L	ES2062R
7,500	(F070)	1988-1992	10.80"		ES3026L	ES3027R
	(F070)	1983-1992	4.93"		ES2061L	ES2062R

B6000, B6P (Cont'd)

Tie Rod Ends (Cont'd)

Axle Lbs. Rating	Code	Year	Length (Inches)	Notes	Tie Rod End Part No.	
					Drivers Side	Passenger Side
8,100	(F090)	1983-1992	4.88"		ES405L	ES405R
9,000	(F090)	1983-1992	4.88"		ES405L	ES405R
	(F090)	1980-1985	4.88"		ES405L	ES405R
	(F090)	1979-1992	4.88"		ES405L	ES405R
	(F120D)	1979-1992	4.88"		ES405L	ES405R
12,000	(F120)	1983-1990	4.88"		ES405L	ES405R
	(F120)	1980-1982	4.88"		ES405L	ES405R

Drag Links

Axle Lbs. Rating	Code	Year	Length (inches)	Notes	Drag Link No.
6,000	(F070D)	1979-1982	17.00"		DS1064
7,000	(F070)	1979-1991	17.00"		DS1064
		1988-1991	17.53"		DS1198
7,500	(F070)	1979-1991	17.00"		DS1064
		1988-1991	17.53"		DS1198
8,100	(F090D)	1983-1988	17.96"		DS987
9,000	(F090) (F120D)	1979-1988	17.96"		DS987
		1979-1991			
		1988-1991	18.50"		DS1199
12,000	(F120)	1979-1991	17.96"		DS987

B7T

King Bolt Sets

Axle Lbs. Rating	Code	Year	Diameter (inches)	Length (Inches)	Pin Type	Bushing	Notes	King Pin Set No.
8,000		1993-1994	1.614"	8.035"	8	Metal	(3675 kg)	8659B
9,000	(F090)	1993-1994	1.892"	9.203"	8	Metal		8660B
11,000		1993-1993	1.892"	9.203"	8	Metal	(5000 kg)	8660B

Tie Rod Ends

Axle Lbs. Rating	Code	Year	Length (Inches)	Notes	Tie Rod End Part No.	
					Drivers Side	Passenger Side
8,000	(FL1)	1993-1994	5.02"	First Design; (3675 kg)	ES3268L	ES3269R
	(FL1)	1993-1999	5.44"	Second Design	ES3270L	ES3271R
9,000	(F090)	1993-1994	5.44"		ES3274L	ES3275R
11,000		1993-1994	5.44"	(5000 kg)	ES3274L	ES3275R

Drag Links

Axle Lbs. Rating	Code	Year	Length (inches)	Notes	Drag Link No.
8,000	(FL1)	1993-1994	17.48"	w/Ross Gear. From 1997	DS1217
			20.65"		DS1216
9,000	(F090)	1993-1994	20.65"		DS1216
11,000	(FL2)	1993-1994	17.48"	w/Ross Gear. From 1997	DS1217
			20.65"		DS1216

Brigadier, J8C, J9C

King Bolt Sets

Axle Lbs. Rating	Code	Year	Diameter (inches)	Length (Inches)	Pin Type	Bushing	Notes	King Pin Set No.
7,000	(F070)	1979-1988	1.249"	7.890"	1	Metal		8491B
	(F070)	1979-1988	1.259"	7.890"	1	Metal		8491B010
	(F070)	1979-1988	1.249"	7.890"	1	Nylon		8491N
9,000	(F090)	1979-1988	1.186/1.434"	8.750"	7	Metal		8462B
	(F090)	1979-1988	1.186/1.434"	8.750"	7	Nylon		8462N
	(F120D)	1979-1988	1.745"	9.380"	1	Metal		8613B
10,860	(F120D)	1979-1988	1.745"	9.380"	1	Metal		8613B
12,000	(F120)	1979-1988	1.745"	9.380"	1	Metal		8613B
	(FF941)	1979-1988	1.794"	10.392"	2	Metal		8590B
16,000	(FL931)	1979-1988	1.999"	11.212"	2	Metal		8571B
18,000	(FL931)	1979-1988	1.999"	11.212"	2	Metal		8571B

Brigadier, J8C, J9C (Cont'd)

Heavy Duty Trucks

Tie Rod Ends

Axle Lbs. Rating	Code	Year	Length (Inches)	Notes	Tie Rod End Part No.	
					Drivers Side	Passenger Side
7,000	(F070)	1979-1988	4.93"		ES2061L	ES2062R
9,000	(F090 & F120D)	1979-1988	4.88"		ES405L	ES405R
10,860	(F120D)	1979-1988	4.88"		ES405L	ES405R
12,000	(F120)	1979-1988	4.88"		ES405L	ES405R
	(FF941)	1979-1988	5.44"		ES423L	ES423R
	(FF941)	1979-1988	5.44"	1-1/8"-18 Optional Thread		ES3312R
13,200	(FF932)	1979-1988	5.44"		ES423L	ES423R
	(FF932)	1979-1988	5.44"	1-1/8"-18 Optional Thread		ES3312R
16,000	(FL931)	1979-1988	12.69"		ES3031L	ES3030R
	(FL931)	1979-1988	5.75"		ES431L	ES431R
	(FL931)	1979-1988	7.37"		ES2090L	ES2091R
18,000	(FL931)	1979-1988	12.69"		ES3031L	ES3030R
	(FL931)	1979-1988	5.75"		ES431L	ES431R
	(FL931)	1979-1988	7.37"		ES2090L	ES2091R
	(FL941)	1979-1988	12.69"		ES3031L	ES3030R
	(FL941)	1979-1988	5.75"		ES431L	ES431R
	(FL941)	1979-1988	7.37"		ES2090L	ES2091R

Drag Links

Axle Lbs. Rating	Code	Year	Length (inches)	Notes	Drag Link No.
9,000	(F090 & F120D)	1979-1988	17.70"	w/Power Steering	DS910
			17.90"	w/Manual Steering	DS988
10,860	(F120D)	1979-1988	17.70"	w/Power Steering	DS910
			17.90"	w/Manual Steering	DS988
12,000	(F120)	1979-1988	16.89"	w/Ross Power Steering	DS1044
				w/Sheppard Power Steering	
			17.70"	w/Power Steering	DS910
			17.90"	w/Manual Steering	DS988
	(FF931) (FF941)	1983-1984			
		1985-1987	16.89"	w/Sheppard Power Steering	DS1044
13,200	(FF932)	1979-1988	17.70"	w/Power Steering-LH	DS910
				w/Manual Steering-RH	DS941
16,000	(FL931)	1979-1988	17.70"	w/Power Steering-RH	DS941
		1985-1987	16.89"	w/Power Steering-LH	DS910
				w/Sheppard Power Steering	DS1044 DS1067
18,000	(FL931)	1979-1988	17.70"	w/Power Steering-LH	DS910
			16.89"	w/Power Steering-RH	DS941
	1985-1987		16.89"	w/Sheppard Power Steering	DS1044 DS1067
		(FL941)	1979-1988	17.70"	w/Power Steering-LH
1985-1987	16.89"		w/Power Steering-RH	DS941	
				w/Sheppard Power Steering	DS1044 DS1067

C4500

King Bolt Sets

Axle Lbs. Rating	Code	Year	Diameter (inches)	Length (Inches)	Pin Type	Bushing	Notes	King Pin Set No.
5,000	(F050)	1969-1972	1.109"	6.344"	1	Metal		8490T

Tie Rod Ends

Axle Lbs. Rating	Code	Year	Length (Inches)	Notes	Tie Rod End Part No.	
					Drivers Side	Passenger Side
5,000	(F050)	1969-1972	5.86"		ES330L	ES330R

Drag Links

Axle Lbs. Rating	Code	Year	Length (inches)	Notes	Drag Link No.
5,000	(F050)	1969-1972	16.75"	w/Power Steering	DS929 DS835

C5000, C5D, Topkick

King Bolt Sets

Axle Lbs. Rating	Code	Year	Diameter (inches)	Length (Inches)	Pin Type	Bushing	Notes	King Pin Set No.
4,000		1963-1966	0.921"	5.640"	1	Metal		8445B
		1963-1966	0.921"	5.640"	1	Nylon		8445N
5,000	(F050)	1973-1975	1.109"	6.344"	1	Metal	To 1975 Second Design	8490T
	(F050)	1975-1992	1.179"	6.360"	1	Metal	From 1975 Second Design	8570B
	(F050)	1975-1992	1.179"	6.360"	1	Nylon	From 1975 Second Design	8570N
	(F050)	1975-1990	1.179"	6.360"	1	Nylon	From 1975 Second Design	8570N
7,000	(F070)	1971-1990	1.249"	7.890"	1	Metal		8491B
	(F070)	1971-1990	1.259"	7.890"	1	Metal		8491B010
	(F070)	1971-1990	1.249"	7.890"	1	Nylon		8491N
8,000	(FL1)	1990-1999	1.614"	8.035"	8	Metal	(3675 kg)	8659B

Tie Rod Ends

Axle Lbs. Rating	Code	Year	Length (Inches)	Notes	Tie Rod End Part No.	
					Drivers Side	Passenger Side
5,000	(F050)	1978-1990	4.93"		ES2061L	ES2062R
	(F050)	1973-1977	5.86"		ES330L	ES330R
7,000	(F070)	1988-1990	10.80"		ES3026L	ES3027R
	(F070)	1975-1990	4.93"		ES2061L	ES2062R
8,000	(FL1)	1990-1994	5.02"	1st.Design; (3675 kg)	ES3268L	ES3269R
		1994-1999	5.44"	2nd.Design; (3675 kg)	ES3270L	ES3271R

Drag Links

Axle Lbs. Rating	Code	Year	Length (inches)	Notes	Drag Link No.
5,000	(F050)	1967-1972	16.75"	To 1975 Second Design From 1975 Second Design	DS929
		1973-1975	17.00"		DS835
		1975-1990			DS1064
7,000	(F070)	1975-1980	17.00"		DS1064
8,000	(FL1)	1990-1999	20.28"	w/Air Brakes	DS1277
			20.65"	w/Hydraulic Brakes	DS1216
11,000	(FL2)	1990-1999	20.28"	w/Air Brakes	DS1277
			20.65"	w/Hydraulic Brakes	DS1216

C5500

King Bolt Sets

Axle Lbs. Rating	Code	Year	Diameter (inches)	Length (Inches)	Pin Type	Bushing	Notes	King Pin Set No.
5,000	(F050)	1967-1972	1.109"	6.344"	1	Metal	From 1975 Second Design From 1975 Second Design From 1975 Second Design	8490T
	(F050)	1975-1985	1.179"	6.360"	1	Metal		8570B
	(F050)	1975-1985	1.189"	6.360"	1	Metal		8570B010
	(F050)	1975-1985	1.179"	6.360"	1	Nylon		8570N
7,000	(F070)	1967-1972	1.249"	7.890"	1	Metal		8491B
	(F070)	1967-1972	1.259"	7.890"	1	Metal		8491B010
	(F070)	1967-1972	1.249"	7.890"	1	Nylon		8491N

Tie Rod Ends

Axle Lbs. Rating	Code	Year	Length (Inches)	Notes	Tie Rod End Part No.	
					Drivers Side	Passenger Side
5,000	(F050)	1978-1985	4.93"		ES2061L	ES2062R
	(F050)	1967-1972	5.86"		ES330L	ES330R
7,000	(F070)	1967-1972	6.50"		ES332L	ES332R

Drag Links

Axle Lbs. Rating	Code	Year	Length (inches)	Notes	Drag Link No.
5,000	(F050)	1971-1972	16.75"		DS929
		1983-1988	17.00"		DS1064
7,000	(F070)	1971-1972	16.75"	Second Design (From 1975)	DS929
		1979-1982 1983-1988	17.00"		DS1064

C6000, C6D, Topkick

King Bolt Sets

Axle Lbs. Rating	Code	Year	Diameter (inches)	Length (Inches)	Pin Type	Bushing	Notes	King Pin Set No.
------------------	------	------	-------------------	-----------------	----------	---------	-------	------------------

C6000, C6D, Topkick (Cont'd)

Heavy Duty Trucks

King Bolt Sets (Cont'd)

Axle Lbs. Rating	Code	Year	Diameter (inches)	Length (Inches)	Pin Type	Bushing	Notes	King Pin Set No.
5,000	(F050)	1964-1972	1.109"	6.344"	1	Metal	From 1964 Second Design; Thrust Washer	8484T
		1964-1972	1.109"	6.344"	1	Metal	From 1964 Second Design; Thrust Bearing	8492B
		1964-1972	1.109"	6.344"	1	Nylon	From 1964 Second Design; Thrust Bearing	8492N
		1973-1975	1.109"	6.344"	1	Metal	To 1975 Second Design	8490T
		1975-1990	1.179"	6.360"	1	Metal	From 1975 Second Design	8570B
		1975-1990	1.189"	6.360"	1	Metal	From 1975 Second Design	8570B010
		1975-1990	1.179"	6.360"	1	Nylon	From 1975 Second Design	8570N
7,000	(F070)	1964-1990	1.249"	7.890"	1	Metal		8491B
		1964-1990	1.259"	7.890"	1	Metal		8491B010
		1964-1990	1.249"	7.890"	1	Nylon		8491N
8,000	(FL1)	1990-1999	1.614"	8.035"	8	Metal	(3675 kg)	8659B
		1990-1999	1.614"	8.035"	8	Metal	(3675 kg)	8659B
8,100	(F090D)	1984-1992	1.745"	9.380"	1	Metal		8613B
9,000	(F090)	1963-1987	1.186/1.434"	8.750"	7	Metal		8462B
		1963-1987	1.186/1.434"	8.750"	7	Nylon		8462N
		1979-1992	1.745"	9.380"	1	Metal		8613B
12,000	(F120)	1973-1975	1.309/1.607"	9.750"	7	Metal		8386B
		1982-1992	1.745"	9.380"	1	Metal		8613B

Tie Rod Ends

Axle Lbs. Rating	Code	Year	Length (Inches)	Notes	Tie Rod End Part No.	
					Drivers Side	Passenger Side
5,000	(F050)	1978-1992	4.93"		ES2061L	ES2062R
		1963-1977	5.86"		ES330L	ES330R
7,000	(F070)	1988-1990	10.80"		ES3026L	ES3027R
		1978-1990	4.93"		ES2061L	ES2062R
		1963-1977	6.50"		ES332L	ES332R
7,500		1988-1992	10.80"		ES3026L	ES3027R
8,000	(FL1)	1990-1995	5.02"	1st Design w/Bead Clamp Retainer	ES3268L	ES3269R
		1994-1999	5.44"	2nd Design w/Swedge Rod End for Clamp Retention; (3675 kg)	ES3270L	ES3271R
8,100	(F090)	1983-1992	4.88"		ES405L	ES405R
9,000	(F090)	1963-1975	3.75"		ES176L	ES176R
		1975-1982	4.88"		ES405L	ES405R
		1983-1992	4.88"		ES405L	ES405R
		1979-1982	4.88"		ES405L	ES405R
12,000	(F120)	1983-1992	4.88"		ES405L	ES405R
		1979-1982	4.88"		ES405L	ES405R

Drag Links

Axle Lbs. Rating	Code	Year	Length (inches)	Notes	Drag Link No.	
5,000	(F050)	1973-1975	16.75"	To 1975 Second Design	DS835	
		1975-1992	17.00"	From 1975 Second Design	DS1064	
7,000	(F070)	1973-1975	16.75"	To 1975 Second Design	DS835	
		1975-1990	17.00"	1983-88 w/Power Steering Exc. Saginaw From 1975 Second Design	DS1064	
		1988-1990	17.53"	w/Saginaw Power Steering	DS1198	
8,000	(FL1)	1990-1999	20.28"	w/Air Brakes	DS1277	
			20.65"	w/Hydraulic Brakes	DS1216	
9,000	(F090)	1979-1988	17.96"		DS987	
				1979-1987		
				1988-1990		
			1988-1992	18.50"	Exc. Saginaw Power Steering w/Saginaw Power Steering	DS1199
11,000	(FL2)	1990-1999	20.28"	w/Air Brakes	DS1277	
			20.65"	w/Hydraulic Brakes	DS1216	
12,000	(F120)	1979-1990	17.93"		DS986	
			18.58"		DS1200	
			17.96"	w/Power Steering & Ram Cyl. w/Power Steering & Ram Cyl. Except Ram Cylinder	DS987	
			18.50"		DS1199	

C6500

King Bolt Sets

Axle Lbs. Rating	Code	Year	Diameter (inches)	Length (Inches)	Pin Type	Bushing	Notes	King Pin Set No.
7,000	(F070)	1969-1978	1.249"	7.890"	1	Metal		8491B
		1969-1978	1.259"	7.890"	1	Metal		8491B010
		1969-1978	1.249"	7.890"	1	Nylon		8491N

C6500 (Cont'd)

King Bolt Sets (Cont'd)

Axle Lbs. Rating	Code	Year	Diameter (inches)	Length (Inches)	Pin Type	Bushing	Notes	King Pin Set No.
9,000	(F090)	1969-1978	1.186/1.434"	8.750"	7	Metal		8462B
	(F090)	1969-1978	1.186/1.434"	8.750"	7	Nylon		8462N
11,000	(F110)	1969-1972	1.309/1.607"	9.750"	7	Metal		8386B
	(F110)	1969-1972	1.309/1.607"	9.750"	7	Nylon		8386N
12,000	(F120)	1969-1975	1.309/1.607"	9.750"	7	Metal		8386B
	(F120)	1969-1975	1.309/1.607"	9.750"	7	Nylon		8386N

Tie Rod Ends

Axle Lbs. Rating	Code	Year	Length (Inches)	Notes	Tie Rod End Part No.	
					Drivers Side	Passenger Side
7,000	(F070)	1969-1978	6.50"		ES332L	ES332R
9,000	(F090)	1969-1974	3.75"		ES176L	ES176R
	(F120D)	1975-1978	4.88"		ES405L	ES405R
11,000	(F110)	1969-1972	5.50"	Internal Threads	ES325L	ES325R
12,000	(F120)	1975-1978	4.88"	w/718934, 718936, 718937; 719597; 2000763; 2002084, 2002085, 2002086, 2002087 Axles - 3 Piece Grease Retainer	ES405L	ES405R
	(F120)	1969-1978	4.88"		ES405L	ES405R

Drag Links

Axle Lbs. Rating	Code	Year	Length (inches)	Notes	Drag Link No.
7,000	(F070)	1975-1978	17.00"	From 1975 Second Design	DS1064
9,000	(F090)	1973-1978	17.20"	w/Power Steering	DS982
			3.12"	Power Steering Cylinder End	ES2030R
	(F120D)	1973-1975 1975-1978	17.96"	From 1975 Second Design	DS987
			3.12"	Power Steering Cylinder End	ES2030R
12,000	(F120)	1975-1978	17.00"	From 1975 Second Design	DS1064
			17.96"		DS987
			3.12"	Power Steering Cylinder End	ES2030R

C7500, C7D, Topkick

King Bolt Sets

Axle Lbs. Rating	Code	Year	Diameter (inches)	Length (Inches)	Pin Type	Bushing	Notes	King Pin Set No.
7,000	(F070)	1979-1990	1.249"	7.890"	1	Metal		8491B
	(F070)	1979-1990	1.259"	7.890"	1	Metal		8491B010
	(F070)	1979-1990	1.249"	7.890"	1	Nylon		8491N
8,000	(FL1)	1990-1999	1.614"	8.035"	8	Metal	(3675 kg)	8659B
8,100	(F090D)	1984-1992	1.745"	9.380"	1	Metal		8613B
9,000	(F090)	1979-1987	1.186/1.434"	8.750"	7	Metal		8462B
	(F090)	1979-1987	1.186/1.434"	8.750"	7	Nylon		8462N
	(F120D)	1979-1990	1.745"	9.380"	1	Metal		8613B
11,000	(FL2)	1990-1999	1.892"	9.203"	8	Metal	(5000 kg)	8660B
12,000	(F120)	1979-1990	1.745"	9.380"	1	Metal		8613B
	(FS7)	1990-1999	1.892"	9.203"	8	Metal	w/Hydraulic Brakes; (5450 kg)	8660B
	(FS7)	1991-1999	1.892"	9.604"	8	Metal	w/Air Brakes; (5450 kg)	8661B
14,000	(FH0)	1990-1994	1.892"	9.604"	8	Metal		8661B
14,600	(FL3)	1990-1999	1.892"	9.604"	8	Metal		8661B
16,000	(PH4)	1993-1999	1.870"	9.970"	1	Composite	Two GM kits req'd per vehicle; (7275 kg)	8633C

Tie Rod Ends

Axle Lbs. Rating	Code	Year	Length (Inches)	Notes	Tie Rod End Part No.	
					Drivers Side	Passenger Side
7,000	(F070)	1988-1990	10.80"		ES3026L	ES3027R
	(F070)	1979-1990	4.93"		ES2061L	ES2062R
8,000	(FL1)	1994-1995	5.02"	1st Design w/Bead Clamp Retainer	ES3268L	ES3269R
	(FL1)	1990-1993	5.02"		ES3268L	ES3269R
	(FL1)	1994-1999	5.44"	2nd Design w/Swedge Rod End for Clamp Retention; (3675 kg)	ES3270L	ES3271R
8,100	(F090D)	1983-1987	4.93"		ES2061L	ES2062R
9,000	(F090)	1983-1992	4.88"	For 2035126 Axle Assy.	ES405L	ES405R
	(F090)	1975-1982	4.88"	Exc. 2035126 Axle Assy.	ES405L	ES405R
	(F120D)	1983-1992	4.88"		ES405L	ES405R
	(F120D)	1980-1986	4.88"		ES405L	ES405R

C7500, C7D, Topkick (Cont'd)

Heavy Duty Trucks

Tie Rod Ends (Cont'd)

Axle Lbs. Rating	Code	Year	Length (Inches)	Notes	Tie Rod End Part No.	
					Drivers Side	Passenger Side
11,000	(FL2)	1990-1999	5.44"	(5000 kg)	ES3274L	ES3275R
12,000	(F120)	1983-1992	4.88"	(5450 kg)	ES405L	ES405R
	(F120)	1979-1982	4.88"		ES405L	ES405R
	(FS7)	1990-1999	5.44"		ES3274L	ES3275R
14,000	(FH0)	1990-1994	5.44"	(6360 kg)	ES3274L	ES3275R
14,600	(FL3)	1991-1999	5.44"	(6610 kg)	ES3274L	ES3275R
16,000	(FH4)	1993-1999	7.37"	(7275 kg)	ES2090L	ES2091R

Drag Links

Axle Lbs. Rating	Code	Year	Length (inches)	Notes	Drag Link No.
5,000		1983-1988	17.00"		DS1064
7,000	(F070)	1979-1982	17.00"	w/Power Steering Exc. Saginaw Power Steering	DS1064
		1983-1988 1988-1992	17.53"		DS1198
8,000	(FL1)	1990-1999	20.28"	w/Saginaw Power Steering	DS1277
			20.65"	w/Air Brakes w/Hydraulic Brakes	DS1216
8,100	(F090D)	1983-1987	17.96"		DS987
9,000	(F090) (F120D)	1979-1988	17.96"	Exc. Saginaw Power Steering w/Saginaw Power Steering	DS987
		1979-1990 1988-1990	18.50"		DS1199
11,000	(FL2)	1990-1999	17.48"	w/Ross Gear	DS1217
			20.28"	w/Air Brakes and Saginaw Steering	DS1277
			20.65"	w/Hydraulic Brakes and Saginaw Steering	DS1216
			17.93"	Models w/Power Steering use Power Ram Cylinder	DS986
12,000	(F120)	1979-1990	17.93"	w/Air brakes W/Hydraulic Brakes, 1991-98	DS1200
		1988-1992	18.58"		DS1278
	(FS7)	1990-1999	16.85"		DS1278
		17.48"	DS1217		
14,000	(FH0)	1990-1994	16.85"		DS1278
14,500	(FL3)	1991-1999	16.85"		DS1278

C9500

King Bolt Sets

Axle Lbs. Rating	Code	Year	Diameter (inches)	Length (Inches)	Pin Type	Bushing	Notes	King Pin Set No.
9,000	(F090)	1963-1969	1.186/1.434"	8.750"	7	Metal		8462B
		1963-1969	1.186/1.434"	8.750"	7	Nylon		8462N
12,000	(F120)	1963-1969	1.309/1.607"	9.750"	7	Metal		8386B
		1963-1969	1.309/1.607"	9.750"	7	Nylon		8386N
16,000	(F160)	1963-1969	1.400/1.794"	10.688"	7	Metal		8474B

Tie Rod Ends

Axle Lbs. Rating	Code	Year	Length (Inches)	Notes	Tie Rod End Part No.	
					Drivers Side	Passenger Side
9,000	(F090)	1963-1969	3.75"		ES176L	ES176R
12,000	(F120)	1963-1969	5.50"	Internal Threads	ES325L	ES325R
16,000	(F160)	1963-1969	5.50"	Internal Threads	ES325L	ES325R

D9500

King Bolt Sets

Axle Lbs. Rating	Code	Year	Diameter (inches)	Length (Inches)	Pin Type	Bushing	Notes	King Pin Set No.
9,000	(F090)	1963-1969	1.186/1.434"	8.750"	7	Metal		8462B
		1963-1969	1.186/1.434"	8.750"	7	Nylon		8462N
11,000	(F110)	1963-1969	1.309/1.607"	9.750"	7	Metal		8386B
		1963-1969	1.309/1.607"	9.750"	7	Nylon		8386N
12,000	(F120 & FE900)	1963-1974	1.309/1.607"	9.750"	7	Metal		8386B
		1963-1974	1.309/1.607"	9.750"	7	Nylon		8386N
	(FE970)	1966-1968	1.607"	8.812"	2	Metal	(Center Point Steering)	8514B
		1966-1968	1.607"	8.812"	2	Nylon	(Center Point Steering)	8514N
16,000	(F160)	1969-1972	1.400/1.794"	10.688"	7	Metal		8474B
		1969-1978	1.999"	11.040"	2	Metal		8518B

D9500 (Cont'd)

King Bolt Sets (Cont'd)

Axle Lbs. Rating	Code	Year	Diameter (inches)	Length (Inches)	Pin Type	Bushing	Notes	King Pin Set No.
16,000	(FL901)	1969-1978	1.999"	11.040"	2	Nylon		8518N
	(FL931)	1973-1978	1.999"	11.212"	2	Metal		8571B

Tie Rod Ends

Axle Lbs. Rating	Code	Year	Length (Inches)	Notes	Tie Rod End Part No.	
					Drivers Side	Passenger Side
9,000	(F090)	1963-1969	3.75"		ES176L	ES176R
11,000	(F110)	1963-1969	5.50"	Internal Threads	ES325L	ES325R
12,000	(F120)	1975-1978	4.88"	Internal Threads	ES405L	ES405R
	(F120)	1970-1974	4.88"		ES405L	ES405R
	(F120)	1963-1969	5.50"		ES325L	ES325R
	(FE900)	1966-1972	4.88"		ES187L	ES187R
16,000	(F160)	1970-1972	4.88"	Internal Threads	ES405L	ES405R
	(F160)	1969-1969	5.50"		ES325L	ES325R
	(FL901)	1969-1978	5.75"		ES431L	ES431R
	(FL931)	1973-1974	5.75"		ES431L	ES431R
	(FL931)	1975-1978	7.37"		ES2090L	ES2091R

Drag Links

Axle Lbs. Rating	Code	Year	Length (inches)	Notes	Drag Link No.
12,000	(All)	1973-1978	17.90"	Color Coded White	DS988
			18.20"	Color Coded Blue	DS991
16,000	(All)	1973-1978	17.90"	Color Coded White	DS988
			18.20"	Color Coded Blue	DS991

E4500

King Bolt Sets

Axle Lbs. Rating	Code	Year	Diameter (inches)	Length (Inches)	Pin Type	Bushing	Notes	King Pin Set No.
4,000	(F040)	1967-1969	0.921"	5.640"	1	Metal		8445B
	(F040)	1967-1969	0.921"	5.640"	1	Nylon		8445N
5,500	(F055)	1967-1969	1.109"	6.344"	1	Metal	Thrust Washer Design	8484T
	(F055)	1967-1969	1.109"	6.344"	1	Metal	Thrust Bearing Design	8492B
	(F055)	1967-1969	1.109"	6.344"	1	Nylon	Thrust Bearing Design	8492N

Tie Rod Ends

Axle Lbs. Rating	Code	Year	Length (Inches)	Notes	Tie Rod End Part No.	
					Drivers Side	Passenger Side
5,500	(F055)	1967-1969	5.86"		ES330L	ES330R

E5500

King Bolt Sets

Axle Lbs. Rating	Code	Year	Diameter (inches)	Length (Inches)	Pin Type	Bushing	Notes	King Pin Set No.
5,500	(F055)	1967-1969	1.109"	6.344"	1	Metal	Thrust Washer Design	8484T
	(F055)	1967-1969	1.109"	6.344"	1	Metal	Thrust Bearing Design	8492B
	(F055)	1967-1969	1.109"	6.344"	1	Nylon	Thrust Bearing Design	8492N
7,000	(F070)	1967-1969	1.249"	7.890"	1	Metal		8491B
	(F070)	1967-1969	1.259"	7.890"	1	Metal		8491B010
	(F070)	1967-1969	1.249"	7.890"	1	Nylon		8491N

Tie Rod Ends

Axle Lbs. Rating	Code	Year	Length (Inches)	Notes	Tie Rod End Part No.	
					Drivers Side	Passenger Side
5,500	(F055)	1967-1969	5.86"		ES330L	ES330R
7,000	(F070)	1967-1969	6.50"		ES332L	ES332R

E6500

King Bolt Sets

Axle Lbs. Rating	Code	Year	Diameter (inches)	Length (Inches)	Pin Type	Bushing	Notes	King Pin Set No.
7,000	(F070)	1967-1969	1.249"	7.890"	1	Metal		8491B

E6500 (Cont'd)

King Bolt Sets (Cont'd)

Axle Lbs. Rating	Code	Year	Diameter (inches)	Length (Inches)	Pin Type	Bushing	Notes	King Pin Set No.
7,000	(F070)	1967-1969	1.259"	7.890"	1	Metal		8491B010
	(F070)	1967-1969	1.249"	7.890"	1	Nylon		8491N

Tie Rod Ends

Axle Lbs. Rating	Code	Year	Length (Inches)	Notes	Tie Rod End Part No.	
					Drivers Side	Passenger Side
7,000	(F070)	1967-1969	6.50"		ES332L	ES332R

F9500

King Bolt Sets

Axle Lbs. Rating	Code	Year	Diameter (inches)	Length (Inches)	Pin Type	Bushing	Notes	King Pin Set No.
9,000	(F090)	1963-1969	1.186/1.434"	8.750"	7	Metal		8462B
	(F090)	1963-1969	1.186/1.434"	8.750"	7	Nylon		8462N
11,000	(F110)	1963-1969	1.309/1.607"	9.750"	7	Metal		8386B
	(F110)	1963-1969	1.309/1.607"	9.750"	7	Nylon		8386N
12,000	(F120)	1963-1974	1.309/1.607"	9.750"	7	Metal		8386B
	(F120)	1975-1978	1.745"	9.380"	1	Metal		8613B
	(F120)	1963-1974	1.309/1.607"	9.750"	7	Nylon		8386N
	(FE970)	1966-1968	1.607"	8.812"	2	Metal	(Center Point Steering)	8514B
	(FE970)	1966-1968	1.607"	8.812"	2	Nylon	(Center Point Steering)	8514N
16,000	(F160)	1966-1972	1.400/1.794"	10.688"	7	Metal		8474B

Tie Rod Ends

Axle Lbs. Rating	Code	Year	Length (Inches)	Notes	Tie Rod End Part No.	
					Drivers Side	Passenger Side
9,000	(F090)	1963-1969	3.75"		ES176L	ES176R
11,000	(F110)	1963-1969	5.50"	Internal Threads	ES325L	ES325R
12,000	(F120)	1975-1978	4.88"		ES405L	ES405R
	(F120)	1970-1974	4.88"		ES405L	ES405R
	(F120)	1963-1969	5.50"	Internal Threads	ES325L	ES325R
16,000	(F160)	1970-1972	4.88"		ES405L	ES405R
	(F160)	1963-1969	5.50"	Internal Threads	ES325L	ES325R

Drag Links

Axle Lbs. Rating	Code	Year	Length (inches)	Notes	Drag Link No.
12,000	(All)	1973-1978	17.90"	Color Coded White	DS988
			18.20"	Color Coded Blue	DS991

General, N9E, N9F

King Bolt Sets

Axle Lbs. Rating	Code	Year	Diameter (inches)	Length (Inches)	Pin Type	Bushing	Notes	King Pin Set No.
9,000	(F120D)	1979-1980	1.745"	9.380"	1	Metal		8613B
10,860	(F120D)	1979-1979	1.745"	9.380"	1	Metal		8613B
12,000	(F120)	1975-1987	1.745"	9.380"	1	Metal		8613B
	(FF931)	1979-1983	1.794"	10.392"	2	Metal	Kit 195	8590B
	(FF933)	1979-1982	1.794"	10.392"	2	Metal		8590B
	(FF941)	1986-1987	1.794"	10.392"	2	Metal		8590B
16,000	(FL931)	1977-1982	1.999"	11.212"	2	Metal		8571B
18,000	(FL931)	1977-1987	1.999"	11.212"	2	Metal		8571B
	(FL941)	1977-1987	1.999"	11.212"	2	Metal		8571B

Tie Rod Ends

Axle Lbs. Rating	Code	Year	Length (Inches)	Notes	Tie Rod End Part No.	
					Drivers Side	Passenger Side
9,000	(F120D)	1979-1980	4.88"		ES405L	ES405R
10,860	(F120D)	1979-1979	4.88"		ES405L	ES405R
12,000	(F120)	1977-1987	4.88"		ES405L	ES405R
	(F120)	1977-1987	4.88"	Use w/2015558, 2015559, 2015580; 2019775, 2030613 Axles	ES405L	ES405R
	(FF931)	1979-1987	5.44"		ES423L	ES423R
	(FF933)	1979-1987	5.44"	1-1/8"-18 Optional Thread		ES3312R
	(FF933)	1977-1980	4.88"	Use w/2015558, 2015559, 2015580; 2019775, 2030613 Axles	ES405L	ES405R

General, N9E, N9F (Cont'd)

Tie Rod Ends (Cont'd)

Axle Lbs. Rating	Code	Year	Length (Inches)	Notes	Tie Rod End Part No.	
					Drivers Side	Passenger Side
12,000	(FF933)	1979-1982	4.88"	Use w/2013302 Axle	ES405L	ES405R
	(FF933)	1977-1980	5.44"		ES423L	ES423R
	(FF941)	1987-1988	5.44"		ES423L	ES423R
16,000	(FL931)	1979-1988	12.69"		ES3031L	ES3030R
	(FL931)	1979-1988	5.75"		ES431L	ES431R
	(FL931)	1979-1988	7.37"		ES2090L	ES2091R
18,000	(FL931)	1979-1988	12.69"		ES3031L	ES3030R
	(FL931)	1979-1988	5.75"		ES431L	ES431R
	(FL931)	1979-1988	7.37"		ES2090L	ES2091R
	(FL941)	1979-1987	12.69"		ES3031L	ES3030R
	(FL941)	1979-1987	5.75"		ES431L	ES431R
	(FL941)	1979-1987	7.37"		ES2090L	ES2091R
20,000	(FF941)	1986-1987	5.44"	A3144E525	ES423L	ES423R

Drag Links

Axle Lbs. Rating	Code	Year	Length (inches)	Notes	Drag Link No.
9,000	(F120D)	1979-1980	17.70"	w/Power Steering	DS910
			17.90"	w/Manual Steering	DS988
10,860	(F120D)	1979-1979	17.70"	w/Power Steering	DS910
			17.90"	w/Manual Steering	DS988
12,000	(F120)	1977-1987	16.89"	w/Ross Power Steering 1983-87	DS1044
			17.70"	w/Saginaw Pwr. Steering 1983-84	DS910
	(FF931)	1983-1983	17.90"	w/Manual Steering 1983-85	DS988
			17.70"	w/Power Steering	DS910
	(FF933)	1977-1982	17.90"	w/Manual Steering	DS988
			17.70"	w/Power Steering	DS910
(FF941)	1986-1987	16.89"	w/Manual Steering	DS988	
(FF941)	1986-1987	16.89"	w/Ross or Sheppard Pwr. Steering	DS1044	
16,000	(FL931)	1977-1982	17.70"	w/Power Steering-RH	DS941
				w/Power Steering-LH	DS910
18,000	(FL931)	1979-1984	17.70"	w/Power Steering-LH	DS910
				w/Power Steering-RH	DS941
	(FL941)	1983-1987	16.89"	w/Sheppard or Ross Power Steering-LH	DS1044
				w/Sheppard Pwr. Steering-RH	DS1067
	(FL941)	1977-1984	17.70"	w/Sheppard or Ross Power Steering-LH	DS1044
				w/Sheppard Pwr. Steering-RH	DS1067
(FL941)	1977-1984	17.70"	w/Saginaw Power Steering	DS910	

H5500

King Bolt Sets

Axle Lbs. Rating	Code	Year	Diameter (inches)	Length (Inches)	Pin Type	Bushing	Notes	King Pin Set No.
5,000	(F050)	1966-1967	1.109"	6.344"	1	Metal	Thrust Washer Design	8484T
	(F050)	1966-1967	1.109"	6.344"	1	Metal	Thrust Bearing Design	8492B
	(F050)	1966-1967	1.109"	6.344"	1	Nylon	Thrust Bearing Design	8492N
5,500	(F055)	1966-1967	1.109"	6.344"	1	Metal	Thrust Washer Design	8484T
	(F055)	1966-1967	1.109"	6.344"	1	Metal	Thrust Bearing Design	8492B
	(F055)	1966-1967	1.109"	6.344"	1	Nylon	Thrust Bearing Design	8492N
7,000	(F070)	1966-1967	1.249"	7.890"	1	Metal		8491B
	(F070)	1966-1967	1.259"	7.890"	1	Metal		8491B010
	(F070)	1966-1967	1.249"	7.890"	1	Nylon		8491N

Tie Rod Ends

Axle Lbs. Rating	Code	Year	Length (Inches)	Notes	Tie Rod End Part No.	
					Drivers Side	Passenger Side
5,000	(F050)	1966-1967	5.86"		ES330L	ES330R
5,500	(F055)	1966-1967	5.86"		ES330L	ES330R
7,000	(F070)	1966-1967	6.50"		ES332L	ES332R

H7500

King Bolt Sets

Axle Lbs. Rating	Code	Year	Diameter (inches)	Length (Inches)	Pin Type	Bushing	Notes	King Pin Set No.
7,000	(F070)	1966-1978	1.249"	7.890"	1	Metal		8491B
	(F070)	1966-1978	1.259"	7.890"	1	Metal		8491B010

H7500 (Cont'd)

King Bolt Sets (Cont'd)

Axle Lbs. Rating	Code	Year	Diameter (inches)	Length (Inches)	Pin Type	Bushing	Notes	King Pin Set No.
7,000	(F070)	1966-1978	1.249"	7.890"	1	Nylon		8491N
9,000	(F090)	1966-1978	1.186/1.434"	8.750"	7	Metal		8462B
	(F090)	1966-1978	1.186/1.434"	8.750"	7	Nylon		8462N
11,000	(F110)	1966-1972	1.309/1.607"	9.750"	7	Metal		8386B
	(F110)	1966-1972	1.309/1.607"	9.750"	7	Nylon		8386N
12,000	(F120)	1966-1974	1.309/1.607"	9.750"	7	Metal		8386B
	(F120)	1966-1974	1.309/1.607"	9.750"	7	Nylon		8386N
16,000	(FL901)	1966-1972	1.999"	11.040"	2	Metal		8518B
	(FL901)	1966-1972	1.999"	11.040"	2	Nylon		8518N

Tie Rod Ends

Axle Lbs. Rating	Code	Year	Length (Inches)	Notes	Tie Rod End Part No.	
					Drivers Side	Passenger Side
7,000	(F070)	1978-1978	4.93"	w/465018 Axle and 6V-53 Engine	ES2061L	ES2062R
	(F070)	1966-1978	6.50"		ES332L	ES332R
9,000	(F090)	1966-1978	3.75"	w/688568 Axle 1973-75 Only Exc. 688561; 688568; 200765; 2002081, 2002083 Axles	ES176L	ES176R
	(F090)	1973-1978	4.88"		ES405L	ES405R
11,000	(F110)	1966-1972	5.50"	Internal Threads	ES325L	ES325R
12,000	(F120)	1973-1978	4.88"	Internal Threads; Two used w/688561 Axle Exc. 688561; 688568; 200765,200767,200768 2002081,2002083 Axles	ES405L	ES405R
	(F120)	1973-1978	4.88"		ES405L	
	(F120)	1973-1978	5.50"	Internal Threads; Two used w/688561 Axle	ES325L	ES325R
	(F120)	1966-1972	5.50"			

Drag Links

Axle Lbs. Rating	Code	Year	Length (inches)	Notes	Drag Link No.
7,000	(F070)	1973-1978	17.90"	w/Manual Steering	DS988
9,000	(F090)	1970-1978	17.70"	w/Power Steering	DS910
		1975-1978	17.90"	w/Manual Steering	DS988
	(F120D)		17.70"	w/Power Steering	DS910
		17.90"	w/Manual Steering	DS988	
12,000	(F120)	1970-1978	17.70"	w/Power Steering	DS910
			17.90"	w/Manual Steering	DS988

H8500

King Bolt Sets

Axle Lbs. Rating	Code	Year	Diameter (inches)	Length (Inches)	Pin Type	Bushing	Notes	King Pin Set No.
7,000	(F070)	1966-1978	1.249"	7.890"	1	Metal		8491B
	(F070)	1966-1978	1.259"	7.890"	1	Metal		8491B010
	(F070)	1966-1978	1.249"	7.890"	1	Nylon		8491N
9,000	(F090)	1963-1978	1.186/1.434"	8.750"	7	Metal		8462B
	(F090)	1963-1978	1.186/1.434"	8.750"	7	Nylon		8462N
12,000	(F120)	1963-1974	1.309/1.607"	9.750"	7	Metal		8386B
	(F120)	1975-1978	1.745"	9.380"	1	Metal		8613B
	(F120)	1963-1974	1.309/1.607"	9.750"	7	Nylon		8386N

Tie Rod Ends

Axle Lbs. Rating	Code	Year	Length (Inches)	Notes	Tie Rod End Part No.	
					Drivers Side	Passenger Side
7,000	(F070)	1966-1978	6.50"		ES332L	ES332R
9,000	(F090)	1963-1969	3.75"		ES176L	ES176R
	(F090)	1973-1978	4.88"		ES405L	ES405R
12,000	(F120)	1973-1978	4.88"		ES405L	ES405R
	(F120)	1963-1969	5.50"	Internal Threads	ES325L	ES325R

Drag Links

Axle Lbs. Rating	Code	Year	Length (inches)	Notes	Drag Link No.
7,000	(F070)	1973-1978	17.90"	w/Manual Steering	DS988
9,000	(F090)	1973-1978	17.70"	w/Power Steering	DS910
			17.90"	w/Manual Steering	DS988
12,000	(F120)	1973-1978	17.70"	w/Power Steering	DS910
			17.90"	w/Manual Steering	DS988

H9500

King Bolt Sets

Axle Lbs. Rating	Code	Year	Diameter (inches)	Length (Inches)	Pin Type	Bushing	Notes	King Pin Set No.
7,000	(F070)	1966-1972	1.249"	7.890"	1	Metal		8491B
	(F070)	1966-1972	1.259"	7.890"	1	Metal		8491B010
	(F070)	1966-1972	1.249"	7.890"	1	Nylon		8491N
9,000	(F090)	1966-1978	1.186/1.434"	8.750"	7	Metal		8462B
	(F090)	1966-1978	1.186/1.434"	8.750"	7	Nylon		8462N
12,000	(F120)	1963-1974	1.309/1.607"	9.750"	7	Metal		8386B
	(F120)	1975-1978	1.745"	9.380"	1	Metal		8613B
	(F120)	1963-1974	1.309/1.607"	9.750"	7	Nylon		8386N
16,000	(F160)	1963-1972	1.400/1.794"	10.688"	7	Metal		8474B

Tie Rod Ends

Axle Lbs. Rating	Code	Year	Length (Inches)	Notes	Tie Rod End Part No.	
					Drivers Side	Passenger Side
7,000	(F070)	1966-1972	6.50"		ES332L	ES332R
9,000	(F090 & F120D)	1970-1978	4.88"		ES405L	ES405R
		1966-1969	3.75"		ES176L	ES176R
12,000	(F120)	1975-1978	4.88"		ES405L	ES405R
	(F120)	1970-1974	4.88"		ES405L	ES405R
	(F120)	1963-1969	5.50"	Internal Threads	ES325L	ES325R
16,000	(F160)	1970-1972	4.88"		ES405L	ES405R
	(F160)	1963-1969	5.50"	Internal Threads	ES325L	ES325R

Drag Links

Axle Lbs. Rating	Code	Year	Length (inches)	Notes	Drag Link No.
9,000	(F090)	1970-1978	17.70"	w/Power Steering	DS910
			17.90"	w/Manual Steering	DS988
12,000	(F120)	1970-1978	17.70"	w/Power Steering	DS910
			17.90"	w/Manual Steering	DS988

J7500

King Bolt Sets

Axle Lbs. Rating	Code	Year	Diameter (inches)	Length (Inches)	Pin Type	Bushing	Notes	King Pin Set No.
7,000	(F070)	1966-1978	1.249"	7.890"	1	Metal		8491B
	(F070)	1966-1978	1.259"	7.890"	1	Metal		8491B010
	(F070)	1966-1978	1.249"	7.890"	1	Nylon		8491N
9,000	(F090)	1966-1978	1.186/1.434"	8.750"	7	Metal		8462B
	(F090)	1966-1978	1.186/1.434"	8.750"	7	Nylon		8462N
11,000	(F110)	1966-1972	1.309/1.607"	9.750"	7	Metal		8386B
	(F110)	1966-1972	1.309/1.607"	9.750"	7	Nylon		8386N
12,000	(F120)	1966-1974	1.309/1.607"	9.750"	7	Metal		8386B
	(F120)	1975-1978	1.745"	9.380"	1	Metal		8613B
	(F120)	1966-1974	1.309/1.607"	9.750"	7	Nylon		8386N
16,000	(FL901)	1966-1978	1.999"	11.040"	2	Metal		8518B
	(FL901)	1966-1978	1.999"	11.040"	2	Nylon		8518N
	(FL931)	1973-1978	1.999"	11.212"	2	Metal		8571B

Tie Rod Ends

Axle Lbs. Rating	Code	Year	Length (Inches)	Notes	Tie Rod End Part No.	
					Drivers Side	Passenger Side
7,000	(F070)	1978-1978	4.93"	w/465018 Axle	ES2061L	ES2062R
		1966-1978	6.50"		ES332L	ES332R
9,000	(F090)	1973-1978	3.75"	w/688568 Axle	ES176L	ES176R
		1966-1972	3.75"		ES176L	ES176R
		1973-1978	4.88"	Exc. 688561; 688568; 200765; 2002081, 2002083 Axles	ES405L	ES405R
11,000	(F110)	1966-1972	5.50"	Internal Threads	ES325L	ES325R
12,000	(F120)	1973-1978	4.88"	Exc. 688561; 688568; 200765, 200767, 200768; 2002081, 83 Axles	ES405L	ES405R
		1973-1978	5.50"	Internal Threads; Two used w/688561 Axle	ES325L	ES325R
		1966-1972	5.50"	Internal Threads	ES325L	ES325R
16,000	(FL901)	1966-1978	5.75"		ES431L	ES431R
	(FL931)	1973-1978	12.69"		ES3031L	ES3030R
	(FL931)	1973-1978	5.75"		ES431L	ES431R
	(FL931)	1973-1978	7.37"	Use w/718314; 719708; 719831; 2025882; 2025886 Axles	ES2090L	ES2091R

J7500 (Cont'd)

Drag Links

Axle Lbs. Rating	Code	Year	Length (inches)	Notes	Drag Link No.	
7,000	(F070)	1973-1978	17.90"	w/Manual Steering	DS988	
9,000	(F090)	1970-1978	17.70"	w/Power Steering	DS910	
			17.90"	w/Manual Steering	DS988	
	(F120D)	1975-1978	17.70"	w/Power Steering	DS910	
			17.90"	w/Manual Steering	DS988	
12,000	(F120)	1970-1978	17.70"	w/Power Steering	DS910	
			17.90"	w/Manual Steering	DS988	
16,000	(FL901)	1973-1978	17.82"	w/Power Steering-LH	DS939	
			17.90"	w/Manual Steering	DS988	
	(FL931)		17.70"	w/Power Steering-RH	DS941	
				w/Power Steering-LH	DS910	

J8500

King Bolt Sets

Axle Lbs. Rating	Code	Year	Diameter (inches)	Length (Inches)	Pin Type	Bushing	Notes	King Pin Set No.	
9,000	(F090)	1963-1978	1.186/1.434"	8.750"	7	Metal		8462B	
	(F090)	1963-1978	1.186/1.434"	8.750"	7	Nylon		8462N	
12,000	(F120)	1963-1974	1.309/1.607"	9.750"	7	Metal		8386B	
	(F120)	1975-1978	1.745"	9.380"	1	Metal		8613B	
	(F120)	1963-1974	1.309/1.607"	9.750"	7	Nylon		8386N	
16,000	(F160)	1963-1972	1.400/1.794"	10.688"	7	Metal		8474B	
	(FL901)	1973-1974	1.999"	11.040"	2	Metal		8518B	
	(FL901)	1973-1974	1.999"	11.040"	2	Nylon		8518N	

Tie Rod Ends

Axle Lbs. Rating	Code	Year	Length (Inches)	Notes	Tie Rod End Part No.	
					Drivers Side	Passenger Side
9,000	(F090 & F120D)	1973-1978	4.88"		ES405L	ES405R
		1963-1972	3.75"		ES176L	ES176R
12,000	(F120)	1973-1978	4.88"		ES405L	ES405R
		1963-1973	5.50"	Internal Threads	ES325L	ES325R
16,000	(F160)	1963-1972	5.50"	Internal Threads	ES325L	ES325R
		1973-1974	5.75"		ES431L	ES431R

Drag Links

Axle Lbs. Rating	Code	Year	Length (inches)	Notes	Drag Link No.	
9,000	(F090)	1973-1978	17.70"	w/Power Steering	DS910	
			17.90"	w/6V-53, 432, 478 Engines & w/Manual Strg.	DS988	
12,000	(F120)	1973-1978	17.70"	w/Power Steering	DS910	
			17.90"	w/Manual Steering	DS988	
16,000	(FL901)	1973-1974	17.82"	w/Power Steering-LH	DS939	
			17.90"	w/Power Steering-RH	DS938	
				w/6V-53 Engine	DS988	

J9500

King Bolt Sets

Axle Lbs. Rating	Code	Year	Diameter (inches)	Length (Inches)	Pin Type	Bushing	Notes	King Pin Set No.	
9,000	(F090)	1963-1978	1.186/1.434"	8.750"	7	Metal		8462B	
	(F090)	1963-1978	1.186/1.434"	8.750"	7	Nylon		8462N	
12,000	(F120)	1963-1974	1.309/1.607"	9.750"	7	Metal		8386B	
	(F120)	1963-1974	1.309/1.607"	9.750"	7	Nylon		8386N	
16,000	(F160)	1963-1969	1.400/1.794"	10.688"	7	Metal		8474B	
	(FL901)	1971-1978	1.999"	11.040"	2	Metal		8518B	
	(FL901)	1971-1978	1.999"	11.040"	2	Nylon		8518N	
	(FL931)	1973-1978	1.999"	11.212"	2	Metal		8571B	

Tie Rod Ends

Axle Lbs. Rating	Code	Year	Length (Inches)	Notes	Tie Rod End Part No.	
					Drivers Side	Passenger Side
9,000	(F090)	1963-1969	3.75"		ES176L	ES176R
	(F090)	1970-1978	4.88"		ES405L	ES405R
12,000	(F120)	1975-1978	4.88"		ES405L	ES405R

J9500 (Cont'd)

Tie Rod Ends (Cont'd)

Axle Lbs. Rating	Code	Year	Length (Inches)	Notes	Tie Rod End Part No.	
					Drivers Side	Passenger Side
12,000	(F120)	1970-1974	4.88"	Internal Threads	ES405L	ES405R
	(F120)	1963-1969	5.50"		ES325L	ES325R
16,000	(F160)	1963-1969	5.50"	Internal Threads	ES325L	ES325R
	(FL901)	1971-1978	5.75"		ES431L	ES431R
	(FL931)	1973-1974	5.75"		ES431L	ES431R
	(FL931)	1975-1978	7.37"		ES2090L	ES2091R

Drag Links

Axle Lbs. Rating	Code	Year	Length (inches)	Notes	Drag Link No.
9,000	(F090)	1970-1978	17.70"	w/Power Steering	DS910
			17.90"	w/Manual Steering	DS988
12,000	(F120)	1970-1978	17.70"	w/Power Steering	DS910
			17.90"	w/Manual Steering	DS988
16,000	(FL901)	1973-1978	17.82"	w/Power Steering-LH	DS939
			17.70"	w/Power Steering-RH	DS938
				w/Power Steering-LH	DS941
	(FL931)				DS910

M6000

King Bolt Sets

Axle Lbs. Rating	Code	Year	Diameter (inches)	Length (Inches)	Pin Type	Bushing	Notes	King Pin Set No.
7,000	(F070)	1978-1979	1.249"	7.890"	1	Metal		8491B
	(F070)	1978-1979	1.259"	7.890"	1	Metal		8491B010
	(F070)	1978-1979	1.249"	7.890"	1	Nylon		8491N
9,000	(F090)	1978-1979	1.186/1.434"	8.750"	7	Metal		8462B
	(F090)	1978-1979	1.186/1.434"	8.750"	7	Nylon		8462N
12,000	(F120)	1978-1979	1.309/1.607"	9.750"	7	Metal		8386B
	(F120)	1978-1979	1.309/1.607"	9.750"	7	Nylon		8386N

Tie Rod Ends

Axle Lbs. Rating	Code	Year	Length (Inches)	Notes	Tie Rod End Part No.	
					Drivers Side	Passenger Side
7,000	(F070)	1978-1979	4.93"		ES2061L	ES2062R
9,000	(F090)	1978-1979	4.88"		ES405L	ES405R
12,000	(F120)	1978-1979	4.88"		ES405L	ES405R

Drag Links

Axle Lbs. Rating	Code	Year	Length (inches)	Notes	Drag Link No.
7,000	(F070)	1978-1979	17.00"		DS1064
9,000	(F090)	1978-1979	17.00"		DS1064
12,000	(F120)	1978-1979	17.00"		DS1064

M6500

King Bolt Sets

Axle Lbs. Rating	Code	Year	Diameter (inches)	Length (Inches)	Pin Type	Bushing	Notes	King Pin Set No.
7,000	(F070)	1969-1978	1.249"	7.890"	1	Metal		8491B
	(F070)	1969-1978	1.259"	7.890"	1	Metal		8491B010
	(F070)	1969-1978	1.249"	7.890"	1	Nylon		8491N
9,000	(F090)	1969-1978	1.186/1.434"	8.750"	7	Metal		8462B
	(F090)	1969-1978	1.186/1.434"	8.750"	7	Nylon		8462N
11,000	(F110)	1969-1972	1.309/1.607"	9.750"	7	Metal		8386B
	(F110)	1969-1972	1.309/1.607"	9.750"	7	Nylon		8386N
12,000	(F120)	1969-1975	1.309/1.607"	9.750"	7	Metal		8386B
	(F120)	1969-1975	1.309/1.607"	9.750"	7	Nylon		8386N

Tie Rod Ends

Axle Lbs. Rating	Code	Year	Length (Inches)	Notes	Tie Rod End Part No.	
					Drivers Side	Passenger Side
7,000	(F070)	1969-1978	6.50"		ES332L	ES332R

M6500 (Cont'd)

Tie Rod Ends (Cont'd)

Axle Lbs. Rating	Code	Year	Length (Inches)	Notes	Tie Rod End Part No.	
					Drivers Side	Passenger Side
9,000	(F090 & F120D) (F090)	1975-1978	4.88"		ES405L	ES405R
		1969-1974	3.75"		ES176L	ES176R
11,000	(F110)	1969-1972	5.50"	Internal Threads	ES325L	ES325R
12,000	(F120)	1975-1978	4.88"	w/718934, 718936, 718937; 719597; 2000763; 2002084, 2002085, 2002086, 2002087 Axles	ES405L	ES405R
	(F120)	1969-1978	4.88"		ES405L	ES405R

Drag Links

Axle Lbs. Rating	Code	Year	Length (inches)	Notes	Drag Link No.
7,000	(F070)	1975-1978	17.00"	From 1975 Second Design	DS1064
9,000	(F090)	1973-1978	17.20"	w/Power Steering	DS982
			3.12"	Power Steering Cylinder End	ES2030R
	(F120D)	1973-1975	17.96"	From 1975 Second Design	DS987
		1975-1978	3.12"	Power Steering Cylinder End	ES2030R
			17.00"	From 1975 Second Design	DS1064
			17.96"		DS987
12,000	(F120)	1973-1978	3.12"	Power Steering Cylinder End	ES2030R

M9500

King Bolt Sets

Axle Lbs. Rating	Code	Year	Diameter (inches)	Length (Inches)	Pin Type	Bushing	Notes	King Pin Set No.
9,000	(F090) (F090) (F120D)	1963-1976	1.186/1.434"	8.750"	7	Metal		8462B
			1.186/1.434"	8.750"	7	Nylon		8462N
		1975-1978	1.745"	9.380"	1	Metal		8613B
12,000	(F120 & FE900) (F120 & FE900)	1963-1974	1.309/1.607"	9.750"	7	Metal		8386B
		1963-1974	1.309/1.607"	9.750"	7	Nylon		8386N
16,000	(F160) (FL901) (FL901) (FL931)	1963-1972	1.400/1.794"	10.688"	7	Metal		8474B
		1971-1974	1.999"	11.040"	2	Metal		8518B
		1971-1974	1.999"	11.040"	2	Nylon		8518N
		1973-1978	1.999"	11.212"	2	Metal		8571B

Tie Rod Ends

Axle Lbs. Rating	Code	Year	Length (Inches)	Notes	Tie Rod End Part No.	
					Drivers Side	Passenger Side
9,000	(F090) (F090)	1963-1969	3.75"		ES176L	ES176R
		1970-1978	4.88"		ES405L	ES405R
12,000	(F120) (F120) (FE900)	1970-1974	4.88"	Internal Threads	ES405L	ES405R
		1963-1969	5.50"		ES325L	ES325R
		1966-1968	4.88"		ES187L	ES187R
16,000	(F160) (FL901) (FL931) (FL931) (FL931)	1963-1972	5.50"	Internal Threads	ES325L	ES325R
		1971-1974	5.75"		ES431L	ES431R
		1973-1978	12.69"		ES3031L	ES3030R
		1973-1978	5.75"		ES431L	ES431R
		1973-1978	7.37"		ES2090L	ES2091R

Drag Links

Axle Lbs. Rating	Code	Year	Length (inches)	Notes	Drag Link No.
9,000	(F090)	1970-1974	17.70"	w/Power Steering	DS910
			17.90"	w/Manual Steering	DS988
12,000	(F120)	1970-1974	17.70"	w/Power Steering	DS910
			17.90"	w/Manual Steering	DS988
16,000	(FL901) (FL931)	1973-1974	17.82"	w/Power Steering-RH	DS939
			17.70"	w/Power Steering-LH	DS938
					DS941
					DS910

P4500

King Bolt Sets

Axle Lbs. Rating	Code	Year	Diameter (inches)	Length (Inches)	Pin Type	Bushing	Notes	King Pin Set No.
5,000	(F050)	1979-1990	1.179"	6.360"	1	Metal		8570B
	(F050)	1979-1990	1.179"	6.360"	1	Nylon		8570N
7,000	(F070)	1979-1984	1.249"	7.890"	1	Metal		8491B
	(F070)	1979-1984	1.259"	7.890"	1	Metal		8491B010
	(F070)	1979-1984	1.249"	7.890"	1	Nylon		8491N

Tie Rod Ends

Axle Lbs. Rating	Code	Year	Length (Inches)	Notes	Tie Rod End Part No.	
					Drivers Side	Passenger Side
5,000	(F050)	1979-1990	4.93"		ES2061L	ES2062R
7,000	(F070)	1979-1984	4.93"		ES2061L	ES2062R

Drag Links

Axle Lbs. Rating	Code	Year	Length (inches)	Notes	Drag Link No.
5,000	(F050)	1982-1990	24.12"	w/Hydraulic Brakes	DS1195
7,000	(F070)	1979-1982	24.12"	w/Hydraulic Brakes	DS1196

P6000

King Bolt Sets

Axle Lbs. Rating	Code	Year	Diameter (inches)	Length (Inches)	Pin Type	Bushing	Notes	King Pin Set No.
5,000	(F050)	1983-1990	1.179"	6.360"	1	Metal		8570B
	(F050)	1983-1990	1.179"	6.360"	1	Nylon		8570N
7,000	(F070)	1983-1990	1.249"	7.890"	1	Metal		8491B
	(F070)	1983-1990	1.259"	7.890"	1	Metal		8491B010
	(F070)	1983-1990	1.249"	7.890"	1	Nylon		8491N
8,000	(FL1)	1992-1996	1.614"	8.035"	8	Metal		8659B
9,000	(F090)	1984-1990	1.745"	9.380"	1	Metal		8613B
11,000	(FL2)	1992-1996	1.892"	9.203"	8	Metal		8660B
12,000	(F120)	1984-1990	1.745"	9.380"	1	Metal		8613B

Tie Rod Ends

Axle Lbs. Rating	Code	Year	Length (Inches)	Notes	Tie Rod End Part No.	
					Drivers Side	Passenger Side
5,000	(F050)	1983-1990	4.93"		ES2061L	ES2062R
7,000	(F070)	1988-1990	10.80"		ES3026L	ES3027R
	(F070)	1983-1987	4.93"		ES2061L	ES2062R
8,000	(FL1)	1992-1994	5.02"	First Design	ES3268L	ES3269R
	(FL1)	1994-1996	5.44"	Second Design	ES3270L	ES3271R
9,000	(F090)	1983-1990	4.88"		ES405L	ES405R
11,000	(FL2)	1992-1996	5.44"		ES3274L	ES3275R
12,000	(F120)	1984-1990	4.88"		ES405L	ES405R

Drag Links

Axle Lbs. Rating	Code	Year	Length (inches)	Notes	Drag Link No.
5,000	(F050)	1983-1990	17.00"		DS1064
7,000	(F070)	1983-1990	17.00"	Exc. Motor Home Applications	DS1064
		1984-1990	17.62"	Motor Home Application w/Hydraulic Brakes	DS1197
		1988-1990	17.53"		DS1198
8,000	(FL1)	1992-1996	20.65"		DS1216
9,000	(F120D)	1983-1990	17.96"	w/Saginaw Power Steering & Hydraulic Brakes	DS987
		1988-1990	18.50"		DS1199
11,000	(FL2)	1992-1996	20.65"		DS1216
12,000	(F120)	1984-1990	17.96"		DS987

P6S

King Bolt Sets

Axle Lbs. Rating	Code	Year	Diameter (inches)	Length (Inches)	Pin Type	Bushing	Notes	King Pin Set No.
8,000		1992-1996	1.614"	8.035"	8	Metal	(3675 kg)	8659B
11,000		1992-1996	1.892"	9.203"	8	Metal	(5000 kg)	8660B

P6S (Cont'd)

Tie Rod Ends

Axle Lbs. Rating	Code	Year	Length (Inches)	Notes	Tie Rod End Part No.	
					Drivers Side	Passenger Side
8,000	(FL1)	1992-1994	5.02"	First Design	ES3268L	ES3269R
	(FL1)	1994-1996	5.44"	Second Design	ES3270L	ES3271R
11,000		1992-1996	5.44"	(5000 kg)	ES3274L	ES3275R

Drag Links

Axle Lbs. Rating	Code	Year	Length (inches)	Notes	Drag Link No.
8,000	(FL1)		20.65"		DS1216
11,000	(FL2)		20.65"		DS1216

R8500

King Bolt Sets

Axle Lbs. Rating	Code	Year	Diameter (inches)	Length (Inches)	Pin Type	Bushing	Notes	King Pin Set No.
9,000	(F090)	1973-1973	1.186/1.434"	8.750"	7	Metal		8462B
	(F090)	1973-1973	1.186/1.434"	8.750"	7	Nylon		8462N

Tie Rod Ends

Axle Lbs. Rating	Code	Year	Length (Inches)	Notes	Tie Rod End Part No.	
					Drivers Side	Passenger Side
9,000	(F090)	1973-1973	4.88"		ES405L	ES405R

S5500

King Bolt Sets

Axle Lbs. Rating	Code	Year	Diameter (inches)	Length (Inches)	Pin Type	Bushing	Notes	King Pin Set No.
5,000	(F050)	1971-1972	1.109"	6.344"	1	Metal	First Design	8490T
7,000	(F070)	1971-1972	1.249"	7.890"	1	Metal		8491B
	(F070)	1971-1972	1.259"	7.890"	1	Metal		8491B010
	(F070)	1971-1972	1.249"	7.890"	1	Nylon		8491N

Tie Rod Ends

Axle Lbs. Rating	Code	Year	Length (Inches)	Notes	Tie Rod End Part No.	
					Drivers Side	Passenger Side
5,000	(F055)	1971-1972	5.86"		ES330L	ES330R
7,000	(F070)	1971-1972	6.50"		ES332L	ES332R

Drag Links

Axle Lbs. Rating	Code	Year	Length (inches)	Notes	Drag Link No.
5,500	(F055)	1971-1972	16.75"	w/ 2 1/2" Springs	DS835

S6000

King Bolt Sets

Axle Lbs. Rating	Code	Year	Diameter (inches)	Length (Inches)	Pin Type	Bushing	Notes	King Pin Set No.
5,500	(F055)	1973-1975	1.109"	6.344"	1	Metal	To 1975 Second Design; Thrust Washer De	8484T
	(F055)	1973-1975	1.109"	6.344"	1	Metal	To 1975 Second Design; Thrust Bearing De	8492B
	(F055)	1975-1979	1.179"	6.360"	1	Metal	From 1975 Second Design	8570B
	(F055)	1975-1979	1.189"	6.360"	1	Metal	From 1975 Second Design	8570B010
	(F055)	1973-1975	1.109"	6.344"	1	Nylon	To 1975 Second Design; Thrust Bearing De	8492N
	(F055)	1975-1979	1.179"	6.360"	1	Nylon	From 1975 Second Design	8570N
7,000	(F070)	1973-1979	1.249"	7.890"	1	Metal		8491B
	(F070)	1973-1979	1.259"	7.890"	1	Metal		8491B010
	(F070)	1973-1979	1.249"	7.890"	1	Nylon		8491N
9,000	(F090)	1973-1979	1.186/1.434"	8.750"	7	Metal		8462B
	(F090)	1973-1979	1.186/1.434"	8.750"	7	Nylon		8462N

Tie Rod Ends

Axle Lbs. Rating	Code	Year	Length (Inches)	Notes	Tie Rod End Part No.	
					Drivers Side	Passenger Side
5,500	(F055)	1973-1979	5.86"		ES330L	ES330R

S6000 (Cont'd)

Tie Rod Ends (Cont'd)

Axle Lbs. Rating	Code	Year	Length (Inches)	Notes	Tie Rod End Part No.	
					Drivers Side	Passenger Side
7,000	(F070)	1978-1979	4.93"		ES2061L	ES2062R
	(F070)	1973-1977	6.50"		ES332L	ES332R
9,000	(F090)	1973-1974	3.75"		ES176L	ES176R
	(F090)	1975-1979	4.88"		ES405L	ES405R

Drag Links

Axle Lbs. Rating	Code	Year	Length (inches)	Notes	Drag Link No.
5.500	(F055)	1973-1975	16.75"	To 1975 Second Design	DS835
		1975-1979	17.00"	From 1975 Second Design	DS1064
7.000	(F070)	1973-1975	16.75"	To 1975 Second Design	DS835
		1975-1979	17.00"	From 1975 Second Design	DS1064

S7500, S7T

King Bolt Sets

Axle Lbs. Rating	Code	Year	Diameter (inches)	Length (Inches)	Pin Type	Bushing	Notes	King Pin Set No.
12,000	(F120)	1983-1990	1.745"	9.380"	1	Metal		8613B
13,200	(FG943)	1987-1990	1.794"	10.392"	2	Metal		8590B

Tie Rod Ends

Axle Lbs. Rating	Code	Year	Length (Inches)	Notes	Tie Rod End Part No.	
					Drivers Side	Passenger Side
9,000	(F120)	1983-1990	4.88"		ES405L	ES405R
	(F120D)	1983-1990	4.88"		ES405L	ES405R
12,000	(F120)	1983-1990	4.88"		ES405L	ES405R
	(F120D)	1983-1990	4.88"		ES405L	ES405R
13,200	(FG943)	1987-1990	5.44"		ES423L	ES423R

Drag Links

Axle Lbs. Rating	Code	Year	Length (inches)	Notes	Drag Link No.
9,000	(F120)	1983-1984	17.70"	w/Power Steering-LH	DS910
12,000	(F120)	1983-1984	17.70"	w/Power Steering-LH	DS910
13,200	(FF932)	1983-1984	17.70"	w/Power Steering	DS910

T5500

King Bolt Sets

Axle Lbs. Rating	Code	Year	Diameter (inches)	Length (Inches)	Pin Type	Bushing	Notes	King Pin Set No.
7,000	(F070)	1970-1972	1.249"	7.890"	1	Metal		8491B
	(F070)	1970-1972	1.259"	7.890"	1	Metal		8491B010
	(F070)	1970-1972	1.249"	7.890"	1	Nylon		8491N
9,000	(F090)	1970-1972	1.186/1.434"	8.750"	7	Metal		8462B
	(F090)	1970-1972	1.186/1.434"	8.750"	7	Nylon		8462N

Tie Rod Ends

Axle Lbs. Rating	Code	Year	Length (Inches)	Notes	Tie Rod End Part No.	
					Drivers Side	Passenger Side
7,000	(F070)	1970-1972	6.50"		ES332L	ES332R
9,000	(F090)	1970-1972	4.88"		ES405L	ES405R

T6000

King Bolt Sets

Axle Lbs. Rating	Code	Year	Diameter (inches)	Length (Inches)	Pin Type	Bushing	Notes	King Pin Set No.
7,000	(F070)	1973-1978	1.249"	7.890"	1	Metal		8491B
	(F070)	1973-1978	1.259"	7.890"	1	Metal		8491B010
	(F070)	1973-1978	1.249"	7.890"	1	Nylon		8491N
9,000	(F090)	1973-1978	1.186/1.434"	8.750"	7	Metal		8462B
	(F090)	1973-1978	1.186/1.434"	8.750"	7	Nylon		8462N

GMC TRUCK



T6000 (Cont'd)

Tie Rod Ends

Axle Lbs. Rating	Code	Year	Length (Inches)	Notes	Tie Rod End Part No.	
					Drivers Side	Passenger Side
7,000	(F070)	1978-1978	4.93"		ES2061L	ES2062R
	(F070)	1973-1977	6.50"		ES332L	ES332R
9,000	(F090)	1973-1975	3.75"	To 1975 Second Design From 1975 Second Design	ES176L	ES176R
	(F090)	1975-1978	4.88"		ES405L	ES405R

T6500

King Bolt Sets

Axle Lbs. Rating	Code	Year	Diameter (inches)	Length (Inches)	Pin Type	Bushing	Notes	King Pin Set No.
7,000	(F070)	1970-1978	1.249"	7.890"	1	Metal		8491B
	(F070)	1970-1978	1.259"	7.890"	1	Metal		8491B010
	(F070)	1970-1978	1.249"	7.890"	1	Nylon		8491N
9,000	(F090)	1970-1978	1.186/1.434"	8.750"	7	Metal		8462B
	(F090)	1970-1978	1.186/1.434"	8.750"	7	Nylon		8462N
12,000	(F120)	1970-1975	1.309/1.607"	9.750"	7	Metal		8386B
	(F120)	1970-1975	1.309/1.607"	9.750"	7	Nylon		8386N

Tie Rod Ends

Axle Lbs. Rating	Code	Year	Length (Inches)	Notes	Tie Rod End Part No.	
					Drivers Side	Passenger Side
7,000	(F070)	1970-1978	6.50"		ES332L	ES332R
9,000	(F090 & F120D)	1975-1978	4.88"		ES405L	ES405R
	(F090)	1970-1974	3.75"		ES176L	ES176R
12,000	(F120)	1975-1978	4.88"	w/718934, 718936, 718937; 719597; 2000763; 2002084, 2002085, 2002086, 2002087 Axles	ES405L	ES405R
	(F120)	1970-1978	4.88"		ES405L	ES405R

Drag Links

Axle Lbs. Rating	Code	Year	Length (inches)	Notes	Drag Link No.
7,000	(F070)	1978-1978	32.22"	TE6500 ONLY	DS983

T7500

King Bolt Sets

Axle Lbs. Rating	Code	Year	Diameter (inches)	Length (Inches)	Pin Type	Bushing	Notes	King Pin Set No.
7,000	(F070)	1966-1978	1.249"	7.890"	1	Metal		8491B
	(F070)	1966-1978	1.259"	7.890"	1	Metal		8491B010
	(F070)	1966-1978	1.249"	7.890"	1	Nylon		8491N
9,000	(F090)	1966-1978	1.186/1.434"	8.750"	7	Metal		8462B
	(F090)	1966-1978	1.186/1.434"	8.750"	7	Nylon		8462N
11,000	(F110)	1966-1972	1.309/1.607"	9.750"	7	Metal		8386B
	(F110)	1966-1972	1.309/1.607"	9.750"	7	Nylon		8386N
12,000	(F120)	1966-1974	1.309/1.607"	9.750"	7	Metal		8386B
	(F120)	1975-1978	1.745"	9.380"	1	Metal		8613B
	(F120)	1966-1974	1.309/1.607"	9.750"	7	Nylon		8386N

Tie Rod Ends

Axle Lbs. Rating	Code	Year	Length (Inches)	Notes	Tie Rod End Part No.	
					Drivers Side	Passenger Side
7,000	(F070)	1978-1978	4.93"	w/465018 Axle	ES2061L	ES2062R
	(F070)	1966-1978	6.50"		ES332L	ES332R
9,000	(F090)	1973-1978	3.75"	w/688568 Axle	ES176L	ES176R
	(F090)	1966-1972	3.75"		ES176L	ES176R
	(F090)	1973-1978	4.88"		ES405L	ES405R
	(F090)	1972-1972	4.88"		ES405L	ES405R
11,000	(F110)	1966-1972	5.50"	Internal Threads	ES325L	ES325R
12,000	(F120)	1973-1978	4.88"	Exc. 688561; 688568; 200765, 200767, 200768 Axles	ES405L	ES405R
	(F120)	1973-1974	4.88"		ES405L	ES405R
	(F120)	1970-1970	4.88"		ES405L	ES405R
	(F120)	1973-1978	5.50"		ES325L	ES325R
	(F120)	1971-1972	5.50"		Internal Threads; Two used w/688561 Axle Internal Threads	ES325L

T7500 (Cont'd)

Tie Rod Ends (Cont'd)

Axle Lbs. Rating	Code	Year	Length (Inches)	Notes	Tie Rod End Part No.	
					Drivers Side	Passenger Side
12,000	(F120)	1966-1969	5.50"	Internal Threads	ES325L	ES325R

T8500

King Bolt Sets

Axle Lbs. Rating	Code	Year	Diameter (inches)	Length (Inches)	Pin Type	Bushing	Notes	King Pin Set No.
9,000	(F090)	1963-1978	1.186/1.434"	8.750"	7	Metal		8462B
	(F090)	1963-1978	1.186/1.434"	8.750"	7	Nylon		8462N
11,000	(F110)	1963-1969	1.309/1.607"	9.750"	7	Metal		8386B
	(F110)	1963-1969	1.309/1.607"	9.750"	7	Nylon		8386N
12,000	(F120)	1973-1978	1.309/1.607"	9.750"	7	Metal		8386B
	(F120)	1973-1978	1.309/1.607"	9.750"	7	Nylon		8386N

Tie Rod Ends

Axle Lbs. Rating	Code	Year	Length (Inches)	Notes	Tie Rod End Part No.	
					Drivers Side	Passenger Side
9,000	(F090)	1963-1969	3.75"		ES176L	ES176R
	(F090)	1973-1978	4.88"		ES405L	ES405R
11,000	(F110)	1963-1969	5.50"	Internal Threads	ES325L	ES325R
12,000	(F120)	1973-1978	4.88"		ES405L	ES405R

T9500

King Bolt Sets

Axle Lbs. Rating	Code	Year	Diameter (inches)	Length (Inches)	Pin Type	Bushing	Notes	King Pin Set No.
9,000	(F090)	1963-1972	1.186/1.434"	8.750"	7	Metal		8462B
	(F090)	1963-1972	1.186/1.434"	8.750"	7	Nylon		8462N
11,000	(F110)	1963-1972	1.309/1.607"	9.750"	7	Metal		8386B
	(F110)	1963-1972	1.309/1.607"	9.750"	7	Nylon		8386N
12,000	(F120)	1970-1978	1.309/1.607"	9.750"	7	Metal		8386B
	(F120)	1970-1978	1.309/1.607"	9.750"	7	Nylon		8386N
16,000	(F160)	1963-1972	1.400/1.794"	10.688"	7	Metal		8474B

Tie Rod Ends

Axle Lbs. Rating	Code	Year	Length (Inches)	Notes	Tie Rod End Part No.	
					Drivers Side	Passenger Side
9,000	(F090)	1963-1969	3.75"		ES176L	ES176R
	(F090)	1970-1972	4.88"		ES405L	ES405R
11,000	(F110)	1963-1972	5.50"	Internal Threads	ES325L	ES325R
12,000	(F120)	1970-1978	4.88"		ES405L	ES405R
	(F120)	1963-1969	5.50"	Internal Threads	ES325L	ES325R
16,000	(F160)	1963-1972	5.50"	Internal Threads	ES325L	ES325R

W4

Tie Rod Ends

Axle Lbs. Rating	Code	Year	Length (Inches)	Notes	Tie Rod End Part No.	
					Drivers Side	Passenger Side
		1987-1994	4.13"		ES3336L	ES3335R

W7500

King Bolt Sets

Axle Lbs. Rating	Code	Year	Diameter (inches)	Length (Inches)	Pin Type	Bushing	Notes	King Pin Set No.
7,000	(F070)	1979-1980	1.249"	7.890"	1	Metal		8491B
	(F070)	1979-1980	1.259"	7.890"	1	Metal		8491B010
	(F070)	1979-1980	1.249"	7.890"	1	Nylon		8491N
9,000	(F090)	1979-1980	1.186/1.434"	8.750"	7	Metal		8462B
	(F090)	1970-1974	1.186/1.434"	8.750"	7	Metal		8462B
	(F090)	1979-1980	1.186/1.434"	8.750"	7	Nylon		8462N
	(F090)	1970-1974	1.186/1.434"	8.750"	7	Nylon		8462N
12,000	(F120)	1970-1974	1.309/1.607"	9.750"	7	Metal		8386B

W7500 (Cont'd)

King Bolt Sets (Cont'd)

Axle Lbs. Rating	Code	Year	Diameter (inches)	Length (Inches)	Pin Type	Bushing	Notes	King Pin Set No.
12,000	(F120)	1970-1974	1.309/1.607"	9.750"	7	Nylon		8386N
16,000	(FL901)	1971-1974	1.999"	11.040"	2	Metal		8518B
	(FL901)	1971-1974	1.999"	11.040"	2	Nylon		8518N

Tie Rod Ends

Axle Lbs. Rating	Code	Year	Length (Inches)	Notes	Tie Rod End Part No.	
					Drivers Side	Passenger Side
7,000	(F070)	1979-1980	4.93"		ES2061L	ES2062R
9,000	(F090)	1970-1971	3.75"		ES176L	ES176R
	(F090)	1979-1980	4.88"		ES405L	ES405R
	(F090)	1972-1974	4.88"		ES405L	ES405R
	(F120D)	1979-1980	4.88"		ES405L	ES405R
12,000	(F120)	1979-1980	4.88"		ES405L	ES405R
	(F120)	1973-1974	4.88"		ES405L	ES405R
	(F120)	1970-1970	4.88"		ES405L	ES405R
	(F120)	1971-1972	5.50"	Internal Threads	ES325L	ES325R
16,000	(FL901)	1971-1974	5.75"		ES431L	ES431R

Drag Links

Axle Lbs. Rating	Code	Year	Length (inches)	Notes	Drag Link No.
7,000	(F070)	1979-1980	32.22"		DS983

W8500

King Bolt Sets

Axle Lbs. Rating	Code	Year	Diameter (inches)	Length (Inches)	Pin Type	Bushing	Notes	King Pin Set No.
9,000	(F090)	1963-1978	1.186/1.434"	8.750"	7	Metal		8462B
	(F090)	1963-1978	1.186/1.434"	8.750"	7	Nylon		8462N
11,000	(F110)	1963-1969	1.309/1.607"	9.750"	7	Metal		8386B
	(F110)	1963-1969	1.309/1.607"	9.750"	7	Nylon		8386N
12,000	(F120)	1973-1978	1.309/1.607"	9.750"	7	Metal		8386B
	(F120)	1973-1978	1.309/1.607"	9.750"	7	Nylon		8386N
15,000	(F150)	1963-1969	1.400/1.794"	10.688"	7	Metal		8474B

Tie Rod Ends

Axle Lbs. Rating	Code	Year	Length (Inches)	Notes	Tie Rod End Part No.	
					Drivers Side	Passenger Side
9,000	(F090)	1963-1969	3.75"		ES176L	ES176R
	(F090)	1973-1978	4.88"		ES405L	ES405R
11,000	(F110)	1963-1969	5.50"	Internal Threads	ES325L	ES325R
12,000	(F120)	1973-1978	4.88"		ES405L	ES405R
15,000	(F150)	1963-1969	5.50"	Internal Threads	ES325L	ES325R

W9500

King Bolt Sets

Axle Lbs. Rating	Code	Year	Diameter (inches)	Length (Inches)	Pin Type	Bushing	Notes	King Pin Set No.
9,000	(F090)	1963-1972	1.186/1.434"	8.750"	7	Metal		8462B
	(F090)	1963-1972	1.186/1.434"	8.750"	7	Nylon		8462N
11,000	(F110)	1966-1972	1.309/1.607"	9.750"	7	Metal		8386B
	(F110)	1966-1972	1.309/1.607"	9.750"	7	Nylon		8386N
12,000	(F120)	1970-1978	1.309/1.607"	9.750"	7	Metal		8386B
	(F120)	1970-1978	1.309/1.607"	9.750"	7	Nylon		8386N
15,000	(F150)	1963-1972	1.400/1.794"	10.688"	7	Metal		8474B

Tie Rod Ends

Axle Lbs. Rating	Code	Year	Length (Inches)	Notes	Tie Rod End Part No.	
					Drivers Side	Passenger Side
9,000	(F090)	1963-1969	3.75"		ES176L	ES176R
	(F090)	1970-1972	4.88"		ES405L	ES405R
11,000	(F110)	1963-1972	5.50"	Internal Threads	ES325L	ES325R
12,000	(F120)	1970-1978	4.88"		ES405L	ES405R

W9500 (Cont'd)

Tie Rod Ends (Cont'd)

Axle Lbs. Rating	Code	Year	Length (Inches)	Notes	Tie Rod End Part No.	
					Drivers Side	Passenger Side
12,000	(F120)	1963-1969	5.50"	Internal Threads	ES325L	ES325R
15,000	(F150)	1963-1972	5.50"	Internal Threads	ES325L	ES325R

HENDRICKSON TRUCK MODEL FINDING INDEX

Model	Model	Model	Model
AIRTEK 4.25" Beam Drop	AIRTEK 5.36" Beam Drop	SOFTEK 5.36" BEAM DROP	STEERTEK 4.25" Beam Drop

AIRTEK 4.25" Beam Drop

Tie Rod Ends

Axle Lbs. Rating	Code	Year	Length (Inches)	Notes	Tie Rod End Part No.	
					Drivers Side	Passenger Side
12,000			6.00"		ES3477	ES3476
12,500			6.00"		ES3477	ES3476
13,200			6.00"	Sliding seal version	ES3477	ES3476
			7.38"		ES3443L	ES34442R
14,600			6.00"	Sliding seal version	ES3477	ES3476
			7.38"		ES3443L	ES34442R

AIRTEK 5.36" Beam Drop

Tie Rod Ends

Axle Lbs. Rating	Code	Year	Length (Inches)	Notes	Tie Rod End Part No.	
					Drivers Side	Passenger Side
12,000			10.32"		ES800421	ES800420
			8.12"		ES3298L	ES3297R
12,500			10.32"		ES800421	ES800420

Airtek for Bluebird

King Bolt Sets

Axle Lbs. Rating	Code	Year	Diameter (inches)	Length (Inches)	Pin Type	Bushing	Notes	King Pin Set No.
12,000			1.998"	9.533"	9	Composite	Bluebird Bus. Steering Knuckle Service Kit	8008C (Service Kit Only)

Airtek for Volvo

King Bolt Sets

Axle Lbs. Rating	Code	Year	Diameter (inches)	Length (Inches)	Pin Type	Bushing	Notes	King Pin Set No.
12,000			1.998"	9.533"	9	Composite	Volvo. Steering Knuckle Service Kit - Does	8008C (Service Kit Only)
12,500			1.998"	9.533"	9	Composite	Volvo. Steering Knuckle Service Kit - Does	8008C (Service Kit Only)
13,200			1.998"	9.533"	9	Composite	Volvo. Steering Knuckle Service Kit - Does	8008C (Service Kit Only)
14,600			1.998"	9.533"	9	Composite	Volvo. Steering Knuckle Service Kit - Does	8008C (Service Kit Only)

SOFTEK 5.36" BEAM DROP

Tie Rod Ends

Axle Lbs. Rating	Code	Year	Length (Inches)	Notes	Tie Rod End Part No.	
					Drivers Side	Passenger Side
9,000			6.00"		ES3477	ES3476
10,000			6.00"		ES3477	ES3476

Softek for Bluebird

King Bolt Sets

Axle Lbs. Rating	Code	Year	Diameter (inches)	Length (Inches)	Pin Type	Bushing	Notes	King Pin Set No.
12,000			1.998"	9.533"	9	Composite	Bluebird Bus. Steering Knuckle Service Kit	8008C (Service Kit Only)

STEERTEK 4.25" Beam Drop

Tie Rod Ends

Axle Lbs. Rating	Code	Year	Length (Inches)	Notes	Tie Rod End Part No.	
					Drivers Side	Passenger Side
12,000			6.00"		ES3477	ES3476

HINO TRUCK MODEL FINDING INDEX

Model	Model	Model	Model
238,268,268A,338			

238,268,268A,338

Tie Rod Ends

Axle Lbs. Rating	Code	Year	Length (Inches)	Notes	Tie Rod End Part No.	
					Drivers Side	Passenger Side
		2005-2007	5.44"		ES423L	ES423R

ISUZU TRUCK MODEL FINDING INDEX

Model		Model		Model		Model	
FSR		FTR		FVR		FXR	
HTR		HVR		NPR			

FSR

King Bolt Sets

Axle Lbs. Rating	Code	Year	Diameter (inches)	Length (Inches)	Pin Type	Bushing	Notes	King Pin Set No.
11,000		1996-2002	1.614"	8.035"	8	Metal	From 03/96	8659B
		1996-2002	1.892"	9.203"	8	Metal		8660B
12,000		1996-2002	1.892"	9.604"	8	Metal		8661B

Tie Rod Ends

Axle Lbs. Rating	Code	Year	Length (Inches)	Notes	Tie Rod End Part No.	
					Drivers Side	Passenger Side
8,000		1996-2002	5.44"		ES3270L	ES3271R
11,000		1996-2002	5.44"		ES3274L	ES3275R
12,000		1996-2002	5.44"		ES3274L	ES3275R
		1996-2002	5.44"		ES3270L	ES3271R
14,600		1996-2002	5.44"		ES3274L	ES3275R
		1996-2002	5.44"		ES3270L	ES3271R

FTR

King Bolt Sets

Axle Lbs. Rating	Code	Year	Diameter (inches)	Length (Inches)	Pin Type	Bushing	Notes	King Pin Set No.
11,000		1996-2002	1.892"	9.203"	8	Metal	From 03/96	8660B
12,000		1996-2002	1.892"	9.604"	8	Metal		8661B

Tie Rod Ends

Axle Lbs. Rating	Code	Year	Length (Inches)	Notes	Tie Rod End Part No.	
					Drivers Side	Passenger Side
8,000		1996-2002	5.44"		ES3270L	ES3271R
11,000		1996-2002	5.44"		ES3274L	ES3275R
12,000		1996-2002	5.44"		ES3274L	ES3275R
		1996-2002	5.44"		ES3270L	ES3271R
14,600		1996-2002	5.44"		ES3274L	ES3275R
		1996-2002	5.44"		ES3270L	ES3271R
		2004-2007	7.37"		(Wheelbase 128"-194")	ES2090L
16,000		2004-2007	7.37"	(Wheelbase 128"-194")	ES2090L	ES2091R

FVR

King Bolt Sets

Axle Lbs. Rating	Code	Year	Diameter (inches)	Length (Inches)	Pin Type	Bushing	Notes	King Pin Set No.
11,000		1996-2002	1.892"	9.203"	8	Metal	From 03/96	8660B
12,000		1996-2002	1.892"	9.604"	8	Metal		8661B

Tie Rod Ends

Axle Lbs. Rating	Code	Year	Length (Inches)	Notes	Tie Rod End Part No.	
					Drivers Side	Passenger Side
8,000		1996-2002	5.44"		ES3270L	ES3271R
11,000		1996-2002	5.44"		ES3274L	ES3275R
12,000		1996-2002	5.44"		ES3274L	ES3275R
		1996-2002	5.44"		ES3270L	ES3271R
14,600		1996-2002	5.44"		ES3274L	ES3275R
		1996-2002	5.44"		ES3270L	ES3271R
		2004-2007	7.37"			ES2090L
16,000		2004-2007	7.37"		ES2090L	ES2091R

FXR

Tie Rod Ends

Axle Lbs. Rating	Code	Year	Length (Inches)	Notes	Tie Rod End Part No.	
					Drivers Side	Passenger Side
14,600		2007	7.37"		ES2090L	ES2091R
16,000		2007	7.37"		ES2090L	ES2091R

HTR

Tie Rod Ends

Axle Lbs. Rating	Code	Year	Length (Inches)	Notes	Tie Rod End Part No.	
					Drivers Side	Passenger Side
14,600		2005-2007	7.37"		ES2090L	ES2091R
16,000		2005-2007	7.37"		ES2090L	ES2091R

HVR

Tie Rod Ends

Axle Lbs. Rating	Code	Year	Length (Inches)	Notes	Tie Rod End Part No.	
					Drivers Side	Passenger Side
14,600		2005-2007	7.37"		ES2090L	ES2091R
16,000		2005-2007	7.37"		ES2090L	ES2091R

NPR

Tie Rod Ends

Axle Lbs. Rating	Code	Year	Length (Inches)	Notes	Tie Rod End Part No.	
					Drivers Side	Passenger Side
		1987-1993	4.13"	Except 7-8 ton; Same as GMC W4 Forward Control Truck	ES3336L	ES3335R
14,600		2007	7.37"	Wheelbase 128"-194"	ES2090L	ES2091R

KENWORTH TRUCK MODEL FINDING INDEX

Model	Model	Model	Model
C500 B Conventional Cab	C500 Conventional	C500B Conventional Cab	K100 (Set forward axle)
K100 Cab-Over-Engine	K100E (Set Back Axle)	K100E Cab-Over-Engine	K300 Cab-Over-engine
L700 Cab Forward	T2000	T400A Conventional Cab	T400B Conventional Cab
T450A Conventional Cab	T450B Conventional Cab	T600A Conventional Cab	T600B Conventional Cab
T800 Conventional Cab	T800B Conventional Cab	T800B Conventional Cab	W900
W900B	W900L	W900S	



W900



K100



C500



L700

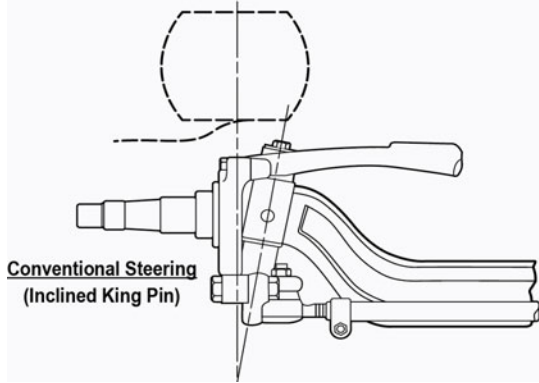

Conventional Steering
(Inclined King Pin)

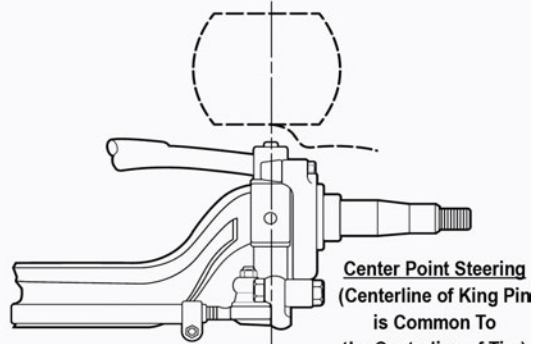

Center Point Steering
(Centerline of King Pin
is Common To
the Centerline of Tire)

C500 B Conventional Cab

King Bolt Sets

Axle Lbs. Rating	Code	Year	Diameter (inches)	Length (Inches)	Pin Type	Bushing	Notes	King Pin Set No.
22,000	(FL951)		2.000"	11.210"	2	Composite		8571C
	(FL951)		1.999"	11.212"	2	Metal		8571B

C500 Conventional

King Bolt Sets

Axle Lbs. Rating	Code	Year	Diameter (inches)	Length (Inches)	Pin Type	Bushing	Notes	King Pin Set No.
11,000	(FE900)		1.309/1.607"	9.750"	7	Metal		8386B
	(FE900)		1.309/1.607"	9.750"	7	Nylon		8386N
12,000	(FE970)		1.607"	8.812"	2	Metal		8514B
	(FE970)		1.607"	8.812"	2	Nylon		8514N
	(FF901)		1.794"	9.120"	2	Metal		8489B
	(FF901)		1.794"	9.120"	2	Nylon		8489N
	(FF921)		1.794"	10.392"	2	Metal		8553B
	(FF931)		1.794"	10.392"	2	Metal		8590B

C500 Conventional (Cont'd)

King Bolt Sets (Cont'd)

Axle Lbs. Rating	Code	Year	Diameter (inches)	Length (Inches)	Pin Type	Bushing	Notes	King Pin Set No.
12,000	(FF971)		1.607"	9.380"	2	Metal	(Center Point Steering)	8612B
16,000	(FH901)		1.999"	11.040"	2	Metal		8518B
	(FH901)		1.999"	11.040"	2	Nylon		8518N
	(FL931)		1.999"	11.212"	2	Metal		8571B
18,000	(FL901)		1.999"	11.040"	2	Metal		8518B
	(FL901)		1.999"	11.040"	2	Nylon		8518N
	(FL931)		1.999"	11.212"	2	Metal		8571B
20,000	(FL931)		1.999"	11.212"	2	Metal		8571B
22,000	(FL951)		2.000"	11.210"	2	Composite		8571C
	(FL951)		1.999"	11.212"	2	Metal		8571B
	(FL951)		1.999"	11.212"	2	Metal		8571B

Tie Rod Ends

Axle Lbs. Rating	Code	Year	Length (Inches)	Notes	Tie Rod End Part No.	
					Drivers Side	Passenger Side
11,000	(FE900)		4.88"		ES187L	ES187R
	(FE900)		5.75"		ES431L	ES431R
12,000	(FE970)		10.50"	Will Retrofit Older Axles	ES2200L	ES2201R
	(FE970)		4.88"		ES187L	ES187R
	(FE970)		5.75"	ES431L	ES431R	
	(FF901)		4.88"	ES187L	ES187R	
	(FF901)		5.75"	ES431L	ES431R	
	(FF901)		5.75"	Anti-Tilt Seal Type	ES346L	ES346R
	(FF921)		5.44"		ES423L	ES423R
	(FF921)		5.44"	1-1/8"-18 Optional Thread		ES3312R
	(FF931)		5.44"		ES423L	ES423R
	(FF931)		5.44"	1-1/8"-18 Optional Thread		ES3312R
16,000	(FH901)		5.75"		ES431L	ES431R
	(FL931)		12.69"		ES3031L	ES3030R
	(FL931)		5.75"		ES431L	ES431R
	(FL931)		7.37"		ES2090L	ES2091R
18,000	(FL901)		5.75"		ES431L	ES431R
	(FL931)		12.69"		ES3031L	ES3030R
	(FL931)		5.75"		ES431L	ES431R
	(FL931)		7.37"		ES2090L	ES2209R
	(FL931)		7.37"		ES2210L	ES2209R
20,000	(FL931)		12.69"		ES3031L	ES3030R
	(FL931)		5.75"		ES431L	ES431R
	(FL931)		7.37"		ES2090L	ES2091R

Drag Links

Axle Lbs. Rating	Code	Year	Length (inches)	Notes	Drag Link No.
All				Drag Link Ends, Used on DS995 & DS996	ES2209R ES2204R ES2091R
12,000	(All)		26.75"		DS996
			27.31"		DS995
16,000	(All)		26.75"		DS996
			27.31"		DS995
18,000	(All)		26.75"		DS996
			27.31"		DS995

C500B Conventional Cab

King Bolt Sets

Axle Lbs. Rating	Code	Year	Diameter (inches)	Length (Inches)	Pin Type	Bushing	Notes	King Pin Set No.
12,000	(FF941)		1.794"	10.392"	2	Metal		8590B
	(FF943)		1.794"	10.392"	2	Metal		8590B
	(FF961)		1.790"	10.390"	2	Composite		80063C
	E-12001		1.794"	9.060"	1	Metal		80076B
	EFA-12F4		1.630"	9.200"	1	Composite		8618C
	EFA-12F4		1.625"	9.200"	1	Metal		8647B
	EFA-13F5		1.630"	9.200"	1	Composite		8618C
	EFA-13F5		1.625"	9.200"	1	Metal		8647B
	13,000	EFA-12F4		1.630"	9.200"	1	Composite	

C500B Conventional Cab (Cont'd)

Heavy Duty Trucks

King Bolt Sets (Cont'd)

Axle Lbs. Rating	Code	Year	Diameter (inches)	Length (Inches)	Pin Type	Bushing	Notes	King Pin Set No.
13,000	EFA-12F4		1.625"	9.200"	1	Metal		8647B
	EFA-13F5		1.630"	9.200"	1	Composite		8618C
	EFA-13F5		1.625"	9.200"	1	Metal		8647B
16,000	(FL941)		1.999"	11.212"	2			8571B
	(FL943)		1.999"	11.212"	2	Metal		8571B
18,000	(FL941)		1.999"	11.212"	2	Metal		8571B
	(FL943)		1.999"	11.212"	2	Metal		8571B
20,000	(FL941)		1.999"	11.212"	2	Metal		8571B
	(FL943)		1.999"	11.212"	2	Metal		8571B

Tie Rod Ends

Axle Lbs. Rating	Code	Year	Length (Inches)	Notes	Tie Rod End Part No.	
					Drivers Side	Passenger Side
12,000	(FF941)		5.44"		ES423L	ES423R
	(FF941)		5.44"	1-1/8"-18 Optional Thread		
	(FF943)		5.44"	1-1/8"-18 Optional Thread		
	(FF943)		5.44"		ES423L	ES423R
	(FF961)		5.44"	1-1/8"-18 Optional Thread		
	(FF961)		5.44"			
	E-12001		6.00"		ES423L	ES423R
	EFA-12F3		5.44"		ES3477	ES3476
	EFA-12F3		8.12"		ES423L	ES423R
	EFA-12F4		5.44"		ES3298L	ES3297R
	EFA-12F4		8.12"		ES423L	ES423R
	EFA-13F3		5.44"		ES3298L	ES3297R
	EFA-13F3		8.12"		ES423L	ES423R
	EFA-13F5		5.44"		ES3298L	ES3297R
	EFA-13F5		8.12"		ES423L	ES423R
13,000	EFA-12F3		5.44"		ES423L	ES423R
	EFA-12F3		8.12"		ES3298L	ES3297R
	EFA-12F4		5.44"		ES423L	ES423R
	EFA-12F4		8.12"		ES3298L	ES3297R
	EFA-13F3		5.44"		ES423L	ES423R
	EFA-13F3		8.12"		ES3298L	ES3297R
	EFA-13F5		5.44"		ES423L	ES423R
EFA-13F5		8.12"		ES3298L	ES3297R	
14,600	(FG941)		5.44"		ES423L	ES423R
	(FG941)		5.44"	1-1/8"-18 Optional Thread		
16,000	(FL941)		12.69"		ES3031L	ES3030R
	(FL941)		5.75"		ES431L	ES431R
	(FL941)		7.37"		ES2090L	ES2091R
	(FL943)		12.69"		ES3031L	ES3030R
	(FL943)		5.75"		ES431L	ES431R
	(FL943)		7.37"		ES2090L	ES2091R
18,000	(FL941)		12.69"		ES3031L	ES3030R
	(FL941)		5.75"		ES431L	ES431R
	(FL941)		7.37"		ES2090L	ES2091R
	(FL943)		12.69"		ES3031L	ES3030R
	(FL943)		5.75"		ES431L	ES431R
	(FL943)		7.37"		ES2090L	ES2091R
20,000	(FL941)		12.69"		ES3031L	ES3030R
	(FL941)		5.75"		ES431L	ES431R
	(FL941)		7.37"		ES2090L	ES2091R
	(FL943)		12.69"		ES3031L	ES3030R
	(FL943)		5.75"		ES431L	ES431R
	(FL943)		7.37"		ES2090L	ES2091R

K100 (set forward axle), K100E(Set Back Axle), Cab-Over-Engine From 1986

King Bolt Sets

Axle Lbs. Rating	Code	Year	Diameter (inches)	Length (Inches)	Pin Type	Bushing	Notes	King Pin Set No.
12,000	(FF941)		1.794"	10.392"	2	Metal		8590B
	(FF943)		1.794"	10.392"	2	Metal		8590B
	(FF961)		1.790"	10.390"	2	Composite		80063C
	E-12001		1.794"	9.060"	1	Metal		80076B
	EFA-12F4		1.630"	9.200"	1	Composite		8618C

K100 (set forward axle), K100E(Set Back Axle), Cab-Over-Engine From 1986 (Cont'd)

King Bolt Sets (Cont'd)

Axle Lbs. Rating	Code	Year	Diameter (inches)	Length (Inches)	Pin Type	Bushing	Notes	King Pin Set No.
12,000	EFA-12F4		1.625"	9.200"	1	Metal		8647B
13,000	EFA-13F5		1.630"	9.200"	1	Composite		8618C
	EFA-13F5		1.625"	9.200"	1	Metal		8647B
14,600	(FG941)		1.790"	10.390"	2	Metal		8611B
16,000	(FL941)		1.999"	11.212"	2	Metal		8571B
	(FL943)		1.999"	11.212"	2	Metal		8571B
18,000	(FL941)		1.999"	11.212"	2	Metal		8571B
	(FL943)		1.999"	11.212"	2	Metal		8571B
20,000	(FL941)		1.999"	11.212"	2	Metal		8571B
	(FL943)		1.999"	11.212"	2	Metal		8571B

Tie Rod Ends

Axle Lbs. Rating	Code	Year	Length (Inches)	Notes	Tie Rod End Part No.	
					Drivers Side	Passenger Side
12,000	(FF941)		5.44"	1-1/8"-18 Optional Thread	ES423L	ES423R
	(FF941)		5.44"			ES3312R
	(FF942)		5.44"		ES423L	ES3312R
	(FF942)		5.44"			ES423R
	(FF943)		5.44"		ES423L	ES3312R
	(FF943)		5.44"			ES423R
	(FF944)		5.44"		ES423L	ES3312R
	(FF944)		5.44"			ES423R
	(FF961)		5.44"		ES423L	ES423R
	(FF961)		5.44"			ES3312R
	E-1200I		6.00"		ES3477	ES3476
	EFA-12F3		5.44"		ES423L	ES423R
	EFA-12F4		8.12"		ES3298L	ES3297R
	13,000	EFA-13F3			5.44"	ES423L
EFA-13F5			8.12"	ES3298L	ES3297R	
14,600	(FG941)		5.44"	1-1/8"-18 Optional Thread	ES423L	ES423R
	(FG941)		5.44"			ES3312R
	(FG943)		5.44"		ES423L	ES3312R
	(FG943)		5.44"			ES423R
16,000	(FL941)		12.69"		ES3031L	ES3030R
	(FL941)		5.75"		ES431L	ES431R
	(FL941)		7.37"		ES2090L	ES2091R
	(FL943)		12.69"		ES3031L	ES3030R
	(FL943)		5.75"		ES431L	ES431R
	(FL943)		7.37"		ES2090L	ES2091R
18,000	(FL941)		12.69"		ES3031L	ES3030R
	(FL941)		5.75"		ES431L	ES431R
	(FL941)		7.37"		ES2090L	ES2091R
	(FL943)		12.69"		ES3031L	ES3030R
	(FL943)		5.75"		ES431L	ES431R
	(FL943)		7.37"		ES2090L	ES2091R
20,000	(FL941)		12.69"		ES3031L	ES3030R
	(FL941)		5.75"		ES431L	ES431R
	(FL941)		7.37"		ES2090L	ES2091R
	(FL943)		12.69"		ES3031L	ES3030R
	(FL943)		5.75"		ES431L	ES431R
	(FL943)		7.37"		ES2090L	ES2091R

K100 Cab-Over-Engine (To 1986)

King Bolt Sets

Axle Lbs. Rating	Code	Year	Diameter (inches)	Length (Inches)	Pin Type	Bushing	Notes	King Pin Set No.
11,000	(FE900)		1.309/1.607"	9.750"	7	Metal		8386B
	(FE900)		1.309/1.607"	9.750"	7	Nylon		8386N
12,000	(FE970)		1.607"	8.812"	2	Metal		8514B
	(FE970)		1.607"	8.812"	2	Nylon		8514N
	(FF901)		1.794"	9.120"	2	Metal		8489B
	(FF901)		1.794"	9.120"	2	Nylon		8489N
	(FF921)		1.794"	10.392"	2	Metal		8553B
	(FF931)		1.794"	10.392"	2	Metal		8590B
	(FF971)		1.607"	9.380"	2	Metal	(Center Point Steering)	8612B
16,000	(FH901)		1.999"	11.040"	2	Metal		8518B

K100 Cab-Over-Engine (To 1986) (Cont'd)

Heavy Duty Trucks

King Bolt Sets (Cont'd)

Axle Lbs. Rating	Code	Year	Diameter (inches)	Length (Inches)	Pin Type	Bushing	Notes	King Pin Set No.
16,000	(FH901)		1.999"	11.040"	2	Nylon		8518N
	(FL931)		1.999"	11.212"	2	Metal		8571B
18,000	(FL901)		1.999"	11.040"	2	Metal		8518B
	(FL901)		1.999"	11.040"	2	Nylon		8518N
	(FL931)		1.999"	11.212"	2	Metal		8571B
	(FL931)		1.999"	11.212"	2	Metal		8571B

Tie Rod Ends

Axle Lbs. Rating	Code	Year	Length (Inches)	Notes	Tie Rod End Part No.	
					Drivers Side	Passenger Side
11,000	(FE900)		4.88"		ES187L	ES187R
	(FE900)		5.75"		ES431L	ES431R
12,000	(FE970)		10.50"	Will Retrofit Older Axles	ES2200L	ES2201R
	(FE970)		4.88"		ES187L	ES187R
	(FE970)		5.75"	ES431L	ES431R	
	(FF901)		4.88"	ES187L	ES187R	
	(FF901)		5.75"	ES431L	ES431R	
	(FF901)		5.75"	Anti-Tilt Seal Type	ES346L	ES346R
	(FF921)		5.44"		ES423L	ES423R
	(FF921)		5.44"	1-1/8"-18 Optional Thread		ES3312R
	(FF931)		5.44"		ES423L	ES423R
	(FF931)		5.44"	1-1/8"-18 Optional Thread		ES3312R
16,000	(FH901)		5.75"		ES431L	ES431R
	(FL931)		12.69"		ES3031L	ES3030R
	(FL931)		5.75"		ES431L	ES431R
	(FL931)		7.37"		ES2090L	ES2091R
	(FL931)		7.37"			
18,000	(FL901)		5.75"		ES431L	ES431R
	(FL931)		12.69"		ES3031L	ES3030R
	(FL931)		5.75"		ES431L	ES431R
	(FL931)		7.37"		ES2090L	ES2209R
	(FL931)		7.37"		ES2210L	ES2209R
20,000	(FL931)		12.69"		ES3031L	ES3030R
	(FL931)		5.75"		ES431L	ES431R
	(FL931)		7.37"		ES2090L	ES2091R

Drag Links

Axle Lbs. Rating	Code	Year	Length (inches)	Notes	Drag Link No.
All				Drag Link Ends, Used on DS995 & DS996 Drag Link End, Used on DS997 & DS998, Has RH Thread	ES2209R ES2204R ES2091R ES2090L
12,000	(All)		20.85"		DS998
			21.50"		DS997
16,000	(All)		20.85"		DS998
			21.50"		DS997
18,000	(All)		20.85"		DS998
			21.50"		DS997

K300 Cab-Over-engine

King Bolt Sets

Axle Lbs. Rating	Code	Year	Diameter (inches)	Length (Inches)	Pin Type	Bushing	Notes	King Pin Set No.
12,000	E-12001		1.794"	9.060"	1	Metal		80076B
	EFA-12F4		1.630"	9.200"	1	Composite		8618C
	EFA-12F4		1.625"	9.200"	1	Metal		8647B
13,000	EFA-13F5		1.630"	9.200"	1	Composite		8618C
	EFA-13F5		1.625"	9.200"	1	Metal		8647B

Tie Rod Ends

Axle Lbs. Rating	Code	Year	Length (Inches)	Notes	Tie Rod End Part No.	
					Drivers Side	Passenger Side
12,000	E-12001		6.00"		ES3477	ES3476
	EFA-12F3		5.44"		ES423L	ES423R
	EFA-12F3		8.12"		ES3298L	ES3297R

K300 Cab-Over-engine (Cont'd)

Tie Rod Ends (Cont'd)

Axle Lbs. Rating	Code	Year	Length (Inches)	Notes	Tie Rod End Part No.	
					Drivers Side	Passenger Side
12,000	EFA-12F4		5.44"		ES423L	ES423R
	EFA-12F4		8.12"		ES3298L	ES3297R
13,000	EFA-13F3		5.44"		ES423L	ES423R
	EFA-13F3		8.12"		ES3298L	ES3297R
	EFA-13F5		5.44"		ES423L	ES423R
	EFA-13F5		8.12"		ES3298L	ES3297R

L700 Cab Forward

King Bolt Sets

Axle Lbs. Rating	Code	Year	Diameter (inches)	Length (Inches)	Pin Type	Bushing	Notes	King Pin Set No.
11,000	(FE900)		1.309/1.607"	9.750"	7	Metal		8386B
	(FE900)		1.309/1.607"	9.750"	7	Nylon		8386N
12,000	(FE970)		1.607"	8.812"	2	Metal		8514B
	(FE970)		1.607"	8.812"	2	Nylon		8514N
	(FF901)		1.794"	9.120"	2	Metal		8489B
	(FF901)		1.794"	9.120"	2	Nylon		8489N
	(FF921)		1.794"	10.392"	2	Metal		8553B
	(FF931)		1.794"	10.392"	2	Metal		8590B
	(FF941)		1.999"	11.040"	2	Metal		8518B
	(FF941)		1.999"	11.040"	2	Nylon		8518N
	(FF971)		1.607"	9.380"	2	Metal	(Center Point Steering)	8612B
16,000	(FH901)		1.999"	11.040"	2	Metal		8518B
	(FH901)		1.999"	11.040"	2	Nylon		8518N
	(FL931)		1.999"	11.212"	2	Metal		8571B
18,000	(FL901)		1.999"	11.040"	2	Metal		8518B
	(FL901)		1.999"	11.040"	2	Nylon		8518N
	(FL931)		1.999"	11.212"	2	Metal		8571B
20,000	(FL931)		1.999"	11.212"	2	Metal		8571B

Tie Rod Ends

Axle Lbs. Rating	Code	Year	Length (Inches)	Notes	Tie Rod End Part No.	
					Drivers Side	Passenger Side
11,000	(FE900)		4.88"		ES187L	ES187R
	(FE900)		5.75"		ES431L	ES431R
12,000	(FE900)		5.50"	Will Retrofit Older Axles	ES325L	ES325R
	(FE970)		10.50"		ES2200L	ES2201R
	(FE970)		4.88"		ES187L	ES187R
	(FE970)		5.75"		ES431L	ES431R
	(FF901)		4.88"		ES187L	ES187R
	(FF901)		5.75"		ES431L	ES431R
	(FF901)		5.75"	Anti-Tilt Seal Type	ES346L	ES346R
	(FF921)		5.44"		ES423L	ES423R
	(FF921)		5.44"	1-1/8"-18 Optional Thread		ES3312R
	(FF931)		5.44"	1-1/8"-18 Optional Thread		ES3312R
	(FF931)		5.44"		ES423L	ES423R
(FF971)		10.50"	(Center Point Steering)	ES2200L	ES2201R	
16,000	(FH901)		5.75"		ES431L	ES431R
	(FL931)		12.69"		ES3031L	ES3030R
	(FL931)		5.75"		ES431L	ES431R
	(FL931)		7.37"		ES2090L	ES2091R
18,000	(FL901)		5.75"		ES431L	ES431R
	(FL931)		12.69"		ES3031L	ES3030R
	(FL931)		5.75"		ES431L	ES431R
	(FL931)		7.37"		ES2090L	ES2091R
20,000	(FL931)		12.69"		ES3031L	ES3030R
	(FL931)		5.75"		ES431L	ES431R
	(FL931)		7.37"		ES2090L	ES2091R

T2000

King Bolt Sets

Axle Lbs. Rating	Code	Year	Diameter (inches)	Length (Inches)	Pin Type	Bushing	Notes	King Pin Set No.
12,000	E-12001		1.794"	9.060"	1	Metal		80076B

T2000 (Cont'd)

Tie Rod Ends

Axle Lbs. Rating	Code	Year	Length (Inches)	Notes	Tie Rod End Part No.	
					Drivers Side	Passenger Side
12,000	E-12001		6.00"		ES3477	ES3476

T400A, T400B Conventional Cab

King Bolt Sets

Axle Lbs. Rating	Code	Year	Diameter (inches)	Length (Inches)	Pin Type	Bushing	Notes	King Pin Set No.
10,000	(FD961)		1.790"	10.390"	2	Composite		80063C
12,000	(FF941)		1.794"	10.392"	2	Metal		8590B
	(FF961)		1.790"	10.390"	2	Composite		80063C
	E-12001		1.794"	9.060"	1	Metal		80076B
	EFA-12F4		1.630"	9.200"	1	Composite		8618C
	EFA-12F4		1.625"	9.200"	1	Metal		8647B
13,000	EFA-13F5		1.630"	9.200"	1	Composite		8618C
	EFA-13F5		1.625"	9.200"	1	Metal		8647B
14,600	(FG941)		1.790"	10.390"	2	Metal		8611B

Tie Rod Ends

Axle Lbs. Rating	Code	Year	Length (Inches)	Notes	Tie Rod End Part No.	
					Drivers Side	Passenger Side
10,000	(FD961)		5.44"	1-1/8"-18 Optional Thread		ES3312R
	(FD961)		5.44"		ES423L	ES423R
12,000	(FF941)		5.44"	1-1/8"-18 Optional Thread	ES423L	ES423R
	(FF961)		5.44"			ES3312R
	(FF961)		5.44"	1-1/8"-18 Optional Thread	ES423L	ES423R
	(FF961)		5.44"			ES3312R
	E-12001		6.00"		ES3477	ES3476
	EFA-12F3		5.44"		ES423L	ES423R
	EFA-12F3		8.12"		ES3298L	ES3297R
	EFA-12F4		5.44"		ES423L	ES423R
EFA-12F4		8.12"		ES3298L	ES3297R	
13,000	EFA-13F3		5.44"		ES423L	ES423R
	EFA-13F3		8.12"		ES3298L	ES3297R
	EFA-13F5		5.44"		ES423L	ES423R
	EFA-13F5		8.12"		ES3298L	ES3297R
14,600	(FG941)		5.44"	1-1/8"-18 Optional Thread		ES3312R
	(FG941)		5.44"		ES423L	ES423R

T450A, T450B Conventional Cab

King Bolt Sets

Axle Lbs. Rating	Code	Year	Diameter (inches)	Length (Inches)	Pin Type	Bushing	Notes	King Pin Set No.
10,000	(FD961)		1.790"	10.390"	2	Composite		80063C
12,000	(FF941)		1.794"	10.392"	2	Metal		8590B
	(FF943)		1.794"	10.392"	2	Metal		8590B
	(FF961)		1.790"	10.390"	2	Composite		80063C
	E-12001		1.794"	9.060"	1	Metal		80076B
	EFA-12F4		1.630"	9.200"	1	Composite		8618C
EFA-12F4		1.625"	9.200"	1	Metal		8647B	
13,000	EFA-13F5		1.630"	9.200"	1	Composite		8618C
	EFA-13F5		1.625"	9.200"	1	Metal		8647B
14,600	(FG941)		1.790"	10.390"	2	Metal		8611B
	(FG943)		1.790"	10.390"	2	Metal		8611B
16,000	(FL941)		1.999"	11.212"	2	Metal		8571B
	(FL943)		1.999"	11.212"	2	Metal		8571B
18,000	(FL941)		1.999"	11.212"	2	Metal		8571B
	(FL943)		1.999"	11.212"	2	Metal		8571B
20,000	(FL941)		1.999"	11.212"	2	Metal		8571B
	(FL943)		1.999"	11.212"	2	Metal		8571B

Tie Rod Ends

Axle Lbs. Rating	Code	Year	Length (Inches)	Notes	Tie Rod End Part No.	
					Drivers Side	Passenger Side
10,000	(FD961)		5.44"	1-1/8"-18 Optional Thread		ES3312R
	(FD961)		5.44"		ES423L	ES423R

T450A, T450B Conventional Cab (Cont'd)

Tie Rod Ends (Cont'd)

Axle Lbs. Rating	Code	Year	Length (Inches)	Notes	Tie Rod End Part No.	
					Drivers Side	Passenger Side
12,000	(FF941)		5.44"	1-1/8"-18 Optional Thread	ES423L	ES3312R
	(FF941)		5.44"			ES423R
	(FF943)		5.44"	1-1/8"-18 Optional Thread	ES423L	ES3312R
	(FF943)		5.44"			ES423R
	(FF961)		5.44"	1-1/8"-18 Optional Thread	ES423L	ES3312R
	(FF961)		5.44"			ES423R
	E-12001		6.00"		ES3477	ES3476
	EFA-12F3		5.44"		ES423L	ES423R
	EFA-12F3		8.12"		ES3298L	ES3297R
	EFA-12F4		5.44"		ES423L	ES423R
	EFA-12F4		8.12"		ES3298L	ES3297R
	13,000	EFA-13F3		5.44"		ES423L
EFA-13F3			8.12"		ES3298L	ES3297R
EFA-13F5			5.44"		ES423L	ES423R
EFA-13F5			8.12"		ES3298L	ES3297R
14,600	(FG941)		5.44"	1-1/8"-18 Optional Thread	ES423L	ES3312R
	(FG941)		5.44"			ES423R
16,000	(FL941)		12.69"		ES3031L	ES3030R
	(FL941)		5.75"		ES431L	ES431R
	(FL941)		7.37"		ES2090L	ES2091R
	(FL943)		12.69"		ES3031L	ES3030R
	(FL943)		5.75"		ES431L	ES431R
	(FL943)		7.37"		ES2090L	ES2091R
18,000	(FL941)		12.69"		ES3031L	ES3030R
	(FL941)		5.75"		ES431L	ES431R
	(FL941)		7.37"		ES2090L	ES2091R
	(FL943)		12.69"		ES3031L	ES3030R
	(FL943)		5.75"		ES431L	ES431R
	(FL943)		7.37"		ES2090L	ES2091R
20,000	(FL941)		12.69"		ES3031L	ES3030R
	(FL941)		5.75"		ES431L	ES431R
	(FL941)		7.37"		ES2090L	ES2091R
	(FL943)		12.69"		ES3031L	ES3030R
	(FL943)		5.75"		ES431L	ES431R
	(FL943)		7.37"		ES2090L	ES2091R

T600A, T600B Conventional Cab

King Bolt Sets

Axle Lbs. Rating	Code	Year	Diameter (inches)	Length (Inches)	Pin Type	Bushing	Notes	King Pin Set No.
12,000	(FF941)		1.794"	10.392"	2	Metal		8590B
	(FF943)		1.794"	10.392"	2	Metal		8590B
	(FF961)		1.790"	10.390"	2	Composite		80063C
	E-12001		1.794"	9.060"	1	Metal		80076B
	EFA-12F4		1.630"	9.200"	1	Composite		8618C
	EFA-12F4		1.625"	9.200"	1	Metal		8647B
13,000	EFA-13F5		1.630"	9.200"	1	Composite		8618C
	EFA-13F5		1.625"	9.200"	1	Metal		8647B

Tie Rod Ends

Axle Lbs. Rating	Code	Year	Length (Inches)	Notes	Tie Rod End Part No.	
					Drivers Side	Passenger Side
12,000	(FF941)		5.44"	1-1/8"-18 Optional Thread	ES423L	ES3312R
	(FF941)		5.44"			ES423R
	(FF943)		5.44"	1-1/8"-18 Optional Thread	ES423L	ES423R
	(FF943)		5.44"			ES3312R
	(FF961)		5.44"	1-1/8"-18 Optional Thread	ES423L	ES423R
	(FF961)		5.44"			ES3312R
	E-12001		6.00"		ES3477	ES3476
	EFA-12F3		5.44"		ES423L	ES423R
	EFA-12F3		8.12"		ES3298L	ES3297R
	EFA-12F4		5.44"		ES423L	ES423R
	EFA-12F4		8.12"		ES3298L	ES3297R
	13,000	EFA-13F3		5.44"		ES423L
EFA-13F3			8.12"		ES3298L	ES3297R

T600A, T600B Conventional Cab (Cont'd)

Tie Rod Ends (Cont'd)

Axle Lbs. Rating	Code	Year	Length (Inches)	Notes	Tie Rod End Part No.	
					Drivers Side	Passenger Side
13,000	EFA-13F5		5.44"		ES423L	ES423R
	EFA-13F5		8.12"		ES3298L	ES3297R
14,600	(FG941)		5.44"	1-1/8"-18 Optional Thread	ES423L	ES3312R
	(FG941)		5.44"			ES423R

T800 Conventional Cab

King Bolt Sets

Axle Lbs. Rating	Code	Year	Diameter (inches)	Length (Inches)	Pin Type	Bushing	Notes	King Pin Set No.
18,000	(EFA-18F3)		1.870"	9.970"	1	Composite		8633C
	(EFA-18F3)		1.870"	9.970"	1	Metal		8633B

T800, T800B, Conventional Cab

King Bolt Sets

Axle Lbs. Rating	Code	Year	Diameter (inches)	Length (Inches)	Pin Type	Bushing	Notes	King Pin Set No.
12,000	(FF941)		1.794"	10.392"	2	Metal		8590B
	(FF943)		1.794"	10.392"	2	Metal		8590B
	(FF961)		1.790"	10.390"	2	Composite		80063C
	E-12001		1.794"	9.060"	1	Metal		80076B
	EFA-12F4		1.630"	9.200"	1	Composite		8618C
	EFA-12F4		1.625"	9.200"	1	Metal		8647B
13,000	EFA-13F5		1.630"	9.200"	1	Composite		8618C
	EFA-13F5		1.625"	9.200"	1	Metal		8647B
14,600	(FG941)		1.790"	10.390"	2	Metal		8611B
16,000	(FL941)		1.999"	11.212"	2	Metal		8571B
18,000	(FL941)		1.999"	11.212"	2	Metal		8571B
20,000	(FL941)		1.999"	11.212"	2	Metal		8571B

Tie Rod Ends

Axle Lbs. Rating	Code	Year	Length (Inches)	Notes	Tie Rod End Part No.		
					Drivers Side	Passenger Side	
12,000	(FF941)		5.44"	1-1/8"-18 Optional Thread	ES423L	ES423R	
	(FF941)		5.44"			ES3312R	
	(FF943)		5.44"			ES3312R	
	(FF943)		5.44"	1-1/8"-18 Optional Thread	ES423L	ES423R	
	(FF961)		5.44"			ES3312R	
	(FF961)		5.44"			ES423R	
	E-12001		6.00"			ES3476	
	EFA-12F3		5.44"		ES423L	ES423R	
	EFA-12F3		8.12"		ES3298L	ES3297R	
	EFA-12F4		5.44"		ES423L	ES423R	
	EFA-12F4		8.12"		ES3298L	ES3297R	
	13,000	EFA-13F3		5.44"		ES423L	ES423R
		EFA-13F3		8.12"		ES3298L	ES3297R
		EFA-13F5		5.44"		ES423L	ES423R
EFA-13F5			8.12"		ES3298L	ES3297R	
14,600	(FG941)		5.44"	1-1/8"-18 Optional Thread	ES423L	ES3312R	
	(FG941)		5.44"			ES423R	
16,000	(FL941)		12.69"		ES3031L	ES3030R	
	(FL941)		5.75"		ES431L	ES431R	
	(FL941)		7.37"		ES2090L	ES2091R	
	(FL943)		12.69"		ES3031L	ES3030R	
	(FL943)		5.75"		ES431L	ES431R	
	(FL943)		7.37"		ES2090L	ES2091R	
18,000	(FL941)		12.69"		ES3031L	ES3030R	
	(FL941)		5.75"		ES431L	ES431R	
	(FL941)		7.37"		ES2090L	ES2091R	
	(FL943)		12.69"		ES3031L	ES3030R	
	(FL943)		5.75"		ES431L	ES431R	
	(FL943)		7.37"		ES2090L	ES2091R	
20,000	(FL941)		12.69"		ES3031L	ES3030R	
	(FL941)		5.75"		ES431L	ES431R	
	(FL941)		7.37"		ES2090L	ES2091R	

T800, T800B, Conventional Cab (Cont'd)

Tie Rod Ends (Cont'd)

Axle Lbs. Rating	Code	Year	Length (Inches)	Notes	Tie Rod End Part No.	
					Drivers Side	Passenger Side
20,000	(FL943)		12.69"		ES3031L	ES3030R
	(FL943)		5.75"		ES431L	ES431R
	(FL943)		7.37"		ES2090L	ES2091R

Drag Links

Axle Lbs. Rating	Code	Year	Length (inches)	Notes	Drag Link No.
			28.25"	Replacable end	ES2204R ES2091R DS1454

T800B Conventional Cab

King Bolt Sets

Axle Lbs. Rating	Code	Year	Diameter (inches)	Length (Inches)	Pin Type	Bushing	Notes	King Pin Set No.
18,000	(EFA-18F3)		1.870"	9.970"	1	Composite		8633C
	(EFA-18F3)		1.870"	9.970"	1	Metal		8633B

W900

Tie Rod Ends

Axle Lbs. Rating	Code	Year	Length (Inches)	Notes	Tie Rod End Part No.	
					Drivers Side	Passenger Side
12,000	(FE900)		5.50"		ES325L	ES325R

W900, W900B, W900L, W900S

King Bolt Sets

Axle Lbs. Rating	Code	Year	Diameter (inches)	Length (Inches)	Pin Type	Bushing	Notes	King Pin Set No.
11,000	(FE900)		1.309/1.607"	9.750"	7	Metal		8386B
	(FE900)		1.309/1.607"	9.750"	7	Nylon		8386N
12,000	(FE970)		1.607"	8.812"	2	Metal		8514B
	(FE970)		1.607"	8.812"	2	Nylon		8514N
	(FF901)		1.794"	9.120"	2	Metal		8489B
	(FF901)		1.794"	9.120"	2	Nylon		8489N
	(FF921)		1.794"	10.392"	2	Metal		8553B
	(FF931)		1.794"	10.392"	2	Metal		8590B
	(FF941)		1.794"	10.392"	2	Metal		8590B
	(FF971)		1.607"	9.380"	2	Metal	(Center Point Steering)	8612B
	EFA-12F4		1.630"	9.200"	1	Composite		8618C
	EFA-12F4		1.625"	9.200"	1	Metal		8647B
	13,000	EFA-13F5		1.630"	9.200"	1	Composite	
EFA-13F5			1.625"	9.200"	1	Metal		8647B
14,600	(FG941)		1.790"	10.390"	2	Metal		8611B
16,000	(FH901)		1.999"	11.040"	2	Metal		8518B
	(FH901)		1.999"	11.040"	2	Nylon		8518N
	(FL931)		1.999"	11.212"	2	Metal		8571B
	(FL941)		1.999"	11.212"	2	Metal		8571B
18,000	(FL901)		1.999"	11.040"	2	Metal		8518B
	(FL901)		1.999"	11.040"	2	Nylon		8518N
	(FL931)		1.999"	11.212"	2	Metal		8571B
	(FL941)		1.999"	11.212"	2	Metal		8571B
	EFA-18F3		1.870"	9.970"	1	Composite		8633C
EFA-18F3		1.870"	9.970"	1	Metal		8633B	
20,000	(FL931)		1.999"	11.212"	2	Metal		8571B
	(FL941)		1.999"	11.212"	2	Metal		8571B
	EFA-20F4		1.870"	9.970"	1	Composite		8633C
	EFA-20F4		1.870"	9.970"	1	Metal		8633B
22,000			1.870"	9.970"	1	Composite		8633C
			1.870"	9.970"	1	Metal		8633B

Tie Rod Ends

Axle Lbs. Rating	Code	Year	Length (Inches)	Notes	Tie Rod End Part No.	
					Drivers Side	Passenger Side
11,000	(FE900)		4.88"		ES187L	ES187R

W900, W900B, W900L, W900S (Cont'd)

Tie Rod Ends (Cont'd)

Axle Lbs. Rating	Code	Year	Length (Inches)	Notes	Tie Rod End Part No.	
					Drivers Side	Passenger Side
11,000	(FE900)		5.75"		ES431L	ES431R
12,000	(FE970)		10.50"	Will Retrofit Older Axles	ES2200L	ES2201R
	(FE970)		4.88"		ES187L	ES187R
	(FE970)		5.75"	ES431L	ES431R	
	(FF901)		4.88"	ES187L	ES187R	
	(FF901)		5.75"	Anti-Tilt Seal Type	ES346L	ES346R
	(FF901)		5.75"		ES431L	ES431R
	(FF921)		5.44"	1-1/8"-18 Optional Thread		ES3312R
	(FF921)		5.44"		ES423L	ES423R
	(FF931)		5.44"		ES423L	ES423R
	(FF931)		5.44"	1-1/8"-18 Optional Thread		ES3312R
	(FF941)		5.44"	1-1/8"-18 Optional Thread		ES3312R
	(FF941)		5.44"		ES423L	ES423R
	(FF971)		10.50"	(Center Point Steering)	ES2200L	ES2201R
	EFA-12F4		5.44"		ES423L	ES423R
EFA-12F4		8.12"		ES3298L	ES3297R	
13,200	EFA-13F5		5.44"		ES423L	ES423R
	EFA-13F5		8.12"		ES3298L	ES3297R
14,600	(FG941)		5.44"	1-1/8"-18 Optional Thread		ES3312R
	(FG941)		5.44"		ES423L	ES423R
16,000	(FH901)		5.75"		ES431L	ES431R
	(FL931)		12.69"		ES3031L	ES3030R
	(FL931)		5.75"		ES431L	ES431R
	(FL931)		7.37"		ES2090L	ES2091R
	(FL941)		12.69"		ES3031L	ES3030R
	(FL941)		5.75"		ES431L	ES431R
	(FL941)		7.37"		ES2090L	ES2091R
18,000	(FL901)		5.75"		ES431L	ES431R
	(FL931)		12.69"		ES3031L	ES3030R
	(FL931)		5.75"		ES431L	ES431R
	(FL931)		7.37"		ES2090L	ES2209R
	(FL941)		12.69"		ES3031L	ES3030R
	(FL941)		5.75"		ES431L	ES431R
	(FL941)		7.37"		ES2090L	ES2091R
EFA-18F3		7.37"		ES2090L	ES2091R	
20,000	(FL931)		12.69"		ES3031L	ES3030R
	(FL931)		5.75"		ES431L	ES431R
	(FL931)		7.37"		ES2090L	ES2091R
	(FL941)		12.69"		ES3031L	ES3030R
	(FL941)		5.75"		ES431L	ES431R
	(FL941)		7.37"		ES2090L	ES2091R
EFA-20F4		7.37"		ES2090L	ES2091R	

Drag Links

Axle Lbs. Rating	Code	Year	Length (inches)	Notes	Drag Link No.
All				Drag Link End, Used on DS993 Drag Link End, Used on DS992 & DS994	ES431R ES2209R ES2204R ES2091R
12,000	(All)		29.56"	w/O.E. No. K162311 w/O.E. No. K162280	DS993 DS992 DS994
			30.56"		DS993 DS992 DS994
16,000	(All)		29.56"		DS993 DS992 DS994
			30.56"		DS993 DS992 DS994
18,000	(All)		29.56"		DS993 DS992 DS994
			30.56"		DS993 DS992 DS994

MACK TRUCK MODEL FINDING INDEX			
Model	Model	Model	Model
B42	B53	B57	B61
B67	B70	CXN612	CXN613
DM400	DM600	DM606S	DM607S
DM685S	DM685T	DM800	DMM600
F700	F786ST	MB400	MB600
MC400	MC600	MR400	MR600
R400	R487P	R600	R600L
R600LS	R685R	R685ST	R686ST
R700	R700L	R700LS	R767ST
RD400	RD600	RD700	RWL700S
RWS700S	U600	U68ST	WL700L
WL700LS	WS700L	WS700LS	

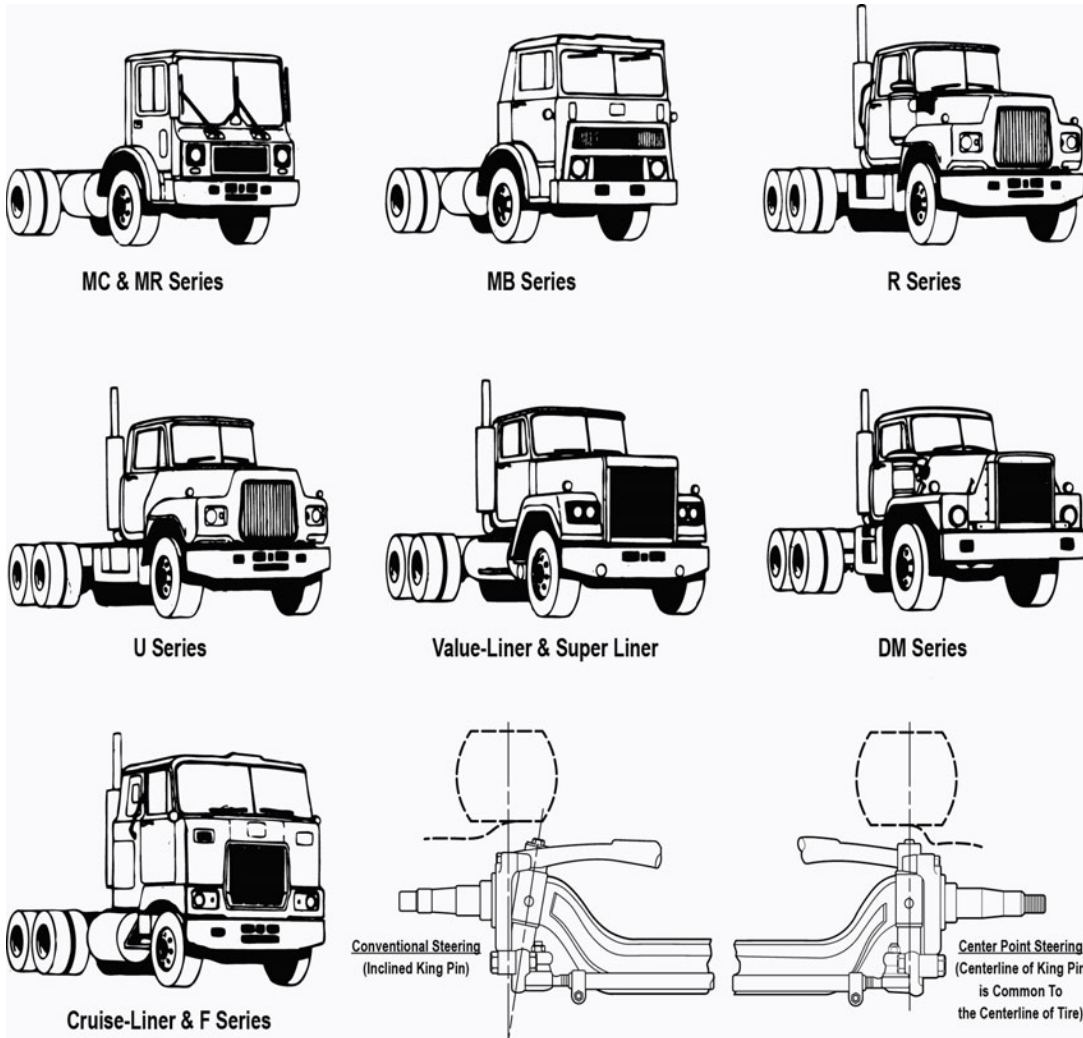

B42, B67, B70

King Bolt Sets

Axle Lbs. Rating	Code	Year	Diameter (inches)	Length (Inches)	Pin Type	Bushing	Notes	King Pin Set No.
8,000	FA505	1963-1965	1.250/1.500"	6.690"	6	Metal		8592B
10,000	FA517	1963-1965	1.250/1.500"	7.400"	6	Metal		8593B

B53, B57

King Bolt Sets

Axle Lbs. Rating	Code	Year	Diameter (inches)	Length (Inches)	Pin Type	Bushing	Notes	King Pin Set No.
------------------	------	------	-------------------	-----------------	----------	---------	-------	------------------

B53, B57 (Cont'd)

King Bolt Sets (Cont'd)

Axle Lbs. Rating	Code	Year	Diameter (inches)	Length (Inches)	Pin Type	Bushing	Notes	King Pin Set No.
18,000	(FL901)		1.999"	11.040"	2	Metal		8518B
	(FL901)		1.999"	11.040"	2	Nylon		8518N
	FA604		1.999"	11.040"	2	Metal		8518B
	FA604		1.999"	11.040"	2	Nylon		8518N

Tie Rod Ends

Axle Lbs. Rating	Code	Year	Length (Inches)	Notes	Tie Rod End Part No.	
					Drivers Side	Passenger Side
18,000	(FL901)		5.75"		ES431L	ES431R
	FA604		5.75"		ES431L	ES431R

B61

King Bolt Sets

Axle Lbs. Rating	Code	Year	Diameter (inches)	Length (Inches)	Pin Type	Bushing	Notes	King Pin Set No.
8,000	FA505	1963-1965	1.250/1.500"	6.690"	6	Metal		8592B
9,500	FA507	1963-1966	1.250/1.500"	7.400"	6	Metal		8593B

CXN612

Tie Rod Ends

Axle Lbs. Rating	Code	Year	Length (Inches)	Notes	Tie Rod End Part No.	
					Drivers Side	Passenger Side
12,000		2008	6.00"	after 07 engine	ES3477	ES3476
12,500		2008	6.00"	after 07 engine	ES3477	ES3476

CXN613

Tie Rod Ends

Axle Lbs. Rating	Code	Year	Length (Inches)	Notes	Tie Rod End Part No.	
					Drivers Side	Passenger Side
13,200		2008	7.38"	after 07 engine	ES3443L	ES3442R
14,600		2008	7.38"	after 07 engine	ES3443L	ES3442R

DM400

King Bolt Sets

Axle Lbs. Rating	Code	Year	Diameter (inches)	Length (Inches)	Pin Type	Bushing	Notes	King Pin Set No.
10,500	FA(W)536		1.375/1.625"	7.470"	6	Metal		8601B
	FA532		1.375/1.625"	7.470"	6	Metal		8601B
	FA535		1.250/1.500"	7.400"	6	Metal		8593B
12,000	FA(W)537		1.375/1.625"	7.470"	6	Metal		8601B
18,000	FA(W)616		2.125/1.750"	8.750"	6	Metal		80058B
20,000	FA(W)617		2.125/1.750"	8.750"	6	Metal		80058B

Tie Rod Ends

Axle Lbs. Rating	Code	Year	Length (Inches)	Notes	Tie Rod End Part No.	
					Drivers Side	Passenger Side
10,500	FA(W)536		4.88"	Coarse Thread	ES187L	ES187R
	FA(W)536		5.75"		ES431L	ES431R
	FA532		4.88"	Fine thread		ES2257R
	FA532		4.88"	Course Thread	ES405L	ES405R
12,000	FA(W)537		5.75"		ES431L	ES431R
18,000	FA(W)616		5.75"	Use w/Tube #7QH2531P1, 7QH253P2	ES431L	ES431R
	FA(W)616		7.37"	Use w/Tube #7QH253P3, 7QH253P4	ES2090L	ES2091R
20,000	FA(W)617		5.75"	Use w/Tube #7QH2531P1, 7QH253P2	ES431L	ES431R
	FA(W)617		7.37"	Use w/Tube #7QH253P3, 7QH253P4	ES2090L	ES2091R

Drag Links

Axle Lbs. Rating	Code	Year	Length (inches)	Notes	Drag Link No.
12,000	FA(W)537			Drag Link End-LH Thread Drag Link End Socket, LH Thread	ES2116L ES431L

DM400 (Cont'd)

Drag Links (Cont'd)

Axle Lbs. Rating	Code	Year	Length (inches)	Notes	Drag Link No.
12,000	FA(W)537			Drag Link End Socket, RH Thread	ES431R
				Drag Link End Socket, RH Thread, Use w/Tube Stamped 39305	
				Drag Link End-RH Thread	ES2114R
18,000	FA(W)616			Drag Link End Socket, LH Thread	ES431L
				Drag Link End Socket, RH Thread, Use w/Tube Stamped 39305	ES431R
	Drag Link End Socket, RH Thread				
	Drag Link End-RH Thread			ES2114R	
	Drag Link End-LH Thread			ES2116L	
20,000	FA(W)617		13.18"	Drag Link End Socket, LH Thread	ES431L
	FA617			Drag Link End Socket, RH Thread	ES431R
				Drag Link End Socket, RH Thread, Use w/Tube Stamped 39305	
				Drag Link End-LH Thread	DS1253
			Drag Link End-RH Thread	ES2116L	
				ES2114R	

DM600, DM606S, DM607S, DM685S, DM685T

King Bolt Sets

Axle Lbs. Rating	Code	Year	Diameter (inches)	Length (Inches)	Pin Type	Bushing	Notes	King Pin Set No.
10,500	FA(W)536		1.375/1.625"	7.470"	6	Metal		8601B
	FA532		1.375/1.625"	7.470"	6	Metal		8601B
	FA535		1.250/1.500"	7.400"	6	Metal		8593B
12,000	FA(W)537		1.375/1.625"	7.470"	6	Metal		8601B
	FA(W)537C		1.375/1.625"	7.470"	6	Metal		8601B
18,000	FA(W)616		2.125/1.750"	8.750"	6	Metal		80058B
20,000	FA(W)617		2.125/1.750"	8.750"	6	Metal		80058B
	FA(W)617D		2.125/1.750"	8.750"	6	Metal		80058B

Tie Rod Ends

Axle Lbs. Rating	Code	Year	Length (Inches)	Notes	Tie Rod End Part No.	
					Drivers Side	Passenger Side
10,500	FA(W)536		4.88"	Coarse Thread	ES187L	ES187R
	FA(W)536		5.75"		ES431L	ES431R
	FA532		4.88"	Fine Thread		ES2257R
	FA532		4.88"	Coarse Thread	ES405L	ES405R
12,000	FA(W)537		5.75"		ES431L	ES431R
	FA(W)537C		5.75"		ES431L	ES431R
18,000	FA(W)616		5.75"	Use w/Tube #7QH2531P1, 7QH253P2	ES431L	ES431R
	FA(W)616		7.37"	For units built after 2/20/84. Use w/Tube #7QH253P3, 7QH253P4	ES2090L	ES2091R
20,000	FA(W)617		5.75"	Use w/Tube #7QH2531P1, 7QH253P2	ES431L	ES431R
	FA(W)617		7.37"	Use w/Tube #7QH253P3, 7QH253P4	ES2090L	ES2091R
	FA(W)617D		5.75"	Use w/Tube #7QH2531P1, 7QH253P2	ES431L	ES431R
	FA(W)617D		7.37"	Use w/Tube #7QH253P3, 7QH253P4	ES2090L	ES2091R

Drag Links

Axle Lbs. Rating	Code	Year	Length (inches)	Notes	Drag Link No.
10,500	FA(W)536		13.18"	Drag Link End Socket, RH Thread, Use w/Tube Stamped 39305	ES431R
				Drag Link End Socket, RH Thread	
				Drag Link End Socket, LH Thread	ES431L
				Pinch Bolt Design. Use W/DS1253	ES3252R
				Drag Link End-LH Thread	ES2116L
				Drag Link End-RH Thread	ES2114R
				Use W/ES3252R	DS1253
				Pinch Bolt Design. Use W/DS1253	ES3252R
				Use W/ES3252R	DS1253
				Pinch Bolt Design. Use W/DS1253	ES3252R
12,000	FA(W)537		13.18"	Drag Link End-RH Thread	ES2114R
				Drag Link End-LH Thread	ES2116L
				Pinch Bolt Design. Use W/DS1253	ES3252R
				Drag Link End Socket, LH Thread	ES431L
				Drag Link End Socket, RH Thread	ES431R
				Drag Link End Socket, RH Thread, Use w/Tube Stamped 39305	
				Use W/ES3252R	DS1253
				Drag Link End Socket, RH Thread	ES431R
				Drag Link End Socket, LH Thread	ES431L
				Drag Link End Socket, RH Thread, Use w/Tube Stamped 39305	ES431R
13.18"	FA(W)537C		13.18"	Pinch Bolt Design. Use W/DS1253	ES3252R
				Use W/ES3252R	DS1253

DM600, DM606S, DM607S, DM685S, DM685T (Cont'd)

Drag Links (Cont'd)

Axle Lbs. Rating	Code	Year	Length (inches)	Notes	Drag Link No.
18,000	FA(W)616		13.18"	Pinch Bolt Design. Use W/DS1253 Drag Link End Socket, LH Thread Drag Link End Socket, RH Thread Drag Link End Socket, RH Thread, Use w/Tube Stamped 39305	ES3252R ES431L ES431R
	FA616			Use W/ES3252R Drag Link End-RH Thread Drag Link End-LH Thread	DS1253 ES2114R ES2116L
20,000	FA(W)617		13.18"	Drag Link End Socket, RH Thread, Use w/Tube Stamped 39305 Drag Link End Socket, RH Thread Pinch Bolt Design. Use W/DS1253 Drag Link End Socket, LH Thread Use W/ES3252R	ES431R ES3252R ES431L DS1253 ES431R
	FA(W)617D			Drag Link End Socket, RH Thread, Use w/Tube Stamped 39305 Drag Link End Socket, RH Thread Drag Link End Socket, LH Thread	ES431L ES3252R DS1253 ES431R
	FA617		13.18"	Pinch Bolt Design. Use W/DS1253 Use W/ES3252R Drag Link End-RH Thread Drag Link End-LH Thread	ES431L ES3252R DS1253 ES2114R ES2116L

DM800

King Bolt Sets

Axle Lbs. Rating	Code	Year	Diameter (inches)	Length (Inches)	Pin Type	Bushing	Notes	King Pin Set No.
18,000	FA(W)616		2.125/1.750"	8.750"	6	Metal		80058B
20,000	FA(W)617		2.125/1.750"	8.750"	6	Metal		80058B
23,000	FA703		2.098/1.746"	12.840"	6	Metal		80057B

Tie Rod Ends

Axle Lbs. Rating	Code	Year	Length (Inches)	Notes	Tie Rod End Part No.	
					Drivers Side	Passenger Side
18,000	FA(W)616		5.75"	Use w/Tube #7QH2531P1, 7QH253P2	ES431L	ES431R
	FA(W)616		7.37"	Use w/Tube #7QH253P3, 7QH253P4	ES2090L	ES2091R
20,000	FA(W)617		5.75"	For units built before 2/20/84. Use w/Tube #7QH2531P1, 7QH253P2	ES431L	ES431R
	FA(W)617		7.37"	For unit built after 2/20/84; Use w/Tube #7QH253P3, 7QH253P4	ES2090L	ES2091R

Drag Links

Axle Lbs. Rating	Code	Year	Length (inches)	Notes	Drag Link No.
18,000	FA(W)616		13.18"	Drag Link End Socket, RH Thread, Use w/Tube Stamped 39305 Drag Link End Socket, RH Thread Drag Link End Socket, LH Thread Use W/DS1253	ES431R ES431L ES3252R DS1253
				Use W/ES3252R	
20,000	FA(W)617		13.18"	Drag Link End Socket, RH Thread, Use w/Tube Stamped 39305 Drag Link End Socket, RH Thread Drag Link End Socket, LH Thread Use W/DS1253	ES431R ES431L ES3252R DS1253
				Use W/ES3252R	

DMM600, RD700

King Bolt Sets

Axle Lbs. Rating	Code	Year	Diameter (inches)	Length (Inches)	Pin Type	Bushing	Notes	King Pin Set No.
10,500	FA(W)536		1.375/1.625"	7.470"	6	Metal		8601B
	FA532		1.375/1.625"	7.470"	6	Metal		8601B
	FA535		1.250/1.500"	7.400"	6	Metal		8593B
12,000	FA(W)537		1.375/1.625"	7.470"	6	Metal		8601B
18,000	FA(W)616		2.125/1.750"	8.750"	6	Metal		80058B
20,000	FA(W)617		2.125/1.750"	8.750"	6	Metal		80058B

Tie Rod Ends

Axle Lbs. Rating	Code	Year	Length (Inches)	Notes	Tie Rod End Part No.	
					Drivers Side	Passenger Side
10,500	FA(W)536		4.88"	Coarse Thread	ES187L	ES187R
	FA(W)536		5.75"		ES431L	ES431R
	FA532		4.88"	Fine Thread		ES2257R

DMM600, RD700 (Cont'd)

Tie Rod Ends (Cont'd)

Axle Lbs. Rating	Code	Year	Length (Inches)	Notes	Tie Rod End Part No.	
					Drivers Side	Passenger Side
10,500	FA532		4.88"	Coarse Thread	ES405L	ES405R
12,000	FA(W)537		5.75"		ES431L	ES431R
18,000	FA(W)616		5.75"	Use w/Tube #7QH2531P1, 7QH253P2	ES431L	ES431R
	FA(W)616		7.37"	Use w/Tube #7QH253P3, 7QH253P4	ES2090L	ES2091R
20,000	FA(W)617		5.75"	Use w/Tube #7QH2531P1, 7QH253P2	ES431L	ES431R
	FA(W)617		7.37"	Use w/Tube #7QH253P3, 7QH253P4	ES2090L	ES2091R

Drag Links

Axle Lbs. Rating	Code	Year	Length (inches)	Notes	Drag Link No.
10,500	FA(W)536			Drag Link End-LH Thread Drag Link End Socket, LH Thread Drag Link End Socket, RH Thread Drag Link End Socket, RH Thread, Use w/Tube Stamped 39305 Drag Link End-RH Thread	ES2116L ES431L ES431R ES2114R
12,000	FA(W)537			Drag Link End Socket, RH Thread, Use w/Tube Stamped 39305 Drag Link End-RH Thread Drag Link End-LH Thread Drag Link End Socket, LH Thread Drag Link End Socket, RH Thread	ES431R ES2114R ES2116L ES431L ES431R
18,000	FA(W)616			Drag Link End Socket, RH Thread Drag Link End Socket, RH Thread, Use w/Tube Stamped 39305 Drag Link End Socket, LH Thread Drag Link End-RH Thread Drag Link End-LH Thread	ES431R ES431L ES2114R ES2116L
	FA616				
20,000	FA(W)617			Drag Link End Socket, LH Thread Drag Link End Socket, RH Thread Drag Link End Socket, RH Thread, Use w/Tube Stamped 39305 Drag Link End-LH Thread Drag Link End-RH Thread	ES431L ES431R ES2116L ES2114R
	FA617				

MB400, MB600

King Bolt Sets

Axle Lbs. Rating	Code	Year	Diameter (inches)	Length (Inches)	Pin Type	Bushing	Notes	King Pin Set No.
10,500	FA(W)536		1.375/1.625"	7.470"	6	Metal		8601B
	FA532		1.375/1.625"	7.470"	6	Metal		8601B
	FA535		1.250/1.500"	7.400"	6	Metal		8593B
12,000	FA(W)537		1.375/1.625"	7.470"	6	Metal		8601B
18,000	FA(W)616		2.125/1.750"	8.750"	6	Metal		80058B
20,000	FA(W)617		2.125/1.750"	8.750"	6	Metal		80058B

Tie Rod Ends

Axle Lbs. Rating	Code	Year	Length (Inches)	Notes	Tie Rod End Part No.	
					Drivers Side	Passenger Side
10,500	FA(W)536		4.88"	Coarse Thread	ES187L	ES187R
	FA(W)536		5.75"		ES431L	ES431R
	FA532		4.88"	Fine Thread		ES2257R
	FA532		4.88"	Coarse Thread	ES405L	ES405R
12,000	FA(W)537		5.75"		ES431L	ES431R
18,000	FA(W)616		5.75"	Use w/Tube #7QH2531P1, 7QH253P2	ES431L	ES431R
	FA(W)616		7.37"	Use w/Tube #7QH253P3, 7QH253P4	ES2090L	ES2091R
20,000	FA(W)617		5.75"	Use w/Tube #7QH2531P1, 7QH253P2	ES431L	ES431R
	FA(W)617		7.37"	Use w/Tube #7QH253P3, 7QH253P4	ES2090L	ES2091R

Drag Links

Axle Lbs. Rating	Code	Year	Length (inches)	Notes	Drag Link No.
12,000	FA(W)537			Drag Link End Socket, RH Thread, Use w/Tube Stamped 39305 Drag Link End Socket, RH Thread Drag Link End Socket, LH Thread	ES431R ES431L
18,000	FA(W)616			Drag Link End Socket, RH Thread, Use w/Tube Stamped 39305 Drag Link End Socket, RH Thread Drag Link End Socket, LH Thread	ES431R ES431L
20,000	FA(W)617			Drag Link End Socket, RH Thread, Use w/Tube Stamped 39305 Drag Link End Socket, RH Thread Drag Link End Socket, LH Thread	ES431R ES431L

MB400, MB600 (Cont'd)

Drag Links (Cont'd)

Axle Lbs. Rating	Code	Year	Length (inches)	Notes	Drag Link No.
20,000	FA(W)617		13.18"		DS1253

MC400, MC600

King Bolt Sets

Axle Lbs. Rating	Code	Year	Diameter (inches)	Length (Inches)	Pin Type	Bushing	Notes	King Pin Set No.
10,500	FA(W)536		1.375/1.625"	7.470"	6	Metal		8601B
12,000	FA(W)537		1.375/1.625"	7.470"	6	Metal		8601B
18,000	FA(W)616		2.125/1.750"	8.750"	6	Metal		80058B
20,000	FA(W)617		2.125/1.750"	8.750"	6	Metal		80058B

Tie Rod Ends

Axle Lbs. Rating	Code	Year	Length (Inches)	Notes	Tie Rod End Part No.	
					Drivers Side	Passenger Side
10,500	FA(W)536		4.88"	Coarse Thread	ES187L	ES187R
			4.88"		ES187L	ES187R
			5.75"		ES431L	ES431R
12,000	FA(W)537		5.75"		ES431L	ES431R
18,000	FA(W)616		5.75"	Use w/Tube #7QH2531P1, 7QH253P2	ES431L	ES431R
			7.37"		ES2090L	ES2091R
20,000	FA(W)617		5.75"	Use w/Tube #7QH2531P1, 7QH253P2	ES431L	ES431R
			7.37"		ES2090L	ES2091R

Drag Links

Axle Lbs. Rating	Code	Year	Length (inches)	Notes	Drag Link No.
10,500	FA(W)536		37.18"	Drag Link End-RH Thread	ES2114R
				Drag Link End-LH Thread	ES2116L
12,000	FA(W)537		37.18"	Pinch Bolt Design. Use W/DS1255	ES3252R
				Drag Link End Socket, LH Thread	ES431L
18,000	FA(W)616		37.18"	Drag Link End Socket, RH Thread	ES431R
				Drag Link End Socket, RH Thread, Use w/Tube Stamped 39305	ES431R
20,000	FA(W)617		37.18"	Use W/ES431R	DS1313
				Drag Link End-RH Thread	ES2114R
	FA616		37.18"	Drag Link End-LH Thread	ES2116L
					ES2116L
	FA617		37.18"	Pinch Bolt Design. Use W/DS1255	ES3252R
				Drag Link End Socket, LH Thread	ES431L
	FA617		37.18"	Drag Link End Socket, RH Thread	ES431R
				Drag Link End Socket, RH Thread, Use w/Tube Stamped 39305	ES431R
				Use W/ES431R	DS1313
				Drag Link End-LH Thread	ES2116L
				Drag Link End-RH Thread	ES2114R

MR400, MR600

King Bolt Sets

Axle Lbs. Rating	Code	Year	Diameter (inches)	Length (Inches)	Pin Type	Bushing	Notes	King Pin Set No.
10,500	FA(W)536		1.375/1.625"	7.470"	6	Metal		8601B
12,000	FA(W)537		1.375/1.625"	7.470"	6	Metal		8601B
18,000	FA(W)616		2.125/1.750"	8.750"	6	Metal		80058B
20,000	FA(W)617		2.125/1.750"	8.750"	6	Metal		80058B

Tie Rod Ends

Axle Lbs. Rating	Code	Year	Length (Inches)	Notes	Tie Rod End Part No.	
					Drivers Side	Passenger Side

MR400, MR600 (Cont'd)

Tie Rod Ends (Cont'd)

Axle Lbs. Rating	Code	Year	Length (Inches)	Notes	Tie Rod End Part No.	
					Drivers Side	Passenger Side
10,500	FA(W)536		4.88"	Coarse Thread	ES187L	ES187R
	FA(W)536		5.75"		ES431L	ES431R
12,000	FA(W)537		5.75"		ES431L	ES431R
18,000	FA(W)616		5.75"	Use w/Tube #7QH2531P1, 7QH253P2 For units built before 2/20/84.	ES431L	ES431R
	FA(W)616		5.75"		ES431L	ES431R
	FA(W)616		7.37"	Use w/Tube #7QH253P3, 7QH253P4 For units built after 2/20/84.	ES2090L	ES2091R
	FA(W)616		7.37"		ES2090L	ES2091R
20,000	FA(W)617		5.75"	Use w/Tube #7QH2531P1, 7QH253P2 For units built before 2/20/84.	ES431L	ES431R
	FA(W)617		5.75"		ES431L	ES431R
	FA(W)617		7.37"	Use w/Tube #7QH253P3, 7QH253P4 For units built after 2/20/84.	ES2090L	ES2091R
	FA(W)617		7.37"		ES2090L	ES2091R

Drag Links

Axle Lbs. Rating	Code	Year	Length (inches)	Notes	Drag Link No.
10,500	FA(W)536		37.18"	Drag Link End-RH Thread Drag Link End-LH Thread Pinch Bolt Design. Use W/DS1255 Drag Link End Socket, LH Thread Drag Link End Socket, RH Thread Drag Link End Socket, RH Thread, Use w/Tube Stamped 39305 Use W/ES431R	ES2114R ES2116L ES3252R ES431L ES431R DS1313
12,000	FA(W)536			37.18"	Drag Link End-RH Thread Drag Link End-LH Thread Drag Link End Socket, RH Thread, Use w/Tube Stamped 39305 Pinch Bolt Design. Use W/DS1255 Drag Link End Socket, LH Thread Drag Link End Socket, RH Thread Use W/ES431R
	FA(W)537				
18,000	FA(W)616		37.18"	Pinch Bolt Design. Use W/DS1255 Drag Link End Socket, LH Thread Drag Link End Socket, RH Thread Drag Link End Socket, RH Thread, Use w/Tube Stamped 39305 Use W/ES431R	ES3252R ES431L ES431R
	FA616				
20,000	FA(W)617		37.18"	Pinch Bolt Design. Use W/DS1255 Drag Link End Socket, LH Thread Drag Link End Socket, RH Thread Drag Link End Socket, RH Thread, Use w/Tube Stamped 39305 Use W/ES431R	ES3252R ES431L ES431R
	FA617				

R400

King Bolt Sets

Axle Lbs. Rating	Code	Year	Diameter (inches)	Length (Inches)	Pin Type	Bushing	Notes	King Pin Set No.
10,500	FA(W)536		1.375/1.625"	7.470"	6	Metal		8601B
	FA532		1.375/1.625"	7.470"	6	Metal		8601B
	FA535		1.250/1.500"	7.400"	6	Metal		8593B
12,000	FA(W)537		1.375/1.625"	7.470"	6	Metal		8601B
18,000	FA(W)616		2.125/1.750"	8.750"	6	Metal		80058B

Tie Rod Ends

Axle Lbs. Rating	Code	Year	Length (Inches)	Notes	Tie Rod End Part No.	
					Drivers Side	Passenger Side
10,500	FA(W)536		4.88"	Coarse Thread	ES187L	ES187R
	FA(W)536		4.88"		ES187L	ES187R
	FA(W)536		5.75"		ES431L	ES431R
12,000	FA(W)537		5.75"		ES431L	ES431R
18,000	FA(W)616		5.75"	Use w/Tube #7QH2531P1, 7QH253P2 Use w/Tube #7QH253P3, 7QH253P4	ES431L	ES431R
	FA(W)616		7.37"		ES2090L	ES2091R

Drag Links

Axle Lbs. Rating	Code	Year	Length (inches)	Notes	Drag Link No.
------------------	------	------	-----------------	-------	---------------

R400 (Cont'd)

Drag Links (Cont'd)

Axle Lbs. Rating	Code	Year	Length (inches)	Notes	Drag Link No.
10.500	FA(W)536			Drag Link End Socket, RH Thread, Use w/Tube Stamped 39305	ES431R
				Drag Link End Socket, RH Thread Drag Link End Socket, LH Thread	ES431L
12.000	FA(W)537			Drag Link End Socket, RH Thread, Use w/Tube Stamped 39305	ES431R
				Drag Link End Socket, RH Thread	ES431L
				Drag Link End Socket, LH Thread	ES2116L
				Drag Link End-LH Thread Drag Link End-RH Thread	ES2114R
18.000	FA(W)616			Drag Link End Socket, RH Thread, Use w/Tube Stamped 39305	ES431R
				Drag Link End Socket, RH Thread	ES431L
	FA616			Drag Link End Socket, LH Thread	ES2116L
				Drag Link End-LH Thread	ES2114R
				Drag Link End-RH Thread	ES2114R

R487P

Drag Links

Axle Lbs. Rating	Code	Year	Length (inches)	Notes	Drag Link No.
			14.18"	Pinch Bolt Design. Use W/DS1254	ES3252R DS1254

R600, R685R, R685ST, R686ST

King Bolt Sets

Axle Lbs. Rating	Code	Year	Diameter (inches)	Length (Inches)	Pin Type	Bushing	Notes	King Pin Set No.
8,000	FA511		1.250/1.500"	6.690"	6	Metal	From 1963	8592B
9,500	FA514		1.250/1.500"	7.400"	6	Metal	From 1963	8593B
10,500	FA(W)536		1.375/1.625"	7.470"	6	Metal		8601B
	FA(W)536C		1.375/1.625"	7.470"	6	Metal		8601B
	FA532		1.375/1.625"	7.470"	6	Metal		8601B
12,000	FA(W)537		1.375/1.625"	7.470"	6	Metal		8601B
	FA(W)537C		1.375/1.625"	7.470"	6	Metal		8601B
18,000	FA(W)616		2.125/1.750"	8.750"	6	Metal		80058B
20,000	FA(W)617		2.125/1.750"	8.750"	6	Metal		80058B

Tie Rod Ends

Axle Lbs. Rating	Code	Year	Length (Inches)	Notes	Tie Rod End Part No.	
					Drivers Side	Passenger Side
10,500	FA(W)536		4.88"	Coarse Thread	ES187L	ES187R
	FA(W)536		5.75"		ES431L	ES431R
	FA(W)536C		4.88"	Coarse Thread	ES187L	ES187R
	FA(W)536C		4.88"		ES187L	ES187R
	FA(W)536C		5.75"		ES431L	ES431R
	FA532		4.88"	Fine Thread		ES2257R
	FA532		4.88"	Coarse Thread	ES405L	ES405R
12,000	FA(W)537		5.75"		ES431L	ES431R
	FA(W)537C		5.75"		ES431L	ES431R
18,000	FA(W)616		5.75"	Use w/Tube #7QH2531P1, 7QH253P2	ES431L	ES431R
	FA(W)616		7.37"	Use w/Tube #7QH253P3, 7QH253P4	ES2090L	ES2091R
20,000	FA(W)617		5.75"	Use w/Tube #7QH2531P1, 7QH253P2	ES431L	ES431R
	FA(W)617		7.37"	Use w/Tube #7QH253P3, 7QH253P4	ES2090L	ES2091R

Drag Links

Axle Lbs. Rating	Code	Year	Length (inches)	Notes	Drag Link No.
8.000	FA511		13.18" 14.18"	Pinch Bolt Design. Use W/DS1253 & DS1254	ES3252R
				Use W/ES3252R	DS1253 DS1254
9.500	FA514		13.18" 14.18"	Pinch Bolt Design. Use W/DS1253 & DS1254	ES3252R
				Use W/ES3252R	DS1253 DS1254
10.500	FA(W)536			Drag Link End Socket, RH Thread	ES431R
				Drag Link End Socket, RH Thread, Use w/Tube Stamped 39305	ES431L
				Drag Link End Socket, LH Thread	ES3252R
				Pinch Bolt Design. Use W/DS1253 & DS1254	ES2116L
				Drag Link End-LH Thread Drag Link End-RH Thread	ES2114R

R600, R685R, R685ST, R686ST (Cont'd)

Drag Links (Cont'd)

Axle Lbs. Rating	Code	Year	Length (inches)	Notes	Drag Link No.
10,500	FA(W)536		13.18"	Use W/ES3252R	DS1253 DS1254 ES431R
	FA(W)536C		14.18"	Drag Link End Socket, RH Thread, Use w/Tube Stamped 39305 Drag Link End Socket, RH Thread Drag Link End Socket, LH Thread Pinch Bolt Design. Use W/DS1253 & DS1254 Use W/ES3252R	ES431L ES3252R DS1253 DS1254 ES3252R
	FA532		13.18" 14.18"	Pinch Bolt Design. Use W/DS1253 & DS1254 Use W/ES3252R	DS1253 DS1254 ES3252R DS1253 DS1254
12,000	FA(W)537		13.18" 14.18"	Pinch Bolt Design. Use W/DS1253 & DS1254 Drag Link End-LH Thread Drag Link End Socket, LH Thread Drag Link End Socket, RH Thread Drag Link End Socket, RH Thread, Use w/Tube Stamped 39305 Drag Link End-RH Thread Use W/ES3252R	ES3252R ES2116L ES431L ES431R ES2114R DS1253 DS1254
18,000	FA(W)616		13.18" 14.18"	Pinch Bolt Design. Use W/DS1253 & DS1254 Drag Link End Socket, RH Thread, Use w/Tube Stamped 39305 Drag Link End Socket, LH Thread Drag Link End Socket, RH Thread Use W/ES3252R	ES3252R ES431R ES431L ES431R DS1253 DS1254 ES2116L ES2114R
	FA616			Drag Link End-LH Thread Drag Link End-RH Thread	
20,000	FA(W)617		13.18" 14.18"	Pinch Bolt Design. Use W/DS1253 & DS1254 Use W/ES3252R	ES3252R DS1253 DS1254

R600L, R600LS, R700L, R700LS, RWL700S, RWS700S, WL700L WL700LS, WS700L, WS700LS

King Bolt Sets

Axle Lbs. Rating	Code	Year	Diameter (inches)	Length (Inches)	Pin Type	Bushing	Notes	King Pin Set No.
10,500	FA(W)536		1.375/1.625"	7.470"	6	Metal		8601B
	FA535		1.250/1.500"	7.400"	6	Metal		8593B
12,000	FA(W)537		1.375/1.625"	7.470"	6	Metal		8601B
	FF931		1.794"	10.392"	2	Metal		8590B
18,000	FL931		1.999"	11.212"	2	Metal		8571B

Tie Rod Ends

Axle Lbs. Rating	Code	Year	Length (Inches)	Notes	Tie Rod End Part No.	
					Drivers Side	Passenger Side
10,500	FA(W)536		4.88"	Coarse Thread	ES187L	ES187R
	FA(W)536		5.75"		ES431L	ES431R
12,000	FA(W)537		5.75"	1-1/8"-18 Optional Thread	ES431L	ES431R
	FF931		5.44"			ES3312R
	FF931		5.44"		ES423L	ES423R
18,000	FL931		12.69"		ES3031L	ES3030R
	FL931		5.75"		ES431L	ES431R
	FL931		7.37"		ES2090L	ES2091R

Drag Links

Axle Lbs. Rating	Code	Year	Length (inches)	Notes	Drag Link No.
10,500	FA(W)536			Drag Link End Socket, RH Thread, Use w/Tube Stamped 39305 Drag Link End Socket, RH Thread Drag Link End Socket, LH Thread	ES431R ES431L
12,000	FA(W)537			Drag Link End Socket, RH Thread, Use w/Tube Stamped 39305 Drag Link End Socket, RH Thread Drag Link End Socket, LH Thread	ES431R ES431L
18,000	FA(W)616			Drag Link End Socket, RH Thread, Use w/Tube Stamped 39305 Drag Link End Socket, RH Thread Drag Link End Socket, LH Thread	ES431R ES431L

RD400

Heavy Duty Trucks

King Bolt Sets

Axle Lbs. Rating	Code	Year	Diameter (inches)	Length (Inches)	Pin Type	Bushing	Notes	King Pin Set No.
8,000	FA511		1.250/1.500"	6.690"	6	Metal	From 1963	8592B
9,500	FA514		1.250/1.500"	7.400"	6	Metal	From 1963	8593B
10,500	FA(W)536		1.375/1.625"	7.470"	6	Metal		8601B
	FA532		1.375/1.625"	7.470"	6	Metal		8601B
	FA535		1.250/1.500"	7.400"	6	Metal		8593B
12,000	FA(W)537		1.375/1.625"	7.470"	6	Metal		8601B
18,000	FA(W)616		2.125/1.750"	8.750"	6	Metal		80058B

Tie Rod Ends

Axle Lbs. Rating	Code	Year	Length (Inches)	Notes	Tie Rod End Part No.	
					Drivers Side	Passenger Side
10,500	FA(W)536		4.88"	Coarse Thread	ES187L	ES187R
	FA(W)536		5.75"		ES431L	ES431R
12,000	FA(W)537		5.75"		ES431L	ES431R
18,000	FA(W)616		5.75"	Use w/Tube #7QH2531P1, 7QH253P2 For units built after 2/20/84. Use w/Tube #7QH253P3, 7QH253P4	ES431L	ES431R
	FA(W)616		7.37"		ES2090L	ES2091R

Drag Links

Axle Lbs. Rating	Code	Year	Length (inches)	Notes	Drag Link No.
8,000	FA511		13.18"	Pinch Bolt Design. Use W/DS1253 Use W/ES3252R	ES3252R DS1253
9,500	FA514		13.18"	Pinch Bolt Design. Use W/DS1253 Use W/ES3252R	ES3252R DS1253
10,500	FA(W)536		13.18"	Drag Link End Socket, LH Thread	ES431L
		Drag Link End Socket, RH Thread		ES431R	
		Pinch Bolt Design. Use W/DS1253		ES3252R	
		Drag Link End-LH Thread		ES2116L	
				Drag Link End-RH Thread	ES2114R
				Drag Link End Socket, RH Thread, Use w/Tube Stamped 39305	ES431R
	FA532		13.18"	Use W/ES3252R	DS1253
				Pinch Bolt Design. Use W/DS1253	ES3252R
	FA535		13.18"	Use W/ES3252R	DS1253
				Pinch Bolt Design. Use W/DS1253	ES3252R
				Use W/ES3252R	DS1253
12,000	FA(W)537		13.18"	Drag Link End Socket, LH Thread	ES431L
		Drag Link End-RH Thread		ES2114R	
		Pinch Bolt Design. Use W/DS1253		ES3252R	
		Drag Link End Socket, RH Thread		ES431R	
				Drag Link End Socket, RH Thread, Use w/Tube Stamped 39305	
				Drag Link End-LH Thread	ES2116L
				Use W/ES3252R	DS1253
18,000	FA(W)616		13.18"	Pinch Bolt Design. Use W/DS1253	ES3252R
		Drag Link End Socket, LH Thread		ES431L	
		Drag Link End Socket, RH Thread		ES431R	
		Drag Link End Socket, RH Thread, Use w/Tube Stamped 39305			
				Use W/ES3252R	DS1253
				Drag Link End-RH Thread	ES2114R
				Drag Link End-LH Thread	ES2116L

RD600, R700

King Bolt Sets

Axle Lbs. Rating	Code	Year	Diameter (inches)	Length (Inches)	Pin Type	Bushing	Notes	King Pin Set No.
8,000	FA511		1.250/1.500"	6.690"	6	Metal	From 1963	8592B
9,500	FA514		1.250/1.500"	7.400"	6	Metal	From 1963	8593B
10,500	FA(W)536		1.375/1.625"	7.470"	6	Metal		8601B
	FA532		1.375/1.625"	7.470"	6	Metal		8601B
12,000	FA(W)537		1.375/1.625"	7.470"	6	Metal		8601B
18,000	FA(W)616		2.125/1.750"	8.750"	6	Metal		80058B
20,000	FA(W)617		2.125/1.750"	8.750"	6	Metal		80058B

Tie Rod Ends

Axle Lbs. Rating	Code	Year	Length (Inches)	Notes	Tie Rod End Part No.	
					Drivers Side	Passenger Side
10,500	FA(W)536		4.88"	Coarse Thread	ES187L	ES187R
	FA(W)536		5.75"		ES431L	ES431R
	FA532		4.88"			ES2257R

RD600, R700 (Cont'd)

Tie Rod Ends (Cont'd)

Axle Lbs. Rating	Code	Year	Length (Inches)	Notes	Tie Rod End Part No.	
					Drivers Side	Passenger Side
10,500	FA532		4.88"	Coarse Thread	ES405L	ES405R
12,000	FA(W)537		5.75"		ES431L	ES431R
18,000	FA(W)616		5.75"	For units built before 2/20/84; Use w/Tube #7QH253P1, 7QH253P2	ES431L	ES431R
	FA(W)616		7.37"	For unit built after 2/20/84; Use w/Tube #7QH253P3, 7QH253P4	ES2090L	ES2091R
20,000	FA(W)617		5.75"	For units built before 2/20/84; Use w/Tube #7QH253P1, 7QH253P2	ES431L	ES431R
	FA(W)617		7.37"	For unit built after 2/20/84; Use w/Tube #7QH253P3, 7QH253P4	ES2090L	ES2091R

Drag Links

Axle Lbs. Rating	Code	Year	Length (inches)	Notes	Drag Link No.
10,500	FA(W)536		13.18"	Drag Link End-RH Thread	ES2114R
				Drag Link End-LH Thread	ES2116L
12,000	FA(W)537		13.18"	Use W/DS1253	ES3252R
				Drag Link End Socket, LH Thread	ES431L
18,000	FA(W)616		13.18"	Drag Link End Socket, RH Thread	ES431R
				Drag Link End Socket, RH Thread, Use w/Tube Stamped 39305	ES2114R
20,000	FA(W)617		13.18"	Use W/ES3252R	ES2116L
				Use W/DS1253	ES431L

U600, U68ST, F700, F786ST, R767ST

King Bolt Sets

Axle Lbs. Rating	Code	Year	Diameter (inches)	Length (Inches)	Pin Type	Bushing	Notes	King Pin Set No.
8,000	FA511		1.250/1.500"	6.690"	6	Metal	From 1963	8592B
9,500	FA514		1.250/1.500"	7.400"	6	Metal	From 1963	8593B
10,500	FA(W)536		1.375/1.625"	7.470"	6	Metal		8601B
	FA532		1.375/1.625"	7.470"	6	Metal		8601B
12,000	FA(W)537		1.375/1.625"	7.470"	6	Metal		8601B

Tie Rod Ends

Axle Lbs. Rating	Code	Year	Length (Inches)	Notes	Tie Rod End Part No.	
					Drivers Side	Passenger Side
10,500	FA(W)536		4.88"	Coarse Thread	ES187L	ES187R
	FA(W)536		5.75"		ES431L	ES431R
	FA532		4.88"	Fine Thread		ES2257R
	FA532		4.88"	Coarse Thread	ES405L	ES405R
12,000	FA(W)537		5.75"		ES431L	ES431R

Drag Links

Axle Lbs. Rating	Code	Year	Length (inches)	Notes	Drag Link No.
10,500	FA(W)536		13.18"	Drag Link End-RH Thread	ES2114R
				Use W/DS1253	ES2116L
12,000	FA(W)537		13.18"	Drag Link End Socket, LH Thread	ES3252R
				Drag Link End Socket, RH Thread	ES431L

MACK



U600, U68ST, F700, F786ST, R767ST (Cont'd)

Drag Links (Cont'd)

Axle Lbs. Rating	Code	Year	Length (inches)	Notes	Drag Link No.
12.000	FA(W)537		13.18"	Drag Link End Socket, LH Thread Drag Link End Socket, RH Thread Use W/ES3252R	ES431L ES431R DS1253

Heavy Duty Trucks

MARMON TRUCK MODEL FINDING INDEX

Model	Model	Model	Model
COE	Conventional		



Conventional



Aluminum Tilt Cab

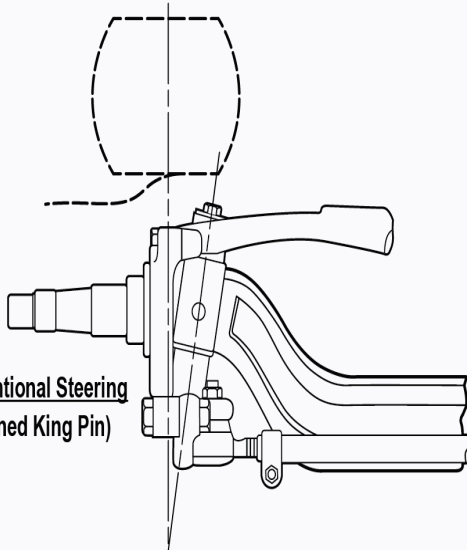

**Conventional Steering
(Inclined King Pin)**

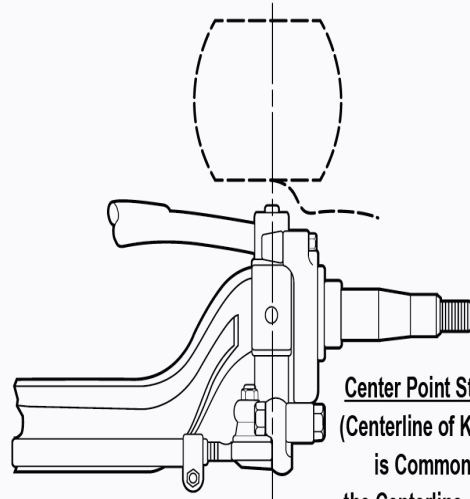

**Center Point Steering
(Centerline of King Pin
is Common To
the Centerline of Tire)**

COE

King Bolt Sets

Axle Lbs. Rating	Code	Year	Diameter (inches)	Length (Inches)	Pin Type	Bushing	Notes	King Pin Set No.
12,000	(EFA-12F4)		1.630"	9.200"	1	Composite		8618C
	(FF941)		1.794"	10.390"	2	Composite		8616C
	(FF941)		1.794"	10.392"	2	Metal		8590B
18,000	(FL941)		1.999"	11.212"	2	Metal		8571B

Conventional

King Bolt Sets

Axle Lbs. Rating	Code	Year	Diameter (inches)	Length (Inches)	Pin Type	Bushing	Notes	King Pin Set No.
12,000	(EFA-12F4)		1.630"	9.200"	1	Composite		8618C
	(FF941)		1.794"	10.390"	2	Composite		8616C
	(FF941)		1.794"	10.392"	2	Metal		8590B
18,000	(FL941)		1.999"	11.212"	2	Metal		8571B

Conventional, COE

King Bolt Sets

Axle Lbs. Rating	Code	Year	Diameter (inches)	Length (Inches)	Pin Type	Bushing	Notes	King Pin Set No.
12,000	(FE900)		1.309/1.607"	9.750"	7	Metal		8386B
	(FE900)		1.309/1.607"	9.750"	7	Nylon		8386N

Conventional, COE (Cont'd)

King Bolt Sets (Cont'd)

Axle Lbs. Rating	Code	Year	Diameter (inches)	Length (Inches)	Pin Type	Bushing	Notes	King Pin Set No.
12,000	(FE970)		1.607"	8.812"	2	Metal		8514B
	(FE970)		1.607"	8.812"	2	Nylon		8514N
	(FF901)		1.794"	9.120"	2	Metal		8489B
	(FF901)		1.794"	9.120"	2	Nylon		8489N
	(FF921)		1.794"	10.392"	2	Metal		8553B
	(FF931)		1.794"	10.392"	2	Metal		8590B
	(FF971)		1.607"	9.380"	2	Metal		8612B
16,000	(FH901)		1.999"	11.040"	2	Metal		8518B
	(FH901)		1.999"	11.040"	2	Nylon		8518N
	(FL931)		1.999"	11.212"	2	Metal		8571B
18,000	(FL901)		1.999"	11.040"	2	Metal		8518B
	(FL901)		1.999"	11.040"	2	Nylon		8518N

Tie Rod Ends

Axle Lbs. Rating	Code	Year	Length (Inches)	Notes	Tie Rod End Part No.	
					Drivers Side	Passenger Side
11,000	(FE900)		4.88"		ES187L	ES187R
	(FE900)		5.75"		ES431L	ES431R
12,000	(FE970)		10.50"	Will Retrofit Older Axles	ES2200L	ES2201R
	(FE970)		10.50"		ES2200L	ES2201R
	(FE970)		4.88"		ES187L	ES187R
	(FE970)		5.75"		ES431L	ES431R
	(FF901)		4.88"		ES187L	ES187R
	(FF901)		5.75"	Anti-Tilt Seal Type	ES346L	ES346R
	(FF901)		5.75"	Conventional Seal Type	ES431L	ES431R
	(FF921)		5.44"	1-1/8"-18 Optional Thread		ES3312R
	(FF921)		5.44"		ES423L	ES423R
	(FF931)		5.44"		ES423L	ES423R
	(FF931)		5.44"	1-1/8"-18 Optional Thread		ES3312R
16,000	(FF971)		10.50"	(Center Point Steering)	ES2200L	ES2201R
	(FH901)		5.75"		ES431L	ES431R
	(FL931)		12.69"		ES3031L	ES3030R
	(FL931)		5.75"		ES431L	ES431R
18,000	(FL931)		7.37"		ES2090L	ES2091R
	(FL901)		5.75"		ES431L	ES431R

MITSUBISHI TRUCK MODEL FINDING INDEX

Model	Model	Model	Model
Fuso FE434			

Fuso FE434

Tie Rod Ends

Axle Lbs. Rating	Code	Year	Length (Inches)	Notes	Tie Rod End Part No.	
					Drivers Side	Passenger Side
		1987-1988	3.78"		ES2556L	ES2557R

NAVISTAR/IHC TRUCK MODEL FINDING INDEX

Model	Model	Model	Model
1452 Series Medium Duty	1600 Loadstar & School Bus	1624 S Series Medium Duty	1652 Series Medium Duty
1654 S Series Medium Duty	1658 S Series Medium Duty	1700 Loadstar & School Bus	1723 S Series Medium Duty
1724 S Series Medium Duty	1750 Loadstar & School Bus	1753 S Series Medium Duty	1754 S Series Medium Duty
1758 S Series Medium Duty	1800 Loadstar & School Bus	1823 S Series Medium Duty	1824 S Series Medium Duty
1850 Loadstar & School Bus	1853 S Series Medium Duty	1854 S Series Medium Duty	1858 S Series Medium Duty
1890 Loadstar & School Bus	1900 Fleetstar	1910A Fleetstar	1924 S Series Medium Duty
1925 S Series Medium Duty	1950 Fleetstar	1954 S Series Medium Duty	1955 S Series Medium Duty
1958 S Series Medium Duty	2000 Fleetstar	2010A Fleetstar	2050A Fleetstar
2070A Fleetstar	2110A Fleetstar	2125 S Series Medium Duty	2155 S Series Medium Duty
2275 S Series Heavy Duty	2276 S Series Heavy Duty	2375 S Series Heavy Duty	2524 S Series Heavy Duty
2554 S Series Heavy Duty	2554 Series (Built 1989 & Later)	2574 S Series Heavy Duty	2574 Series (Built 1989 & Later)
2575 S Series Heavy Duty	2624 S Series Heavy Duty	2654 Series (Built 1989 & Later)	2674 S Series Heavy Duty
2674 Series (Built 1989 & Later)	2675 S Series Heavy Duty	3700 Series	3800 Series
3900 Series	4070B Transtar	4170 Transtar	4200 Transtar
4300 Transtar	4600 Series	4700 Series	4800 Series
4900 Series	5010 Paystar	5050 Paystar	5070 Paystar
7100 Series	8100 Series (Built 1989 & Later)	8200 Series (Built 1989 & Later)	8300 Series (Built 1989 & Later)
9100 Series Short conventional Cab	9200 Series	9200i	9300 Series
9400 Series	9400i	9600 Series	9700 Series
9800 Series	CO4070B Transtar	COF4070B Transtar	CO1600 Loadstar & School Bus
CO1610 Cargostar	CO1630 Cargostar	CO1700 Loadstar & School Bus	CO1710 Cargostar
CO1730 Cargostar	CO1750 Cargostar	CO1750 Loadstar & School Bus	CO1800 Loadstar & School Bus
CO1810 Cargostar	CO1830 Cargostar	CO1850 Cargostar	CO1850 Loadstar & School Bus
CO1910 Cargostar	CO1950 Cargostar	CO4000	CO4070A Transtar
CO4070B Transtar	CO5370 Paystar	CO9670 Eagle	COF1810 Cargostar
COF1910 Cargostar	COF1950 Cargostar	COF4000	COF4070A Transtar
COF4070B Transtar	COF5370 Paystar	COF5870	COF9670 Eagle
COT4000	D400 Conventional	D405 Conventional	DC400 Conventional
DC405 Conventional	DCF400 Conventional	DCF400M Conventional	DCF405 Conventional
DCT405 Conventional	DF400 Conventional	DF405 Conventional	DT405 Conventional
F1600 Loadstar & School Bus	F1700 Loadstar & School Bus	F1800 Loadstar & School Bus	F1850 Loadstar & School Bus
F1900 Fleetstar	F1900A Fleetstar	F1924 S Series Medium Duty	F1950 Fleetstar
F1954 S Series Medium Duty	F2000 Fleetstar	F2010A Fleetstar	F2050A Fleetstar
F2070A Fleetstar	F2125 S Series Medium Duty	F2275 S Series Heavy Duty	F2276 S Series Heavy Duty
F2375 S Series Heavy Duty	F2524 S Series Heavy Duty	F2554 S Series Heavy Duty	F2574 S Series Heavy Duty
F2575 S Series Heavy Duty	F2624 S Series Heavy Duty	F2654 S Series Heavy Duty	F2674 S Series Heavy Duty
F2675 S Series Heavy Duty	F4070B Transtar	F4170 Transtar	F4200 Transtar
F4300 Transtar	F5010 Paystar	F5050 Paystar	F5050SF Paystar
F5050SF-LW Paystar	F5070 Paystar	F5070SF Paystar	F5070SF-LW Paystar
M1400 Series Medium Duty	M1600 Series Medium Duty	RE Series, Bus	T1900 Fleetstar
T1950 Fleetstar	T2000 Fleetstar		

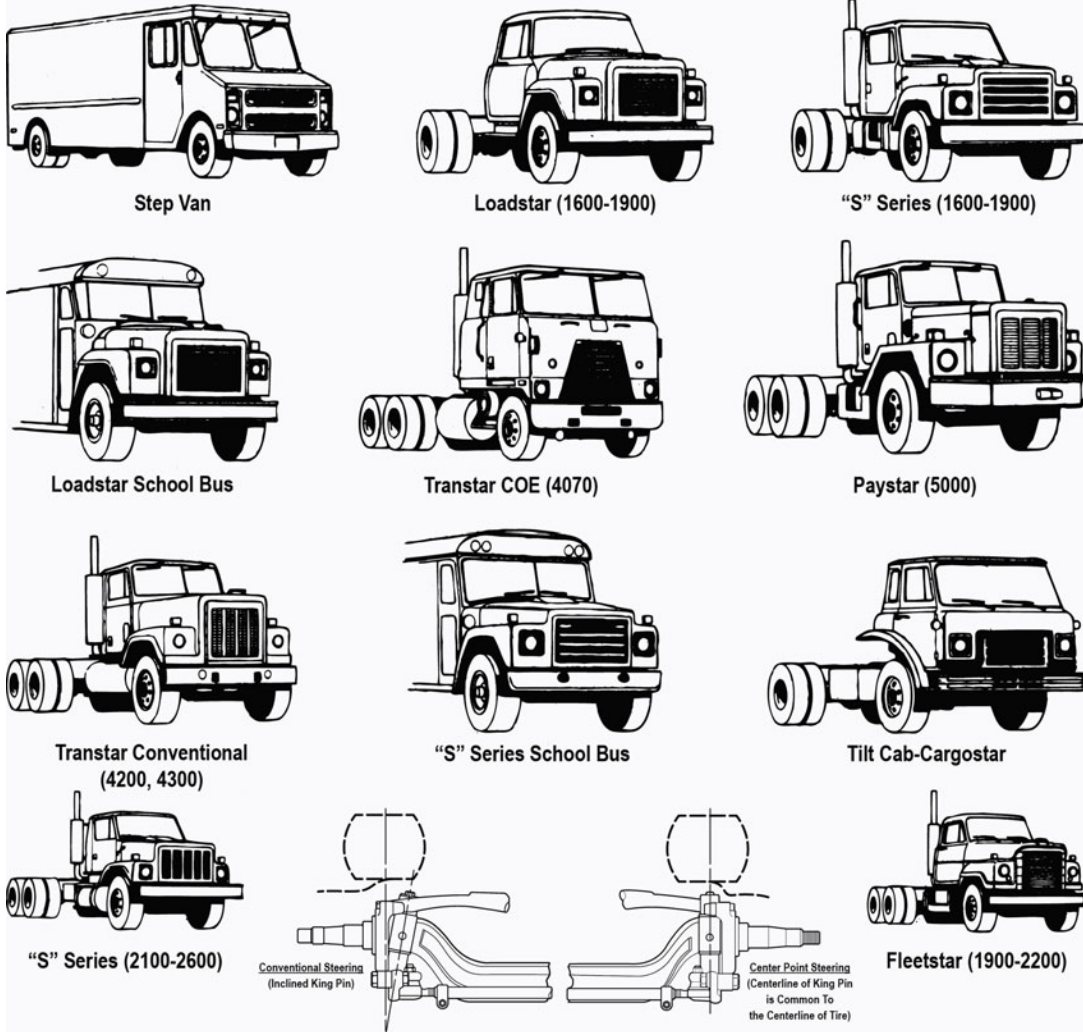

2554, 2574, 2654, 2674 Series (Built 1989 & Later)

King Bolt Sets

Axle Lbs. Rating	Code	Year	Diameter (inches)	Length (Inches)	Pin Type	Bushing	Notes	King Pin Set No.
10,000	I100S		1.921"	9.870"	2	Composite		8655C
	I100S		1.921"	9.870"	2	Metal		8655B
12,000	FF961 (02ARA)		1.790"	10.390"	2	Composite	Rockwell Kit 1315	80063C
	FF961 (02ARA)		1.790"	10.390"	2	Metal		80063B
	I120S		1.921"	9.870"	2	Composite		8655C
	I120S		1.921"	9.870"	2	Metal		8655B
13,200	FF942 (02227)		1.790"	10.390"	2	Composite	Rockwell Kit 1315	80063C
	FF942 (02227)		1.790"	10.390"	2	Metal		80063B
14,000	I140S		2.046"	10.120"	2	Composite		80070C
	I140S		2.046"	10.120"	2	Metal		8657B
16,000	FL941 (02231)		1.999"	11.212"	2	Metal	Rockwell Kit 198	8571B
	I160S (02ADH)		2.046"	11.000"	2	Composite		80075C
	I160S (02ADH)		2.046"	11.000"	2	Composite		80075C
	I160S (02ADH)		2.046"	11.000"	2	Metal		80074B
18,000	FL941 (02232)		1.999"	11.212"	2	Metal	Rockwell Kit 198	8571B
	I180S (02ADJ)		2.046"	11.000"	2	Composite		80075C
	I180S (02ADJ)		2.046"	11.000"	2	Composite		80075C

NAVISTAR/IHC TRUCK



2554, 2574, 2654, 2674 Series (Built 1989 & Later) (Cont'd)

King Bolt Sets (Cont'd)

Axle Lbs. Rating	Code	Year	Diameter (inches)	Length (Inches)	Pin Type	Bushing	Notes	King Pin Set No.
18,000	I180S (02ADJ)		2.046"	11.000"	2	Metal		80074B
20,000	FL941 (02233)		1.999"	11.212"	2	Metal	Rockwell Kit 198	8571B
	I200S (02ADK)		2.046"	11.000"	2	Composite		80075C
	I200S (02ADK)		2.046"	11.000"	2	Composite		80075C
	I200S (02ADK)		2.046"	11.000"	2	Metal		80074B

Tie Rod Ends

Axle Lbs. Rating	Code	Year	Length (Inches)	Notes	Tie Rod End Part No.	
					Drivers Side	Passenger Side
10,000	I100S (02ADC) I100S (02ADC)		5.44"	w/126" through 225" W.B.	ES423L	ES423R
			9.18"	w/226" through 280" W.B.	ES411L	ES411R
12,000	FF961 (02ARA) FF961 (02ARA) I120S (02ADD) I120S (02ADD) I120S (02ADG)		5.44"	1-1/8"-18 Optional Thread w/126" through 225" W.B. w/226" through 280" W.B.	ES423L	ES423R
			5.44"		ES3312R	
			5.44"		ES423L	ES423R
			9.18"		ES411L	ES411R
13,200	FF942 (02227) FF942 (02227)		5.44"	1-1/8"-18 Optional Thread	ES423L	ES423R
			5.44"		ES3312R	
14,000	I140S (02ADE) I140S (02ADE)		5.44"		ES3217L	ES3218R
			9.43"		ES3219L	ES3220R
16,000	FL941 (02231) FL941 (02231) FL941 (02231) FL941 (02232) FL941 (02232) FL941 (02232) FL941 (02232) FL941 (02233) FL941 (02233) FL941 (02233) I160S (02ADH) I160S (02ADH)		12.69"		ES3031L	ES3030R
			5.75"		ES431L	ES431R
			7.37"		ES2090L	ES2091R
			12.69"		ES3031L	ES3030R
			5.75"		ES431L	ES431R
			7.37"		ES2090L	ES2091R
			12.69"		ES3031L	ES3030R
			5.75"		ES431L	ES431R
			7.37"		ES2090L	ES2091R
			12.69"		ES3030R	ES3031L
			5.75"		ES431L	ES431R
			7.37"		ES2090L	ES2091R
18,000	FL941 (02231) FL941 (02231) FL941 (02231) FL941 (02232) FL941 (02232) FL941 (02232)		12.69"		ES3031L	ES3030R
			5.75"		ES431L	ES431R
			7.37"		ES2090L	ES2091R
			12.69"		ES3031L	ES3030R
			5.75"		ES431L	ES431R
			7.37"		ES2090L	ES2091R
			7.37"		ES2090L	ES2091R

2554, 2574, 2654, 2674 Series (Built 1989 & Later) (Cont'd)

Tie Rod Ends (Cont'd)

Axle Lbs. Rating	Code	Year	Length (Inches)	Notes	Tie Rod End Part No.	
					Drivers Side	Passenger Side
18,000	FL941 (02233)		12.69"		ES3031L	ES3030R
	FL941 (02233)		5.75"		ES431L	ES431R
	FL941 (02233)		7.37"		ES2090L	ES2091R
	I180S (02ADJ)		12.69"		ES3030R	ES3031L
	I180S (02ADJ)		5.75"		ES431L	ES431R
20,000	FL941 (02231)		12.69"		ES3031L	ES3030R
	FL941 (02231)		5.75"		ES431L	ES431R
	FL941 (02231)		7.37"		ES2090L	ES2091R
	FL941 (02232)		12.69"		ES3031L	ES3030R
	FL941 (02232)		5.75"		ES431L	ES431R
	FL941 (02232)		7.37"		ES2090L	ES2091R
	FL941 (02233)		12.69"		ES3031L	ES3030R
	FL941 (02233)		5.75"		ES431L	ES431R
	FL941 (02233)		7.37"		ES2090L	ES2091R
	I200S (02ADK)		12.69"		ES3030R	ES3031L
	I200S (02ADK)		5.75"		ES431L	ES431R

Drag Links

Axle Lbs. Rating	Code	Year	Length (inches)	Notes	Drag Link No.
			17.68"	Used on 05PTA, 05PRH (2500)	DS1214
			17.96"	Used on 05PTB 2004 R.H. P/S (2500)	DS1281
			18.14"	Used on 05PTB 2004 L.H. P/S	DS979
			32.85"	Used on 05PTB 2001 R.H. P/S (2600)	DS1303

3700, 3800, 3900 Series

King Bolt Sets

Axle Lbs. Rating	Code	Year	Diameter (inches)	Length (Inches)	Pin Type	Bushing	Notes	King Pin Set No.
6,000	I60S (02ADA)		1.359"	7.970"	1	Composite	No Ream, Single Drawkey	8577C
	I60S (02ADA)		1.361"	7.970"	1	Composite	No Ream, Double Drawkey	8577C002
	I60S (02ADA)		1.360"	7.970"	2	Composite	No Ream, Double Drawkey	8637C
	I60S (02ADA)		1.360"	7.970"	2	Metal	Double Drawkey	8637B
8,000	I80S (02ADB)		1.359"	7.970"	1	Composite	No Ream, Single Drawkey	8577C
	I80S (02ADB)		1.361"	7.970"	1	Composite	No Ream, Double Drawkey	8577C002
	I80S (02ADB)		1.360"	7.970"	2	Composite	No Ream, Double Drawkey	8637C
10,000	I100S		1.921"	9.870"	2	Composite	Double Drawkey	8655C
	I100S		1.921"	9.870"	2	Metal	Double Drawkey	8655B
	I120S		1.921"	9.870"	2	Composite	Double Drawkey	8655C
12,000	I120S		1.921"	9.870"	2	Metal	Double Drawkey	8655B
	I140S (02ADE)		2.046"	10.120"	2	Composite	Double Drawkey	80070C
14,000	I140S (02ADE)		2.046"	10.120"	2	Metal	Double Drawkey	8657B
	FA231 (02231)		1.999"	11.212"	2	Metal		8571B

Tie Rod Ends

Axle Lbs. Rating	Code	Year	Length (Inches)	Notes	Tie Rod End Part No.	
					Drivers Side	Passenger Side

NAVISTAR/IHC TRUCK



3700, 3800, 3900 Series (Cont'd)

Tie Rod Ends (Cont'd)

Axle Lbs. Rating	Code	Year	Length (Inches)	Notes	Tie Rod End Part No.	
					Drivers Side	Passenger Side
6,000	I60S (02ADA)		11.89"		ES3205R	ES3204L
8,000	I80S (02ADB)		11.89"		ES3205R	ES3204L
10,000	I100S (02ADC) I100S (02ADC)		5.44"	w/126" through 225" W.B.	ES423L	ES423R
			9.18"	w/226" through 280" W.B.	ES411L	ES411R
12,000	FA082 FA083 (02083) I120S (02ADD) I120S (02ADD)		4.88"	Fabco SDA12	ES187L	ES187R
			4.88"	Fabco SDA12	ES187L	ES187R
			5.44"	w/126" through 225" W.B.	ES423L	ES423R
			9.18"	w/226" through 280" W.B.	ES411L	ES411R
14,000	I140S (02ADE) I140S (02ADE)		5.44"		ES3217L	ES3218R
			9.43"		ES3219L	ES3220R
16,000	FA231 (02231) FA231 (02231) FA231 (02231)		12.69"		ES3031L	ES3030R
			5.75"		ES431L	ES431R
			7.37"	Rockwell FL941 w/Disc Wheels	ES2090L	ES2091R

4600, 4700, 4800, 4900 Series

King Bolt Sets

Axle Lbs. Rating	Code	Year	Diameter (inches)	Length (Inches)	Pin Type	Bushing	Notes	King Pin Set No.
6,000	I60S (02ADA) I60S (02ADA) I60S (02ADA) I60S (02ADA)		1.359"	7.970"	1	Composite	No Ream, Single Drawkey	8577C
			1.361"	7.970"	1	Composite	No Ream, Double Drawkey	8577C002
			1.360"	7.970"	2	Composite	No Ream, Double Drawkey	8637C
			1.360"	7.970"	2	Metal	Double Drawkey	8637B
8,000	I80S (02ADB) I80S (02ADB) I80S (02ADB) I80S (02ADB)		1.359"	7.970"	1	Composite	No Ream, Single Drawkey	8577C
			1.361"	7.970"	1	Composite	No Ream, Double Drawkey	8577C002
			1.360"	7.970"	2	Composite	No Ream, Double Drawkey	8637C
			1.360"	7.970"	2	Metal	Double Drawkey	8637B
10,000	I100S (02ADC) I100S (02ADC)		1.921"	9.870"	2	Composite		8655C
			1.921"	9.870"	2	Metal		8655B
12,000	I120S (02ADD) I120S (02ADD)		1.921"	9.870"	2	Composite		8655C
			1.921"	9.870"	2	Metal		8655B
14,000	I140S (02ADE) I140S (02ADE)		2.046"	10.120"	2	Composite		80070C
			2.046"	10.120"	2	Metal		8657B
16,000	FA231 (02231) I160S (02ADH) I160S (02ADH)		1.999"	11.212"	2	Metal		8571B
			2.046"	11.000"	2	Composite		80075C
			2.046"	11.000"	2	Metal		80074B
18,000	I180S (02ADJ) I180S (02ADJ)		2.046"	11.000"	2	Composite		80075C
			2.046"	11.000"	2	Metal		80074B
20,000	I200S (02ADK) I200S (02ADK)		2.046"	11.000"	2	Composite		80075C
			2.046"	11.000"	2	Metal		80074B

4600, 4700, 4800, 4900 Series (Cont'd)

Tie Rod Ends						
Axle Lbs. Rating	Code	Year	Length (Inches)	Notes	Tie Rod End Part No.	
					Drivers Side	Passenger Side
6,000	I60S (02ADA)		11.89"		ES3205R	ES3204L
8,000	I80S (02ADB)		11.89"		ES3205R	ES3204L
10,000	I100S (02ADC)		5.44"	w/126" through 225" W.B.	ES423L	ES423R
			9.18"	w/226" through 280" W.B.	ES411L	ES411R
12,000	FA082 (02EYB) FA083 (02083) I120S (02ADD) I120S (02ADD) I120S (02ADG) I120S (02ADG)		4.88"	Fabco SDA12	ES187L	ES187R
			4.88"	Fabco SDA12	ES187L	ES187R
			5.44"	w/126" through 225" W.B.	ES423L	ES423R
			9.18"	w/226" through 280" W.B.	ES411L	ES411R
			5.44"		ES423L	ES423R
			9.18"		ES411L	ES411R
14,000	I140S (02ADE) I140S (02ADE)		5.44"		ES3217L	ES3218R
			9.43"		ES3219L	ES3220R
16,000	FA231 (02231) FA231 (02231) FA231 (02231) I160S (02ADH) I160S (02ADH)		12.69"		ES3031L	ES3030R
			5.75"		ES431L	ES431R
			7.37"	Rockwell FL941 w/Disc Wheels	ES2090L	ES2091R
			12.69"		ES3030R	ES3031L
			5.75"		ES431R	ES431L
18,000	I180S (02ADJ) I180S (02ADJ)		12.69"		ES3030R	ES3031L
			5.75"		ES431R	ES431L
20,000	I200S (02ADK) I200S (02ADK)		12.69"		ES3030R	ES3031L
			5.75"		ES431R	ES431L
			12.69"		ES3030R	ES3031L
			5.75"		ES431R	ES431L

Drag Links						
Axle Lbs. Rating	Code	Year	Length (inches)	Notes	Drag Link No.	
	FA64 (02064)		18.45"	Ross TAS55 Pwr Strg.	DS1305	

7100 Series

King Bolt Sets								
Axle Lbs. Rating	Code	Year	Diameter (inches)	Length (Inches)	Pin Type	Bushing	Notes	King Pin Set No.
6,000	I60S (02ADA)		1.359"	7.970"	1	Composite	No Ream, Single Drawkey	8577C
			1.361"	7.970"	1	Composite	No Ream, Single Drawkey	8577C002
			1.360"	7.970"	2	Composite	No Ream, Double Drawkey	8637C
			1.360"	7.970"	2	Metal	Double Drawkey	8637B
8,000	I80S (02ADB)		1.359"	7.970"	1	Composite	No Ream, Single Drawkey	8577C
			1.361"	7.970"	1	Composite	No Ream, Single Drawkey	8577C002
			1.360"	7.970"	2	Composite	No Ream, Double Drawkey	8637C
			1.360"	7.970"	2	Metal	Double Drawkey	8637B
10,000	I100S (02ADC)		1.921"	9.870"	2	Composite		8655C
			1.921"	9.870"	2	Metal		8655B
12,000	E-12001 (02AED)		1.794"	9.060"	1	Metal		80076B

Heavy Duty Trucks

7100 Series (Cont'd)

King Bolt Sets (Cont'd)

Axle Lbs. Rating	Code	Year	Diameter (inches)	Length (Inches)	Pin Type	Bushing	Notes	King Pin Set No.
12,000	I120S (02ADD)		1.921"	9.870"	2	Composite		8655C
	I120S (02ADD)		1.921"	9.870"	2	Metal		8655B
14,000	I140S (02ADE)		2.046"	10.120"	2	Composite		80070C
	I140S (02ADE)		2.046"	10.120"	2	Metal		8657B
16,000	FA231 (02231)		1.999"	11.212"	2	Metal	Double Drawkey, Rockwell Std. FH901	8571B

Tie Rod Ends

Axle Lbs. Rating	Code	Year	Length (Inches)	Notes	Tie Rod End Part No.	
					Drivers Side	Passenger Side
6,000	I60S (02ADA)		11.89"		ES3205R	ES3204L
8,000	I80S (02ADB)		11.89"		ES3205R	ES3204L
10,000	I100S (02ADC) I100S (02ADC)		5.44"	w/126" through 225" W.B.	ES423L	ES423R
			9.18"	w/226" through 280" W.B.	ES411L	ES411R
12,000	E-1200I (02AED) FA082 (02EYB) FA083 (02083) I120S (02ADD) I120S (02ADD)		6.00"		ES3477	ES3476
			4.88"	Fabco SDA12 Axle	ES187L	ES187R
			4.88"	Fabco SDA12 Axle	ES187L	ES187R
			5.44"	w/126" through 225" W.B.	ES423L	ES423R
			9.18"	w/226" through 280" W.B.	ES411L	ES411R
14,000	I140S (02ADE) I140S (02ADE)		5.44"		ES3217L	ES3218R
			9.43"		ES3219L	ES3220R
16,000	FA231 (02231)		7.37"	Rockwell FL941 w/Disc Wheels	ES2090L	ES2091R

Drag Links

Axle Lbs. Rating	Code	Year	Length (inches)	Notes	Drag Link No.
			17.47" 17.68"		DS1215 DS1214

8100, 8200, 8300 Series (Built 1989 & Later)

King Bolt Sets

Axle Lbs. Rating	Code	Year	Diameter (inches)	Length (Inches)	Pin Type	Bushing	Notes	King Pin Set No.
10,000	I100S (02ADC) I100S (02ADC)		1.921"	9.870"	2	Composite		8655C
			1.921"	9.870"	2	Metal		8655B
12,000	FF942 (02227) FF961 (02ARA) FF961 (02ARA) I120S (02ADD) I120S (02ADD) I120S (02ADG) I120S (02ADG)		1.794"	10.392"	2	Metal		8590B
			1.790"	10.390"	2	Composite	Rockwell Kit 1315	80063C
			1.790"	10.390"	2	Metal		80063B
			1.921"	9.870"	2	Composite		8655C
			1.921"	9.870"	2	Metal		8655B
			1.921"	9.870"	2	Composite		8655C
			1.921"	9.870"	2	Metal		8655B

8100, 8200, 8300 Series (Built 1989 & Later) (Cont'd)

King Bolt Sets (Cont'd)

Axle Lbs. Rating	Code	Year	Diameter (inches)	Length (Inches)	Pin Type	Bushing	Notes	King Pin Set No.
13,200	FF932 (02227)		1.794"	10.392"	2	Metal		8590B
14,000	I140S (02ADE)		2.046"	10.120"	2	Composite		80070C
	I140S (02ADE)		2.046"	10.120"	2	Metal		8657B
	I140S (02ADE)		2.046"	10.120"	2	Metal		8657B
16,000	FL941 (02231)		1.999"	11.212"	2	Metal	Rockwell Kit 198	8571B
18,000	FL941 (02232)		1.999"	11.212"	2	Metal	Rockwell Kit 198	8571B
20,000	FL941 (02233)		1.999"	11.212"	2	Metal	Rockwell Kit 198	8571B

Tie Rod Ends

Axle Lbs. Rating	Code	Year	Length (Inches)	Notes	Tie Rod End Part No.		
					Drivers Side	Passenger Side	
10,000	I100S (02ADC)		5.44"	w/126" through 225" W.B.	ES423L	ES423R	
			9.18"	w/226" through 280" W.B.	ES411L	ES411R	
12,000	FF942 (02227) FF942 (02227) FF961 (02ARA) FF961 (02ARA) I120S (02ADD) I120S (02ADD) I120S (02ADG)		5.44"	1-1/8"-18 Optional Thread	ES423L	ES423R	
			5.44"		ES3312R		
			5.44"		ES423L	ES423R	
			5.44"	1-1/8"-18 Optional Thread		ES3312R	
			5.44"		w/126" through 225" W.B.	ES423L	ES423R
			9.18"		w/226" through 280" W.B.	ES411L	ES411R
13,200	FF932 (02227) FF932 (02227)		5.44"	1-1/8"-18 Optional Thread	ES423L	ES423R	
			5.44"		ES3312R		
14,000	I140S (02ADE) I140S (02ADE)		5.44"		ES3217L	ES3218R	
			9.43"		ES3219L	ES3220R	
16,000	FL941 (02231) FL941 (02231) FL941 (02231) FL941 (02232) FL941 (02232) FL941 (02232) FL941 (02233) FL941 (02233) FL941 (02233)		12.69"		ES3031L	ES3030R	
			5.75"		ES431L	ES431R	
			7.37"		ES2090L	ES2091R	
			12.69"		ES3031L	ES3030R	
			5.75"		ES431L	ES431R	
			7.37"		ES2090L	ES2091R	
			12.69"		ES3031L	ES3030R	
			5.75"		ES431L	ES431R	
			7.37"		ES2090L	ES2091R	
			18,000	FL941 (02231) FL941 (02231) FL941 (02231) FL941 (02232)		12.69"	
5.75"		ES431L	ES431R				
7.37"		ES2090L	ES2091R				
12.69"		ES3031L	ES3030R				

8100, 8200, 8300 Series (Built 1989 & Later) (Cont'd)

Heavy Duty Trucks

Tie Rod Ends (Cont'd)

Axle Lbs. Rating	Code	Year	Length (Inches)	Notes	Tie Rod End Part No.	
					Drivers Side	Passenger Side
18,000	FL941 (02232)		5.75"		ES431L	ES431R
	FL941 (02232)		7.37"		ES2090L	ES2091R
	FL941 (02233)		12.69"		ES3031L	ES3030R
	FL941 (02233)		5.75"		ES431L	ES431R
	FL941 (02233)		7.37"		ES2090L	ES2091R
	FL941 (02233)					
20,000	FL941 (02231)		12.69"		ES3031L	ES3030R
	FL941 (02231)		5.75"		ES431L	ES431R
	FL941 (02231)		7.37"		ES2090L	ES2091R
	FL941 (02232)		12.69"		ES3031L	ES3030R
	FL941 (02232)		5.75"		ES431L	ES431R
	FL941 (02232)		7.37"		ES2090L	ES2091R
	FL941 (02232)		12.69"		ES3031L	ES3030R
	FL941 (02233)		5.75"		ES431L	ES431R
	FL941 (02233)		7.37"		ES2090L	ES2091R
	FL941 (02233)		12.69"		ES3031L	ES3030R
	FL941 (02233)		5.75"		ES431L	ES431R
	FL941 (02233)		7.37"		ES2090L	ES2091R
	FL941 (02233)					

Drag Links

Axle Lbs. Rating	Code	Year	Length (inches)	Notes	Drag Link No.
			16.50" 17.68" 24.08" 27.56"	Adj. End for Set Back Axle Adj. End for Set Forward Axle DS1264 Drag link & ES3178R End	ES3216R ES3178R DS1302 DS1214 DS1264 DS1291A

9100 Series Short conventional Cab

King Bolt Sets

Axle Lbs. Rating	Code	Year	Diameter (inches)	Length (Inches)	Pin Type	Bushing	Notes	King Pin Set No.
12,000	I120S		1.921"	9.870"	2	Composite	Double Drawkey	8655C
	I120S		1.921"	9.870"	2	Metal	Double Drawkey	8655B

Tie Rod Ends

Axle Lbs. Rating	Code	Year	Length (Inches)	Notes	Tie Rod End Part No.	
					Drivers Side	Passenger Side
12,000	I120S		5.44"		ES423L	ES423R
	I120S		9.18"		ES411L	ES411R

9200 Series

King Bolt Sets

Axle Lbs. Rating	Code	Year	Diameter (inches)	Length (Inches)	Pin Type	Bushing	Notes	King Pin Set No.
10,000	I100S (02ADC)		1.921"	9.870"	2	Composite	Double Drawkey	8655C
	I100S (02ADC)		1.921"	9.870"	2	Metal	Double Drawkey	8655B
12,000	E-12001 (02AED)		1.794"	9.060"	1	Metal		80076B
	EFA-12F3 (02AEA)		1.630"	9.200"	1	Composite		8631C
	EFA-12F3 (02AEA)		1.625"	9.195"	1	Metal		8631B

9200 Series (Cont'd)

King Bolt Sets (Cont'd)

Axle Lbs. Rating	Code	Year	Diameter (inches)	Length (Inches)	Pin Type	Bushing	Notes	King Pin Set No.
12,000	EFA-12F4 (02250)		1.630"	9.200"	1	Composite		8618C
	FF942 (02227)		1.794"	10.392"	2	Metal		8590B
	FF961 (02ARA)		1.790"	10.390"	2	Composite		80063C
	FF961 (02ARA)		1.790"	10.390"	2	Metal		80063B
	I120S (02ADD)		1.921"	9.870"	2	Composite	Double Drawkey	8655C
	I120S (02ADD)		1.921"	9.870"	2	Metal	Double Drawkey	8655B
13,200	EFA-13F5 (02250)		1.625"	9.200"	1	Metal		8647B
	FF932 (02227)		1.794"	10.392"	2	Metal		8590B
14,000	I140S (02ADE)		2.046"	10.120"	2	Composite		80070C
	I140S (02ADE)		2.046"	10.120"	2	Metal		8657B
16,000	FL941 (02231)		1.999"	11.212"	2	Metal		8571B
	FL941 (02232)		1.999"	11.212"	2	Metal		8571B
	I160S (02ADH)		2.046"	11.000"	2	Composite		80075C
	I160S (02ADH)		2.046"	11.000"	2	Metal		80074B
18,000	FL941 (02231)		1.999"	11.212"	2	Metal		8571B
	FL941 (02232)		1.999"	11.212"	2	Metal		8571B
	I180S (02ADJ)		2.046"	11.000"	2	Composite		80075C
	I180S (02ADJ)		2.046"	11.000"	2	Metal		80074B

Tie Rod Ends

Axle Lbs. Rating	Code	Year	Length (Inches)	Notes	Tie Rod End Part No.	
					Drivers Side	Passenger Side
10,000	I100S (02ADC)		5.44"	w/o 04AZA ABS Brakes, 154 through 188 W.B.	ES423L	ES423R
			9.18"	189 W.B. and Up	ES411L	ES411R
12,000	E-1200I (02AED) EFA-12F3 EFA-12F4 FF942 (02227) FF942 (02227) FF961 (02ARA) FF961 (02ARA) I120S (02ADD) I120S (02ADD)		6.00"		ES3477	ES3476
			5.44"		ES423L	ES423R
			8.12"		ES3298L	ES3297R
			5.44"		ES423L	ES423R
			5.44"	1-1/8"-18 Optional Thread		ES3312R
			5.44"		ES423L	ES423R
			5.44"	1-1/8"-18 Optional Thread		ES3312R
			5.44"	w/o 04AZA ABS Brakes, 154 through 188 W.B.	ES423L	ES423R
13,200	EFA-13F3 EFA-13F5 FF932 (02227) FF932 (02227)		5.44"		ES423L	ES423R
			8.12"		ES3298L	ES3297R
			5.44"	1-1/8"-18 Optional Thread		ES3312R
			5.44"		ES423L	ES423R
14,000	I140S (02ADE) I140S (02ADE)		5.44"	Used on J, X, Refer to line set ticket	ES3217L	ES3218R
			9.43"	Used on U, Y, Refer to line set ticket	ES3219L	ES3220R

9200 Series (Cont'd)

Tie Rod Ends (Cont'd)

Axle Lbs. Rating	Code	Year	Length (Inches)	Notes	Tie Rod End Part No.	
					Drivers Side	Passenger Side
16,000	FL941 (02231)		12.69"		ES3031L	ES3030R
	FL941 (02231)		5.75"		ES431L	ES431R
	FL941 (02231)		7.37"		ES2090L	ES2091R
	FL941 (02232)		12.69"		ES3031L	ES3030R
	FL941 (02232)		5.75"		ES431L	ES431R
	FL941 (02232)		7.37"		ES2090L	ES2091R
	FL941 (02232)		12.69"		ES3031L	ES3030R
	FL941 (02232)		5.75"		ES431L	ES431R
18,000	FL941 (02231)		12.69"		ES3031L	ES3030R
	FL941 (02231)		5.75"		ES431L	ES431R
	FL941 (02231)		7.37"		ES2090L	ES2091R
	FL941 (02232)		12.69"		ES3031L	ES3030R
	FL941 (02232)		5.75"		ES431L	ES431R
	FL941 (02232)		7.37"		ES2090L	ES2091R
	I180S (02ADJ)		12.69"		ES3031L	ES3030R
	I180S (02ADJ)		5.75"		ES431L	ES431R

Drag Links

Axle Lbs. Rating	Code	Year	Length (inches)	Notes	Drag Link No.
			24.99" 29.01" 29.20"	End only for DS1298 & DS1296 Codes 05PRJ, 05PSA Codes 05PSA, 05PRJ Code 05PRK	ES2204R ES2091R DS1298 DS1294A DS1295A

9200i , 9400i

Tie Rod Ends

Axle Lbs. Rating	Code	Year	Length (Inches)	Notes	Tie Rod End Part No.	
					Drivers Side	Passenger Side
12,000		2007	6.00"	after 9/06 engine	ES3477	ES3476

9300, 9400 Series

King Bolt Sets

Axle Lbs. Rating	Code	Year	Diameter (inches)	Length (Inches)	Pin Type	Bushing	Notes	King Pin Set No.
10,000	I100S (02ADC)		1.921"	9.870"	2	Composite	Double Drawkey	8655C
	I100S (02ADC)		1.921"	9.870"	2	Metal	Double Drawkey	8655B
12,000	E-1200I (02AED)		1.794"	9.060"	1	Metal		80076B
	EFA-12F3 (02AEA)		1.630"	9.200"	1	Composite		8631C
	EFA-12F3 (02AEA)		1.625"	9.195"	1	Metal		8631B
	EFA-12F4 (02250)		1.630"	9.200"	1	Composite		8618C
	FA234 (02234)		1.607"	9.380"	2	Metal	Double Drawkey, Rockwell FF971	8612B
	FF931 (02226)		1.794"	10.392"	2	Metal		8590B
	FF961 (02ARA)		1.790"	10.390"	2	Composite	Kit 1315	80063C

9300, 9400 Series (Cont'd)

King Bolt Sets (Cont'd)

Axle Lbs. Rating	Code	Year	Diameter (inches)	Length (Inches)	Pin Type	Bushing	Notes	King Pin Set No.
12,000	FF961 (02ARA)		1.790"	10.390"	2	Metal		80063B
	I120S (02ADD)		1.921"	9.870"	2	Composite	Double Drawkey	8655C
	I120S (02ADD)		1.921"	9.870"	2	Metal	Double Drawkey	8655B
13,200	E-1320I (02AEG)		1.794"	9.060"	1	Metal		80076B
	EFA-13F5 (02250)		1.625"	9.200"	1	Metal		8647B
	FA227 (02227)		1.794"	10.392"	2	Metal	Rockwell FF941	8590B
14,000	I140S (02ADE)		2.046"	10.120"	2	Composite		80070C
	I140S (02ADE)		2.046"	10.120"	2	Metal		8657B
	I140S (02ADE)		2.046"	10.120"	2	Metal		8657B
14,600	FG941 (02ARG)		1.790"	10.390"	2	Metal		8611B
16,000	FA231 (02231)		1.999"	11.212"	2	Metal		8571B
	I160S (02ADH)		2.046"	11.000"	2	Composite		80075C
	I160S (02ADH)		2.046"	11.000"	2	Metal		80074B
18,000	FA232 (02232)		1.999"	11.212"	2	Metal		8571B
	I180S (02ADJ)		2.046"	11.000"	2	Composite		80075C
	I180S (02ADJ)		2.046"	11.000"	2	Metal		80074B
20,000	I200S (02ADK)		2.046"	11.000"	2	Composite		80075C
	I200S (02ADK)		2.046"	11.000"	2	Metal		80074B

Tie Rod Ends

Axle Lbs. Rating	Code	Year	Length (Inches)	Notes	Tie Rod End Part No.		
					Drivers Side	Passenger Side	
10,000	I100S		5.44"		ES423L	ES423R	
			9.18"		ES411L	ES411R	
12,000	E-1200I (02AED)		6.00"	Rockwell FF971	ES3477	ES3476	
	EFA-12F3		5.44"		ES423L	ES3297R	
	EFA-12F4		8.12"		ES3298L	ES2201R	
	FA234 (02234)		10.50"		ES2200L		
	FA239 (02239)		9.18"		ES411L	ES411R	
	FA337 (02337)		9.18"		ES411L	ES411R	
	FF931 (02226)		5.44"		ES423L	ES423R	
	FF961 (02ARA)		5.44"		ES423L	ES423R	
	I120S (02ADD)		5.44"			ES423R	
	I120S (02ADD)		5.44"		w/o 04AZA ABS Brakes,154 through 188 W.B.	ES423R	
	I120S (02ADD)		5.44"		w/1659387C91 Axle	ES423L	
	I120S (02ADD)		9.18"		w/1659688C91 Axle	ES411L	ES411R
	I120S (02ADD)		9.18"		189 W.B. and Up	ES411L	ES411R
I120S (02ADG)	5.44"		ES3217L	ES3218R			

NAVISTAR/IHC TRUCK



9300, 9400 Series (Cont'd)

Tie Rod Ends (Cont'd)

Axle Lbs. Rating	Code	Year	Length (Inches)	Notes	Tie Rod End Part No.	
					Drivers Side	Passenger Side
13,200	E-13201 (02AEG)		6.00"		ES3477	ES3476
	EFA-13F3		5.44"		ES423L	ES423R
	EFA-13F5		8.12"		ES3298L	ES3297R
	FA227 (02227)		5.44"	Rockwell FF942	ES423L	ES423R
	FA227 (02227)		5.44"	1-1/8"-18 Optional Thread		ES3312R
	FA343 (02343)		10.84"		ES3086L	ES3087R
14,000	I140S (02ADE)		5.44"	140 Through 188 W.B., 154 Through 188 W.B.	ES3217L	ES3218R
	I140S (02ADE)		9.43"	189 W.B. and Up	ES3219L	ES3220R
14,600	FG941 (02ARG)		5.44"		ES423L	ES423R
	FG941 (02ARG)		5.44"	1-1/8"-18 Optional Thread		ES3312R
16,000	FA231 (02231)		12.69"		ES3031L	ES3030R
	FA231 (02231)		5.75"		ES431L	ES431R
	FA231 (02231)		7.37"	Rockwell FL931	ES2090L	ES2091R
	I160S (02ADH)		12.69"		ES3031L	ES3030R
	I160S (02ADH)		5.75"		ES431L	ES431R
18,000	FA232 (02232)		12.69"		ES3031L	ES3030R
	FA232 (02232)		5.75"		ES431L	ES431R
	FA232 (02232)		7.37"	Rockwell FL941	ES2090L	ES2091R
	I180S (02ADJ)		12.69"		ES3031L	ES3030R
	I180S (02ADJ)		5.75"		ES431L	ES431R
	I200S (02ADK)		12.69"		ES3031L	ES3030R
20,000	I200S (02ADK)		5.75"		ES431L	ES431R

Drag Links

Axle Lbs. Rating	Code	Year	Length (inches)	Notes	Drag Link No.
				End Only, Use W/DS1020. Code 05PSA	ES2204R
			12.40"	Codes 05PRJ 3600, 05PRK 3601 (D.L. End, Use W/DS1020)	ES2091R
			16.27"	Incl. ES2091R & ES3214R	ES3214R
			24.99"	Codes 05PRJ, 05PSA	DS1020
			29.01"	Code 05PSA	DS1298
			29.20"	Code 05PRK	DS1294A
					DS1295A

9600, 9700 Series

King Bolt Sets

Axle Lbs. Rating	Code	Year	Diameter (inches)	Length (Inches)	Pin Type	Bushing	Notes	King Pin Set No.
10,800	FA341		1.611"	9.660"	1	Composite	Aluminun Axle - No Ream Bushing	80079C
12,000	EFA-12F3 (02AEA)		1.630"	9.200"	1	Composite		8631C
	EFA-12F3 (02AEA)		1.625"	9.195"	1	Metal		8631B
	EFA-12F4		1.630"	9.200"	1	Composite		8618C
	FA234 (02234)		1.607"	9.380"	2	Metal	Rockwell FF971, Kit 1300	8612B
	FA340		1.611"	9.660"	1	Composite	Aluminun Axle - No Ream Bushing	80079C
	FA340 (02340)		1.609"	9.660"	1	Metal	Single Drawkey	8581B

9600, 9700 Series (Cont'd)

King Bolt Sets (Cont'd)

Axle Lbs. Rating	Code	Year	Diameter (inches)	Length (Inches)	Pin Type	Bushing	Notes	King Pin Set No.
12,000	FA340 (02340)		1.611"	9.660"	1	Metal	Single Drawkey	8581B002
	FA340 (02340)		1.609"	9.660"	1	Nylon	Single Drawkey	8581N
	FA340 (02340)		1.611"	9.660"	1	Nylon	Single Drawkey	8581N002
	FF931 (02223)		1.794"	10.392"	2	Metal	Rockwell Kit 195	8590B
	FF941 (02226)		1.790"	10.390"	2	Composite	Rockwell Kit 1315	80063C
	FF941 (02226)		1.790"	10.390"	2	Metal		80063B
	FF961 (02ARA)		1.790"	10.390"	2	Composite	Rockwell Kit 1315	80063C
	FF961 (02ARA)		1.790"	10.390"	2	Metal		80063B
	I120 (02337)		1.609"	9.160"	2	Composite	No Ream, Double Drawkey	8610C
	I120 (02337)		1.609"	9.660"	2	Metal	Double Drawkey	8617B
	I120 (02337)		1.609"	9.660"	1	Nylon	No Ream, Single Drawkey	8581N
	I120 (02337)		1.611"	9.660"	1	Nylon	No Ream, Single Drawkey	8581N002
	I120S (02ADD)		1.921"	9.870"	2	Composite		8655C
	I120S (02ADD)		1.921"	9.870"	2	Metal		8655B
	13,200	EFA-13F5		1.625"	9.200"	1	Metal	
FA227 (02227)			1.790"	10.390"	2	Composite		80063C
FA227 (02227)			1.790"	10.390"	2	Metal		80063B
I132 (02343)			1.609"	9.160"	2	Composite	No Ream, Double Drawkey	8610C
I132 (02343)			1.609"	9.660"	2	Metal	Double Drawkey	8617B
I132 (02343)			1.609"	9.660"	1	Nylon	No Ream, Single Drawkey	8581N
14,000	I140S (02ADE)		2.046"	10.120"	2	Composite		80070C
	I140S (02ADE)		2.046"	10.120"	2	Metal		8657B
16,000	FA231 (02231)		1.999"	11.212"	2	Metal		8571B
18,000	FA232 (02232)		1.999"	11.212"	2	Metal		8571B

Tie Rod Ends

Axle Lbs. Rating	Code	Year	Length (Inches)	Notes	Tie Rod End Part No.	
					Drivers Side	Passenger Side
10,800	FA341 (02341)		9.18"		ES411L	ES411R
12,000	EFA12 (02250)		5.44"		ES423L	ES423R
	EFA-12F3		5.44"		ES423L	ES423R
	EFA-12F4		8.12"		ES3298L	ES3297R
	FA234 (02234)		10.50"	Rockwell FF971	ES2200L	ES2201R
	FA339 (02339)		5.44"	Drop End	ES2613L	ES2614R
	FA339 (02339)		9.18"	Straight End	ES411L	ES411R
	FA340 (02340)		9.18"		ES411L	ES411R
	FF931 (02223)		5.44"	1-1/8"-18 Optional Thread		ES3312R
	FF931 (02223)		5.44"		ES423L	ES423R
	FF941 (02226)		5.44"		ES423L	ES423R
	FF941 (02226)		5.44"	1-1/8"-18 Optional Thread		ES3312R
	FF961 (02ARA)		5.44"	1-1/8"-18 Optional Thread		ES3312R

NAVISTAR/IHC TRUCK



9600, 9700 Series (Cont'd)

Tie Rod Ends (Cont'd)

Axle Lbs. Rating	Code	Year	Length (Inches)	Notes	Tie Rod End Part No.	
					Drivers Side	Passenger Side
12,000	FF961 (02ARA)		5.44"		ES423L	ES423R
	I120 (02337)		5.44"	Drop End	ES2613L	ES2614R
	I120 (02337)		9.18"	Straight End	ES411L	ES411R
	I120S (02ADD)		5.44"	110 Through 158 W.B., 159 W.B. and Up/9600	ES423L	ES423R
	I120S (02ADD)		9.43"	w/04AZA ABS Brakes/9700	ES3219L	ES3220R
13,200	EFA-13F3		5.44"		ES3298L	ES423R
	EFA-13F5		8.12"		ES423L	ES423R
	FA227 (02227)		5.44"	Rockwell FL931	ES423L	ES423R
	FA227 (02227)		5.44"	1-1/8"-18 Optional Thread		ES3312R
	FA227 (02227)		5.44"	Drop End	ES2613L	ES2614R
	I132 (02343)		9.18"	Straight End	ES411L	ES411R
	I132 (02343)		9.18"			
14,000	I140S (02ADE)		5.44"	110 Thru. 158 W.B., 159 W.B. and Up/9600	ES423L	ES423R
	I140S (02ADE)		9.43"	w/04AZA ABS Brakes/9700	ES3219L	ES3220R
16,000	FA231 (02231)		12.69"		ES3031L	ES3030R
	FA231 (02231)		5.75"		ES431L	ES431R
	FA231 (02231)		7.37"	Rockwell FL941	ES2090L	ES2091R
	FA231 (02232)		12.69"		ES3031L	ES3030R
	FA231 (02232)		5.75"		ES431L	ES431R
	FA231 (02232)		7.37"	Rockwell FL941	ES2090L	ES2091R
	FA231 (02232)		7.37"			
18,000	FA231 (02231)		12.69"		ES3031L	ES3030R
	FA231 (02231)		5.75"		ES431L	ES431R
	FA231 (02231)		7.37"	Rockwell FL941	ES2090L	ES2091R
	FA231 (02232)		12.69"		ES3031L	ES3030R
	FA231 (02232)		5.75"		ES431L	ES431R
	FA231 (02232)		7.37"	Rockwell FL941	ES2090L	ES2091R
	FA231 (02232)		7.37"			
24,000	FA248 (02248)		9.18"		ES411L	ES411R

Drag Links

Axle Lbs. Rating	Code	Year	Length (inches)	Notes	Drag Link No.
				End Assembly for DS1293	ES2204R
			12.40"	Codes 05PRJ 4510, 05PSA 4518	ES2091R
			16.27"	Incl. ES2091R & ES3214R	ES3214R
			33.88"	Code 05PRJ 4501, 05PSA 4500	DS1020
					DS1293

9800 Series

King Bolt Sets

Axle Lbs. Rating	Code	Year	Diameter (inches)	Length (Inches)	Pin Type	Bushing	Notes	King Pin Set No.
12,000	FF961		1.790"	10.390"	2	Composite		80063C
	FF961		1.790"	10.390"	2	Metal		80063B
	I120S (02ADD)		1.921"	9.870"	2	Composite		8655C
	I120S (02ADD)		1.921"	9.870"	2	Metal		8655B

9800 Series (Cont'd)

King Bolt Sets (Cont'd)

Axle Lbs. Rating	Code	Year	Diameter (inches)	Length (Inches)	Pin Type	Bushing	Notes	King Pin Set No.
14,000	I140S (02ADE)		2.046"	10.120"	2	Composite		80070C
	I140S (02ADE)		2.046"	10.120"	2	Metal		8657B

Tie Rod Ends

Axle Lbs. Rating	Code	Year	Length (Inches)	Notes	Tie Rod End Part No.	
					Drivers Side	Passenger Side
12,000	FF961		5.44"	1-1/8"-18 Optional Thread	ES423L	ES3312R
	FF961		5.44"			ES423R
	I120S (02ADD)		5.44"		ES423L	ES423R
	I120S (02ADD)		9.43"		ES3219L	ES3220R
	I120S (02ADG)		5.44"		ES423L	ES423R
	I120S (02ADG)		9.43"		ES3219L	ES3220R
14,000	I140S (02ADE)		5.44"		ES423L	ES423R
	I140S (02ADE)		9.43"		ES3219L	ES3220R

Cargostar Models CO1610, CO1630, CO1710, CO1730, CO1750, CO1810, COF1810, CO1830, CO1850, CO1910, COF1910, CO1950, COF1950

King Bolt Sets

Axle Lbs. Rating	Code	Year	Diameter (inches)	Length (Inches)	Pin Type	Bushing	Notes	King Pin Set No.
6,000	FA69 (02069)		1.234"	6.750"	5	Metal	Single Drawkey	8385B
	FA74 (02074)		1.359"	7.970"	1	Composite	Single Drawkey	8577C
	FA74 (02074)		1.361"	7.970"	1	Composite	Single Drawkey	8577C002
	FA74 (02074)		1.359"	7.970"	1	Metal	Single Drawkey	8577B
7,000	FA99 (02099)		1.234"	7.656"	5	Metal	Single Drawkey	8375B
7,500	FA103 (02103)		1.359"	7.970"	1	Composite	Single Drawkey	8577C
	FA103 (02103)		1.361"	7.970"	1	Composite	Single Drawkey	8577C002
	FA103 (02103)		1.359"	7.970"	1	Metal	Single Drawkey	8577B
	FA99 (02099)		1.234"	7.656"	5	Metal	Single Drawkey	8375B
9,000	FA109 (02109)		1.484"	8.850"	2	Metal	Double Drawkey	80066B
	FA109 (02109)		1.484"	8.850"	1	Metal	Single Drawkey	8579B
	FA109 (02109)		1.486"	8.850"	1	Metal	Single Drawkey	8579B002
	FA109 (02109)		1.484"	8.850"	3	Metal		8645B
	FA209 (02209)		1.434"	8.500"	2	Metal	Double Drawkey	8519B
	FA209 (02209)		1.444"	8.500"	2	Metal	Double Drawkey	8519B010
	FA209 (02209)		1.434"	8.500"	2	Nylon	Double Drawkey	8519N
	FA309 (02309)		1.609"	9.160"	2	Composite	Double Drawkey	8610C
	FA309 (02309)		1.609"	9.160"	1	Metal	Single Drawkey	8583B
	FA309 (02309)		1.609"	9.160"	2	Metal	Double Drawkey	8610B
	FA309 (02309)		1.609"	9.160"	1	Nylon	Single Drawkey	8583N
	FA309 (02309)		1.611"	9.160"	1	Nylon	Single Drawkey	8583N002
10,800	FA329 (02329)		1.609"	9.660"	2	Metal	Double Drawkey	8567B
	FA329 (02329)		1.609"	9.660"	1	Metal	Single Drawkey	8581B

NAVISTAR/IHC TRUCK



Cargostar Models CO1610, CO1630, CO1710, CO1730, CO1750, CO1810, COF1810, CO1830, CO1850, CO1910, COF1910, CO1950, COF1950 (Cont'd)

Heavy Duty Trucks

King Bolt Sets (Cont'd)

Axle Lbs. Rating	Code	Year	Diameter (inches)	Length (Inches)	Pin Type	Bushing	Notes	King Pin Set No.	
10,800	FA329 (02329)		1.611"	9.660"	1	Metal	Single Drawkey	8581B002	
	FA329 (02329)		1.609"	9.660"	2	Nylon	Double Drawkey	8567N	
	FA329 (02329)		1.609"	9.660"	1	Nylon	Single Drawkey	8581N	
	FA329 (02329)		1.611"	9.660"	1	Nylon	Single Drawkey	8581N002	
12,000	FA139 (02139)		1.609"	9.660"	1	Metal	Single Drawkey	8581B	
	FA139 (02139)		1.611"	9.660"	1	Metal	Single Drawkey	8581B002	
	FA139 (02139)		1.609"	9.660"	1	Nylon	Single Drawkey	8581N	
	FA139 (02139)		1.611"	9.660"	1	Nylon	Single Drawkey	8581N002	
	FA219 (02219)		1.794"	9.120"	2	Metal	Double Drawkey	8489B	
	FA219 (02219)		1.794"	9.120"	2	Nylon		8489N	
	FA339 (02339)		1.609"	9.660"	2	Metal	Double Drawkey	8567B	
	FA339 (02339)		1.609"	9.660"	1	Metal	Single Drawkey	8581B	
	FA339 (02339)		1.611"	9.660"	1	Metal	Single Drawkey	8581B002	
	FA339 (02339)		1.609"	9.660"	2	Nylon	Double Drawkey	8567N	
	FA339 (02339)		1.609"	9.660"	1	Nylon	Single Drawkey	8581N	
	FA339 (02339)		1.611"	9.660"	1	Nylon	Single Drawkey	8581N002	
	16,000	FA136 (02136)		1.999"	11.040"	2	Metal	Double Drawkey	8518B
		FA136 (02136)		1.999"	11.040"	2	Nylon	Double Drawkey	8518N
FA231 (02232)			1.999"	11.212"	2	Metal	Double Drawkey	8571B	
18,000	FA232 (02232)		1.999"	11.212"	2	Metal	Double Drawkey	8571B	

Tie Rod Ends

Axle Lbs. Rating	Code	Year	Length (Inches)	Notes	Tie Rod End Part No.	
					Drivers Side	Passenger Side
6,000	FA69 (02069)		3.75"		ES235L	ES235R
	FA74 (02074)		4.45"		ES373L	ES373R
7,000	FA99 (02099)		3.75"		ES235L	ES235R
7,500	FA103 (02103)		4.45"		ES373L	ES373R
	FA99 (02099)		3.75"		ES235L	ES235R
9,000	FA109 (02109)		5.44"		ES423L	ES423R
	FA209 (02209)		4.88"		ES187L	ES187R
	FA309 (02309)		5.44"		ES423L	ES423R
10,800	FA329 (02329)		5.44"		ES423L	ES423R
12,000	FA139 (02139)		5.44"		ES423L	ES423R
	FA219 (02219)		4.88"		ES187L	ES187R
	FA339 (02339)		5.44"		ES423L	ES423R

Cargostar Models CO1610, CO1630, CO1710, CO1730, CO1750, CO1810, CO1810, CO1830, CO1850, CO1910, CO1910, CO1950, CO1950 (Cont'd)

Tie Rod Ends (Cont'd)

Axle Lbs. Rating	Code	Year	Length (Inches)	Notes	Tie Rod End Part No.	
					Drivers Side	Passenger Side
16,000	FA136 (02136)		5.75"	Rockwell Std. FH901	ES431L	ES431R
	FA231 (02231)		12.69"		ES3031L	ES3030R
	FA231 (02231)		5.75"		ES431L	ES431R
	FA231 (02231)		7.37"		ES2090L	ES2091R
18,000	FA232 (02232)		12.69"	Rockwell Std. FL931	ES3031L	ES3030R
	FA232 (02232)		5.75"		ES431L	ES431R
	FA232 (02232)		7.37"		ES2090L	ES2091R
	FA232 (02232)					

CO4000, COF4000, COT4000

King Bolt Sets

Axle Lbs. Rating	Code	Year	Diameter (inches)	Length (Inches)	Pin Type	Bushing	Notes	King Pin Set No.
9,000	FA109 (02109)		1.484"	8.530"	3	Metal	Double Drawkey	80053B
12,000	FA112 (02112)		1.607"	8.812"	2	Metal	Double Drawkey, (Center Point Steering)	8514B
	FA112 (02112)		1.607"	8.812"	2	Nylon	Double Drawkey, (Center Point Steering)	8514N
	FA119 (02119)		1.609"	9.610"	3	Metal	Double Drawkey	8503B
	FA215 (02215)		1.110"	6.250"	5	Metal	Single Drawkey	8389B
16,000	FA136 (02136)		1.999"	11.040"	2	Metal	Double Drawkey	8518B
	FA136 (02136)		1.999"	11.040"	2	Nylon		8518N
18,000	FA182 (02182)		1.999"	11.040"	2	Metal	Double Drawkey	8518B
	FA182 (02182)		1.999"	11.040"	2	Nylon		8518N

Tie Rod Ends

Axle Lbs. Rating	Code	Year	Length (Inches)	Notes	Tie Rod End Part No.	
					Drivers Side	Passenger Side
9,000	FA109 (02109)		9.18"	From 1970	ES411L	ES411R
12,000	FA112 (02112)		10.50"	(Center Point Steering)	ES2200L	ES2201R
	FA119 (2119)		9.18"	From 1970	ES411L	ES411R
	FA215 (02215)		4.88"		ES187L	ES187R
16,000	FA136 (02136)		5.75"	Rockwell Std. FH901	ES431L	ES431R
18,000	FA182 (02182)		5.75"	Rockwell Std. FL901	ES431L	ES431R

CO9670, COF9670, Eagle

King Bolt Sets

Axle Lbs. Rating	Code	Year	Diameter (inches)	Length (Inches)	Pin Type	Bushing	Notes	King Pin Set No.
10,800	FA341		1.611"	9.660"	1	Composite	Aluminum Axle - No Ream Bushing	80079C
	FA341 (02341)		1.609"	9.660"	1	Metal	Single Drawkey	8581B
	FA341 (02341)		1.609"	9.660"	1	Nylon	Single Drawkey	8581N
12,000	FA223 (02223)		1.794"	10.392"	2	Metal	Double Drawkey, Rockwell Std. FF941	8590B

CO9670, COF9670, Eagle (Cont'd)

Heavy Duty Trucks

King Bolt Sets (Cont'd)

Axle Lbs. Rating	Code	Year	Diameter (inches)	Length (Inches)	Pin Type	Bushing	Notes	King Pin Set No.
12,000	FA226 (02226)		1.794"	10.392"	2	Metal	Double Drawkey, Rockwell Std. FF931	8590B
	FA234 (02234)		1.607"	9.380"	2	Metal	Double Drawkey, Rockwell FF971 (Center F	8612B
	FA337 (02337)		1.609"	9.660"	2	Metal	Double Drawkey	8617B
	FA339 (02339)		1.609"	9.660"	2	Metal	Double Drawkey	8617B
	FA340 (02340)		1.611"	9.660"	1	Composite	Aluminun Axle - No Ream Bushing	80079C
	FA340 (02340)		1.609"	9.660"	1	Metal	Single Drawkey	8581B
	FA340 (02340)		1.609"	9.660"	1	Nylon	Single Drawkey	8581N
16,000	FA231 (02231)		1.999"	11.212"	2	Metal	Double Drawkey, Rockwell Std. FL931	8571B
18,000	FA232 (02232)		1.999"	11.212"	2	Metal	Double Drawkey, Rockwell Std. FL931	8571B
24,000	FA340 (02348)		1.609"	9.660"	1	Metal	Single Drawkey, Dual 12,000 lbs. IHC Axles	8581B
	FA340 (02348)		1.609"	9.660"	1	Nylon	Single Drawkey, Dual 12,000 lbs. IHC Axles	8581N

Tie Rod Ends

Axle Lbs. Rating	Code	Year	Length (Inches)	Notes	Tie Rod End Part No.	
					Drivers Side	Passenger Side
10,800	FA341 (02341)		9.18"		ES411L	ES411R
12,000	FA223 (02223)		5.44"	Rockwell Std. FF941	ES423L	ES423R
	FA223 (02223)		5.44"	1-1/8"-18 Optional Thread		ES3312R
	FA226 (02226)		5.44"	Rockwell Std. FF931	ES423L	ES423R
	FA226 (02226)		5.44"	1-1/8"-18 Optional Thread		ES3312R
	FA234 (02234)		10.50"	(Center Point Steering)	ES2200L	
	FA234 (02234)		10.50"	Rockwell Std. FF971 (Center Point Steering)		ES2201R
	FA337 (02337)		5.44"	Drop End	ES2613L	ES2614R
	FA337 (02337)		9.18"	Straight End	ES411L	ES411R
	FA339 (02339)		5.44"	Drop End	ES2613L	ES2614R
	FA339 (02339)		9.18"	Straight End	ES411L	ES411R
	FA340 (02340)		9.18"		ES411L	ES411R
	16,000	FA231 (02231)		12.69"		ES3031L
FA231 (02231)			5.75"		ES431L	ES431R
FA231 (02231)			7.37"	Rockwell Std. FL931	ES2090L	ES2091R
FA231 (02232)			12.69"		ES3031L	ES3030R
FA231 (02232)			5.75"		ES431L	ES431R
FA231 (02232)			7.37"	Rockwell Std. FL931	ES2090L	ES2091R
18,000	FA231 (02231)		12.69"		ES3031L	ES3030R
	FA231 (02231)		5.75"		ES431L	ES431R
	FA231 (02231)		7.37"	Rockwell Std. FL931	ES2090L	ES2091R
	FA231 (02232)		12.69"		ES3031L	ES3030R

CO9670, COF9670, Eagle (Cont'd)

Tie Rod Ends (Cont'd)

Axle Lbs. Rating	Code	Year	Length (Inches)	Notes	Tie Rod End Part No.	
					Drivers Side	Passenger Side
18,000	FA231 (02232)		5.75"	Rockwell Std. FL931	ES431L	ES431R
	FA231 (02232)		7.37"		ES2090L	ES2091R
24,000	FA340 (02340)		9.18"	Dual 12,000 lbs.	ES411L	ES411R
	FA340 (02340)		9.18"	IHC Axles	ES411L	ES411R
24,500	FA344 (02340)		9.18"		ES411L	ES411R

Drag Links

Axle Lbs. Rating	Code	Year	Length (inches)	Notes	Drag Link No.
			12.40" 16.27" 33.88"	End Only. Use w/DS1020 & DS1292A Incl. ES2091R & ES3214R Code 05PRJ 4501.05PSA 4500	ES2204R ES2091R ES3214R DS1020 DS1293

COF5870

King Bolt Sets

Axle Lbs. Rating	Code	Year	Diameter (inches)	Length (Inches)	Pin Type	Bushing	Notes	King Pin Set No.
16,000	FA231 (02231)		1.999"	11.212"	2	Metal	Double Drawkey, Rockwell Std. FH901	8571B
	FL941 (02231)		1.999"	11.212"	2	Metal		8571B
18,000	FA232 (02232)		1.999"	11.212"	2	Metal	Double Drawkey, Rockwell Std. FL931	8571B
	FL941 (02232)		1.999"	11.212"	2	Metal		8571B
20,000	FA233 (02233)		1.999"	11.212"	2	Metal	Double Drawkey, Rockwell Std. FL931	8571B
	FL941 (02233)		1.999"	11.212"	2	Metal		8571B
24,000	FA242 (02242)		1.609"	9.660"	2	Metal	Double Drawkey, Dual IHC 12,000 lbs. Axle	8567B
	FA242 (02242)		1.609"	9.660"	2	Nylon	Double Drawkey, Dual IHC 12,000 lbs. Axle	8567N
	I120 Dual (02242)		1.609"	9.160"	2	Composite	No Ream, Double Drawkey	8610C
	I120 Dual (02242)		1.609"	9.660"	2	Metal	Double Drawkey	8617B
	I120 Dual (02242)		1.609"	9.660"	1	Nylon	No Ream, Single Drawkey	8581N
	I120 Dual (02242)		1.611"	9.660"	1	Nylon	No Ream, Single Drawkey	8581N002
32,000	FA241 (02241)		1.999"	11.212"	2	Metal	Double Drawkey, Dual Rockwell Std. 16,000	8571B
	FL941 (02241)		1.999"	11.212"	2	Metal		8571B

Tie Rod Ends

Axle Lbs. Rating	Code	Year	Length (Inches)	Notes	Tie Rod End Part No.	
					Drivers Side	Passenger Side
16,000	FL941 (02231)		12.69"	Codes 02231, 02232, 02233, 02241-Rockwell Axle	ES3031L	ES3030R
	FL941 (02231)		5.75"		ES431L	ES431R
	FL941 (02231)		7.37"		ES2090L	ES2091R
	FL941 (02231)		7.37"		ES2090L	ES2091R
	FL941 (02232)		12.69"		ES3031L	ES3030R
	FL941 (02232)		5.75"		ES431L	ES431R

COF5870 (Cont'd)

Tie Rod Ends (Cont'd)

Axle Lbs. Rating	Code	Year	Length (Inches)	Notes	Tie Rod End Part No.		
					Drivers Side	Passenger Side	
16,000	FL941 (02232)		7.37"	Codes 02231, 02232, 02233, 02241-Rockwell Axle	ES2090L	ES2091R	
	FL941 (02232)		7.37"		ES2090L	ES2091R	
	FL941 (02233)		12.69"	ES3031L	ES3030R		
	FL941 (02233)		5.75"	ES431L	ES431R		
	FL941 (02233)		7.37"	ES2090L	ES2091R		
	FL941 (02233)		7.37"	Codes 02231, 02232, 02233, 02241-Rockwell Axle	ES2090L	ES2091R	
	FL941 (02233)		7.37"		ES2090L	ES2091R	
	18,000	FL941 (02231)		12.69"	Codes 02231, 02232, 02233, 02241-Rockwell Axle	ES3031L	ES3030R
FL941 (02231)			5.75"	ES431L		ES431R	
FL941 (02231)			7.37"	ES2090L		ES2091R	
FL941 (02231)			7.37"	ES2090L		ES2091R	
FL941 (02232)			12.69"	Codes 02231, 02232, 02233, 02241-Rockwell Axle	ES3031L	ES3030R	
FL941 (02232)			5.75"		ES431L	ES431R	
FL941 (02232)			7.37"	Codes 02231, 02232, 02233, 02241-Rockwell Axle	ES2090L	ES2091R	
FL941 (02232)			12.69"		ES3031L	ES3030R	
FL941 (02233)			5.75"	Codes 02231, 02232, 02233, 02241-Rockwell Axle	ES431L	ES431R	
FL941 (02233)			7.37"		ES2090L	ES2091R	
FL941 (02233)			7.37"		ES2090L	ES2091R	
FL941 (02233)			7.37"		ES2090L	ES2091R	
20,000		FL941 (02231)		12.69"	Codes 02231, 02232, 02233, 02241-Rockwell Axle	ES3031L	ES3030R
		FL941 (02231)		5.75"		ES431L	ES431R
	FL941 (02231)		7.37"	ES2090L		ES2091R	
	FL941 (02231)		7.37"	ES2090L		ES2091R	
	FL941 (02232)		12.69"	Codes 02231, 02232, 02233, 02241-Rockwell Axle	ES3031L	ES3030R	
	FL941 (02232)		5.75"		ES431L	ES431R	
	FL941 (02232)		7.37"	Codes 02231, 02232, 02233, 02241-Rockwell Axle	ES2090L	ES2091R	
	FL941 (02232)		7.37"		ES2090L	ES2091R	
	FL941 (02233)		12.69"	Codes 02231, 02232, 02233, 02241-Rockwell Axle	ES3031L	ES3030R	
	FL941 (02233)		5.75"		ES431L	ES431R	
	FL941 (02233)		7.37"		ES2090L	ES2091R	
	FL941 (02233)		7.37"		ES2090L	ES2091R	
	21,000	FDS1805 (02195)		5.75"	After 2/1983	ES3032R	ES2208R
	24,000	I120 Dual (02242)		5.44"	Drop-End Type	ES2613L	ES2614R
I120 Dual (02242)			9.18"	Codes 02242-Spicer Axle	ES411L	ES411R	
I120 Dual (02242)			9.18"	For Straight I-Beam	ES411L	ES411R	
32,000	FL941Dual (02241)		12.69"		ES3031L	ES3030R	
	FL941Dual (02241)		5.75"		ES431L	ES431R	

Heavy Duty Trucks

COF5870 (Cont'd)

Tie Rod Ends (Cont'd)

Axle Lbs. Rating	Code	Year	Length (Inches)	Notes	Tie Rod End Part No.	
					Drivers Side	Passenger Side
32,000	FL941Dual (02241)		7.37"	Codes 02231, 02232, 02233, 02241-Rockwell Axle	ES2090L	ES2091R
	FL941Dual (02241)		7.37"		ES2090L	ES2091R

Drag Links

Axle Lbs. Rating	Code	Year	Length (inches)	Notes	Drag Link No.
			29.91" 34.70"	End only for DS1299A Drag Link for DS1299A w/Sheppard M-392 Dual Power w/Gear Prisen Pump	ES2204R ES2091R DS1263 DS1299A

D400, DC400, DCF400, DCF400M, DF400, D405, DC405, DCF405, DCT405, DF405, DT405

Conventional

King Bolt Sets

Axle Lbs. Rating	Code	Year	Diameter (inches)	Length (Inches)	Pin Type	Bushing	Notes	King Pin Set No.
11,000	FA112 (02112)		1.607"	8.812"	2	Metal	Double Drawkey	8514B
	FA112 (02112)		1.607"	8.812"	2	Nylon	Double Drawkey	8514N
12,000	FA119 (02119)		1.609"	9.610"	3	Metal	Double Drawkey	8503B
	FA139 (02139)		1.609"	9.660"	2	Metal	Double Drawkey	8567B
	FA139 (02139)		1.609"	9.660"	2	Nylon	Double Drawkey	8567N
	FA215 (02215)		1.794"	9.120"	2	Metal	Double Drawkey	8489B
	FA215 (02215)		1.794"	9.120"	2	Nylon	Double Drawkey	8489N
	FA228 (02228)		1.794"	10.392"	2	Metal	Double Drawkey	8553B
16,000	FA136 (02136)		1.999"	11.040"	2	Metal	Double Drawkey	8518B
	FA136 (02136)		1.999"	11.040"	2	Nylon	Double Drawkey	8518N
18,000	FA182 (02182)		1.999"	11.040"	2	Metal	Double Drawkey	8518B
	FA182 (02182)		1.999"	11.040"	2	Nylon	Double Drawkey	8518N

Tie Rod Ends

Axle Lbs. Rating	Code	Year	Length (Inches)	Notes	Tie Rod End Part No.	
					Drivers Side	Passenger Side
11,000	FA112 (02112)		9.18"	From Chassis No. G297629, Y17,500,	ES411L	ES411R
12,000	FA119 (02119)		9.18"	From Chassis No. G297629, Y17,500,	ES411L	ES411R
	FA139 (02139)		9.18"		ES411L	ES411R
	FA215 (02215)		4.88"		ES187L	ES187R
	FA218 (02218)		4.88"		ES187L	ES187R
	FA228 (02228)		5.44"		1-1/8"-18 Optional Thread	ES3312R
	FA228 (02228)		5.44"		Rockwell Std. FF921	ES423L
16,000	FA136 (02136)		5.75"	Rockwell Std. FH901	ES431L	ES431R
	FA228 (02228)		5.44"		ES423L	ES423R
18,000	FA182 (02182)		5.75"	Rockwell Std. FL901	ES431L	ES431R

Fleetstar Models 1900, F1900, T1900, 1910A, F1900A, 1950, F1950, T1950, 2000, F2000, T2000, 2010A, F2010A, 2050A, F2050A, 2070A, F2070A, 2110A

King Bolt Sets

Axle Lbs. Rating	Code	Year	Diameter (inches)	Length (Inches)	Pin Type	Bushing	Notes	King Pin Set No.
7,000	FA91 (02091)		1.234"	7.656"	5	Metal	Single Drawkey	8375B
	FA98 (02098)		1.234"	7.656"	5	Metal	Single Drawkey	8375B
7,500	FA101 (02101)		1.359"	7.970"	1	Composite	Single Drawkey	8577C
	FA101 (02101)		1.361"	7.970"	1	Composite	Single Drawkey	8577C002
	FA101 (02101)		1.359"	7.970"	1	Metal	Single Drawkey	8577B
	FA101 (02101)		1.360"	7.970"	2	Metal		8637B
	FA91 (02091)		1.234"	7.656"	5	Metal	Single Drawkey	8375B
	FA98 (02098)		1.234"	7.656"	5	Metal	Single Drawkey	8375B
9,000	FA105 (02105)		1.434"	8.500"	2	Metal	Double Drawkey	8519B
	FA105 (02105)		1.444"	8.500"	2	Metal	Double Drawkey	8519B010
	FA105 (02105)		1.434"	8.500"	2	Nylon	Double Drawkey	8519N
	FA109 (02109)		1.484"	8.850"	2	Metal	Double Drawkey	80066B
	FA109 (02109)		1.484"	8.850"	1	Metal	Single Drawkey	8579B
	FA109 (02109)		1.486"	8.850"	1	Metal	Single Drawkey	8579B002
	FA109 (02109)		1.484"	8.850"	3	Metal	Double Drawkey	8645B
	FA309 (02309)		1.609"	9.660"	2	Metal	Double Drawkey	8567B
	FA309 (02309)		1.609"	9.160"	1	Metal	Single Drawkey	8583B
	FA309 (02309)		1.609"	9.660"	2	Nylon	Double Drawkey	8567N
	FA309 (02309)		1.609"	9.160"	1	Nylon	Single Drawkey	8583N
	FA309 (02309)		1.611"	9.160"	1	Nylon	Single Drawkey	8583N002
	10,800	FA329 (02329)		1.609"	9.660"	2	Metal	Double Drawkey
FA329 (02329)			1.609"	9.660"	1	Metal	Single Drawkey	8581B
FA329 (02329)			1.611"	9.660"	1	Metal	Single Drawkey	8581B002
FA329 (02329)			1.609"	9.660"	2	Nylon	Double Drawkey	8567N
FA329 (02329)			1.609"	9.660"	1	Nylon	Single Drawkey	8581N
FA329 (02329)			1.611"	9.660"	1	Nylon	Single Drawkey	8581N002
12,000	FA112 (02112)		1.607"	8.812"	2	Metal	Double Drawkey, (Center Point Steering)	8514B
	FA112 (02112)		1.607"	8.812"	2	Nylon	Double Drawkey, (Center Point Steering)	8514N
	FA119 (02119)		1.609"	9.610"	3	Metal	Double Drawkey	8503B
	FA139 (02139)		1.609"	9.660"	2	Metal	Double Drawkey	8567B
	FA139 (02139)		1.609"	9.660"	1	Metal	Single Drawkey	8581B
	FA139 (02139)		1.611"	9.660"	1	Metal	Single Drawkey	8581B002
	FA139 (02139)		1.609"	9.660"	2	Nylon	Double Drawkey	8567N
	FA139 (02139)		1.609"	9.660"	1	Nylon	Single Drawkey	8581N
	FA139 (02139)		1.611"	9.660"	1	Nylon	Single Drawkey	8581N002
	FA139 (02139)		1.609"	9.660"	1	Nylon	Single Drawkey	8581N

Fleetstar Models 1900, F1900, T1900, 1910A, F1900A, 1950, F1950, T1950, 2000, F2000, T2000, 2010A, F2010A, 2050A, F2050A, 2070A, F2070A, 2110A (Cont'd)

King Bolt Sets (Cont'd)

Axle Lbs. Rating	Code	Year	Diameter (inches)	Length (Inches)	Pin Type	Bushing	Notes	King Pin Set No.
12,000	FA211 (02211)		1.794"	9.120"	2	Metal	Double Drawkey	8489B
	FA211 (02211)		1.794"	9.120"	2	Nylon		8489N
	FA215 (02215)		1.794"	9.120"	2	Metal	Double Drawkey	8489B
	FA215 (02215)		1.794"	9.120"	2	Nylon		8489N
	FA228 (02228)		1.794"	10.392"	2	Metal	Double Drawkey	8553B
	FA339 (02339)		1.609"	9.660"	2	Metal	Double Drawkey	8567B
	FA339 (02339)		1.609"	9.660"	1	Metal	Single Drawkey	8581B
	FA339 (02339)		1.611"	9.660"	1	Metal	Single Drawkey	8581B002
	FA339 (02339)		1.609"	9.660"	2	Nylon	Double Drawkey	8567N
	FA339 (02339)		1.609"	9.660"	1	Nylon	Single Drawkey	8581N
	FA339 (02339)		1.611"	9.660"	1	Nylon	Single Drawkey	8581N002
	16,000	FA136 (02136)		1.999"	11.040"	2	Metal	Double Drawkey
FA136 (02136)			1.999"	11.040"	2	Nylon	Double Drawkey	8518N
FA231 (02231)			1.999"	11.212"	2	Metal	Double Drawkey	8571B
FA232 (02232)			1.999"	11.212"	2	Metal	Double Drawkey, Rockwell Std. FL931	8571B
18,000	FA182 (02182)		1.999"	11.040"	2	Metal	Double Drawkey	8518B
	FA182 (02182)		1.999"	11.040"	2	Nylon	Double Drawkey	8518N

Tie Rod Ends

Axle Lbs. Rating	Code	Year	Length (Inches)	Notes	Tie Rod End Part No.	
					Drivers Side	Passenger Side
7,000	FA91 (02091)		3.75"		ES235L	ES235R
	FA98 (02098)		3.75"		ES235L	ES235R
7,500	FA101 (02101)		4.45"		ES373L	ES373R
	FA91 (02091)		3.75"		ES235L	ES235R
	FA98 (02098)		3.75"		ES235L	ES235R
9,000	FA105 (02105)		4.88"	Rockwell Std. FD900	ES187L	ES187R
	FA109 (02109)		9.18"		ES411L	ES411R
	FA309 (02309)		9.18"		ES411L	ES411R
10,800	FA329 (02329)		9.18"		ES411L	ES411R
12,000	FA112 (02112)		10.50"	Will Retrofit Older Axles. Rockwell FE970 (Center Point Steering)	ES2200L	ES2201R
	FA112 (02112)		4.88"	(Center Point Steering)	ES187L	ES187R
	FA112 (02112)		5.75"	(Center Point Steering)	ES431L	ES431R
	FA119 (02119)		9.18"		ES411L	ES411R
	FA139 (02139)		9.18"		ES411L	ES411R
	FA211 (02211)		4.88"		ES187L	ES187R

NAVISTAR/IHC TRUCK



Fleetstar Models 1900, F1900, T1900, 1910A, F1900A, 1950, F1950, T1950, 2000, F2000, T2000, 2010A, F2010A, 2050A, F2050A, 2070A, F2070A, 2110A (Cont'd)

Tie Rod Ends (Cont'd)

Axle Lbs. Rating	Code	Year	Length (Inches)	Notes	Tie Rod End Part No.	
					Drivers Side	Passenger Side
12,000	FA215 (02215)		4.88"		ES187L	ES187R
	FA228 (02228)		5.44"	Rockwell Std. FF921	ES423L	ES423R
	FA228 (02228)		5.44"	1-1/8"-18 Optional Thread		ES3312R
	FA339 (02339)		9.18"		ES411L	ES411R
16,000	FA136 (02136)		5.75"	Rockwell Std. FH901	ES431L	ES431R
	FA231 (02231)		7.37"	Rockwell Std. FH901	ES2090L	ES2091R
18,000	FA182 (02182)		5.75"	Rockwell Std. FL901	ES431L	ES431R
	FA232 (02232)		7.37"	Rockwell Std. FL931	ES2090L	ES2091R

Drag Links

Axle Lbs. Rating	Code	Year	Length (inches)	Notes	Drag Link No.
7.000	FA98 (2098)		15.27"	w/Power Steering Except	DS963
7.500	FA101 (2101)		15.27"	w/Power Steering Except	DS963
9.000	FA109 (02109)		15.28"	w/Power Steering For Gear Codes .05320,05326,05329,05322	DS973
	FA109 (2109)		15.27"	w/Power Steering Except	DS963
	FA309 (02309)		15.28"	w/Power Steering For Gear Codes .05320,05326,05329,05322	DS973
10.800	FA329 (02329)		14.45"	w/Power Steering For Gear Codes .05320,05326,05329,05322	DS976
12.000	FA139 (02139)		14.45"	w/Steering Gear Codes 05321,05323	DS974
			15.28"		DS973
	FA339 (02339)		14.45"	w/Power Steering For Gear Codes 05321,05323 w/Power Steering For Gear Codes .05320,05326,05329,05322	DS976
16.000	FA136 (2136)		15.27"	Exc. Steering Gear Codes 05290,5291	DS963

Loadstar & School Bus Models 1600, 1700, 1750, 1800, 1850, 1890, F1600, F1700, F1800, F1850, CO1600, CO1700, CO1750, CO1800, CO1850

King Bolt Sets

Axle Lbs. Rating	Code	Year	Diameter (inches)	Length (Inches)	Pin Type	Bushing	Notes	King Pin Set No.
4,700	FA48 (02048)		1.110"	6.250"	5	Metal	Single Drawkey	8389B
	FA48 (02048)		1.125"	6.250"	5	Metal	Single Drawkey	8441B
5,000	FA68 (02068)		1.234"	6.750"	5	Metal	Single Drawkey	8385B
	FA68 (02068)		1.249"	6.750"	5	Metal		8385B015
	FA71 (02071)		1.359"	7.970"	1	Composite	Single Drawkey	8577C
	FA71 (02071)		1.361"	7.970"	1	Composite	Single Drawkey	8577C002
	FA71 (02071)		1.360"	7.970"	2	Composite	Double Drawkey	8637C
	FA71 (02071)		1.359"	7.970"	1	Metal	Single Drawkey	8577B
	FA71 (02071)		1.369"	7.970"	1	Metal		8577B010
	FA71 (02071)		1.360"	7.970"	2	Metal	Double Drawkey	8637B
5,500	FA68 (02072)		1.249"	6.750"	5	Metal		8385B015
	FA72 (02072)		1.234"	6.750"	5	Metal	Single Drawkey	8385B
	FA89 (02089)		1.234"	7.656"	5	Metal	Single Drawkey	8375B
6,000	FA73 (02073)		1.359"	7.970"	1	Composite	Single Drawkey	8577C
	FA73 (02073)		1.361"	7.970"	1	Composite	Single Drawkey	8577C002
	FA73 (02073)		1.360"	7.970"	2	Composite	Double Drawkey	8637C
	FA73 (02073)		1.359"	7.970"	1	Metal	Single Drawkey	8577B
	FA73 (02073)		1.360"	7.970"	2	Metal	Double Drawkey	8637B
7,000	FA91 (02091)		1.234"	7.656"	5	Metal	Single Drawkey	8375B
	FA91 (02091)		1.234"	6.750"	5	Metal		8385B
	FA98 (02098)		1.234"	7.656"	5	Metal	Single Drawkey	8375B
7,500	FA101 (02101)		1.359"	7.970"	1	Composite	Single Drawkey	8577C
	FA101 (02101)		1.361"	7.970"	1	Composite	Single Drawkey	8577C002
	FA101 (02101)		1.360"	7.970"	2	Composite	Double Drawkey	8637C
	FA101 (02101)		1.359"	7.970"	1	Metal	Single Drawkey	8577B
	FA101 (02101)		1.359"	7.970"	1	Metal	Single Drawkey	8577B

Loadstar & School Bus Models 1600, 1700, 1750, 1800, 1850, 1890, F1600, F1700, F1800, F1850, CO1600, CO1700, CO1750, CO1800, CO1850 (Cont'd)

King Bolt Sets (Cont'd)

Axle Lbs. Rating	Code	Year	Diameter (inches)	Length (Inches)	Pin Type	Bushing	Notes	King Pin Set No.
7,500	FA101 (02101)		1.360"	7.970"	2	Metal	Double Drawkey	8637B
	FA91 (02091)		1.234"	7.656"	5	Metal	Single Drawkey	8375B
	FA91 (02091)		1.234"	6.750"	5	Metal		8385B
	FA98 (02098)		1.234"	7.656"	5	Metal	Single Drawkey	8375B
9,000	FA105 (02105)		1.434"	8.500"	2	Metal	Double Drawkey	8519B
	FA105 (02105)		1.444"	8.500"	2	Metal	Double Drawkey	8519B010
	FA105 (02105)		1.434"	8.500"	2	Nylon	Double Drawkey	8519N
	FA109 (02109)		1.484"	8.850"	2	Metal	Double Drawkey	80066B
	FA109 (02109)		1.484"	8.850"	1	Metal	Single Drawkey	8579B
	FA109 (02109)		1.486"	8.850"	1	Metal	Single Drawkey	8579B002
	FA109 (02109)		1.484"	8.850"	3	Metal	Double Drawkey	8645B
	FA208 (02208)		1.434"	8.500"	2	Metal	Double Drawkey	8519B
	FA208 (02208)		1.444"	8.500"	2	Metal	Double Drawkey	8519B010
	FA208 (02208)		1.434"	8.500"	2	Nylon	Double Drawkey	8519N
	FA309 (02309)		1.609"	9.660"	2	Metal	Double Drawkey	8567B
	FA309 (02309)		1.609"	9.160"	1	Metal	Single Drawkey	8583B
	FA309 (02309)		1.609"	9.660"	2	Nylon	Double Drawkey	8567N
	FA309 (02309)		1.609"	9.160"	1	Nylon	Single Drawkey	8583N
	FA309 (02309)		1.611"	9.160"	1	Nylon	Single Drawkey	8583N002
	10,500	FA329 (02329)		1.609"	9.660"	2	Metal	Double Drawkey
FA329 (02329)			1.609"	9.660"	1	Metal	Single Drawkey	8581B
FA329 (02329)			1.611"	9.660"	1	Metal	Single Drawkey	8581B002
FA329 (02329)			1.609"	9.660"	2	Nylon	Double Drawkey	8567N
FA329 (02329)			1.609"	9.660"	1	Nylon	Single Drawkey	8581N
FA329 (02329)			1.611"	9.660"	1	Nylon	Single Drawkey	8581N002
10,800	FA329 (02329)		1.609"	9.660"	2	Metal	Double Drawkey	8567B
	FA329 (02329)		1.609"	9.660"	1	Metal	Single Drawkey	8581B
	FA329 (02329)		1.611"	9.660"	1	Metal	Single Drawkey	8581B002
	FA329 (02329)		1.609"	9.660"	2	Nylon	Double Drawkey	8567N
	FA329 (02329)		1.609"	9.660"	1	Nylon	Single Drawkey	8581N
	FA329 (02329)		1.611"	9.660"	1	Nylon	Single Drawkey	8581N002
12,000	FA139 (02139)		1.609"	9.660"	2	Metal	Double Drawkey	8567B
	FA139 (02139)		1.609"	9.660"	1	Metal	Single Drawkey	8581B
	FA139 (02139)		1.611"	9.660"	1	Metal	Single Drawkey	8581B002
	FA139 (02139)		1.609"	9.660"	2	Nylon	Double Drawkey	8567N
	FA139 (02139)		1.609"	9.660"	1	Nylon	Single Drawkey	8581N
	FA139 (02139)							

NAVISTAR/IHC TRUCK



Loadstar & School Bus Models 1600, 1700, 1750, 1800, 1850, 1890, F1600, F1700, F1800, F1850, CO1600, CO1700, CO1750, CO1800, CO1850 (Cont'd)

Heavy Duty Trucks

King Bolt Sets (Cont'd)

Axle Lbs. Rating	Code	Year	Diameter (inches)	Length (Inches)	Pin Type	Bushing	Notes	King Pin Set No.	
12,000	FA139 (02139)		1.611"	9.660"	1	Nylon	Single Drawkey	8581N002	
	FA215 (02215)		1.794"	9.120"	2	Metal	Double Drawkey	8489B	
	FA215 (02215)		1.794"	9.120"	2	Nylon	Double Drawkey	8489N	
	FA218 (02218)		1.794"	9.120"	2	Metal	Double Drawkey	8489B	
	FA218 (02218)		1.794"	9.120"	2	Nylon	Double Drawkey	8489N	
	FA228 (02228)		1.794"	10.392"	2	Metal	Double Drawkey	8553B	
	FA339 (02339)		1.609"	9.660"	2	Metal	Double Drawkey	8567B	
	FA339 (02339)		1.609"	9.660"	1	Metal	Single Drawkey	8581B	
	FA339 (02339)		1.611"	9.660"	1	Metal	Single Drawkey	8581B002	
	FA339 (02339)		1.609"	9.660"	2	Nylon	Double Drawkey	8567N	
	FA339 (02339)		1.609"	9.660"	1	Nylon	Single Drawkey	8581N	
	FA339 (02339)		1.611"	9.660"	1	Nylon	Single Drawkey	8581N002	
	16,000	FA136 (02136)		1.999"	11.040"	2	Metal	Double Drawkey	8518B
		FA136 (02136)		1.999"	11.040"	2	Nylon	Double Drawkey	8518N

Tie Rod Ends

Axle Lbs. Rating	Code	Year	Length (Inches)	Notes	Tie Rod End Part No.	
					Drivers Side	Passenger Side
4,700	FA48 (02048)		3.55"		ES26R	ES26L
5,000	FA68 (02068) FA71 (02071)		3.75"		ES235L	ES235R
			4.45"		ES373L	ES373R
5,500	FA72 (02072) FA89 (02089)		3.75"		ES235L	ES235R
			3.75"		ES235L	ES235R
6,000	FA73 (02073)		4.45"	A648	ES373L	ES373R
7,000	FA91 (02091) FA98 (02098)		3.75"		ES235L	ES235R
			3.75"		ES235L	ES235R
7,500	FA101 (02101) FA91 (02091) FA98 (02098)		4.45"		ES373L	ES373R
			3.75"		ES235L	ES235R
			3.75"		ES235L	ES235R
9,000	FA105 (02105) FA109 (02109) FA208 (02208) FA309 (02309)		4.88"	Rockwell Std. FD900	ES187L	ES187R
			9.18"		ES411L	ES411R
			4.88"		ES187L	ES187R
			9.18"		ES411L	ES411R
10,500	FA329 (02329)		9.18"		ES411L	ES411R
10,800	FA329 (02329)		9.18"		ES411L	ES411R
12,000	FA139 (02139)		9.18"		ES411L	ES411R

Loadstar & School Bus Models 1600, 1700, 1750, 1800, 1850, 1890, F1600, F1700, F1800, F1850, CO1600, CO1700, CO1750, CO1800, CO1850 (Cont'd)

Tie Rod Ends (Cont'd)

Axle Lbs. Rating	Code	Year	Length (Inches)	Notes	Tie Rod End Part No.	
					Drivers Side	Passenger Side
12,000	FA215 (02215)		4.88"		ES187L	ES187R
	FA218 (02218)		4.88"		ES187L	ES187R
	FA228 (02228)		5.44"	1-1/8"-18 Optional Thread		ES3312R
	FA228 (02228)		5.44"	Rockwell Std. FF921	ES423L	ES423R
	FA339 (02339)		9.18"		ES411L	ES411R
16,000	FA136 (02136)		5.75"	Rockwell Std. FH901	ES431L	ES431R

Drag Links

Axle Lbs. Rating	Code	Year	Length (inches)	Notes	Drag Link No.	
5,000	FA71 (02071)		14.44"	w/05165, 05277, 05299 Steering Gear Codes	DS977	
6,000	FA73 (02073)		14.44"	w/05165, 05277, 05299 Steering Gear Codes	DS977	
7,000	FA98 (02098)		14.13"	w/05031, 05063, 05276, 05299 Steering Gear Codes w/05276, 05299 Strg. Gear Codes	DS969	
			14.75"	w/05031, 05063, 05276, 05299 Steering Gear Codes w/05031, 05063 Strg. Gear Codes	DS970	
7,500	FA101 (02101)		14.75"	w/05031, 05063, 05276, 05299 Steering Gear Codes	DS970	
9,000	FA109 (02109)		14.80"	w/05031, 05063, 05261, 05277, 05301, 05302 Strg. Gear Codes w/05031, 05063, 05261, 05277, w/05031, 05063, 05261, 05277, 05301, 05302 Strg. Gear Codes	DS971	
			15.28"	w/05031, 05063, 05261, 05277, 05301, 05302 Strg. Gear Codes	DS973	
			14.08"	05301, 05302 Strg. Gear Codes	DS972	
			14.45"	w/05031, 05063 Strg. Gear Codes 05301, 05302 Strg. Gear Codes	DS974	
			14.80"	w/05261, 05277, 05301, 05302 Strg. Gear Codes Exc. Flotation Tires w/05031, 05063, 05261, 05277, 05301, 05302 Strg. Gear Codes	DS971	
		FA208 (02208)		15.28"	w/05031, 05063, 05261, 05277, w/05031, 05063, 05261, 05277, 05301, 05302 Steering Gear Codes	DS973
			14.80"	w/05031, 05063 Strg. Gear Codes	DS971	
			15.28"	05301, 05302 Strg. Gear Codes	DS973	
			14.80"	w/05031, 05063 Strg. Gear Codes	DS971	
			15.28"	05301, 05302 Strg. Gear Codes	DS973	
10,800	FA329 (02329)		14.45"		DS976	
			14.80"	w/05261, 05277, 05301, 05302 Steering Gear Codes	DS971	
12,000	FA139 (02139)		14.45"		DS976	
			14.80"	w/05261, 05277, 05301, 05302 Steering Gear Codes	DS971	
	FA339 (02339)		14.45"		DS976	
			14.80"	w/05261, 05277, 05301, 05302 Steering Gear Codes	DS971	

M1400, M1600, 1452, 1652 Series Medium Duty

King Bolt Sets

Axle Lbs. Rating	Code	Year	Diameter (inches)	Length (Inches)	Pin Type	Bushing	Notes	King Pin Set No.
6,000	I60 (92ADA)		1.359"	7.970"	1	Composite	No Ream, Single Drawkey	8577C
	I60 (92ADA)		1.361"	7.970"	1	Composite	No Ream, Double Drawkey	8577C002
	I60 (92ADA)		1.360"	7.970"	2	Composite	No Ream, Double Drawkey	8637C
	I60 (92ADA)		1.359"	7.970"	1	Metal	Single Drawkey	8577B
	I60 (92ADA)		1.360"	7.970"	2	Metal	Double Drawkey	8637B
8,000	I80 (02ABD)		1.359"	7.970"	1	Composite	No Ream, Single Drawkey	8577C
	I80 (02ABD)		1.361"	7.970"	1	Composite	No Ream, Double Drawkey	8577C002
	I80 (02ABD)		1.360"	7.970"	2	Composite	No Ream, Double Drawkey	8637C
	I80 (02ABD)		1.359"	7.970"	1	Metal	Single Drawkey	8577B
	I80 (02ABD)		1.360"	7.970"	2	Metal	Double Drawkey	8637B
10,000	I100S (02ADC)		1.921"	9.870"	2	Composite		8655C
	I100S (02ADC)		1.921"	9.870"	2	Metal		8655B

M1400, M1600, 1452, 1652 Series Medium Duty (Cont'd)

Heavy Duty Trucks

King Bolt Sets (Cont'd)

Axle Lbs. Rating	Code	Year	Diameter (inches)	Length (Inches)	Pin Type	Bushing	Notes	King Pin Set No.
12,000	I120S (02ADD)		1.921"	9.870"	2	Composite		8655C
	I120S (02ADD)		1.921"	9.870"	2	Metal		8655B
14,000	I140S (02ADE)		2.046"	10.120"	2	Composite		80070C
	I140S (02ADE)		2.046"	10.120"	2	Metal		8657B
16,000	FA231 (02231)		1.999"	11.212"	2	Metal	Kit 198 (Rockwell)	8571B
	I160S (02ADH)		2.046"	11.000"	2	Composite		80075C
	I160S (02ADH)		2.046"	11.000"	2	Metal		80074B

Tie Rod Ends

Axle Lbs. Rating	Code	Year	Length (Inches)	Notes	Tie Rod End Part No.	
					Drivers Side	Passenger Side
6,000	I60S (92ADA)		11.89"		ES3205R	ES3204L
8,000	I80S (02ADB)		11.89"		ES3205R	ES3204L
10,000	I100S (02ADC)		5.44"	w/126" through 225" W.B.	ES423L	ES423R
			9.18"	w/226" through 280" W.B.	ES411L	ES411R
12,000	I120S (02ADD)		5.44"	w/126" through 225" W.B.	ES423L	ES423R
			9.18"	w/226" through 280" W.B.	ES411L	ES411R
			4.88"	A3144R226	ES187L	ES187R
14,000	I140S (02ADE)		5.44"		ES3217L	ES3218R
			9.43"		ES3219L	ES3220R
16,000	FA231 (02231)		12.69"		ES3031L	ES3030R
			5.75"		ES431L	ES431R
			7.37"	Rockwell FL941	ES2090L	ES2091R
			12.69"		ES3031L	ES3030R
			5.75"		ES431L	ES431R

Drag Links

Axle Lbs. Rating	Code	Year	Length (inches)	Notes	Drag Link No.
6,000	I60S (02ADA)		17.47"	w/Ross TAS40 strg	DS1215
8,000	I80S (02ADB)		17.47"	w/Ross TAS40 strg	DS1215

Paystar Models 5010, 5050, 5070, F5010, F5050, F5070, F5050SF, F5070SF, F5050SF-LW, F5070SF-LW, CO5370, COF5370

King Bolt Sets

Axle Lbs. Rating	Code	Year	Diameter (inches)	Length (Inches)	Pin Type	Bushing	Notes	King Pin Set No.
12,000	FA139 (02139)		1.609"	9.660"	2	Metal	Double Drawkey	8567B
	FA139 (02139)		1.609"	9.660"	2	Nylon	Double Drawkey	8567N
	FA339 (02339)		1.609"	9.660"	2	Metal	Double Drawkey to 1981	8567B
	FA339 (02339)		1.609"	9.660"	1	Metal	Single Drawkey	8581B
	FA339 (02339)		1.611"	9.660"	1	Metal	Single Drawkey	8581B002

Paystar Models 5010, 5050, 5070, F5010, F5050, F5070, F5050SF, F5070SF, F5050SF-LW, F5070SF-LW, CO5370, COF5370 (Cont'd)

Heavy Duty Trucks

King Bolt Sets (Cont'd)

Axle Lbs. Rating	Code	Year	Diameter (inches)	Length (Inches)	Pin Type	Bushing	Notes	King Pin Set No.
12,000	FA339 (02339)		1.609"	9.660"	2	Metal	Double Drawkey from 1981	8617B
	FA339 (02339)		1.609"	9.660"	2	Nylon	Double Drawkey to 1981	8567N
	FA339 (02339)		1.609"	9.660"	1	Nylon	Single Drawkey	8581N
	FA339 (02339)		1.611"	9.660"	1	Nylon	Single Drawkey	8581N002
	I120 (02339)		1.609"	9.160"	2	Composite	No Ream, Double Drawkey	8610C
	I120 (02339)		1.609"	9.660"	2	Metal	Double Drawkey	8617B
	I120 (02339)		1.609"	9.660"	1	Nylon	No Ream, Single Drawkey	8581N
	I120 (02339)		1.611"	9.660"	1	Nylon	No Ream, Single Drawkey	8581N002
	16,000	FA136 (02136)		1.999"	11.040"	2	Metal	Double Drawkey, Rockwell Std. FH901, To
FA136 (02136)			1.999"	11.040"	2	Nylon	Double Drawkey, Rockwell Std. FH901, To	8518N
FA231 (02231)			1.999"	11.212"	2	Metal		8571B
FA231 (02231)			1.999"	11.212"	2	Metal	Double Drawkey, Rockwell Std. FH901 to 19	8571B
I160S (02ADH)			2.046"	11.000"	2	Composite		80075C
I160S (02ADH)			2.046"	11.000"	2	Composite		80075C
I160S (02ADH)			2.046"	11.000"	2	Metal		80074B
18,000		FA182 (02182)		1.999"	11.040"	2	Metal	Double Drawkey, Rockwell Std. FL901
	FA182 (02182)		1.999"	11.040"	2	Nylon	Double Drawkey, Rockwell Std. FL901	8518N
	FA232 (02232)		1.999"	11.212"	2	Metal	Kit 1312 From 2/1981, Rockwell FL941	8571B
	FA232 (02232)		1.999"	11.212"	2	Metal	Double Drawkey, Rockwell Std. FL931	8571B
	FA238 (02238)		1.999"	11.212"	2	Metal	Kit 1312 From 2/1981, Rockwell FL941	8571B
	FA238 (02238)		1.999"	11.212"	2	Metal	Double Drawkey, Rockwell Std. FL931	8571B
	I180S (02ADJ)		2.046"	11.000"	2	Composite		80075C
	I180S (02ADJ)		2.046"	11.000"	2	Metal		80074B
	20,000	FA183 (02183)		1.999"	11.040"	2	Metal	Double Drawkey, Rockwell Std. FL901
FA183 (02183)			1.999"	11.040"	2	Nylon	Double Drawkey, Rockwell Std. FL901	8518N
FA233 (02233)			1.999"	11.212"	2	Metal	Double Drawkey, Rockwell Std. FL931	8571B
FA233 (02233)			1.999"	11.212"	2	Metal	Kit 1312 From 2/1981, Rockwell FL941	8571B
FA239 (02239)			1.999"	11.212"	2	Metal	Double Drawkey, Rockwell Std. FL931	8571B
FA239 (02239)			1.999"	11.212"	2	Metal	Kit 1312 From 2/1981, Rockwell FL941	8571B
I200S (02ADK)			2.046"	11.000"	2	Composite		80075C
I200S (02ADK)			2.046"	11.000"	2	Metal		80074B

Tie Rod Ends

Axle Lbs. Rating	Code	Year	Length (Inches)	Notes	Tie Rod End Part No.	
					Drivers Side	Passenger Side
12,000	FA136 (02136)		12.69"		ES3031L	ES3030R
	FA136 (02136)		5.75"		ES431L	ES431R
	FA136 (02136)		7.37"		ES2090L	ES2091R

NAVISTAR/IHC TRUCK



Paystar Models 5010, 5050, 5070, F5010, F5050, F5070, F5050SF, F5070SF, F5050SF-LW, F5070SF-LW, CO5370, COF5370 (Cont'd)

Tie Rod Ends (Cont'd)

Axle Lbs. Rating	Code	Year	Length (Inches)	Notes	Tie Rod End Part No.	
					Drivers Side	Passenger Side
12,000	FA139 (02139)		9.18"		ES411L	ES411R
	FA339 (02339)		9.18"		ES411L	ES411R
	I120 (02339)		9.18"		ES411L	ES411R
16,000	FA231 (02231)		12.69"		ES3031L	ES3030R
	FA231 (02231)		5.75"		ES431L	ES431R
	FA231 (02231)		7.37"		ES2090L	ES2091R
	I160S (02ADH)		12.69"		ES3031L	ES3030R
	I160S (02ADH)		5.75"		ES431L	ES431R
18,000	FA182 (02182)		5.75"	Rockwell Std. FL901	ES431L	ES431R
	FA194 (02194)		5.75"	Rockwell FDS1807 Until 7/1982	ES3032R	ES2208R
	FA232 (02232)		12.69"		ES3031L	ES3030R
	FA232 (02232)		5.75"		ES431L	ES431R
	FA232 (02232)		7.37"		ES2090L	ES2091R
	FA238 (02238)		12.69"		ES3031L	ES3030R
	FA238 (02238)		5.75"		ES431L	ES431R
	FA238 (02238)		7.37"		ES2090L	ES2091R
	I180S (02ADJ)		12.69"		ES3031L	ES3030R
	I180S (02ADJ)		5.75"		ES431L	ES431R
	20,000	FA183 (02183)		5.75"	Rockwell Std. FL901	ES431L
FA233 (02233)			12.69"		ES3031L	ES3030R
FA233 (02233)			5.75"		ES431L	ES431R
FA233 (02233)			7.37"	Rockwell Std. FL931	ES2090L	ES2091R
FA239 (02239)			12.69"		ES3031L	ES3030R
FA239 (02239)			5.75"		ES431L	ES431R
FA239 (02239)			7.37"		ES2090L	ES2091R
I200S (02ADK)			12.69"		ES3031L	ES3030R
I200S (02ADK)			5.75"		ES431L	ES431R
21,000	FA196 (02196)		5.75"	Rockwell FDS1808 Until 7/1982; A13144E551 From 7/1982	ES2208R	
	FA196 (02196)		5.75"	Rockwell FDS1808 Until 7/1982; A13144E551 From 7/1982	ES3032R	
	FA196 (02ERA)		5.75"	A3144J296	ES3032R	ES2208R

RE Series, Bus

Tie Rod Ends

Axle Lbs. Rating	Code	Year	Length (Inches)	Notes	Tie Rod End Part No.	
					Drivers Side	Passenger Side
12,000			7.38"		ES3443L	ES3442R
14,000			7.38"		ES3443L	ES3442R

S Series Heavy Duty Models 2275, F2275, 2276, F2276, 2375, F2375, 2524, F2524, 2554, F2554, 2574, F2574, 2575, F2575, 2624, F2624, F2654, 2674, F2674, 2675, F2675

King Bolt Sets

Axle Lbs. Rating	Code	Year	Diameter (inches)	Length (Inches)	Pin Type	Bushing	Notes	King Pin Set No.
7,000	FA97 (02097)		1.234"	7.656"	5	Metal	Single Drawkey	8375B
9,000	FA309 (02309)		1.609"	9.160"	2	Composite	Double Drawkey	8610C
	FA309 (02309)		1.609"	9.160"	1	Metal	Single Drawkey	8583B
	FA309 (02309)		1.609"	9.160"	2	Metal	Double Drawkey	8610B
	FA309 (02309)		1.609"	9.660"	2	Metal	Double Drawkey From 8/1981	8617B
	FA309 (02309)		1.609"	9.160"	1	Nylon	Single Drawkey	8583N
	FA309 (02309)		1.611"	9.160"	1	Nylon	Single Drawkey	8583N002
	I90 (02309)		1.609"	9.160"	2	Composite	From 2/1981, No Ream, Double Drawkey	8610C
	I90 (02309)		1.609"	9.160"	2	Metal	From 2/1981	8610B
	I90 (02309)		1.609"	9.160"	1	Nylon	Single Drawkey	8583N
	I90 (02309)		1.611"	9.160"	1	Nylon	No Ream, Single Drawkey	8583N002
10,800	FA329 (02329)		1.609"	9.660"	2	Metal	Double Drawkey Until 8/1981	8567B
	FA329 (02329)		1.609"	9.660"	1	Metal	Single Drawkey	8581B
	FA329 (02329)		1.611"	9.660"	1	Metal	Single Drawkey	8581B002
	FA329 (02329)		1.609"	9.660"	2	Metal	Double Drawkey From 8/1981	8617B
	FA329 (02329)		1.609"	9.660"	2	Nylon	Double Drawkey Until 8/1981	8567N
	FA341 (02341)		1.611"	9.660"	1	Composite	Aluminum Axle. No Ream Bush.	80079C
	FA341 (02341)		1.609"	9.660"	1	Metal	Single Drawkey From 8/1981	8581B
	FA341 (02341)		1.611"	9.660"	1	Metal	Single Drawkey to August 1981	8581B002
	FA341 (02341)		1.609"	9.660"	1	Nylon	Single Drawkey From 8/1981	8581N
	FA341 (02341)		1.611"	9.660"	1	Nylon	No Ream, Single Drawkey	8581N002
	I108 (02329)		1.609"	9.160"	2	Composite	No Ream, Double Drawkey	8610C
	I108 (02329)		1.609"	9.660"	2	Metal	Double Drawkey	8617B
	I108 (02329)		1.609"	9.660"	1	Nylon	No Ream, Single Drawkey	8581N
	I108 (02329)		1.611"	9.660"	1	Nylon	No Ream, Single Drawkey	8581N002
12,000	EFA-12 (02250)		1.630"	9.200"	1	Composite		8618C
	EFA-12 (02250)		1.625"	9.200"	1	Metal		8647B
	FA226 (02226)		1.790"	10.390"	2	Composite		80063C
	FA226 (02226)		1.790"	10.390"	2	Metal		80063B
	FA226 (02226)		1.794"	10.392"	2	Metal	Double Drawkey	8590B
	FA226 (802226)		1.790"	10.390"	2	Composite		80063C
	FA226 (802226)		1.790"	10.390"	2	Metal		80063B
	FA226 (802226)		1.794"	10.392"	2	Metal	Double Drawkey	8590B
	FA336 (02336)		1.609"	9.660"	2	Metal		8617B
	FA337 (02337)		1.609"	9.660"	2	Metal		8617B
	FA338 (02338)		1.609"	9.660"	2	Metal	Double Drawkey	8617B
	FA339 (02339)		1.609"	9.660"	2	Metal	Double Drawkey Until 8/1981	8567B
	FA339 (02339)		1.609"	9.660"	1	Metal	Single Drawkey	8581B

S Series Heavy Duty Models 2275, F2275, 2276, F2276, 2375, F2375, 2524, F2524, 2554, F2554, 2574, F2574, 2575, F2575, 2624, F2624, F2654, 2674, F2674, 2675, F2675 (Cont'd)

King Bolt Sets (Cont'd)

Axle Lbs. Rating	Code	Year	Diameter (inches)	Length (Inches)	Pin Type	Bushing	Notes	King Pin Set No.
12,000	FA339 (02339)		1.611"	9.660"	1	Metal	Single Drawkey	8581B002
	FA339 (02339)		1.609"	9.660"	2	Metal	Double Drawkey From 8/1981	8617B
	FA339 (02339)		1.609"	9.660"	2	Nylon	Double Drawkey Until 8/1981	8567N
	FA340 (02340)		1.611"	9.660"	1	Composite	Aluminum Axle. No Ream Bush. Single Drawkey	80079C
	FA340 (02340)		1.611"	9.660"	1	Composite		80079C
	FA340 (02340)		1.609"	9.660"	1	Metal		8581B
	FA340 (02340)		1.611"	9.660"	1	Metal		8581B002
	FA340 (02340)		1.999"	11.040"	2	Nylon		8518N
	FF961 (02ARA)		1.790"	10.390"	2	Composite		80063C
	FF961 (02ARA)		1.790"	10.390"	2	Metal		80063B
13,200	FF942 (02227)		1.790"	10.390"	2	Composite	Comp. Bush. Used on FF942NX609	80063C
	FF942 (02227)		1.790"	10.390"	2	Metal		80063B
16,000	FA231 (02231)		1.999"	11.212"	2	Metal	Double Drawkey, Rockwell Std. FH901 to 8/	8571B
18,000	FA232 (02232)		1.999"	11.212"	2	Metal	Double Drawkey	8571B
20,000	FA233 (02233)		1.999"	11.212"	2	Metal	Double Drawkey	8571B
24,000	FA248 (02248)		1.609"	9.660"	1	Metal	Single Drawkey	8581B
	FA248 (02248)		1.611"	9.660"	1	Metal	Single Drawkey	8581B002
	FA248 (02248)		1.609"	9.660"	1	Nylon		8581N
	FA248 (02248)		1.611"	9.660"	1	Nylon	No Ream, Single Drawkey	8581N002

Tie Rod Ends

Axle Lbs. Rating	Code	Year	Length (Inches)	Notes	Tie Rod End Part No.	
					Drivers Side	Passenger Side
7,000	FA97 (02097)		3.75"		ES235L	ES235R
9,000	FA309 (02309)		9.18"		ES411L	ES411R
	I90 (02309)		5.44"	For Dropped I-Beam	ES2613L	ES2614R
	I90 (02309)		9.18"	For Straight I-Beam	ES411L	ES411R
10,800	FA329 (02329)		9.18"		ES411L	ES411R
	FA341 (02341)		9.18"		ES411L	ES411R
	I108 (02329)		5.44"	For Dropped I-Beam	ES2613L	ES2614R
12,000	I108 (02329)		9.18"	For Straight I-Beam	ES411L	ES411R
	EFA-12 (02250)		5.44"		ES423L	ES423R
	FA226 (02226)		5.44"		ES423L	ES423R
	FA226 (02226)		5.44"	Rockwell Std. FF931	ES423L	ES423R
	FA226 (02226)		5.44"	1-1/8"-18 Optional Thread		ES3312R
	FA336 (02336)		5.44"	For Dropped I-Beam	ES2613L	ES2614R
	FA337 (02337)		9.18"	For Straight I-Beam	ES411L	ES411R
	FA338 (02338)		5.44"	Drop-End Type	ES2613L	ES2614R
	FA339 (02339)		9.18"		ES411L	ES411R

S Series Heavy Duty Models 2275, F2275, 2276, F2276, 2375, F2375, 2524, F2524, 2554, F2554, 2574, F2574, 2575, F2575, 2624, F2624, F2654, 2674, F2674, 2675, F2675 (Cont'd)

Tie Rod Ends (Cont'd)

Axle Lbs. Rating	Code	Year	Length (Inches)	Notes	Tie Rod End Part No.	
					Drivers Side	Passenger Side
12,000	FA340 (02340)		9.18"		ES411L	ES411R
16,000	FA231 (02231)		7.37"	Rockwell Std. FH901 To 8/1981	ES2090L	ES2091R
	FA231 (02231)		7.37"	Rockwell Std. FL931 From 8/1981	ES2090L	ES2091R
	FA231 (02231)		7.37"	A3144Z546 Rockwell FL941	ES2090L	ES2091R
18,000	FA232 (02232)		7.37"		ES2090L	ES2091R
	FA232 (02232)		7.37"	Rockwell FL941; Rockwell Std. FL931	ES2090L	ES2091R
20,000	FA233 (02233)		7.37"		ES2090L	ES2091R
	FA233 (02233)		7.37"	Rockwell Std. FL931; Rockwell FL941	ES2090L	ES2091R
24,000	FA248 (02248)		9.18"		ES411L	ES411R

Drag Links

Axle Lbs. Rating	Code	Year	Length (inches)	Notes	Drag Link No.
			16.50" 16.84" 17.13" 17.37" 18.14" 32.65"	Adj. End for Set Back Axle Adj. End for Set Forward Axle End Only, Use with DS1022, DS1030, DS1031, DS1032 For Steering Codes 0508.1602, 8204; 05331.1601, 8202, 8203; 05335.9265; 05336. For Steering Code 05057.1600 For Steering Code 05344, Exc. Models F2624, F2654, F2674, Includes End 486807C For Steering Codes 05337, 05338, Exc. Models 2624, F2624, 2654, F2654, 2674, F2674 For Steering Codes 05333, 05335, 05336, Exc. Models F2625, F2654, F2674 For Steering Codes 05057, 05058, 05170, 05318, 05319, 05332, 05334, 05339, 05337, 05338, and for Models 2624, F2624, 2654, F2654, 2674, F2674	ES3216R ES3178R ES2203R DS1302 DS1034 DS1022 DS1031 DS979 DS1030

S Series Medium Duty Models 1624, 1654, 1658, 1723, 1724, 1753, 1754, 1758, 1823, 1824, 1853, 1854, 1858, 1924, F1924, 1925, 1954, F1954, 1955, 1958, 2125, F2125, 2155

King Bolt Sets

Axle Lbs. Rating	Code	Year	Diameter (inches)	Length (Inches)	Pin Type	Bushing	Notes	King Pin Set No.	
5,000	FA71 (02071)		1.359"	7.970"	1	Composite	No Ream, Single Drawkey	8577C	
	FA71 (02071)		1.361"	7.970"	1	Composite	No Ream, Double Drawkey	8577C002	
	FA71 (02071)		1.360"	7.970"	2	Composite	No Ream, Double Drawkey	8637C	
	FA71 (02071)		1.359"	7.970"	1	Metal	Single Drawkey	8577B	
	FA71 (02071)		1.360"	7.970"	2	Metal	Double Drawkey	8637B	
	I50 (02071)		1.359"	7.970"	1	Composite	No Ream, Single Drawkey	8577C	
	I50 (02071)		1.361"	7.970"	1	Composite	No Ream, Double Drawkey	8577C002	
	I50 (02071)		1.360"	7.970"	2	Composite	No Ream, Double Drawkey	8637C	
	I50 (02071)		1.359"	7.970"	1	Metal	Single Drawkey	8577B	
	I50 (02071)		1.360"	7.970"	2	Metal	Double Drawkey	8637B	
	6,000	FA73 (02073)		1.359"	7.970"	1	Composite	No Ream, Single Drawkey	8577C
		FA73 (02073)		1.361"	7.970"	1	Composite	No Ream, Double Drawkey	8577C002
FA73 (02073)			1.360"	7.970"	2	Composite	No Ream, Double Drawkey	8637C	
FA73 (02073)			1.359"	7.970"	1	Metal	Single Drawkey	8577B	
FA73 (02073)			1.360"	7.970"	2	Metal	Double Drawkey	8637B	
I60 (02073)			1.359"	7.970"	1	Composite	No Ream, Single Drawkey	8577C	
I60 (02073)			1.361"	7.970"	1	Composite	No Ream, Double Drawkey	8577C002	
I60 (02073)			1.360"	7.970"	2	Composite	No Ream, Double Drawkey	8637C	
I60 (02073)			1.359"	7.970"	1	Metal	Single Drawkey	8577B	
I60 (02073)			1.360"	7.970"	2	Metal	Double Drawkey	8637B	
7,500		FA101 (02101)		1.359"	7.970"	1	Composite	No Ream, Single Drawkey	8577C
		FA101 (02101)		1.361"	7.970"	1	Composite	No Ream, Double Drawkey	8577C002
	FA101 (02101)		1.360"	7.970"	2	Composite	No Ream, Double Drawkey	8637C	
	FA101 (02101)		1.359"	7.970"	1	Metal	Single Drawkey	8577B	
	FA101 (02101)		1.360"	7.970"	2	Metal	Double Drawkey	8637B	
	FA101 (02101)		1.360"	7.970"	2	Metal	Double Drawkey	8637B	

NAVISTAR/IHC TRUCK

S Series Medium Duty Models 1624, 1654, 1658, 1723, 1724, 1753, 1754, 1758, 1823, 1824, 1853, 1854, 1858, 1924, F1924, 1925, 1954, F1954, 1955, 1958, 2125, F2125, 2155

(Cont'd)

King Bolt Sets (Cont'd)

Axle Lbs. Rating	Code	Year	Diameter (inches)	Length (Inches)	Pin Type	Bushing	Notes	King Pin Set No.
7,500	I75 (02101)		1.359"	7.970"	1	Composite	No Ream, Single Drawkey	8577C
	I75 (02101)		1.361"	7.970"	1	Composite	No Ream, Double Drawkey	8577C002
	I75 (02101)		1.360"	7.970"	2	Composite	No Ream, Double Drawkey	8637C
	I75 (02101)		1.359"	7.970"	1	Metal	Single Drawkey	8577B
	I75 (02101)		1.360"	7.970"	2	Metal	Double Drawkey	8637B
8,000	FA104 (02104)		1.359"	7.970"	1	Composite	No Ream, Single Drawkey	8577C
	FA104 (02104)		1.361"	7.970"	1	Composite	No Ream, Double Drawkey	8577C002
	FA104 (02104)		1.360"	7.970"	2	Composite	No Ream, Double Drawkey	8637C
	FA104 (02104)		1.359"	7.970"	1	Metal	Single Drawkey	8577B
	FA104 (02104)		1.360"	7.970"	2	Metal	Double Drawkey	8637B
	I80 (02104)		1.359"	7.970"	1	Composite	No Ream, Single Drawkey	8577C
	I80 (02104)		1.361"	7.970"	1	Composite	No Ream, Double Drawkey	8577C002
	I80 (02104)		1.360"	7.970"	2	Composite	No Ream, Double Drawkey	8637C
	I80 (02104)		1.359"	7.970"	1	Metal	Single Drawkey	8577B
	I80 (02104)		1.360"	7.970"	2	Metal	Double Drawkey	8637B
9,000	FA109 (02109)		1.484"	8.850"	2	Metal	Double Drawkey	80066B
	FA109 (02109)		1.484"	8.850"	1	Metal	Single Drawkey	8579B
	FA109 (02109)		1.486"	8.850"	1	Metal	Single Drawkey	8579B002
	FA109 (02109)		1.484"	8.850"	3	Metal	Double Drawkey	8645B
	FA118 (02118)		1.609"	9.660"	2	Metal	Double Drawkey to 1981	8567B
	FA118 (02118)		1.609"	9.660"	1	Metal	Single Drawkey	8581B
	FA118 (02118)		1.609"	9.660"	2	Metal	Double Drawkey from 1981	8617B
	FA118 (02118)		1.609"	9.660"	2	Nylon	Double Drawkey to 1981	8567N
	FA118 (02118)		1.609"	9.660"	1	Nylon	Single Drawkey	8581N
	FA118 (02118)		1.611"	9.660"	1	Nylon	Single Drawkey	8581N002
	FA309 (02309)		1.609"	9.160"	2	Composite	No Ream, Double Drawkey	8610C
	FA309 (02309)		1.609"	9.160"	1	Metal	Single Drawkey	8583B
	FA309 (02309)		1.609"	9.160"	2	Metal	Double Drawkey	8610B
	FA309 (02309)		1.609"	9.160"	1	Nylon	Single Drawkey	8583N
	FA309 (02309)		1.611"	9.160"	1	Nylon	No Ream, Single Drawkey	8583N002
	I90 (02309)		1.609"	9.160"	2	Composite	No Ream, Double Drawkey Before 8/81	8610C
	I90 (02309)		1.609"	9.160"	2	Metal	Double Drawkey Before 8/81	8610B
I90 (02309)		1.609"	9.160"	1	Nylon	Single Drawkey	8583N	
I90 (02309)		1.611"	9.160"	1	Nylon	No Ream, Single Drawkey	8583N002	
10,800	FA127 (02127)		1.609"	9.660"	2	Metal	Double Drawkey to 1981	8567B
	FA127 (02127)		1.609"	9.660"	1	Metal	Single Drawkey	8581B
	FA127 (02127)		1.609"	9.660"	2	Metal	Double Drawkey from 1981	8617B
	FA127 (02127)		1.609"	9.660"	2	Nylon	Double Drawkey to 1981	8567N
	FA127 (02127)		1.609"	9.660"	1	Nylon	Single Drawkey	8581N
	FA127 (02127)		1.611"	9.660"	1	Nylon	Single Drawkey	8581N002
	FA329 (02329)		1.609"	9.660"	2	Metal	Double Drawkey	8567B

S Series Medium Duty Models 1624, 1654, 1658, 1723, 1724, 1753, 1754, 1758, 1823, 1824, 1853, 1854, 1858, 1924, F1924, 1925, 1954, F1954, 1955, 1958, 2125, F2125, 2155

(Cont'd)

King Bolt Sets (Cont'd)

Axle Lbs. Rating	Code	Year	Diameter (inches)	Length (Inches)	Pin Type	Bushing	Notes	King Pin Set No.	
10,800	FA329 (02329)		1.609"	9.660"	1	Metal	Single Drawkey	8581B	
	FA329 (02329)		1.611"	9.660"	1	Metal	Single Drawkey	8581B002	
	FA329 (02329)		1.609"	9.660"	2	Nylon	Double Drawkey	8567N	
	I108 (02329)		1.609"	9.160"	2	Composite	No Ream, Double Drawkey	8610C	
	I108 (02329)		1.609"	9.660"	2	Metal	Double Drawkey	8617B	
	I108 (02329)		1.609"	9.660"	1	Nylon	No Ream, Single Drawkey	8581N	
	I108 (02329)		1.611"	9.660"	1	Nylon	No Ream, Single Drawkey	8581N002	
	12,000	FA139 (02139)		1.609"	9.660"	2	Metal	Double Drawkey to 1981	8567B
FA139 (02139)			1.609"	9.660"	1	Metal	Single Drawkey	8581B	
FA139 (02139)			1.611"	9.660"	1	Metal	Single Drawkey	8581B002	
FA139 (02139)			1.609"	9.660"	2	Metal	Double Drawkey from 1981	8617B	
FA139 (02139)			1.609"	9.660"	2	Nylon	Double Drawkey to 1981	8567N	
FA139 (02139)			1.609"	9.660"	1	Nylon	Single Drawkey	8581N	
FA139 (02139)			1.611"	9.660"	1	Nylon	No Ream, Single Drawkey	8581N002	
FA223 (02223)			1.790"	10.390"	2	Composite	Kit 1315	80063C	
FA223 (02223)			1.790"	10.390"	2	Metal		80063B	
FA223 (02223)			1.794"	10.392"	2	Metal	Kit 195	8590B	
FA226 (02226)			1.790"	10.390"	2	Composite	Kit 1315	80063C	
FA226 (02226)			1.790"	10.390"	2	Metal		80063B	
FA226 (02226)			1.794"	10.392"	2	Metal	Double Drawkey, KIT195	8590B	
FA226 (02226)			1.794"	10.392"	2	Metal	Rockwell Standard FF941	8590B	
FA339 (02339)			1.609"	9.660"	2	Metal	Double Drawkey	8567B	
FA339 (02339)			1.609"	9.660"	1	Metal	Single Drawkey	8581B	
FA339 (02339)			1.611"	9.660"	1	Metal	Single Drawkey	8581B002	
FA339 (02339)			1.609"	9.660"	2	Nylon	Double Drawkey	8567N	
I120 (02339)			1.609"	9.160"	2	Composite	No Ream, Double Drawkey	8610C	
I120 (02339)			1.609"	9.660"	2	Metal	Double Drawkey	8617B	
I120 (02339)			1.609"	9.660"	1	Nylon	No Ream, Single Drawkey	8581N	
I120 (02339)			1.611"	9.660"	1	Nylon	No Ream, Single Drawkey	8581N002	
13,200		FA227 (02227)		1.790"	10.390"	2	Composite	Kit 1315	80063C
		FA227 (02227)		1.790"	10.390"	2	Metal		80063B
		FA227 (02227)		1.794"	10.392"	2	Metal	Kit 195	8590B
		I132 (2342)		1.609"	9.160"	2	Composite	No Ream, Double Drawkey	8610C
	I132 (2342)		1.609"	9.660"	2	Metal	Double Drawkey	8617B	
	I132 (2342)		1.609"	9.660"	1	Nylon	No Ream, Single Drawkey	8581N	
14,000	FA342 (02342)		1.609"	9.660"	1	Nylon	No Ream, Single Drawkey	8581N002	
	FA342 (02342)		1.609"	9.660"	2	Metal	Double Drawkey to 1981	8567B	
	FA342 (02342)		1.609"	9.660"	2	Metal	Double Drawkey from 1981	8617B	
	FA342 (02342)		1.609"	9.660"	2	Nylon	Double Drawkey to 1981	8567N	
16,000	FA231 (02231)		1.999"	11.212"	2	Metal	Dbl.Drawkey, Kit 198	8571B	

S Series Medium Duty Models 1624, 1654, 1658, 1723, 1724, 1753, 1754, 1758, 1823, 1824, 1853, 1854, 1858, 1924, F1924, 1925, 1954, F1954, 1955, 1958, 2125, F2125, 2155

(Cont'd)

King Bolt Sets (Cont'd)

Axle Lbs. Rating	Code	Year	Diameter (inches)	Length (Inches)	Pin Type	Bushing	Notes	King Pin Set No.
18,000	FA232 (02232)		1.999"	11.212"	2	Metal	Dbl. Drawkey, Kit 198	8571B
20,000	FA233 (02233)		1.999"	11.212"	2	Metal	Dbl. Drawkey, Kit 198	8571B

Tie Rod Ends

Axle Lbs. Rating	Code	Year	Length (Inches)	Notes	Tie Rod End Part No.	
					Drivers Side	Passenger Side
5,000	FA71 (02071) I50 (02071)		4.45"		ES373L	ES373R
			4.45"		ES373L	ES373R
6,000	FA73 (02073) I60 (02073)		4.45"		ES373L	ES373R
			4.45"		ES373L	ES373R
7,500	FA101 (02101) I75 (02010) S90 (02010) S90 (02010)		4.45"		ES373L	ES373R
			4.45"		ES373L	ES373R
			4.88"	Front Driving Axle	ES3294L	ES3216R
			4.88"	Front Driving Axle		
8,000	FA104 (02104) I80 (02104)		4.45"		ES373L	ES373R
			4.45"		ES373L	ES373R
9,000	FA109 (02109) FA109 (2109) FA118 (02118) FA242 (02309) FA309 (02309) I90 (02309) I90 (02309) I90 (02309) S90 (02064) S90 (02064) S90 (02078) S90 (02078)		9.18"		ES411L	ES411R
			5.44"	From February 1981	ES423L	ES423R
			9.18"		ES411L	ES411R
			9.18"	For Straight I-Beam	ES411L	ES411R
			9.18"		ES411L	ES411R
			10.84"	For Dropped I-Beam	ES3086L	ES3087R
			5.44"	Drop-End Type	ES2613L	ES2614R
			9.18"	For Straight I-Beam	ES411L	ES411R
			4.88"	Front Driving Axle	ES3294L	ES3216R
			4.88"	Front Driving Axle	ES3294L	ES3216R
			4.88"	Front Driving Axle		
10,800	(02329) FA127 (02127) FA329 (02329) FA337 (02329) I108 (02329) I108 (02329)		10.84"	For Dropped I-Beam	ES3086L	ES3087R
			9.18"		ES411L	ES411R
			9.18"		ES411L	ES411R
			9.18"	For Straight I-Beam	ES411L	ES411R
			5.44"	For Dropped I-Beam	ES2613L	ES2614R
			9.18"	For Straight I-Beam	ES411L	ES411R
12,000	(02339) 1120 (02337) FA139 (02139) FA226 (02226) FA339 (02339) I120 (02339) I120 (02339) SDA12 (02EYB)		10.84"	For Dropped I-Beam	ES3086L	ES3087R
			10.84"	For Dropped I-Beam	ES3086L	ES3087R
			9.18"		ES411L	ES411R
			5.44"		ES423L	ES423R
			9.18"		ES411L	ES411R
			5.44"	For Dropped I-Beam	ES2613L	ES2614R
			9.18"	For Straight I-Beam	ES411L	ES411R
			4.88"	Front Driving Axle (02082, 02083)	ES187L	ES187R
13,200	FA227 (02227) I132 (2342) I132 (2342)		5.44"		ES423L	ES423R
			10.84"	For Dropped I-Beam	ES3086L	ES3087R
			5.44"	Drop-End Type	ES2613L	ES2614R

S Series Medium Duty Models 1624, 1654, 1658, 1723, 1724, 1753, 1754, 1758, 1823, 1824, 1853, 1854, 1858, 1924, F1924, 1925, 1954, F1954, 1955, 1958, 2125, F2125, 2155 (Cont'd)

Heavy Duty Trucks

Tie Rod Ends (Cont'd)						
Axle Lbs. Rating	Code	Year	Length (Inches)	Notes	Tie Rod End Part No.	
					Drivers Side	Passenger Side
13,200	I132 (2342)		9.18"	For Straight I-Beam	ES411L	ES411R
14,000	FA342 (2342)		9.18"		ES411L	ES411R
16,000	(FL931)		12.69"		ES3031L	ES3030R
	(FL931)		5.75"		ES431L	ES431R
	(FL931)		7.37"		ES2090L	ES2091R
	(FL941)		12.69"		ES3031L	ES3030R
	(FL941)		5.75"		ES431L	ES431R
	(FL941)		7.37"		ES2090L	ES2091R
18,000	(FL931)		12.69"		ES3031L	ES3030R
	(FL931)		5.75"		ES431L	ES431R
	(FL931)		7.37"		ES2090L	ES2091R
	(FL941)		12.69"		ES3031L	ES3030R
	(FL941)		5.75"		ES431L	ES431R
	(FL941)		7.37"		ES2090L	ES2091R
	FA232 (02232)		7.37"		ES2090L	ES2091R
20,000	(FL931)		12.69"		ES3031L	ES3030R
	(FL931)		5.75"		ES431L	ES431R
	(FL931)		7.37"		ES2090L	ES2091R
	(FL941)		12.69"		ES3031L	ES3030R
	(FL941)		5.75"		ES431L	ES431R
	(FL941)		7.37"		ES2090L	ES2091R
	FA233 (02233)		7.37"		ES2090L	ES2091R

Drag Links					
Axle Lbs. Rating	Code	Year	Length (inches)	Notes	Drag Link No.
5.000	FA71 (02071) I50 (02071)		16.84"	For Steering Codes 05165, 05345	DS1034
6.000	FA73 (02073) I60 (02073)		16.84"	For Steering Codes 05165, 05345	DS1034
7.500	FA101 (02101) I75 (02101)		16.84"	For Steering Codes 05057, 05345	DS1034
	S90 (02081)		17.65"	For L.H. Drive	DS1021
8.000	FA104 (02104) I80 (02104)		16.84"		DS1034
9.000	FA109 (02109)		18.14"	For Steering Codes 05057, 05333, 05342	DS979
	FA118 (02118)				
	FA309 (02309) I90 (02309) S90 (02064,02078)		17.65"	For L.H. Drive	DS1021
10.800	FA127 (02127)		17.65"	For Steering Code 05335 w/Flotation Tires	DS1021
			18.14"	For Steering Code 05335 w/o Flotation Tires	DS979
	FA329 (02329)		17.65"	For Steering Code 05335 w/Flotation Tires '(Exc. 1853FC Model from 1981)	DS1021
			18.14"	For Steering Codes 05058, 05332, 05335 w/o Rotation Tires '(Exc. 1853FC Model fr Exc. 1853FC Model from 1981	DS979
12.000	FA139 (02139)		17.65"	For Steering Code 05335 w/Flotation Tires to 1981 or for 1600, 1700, 1800, 1900 Mc	DS1021
			18.14"	For Steering Code 05335 w/o Flotation Tires to 1981 or for 2100 Model from 1981	DS979
	FA226 (02226)		16.50"	For Code 05335.0004	DS1302
			18.14"	Rockwell FF941, FF942	DS979
	FA339 (02239)		17.65"	For Steering Code 05335 w/Flotation Tires '(Exc. 1853FC Model from 1981)	DS1021
			18.14"	For Steering Code 05335 w/o Flotation Tires '(Exc. 1853FC Model from 1981)	DS979
13.200			17.65"	For Models w/Flotation Tires from 1981 Exc. 1853FC Model	DS1021
			18.14"	For Models w/o Flotation Tires from 1981 Exc. 1853FC Model	DS979
			16.50"	For Code 05335.0004, .9265	DS1302
			17.65"	1600-1900 Models	DS1021
14.000	FA342 (02342)		17.13"	For Codes 05298, 05337	DS1022

Transtar Models 4200, F4200, 4300, F4300

King Bolt Sets

Axle Lbs. Rating	Code	Year	Diameter (inches)	Length (Inches)	Pin Type	Bushing	Notes	King Pin Set No.	
10,800	FA329 (02329)		1.609"	9.660"	2	Metal	Double Drawkey	8567B	
	FA329 (02329)		1.609"	9.660"	1	Metal	Single Drawkey	8581B	
	FA329 (02329)		1.611"	9.660"	1	Metal	Single Drawkey	8581B002	
	FA329 (02329)		1.609"	9.660"	2	Nylon	Double Drawkey	8567N	
	FA329 (02329)		1.609"	9.660"	1	Nylon	Single Drawkey	8581N	
	FA329 (02329)		1.611"	9.660"	1	Nylon	Single Drawkey	8581N002	
	FA341 (02341)		1.611"	9.660"	1	Composite	Aluminum Axle - No Ream Bush.	80079C	
	FA341 (02341)		1.609"	9.660"	1	Metal	Single Drawkey	8581B	
	FA341 (02341)		1.611"	9.660"	1	Metal	Single Drawkey	8581B002	
	FA341 (02341)		1.609"	9.660"	1	Nylon	Single Drawkey	8581N	
	FA341 (02341)		1.611"	9.660"	1	Nylon	Single Drawkey	8581N002	
	12,000	FA112 (02112)		1.607"	8.812"	2	Metal	Double Drawkey, (Center Point Steering)	8514B
		FA112 (02112)		1.607"	8.812"	2	Nylon	Double Drawkey, (Center Point Steering)	8514N
		FA139 (02139)		1.609"	9.660"	2	Metal	Double Drawkey	8567B
FA139 (02139)			1.609"	9.660"	1	Metal	Single Drawkey	8581B	
FA139 (02139)			1.611"	9.660"	1	Metal	Single Drawkey	8581B002	
FA139 (02139)			1.609"	9.660"	2	Nylon	Double Drawkey	8567N	
FA139 (02139)			1.609"	9.660"	1	Nylon	Single Drawkey	8581N	
FA139 (02139)			1.611"	9.660"	1	Nylon	Single Drawkey	8581N002	
FA218 (02218)			1.794"	9.120"	2	Metal	Double Drawkey	8489B	
FA218 (02218)			1.794"	9.120"	2	Nylon		8489N	
FA223 (02223)			1.794"	10.392"	2	Metal	Double Drawkey	8590B	
FA226 (02226)			1.794"	10.392"	2	Metal	Double Drawkey	8590B	
FA228 (02228)			1.794"	10.392"	2	Metal	Double Drawkey	8553B	
FA234 (02234)			1.607"	9.380"	2	Metal	Double Drawkey, (Center Point Steering)	8612B	
FA339 (02339)			1.609"	9.660"	2	Metal	Double Drawkey	8567B	
FA339 (02339)			1.609"	9.660"	1	Metal	Single Drawkey	8581B	
FA339 (02339)			1.611"	9.660"	1	Metal	Single Drawkey	8581B002	
FA339 (02339)			1.609"	9.660"	2	Nylon	Double Drawkey	8567N	
FA339 (02339)			1.609"	9.660"	1	Nylon	Single Drawkey	8581N	
FA339 (02339)			1.611"	9.660"	1	Nylon	Single Drawkey	8581N002	
FA340 (02340)			1.611"	9.660"	1	Composite	Aluminum Axle - No Ream Bush.	80079C	
FA340 (02340)			1.609"	9.660"	1	Metal	Single Drawkey	8581B	
FA340 (02340)			1.611"	9.660"	1	Metal	Single Drawkey	8581B002	
FA340 (02340)			1.609"	9.660"	1	Nylon	Single Drawkey	8581N	
FA340 (02340)			1.611"	9.660"	1	Nylon	Single Drawkey	8581N002	

Heavy Duty Trucks

Transtar Models 4200, F4200, 4300, F4300 (Cont'd)

King Bolt Sets (Cont'd)

Axle Lbs. Rating	Code	Year	Diameter (inches)	Length (Inches)	Pin Type	Bushing	Notes	King Pin Set No.
13,200	FA227 (02227)		1.794"	10.392"	2	Metal	Double Drawkey	8590B
16,000	FA136 (02136)		1.999"	11.040"	2	Metal	Double Drawkey	8518B
	FA136 (02136)		1.999"	11.040"	2	Nylon	Rockwell Std. FH901	8518N
	FA231 (02231)		1.999"	11.212"	2	Metal	Double Drawkey-Rockwell Std. FH901 to 19	8571B

Tie Rod Ends

Axle Lbs. Rating	Code	Year	Length (Inches)	Notes	Tie Rod End Part No.	
					Drivers Side	Passenger Side
10,800	FA329 (02329) FA341 (02341)		9.18"		ES411L	ES411R
			9.18"		ES411L	ES411R
12,000	FA112 (02112)		10.50"	Rockwell Std. FE970	ES2200L	ES2201R
	FA139 (02139)		9.18"		ES411L	ES411R
	FA218 (02218)		4.88"		ES187L	ES187R
	FA223 (02223)		5.44"	Rockwell Std. FF941	ES423L	ES423R
	FA223 (02223)		5.44"	1-1/8"-18 Optional Thread		ES3312R
	FA224 (02224)		5.44"	Rockwell Std. FF931A	ES423L	ES423R
	FA224 (02224)		5.44"	1-1/8"-18 Optional Thread		ES3312R
	FA226 (02226)		5.44"	Rockwell Std. FF931	ES423L	ES423R
	FA226 (02226)		5.44"	1-1/8"-18 Optional Thread		ES3312R
	FA228 (02228)		5.44"	1-1/8"-18 Optional Thread		ES3312R
	FA228 (02228)		5.44"	Rockwell Std. FF921	ES423L	ES423R
	FA234 (02234)		10.50"	Rockwell Std. FF971	ES2200L	ES2201R
	FA339 (02339)		9.18"		ES411L	ES411R
	FA340 (02340)		9.18"		ES411L	ES411R
13,200	FA227 (02227) FA227 (02227)		5.44"	Rockwell Std. FF932	ES423L	ES423R
			5.44"	1-1/8"-18 Optional Thread		ES3312R
16,000	FA136 (02136) FA231 (02231) FA231 (02231) FA231 (02231) FA231 (02231)		5.75"	Rockwell Std. FH901	ES431L	ES431R
			12.69"		ES3031L	ES3030R
			5.75"		ES431L	ES431R
			7.37"	Rockwell Std. FL931 From 1981	ES2090L	ES2091R
			7.37"	Rockwell Std. FH901 To 1981	ES2090L	ES2091R

Drag Links

Axle Lbs. Rating	Code	Year	Length (inches)	Notes	Drag Link No.
All	All			End Only. Used with DS1027, DS1028, DS1029	ES2204R ES2091R
10,800	All		17.88"	For Steering Codes 05331, 05293 Incl. 442354C91 End (ES2202R)	DS1028
12,000	All		17.88"	For Steering Codes 05331, 05293 Incl. 442354C91 End (ES2202R)	DS1028
16,000	All FA231 (02231)		17.88"	For Steering Codes 05331, 05293 Incl. 442354C91 End (ES2202R)	DS1028
			17.40"	Incl. 442354C91 End (ES2202R) For Axle Code 02231 w/5.1" Ball End	DS1027

Transtar Models C04070B, COF4070B, 4170, 4070B, F4070B, F4170

Drag Links

Axle Lbs. Rating	Code	Year	Length (inches)	Notes	Drag Link No.
All	All			End Only	ES2204R ES2091R
10,800			17.88"	For Steering Codes 05331, 05293 Incl. 442354C91 End (ES2202R)	DS1028
12,000			17.88"	For Steering Codes 05331, 05293 Incl. 442354C91 End (ES2202R)	DS1028
16,000			17.88"	For Steering Codes 05331, 05293 Incl. 442354C91 End (ES2202R)	DS1028

Transtar Models CO4070A, COF4070A

King Bolt Sets

Axle Lbs. Rating	Code	Year	Diameter (inches)	Length (Inches)	Pin Type	Bushing	Notes	King Pin Set No.
12,000	FA112 (02112)		1.607"	8.812"	2	Metal	Double Drawkey, (Center Point Steering)	8514B
	FA112 (02112)		1.607"	8.812"	2	Nylon	Double Drawkey, (Center Point Steering)	8514N
	FA119 (02119)		1.609"	9.610"	3	Metal	Double Drawkey	8503B
	FA139 (02139)		1.609"	9.660"	2	Metal	Double Drawkey	8567B
	FA139 (02139)		1.609"	9.660"	2	Nylon	Double Drawkey	8567N
	FA215 (02215)		1.110"	6.250"	5	Metal	Single Drawkey	8389B
	16,000	FA136 (02136)		1.999"	11.040"	2	Metal	Double Drawkey
FA136 (02136)			1.999"	11.040"	2	Nylon		8518N
18,000	FA182 (02182)		1.999"	11.040"	2	Metal	Double Drawkey	8518B
	FA182 (02182)		1.999"	11.040"	2	Nylon		8518N

Tie Rod Ends

Axle Lbs. Rating	Code	Year	Length (Inches)	Notes	Tie Rod End Part No.	
					Drivers Side	Passenger Side
12,000	FA119 (02119)		9.18"	From 1970	ES411L	ES411R
	FA139 (02139)		9.18"		ES411L	ES411R
	FA215 (02215)		4.88"		ES187L	ES187R
16,000	FA136 (02136)		5.75"	Rockwell Std. FH901	ES431L	ES431R
18,000	FA182 (02182)		5.75"	Rockwell Std. FL901	ES431L	ES431R

Transtar Models CO4070B, COF4070B, 4170, 4070B, F4070B, F4170

King Bolt Sets

Axle Lbs. Rating	Code	Year	Diameter (inches)	Length (Inches)	Pin Type	Bushing	Notes	King Pin Set No.
10,800	FA329 (02329)		1.609"	9.660"	2	Metal	Double Drawkey	8567B
	FA329 (02329)		1.609"	9.660"	1	Metal	Single Drawkey	8581B
	FA329 (02329)		1.611"	9.660"	1	Metal	Single Drawkey	8581B002
	FA329 (02329)		1.609"	9.660"	2	Nylon	Double Drawkey	8567N
	FA329 (02329)		1.609"	9.660"	1	Nylon	Single Drawkey	8581N
	FA329 (02329)		1.611"	9.660"	1	Nylon	No Ream, Single Drawkey	8581N002
	FA341 (02341)		1.611"	9.660"	1	Composite	Aluminum Axle - No Ream Bush.	80079C
	FA341 (02341)		1.609"	9.660"	1	Metal	Single Drawkey - Steel I-Beam Axle	8581B
	FA341 (02341)		1.611"	9.660"	1	Metal	Single Drawkey - Steel I-Beam Axle	8581B002
	FA341 (02341)		1.611"	9.660"	1	Metal	Single Drawkey - Steel I-Beam Axle	8581B002

Transtar Models CO4070B, COF4070B, 4170, 4070B, F4070B, F4170 (Cont'd)

King Bolt Sets (Cont'd)

Axle Lbs. Rating	Code	Year	Diameter (inches)	Length (Inches)	Pin Type	Bushing	Notes	King Pin Set No.
10,800	FA341 (02341)		1.609"	9.660"	1	Nylon	Single Drawkey - Steel I-Beam Axle	8581N
	FA341 (02341)		1.611"	9.660"	1	Nylon	Single Drawkey - Steel I-Beam Axle No Rea	8581N002
12,000	FA139 (02139)		1.609"	9.660"	2	Metal	Double Drawkey	8567B
	FA139 (02139)		1.609"	9.660"	2	Nylon	Double Drawkey	8567N
	FA228 (02228)		1.794"	10.392"	2	Metal	Double Drawkey	8553B
	FA339 (02339)		1.609"	9.660"	2	Metal	Double Drawkey	8567B
	FA339 (02339)		1.609"	9.660"	1	Metal	Single Drawkey	8581B
	FA339 (02339)		1.611"	9.660"	1	Metal	Single Drawkey	8581B002
	FA339 (02339)		1.609"	9.660"	2	Nylon	Double Drawkey	8567N
	FA339 (02339)		1.609"	9.660"	1	Nylon	No Ream, Single Drawkey	8581N
	FA339 (02339)		1.611"	9.660"	1	Nylon	No Ream, Single Drawkey	8581N002
	FA340 (02340)		1.611"	9.660"	1	Composite	Aluminum Axle - No Ream Bush.	80079C
	FA340 (02340)		1.609"	9.660"	1	Metal	Single Drawkey - Steel I-Beam Axle	8581B
	FA340 (02340)		1.611"	9.660"	1	Metal	Single Drawkey - Aluminum I-Beam Axle Fr	8581B002
	FA340 (02340)		1.609"	9.660"	1	Nylon	Single Drawkey - Steel I-Beam Axle	8581N
	FA340 (02340)		1.611"	9.660"	1	Nylon	Single Drawkey - Steel I-Beam Axle	8581N002
	16,000	FA136 (02136)		1.999"	11.040"	2	Metal	Double Drawkey
FA136 (02136)			1.999"	11.040"	2	Nylon		8518N
FA231 (02231)			1.999"	11.212"	2	Metal	Double Drawkey	8571B

Tie Rod Ends

Axle Lbs. Rating	Code	Year	Length (Inches)	Notes	Tie Rod End Part No.	
					Drivers Side	Passenger Side
10,800	FA329 (02329)		9.18"		ES411L	ES411R
	FA341 (02341)		9.18"		ES411L	ES411R
12,000	FA139 (02139)		9.18"		ES411L	ES411R
	FA228 (02228)		5.44"		ES423L	ES423R
	FA339 (02339)		9.18"		ES411L	ES411R
	FA340 (02340)		9.18"		ES411L	ES411R
16,000	FA136 (02136)		5.75"	Rockwell Std. FH901	ES431L	ES431R
	FA231 (02231)		7.37"	Rockwell Std. FH901	ES2090L	ES2091R

PETERBILT TRUCK MODEL FINDING INDEX			
Model	Model	Model	Model
252	282	289	300
310	320	330	348
352	352H	353	357
359	362	372	375
376	377	378	379
385	387		



Conventional
(252, 289, 348, 353, 359)



Low Cab Forward
(300)



Aluminum Tilt Cab
(282, 352, 352H)

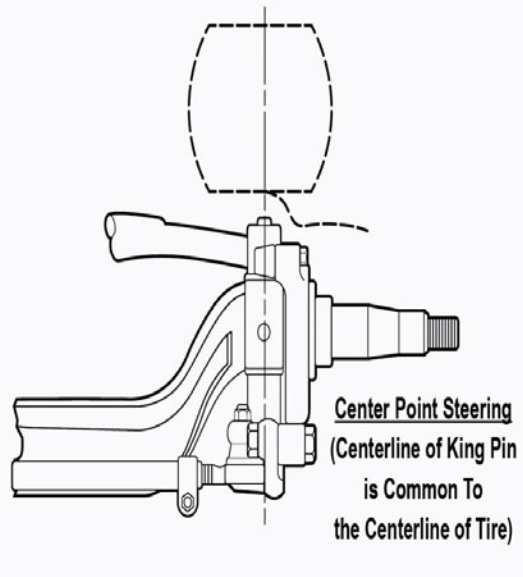
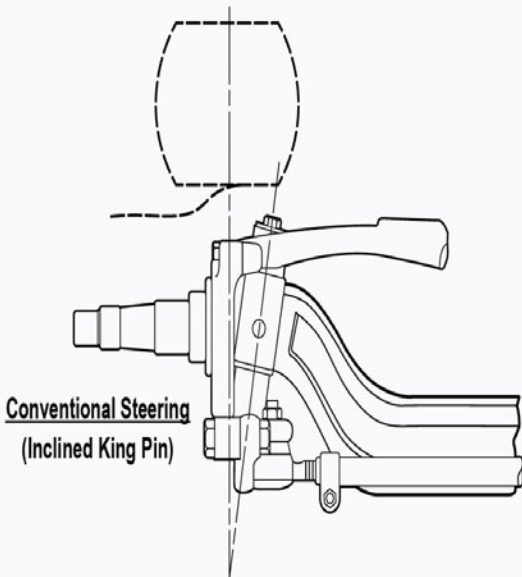

252, 282, 289, 300, 348, 352, 352H, 353, 359

King Bolt Sets

Axle Lbs. Rating	Code	Year	Diameter (inches)	Length (Inches)	Pin Type	Bushing	Notes	King Pin Set No.
12,000	(FE970)		1.607"	8.812"	2	Metal		8514B
	(FE970)		1.607"	8.812"	2	Nylon		8514N
	(FF901)		1.309/1.607"	9.750"	7	Metal		8386B
	(FF901)		1.794"	9.120"	2	Metal		8489B
	(FF901)		1.309/1.607"	9.750"	7	Nylon		8386N
	(FF901)		1.794"	9.120"	2	Nylon		8489N
	(FF921)		1.794"	10.392"	2	Metal		8553B
	(FF931)		1.794"	10.392"	2	Metal		8590B
	(FF971)		1.607"	9.380"	2	Metal		8612B
	EFA-12F3		1.630"	9.200"	1	Composite		8631C
	EFA-12F3		1.625"	9.195"	1	Metal		8631B
	EFA-12F4		1.630"	9.200"	1	Composite		8618C
	EFA-12F4		1.625"	9.200"	1	Metal		8647B
	16,000	(FH901)		1.999"	11.040"	2	Metal	
(FH901)			1.999"	11.040"	2	Nylon		8518N
(FL931)			1.999"	11.212"	2	Metal		8571B

252, 282, 289, 300, 348, 352, 352H, 353, 359 (Cont'd)

King Bolt Sets (Cont'd)

Axle Lbs. Rating	Code	Year	Diameter (inches)	Length (Inches)	Pin Type	Bushing	Notes	King Pin Set No.
18,000	(FL901)		1.999"	11.040"	2	Metal		8518B
	(FL901)		1.999"	11.040"	2	Nylon		8518N

Tie Rod Ends

Axle Lbs. Rating	Code	Year	Length (Inches)	Notes	Tie Rod End Part No.	
					Drivers Side	Passenger Side
11,000	(FE900)		4.88"		ES187L	ES187R
	(FE900)		5.75"		ES431L	ES431R
12,000	(FE900)		4.88"	Will Retrofit Older Axles	ES187L	ES187R
	(FE970)		10.50"		ES2200L	ES2201R
	(FE970)		4.88"		ES187L	ES187R
	(FE970)		5.75"		ES431L	ES431R
	(FE971)		10.50"	(Center Point Steering)	ES2200L	ES2201R
	(FF901)		4.88"		ES187L	ES187R
	(FF901)		5.75"	Conventional Seal Type	ES431L	ES431R
	(FF901)		5.75"	Anti-Tilt Seal Type	ES346L	ES346R
	(FF921)		5.44"		ES423L	ES423R
	(FF931)		5.44"	1-1/8"-18 Optional Thread (Requires 2)		ES3312R
	(FF931)		5.44"	1-1/8"-18 Optional Thread	ES423L	ES423R
16,000	(FH901)		5.75"		ES431L	ES431R
	(FL931)		12.69"		ES3031L	ES3030R
	(FL931)		5.75"		ES431L	ES431R
	(FL931)		7.37"		ES2090L	ES2091R
18,000	(FL901)		5.75"		ES431L	ES431R

Drag Links

Axle Lbs. Rating	Code	Year	Length (inches)	Notes	Drag Link No.
			14.21"		DS1185
			19.29"		DS1179
			29.13"		DS1283
			31.69"		DS1182
			44.29"		DS1180
					DS1184

310, 320, 330, 357, 362, 372, 375, 376, 377, 378, 379, 385, 387

King Bolt Sets

Axle Lbs. Rating	Code	Year	Diameter (inches)	Length (Inches)	Pin Type	Bushing	Notes	King Pin Set No.
11,000	(FE900)		1.309/1.607"	9.750"	7	Metal		8386B
	(FE900)		1.309/1.607"	9.750"	7	Nylon		8386N
12,000	(FE970)		1.607"	8.812"	2	Metal		8514B
	(FE970)		1.607"	8.812"	2	Nylon		8514N
	(FF901)		1.794"	9.120"	2	Metal		8489B
	(FF901)		1.794"	9.120"	2	Nylon		8489N
	(FF921)		1.794"	10.392"	2	Metal		8553B
	(FF931)		1.794"	10.392"	2	Metal		8590B
	(FF941)		1.794"	10.392"	2	Metal		8590B
	(FF943)		1.794"	10.392"	2	Metal		8590B
	(FF944)		1.794"	10.392"	2	Metal		8590B
	(FF961)		1.790"	10.390"	2	Composite		80063C
	(FF961)		1.790"	10.390"	2	Metal		80063B
	(FF971)		1.607"	9.380"	2	Metal		8612B
	(FF971)		1.607"	9.380"	2	Metal		8612B
	E-12001		1.794"	9.060"	1	Metal		80076B
	EFA-12F3		1.630"	9.200"	1	Composite		8631C
	EFA-12F3		1.625"	9.195"	1	Metal		8631B
	EFA-12F4		1.630"	9.200"	1	Composite		8618C
EFA-12F4		1.630"	9.200"	1	Composite		8618C	
EFA-12F4		1.625"	9.200"	1	Metal		8647B	
EFA-12F4		1.625"	9.200"	1	Metal		8647B	
13,000	EFA-13F3		1.630"	9.200"	1	Composite		8631C
	EFA-13F3		1.625"	9.195"	1	Metal		8631B
13,200	1320i		1.794"	9.060"	1	Metal		80076B
	1320i		1.872"	9.060"	1	Metal		80077B
	EFA-12F4		1.630"	9.200"	1	Composite		8618C
	EFA-12F4		1.625"	9.200"	1	Metal		8647B

310, 320, 330, 357, 362, 372, 375, 376, 377, 378, 379, 385, 387 (Cont'd)

Heavy Duty Trucks

King Bolt Sets (Cont'd)

Axle Lbs. Rating	Code	Year	Diameter (inches)	Length (Inches)	Pin Type	Bushing	Notes	King Pin Set No.
14,600	(FG941)		1.790"	10.390"	2	Metal		8611B
	1460i		1.872"	9.060"	1	Composite		80078C
	1460i		1.872"	9.060"	1	Metal		80077B
16,000	(FH901)		1.999"	11.040"	2	Metal		8518B
	(FH901)		1.999"	11.040"	2	Nylon		8518N
	(FL931)		1.999"	11.212"	2	Metal		8571B
18,000	(FL901)		1.999"	11.040"	2	Metal		8518B
	(FL901)		1.999"	11.040"	2	Nylon		8518N
	(FL931)		1.999"	11.212"	2	Metal		8571B
	(FL941)		1.999"	11.212"	2	Metal		8571B
	EFA-18F3		1.870"	9.970"	1	Composite		8633C
	EFA-18F3		1.870"	9.970"	1	Metal		8633B
20,000	(FL941)		1.999"	11.212"	2	Metal		8571B
	EFA-20F4		1.870"	9.970"	1	Composite		8633C
	EFA-20F4		1.870"	9.970"	1	Metal		8633B
36,000	(FL941)		1.999"	11.212"	2	Metal	w/Dual Str. Axles	8571B

Tie Rod Ends

Axle Lbs. Rating	Code	Year	Length (Inches)	Notes	Tie Rod End Part No.	
					Drivers Side	Passenger Side
11,000	(FE900)		4.88"		ES187L	ES187R
	(FE900)		5.75"		ES431L	ES431R
12,000	(FE970)		10.50"	Will Retrofit Older Axles	ES2200L	ES2201R
	(FE970)		4.88"		ES187L	ES187R
	(FE970)		5.75"		ES431L	ES431R
	(FE971)		10.50"	(Center Point Steering)	ES2200L	ES2201R
	(FF901)		4.88"		ES187L	ES187R
	(FF901)		5.75"	Conventional Seal Type	ES431L	ES431R
	(FF901)		5.75"	Anti-Tilt Seal Type	ES346L	ES346R
	(FF921)		5.44"	1-1/8"-18 Optional Thread		ES3312R
	(FF921)		5.44"		ES423L	ES423R
	(FF931)		5.44"		ES423L	ES423R
	(FF931)		5.44"	1-1/8"-18 Optional Thread		ES3312R
	(FF941)		5.44"		ES423L	ES423R
	(FF943)		5.44"		ES423L	ES423R
	(FF944)		5.44"	1-1/8"-18 Optional Thread		ES3312R
	(FF961)		5.44"	1-1/8"-18 Optional Thread		ES3312R
	E-1200i		6.00"		ES423L	ES423R
EFA-12F4		5.44"		ES3477	ES3476	
EFA-12F4		8.12"		ES423L	ES423R	
				ES3298L	ES3297R	
13,200	EFA-12F4		5.44"		ES423L	ES423R
	EFA-12F4/EI 320i		8.12"		ES3298L	ES3297R
14,600	(FG941)		5.44"	1-1/8"-18 Optional Thread		ES3312R
	(FG941)		5.44"		ES423L	ES423R
	E1460i		7.37"		ES2090L	ES2091R
	E1460i		7.37"		ES2090L	ES2091R
16,000	(FH901)		5.75"		ES431L	ES431R
	(FL931)		12.69"		ES3031L	ES3030R
	(FL931)		5.75"		ES431L	ES431R
	(FL931)		7.37"		ES2090L	ES2091R
18,000	(FL901)		5.75"		ES431L	ES431R
	(FL931)		12.69"		ES3031L	ES3030R
	(FL931)		5.75"		ES431L	ES431R
	(FL931)		7.37"		ES2090L	ES2091R
	(FL941)		12.69"		ES3031L	ES3030R
	(FL941)		5.75"		ES431L	ES431R
	(FL941)		7.37"		ES2090L	ES2091R
EFA-18F3		7.37"		ES2090L	ES2091R	
20,000	(FL941)		12.69"		ES3031L	ES3030R
	(FL941)		5.75"		ES431L	ES431R
	(FL941)		7.37"		ES2090L	ES2091R
	EFA-20F4		7.37"		ES2090L	ES2091R
36,000	(FL941)		12.69"	W/Dual Str. Axles	ES3031L	ES3030R
	(FL941)		5.75"	W/Dual Str. Axles	ES431L	ES431R
	(FL941)		7.37"	W/Dual Str. Axles	ES2090L	ES2091R

310, 320, 330, 357, 362, 372, 375, 376, 377, 378, 379, 385, 387 (Cont'd)

Drag Links					
Axle Lbs. Rating	Code	Year	Length (inches)	Notes	Drag Link No.
			14.21"		DS1185
			19.29"		DS1179
			29.13"		DS1283
			31.69"		DS1182
			44.29"		DS1180
					DS1184

ROCKWELL TRUCK MODEL FINDING INDEX			
Model	Model	Model	Model
16612	16613	16616	16930
16931	17100	17101	17111
27460-A	27465-A	30000 Series	31000 Series
32500 Series	33000 Series	F9E951	FC901
FC902	FC903	FC921	FC931
FD900	FD901	FD902	FD903
FD931	FD933	FD961	FDS SERIES
FDS1805FWD	FDS1807FWD	FE900	FE903
FE910	FE970	FF901	FF903
FF921	FF923	FF930	FF931
FF931A	FF932	FF933	FF934
FF941	FF941A	FF942	FF943
FF944	FF961	FF971	FF981
FF982	FF983	FF986	FG900
FG903	FG931	FG933	FG941
FG943	FH901	FH945	FH946
FL901	FL931	FL933	FL941
FL943	FL951	FU910	MFS SERIES
RF SERIES			

Rockwell's Front Axle Models: **Example FF941 Front Axle**

This model number indicates a front axle with a 12,000 pound capacity, has Easy Steer king pin bushings and uses a straight king pin design.

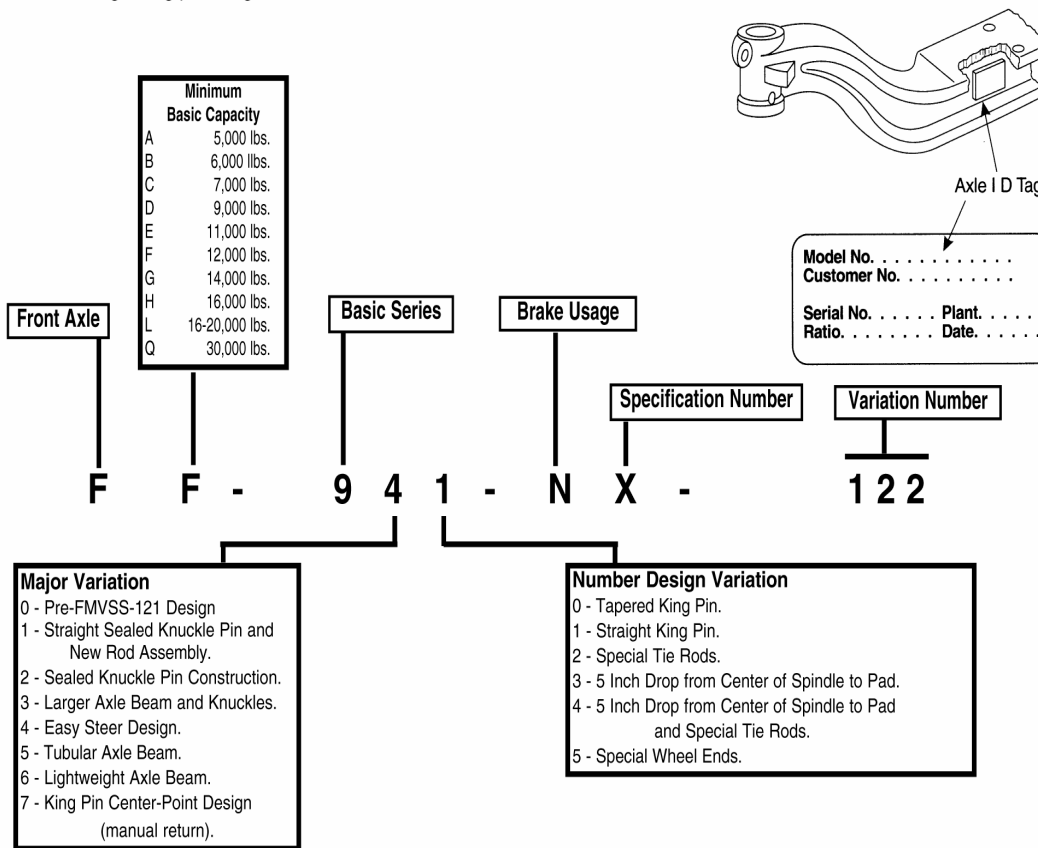

A letter appearing after the model number such as an A, indicates that the beam is aluminum.
 After the base model ID there will be a SPECIFICATION NUMBER. This spec number identifies axle specifics (ie. type of brake, types of knuckle etc.).

16612, 16613, 16616

King Bolt Sets

Axle Lbs. Rating	Code	Year	Diameter (inches)	Length (Inches)	Pin Type	Bushing	Notes	King Pin Set No.
12,000			1.309/1.607"	9.750"	7	Metal		8386B
			1.309/1.607"	9.750"	7	Nylon		8386N

16930, 16931

Tie Rod Ends						
Axle Lbs. Rating	Code	Year	Length (Inches)	Notes	Tie Rod End Part No.	
					Drivers Side	Passenger Side
12,000			5.44"	1-1/8"-18 Optional Thread	ES423L	ES3312R
			5.44"			ES423R
			5.75"			ES431R
					ES431L	ES431R

17100,17101,17111

King Bolt Sets								
Axle Lbs. Rating	Code	Year	Diameter (inches)	Length (Inches)	Pin Type	Bushing	Notes	King Pin Set No.
14,600			1.790"	10.390"	2	Metal		8611B

Tie Rod Ends						
Axle Lbs. Rating	Code	Year	Length (Inches)	Notes	Tie Rod End Part No.	
					Drivers Side	Passenger Side
14,600			5.75"		ES431L	ES431R
			9.18"			ES411R
					ES411L	

27460-A, 27465-A

Tie Rod Ends						
Axle Lbs. Rating	Code	Year	Length (Inches)	Notes	Tie Rod End Part No.	
					Drivers Side	Passenger Side
			4.88"	External Threads, For Straight Rod Only Internal Threads, For Straight Rod Only	ES187L	ES187R
			5.50"			ES325R
					ES325L	

30000, 31000 Series

King Bolt Sets								
Axle Lbs. Rating	Code	Year	Diameter (inches)	Length (Inches)	Pin Type	Bushing	Notes	King Pin Set No.
5,000			1.109"	6.812"	1	Metal	Thrust Bearing Type	8336B

32500, 33000 Series

Tie Rod Ends						
Axle Lbs. Rating	Code	Year	Length (Inches)	Notes	Tie Rod End Part No.	
					Drivers Side	Passenger Side
5,000			4.44"	External Threads, For Straight Rod Only	ES2083L	ES2082R

FAE951

Tie Rod Ends						
Axle Lbs. Rating	Code	Year	Length (Inches)	Notes	Tie Rod End Part No.	
					Drivers Side	Passenger Side
2,500			3.25"		ES262R	ES262L

FC901, FC902, FC903

King Bolt Sets								
Axle Lbs. Rating	Code	Year	Diameter (inches)	Length (Inches)	Pin Type	Bushing	Notes	King Pin Set No.
7,000			1.234"	7.440"	2	Metal		8479B
			1.244"	7.440"	2	Metal		8507B010
			1.234"	7.440"	2	Nylon		8479N

Tie Rod Ends						
Axle Lbs. Rating	Code	Year	Length (Inches)	Notes	Tie Rod End Part No.	
					Drivers Side	Passenger Side
7,000			3.90"		ES304L	ES304R
			4.43"			ES3328R
					ES3329L	

FC921							
Tie Rod Ends							
Axle Lbs. Rating	Code	Year	Length (Inches)	Notes	Tie Rod End Part No.		
					Drivers Side	Passenger Side	
7,000			3.90"		ES304L	ES304R	

FC931							
Tie Rod Ends							
Axle Lbs. Rating	Code	Year	Length (Inches)	Notes	Tie Rod End Part No.		
					Drivers Side	Passenger Side	
7,000			4.88"		ES187L	ES187R	

FD900								
King Bolt Sets								
Axle Lbs. Rating	Code	Year	Diameter (inches)	Length (Inches)	Pin Type	Bushing	Notes	King Pin Set No.
9,000			1.186/1.434"	9.410"	6	Metal		80059B

FD901								
King Bolt Sets								
Axle Lbs. Rating	Code	Year	Diameter (inches)	Length (Inches)	Pin Type	Bushing	Notes	King Pin Set No.
9,000			1.434"	8.500"	2	Metal		8519B
			1.444"	8.500"	2	Metal		8519B010
			1.434"	8.500"	2	Nylon		8519N

Tie Rod Ends							
Axle Lbs. Rating	Code	Year	Length (Inches)	Notes	Tie Rod End Part No.		
					Drivers Side	Passenger Side	
9,000			4.88"		ES187L	ES187R	

FD902, FD903								
King Bolt Sets								
Axle Lbs. Rating	Code	Year	Diameter (inches)	Length (Inches)	Pin Type	Bushing	Notes	King Pin Set No.
9,000			1.434"	8.500"	2	Metal		8519B
			1.444"	8.500"	2	Metal		8519B010
			1.434"	8.500"	2	Nylon		8519N

Tie Rod Ends							
Axle Lbs. Rating	Code	Year	Length (Inches)	Notes	Tie Rod End Part No.		
					Drivers Side	Passenger Side	
9,000			4.88"		ES187L	ES187R	

FD931							
Tie Rod Ends							
Axle Lbs. Rating	Code	Year	Length (Inches)	Notes	Tie Rod End Part No.		
					Drivers Side	Passenger Side	
9,000			5.44"	1-1/8"-18 Optional Thread	ES423L	ES423R	ES3312R
			5.44"				ES423R

FD933							
Tie Rod Ends							
Axle Lbs. Rating	Code	Year	Length (Inches)	Notes	Tie Rod End Part No.		
					Drivers Side	Passenger Side	
12,000			5.44"	1-1/8"-18 Optional Thread	ES423L	ES423R	ES3312R
			5.44"				ES423R

FD961, FF961								
King Bolt Sets								
Axle Lbs. Rating	Code	Year	Diameter (inches)	Length (Inches)	Pin Type	Bushing	Notes	King Pin Set No.
10,000			1.790"	10.390"	2	Composite		80063C
			1.790"	10.390"	2	Metal		80063B
12,000			1.790"	10.390"	2	Composite		80063C
			1.790"	10.390"	2	Metal		80063B
Tie Rod Ends								
Axle Lbs. Rating	Code	Year	Length (Inches)	Notes	Tie Rod End Part No.			
					Drivers Side	Passenger Side		
10,000			5.44"	1-1/8"-18 Optional Thread	ES423L	ES3312R		
			5.44"			ES423R		
12,000			5.44"	1-1/8"-18 Optional Thread	ES423L	ES3312R		
			5.44"			ES423R		
FDS SERIES								
Tie Rod Ends								
Axle Lbs. Rating	Code	Year	Length (Inches)	Notes	Tie Rod End Part No.			
					Drivers Side	Passenger Side		
7,500	FDS75		3.90"		ES304L			
9,000	FDS90		3.90"		ES304L			
18,000	FDS1800		5.75"			ES3032R		
	FDS1800		5.75"			ES2208R		
	FDS1800		5.75"			ES346R		
21,000	FDS2100		5.75"			ES2208R		
FDS1807FWD, FDS1805FWD								
Tie Rod Ends								
Axle Lbs. Rating	Code	Year	Length (Inches)	Notes	Tie Rod End Part No.			
					Drivers Side	Passenger Side		
18,000			5.75"		ES2208R	ES2207R		
FE900, FE903, FE910								
King Bolt Sets								
Axle Lbs. Rating	Code	Year	Diameter (inches)	Length (Inches)	Pin Type	Bushing	Notes	King Pin Set No.
11,000			1.309/1.607"	9.750"	7	Metal		8386B
			1.309/1.607"	9.750"	7	Nylon		8386N
Tie Rod Ends								
Axle Lbs. Rating	Code	Year	Length (Inches)	Notes	Tie Rod End Part No.			
					Drivers Side	Passenger Side		
11,000			4.88"		ES187L ES431L	ES187R		
			5.75"			ES431R		
FE970								
King Bolt Sets								
Axle Lbs. Rating	Code	Year	Diameter (inches)	Length (Inches)	Pin Type	Bushing	Notes	King Pin Set No.
12,000			1.607"	8.812"	2	Metal		8514B
			1.607"	8.812"	2	Nylon		8514N
Tie Rod Ends								
Axle Lbs. Rating	Code	Year	Length (Inches)	Notes	Tie Rod End Part No.			
					Drivers Side	Passenger Side		
12,000			10.50"	Will Retrofit Older Axles	ES2200L ES187L ES431L	ES2201R		
			4.88"			ES187R		
			5.75"			ES431R		

FF901, FF903

King Bolt Sets

Axle Lbs. Rating	Code	Year	Diameter (inches)	Length (Inches)	Pin Type	Bushing	Notes	King Pin Set No.
12,000			1.794"	9.120"	2	Metal		8489B
			1.794"	9.120"	2	Nylon		8489N

Tie Rod Ends

Axle Lbs. Rating	Code	Year	Length (Inches)	Notes	Tie Rod End Part No.	
					Drivers Side	Passenger Side
12,000			4.88"	Anti-Tilt Seal Type	ES187L	ES187R
			5.75"		ES346L	ES346R
			5.75"		ES431L	ES431R

FF921, FF923

King Bolt Sets

Axle Lbs. Rating	Code	Year	Diameter (inches)	Length (Inches)	Pin Type	Bushing	Notes	King Pin Set No.
12,000			1.794"	10.392"	2	Metal		8553B

Tie Rod Ends

Axle Lbs. Rating	Code	Year	Length (Inches)	Notes	Tie Rod End Part No.	
					Drivers Side	Passenger Side
12,000			5.44"	1-1/8"-18 Optional Thread	ES423L	ES3312R
			5.44"			ES423R

FF930

Tie Rod Ends

Axle Lbs. Rating	Code	Year	Length (Inches)	Notes	Tie Rod End Part No.	
					Drivers Side	Passenger Side
12,000			5.44"		ES423L	ES423R
			5.75"			ES431R

FF931

King Bolt Sets

Axle Lbs. Rating	Code	Year	Diameter (inches)	Length (Inches)	Pin Type	Bushing	Notes	King Pin Set No.
12,000			1.794"	10.392"	2	Metal		8590B
			1.790"	10.390"	2	Metal		8611B

Tie Rod Ends

Axle Lbs. Rating	Code	Year	Length (Inches)	Notes	Tie Rod End Part No.	
					Drivers Side	Passenger Side
12,000			5.44"	1-1/8"-18 Optional Thread	ES423L	ES3312R
			5.44"			ES423R

FF931A, FF941A

Tie Rod Ends

Axle Lbs. Rating	Code	Year	Length (Inches)	Notes	Tie Rod End Part No.	
					Drivers Side	Passenger Side
12,000			5.44"	1-1/8"-18 Optional Thread (Aluminum) (Aluminum)	ES423L	ES3312R
			5.44"			ES423R

FF932

King Bolt Sets

Axle Lbs. Rating	Code	Year	Diameter (inches)	Length (Inches)	Pin Type	Bushing	Notes	King Pin Set No.
12,000			1.790"	10.390"	2	Metal		8611B
13,200			1.794"	10.392"	2	Metal		8590B

FF932 (Cont'd)

Tie Rod Ends						
Axle Lbs. Rating	Code	Year	Length (Inches)	Notes	Tie Rod End Part No.	
					Drivers Side	Passenger Side
13,200			5.44"	1-1/8"-18 Optional Thread	ES423L	ES3312R
			5.44"			ES423R

FF933, FF934

King Bolt Sets								
Axle Lbs. Rating	Code	Year	Diameter (inches)	Length (Inches)	Pin Type	Bushing	Notes	King Pin Set No.
12,000			1.794"	10.392"	2	Metal		8590B

Tie Rod Ends						
Axle Lbs. Rating	Code	Year	Length (Inches)	Notes	Tie Rod End Part No.	
					Drivers Side	Passenger Side
12,000			5.44"	1-1/8"-18 Optional Thread	ES423L	ES3312R
			5.44"			ES423R

FF941

King Bolt Sets								
Axle Lbs. Rating	Code	Year	Diameter (inches)	Length (Inches)	Pin Type	Bushing	Notes	King Pin Set No.
12,000			1.794"	10.392"	2	Metal		8590B

Tie Rod Ends						
Axle Lbs. Rating	Code	Year	Length (Inches)	Notes	Tie Rod End Part No.	
					Drivers Side	Passenger Side
12,000			5.44"	1-1/8"-18 Optional Thread	ES423L	ES3312R
			5.44"			ES423R

FF941,942

King Bolt Sets								
Axle Lbs. Rating	Code	Year	Diameter (inches)	Length (Inches)	Pin Type	Bushing	Notes	King Pin Set No.
12,000			1.790"	10.390"	2	Metal		8611B

FF942, FF943, FF944

King Bolt Sets								
Axle Lbs. Rating	Code	Year	Diameter (inches)	Length (Inches)	Pin Type	Bushing	Notes	King Pin Set No.
12,000			1.794"	10.392"	2	Metal		8590B

Tie Rod Ends						
Axle Lbs. Rating	Code	Year	Length (Inches)	Notes	Tie Rod End Part No.	
					Drivers Side	Passenger Side
12,000			5.44"	1-1/8"-18 Optional Thread	ES423L	ES3312R
			5.44"			ES423R

FF943

King Bolt Sets								
Axle Lbs. Rating	Code	Year	Diameter (inches)	Length (Inches)	Pin Type	Bushing	Notes	King Pin Set No.
12,000			1.790"	10.390"	2	Metal		8611B

FF971

King Bolt Sets								
Axle Lbs. Rating	Code	Year	Diameter (inches)	Length (Inches)	Pin Type	Bushing	Notes	King Pin Set No.
12,000			1.607"	9.380"	2	Metal	(Center Point Steering)	8612B

FF971 (Cont'd)

Tie Rod Ends						
Axle Lbs. Rating	Code	Year	Length (Inches)	Notes	Tie Rod End Part No.	
					Drivers Side	Passenger Side
12,000			10.50"	(Center Point Steering)	ES2200L	ES2201R

FF981, FF982, FF983, FF986

Tie Rod Ends						
Axle Lbs. Rating	Code	Year	Length (Inches)	Notes	Tie Rod End Part No.	
					Drivers Side	Passenger Side
12,000			5.44"		ES423L	ES423R

FG900, FG903

King Bolt Sets								
Axle Lbs. Rating	Code	Year	Diameter (inches)	Length (Inches)	Pin Type	Bushing	Notes	King Pin Set No.
16,000			1.400/1.794"	10.688"	7	Metal		8474B

Tie Rod Ends						
Axle Lbs. Rating	Code	Year	Length (Inches)	Notes	Tie Rod End Part No.	
					Drivers Side	Passenger Side
16,000			4.88"	For Straight Rod Only	ES187L	ES187R

FG931, FG933, FG941

King Bolt Sets								
Axle Lbs. Rating	Code	Year	Diameter (inches)	Length (Inches)	Pin Type	Bushing	Notes	King Pin Set No.
14,600			1.790"	10.390"	2	Metal		8611B

Tie Rod Ends						
Axle Lbs. Rating	Code	Year	Length (Inches)	Notes	Tie Rod End Part No.	
					Drivers Side	Passenger Side
14,600			5.44" 5.44"	1-1/8"-18 Optional Thread	ES423L	ES3312R ES423R

FG943

King Bolt Sets								
Axle Lbs. Rating	Code	Year	Diameter (inches)	Length (Inches)	Pin Type	Bushing	Notes	King Pin Set No.
14,600			1.790"	10.390"	2	Metal		8611B

Tie Rod Ends						
Axle Lbs. Rating	Code	Year	Length (Inches)	Notes	Tie Rod End Part No.	
					Drivers Side	Passenger Side
14,600			5.44" 5.44"	1-1/8"-18 Optional Thread	ES423L	ES3312R ES423R

FH901

King Bolt Sets								
Axle Lbs. Rating	Code	Year	Diameter (inches)	Length (Inches)	Pin Type	Bushing	Notes	King Pin Set No.
16,000			1.999" 1.999"	11.040" 11.040"	2 2	Metal Nylon		8518B 8518N

Tie Rod Ends						
Axle Lbs. Rating	Code	Year	Length (Inches)	Notes	Tie Rod End Part No.	
					Drivers Side	Passenger Side
16,000			5.75"		ES431L	ES431R

FH945, FH946

Tie Rod Ends

Axle Lbs. Rating	Code	Year	Length (Inches)	Notes	Tie Rod End Part No.	
					Drivers Side	Passenger Side
16,000			7.37"		ES2090L	ES2091R

FL901

King Bolt Sets

Axle Lbs. Rating	Code	Year	Diameter (inches)	Length (Inches)	Pin Type	Bushing	Notes	King Pin Set No.
18,000			1.999"	11.040"	2	Metal		8518B
			1.999"	11.040"	2	Nylon		8518N

Tie Rod Ends

Axle Lbs. Rating	Code	Year	Length (Inches)	Notes	Tie Rod End Part No.	
					Drivers Side	Passenger Side
18,000			5.75"		ES431L	ES431R

FL931, FL933

King Bolt Sets

Axle Lbs. Rating	Code	Year	Diameter (inches)	Length (Inches)	Pin Type	Bushing	Notes	King Pin Set No.
16,000			1.999"	11.212"	2	Metal		8571B
18,000			1.999"	11.212"	2	Metal		8571B
20,000			1.999"	11.212"	2	Metal		8571B

Tie Rod Ends

Axle Lbs. Rating	Code	Year	Length (Inches)	Notes	Tie Rod End Part No.	
					Drivers Side	Passenger Side
16,000			12.69"		ES3031L	ES3030R
			5.75"		ES431L	ES431R
			7.37"		ES2090L	ES2091R
18,000			12.69"		ES3031L	ES3030R
			5.75"		ES431L	ES431R
			7.37"		ES2090L	ES2091R
20,000			12.69"		ES3031L	ES3030R
			5.75"		ES431L	ES431R
			7.37"		ES2090L	ES2091R

FL941, FL943

King Bolt Sets

Axle Lbs. Rating	Code	Year	Diameter (inches)	Length (Inches)	Pin Type	Bushing	Notes	King Pin Set No.
16,000			1.999"	11.212"	2	Metal		8571B
18,000			1.999"	11.212"	2	Metal		8571B
20,000			1.999"	11.212"	2	Metal		8571B

Tie Rod Ends

Axle Lbs. Rating	Code	Year	Length (Inches)	Notes	Tie Rod End Part No.	
					Drivers Side	Passenger Side
16,000			12.69"		ES3031L	ES3030R
			5.75"		ES431L	ES431R
			7.37"		ES2090L	ES2091R
18,000			12.69"		ES3031L	ES3030R
			5.75"		ES431L	ES431R
			7.37"		ES2090L	ES2091R
20,000			12.69"		ES3031L	ES3030R
			5.75"		ES431L	ES431R
			7.37"		ES2090L	ES2091R

FL951

King Bolt Sets

Axle Lbs. Rating	Code	Year	Diameter (inches)	Length (Inches)	Pin Type	Bushing	Notes	King Pin Set No.
22,000			1.999"	11.212"	2	Metal		8571B

FL951 (Cont'd)

Tie Rod Ends

Axle Lbs. Rating	Code	Year	Length (Inches)	Notes	Tie Rod End Part No.	
					Drivers Side	Passenger Side
22,000			7.37"		ES2090L	ES2091R

FU910

Tie Rod Ends

Axle Lbs. Rating	Code	Year	Length (Inches)	Notes	Tie Rod End Part No.	
					Drivers Side	Passenger Side
28,000			4.88"		ES187L	ES187R

MFS SERIES

King Bolt Sets

Axle Lbs. Rating	Code	Year	Diameter (inches)	Length (Inches)	Pin Type	Bushing	Notes	King Pin Set No.
10,000	MFS10		1.790"	10.390"	2	Composite		80063C
	MFS10		1.790"	10.390"	2	Metal		80063B
12,000	MFS12		1.790"	10.390"	2	Composite		80063C
	MFS12		1.790"	10.390"	2	Metal		80063B

Tie Rod Ends

Axle Lbs. Rating	Code	Year	Length (Inches)	Notes	Tie Rod End Part No.	
					Drivers Side	Passenger Side
8,000	MFS08		5.44"		ES423L	ES423R
10,000	MFS10		5.44"		ES423L	ES423R
12,000	MFS12		5.44"		ES423L	ES423R
13,000	MFS13		5.44"		ES423L	ES423R
14,000	MFS14		5.44"		ES423L	ES423R
	MFS14		7.37"		ES2090L	ES2091R
16,000	MFS16		12.69"		ES3031L	ES3031R
	MFS16		5.44"		ES423L	ES423R
	MFS16		7.37"		ES2090L	ES2091R
18,000	MFS18		12.69"		ES3031L	ES3031R
	MFS18		5.44"		ES423L	ES423R
	MFS18		7.37"		ES2090L	ES2091R
20,000	MFS20		12.69"		ES3031L	ES3031R
	MFS20		5.44"		ES423L	ES423R
	MFS20		7.37"		ES2090L	ES2091R

RF SERIES

Tie Rod Ends

Axle Lbs. Rating	Code	Year	Length (Inches)	Notes	Tie Rod End Part No.	
					Drivers Side	Passenger Side
12,000	RF12		3.90"		ES304L	

STERLING TRUCK MODEL FINDING INDEX			
Model	Model	Model	Model
A, L, S Series	A, L, S, Series	A9500	Acterra
SC7000 CARGO, COE	SC7000, SC8000 CARGO, COE		

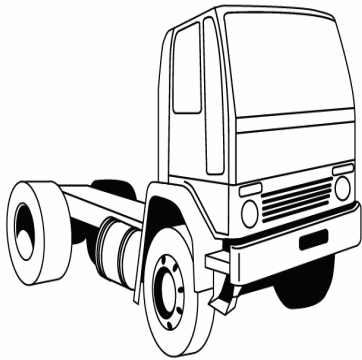

Cargo

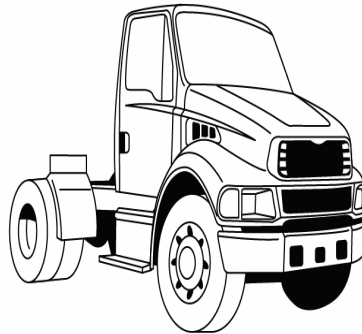

Acterra



A, AT, S, ST



L, LT



L, LT

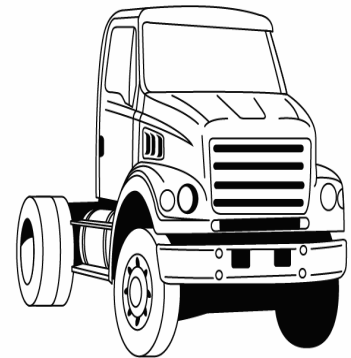

L, LT

A, L, S Series

King Bolt Sets

Axle Lbs. Rating	Code	Year	Diameter (inches)	Length (Inches)	Pin Type	Bushing	Notes	King Pin Set No.
12,000	(02ADD)		1.921"	9.870"	2	Composite		8655C
	(02ADD)		1.921"	9.870"	2	Metal		8655B
	(140SA)		1.859"	10.77"	9	Composite		8006C
	(146SA)		1.859"	10.77"	9	Composite		8006C
	(120S/SG)		1.921"	9.870"	2	Composite		8655C
	(120S/SG)		1.921"	9.870"	2	Metal		8655B
	(120SA)		1.859"	10.77"	9	Composite		8006C
	02ADE		2.046"	10.120"	2	Composite		80070C
	02ADE		2.046"	10.120"	2	Metal		8657B
	02ADG		2.046"	10.120"	2	Composite		80070C
	02ADG		2.046"	10.120"	2	Metal		8657B
	I120W		2.046"	10.120"	2	Composite		80070C
	I120W		2.046"	10.120"	2	Metal		8657B
	13,200	132SG		2.046"	10.120"	2	Composite	
132SG			2.046"	10.120"	2	Metal		8657B
14,000	(140SA)		1.859"	10.77"	9	Composite		8006C
	(146SA)		1.859"	10.77"	9	Composite		8006C
	(120SA)		1.859"	10.77"	9	Composite		8006C
	140S		2.046"	10.120"	2	Composite		80070C

A, L, S Series (Cont'd)

King Bolt Sets (Cont'd)

Axle Lbs. Rating	Code	Year	Diameter (inches)	Length (Inches)	Pin Type	Bushing	Notes	King Pin Set No.
14,000	140S		2.046"	10.120"	2	Metal		8657B
	140SG		2.046"	10.120"	2	Composite		80070C
	140SG		2.046"	10.120"	2	Metal		8657B
	140W		2.046"	10.120"	2	Composite		80070C
	140W		2.046"	10.120"	2	Metal		8657B
14,600	(140SA)		1.859"	10.77"	9	Composite		8006C
	(146SA)		1.859"	10.77"	9	Composite		8006C
	(120SA)		1.859"	10.77"	9	Composite		8006C
	140S		2.046"	10.120"	2	Composite		80070C
	140S		2.046"	10.120"	2	Metal		8657B
	140SG		2.046"	10.120"	2	Composite		80070C
	140SG		2.046"	10.120"	2	Metal		8657B
	140W		2.046"	10.120"	2	Composite		80070C
	140W		2.046"	10.120"	2	Metal		8657B
16,000	(160S)		2.046"	11.000"	2	Composite		80075C
	(160S/SG)		2.046"	11.000"	2	Metal		80074B
18,000	(180S)		2.046"	11.000"	2	Composite		80075C
	(180S/SG)		2.046"	11.000"	2	Metal		80074B
20,000	(200S)		2.046"	11.000"	2	Composite		80075C
	(200S/SG)		2.046"	11.000"	2	Metal		80074B

A, L, S, Series

Tie Rod Ends

Axle Lbs. Rating	Code	Year	Length (Inches)	Notes	Tie Rod End Part No.	
					Drivers Side	Passenger Side
12,000	02ADD	2000-2006	12.69"		ES3031L	ES3030R
	02ADD		5.44"		ES423L	ES423R
	02ADD		5.75"		ES431L	ES431R
	I120S/SG	12.69"	ES3031L		ES3030R	
	I120S/SG	2000-2006	5.44"		ES423L	ES423R
	I120W	2000-2005	7.37"		ES2090L	ES2091R
	I20S/SG		5.75"		ES431L	ES431R
	MFS12	2000-2006	5.44"		ES423L	ES423R
13,000	132SG	2000-2006	5.44"		ES423L	ES423R
	MFS13	2000-2006	5.44"		ES423L	ES423R
13,200	132SG	2000-2006	12.69"		ES3031L	ES3030R
	132SG		5.44"		ES423L	ES423R
	132SG		5.75"		ES431L	ES431R
	I132SG	6.00"	ES3477		ES3476	
	I132SG	9.18"	ES411L		ES411R	
	MFS13	2000-2006	5.44"		ES423L	ES423R
14,000	140S/SA/SG	2000-2006	5.44"		ES423L	ES423R
	140S/SA/SG		12.69"		ES3031L	ES3030R
	140S/SA/SG		5.75"		ES431L	ES431R
	140W	2000-2005	7.37"		ES2090L	ES2091R
	146SA	2000-2006	12.69"		ES3031L	ES3030R
	146SA		5.44"		ES423L	ES423R
	146SA		5.75"		ES431L	ES431R
	146SA		6.00"		ES3477	ES3476
	146SA		9.18"		ES411L	ES411R
	146SA		6.00"		ES3477	ES3476
	I140SA	2000-2006	9.18"		ES411L	ES411R
	I140SA		5.44"		ES423L	ES423R
	MFS14		2000-2006		5.44"	ES423L
MFS14	2000-2005		7.37"	ES2090L	ES2091R	
14,600	140S/SA/SG	2000-2006	5.44"		ES423L	ES423R
	140S/SA/SG		12.69"		ES3031L	ES3030R
	140S/SA/SG		5.75"		ES431L	ES431R
	146SA	2000-2006	12.69"		ES3031L	ES3030R
	146SA		5.44"		ES423L	ES423R
	146SA		5.75"		ES431L	ES431R
	146SA		6.00"		ES3477	ES3476
	146SA		9.18"		ES411L	ES411R
	146SA		6.00"		ES3477	ES3476
MFS14	2000-2006	5.44"	ES423L	ES423R		
16,000	160S/SG		12.69"		ES3031L	ES3030R
	160S/SG		5.75"		ES431L	ES431R
	MFS16	2000-2006	5.44"		ES423L	ES423R
	MFS16	2000-2005	7.37"		ES2090L	ES2091R

A, L, S, Series (Cont'd)

Tie Rod Ends (Cont'd)

Axle Lbs. Rating	Code	Year	Length (Inches)	Notes	Tie Rod End Part No.		
					Drivers Side	Passenger Side	
18,000	180S,SG	2000-2006 2000-2005	12.69"			ES3031L	ES3030R
	180S/SG		5.75"			ES431L	ES431R
	MFS18		5.44"			ES423L	ES423R
	MFS18		7.37"			ES2090L	ES2091R
20,000	200S/SG	2000-2006 2000-2005	12.69"			ES3031L	ES3030R
	200S/SG		5.75"			ES431L	ES431R
	D2000F		12.69"			ES3031L	ES3030R
	MFS20		5.44"			ES423L	ES423R
	MFS20		7.37"			ES2090L	ES2091R
22,000	2200F		12.69"			ES3031L	ES3030R

A9500

King Bolt Sets

Axle Lbs. Rating	Code	Year	Diameter (inches)	Length (Inches)	Pin Type	Bushing	Notes	King Pin Set No.
12,000	(MFS12)		1.790"	10.390"	2	Composite		80063C
	(MFS12)		1.790"	10.390"	2	Metal		80063B

Acterra

King Bolt Sets

Axle Lbs. Rating	Code	Year	Diameter (inches)	Length (Inches)	Pin Type	Bushing	Notes	King Pin Set No.
10,000	(MFS10)	2001-2004	1.790"	10.390"	2	Composite		80063C
	(MFS10)		1.790"	10.390"	2	Metal		80063B
12,000	(12)	2001-2004	1.790"	10.390"	2	Composite		80063C
	(12)		1.790"	10.390"	2	Metal		80063B

Tie Rod Ends

Axle Lbs. Rating	Code	Year	Length (Inches)	Notes	Tie Rod End Part No.		
					Drivers Side	Passenger Side	
8,000	MFS08	2001-2004	5.44"		ES423L	ES423R	
10,000	MFS10	2001-2004	5.44"		ES423L	ES423R	
12,000	MFS12	2001-2004	5.44"		ES423L	ES423R	
13,000	MFS13	2001-2004	5.44"		ES423L	ES423R	
14,000	MFS14	2001-2004	5.44"			ES423L	ES423R
	MFS14		7.37"			ES2090L	ES2091R
16,000	MFS16	2001-2004	12.69"			ES3031L	ES3030R
	MFS16		5.44"			ES423L	ES423R
	MFS16		7.37"			ES2090L	ES2091R
18,000	(MFS18)	2001-2004	12.69"			ES3031L	ES3030R
	MFS18		5.44"			ES423L	ES423R
	MFS18		7.37"			ES2090L	ES2091R
20,000	(MFS20)	2001-2004	12.69"			ES3031L	ES3030R
	MFS20		5.44"			ES423L	ES423R
	MFS20		7.37"			ES2090L	ES2091R

SC7000 CARGO, COE

King Bolt Sets

Axle Lbs. Rating	Code	Year	Diameter (inches)	Length (Inches)	Pin Type	Bushing	Notes	King Pin Set No.
			1.790"	10.390"	2	Composite		80063C
			1.790"	10.390"	2	Metal		80063B

SC7000, SC8000 CARGO, COE

Tie Rod Ends

Axle Lbs. Rating	Code	Year	Length (Inches)	Notes	Tie Rod End Part No.	
					Drivers Side	Passenger Side
8,000	MFS08	1999-2006	5.44"		ES423L	ES423R
10,000	MFS10	1999-2006	5.44"		ES423L	ES423R
12,000	MFS12	1999-2006	5.44"		ES423L	ES423R

THOMAS BUILT TRUCK MODEL FINDING INDEX			
Model	Model	Model	Model
ER Series	Saf-T-Liner	Saf-T-Liner & MVP	Saf-T-Liner C2
SCHOOL BUS	Type C Saf-T-Liner Vista		

ER Series

King Bolt Sets

Axle Lbs. Rating	Code	Year	Diameter (inches)	Length (Inches)	Pin Type	Bushing	Notes	King Pin Set No.
13,200	FF932		1.790"	10.390"	2	Composite		80063C
	FF932		1.794"	10.390"	2	Composite		8616C
	FF932		1.790"	10.390"	2	Metal		80063B
	FF932		1.794"	10.392"	2	Metal		8590B
14,600	FG931		1.790"	10.390"	2	Metal		8611B
	FG933		1.790"	10.390"	2	Metal		8611B
	FG941		1.790"	10.390"	2	Metal		8611B
	FG943		1.790"	10.390"	2	Metal		8611B

Tie Rod Ends

Axle Lbs. Rating	Code	Year	Length (Inches)	Notes	Tie Rod End Part No.	
					Drivers Side	Passenger Side
13,200	FF932		5.44"		ES423L	ES423R
	FG931		5.44"		ES423L	ES423R
	FG933		5.44"		ES423L	ES423R
	FG941		5.44"		ES423L	ES423R
	FG943		5.44"		ES423L	ES423R
14,600	FF932		5.44"		ES423L	ES423R
	FG931		5.44"		ES423L	ES423R
	FG933		5.44"		ES423L	ES423R
	FG941		5.44"		ES423L	ES423R
	FG943		5.44"		ES423L	ES423R

Saf-T-Liner

Tie Rod Ends

Axle Lbs. Rating	Code	Year	Length (Inches)	Notes	Tie Rod End Part No.	
					Drivers Side	Passenger Side
6K to 8K			5.44"		ES423L	ES423R

Saf-T-Liner & MVP

Tie Rod Ends

Axle Lbs. Rating	Code	Year	Length (Inches)	Notes	Tie Rod End Part No.	
					Drivers Side	Passenger Side
6K to 8K			5.44"		ES423L	ES423R

Saf-T-Liner C2

King Bolt Sets

Axle Lbs. Rating	Code	Year	Diameter (inches)	Length (Inches)	Pin Type	Bushing	Notes	King Pin Set No.
10,000	FD961		1.790"	10.390"	2	Composite		80063C
	FD961		1.790"	10.390"	2	Metal		80063B
	FF931		1.790"	10.390"	2	Composite		80063C
	FF931		1.790"	10.390"	2	Metal		80063B
	FF932		1.790"	10.390"	2	Composite		80063C
	FF932		1.790"	10.390"	2	Metal		80063B
	FF933		1.790"	10.390"	2	Composite		80063C
	FF933		1.790"	10.390"	2	Metal		80063B
	FF934		1.790"	10.390"	2	Composite		80063C
	FF934		1.790"	10.390"	2	Metal		80063B
	FF941		1.790"	10.390"	2	Composite		80063C
	FF941		1.790"	10.390"	2	Metal		80063B
	FF942		1.790"	10.390"	2	Composite		80063C
	FF942		1.790"	10.390"	2	Metal		80063B
	FF943		1.790"	10.390"	2	Composite		80063C
	FF943		1.790"	10.390"	2	Metal		80063B
	FF961		1.790"	10.390"	2	Composite		80063C
	FF961		1.790"	10.390"	2	Metal		80063B
12,000	(FF971)		1.607"	9.380"	2	Metal		8612B

Saf-T-Liner C2 (Cont'd)

King Bolt Sets (Cont'd)

Axle Lbs. Rating	Code	Year	Diameter (inches)	Length (Inches)	Pin Type	Bushing	Notes	King Pin Set No.
12,000	932		1.794"	10.392"	2	Metal		8590B
	933		1.794"	10.392"	2	Metal		8590B
	934		1.794"	10.392"	2	Metal		8590B
	941		1.794"	10.392"	2	Metal		8590B
	942		1.794"	10.392"	2	Metal		8590B
	943		1.794"	10.392"	2	Metal		8590B
	FD961		1.790"	10.390"	2	Composite		80063C
	FD961		1.790"	10.390"	2	Metal		80063B
	FF931		1.790"	10.390"	2	Composite		80063C
	FF931		1.790"	10.390"	2	Metal		80063B
	FF931		1.794"	10.392"	2	Metal		8590B
	FF932		1.790"	10.390"	2	Composite		80063C
	FF932		1.790"	10.390"	2	Metal		80063B
	FF933		1.790"	10.390"	2	Composite		80063C
	FF933		1.790"	10.390"	2	Metal		80063B
	FF934		1.790"	10.390"	2	Composite		80063C
	FF934		1.790"	10.390"	2	Metal		80063B
	FF941		1.790"	10.390"	2	Composite		80063C
	FF941		1.790"	10.390"	2	Metal		80063B
	FF942		1.790"	10.390"	2	Composite		80063C
FF942		1.790"	10.390"	2	Metal		80063B	
FF943		1.790"	10.390"	2	Composite		80063C	
FF943		1.790"	10.390"	2	Metal		80063B	
FF961		1.790"	10.390"	2	Composite		80063C	
FF961		1.790"	10.390"	2	Metal		80063B	

Tie Rod Ends

Axle Lbs. Rating	Code	Year	Length (Inches)	Notes	Tie Rod End Part No.	
					Drivers Side	Passenger Side
8,000	FC921		3.90"		ES304L	ES304R

SCHOOL BUS

King Bolt Sets

Axle Lbs. Rating	Code	Year	Diameter (inches)	Length (Inches)	Pin Type	Bushing	Notes	King Pin Set No.
13,200	FF932		1.794"	10.392"	2	Metal		8590B
14,600	FG931		1.790"	10.390"	2	Metal		8611B
	FG933		1.790"	10.390"	2	Metal		8611B
	FG941		1.790"	10.390"	2	Metal		8611B
	FG943		1.790"	10.390"	2	Metal		8611B

Tie Rod Ends

Axle Lbs. Rating	Code	Year	Length (Inches)	Notes	Tie Rod End Part No.	
					Drivers Side	Passenger Side
13,200	FF932		5.44"	1-1/8"-18 Optional Thread	ES423L	ES3312R
	FF932		5.44"			ES423R
14,600	FG931		5.44"	1-1/8"-18 Optional Thread	ES423L	ES3312R
	FG931		5.44"			ES423R
	FG933		5.44"	1-1/8"-18 Optional Thread	ES423L	ES3312R
	FG933		5.44"			ES423R
	FG941		5.44"	1-1/8"-18 Optional Thread	ES423L	ES3312R
	FG941		5.44"			ES423R
	FG943		5.44"	1-1/8"-18 Optional Thread	ES423L	ES3312R
	FG943		5.44"			ES423R

Type C Saf-T-Liner Vista

Tie Rod Ends

Axle Lbs. Rating	Code	Year	Length (Inches)	Notes	Tie Rod End Part No.	
					Drivers Side	Passenger Side
6K to 8K 10K +			11.89"		ES3204L	ES3205R
			9.18"		ES411L	ES411R

Drag Links

Axle Lbs. Rating	Code	Year	Length (inches)	Notes	Drag Link No.

Type C Saf-T-Liner Vista (Cont'd)

Drag Links (Cont'd)

Axle Lbs. Rating	Code	Year	Length (inches)	Notes	Drag Link No.
6K-8K 10K +			17.47" 17.68"		DS1215 DS1214

VOLVO/WHITE/GMC TRUCK MODEL FINDING INDEX			
Model	Model	Model	Model
AC Series	ACL Series	AERO Series	AUTOHAULER TRACTORS
VNL, VNM Series	WG Series	WHR Series	WIA Series
WIL Series	XPEDITOR		

AC Series

King Bolt Sets

Axle Lbs. Rating	Code	Year	Diameter (inches)	Length (Inches)	Pin Type	Bushing	Notes	King Pin Set No.
12,000	(FF961)		1.790"	10.390"	2	Composite		80063C
	(FF961)		1.790"	10.390"	2	Metal		80063B
16,000	(FL941)		1.999"	11.212"	2	Metal		8571B
18,000	(FL941)		1.999"	11.212"	2	Metal		8571B
20,000	(FL941)		1.999"	11.212"	2	Metal		8571B

Tie Rod Ends

Axle Lbs. Rating	Code	Year	Length (Inches)	Notes	Tie Rod End Part No.	
					Drivers Side	Passenger Side
12,000	(FF961)		5.44"	1-1/8"-18 Optional Thread		ES3312R
	(FF961)		5.44"		ES423L	ES423R
16,000	(FL941)		12.69"		ES3031L	ES3030R
	(FL941)		5.75"		ES431L	ES431R
	(FL941)		7.37"		ES2090L	ES2091R
18,000	(FL941)		12.69"		ES3031L	ES3030R
	(FL941)		5.75"		ES431L	ES431R
	(FL941)		7.37"		ES2090L	ES2091R
20,000	(FL941)		12.69"		ES3031L	ES3030R
	(FL941)		5.75"		ES431L	ES431R
	(FL941)		7.37"		ES2090L	ES2091R

ACL Series

King Bolt Sets

Axle Lbs. Rating	Code	Year	Diameter (inches)	Length (Inches)	Pin Type	Bushing	Notes	King Pin Set No.
12,000	(FF961)		1.790"	10.390"	2	Composite		80063C
	(FF961)		1.790"	10.390"	2	Metal		80063B
14,600	(FG941)		1.790"	10.390"	2	Metal		8611B
16,000	(FL941)		1.999"	11.212"	2	Metal		8571B
18,000	(FL941)		1.999"	11.212"	2	Metal		8571B
20,000	(FL941)		1.999"	11.212"	2	Metal		8571B

Tie Rod Ends

Axle Lbs. Rating	Code	Year	Length (Inches)	Notes	Tie Rod End Part No.	
					Drivers Side	Passenger Side
12,000	(FF961)		5.44"	1-1/8"-18 Optional Thread		ES3312R
	(FF961)		5.44"		ES423L	ES423R
14,600	(FG941)		5.44"	1-1/8"-18 Optional Thread		ES3312R
	(FG941)		5.44"		ES423L	ES423R
16,000	(FL941)		12.69"		ES3031L	ES3030R
	(FL941)		5.75"		ES431L	ES431R
	(FL941)		7.37"		ES2090L	ES2091R
18,000	(FL941)		12.69"		ES3031L	ES3030R
	(FL941)		5.75"		ES431L	ES431R
	(FL941)		7.37"		ES2090L	ES2091R
20,000	(FL941)		12.69"		ES3031L	ES3030R
	(FL941)		5.75"		ES431L	ES431R
	(FL941)		7.37"		ES2090L	ES2091R

AERO Series

King Bolt Sets

Axle Lbs. Rating	Code	Year	Diameter (inches)	Length (Inches)	Pin Type	Bushing	Notes	King Pin Set No.
12,000	(FF943)		1.794"	10.392"	2	Metal		8590B
	(FF961)		1.790"	10.390"	2	Composite		80063C
	(FF961)		1.790"	10.390"	2	Metal		80063B
	EFA-12F4		1.630"	9.200"	1	Composite		8618C

AERO Series (Cont'd)

King Bolt Sets (Cont'd)

Axle Lbs. Rating	Code	Year	Diameter (inches)	Length (Inches)	Pin Type	Bushing	Notes	King Pin Set No.
12,000	EFA-12F4		1.625"	9.200"	1	Metal		8647B
14,600	(FG943)		1.790"	10.390"	2	Metal		8611B

Tie Rod Ends

Axle Lbs. Rating	Code	Year	Length (Inches)	Notes	Tie Rod End Part No.				
					Drivers Side	Passenger Side			
12,000	(FF943)		5.44"	1-1/8"-18 Optional Thread	ES423L	ES3312R			
	(FF943)		5.44"						
	(FF961)		5.44"	1-1/8"-18 Optional Thread			ES423L	ES423R	
	(FF961)		5.44"						
	EFA-12F4		5.44"	ES423L					ES423R
	EFA-12F4		8.12"						
14,600	(FG943)		5.44"	1-1/8"-18 Optional Thread	ES3298L	ES423R			
	(FG943)		5.44"						

AUTOHAULER TRACTORS

King Bolt Sets

Axle Lbs. Rating	Code	Year	Diameter (inches)	Length (Inches)	Pin Type	Bushing	Notes	King Pin Set No.
12,000	(FF943)		1.794"	10.392"	2	Metal		8590B
	(FF961)		1.790"	10.390"	2	Composite		80063C
	(FF961)		1.790"	10.390"	2	Metal		80063B
	E-12001		1.794"	9.060"	1	Metal		80076B
	EFA-12F4		1.630"	9.200"	1	Composite		8618C
	EFA-12F4		1.625"	9.200"	1	Metal		8647B
14,600	(FG943)		1.790"	10.390"	2	Metal		8611B

Tie Rod Ends

Axle Lbs. Rating	Code	Year	Length (Inches)	Notes	Tie Rod End Part No.					
					Drivers Side	Passenger Side				
12,000	(FF943)		5.44"	1-1/8"-18 Optional Thread	ES423L	ES3312R				
	(FF943)		5.44"							
	(FF961)		5.44"	1-1/8"-18 Optional Thread			ES423L	ES423R		
	(FF961)		5.44"							
	E-12001		6.00"	ES423L					ES423R	
	EFA-12F4		5.44"							
	EFA-12F4		8.12"	ES3477						ES3476
14,600	(FG943)		5.44"	1-1/8"-18 Optional Thread	ES423L	ES3312R				
	(FG943)		5.44"							

VNL, VNM Series

Tie Rod Ends

Axle Lbs. Rating	Code	Year	Length (Inches)	Notes	Tie Rod End Part No.	
					Drivers Side	Passenger Side
12,500			6.00"	after 07 engine	ES3477	ES3476
			7.38"	after 07 engine		
13,200			6.00"	after 07 engine	ES3477	ES3476
			7.38"	after 07 engine		
14,600			6.00"	after 07 engine	ES3443L	ES3442R
			7.38"	after 07 engine		

WG Series

King Bolt Sets

Axle Lbs. Rating	Code	Year	Diameter (inches)	Length (Inches)	Pin Type	Bushing	Notes	King Pin Set No.
12,000	(FF961)		1.790"	10.390"	2	Composite		80063C
	(FF961)		1.790"	10.390"	2	Metal		80063B
	EFA-12F4		1.630"	9.200"	1	Composite		8618C
	EFA-12F4		1.625"	9.200"	1	Metal		8647B
14,600	(FG943)		1.790"	10.390"	2	Metal		8611B
16,000	(FL941)		1.999"	11.212"	2	Metal		8571B
	(FL943)		1.999"	11.212"	2	Metal		8571B
18,000	(FL941)		1.999"	11.212"	2	Metal		8571B

WG Series (Cont'd)

King Bolt Sets (Cont'd)

Axle Lbs. Rating	Code	Year	Diameter (inches)	Length (Inches)	Pin Type	Bushing	Notes	King Pin Set No.
18,000	(FL943)		1.999"	11.212"	2	Metal		8571B
20,000	(FL941)		1.999"	11.212"	2	Metal		8571B
	(FL943)		1.999"	11.212"	2	Metal		8571B

Tie Rod Ends

Axle Lbs. Rating	Code	Year	Length (Inches)	Notes	Tie Rod End Part No.	
					Drivers Side	Passenger Side
12,000	(FF961)		5.44"	1-1/8"-18 Optional Thread	ES423L	ES3312R
	(FF961)		5.44"			ES423R
	EFA-12F4		5.44"			ES423R
	EFA-12F4		8.12"			ES3297R
14,600	(FG943)		5.44"	1-1/8"-18 Optional Thread	ES423L	ES423R
	(FG943)		5.44"			ES3312R
16,000	(FL941)		12.69"		ES3031L	ES3030R
	(FL941)		5.75"			ES431R
	(FL941)		7.37"			ES2091R
	(FL943)		12.69"			ES3030R
	(FL943)		5.75"			ES431R
	(FL943)		7.37"			ES2091R
18,000	(FL941)		12.69"		ES3031L	ES3030R
	(FL941)		5.75"			ES431R
	(FL941)		7.37"			ES2091R
	(FL943)		12.69"			ES3030R
	(FL943)		5.75"			ES431R
	(FL943)		7.37"			ES2091R
20,000	(FL941)		12.69"		ES3031L	ES3030R
	(FL941)		5.75"			ES431R
	(FL941)		7.37"			ES2091R
	(FL943)		12.69"			ES3030R
	(FL943)		5.75"			ES431R
	(FL943)		7.37"			ES2091R

WHR, WIL, WIA Series

King Bolt Sets

Axle Lbs. Rating	Code	Year	Diameter (inches)	Length (Inches)	Pin Type	Bushing	Notes	King Pin Set No.
12,000	(FF943)		1.794"	10.392"	2	Metal		8590B
	(FF961)		1.790"	10.390"	2	Composite		80063C
	(FF961)		1.790"	10.390"	2	Metal		80063B
	EFA-12F4		1.630"	9.200"	1	Composite		8618C
	EFA-12F4		1.625"	9.200"	1	Metal		8647B
14,600	(FG943)		1.790"	10.390"	2	Metal		8611B

Tie Rod Ends

Axle Lbs. Rating	Code	Year	Length (Inches)	Notes	Tie Rod End Part No.	
					Drivers Side	Passenger Side
12,000	(FF943)		5.44"	1-1/8"-18 Optional Thread	ES423L	ES3312R
	(FF943)		5.44"			ES423R
	(FF961)		5.44"	1-1/8"-18 Optional Thread		ES3312R
	(FF961)		5.44"			ES423R
	EFA-12F4		5.44"	ES423R		
	EFA-12F4		8.12"	ES3297R		
14,600	(FG943)		5.44"	1-1/8"-18 Optional Thread	ES423L	ES3312R
	(FG943)		5.44"			ES423R

XPEDITOR

King Bolt Sets

Axle Lbs. Rating	Code	Year	Diameter (inches)	Length (Inches)	Pin Type	Bushing	Notes	King Pin Set No.
12,000	(FF943)		1.794"	10.392"	2	Metal		8590B
14,600	(FG943)		1.790"	10.390"	2	Metal		8611B
16,000	(FL941)		1.999"	11.212"	2	Metal		8571B
	(FL943)		1.999"	11.212"	2	Metal		8571B
18,000	(FL941)		1.999"	11.212"	2	Metal		8571B

XPEDITOR (Cont'd)

King Bolt Sets (Cont'd)

Axle Lbs. Rating	Code	Year	Diameter (inches)	Length (Inches)	Pin Type	Bushing	Notes	King Pin Set No.
18,000	(FL943)		1.999"	11.212"	2	Metal		8571B
20,000	(FL941)		1.999"	11.212"	2	Metal		8571B
	(FL943)		1.999"	11.212"	2	Metal		8571B

Tie Rod Ends

Axle Lbs. Rating	Code	Year	Length (Inches)	Notes	Tie Rod End Part No.	
					Drivers Side	Passenger Side
12,000	(FF943)		5.44"	1-1/8"-18 Optional Thread		ES3312R
	(FF943)		5.44"		ES423L	ES423R
14,600	(FG943)		5.44"	1-1/8"-18 Optional Thread	ES423L	ES423R
	(FG943)		5.44"			ES3312R
16,000	(FL941)		12.69"		ES3031L	ES3030R
	(FL941)		5.75"		ES431L	ES431R
	(FL941)		7.37"		ES2090L	ES2091R
	(FL943)		12.69"		ES3031L	ES3030R
	(FL943)		5.75"		ES431L	ES431R
	(FL943)		7.37"		ES2090L	ES2091R
18,000	(FL941)		12.69"		ES3031L	ES3030R
	(FL941)		5.75"		ES431L	ES431R
	(FL941)		7.37"		ES2090L	ES2091R
	(FL943)		12.69"		ES3031L	ES3030R
	(FL943)		5.75"		ES431L	ES431R
	(FL943)		7.37"		ES2090L	ES2091R
20,000	(FL941)		12.69"		ES3031L	ES3030R
	(FL941)		5.75"		ES431L	ES431R
	(FL941)		7.37"		ES2090L	ES2091R
	(FL943)		12.69"		ES3031L	ES3030R
	(FL943)		5.75"		ES431L	ES431R
	(FL943)		7.37"		ES2090L	ES2091R

Drag Links

Axle Lbs. Rating	Code	Year	Length (inches)	Notes	Drag Link No.
				Drag Link End-Use w/DS1026; Refer to O.E.M. or Compare with Old Part	ES2225R
				Drag Link End-Use w/DS1025 & DS1026,	
				Drag Link End-Use w/DS1024 RH Thread; Refer to O.E.M. or Compare with Old Part	ES2224L
				Drag Link End-Use w/DS1025 LH Thread	
				Drag Link End-Use w/DS1024 LH Thread; Refer to O.E.M. or Compare with Old Part	DS1033
			16.12"	Refer to O.E.M. or Compare with Old Part	DS1024
			18.38"	Has one fixed end; Refer to O.E.M. or Compare with Old Part	DS1026
			41.29"	Has one fixed end	DS1025

WESTERN STAR TRUCK MODEL FINDING INDEX			
Model	Model	Model	Model
123FA	123SA	3842S	3864S
4842	4864	49132EX	4942
4964	5842SS	5864SS	5942SS
5964SS	6964F	6964S	6969RL

123FA, 123SA, 49132EX

Tie Rod Ends

Axle Lbs. Rating	Code	Year	Length (Inches)	Notes	Tie Rod End Part No.	
					Drivers Side	Passenger Side
12,000		2010	6.00"		ES3477	ES3476

3842S, 3864S, 4842, 4864, 4942, 4964, 5842SS, 5864SS, 5942SS, 5964SS, 6964F, 6964S, 6969RL

King Bolt Sets

Axle Lbs. Rating	Code	Year	Diameter (inches)	Length (Inches)	Pin Type	Bushing	Notes	King Pin Set No.
12,000	EFA-12F4		1.630"	9.200"	1	Composite		8618C
	EFA-12F4		1.625"	9.200"	1	Metal		8647B
	FF961		1.790"	10.390"	2	Composite		80063C
	FF961		1.790"	10.390"	2	Metal		80063B
14,600	FG941		1.790"	10.390"	2	Metal		8611B
16,000	FL941		1.999"	11.212"	2	Metal		8571B
18,000	FL941		1.999"	11.212"	2	Metal		8571B
20,000	FL941		1.999"	11.212"	2	Metal		8571B

Tie Rod Ends

Axle Lbs. Rating	Code	Year	Length (Inches)	Notes	Tie Rod End Part No.	
					Drivers Side	Passenger Side
12,000	EFA-12F4		5.44"		ES423L	ES423R
	EFA-12F4		8.12"		ES3298L	ES3297R
	FF961		5.44"	1-1/8"-18 Optional Thread		ES3312R
	FF961		5.44"		ES423L	ES423R
14,600	FG941		5.44"	1-1/8"-18 Optional Thread		ES3312R
	FG941		5.44"		ES423L	ES423R
16,000	FL941		12.69"		ES3031L	ES3030R
	FL941		5.75"		ES431L	ES431R
	FL941		7.37"		ES2090L	ES2091R
18,000	FL941		12.69"		ES3031L	ES3030R
	FL941		5.75"		ES431L	ES431R
	FL941		7.37"		ES2090L	ES2091R
20,000	FL941		12.69"		ES3031L	ES3030R
	FL941		5.75"		ES431L	ES431R
	FL941		7.37"		ES2090L	ES2091R

WESTPORT AXLE TRUCK MODEL FINDING INDEX

Model	Model	Model	Model
F3W-1200	F3W-1400	F3W-1600	F3W-1800
F5W-0900	F6W-1200	F6W-1400	F6W-1600

F3W-1200

King Bolt Sets

Axle Lbs. Rating	Code	Year	Diameter (inches)	Length (Inches)	Pin Type	Bushing	Notes	King Pin Set No.
13,200			1.811"	10.531"	1	Metal		80055B
			1.811"	10.750"	1	Metal		8527B
			1.811"	10.531"	1	Metal		8605B

Tie Rod Ends

Axle Lbs. Rating	Code	Year	Length (Inches)	Notes	Tie Rod End Part No.	
					Drivers Side	Passenger Side
13,200			5.75"	W/3.5" drop axle	ES431L	ES431R

F3W-1400

King Bolt Sets

Axle Lbs. Rating	Code	Year	Diameter (inches)	Length (Inches)	Pin Type	Bushing	Notes	King Pin Set No.
14,600			1.811"	10.531"	1	Metal		80055B

Tie Rod Ends

Axle Lbs. Rating	Code	Year	Length (Inches)	Notes	Tie Rod End Part No.	
					Drivers Side	Passenger Side
14,600			5.75"	W/3.5" drop axle	ES431L	ES431R

F3W-1600

King Bolt Sets

Axle Lbs. Rating	Code	Year	Diameter (inches)	Length (Inches)	Pin Type	Bushing	Notes	King Pin Set No.
16,000			1.811"	10.531"	1	Metal		8605B

Tie Rod Ends

Axle Lbs. Rating	Code	Year	Length (Inches)	Notes	Tie Rod End Part No.	
					Drivers Side	Passenger Side
16,000			5.75"	W/3.5" drop axle	ES431L	ES431R

F3W-1800

Tie Rod Ends

Axle Lbs. Rating	Code	Year	Length (Inches)	Notes	Tie Rod End Part No.	
					Drivers Side	Passenger Side
18,000			5.75"	W/3.5" drop axle	ES431L	ES431R

F5W-0900

Tie Rod Ends

Axle Lbs. Rating	Code	Year	Length (Inches)	Notes	Tie Rod End Part No.	
					Drivers Side	Passenger Side
9,000			5.44"	W/5" drop axle	ES423L	ES423R

F6W-1200

King Bolt Sets

Axle Lbs. Rating	Code	Year	Diameter (inches)	Length (Inches)	Pin Type	Bushing	Notes	King Pin Set No.
13,200			1.811"	10.531"	1	Metal		80055B
			1.811"	10.750"	1	Metal		8527B
			1.811"	10.531"	1	Metal		8605B

F6W-1200 (Cont'd)

Tie Rod Ends

Axle Lbs. Rating	Code	Year	Length (Inches)	Notes	Tie Rod End Part No.	
					Drivers Side	Passenger Side
13,200			5.75"	W/5.625" drop axle	ES431L	ES431R

F6W-1400

King Bolt Sets

Axle Lbs. Rating	Code	Year	Diameter (inches)	Length (Inches)	Pin Type	Bushing	Notes	King Pin Set No.
14,600			1.811"	10.531"	1	Metal		80055B

Tie Rod Ends

Axle Lbs. Rating	Code	Year	Length (Inches)	Notes	Tie Rod End Part No.	
					Drivers Side	Passenger Side
14,600			5.75"	W/5.625" drop axle	ES431L	ES431R

F6W-1600

King Bolt Sets

Axle Lbs. Rating	Code	Year	Diameter (inches)	Length (Inches)	Pin Type	Bushing	Notes	King Pin Set No.
16,000			1.811"	10.531"	1	Metal		8605B

Tie Rod Ends

Axle Lbs. Rating	Code	Year	Length (Inches)	Notes	Tie Rod End Part No.	
					Drivers Side	Passenger Side
16,000			5.75"	W/5.625" drop axle	ES431L	ES431R

WHITE TRUCK MODEL FINDING INDEX			
Model	Model	Model	Model
4842	4864	4942	4964
FDS1805(FWD)	FDS1807(FWD)	RB2-42T	RB2-64T
RBW-42T	RBW-64T	RC2-42T	RC2-64T
RCW-42T	RCW-64T	RX2-42T	RX2-64T
WFC-12042T	WFC-12064	WFC-12064T	WFP-6342T
WFP-6364	WFP-6364T	WFP-7564T	WFT-6342T
WFT-6364	WFT-6364T	WFT-7564T	WFT-8164T
WFT-9664T	WHITE AXLES	WSH-42T	WSH-64T

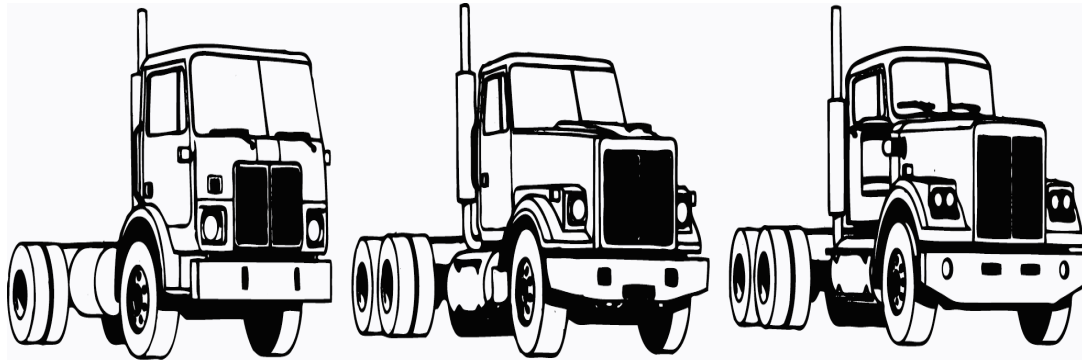

Road Xpeditor 2

Road Boss 2

Western Star Conventional

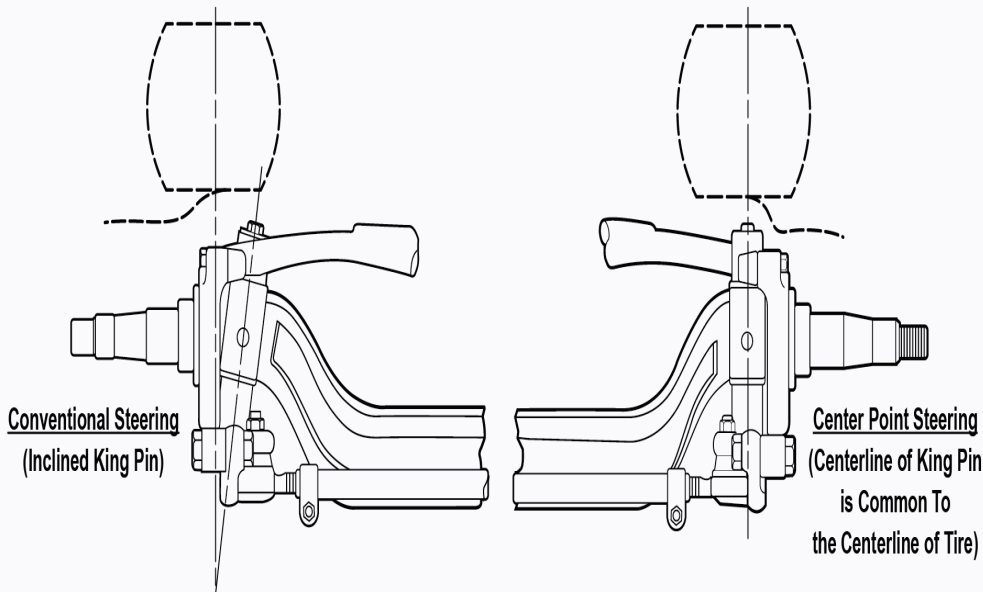

Conventional Steering
(Inclined King Pin)

Center Point Steering
(Centerline of King Pin
is Common To
the Centerline of Tire)

FDS1807(FWD), FDS1805(FWD)

Tie Rod Ends

Axle Lbs. Rating	Code	Year	Length (Inches)	Notes	Tie Rod End Part No.	
					Drivers Side	Passenger Side
18,000			5.75"	Front Drive Axle		ES2208R

RB2-42T, 4842, 4864, 4942, 4964

King Bolt Sets

Axle Lbs. Rating	Code	Year	Diameter (inches)	Length (Inches)	Pin Type	Bushing	Notes	King Pin Set No.
12,000	F6W-1200		1.811"	10.531"	1	Metal		8605B
	FF933		1.794"	10.392"	2	Metal		8590B
14,000	F6W-1400		1.811"	10.531"	1	Metal		80055B
20,000	FL931		1.999"	11.212"	2	Metal		8571B

RB2-42T, 4842, 4864, 4942, 4964 (Cont'd)

Tie Rod Ends

Axle Lbs. Rating	Code	Year	Length (Inches)	Notes	Tie Rod End Part No.	
					Drivers Side	Passenger Side
12,000	F6W-1200		5.44"	1-1/8"-18 Optional Thread	ES423L	ES423R
	FF933		ES3312R			
	FF933		ES423R			
14,000	F6W-1400		5.75"		ES431L	ES431R
20,000	FL931		12.69"		ES3031L	ES3030R
	FL931		ES431R			
	FL931		ES2091R			

RB2-64T

King Bolt Sets

Axle Lbs. Rating	Code	Year	Diameter (inches)	Length (Inches)	Pin Type	Bushing	Notes	King Pin Set No.
12,000	F6W-1200		1.811"	10.531"	1	Metal		8605B
	FF933		1.794"	10.392"	2	Metal		8590B
14,000	F6W-1400		1.811"	10.531"	1	Metal		80055B
20,000	FL931		1.999"	11.212"	2	Metal		8571B

Tie Rod Ends

Axle Lbs. Rating	Code	Year	Length (Inches)	Notes	Tie Rod End Part No.	
					Drivers Side	Passenger Side
12,000	F6W-1200		5.44"	1-1/8"-18 Optional Thread	ES423L	ES423R
	FF933		ES3312R			
	FF933		ES423R			
14,000	F6W-1400		5.75"		ES431L	ES431R
20,000	FL931		12.69"		ES3031L	ES3030R
	FL931		ES431R			
	FL931		ES2091R			

Drag Links

Axle Lbs. Rating	Code	Year	Length (inches)	Notes	Drag Link No.
			41.29"	Drag Link End-Use w/DS1026; Refer to O.E.M. or Compare with Old Part Has one fixed end; Refer to O.E.M. or Compare with Old Part	ES2225R DS1026

RBW-42T

King Bolt Sets

Axle Lbs. Rating	Code	Year	Diameter (inches)	Length (Inches)	Pin Type	Bushing	Notes	King Pin Set No.
12,000	F6W-1200		1.811"	10.531"	1	Metal		8605B
	FF933		1.794"	10.392"	2	Metal		8590B
14,000	F6W-1400		1.811"	10.531"	1	Metal		80055B

Tie Rod Ends

Axle Lbs. Rating	Code	Year	Length (Inches)	Notes	Tie Rod End Part No.	
					Drivers Side	Passenger Side
12,000	F6W-1200		5.44"	1-1/8"-18 Optional Thread	ES423L	ES423R
	FF933		ES3312R			
	FF933		ES423R			
14,000	F6W-1400		5.75"		ES431L	ES431R

Drag Links

Axle Lbs. Rating	Code	Year	Length (inches)	Notes	Drag Link No.
			16.12"	Refer to O.E.M. or Compare with Old Part	DS1033

RBW-64T

King Bolt Sets

Axle Lbs. Rating	Code	Year	Diameter (inches)	Length (Inches)	Pin Type	Bushing	Notes	King Pin Set No.
12,000	F6W-1200		1.811"	10.531"	1	Metal		8605B
	FF933		1.794"	10.392"	2	Metal		8590B
14,000	F6W-1400		1.811"	10.531"	1	Metal		80055B

WHITE TRUCK

RBW-64T (Cont'd)

Tie Rod Ends

Axle Lbs. Rating	Code	Year	Length (Inches)	Notes	Tie Rod End Part No.		
					Drivers Side	Passenger Side	
12,000	F6W-1200		5.44"	1-1/8"-18 Optional Thread	ES423L	ES423R	
	FF933		5.44"				ES3312R
	FF933		5.44"				ES423R
14,000	F6W-1400		5.75"		ES431L	ES431R	

Drag Links

Axle Lbs. Rating	Code	Year	Length (inches)	Notes	Drag Link No.
			41.29"	Drag Link End-Use w/DS1026; Refer to O.E.M. or Compare with Old Part Has one fixed end; Refer to O.E.M. or Compare with Old Part	ES2225R DS1026

RC2-42T, RC2-64T

King Bolt Sets

Axle Lbs. Rating	Code	Year	Diameter (inches)	Length (Inches)	Pin Type	Bushing	Notes	King Pin Set No.
12,000	F6W-1200		1.811"	10.531"	1	Metal		8605B
	FF933		1.794"	10.392"	2	Metal		8590B
14,000	F6W-1400		1.811"	10.531"	1	Metal		80055B
20,000	FL931		1.999"	11.212"	2	Metal		8571B

Tie Rod Ends

Axle Lbs. Rating	Code	Year	Length (Inches)	Notes	Tie Rod End Part No.			
					Drivers Side	Passenger Side		
12,000	F6W-1200		5.44"	1-1/8"-18 Optional Thread	ES423L	ES423R		
	FF933		5.44"				ES3312R	
	FF933		5.44"				ES423R	
14,000	F6W-1400		5.75"		ES431L	ES431R		
20,000	FL931		12.69"		ES3031L	ES3030R		
	FL931		5.75"				ES431L	ES431R
	FL931		7.37"				ES2090L	ES2091R

Drag Links

Axle Lbs. Rating	Code	Year	Length (inches)	Notes	Drag Link No.
			18.38"	Drag Link End-Use w/DS1024; Refer to O.E.M. or Compare with Old Part Refer to O.E.M. or Compare with Old Part	ES2225R ES2224L DS1024

RCW-42T, WSH-42T, WSH-64T

King Bolt Sets

Axle Lbs. Rating	Code	Year	Diameter (inches)	Length (Inches)	Pin Type	Bushing	Notes	King Pin Set No.
12,000	F6W-1200		1.811"	10.531"	1	Metal		8605B
	FF933		1.794"	10.392"	2	Metal		8590B
14,000	F6W-1400		1.811"	10.531"	1	Metal		80055B

Tie Rod Ends

Axle Lbs. Rating	Code	Year	Length (Inches)	Notes	Tie Rod End Part No.		
					Drivers Side	Passenger Side	
12,000	F6W-1200		5.44"	1-1/8"-18 Optional Thread	ES423L	ES423R	
	FF933		5.44"				ES3312R
	FF933		5.44"				ES423R
14,000	F6W-1400		5.75"		ES431L	ES431R	

RCW-64T

King Bolt Sets

Axle Lbs. Rating	Code	Year	Diameter (inches)	Length (Inches)	Pin Type	Bushing	Notes	King Pin Set No.
12,000	F6W-1200		1.811"	10.531"	1	Metal		8605B
	FF933		1.794"	10.392"	2	Metal		8590B
14,000	F6W-1400		1.811"	10.531"	1	Metal		80055B

RCW-64T (Cont'd)

Tie Rod Ends

Axle Lbs. Rating	Code	Year	Length (Inches)	Notes	Tie Rod End Part No.		
					Drivers Side	Passenger Side	
12,000	F6W-1200		5.44"	1-1/8"-18 Optional Thread	ES423L	ES423R	
	FF933		5.44"				ES3312R
	FF933		5.44"				ES423R
14,000	F6W-1400		5.75"		ES431L	ES431R	

Drag Links

Axle Lbs. Rating	Code	Year	Length (inches)	Notes	Drag Link No.
			18.38"	Drag Link End-Use w/DS1024; Refer to O.E.M. or Compare with Old Part Refer to O.E.M. or Compare with Old Part	ES2225R ES2224L DS1024

RX2-42T

King Bolt Sets

Axle Lbs. Rating	Code	Year	Diameter (inches)	Length (Inches)	Pin Type	Bushing	Notes	King Pin Set No.
12,000	F6W-1200 FF933		1.811"	10.531"	1	Metal		8605B
			1.794"	10.392"	2	Metal		8590B
14,000	F6W-1400		1.811"	10.531"	1	Metal		80055B
20,000	FL931		1.999"	11.212"	2	Metal		8571B

Tie Rod Ends

Axle Lbs. Rating	Code	Year	Length (Inches)	Notes	Tie Rod End Part No.		
					Drivers Side	Passenger Side	
12,000	F6W-1200 FF933 FF933		5.44"	1-1/8"-18 Optional Thread	ES423L	ES423R	
			5.44"				ES3312R
			5.44"				ES423R
14,000	F6W-1400		5.75"		ES431L	ES431R	
20,000	FL931 FL931 FL931		12.69"		ES3031L	ES3030R	
			5.75"				ES431R
			7.37"				ES2090L ES2091R

Drag Links

Axle Lbs. Rating	Code	Year	Length (inches)	Notes	Drag Link No.
			41.29"	Drag Link End-Use w/DS1025 & DS1026; Refer to O.E.M. or Compare with Old Part Drag Link End-Use w/DS1025; Refer to O.E.M. or Compare with Old Part Has one fixed end; Refer to O.E.M. or Compare with Old Part Refer to O.E.M. or Compare with Old Part	ES2225R ES2224L DS1026 DS1025

RX2-64T

King Bolt Sets

Axle Lbs. Rating	Code	Year	Diameter (inches)	Length (Inches)	Pin Type	Bushing	Notes	King Pin Set No.
12,000	F6W-1200 FF933		1.811"	10.531"	1	Metal		8605B
			1.794"	10.392"	2	Metal		8590B
14,000	F6W-1400		1.811"	10.531"	1	Metal		80055B
20,000	FL931		1.999"	11.212"	2	Metal		8571B

Tie Rod Ends

Axle Lbs. Rating	Code	Year	Length (Inches)	Notes	Tie Rod End Part No.		
					Drivers Side	Passenger Side	
12,000	F6W-1200 FF933 FF933		5.44"	1-1/8"-18 Optional Thread	ES423L	ES423R	
			5.44"				ES3312R
			5.44"				ES423R
14,000	F6W-1400		5.75"		ES431L	ES431R	
20,000	FL931 FL931 FL931		12.69"		ES3031L	ES3030R	
			5.75"				ES431R
			7.37"				ES2090L ES2091R

Drag Links

Axle Lbs. Rating	Code	Year	Length (inches)	Notes	Drag Link No.
				Drag Link End-Use w/DS1025 & DS1026; Refer to O.E.M. or Compare with Old Part	ES2225R

WHITE TRUCK

RX2-64T (Cont'd)

Drag Links (Cont'd)

Axle Lbs. Rating	Code	Year	Length (inches)	Notes	Drag Link No.
			41.29"	Drag Link End-Use w/DS1025; Refer to O.E.M. or Compare with Old Part Has one fixed end; Refer to O.E.M. or Compare with Old Part Refer to O.E.M. or Compare with Old Part	ES2224L DS1026 DS1025

WFC-12042T, WFC-12064, WFC-12064T

King Bolt Sets

Axle Lbs. Rating	Code	Year	Diameter (inches)	Length (Inches)	Pin Type	Bushing	Notes	King Pin Set No.
12,000	(FE900)		1.309/1.607"	9.750"	7	Metal		8386B
	(FE900)		1.309/1.607"	9.750"	7	Nylon		8386N
	(FE970)		1.607"	8.812"	2	Metal		8514B
	(FE970)		1.607"	8.812"	2	Nylon		8514N
	(FF901)		1.794"	9.120"	2	Metal		8489B
	(FF901)		1.794"	9.120"	2	Nylon		8489N
	(FF921)		1.794"	10.392"	2	Metal		8553B
	(FF931)		1.794"	10.392"	2	Metal		8590B
16,000	(FH901)		1.999"	11.040"	2	Metal		8518B
	(FH901)		1.999"	11.040"	2	Nylon		8518N
	(FL931)		1.999"	11.212"	2	Metal		8571B
18,000	(FL901)		1.999"	11.040"	2	Metal		8518B
	(FL901)		1.999"	11.040"	2	Nylon		8518N

Tie Rod Ends

Axle Lbs. Rating	Code	Year	Length (Inches)	Notes	Tie Rod End Part No.	
					Drivers Side	Passenger Side
12,000	(FE900)		4.88"	Will Retrofit Older Axles	ES187L	ES187R
	(FE900)		5.75"		ES431L	ES431R
	(FE970)		10.50"		ES2200L	ES2201R
	(FE970)		4.88"		ES187L	ES187R
	(FE970)		5.75"		ES431L	ES431R
	(FF901)		4.88"		ES187L	ES187R
	(FF901)		5.75"	Anti-Tilt Seal Type Conventional Seal Type	ES346L	ES346R
	(FF901)		5.75"		ES431L	ES431R
	(FF921)		5.44"	1-1/8"-18 Optional Thread		ES3312R
	(FF921)		5.44"		ES423L	ES423R
	(FF931)		5.44"		ES423L	ES423R
	(FF931)		5.44"	1-1/8"-18 Optional Thread		ES3312R
16,000	(FH901)		5.75"		ES431L	ES431R
	(FL931)		12.69"		ES3031L	ES3030R
	(FL931)		5.75"		ES431L	ES431R
	(FL931)		7.37"		ES2090L	ES2091R
18,000	(FL901)		5.75"		ES431L	ES431R

Drag Links

Axle Lbs. Rating	Code	Year	Length (inches)	Notes	Drag Link No.
12,000				Drag Link End-LH Thread Drag Link End-RH Thread	ES434L ES431R ES2113R
16,000				Drag Link End-LH Thread Drag Link End-RH Thread	ES434L ES431R ES2113R
18,000				Drag Link End-LH Thread Drag Link End-RH Thread	ES434L ES431R ES2113R

WFP-6342T, WFP-6364, WFP-6364T, WFP-7564T, WFT-6342T, WFT-6364, WFT-6364T, WFT-7564T, WFT-8164T, WFT-9664T

King Bolt Sets

Axle Lbs. Rating	Code	Year	Diameter (inches)	Length (Inches)	Pin Type	Bushing	Notes	King Pin Set No.
12,000	(FE900)		1.309/1.607"	9.750"	7	Metal		8386B
	(FE900)		1.309/1.607"	9.750"	7	Nylon		8386N
	(FE970)		1.607"	8.812"	2	Metal		8514B
	(FE970)		1.607"	8.812"	2	Nylon		8514N
	(FF901)		1.794"	9.120"	2	Metal		8489B
	(FF901)		1.794"	9.120"	2	Nylon		8489N

WFP-6342T, WFP-6364, WFP-6364T, WFP-7564T, WFT-6342T, WFT-6364, WFT-6364T, WFT-7564T, WFT-8164T, WFT-9664T (Cont'd)

King Bolt Sets (Cont'd)

Axle Lbs. Rating	Code	Year	Diameter (inches)	Length (Inches)	Pin Type	Bushing	Notes	King Pin Set No.
12,000	(FF921)		1.794"	10.392"	2	Metal		8553B
	(FF931)		1.794"	10.392"	2	Metal		8590B
16,000	(FH901)		1.999"	11.040"	2	Metal		8518B
	(FH901)		1.999"	11.040"	2	Nylon		8518N
	(FL931)		1.999"	11.212"	2	Metal		8571B
18,000	(FL901)		1.999"	11.040"	2	Metal		8518B
	(FL901)		1.999"	11.040"	2	Nylon		8518N

Tie Rod Ends

Axle Lbs. Rating	Code	Year	Length (Inches)	Notes	Tie Rod End Part No.	
					Drivers Side	Passenger Side
12,000	(FE900)		4.88"	Will Retrofit Older Axles	ES187L	ES187R
	(FE900)		5.75"		ES431L	ES431R
	(FE970)		10.50"		ES2200L	ES2201R
	(FE970)		4.88"		ES187L	ES187R
	(FE970)		5.75"		ES431L	ES431R
	(FF901)		4.88"		ES187L	ES187R
	(FF901)		5.75"	Anti-Tilt Seal Type	ES346L	ES346R
	(FF901)		5.75"	Conventional Seal Type	ES431L	ES431R
	(FF921)		5.44"	1-1/8"-18 Optional Thread		ES3312R
	(FF921)		5.44"		ES423L	ES423R
	(FF931)		5.44"		ES423L	ES423R
	(FF931)		5.44"	1-1/8"-18 Optional Thread		ES3312R
16,000	(FH901)		5.75"		ES431L	ES431R
	(FL931)		12.69"		ES3031L	ES3030R
	(FL931)		5.75"		ES431L	ES431R
	(FL931)		7.37"		ES2090L	ES2091R
18,000	(FL901)		5.75"		ES431L	ES431R

Drag Links

Axle Lbs. Rating	Code	Year	Length (inches)	Notes	Drag Link No.
12,000	(All)		23.44"		DS999
16,000	(All)		23.44"		DS999
18,000	(All)		23.44"		DS999

WHITE AXLES

King Bolt Sets

Axle Lbs. Rating	Code	Year	Diameter (inches)	Length (Inches)	Pin Type	Bushing	Notes	King Pin Set No.
10,000	F3-100		1.811"	10.375"	1	Metal		80056B
	F3W-100		1.811"	10.375"	1	Metal		80056B
	F5-100		1.811"	10.375"	1	Metal		80056B
	F5W-100		1.811"	10.375"	1	Metal		80056B
	F6-100		1.811"	10.375"	1	Metal		80056B
	F6W-100		1.811"	10.375"	1	Metal		80056B
12,000	F120		1.811"	10.750"	1	Metal		8527B
	F3-120		1.811"	10.750"	1	Metal		8527B
	F3W-120		1.811"	10.750"	1	Metal		8527B
	F5-120		1.811"	10.750"	1	Metal		8527B
	F5W-120		1.811"	10.750"	1	Metal		8527B
	F6W-120		1.811"	10.750"	1	Metal		8527B
14,000	F5-140		1.811"	10.750"	1	Metal		8527B
	F5W-140		1.811"	10.750"	1	Metal		8527B
	F6W-140		1.811"	10.531"	1	Metal		80055B

WORKHORSE TRUCK MODEL FINDING INDEX

Model	Model	Model	Model
UFO, Motorhome			

UFO, Motorhome

Tie Rod Ends

Axle Lbs. Rating	Code	Year	Length (Inches)	Notes	Tie Rod End Part No.	
					Drivers Side	Passenger Side
9,000			6.00"		ES3477	ES3476
10,000			6.00"		ES3477	ES3476

Heavy Duty Chassis Parts Numerical/Buyers Guide

Drag Links		Part Number	Application
DS1020	NAVISTAR/IHC TRUCK ; NAVISTAR/IHC TRUCK 9300, 9400 Series, 9600, 9700 Series, CO9670, COF9670, Eagle	DS1192	
DS1021	NAVISTAR/IHC TRUCK S Series Medium Duty Models 1624, 1654, 1658, 1723, 1724, 1753, 1754, 1758, 1823, 1824, 1853, 1854, 1858, 1924, F1924, 1925, 1954, F1954, 1955, 1958, 2125, F2125, 2155	DS1195	CHEVROLET TRUCK P40; GMC TRUCK P4500
DS1022	NAVISTAR/IHC TRUCK ; NAVISTAR/IHC TRUCK S Series Heavy Duty Models 2275, F2275, 2276, F2276, 2375, F2375, 2524, F2524, 2554, F2554, 2574, F2574, 2575, F2575, 2624, F2624, F2654, 2674, F2674, 2675, F2675, S Series Medium Duty Models 1624, 1654, 1658, 1723, 1724, 1753, 1754, 1758, 1823, 1824, 185	DS1196	
DS1024	VOLVO/WHITE/GMC XPEDITOR; WHITE TRUCK ; WHITE TRUCK RC2-42T, RC2-64T, RCW-64T	DS1197	CHEVROLET TRUCK P60; GMC TRUCK P6000
DS1025	VOLVO/WHITE/GMC XPEDITOR; WHITE TRUCK ; WHITE TRUCK RX2-42T, RX2-64T	DS1198	CHEVROLET TRUCK ; CHEVROLET TRUCK B60, B6P, C60, C6D, Kodiak, C70, C7D, Kodiak, P60; GMC TRUCK ; GMC TRUCK B6000, B6P, C6000, C6D, Topkick, C7500, C7D, Topkick, P6000
DS1026	VOLVO/WHITE/GMC XPEDITOR; WHITE TRUCK ; WHITE TRUCK RB2-64T, RBW-64T, RX2-42T, RX2-64T	DS1199	
DS1027	NAVISTAR/IHC TRUCK Transtar Models 4200, F4200, 4300, F4300	DS1200	CHEVROLET TRUCK ; CHEVROLET TRUCK C60, C6D, Kodiak, C70, C7D, Kodiak; GMC TRUCK ; GMC TRUCK C6000, C6D, Topkick, C7500, C7D, Topkick
DS1028	NAVISTAR/IHC TRUCK ; NAVISTAR/IHC TRUCK Transtar Models 4200, F4200, 4300, F4300, Transtar Models C04070B, COF4070B, F4170, F4070B, F4070B, F4170	DS1203	FORD TRUCK ; FORD TRUCK L800, LA800, L900, LA900, LL900, LN900, L9000, LN9000, LNT900, LT900, LNT8000, LT8000, LNT9000, LT9000, LS800, LT800, LTL800, LTS800, LTS8000, LTL900, LTA 900, LTL9000, LTS900, LS900, LTS9000, LS9000
DS1030	NAVISTAR/IHC TRUCK S Series Heavy Duty Models 2275, F2275, 2276, F2276, 2375, F2375, 2524, F2524, 2554, F2554, 2574, F2574, 2575, F2575, 2624, F2624, F2654, 2674, F2674, 2675, F2675, S Series Medium Duty Models 1624, 1654, 1658, 1723, 1724, 1753, 1754, 1758, 1823, 1824, 185	DS1204	FORD TRUCK ; FORD TRUCK B600, B6000, B700, B7000, F600, FT600, F700, FT700, F800, F8000, FT800, F900, FT900
DS1031		DS1205	FORD TRUCK ; FORD TRUCK C600, CT600, C700, CT700, C750, C7000, C800, C8000, CT8000, C900, CT900, C9000, CT800
DS1033	VOLVO/WHITE/GMC XPEDITOR; WHITE TRUCK RBW-42T	DS1206	FORD TRUCK ; FORD TRUCK C800, C8000, CT8000, CT800
DS1034	NAVISTAR/IHC TRUCK ; NAVISTAR/IHC TRUCK S Series Heavy Duty Models 2275, F2275, 2276, F2276, 2375, F2375, 2524, F2524, 2554, F2554, 2574, F2574, 2575, F2575, 2624, F2624, F2654, 2674, F2674, 2675, F2675, S Series Medium Duty Models 1624, 1654, 1658, 1723, 1724, 1753, 1754, 1758, 1823, 1824, 185	DS1207	FORD TRUCK ; FORD TRUCK L800, LA800, L900, LA900, LL900, LN900, L9000, LN9000, LN800, L8000, LN8000, LNT800, LNT900, LT900, LNT8000, LT8000, LNT9000, LT9000, LS800, LT800, LTL800, LTS800, LTS8000, LTS900, LS900, LTS9000, LS9000
DS1035	FORD TRUCK ; FORD TRUCK C600, CT600, C700, CT700, C750, C7000, C800, C8000, CT8000, C900, CT900, C9000, CT800	DS1214	NAVISTAR/IHC TRUCK ; NAVISTAR/IHC TRUCK 2554, 2574, 2654, 2674 Series (Built 1989 & Later), 7100 Series, 8100, 8200, 8300 Series (Built 1989 & Later); THOMAS BUILT Type C Saf-T-Liner Vista
DS1044	CHEVROLET TRUCK ; CHEVROLET TRUCK Bison, Bruin, Titan; GMC TRUCK ; GMC TRUCK Astro, D9K, D9L, Brigadier, J8C, J9C, General, N9E, N9F	DS1215	NAVISTAR/IHC TRUCK ; NAVISTAR/IHC TRUCK 7100 Series, M1400, M1600, 1452, 1652 Series Medium Duty; THOMAS BUILT Type C Saf-T-Liner Vista
DS1064	CHEVROLET TRUCK ; CHEVROLET TRUCK B60, B6P, C50, C5D, Kodiak, C60, C6D, Kodiak, C65, C70, C7D, Kodiak, M60, M65, P60, S60; GMC TRUCK ; GMC TRUCK B6000, B6P, C5000, C5D, Topkick, C5500, C6000, C6D, Topkick, C6500, C7500, C7D, Topkick, M6000, M6500, P6000, S6000	DS1216	CHEVROLET TRUCK ; CHEVROLET TRUCK B7T, C50, C5D, Kodiak, C60, C6D, Kodiak, C70, C7D, Kodiak, P60, P6S, T5500, T6500, T7500, T8500; GMC TRUCK ; GMC TRUCK B7T, C5000, C5D, Topkick, C6000, C6D, Topkick, C7500, C7D, Topkick, P6000, P6S
DS1067	CHEVROLET TRUCK Bison; GMC TRUCK ; GMC TRUCK Astro, D9K, D9L, Brigadier, J8C, J9C, General, N9E, N9F	DS1217	CHEVROLET TRUCK ; CHEVROLET TRUCK B7T, C70, C7D, Kodiak, T5500, T6500, T7500, T8500; GMC TRUCK ; GMC TRUCK B7T, C7500, C7D, Topkick
DS1136	FREIGHTLINER ALL MODELS	DS1218	FREIGHTLINER ALL MODELS
DS1179	PETERBILT ; PETERBILT 252, 282, 289, 300, 348, 352, 352H, 353, 359, 310, 320, 330, 357, 362, 372, 375, 376, 377, 378, 379, 385, 387	DS1219	
DS1180		DS1220	
DS1182		DS1221	
DS1184		DS1234	FORD TRUCK ; FORD TRUCK CF600, CF700, CF800, CFT800
DS1185		DS1253	MACK ; MACK DM400, DM600, DM606S, DM607S, DM685S, DM685T, DM800, MB400, MB600, R600, R685R, R685ST, R686ST, RD400, RD600, R700, U600, U68ST, F700, F786ST, R767ST
DS1190	FORD TRUCK ; FORD TRUCK B600, B6000, B700, B7000, F700, FT900	DS1254	MACK ; MACK R487P, R600, R685R, R685ST, R686ST
DS1191	FORD TRUCK ; FORD TRUCK B600, B6000, B700, B7000, F600, FT600, F700, FT700, F800, F8000, FT800, F900, FT900	DS1259	FORD TRUCK ; FORD TRUCK B600, B6000, B700, B7000, F600, FT600, F700, FT700, F800, F8000, FT800, F900, FT900
		DS1263	NAVISTAR/IHC TRUCK COF5870
		DS1264	NAVISTAR/IHC TRUCK 8100, 8200, 8300 Series (Built 1989 & Later)

Heavy Duty Chassis Parts Numerical/Buyers Guide

Drag Links (Cont'd)		Part Number	Application
DS1265	FORD TRUCK ; FORD TRUCK L800, LA800, L900, LA900, LL900, LN900, L9000, LN9000, LN800, L8000, LN8000, LNT900, LT900, LNT8000, LT8000, LNT9000, LT9000, LS800, LT800, LTL800, LTS800, LTS8000, LTL900, LTA 900, LTL9000	DS1337	FREIGHTLINER ALL MODELS
DS1266	FORD TRUCK ; FORD TRUCK L800, LA800, L900, LA900, LL900, LN900, L9000, LN9000, LNT900, LT900, LNT8000, LT8000, LNT9000, LT9000, LS800, LTL800, LTS800, LTS8000, LTL900, LTA 900, LTL9000, LTS900, LS900, LTS9000, LS9000	DS1340	
DS1267	FORD TRUCK ; FORD TRUCK L800, LA800, L900, LA900, LL900, LN900, L9000, LN9000, LN800, L8000, LN8000, LNT900, LT900, LNT8000, LT8000, LNT9000, LT9000, LS800, LT800, LTL800, LTS800, LTS8000, LTL900, LTA 900, LTL9000	DS1344	
DS1268	FORD TRUCK ; FORD TRUCK L800, LA800, L900, LA900, LL900, LN900, L9000, LN9000, LNT900, LT900, LNT8000, LT8000, LNT9000, LT9000, LS800, LT800, LTL800, LTS800, LTS8000, LTL900, LTA 900, LTL9000, LTS900, LS900, LTS9000, LS9000	DS1350	
DS1269	FORD TRUCK LLA900, LLS900, LTLA900, LTLS900	DS1366	FORD TRUCK ; FORD TRUCK B600, B6000, B700, B7000, F600, FT600, F700, FT700, F800, F8000, FT800, F900, FT900
DS1270	FORD TRUCK ; FORD TRUCK L800, LA800, L900, LA900, LL900, LN900, L9000, LN9000, LLA900, LLS900, LTLA900, LTLS900, LN800, L8000, LN8000, LN8000, LNT800, LNT900, LT900, LNT8000, LT8000, LNT9000, LT9000, LS800, LT800, LTL800, LTS800, LTS8000, LTL9000	DS1369	
DS1271	FORD TRUCK ; FORD TRUCK B600, B6000, B700, B7000, F600, FT600, F700, FT700, F800, F8000, FT800, F900, FT900	DS1370	FORD TRUCK ; FORD TRUCK B600, B6000, B700, B7000, B7000, F600, F700, FT700, F800, F8000, FT800, F900, FT900
DS1272		DS1371	FORD TRUCK ; FORD TRUCK B600, B6000, B7000, F600, F700, FT700, F800, F8000, FT800, F900, FT900
DS1273	FREIGHTLINER ALL MODELS	DS1409	FORD TRUCK LLA900, LLS900, LTLA900, LTLS900
DS1274		DS1442	FORD TRUCK ; FORD TRUCK Aeromax Series, A85, AT85, A95, AT95, Louisville Series, L85, LT85, L95, LT95
DS1275		DS1443	
DS1276		DS1444	
DS1277	CHEVROLET TRUCK ; CHEVROLET TRUCK C50, C5D, Kodiak, C60, C6D, Kodiak, C70, C7D, Kodiak, T5500, T6500, T7500, T8500; GMC TRUCK ; GMC TRUCK C5000, C5D, Topkick, C6000, C6D, Topkick, C7500, C7D, Topkick	DS1445	
DS1278	CHEVROLET TRUCK ; CHEVROLET TRUCK C70, C7D, Kodiak, T5500, T6500, T7500, T8500; GMC TRUCK C7500, C7D, Topkick	DS1446	
DS1281	NAVISTAR/IHC TRUCK 2554, 2574, 2654, 2674 Series (Built 1989 & Later)	DS1447	
DS1283	PETERBILT ; PETERBILT 252, 282, 289, 300, 348, 352, 352H, 353, 359, 310, 320, 330, 357, 362, 372, 375, 376, 377, 378, 379, 385, 387	DS1448	
DS1291A	NAVISTAR/IHC TRUCK 8100, 8200, 8300 Series (Built 1989 & Later)	DS1454	KENWORTH T800, T800B, Conventional Cab
DS1293	NAVISTAR/IHC TRUCK ; NAVISTAR/IHC TRUCK 9600, 9700 Series, CO9670, COF9670, Eagle	DS300001	MACK
DS1294A	NAVISTAR/IHC TRUCK ; NAVISTAR/IHC TRUCK 9200 Series, 9300, 9400 Series	DS300002	FREIGHTLINER ; FREIGHTLINER C112, C120 CENTURY CLASS, CONVENTIONAL CAB, Columbia
DS1295A		DS584	CHEVROLET TRUCK ; CHEVROLET TRUCK N,P (Second Series), 4A, 4B, R (Second Series), 4C, Regular School Bus 6A, 6B, 6C, 6D, 6E (except Heavy Duty), School Bus 6D, 6E (Heavy Duty); F1850 6A (Regular) 6B, 6C Heavy Duty
DS1298		DS659	FORD TRUCK ; FORD TRUCK B500, F500, B600, B6000, F600, FT600
DS1299A	NAVISTAR/IHC TRUCK COF5870	DS685	FORD TRUCK ; FORD TRUCK P400, P500, P600
DS1302	NAVISTAR/IHC TRUCK ; NAVISTAR/IHC TRUCK 8100, 8200, 8300 Series (Built 1989 & Later), S Series Heavy Duty Models 2275, F2275, 2276, F2276, 2375, F2375, 2524, F2524, 2554, F2554, 2574, F2574, 2575, F2575, 2624, F2624, F2654, 2674, F2674, 2675, F2675, S Series Medium Duty Models 1624, 1654, 1658,	DS733	FORD TRUCK ; FORD TRUCK B600, B6000, B700, B7000, F600, FT600
DS1303	NAVISTAR/IHC TRUCK 2554, 2574, 2654, 2674 Series (Built 1989 & Later)	DS800	FORD TRUCK ; FORD TRUCK B500, F500, B600, B6000, B700, B7000, F600, FT600, F700, FT700, F750, F800, F8000, FT800, FT900, LN500
DS1305	NAVISTAR/IHC TRUCK 4600, 4700, 4800, 4900 Series	DS803	FORD TRUCK ; FORD TRUCK B600, B6000, B700, B7000, F600, FT600, F700, FT700, F750, F800, F8000, FT800
DS1313	MACK ; MACK MC400, MC600, MR400, MR600	DS835	CHEVROLET TRUCK ; CHEVROLET TRUCK C40, C50, C5D, Kodiak, C60, C6D, Kodiak, S50, Q50, S60; GMC TRUCK ; GMC TRUCK C4500, C5000, C5D, Topkick, C6000, C6D, Topkick, S5500, S6000
		DS845	FORD TRUCK ; FORD TRUCK LN500, LN600, LN700
		DS867	DODGE TRUCK ; DODGE TRUCK D500, D600, D700, DL400, P400, PL400, S600
		DS872	FORD TRUCK ; FORD TRUCK F700, FT700, F750, F800, F8000, FT800
		DS873	
		DS880	DODGE TRUCK ; DODGE TRUCK D500, D600, D700, D800, S600, S700
		DS881	DODGE TRUCK ; DODGE TRUCK M400, R400, M500, R500
		DS908	FORD TRUCK ; FORD TRUCK L800, LA800, L900, LA900, LL900, LN900, L9000, LN9000, LN800, L8000, LN8000, LNT800, LNT900, LT900, LNT8000, LT8000, LNT9000, LT9000, LS800, LT800, LTL800, LTS800, LTS8000, LTL900, LTA 900, LTL9000
		DS910	CHEVROLET TRUCK ; CHEVROLET TRUCK Bison, Bruin, H70, H80, H90, J70, J80, J90, M90, S70, S7T; GMC TRUCK ; GMC TRUCK Brigadier, J8C, J9C, General, N9E, N9F, H7500, H8500, H9500, J7500, J8500, J9500, M9500, S7500, S7T

Heavy Duty Chassis Parts Numerical/Buyers Guide

Drag Links (Cont'd)		Part Number	Application
DS910	CHEVROLET TRUCK ; CHEVROLET TRUCK Bison, Bruin, H70, H80, H90, J70, J80, J90, M90, S70, S7T; GMC TRUCK ; GMC TRUCK Brigadier, J8C, J9C, General, N9E, N9F, H7500, H8500, H9500, J7500, J8500, J9500, M9500, S7500, S7T	DS977	NAVISTAR/IHC TRUCK Loadstar & School Bus Models 1600, 1700, 1750, 1800, 1850, 1890, F1600, F1700, F1800, F1850, CO1600, CO1700, CO1750, CO1800, CO1850
DS929	CHEVROLET TRUCK ; CHEVROLET TRUCK C50, C5D, Kodiak, S50, Q50; GMC TRUCK ; GMC TRUCK C4500, C5000, C5D, Topkick, C5500	DS979	NAVISTAR/IHC TRUCK ; NAVISTAR/IHC TRUCK 2554, 2574, 2654, 2674 Series (Built 1989 & Later), S Series Heavy Duty Models 2275, F2275, 2276, F2276, 2375, F2375, 2524, F2524, 2554, F2554, 2574, F2574, 2575, F2575, 2624, F2624, F2654, 2674, F2674, 2675, F2675, S Series Medium Duty Models 1624, 1654,
DS930	DODGE TRUCK ; DODGE TRUCK M400, R400, M500, R500	DS982	CHEVROLET TRUCK ; CHEVROLET TRUCK C65, M65; GMC TRUCK ; GMC TRUCK C6500, M6500
DS938	CHEVROLET TRUCK ; CHEVROLET TRUCK J70, J80, J90, M90; GMC TRUCK ; GMC TRUCK J8500, J9500, M9500	DS983	CHEVROLET TRUCK ; CHEVROLET TRUCK T65, W60, W6N, W70, W7N; GMC TRUCK ; GMC TRUCK T6500, W7500
DS939	CHEVROLET TRUCK ; CHEVROLET TRUCK J70, J80, J90, M90; GMC TRUCK ; GMC TRUCK J7500, J8500, J9500, M9500	DS986	CHEVROLET TRUCK ; CHEVROLET TRUCK C60, C6D, Kodiak, C70, C7D, Kodiak; GMC TRUCK ; GMC TRUCK C6000, C6D, Topkick, C7500, C7D, Topkick
DS941	CHEVROLET TRUCK ; CHEVROLET TRUCK Bison, Bruin, J70, J90, M90; GMC TRUCK ; GMC TRUCK Brigadier, J8C, J9C, General, N9E, N9F, J7500, J9500, M9500	DS987	CHEVROLET TRUCK ; CHEVROLET TRUCK B60, B6P, C60, C6D, Kodiak, C65, C70, C7D, Kodiak, M65, P60; GMC TRUCK ; GMC TRUCK B6000, B6P, C6000, C6D, Topkick, C6500, C7500, C7D, Topkick, M6500, P6000
DS943	FORD TRUCK ; FORD TRUCK C600, CT600, C700, CT700, C750, C7000, C800, C8000, CT8000, C900, CT900, C9000, CT800	DS988	CHEVROLET TRUCK ; CHEVROLET TRUCK Bison, Bruin, D90, F90, H70, H80, H90, J70, J80, J90, M90, Titan; GMC TRUCK ; GMC TRUCK Astro, D9K, D9L, Brigadier, J8C, J9C, D9500, F9500, General, N9E, N9F, H7500, H8500, H9500, J7500, J8500, J9500, M9500
DS944		DS991	CHEVROLET TRUCK ; CHEVROLET TRUCK D90, F90, Titan; GMC TRUCK ; GMC TRUCK Astro, D9K, D9L, D9500, F9500
DS945	FORD TRUCK ; FORD TRUCK B700, B7000, F600, FT600, F700, FT700	DS992	KENWORTH W900, W900B, W900L, W900S
DS946	FORD TRUCK ; FORD TRUCK LN600, LN700	DS993	
DS948	FORD TRUCK ; FORD TRUCK B600, B6000, B700, B7000, F600, FT600, F700, FT700, F800, F8000, FT800, F900, FT900	DS994	
DS949		DS995	KENWORTH C500 Conventional
DS952	FORD TRUCK ; FORD TRUCK B700, B7000, F700, FT700, F750, F800, F8000, FT800	DS996	
DS953	FORD TRUCK ; FORD TRUCK LS800, LT800, LTL800, LTS800, LTS8000, LTL900, LTA 900, LTL9000, LTS900, LS900, LTS9000, LS9000	DS997	KENWORTH K100 Cab-Over-Engine (To 1986)
DS954	FORD TRUCK ; FORD TRUCK LN600, LN700	DS998	
DS955	FORD TRUCK ; FORD TRUCK C600, CT600, C700, CT700, C750, C7000, C800, C8000, CT8000, C900, CT900, C9000, CT800	DS999	FREIGHTLINER ALL MODELS; WHITE TRUCK WFP-6342T, WFP-6364, WFP-6364T, WFP-7564T, WFT-6342T, WFT-6364, WFT-6364T, WFT-7564T, WFT-8164T, WFT-9664T
DS956		ES2030R	CHEVROLET TRUCK ; CHEVROLET TRUCK C65, M65; GMC TRUCK ; GMC TRUCK C6500, M6500
DS958	FORD TRUCK CL900, CLT900, CL9000, CLT9000	ES2090L	KENWORTH K100 Cab-Over-Engine (To 1986)
DS963	NAVISTAR/IHC TRUCK Fleetstar Models 1900, F1900, T1900, 1910A, F1900A, 1950, F1950, T1950, 2000, F2000, T2000, 2010A, F2010A, 2050A, F2050A, 2070A, F2070A, 2110A	ES2091R	KENWORTH ; KENWORTH C500 Conventional, K100 Cab-Over-Engine (To 1986), T800, T800B, Conventional Cab, W900, W900B, W900L, W900S; NAVISTAR/IHC TRUCK ; NAVISTAR/IHC TRUCK 9200 Series, 9300, 9400 Series, 9600, 9700 Series, CO9670, COF9670, Eagle, COF5870, Transtar Models 4200, F4200, 4300, F4300, Transtar Models C04070B, C0F4070B, 4170, 4070B, F4070B, F4170
DS969	NAVISTAR/IHC TRUCK Loadstar & School Bus Models 1600, 1700, 1750, 1800, 1850, 1890, F1600, F1700, F1800, F1850, CO1600, CO1700, CO1750, CO1800, CO1850	ES2113R	FREIGHTLINER ALL MODELS; WHITE TRUCK WFC-12042T, WFC-12064, WFC-12064T
DS970		ES2114R	MACK ; MACK DM400, DM600, DM606S, DM607S, DM685S, DM685T, DMM600, RD700, MC400, MC600, MR400, MR600, R400, R600, R685R, R685ST, R686ST, RD400, RD600, R700, U600, U68ST, F700, F786ST, R767ST
DS971		ES2116L	
DS972		ES2203R	NAVISTAR/IHC TRUCK S Series Heavy Duty Models 2275, F2275, 2276, F2276, 2375, F2375, 2524, F2524, 2554, F2554, 2574, F2574, 2575, F2575, 2624, F2624, F2654, 2674, F2674, 2675, F2675
DS973			
	NAVISTAR/IHC TRUCK Fleetstar Models 1900, F1900, T1900, 1910A, F1900A, 1950, F1950, T1950, 2000, F2000, T2000, 2010A, F2010A, 2050A, F2050A, 2070A, F2070A, 2110A		
DS974	NAVISTAR/IHC TRUCK Loadstar & School Bus Models 1600, 1700, 1750, 1800, 1850, 1890, F1600, F1700, F1800, F1850, CO1600, CO1700, CO1750, CO1800, CO1850		
	NAVISTAR/IHC TRUCK Fleetstar Models 1900, F1900, T1900, 1910A, F1900A, 1950, F1950, T1950, 2000, F2000, T2000, 2010A, F2010A, 2050A, F2050A, 2070A, F2070A, 2110A		
DS976	NAVISTAR/IHC TRUCK Fleetstar Models 1900, F1900, T1900, 1910A, F1900A, 1950, F1950, T1950, 2000, F2000, T2000, 2010A, F2010A, 2050A, F2050A, 2070A, F2070A, 2110A; NAVISTAR/IHC TRUCK Loadstar & School Bus Models 1600, 1700, 1750, 1800, 1850, 1890, F1600, F1700, F1800, F1850, CO1600, CO1700, CO1750, CO1800, CO1850		

Heavy Duty Chassis Parts Numerical/Buyers Guide

Numerical/Buyer's Guide

Drag Links (Cont'd)		Part Number	Application
ES2204R	KENWORTH ; KENWORTH C500 Conventional, K100 Cab-Over-Engine (To 1986), T800,T800B, Conventional Cab, W900, W900B, W900L,W900S; NAVISTAR/IHC TRUCK ; NAVISTAR/IHC TRUCK 9200 Series, 9300, 9400 Series, 9600, 9700 Series, CO9670, COF9670, Eagle, COF5870, Transtar Models 4200, F4200, 4300, F4300, Transtar Models C04070B,C0F4070B,4170,4070B,F4070B,F4170	Drag Links (Cont'd)	
ES2209R	KENWORTH ; KENWORTH C500 Conventional, K100 Cab-Over-Engine (To 1986), W900, W900B, W900L,W900S		
ES2224L	VOLVO/WHITE/GMC XPEDITOR; WHITE TRUCK ; WHITE TRUCK RC2-42T, RC2-64T, RCW-64T, RX2-42T, RX2-64T		
ES2225R	VOLVO/WHITE/GMC XPEDITOR; WHITE TRUCK ; WHITE TRUCK RB2-64T, RBW-64T, RC2-42T, RC2-64T, RCW-64T, RX2-42T, RX2-64T		
ES3178R	NAVISTAR/IHC TRUCK ; NAVISTAR/IHC TRUCK 8100, 8200, 8300 Series (Built 1989 & Later), S Series Heavy Duty Models 2275, F2275, 2276, F2276, 2375, F2375, 2524, F2524, 2554, F2554, 2574, F2574, 2575, F2575, 2624, F2624, F2654, 2674, F2674, 2675, F2675		
ES3214R	NAVISTAR/IHC TRUCK ; NAVISTAR/IHC TRUCK 9300, 9400 Series, 9600, 9700 Series, CO9670, COF9670, Eagle		
ES3216R	NAVISTAR/IHC TRUCK ; NAVISTAR/IHC TRUCK 8100, 8200, 8300 Series (Built 1989 & Later), S Series Heavy Duty Models 2275, F2275, 2276, F2276, 2375, F2375, 2524, F2524, 2554, F2554, 2574, F2574, 2575, F2575, 2624, F2624, F2654, 2674, F2674, 2675, F2675		
ES3252R	MACK ; MACK DM600, DM606S, DM607S, DM685S, DM685T, DM800, MC400, MC600, MR400, MR600, R487P, R600, R685R, R685ST, R686ST, RD400, RD600, R700, U600, U68ST, F700, F786ST, R767ST		
ES431L	MACK ; MACK DM400, DM600, DM606S, DM607S, DM685S, DM685T, DM800, DMM600, RD700, MB400, MB600, MC400, MC600, MR400, MR600, R400, R600, R685R, R685ST, R686ST, R600L, R600LS, R700L, R700LS, RWL700S, RWS700S, WL700L WL700LS, WS700L, WS700LS, RD400, RD600, R700, U600, U6		
ES431R	FREIGHTLINER ALL MODELS; KENWORTH W900, W900B, W900L,W900S; MACK ; MACK DM400, DM600, DM606S, DM607S, DM685S, DM685T, DM800, DMM600, RD700, MB400, MB600, MC400, MC600, MR400, MR600, R400, R600, R685R, R685ST, R686ST, R600L, R600LS, R700L, R700LS, RWL700S, RWS700S, WL700L WL700LS, WS700L, WS700LS, RD400, RD600, R700, U600, U6; WHITE TRUCK WFC-12042T, WFC-12064, WFC-12064T		
ES434L	FREIGHTLINER ALL MODELS		

Heavy Duty Chassis Parts Numerical/Buyers Guide

King Bolt Sets		Part Number	Application
8001C	DANA/SPICER AXLE ; DANA/SPICER AXLE D600N, D700F, D700N, D800F, D800N, D850F, D850N; FORD TRUCK F600	80066B	NAVISTAR/IHC TRUCK ; NAVISTAR/IHC TRUCK Cargostar Models CO1610, CO1630, CO1710, CO1730, CO1750, CO1810, COF1810, CO1830, CO1850, CO1910, COF1910, CO1950, COF1950, Fleetstar Models 1900, F1900, T1900, 1910A, F1900A, 1950, F1950, T1950, 2000, F2000, T2000, 2010A, F2010A, 2050A, F2050A, 2070A, F2
8002C	DANA/SPICER AXLE ; DANA/SPICER AXLE I100W, I120W, I140W	80068C	FORD TRUCK ; FORD TRUCK C600, C700, C800, CF600, CF700, CF800, CFT800, CL900, CLT900, CL9000, CLT9000, F600, F600, FT600, F700, FT700, F800, F8000, FT800, F900, FT900, FT950, L800, LA800, L900, LA900, LL900, LN900, L9000, LN9000, LN800, L8000, LN8000, LNT800, LNT900, LT900, LNT8
8003C	DANA/SPICER AXLE I160W	80069B	FORD TRUCK ; FORD TRUCK B600, B6000, F600, F700, FT700, F800, F8000, FT800, F900, FT900
8004C	EATON ; EATON E1002I, E1002W, E1202I, E1202W, E1322I, E1322W, E1462I, E1462W	8006C	BLUE BIRD ; BLUE BIRD Wander Lodge 450LXI, Wander Lodge M380, Xcel 103; DANA/SPICER AXLE ; STERLING TRUCK A, L, S Series
80053B	NAVISTAR/IHC TRUCK CO4000, COF4000, COT4000	80070C	DANA/SPICER AXLE ; DANA/SPICER AXLE 02ADE, 02ADG, I132SG, I140S, I140SG; NAVISTAR/IHC TRUCK ; NAVISTAR/IHC TRUCK 2554, 2574, 2654, 2674 Series (Built 1989 & Later), 3700, 3800, 3900 Series, 4600, 4700, 4800, 4900 Series, 7100 Series, 8100, 8200, 8300 Series (Built 1989 & Later), 9200 Series, 9300, 9400 Series, 9600, 9700 Series, 9800 Series, M1400, M1600, 1452, 1652; STERLING TRUCK A, L, S Series
80055B	WESTPORT AXLE ; WESTPORT AXLE F3W-1200, F3W-1400, F6W-1200, F6W-1400; WHITE TRUCK ; WHITE TRUCK RB2-42T, 4842, 4864, 4942, 4964, RB2-64T, RBW-42T, RBW-64T, RC2-42T, RC2-64T, RCW-42T, WSH-42T, WSH-64T, RCW-64T, RX2-42T, RX2-64T, WHITE AXLES	80071C	FORD TRUCK ; FORD TRUCK Aeromax Series, A85, AT85, A95, AT95, Louisville Series L85
80056B	WHITE TRUCK WHITE AXLES	80072B	
80057B	MACK DM800	80073C	
80058B	MACK ; MACK DM400, DM600, DM606S, DM607S, DM685S, DM685T, DM800, DMM600, RD700, MB400, MB600, MC400, MC600, MR400, MR600, R400, R600, R685R, R685ST, R686ST, RD400, RD600, R700	80074B	DANA/SPICER AXLE ; NAVISTAR/IHC TRUCK ; NAVISTAR/IHC TRUCK 2554, 2574, 2654, 2674 Series (Built 1989 & Later), 4600, 4700, 4800, 4900 Series, 9200 Series, 9300, 9400 Series, M1400, M1600, 1452, 1652 Series Medium Duty, Paystar Models 5010, 5050, 5070, F5010, F5050, F5070, F5050SF, F5070SF, F5050SF-LW, F5070SF-LW; STERLING TRUCK A, L, S Series
80059B	ROCKWELL FD900	80075C	DANA/SPICER AXLE ; DANA/SPICER AXLE 02ADC, 02ADD, I160S, I180S, I200S; NAVISTAR/IHC TRUCK ; NAVISTAR/IHC TRUCK 2554, 2574, 2654, 2674 Series (Built 1989 & Later), 4600, 4700, 4800, 4900 Series, 9200 Series, 9300, 9400 Series, M1400, M1600, 1452, 1652 Series Medium Duty, Paystar Models 5010, 5050, 5070, F5010, F5050, F5070, F5050SF, F5070SF, F5050SF-LW, F5070SF-LW; STERLING TRUCK A, L, S Series
8005C	EATON E1203I	80076B	EATON ; EATON E-1000I, E-1200I, E-1320I, E-1460I, E1000W, E1200W, E1320W; FREIGHTLINER ; FREIGHTLINER C112, C120 Century Class, Conventional Cab, FL70, MB70, FL80, MB80, FL106 Business Class, Conventional Cab, FLA, FLP, FLT Series Cab-Over-Engine, FLB, FLL Series Cab-Over-Engine, FLC 112 Series, FLD 112SD, FLD 120SD Conventional cab, Severe Duty, FLD 1 ; KENWORTH ; KENWORTH C500B Conventional Cab, K100 (set forward axle), K100E(Set Back Axle), Cab-Over-Engine From 1986, T400A, T400B Conventional Cab, T450A, T450B Conventional Cab, T600A, T600B Conventional Cab, T800, T800B, Conventional Cab; NAVISTAR/IHC TRUCK ; NAVISTAR/IHC TRUCK 2554, 2574, 2654, 2674 Series (Built 1989 & Later), 8100, 8200, 8300 Series (Built 1989 & Later), 9200 Series, 9300, 9400 Series, 9600, 9700 Series, 9800 Series, S Series Heavy Duty Models 2275, F2275, 2276, F2276, 2375, F2375, 2524, F2524, 2554, F2554, 2; PETERBILT 310, 320, 330, 357, 362, 372, 375, 376, 377, 378, 379, 385, 387; ROCKWELL ; ROCKWELL FD961, FF961, MFS SERIES; STERLING TRUCK ; STERLING TRUCK A9500, Acterra, SC7000 CARGO, COE; THOMAS BUILT ; THOMAS BUILT ER Series, Saf-T-Liner C2; VOLVO/WHITE/GMC ; VOLVO/WHITE/GMC AC Series, ACL Series, AERO Series, AUTOHAULER TRACTORS, WG Series, WHR, WIL, WIA Series; WESTERN STAR 3842S, 3864S, 4842, 4864, 4942, 4964, 5842SS, 5864SS, 5942SS, 5964SS, 6964F, 6964S, 6969RL
80063B	BLUE BIRD Ultra FL; NAVISTAR/IHC TRUCK ; NAVISTAR/IHC TRUCK 2554, 2574, 2654, 2674 Series (Built 1989 & Later), 8100, 8200, 8300 Series (Built 1989 & Later), 9200 Series, 9300, 9400 Series, 9600, 9700 Series, 9800 Series, S Series Heavy Duty Models 2275, F2275, 2276, F2276, 2375, F2375, 2524, F2524, 2554, F2554, 2; PETERBILT 310, 320, 330, 357, 362, 372, 375, 376, 377, 378, 379, 385, 387; ROCKWELL ; ROCKWELL FD961, FF961, MFS SERIES; STERLING TRUCK ; STERLING TRUCK A9500, Acterra, SC7000 CARGO, COE; THOMAS BUILT ; THOMAS BUILT ER Series, Saf-T-Liner C2; VOLVO/WHITE/GMC ; VOLVO/WHITE/GMC AC Series, ACL Series, AERO Series, AUTOHAULER TRACTORS, WG Series, WHR, WIL, WIA Series; WESTERN STAR 3842S, 3864S, 4842, 4864, 4942, 4964, 5842SS, 5864SS, 5942SS, 5964SS, 6964F, 6964S, 6969RL	80077B	EATON E-1000I, E-1200I, E-1320I, E-1460I; PETERBILT 310, 320, 330, 357, 362, 372, 375, 376, 377, 378, 379, 385, 387
80063C	BLUE BIRD Ultra FL; FORD TRUCK F900, FT900; FREIGHTLINER ; FREIGHTLINER C112, C120 Century Class, Conventional Cab, FL70, MB70, FL80, MB80, FL106 Business Class, Conventional Cab, FLA, FLP, FLT Series Cab-Over-Engine, FLB, FLL Series Cab-Over-Engine, FLC 112 Series, FLD 112SD, FLD 120SD Conventional cab, Severe Duty, FLD 1 ; KENWORTH ; KENWORTH C500B Conventional Cab, K100 (set forward axle), K100E(Set Back Axle), Cab-Over-Engine From 1986, T400A, T400B Conventional Cab, T450A, T450B Conventional Cab, T600A, T600B Conventional Cab, T800, T800B, Conventional Cab; NAVISTAR/IHC TRUCK ; NAVISTAR/IHC TRUCK 2554, 2574, 2654, 2674 Series (Built 1989 & Later), 8100, 8200, 8300 Series (Built 1989 & Later), 9200 Series, 9300, 9400 Series, 9600, 9700 Series, 9800 Series, S Series Heavy Duty Models 2275, F2275, 2276, F2276, 2375, F2375, 2524, F2524, 2554, F2554, 2; PETERBILT 310, 320, 330, 357, 362, 372, 375, 376, 377, 378, 379, 385, 387; ROCKWELL ; ROCKWELL FD961, FF961, MFS SERIES; STERLING TRUCK ; STERLING TRUCK A9500, Acterra, SC7000 CARGO, COE; THOMAS BUILT ; THOMAS BUILT ER Series, Saf-T-Liner C2; VOLVO/WHITE/GMC ; VOLVO/WHITE/GMC AC Series, ACL Series, AERO Series, AUTOHAULER TRACTORS, WG Series, WHR, WIL, WIA Series; WESTERN STAR 3842S, 3864S, 4842, 4864, 4942, 4964, 5842SS, 5864SS, 5942SS, 5964SS, 6964F, 6964S, 6969RL	80078C	

Heavy Duty Chassis Parts Numerical/Buyers Guide

Numerical/Buyer's Guide

King Bolt Sets (Cont'd)		Part Number	Application
80079C	NAVISTAR/IHC TRUCK ; NAVISTAR/IHC TRUCK 9600, 9700 Series, CO9670, COF9670, Eagle, S Series Heavy Duty Models 2275, F2275, 2276, F2276, 2375, F2375, 2524, F2524, 2554, F2554, 2574, F2574, 2575, F2575, 2624, F2624, F2654, 2674, F2674, 2675, F2675, Transtar Models 4200, F4200, 4300, F4300, Transt	8386B	AUTOCAR A42, S42, A64, S64; CHEVROLET TRUCK ; CHEVROLET TRUCK A60, A80, N80, Q80, V80, C50, C5D, C5H, C5500, Kodiak, C60, C6D, C6H, Kodiak, C65, C80, E80, L80, M80, U80, D60, D90, F90, H70, H80, H90, J70, J80, J90, L50, L60, M60, M65, M90, N60, Y60, T50, T60, T65, T70, T80, T90, W70, W7N, W80, W90; DODGE TRUCK ; DODGE TRUCK D800, L700, LN1000, LNT1000, LV1000, LVT1000, NC1000, NCT1000, NL1000, NLT1000, VL1000, VLT1000, NC900, NCT900; FORD TRUCK ; FORD TRUCK C850, L800; FREIGHTLINER OTHER MODELS Conventional and Cab-Over-Engine; GMC TRUCK ; GMC TRUCK C6000, C6D, Topkick, C6500, C9500, D9500, F9500, H7500, H8500, H9500, J7500, J8500, J9500, M6000, M6500, M9500, T6500, T7500, T8500, T9500, W7500, W8500, W9500; KENWORTH ; KENWORTH C500 Conventional, K100 Cab-Over-Engine (To 1986), L700 Cab Forward, W900, W900B, W900L, W900S; MARMON Conventional, COE; PETERBILT ; PETERBILT 252, 282, 289, 300, 348, 352, 352H, 353, 359, 310, 320, 330, 357, 362, 372, 375, 376, 377, 378, 379, 385, 387; ROCKWELL ; ROCKWELL 16612, 16613, 16616, FE900, FE903, FE910; WHITE TRUCK ; WHITE TRUCK WFC-12042T, WFC-12064, WFC-12064T, WFP-6342T, WFP-6364, WFP-6364T, WFT-7564T, WFT-6342T, WFT-6364, WFT-6364T, WFT-7564T, WFT-8164T, WFT-9664T
8008C (Service Kit Only)	HENDRICKSON ; HENDRICKSON Airtek for Bluebird, Airtek for Volvo, Softek for Bluebird	8386N	
8207B	CHEVROLET TRUCK ; CHEVROLET TRUCK QJ,QK,RJ,RK,SJ,SK,TJ,TK, Y,M,O,P Series except Heavy Duty,COE& School Bus	8389B	NAVISTAR/IHC TRUCK ; NAVISTAR/IHC TRUCK CO4000, COF4000, COT4000, Loadstar & School Bus Models 1600, 1700, 1750, 1800, 1850, 1890, F1600, F1700, F1800, F1850, CO1600, CO1700, CO1750, CO1800, CO1850, Transtar Models CO4070A, COF4070A
8336B	CHEVROLET TRUCK ; CHEVROLET TRUCK Y,M,O,P Series Heavy Duty, Y,M, Series COE & Y,M,O Series School Bus; DIVCO ; DIVCO 10A, B, C, 11, 12, 13, 15, 100A, B, C, AX, BX, CX, 114, 124, 134, 154, 200A, B, C, 214,224,300A,B,C,D,E,334,344,364374, UMB8,UML8, 11, 12, 13, 14, 15, 21, 22, 31, 33, 34, 36, 37; ROCKWELL 30000, 31000 Series	8426B	FORD TRUCK F4
8343B	CHEVROLET TRUCK ; CHEVROLET TRUCK L,C,F,5A,5B,5C,Standard,F,C,6J,6K, N,P (First Series), R (Second Series),4C, Regular and School Bus,COE, Regular and School Bus,COE(1955 1st Series), Regular School Bus 6A,6B,6C,6D,6E(except Heavy Duty), SL,TL,UL,VL,R (First Series), UJ,UK,VJ,VK	8428B	CHEVROLET TRUCK N,P (First Series)
8357B	FORD TRUCK ; FORD TRUCK B600, B6000, B700, B7000, C500, C550, C600, CT600, C700, CT700, C750, C7000, F600, FT600, F700, FT700, F850, F950, N600, N6000, T800	8440B	FORD TRUCK All
8357N		8441B	NAVISTAR/IHC TRUCK Loadstar & School Bus Models 1600, 1700, 1750, 1800, 1850, 1890, F1600, F1700, F1800, F1850, CO1600, CO1700, CO1750, CO1800, CO1850
8375B	CLARK AXLE F-553; NAVISTAR/IHC TRUCK ; NAVISTAR/IHC TRUCK Cargostar Models CO1610, CO1630, CO1710, CO1730, CO1750, CO1810, COF1810, CO1830, CO1850, CO1910, COF1910, CO1950, COF1950, Fleetstar Models 1900, F1900, T1900, 1910A, F1900A, 1950, F1950, T1950, 2000, F2000, T2000, 2010A, F2010A, 2050A, F2050A, 2070A, F2	8445B	CHEVROLET TRUCK ; CHEVROLET TRUCK C40, C50, C5D, C5H, C5500, Kodiak, D50, L50, N,P(Second Series),4A,4B, P50, S50, Q50; GMC TRUCK ; GMC TRUCK C5000, C5D, Topkick, E4500
8385B	NAVISTAR/IHC TRUCK ; NAVISTAR/IHC TRUCK Cargostar Models CO1610, CO1630, CO1710, CO1730, CO1750, CO1810, COF1810, CO1830, CO1850, CO1910, COF1910, CO1950, COF1950, Loadstar & School Bus Models 1600, 1700, 1750, 1800, 1850, 1890, F1600, F1700, F1800, F1850, CO1600, CO1700, CO1750, CO1800, CO1850	8445N	CHEVROLET TRUCK ; CHEVROLET TRUCK C40, D50, L50, N,P(Second Series),4A,4B, P50, S50, Q50; GMC TRUCK ; GMC TRUCK C5000, C5D, Topkick, E4500
8385B015	NAVISTAR/IHC TRUCK Loadstar & School Bus Models 1600, 1700, 1750, 1800, 1850, 1890, F1600, F1700, F1800, F1850, CO1600, CO1700, CO1750, CO1800, CO1850	8454B	DODGE TRUCK ; DODGE TRUCK ALL (Except W500 4WD), D400, D500, DL400, P400, PL400, M400, R400
		8454N	
		8456B	DODGE TRUCK ; DODGE TRUCK ALL (Except W500 4WD), C500, C600, D400, D500, D600, D700, DC700, DL400, P400, PL400, F,FL,FN,FNL,FS,G,GA SERIES, H,HM,J,JM,K,KM SERIES, L600, M400, R400, PC500, PD500, PC600, PD600, R,RA,RAL,RL,RS Series, S500, S600
		8458B	FORD TRUCK P400
		8458B010	
		8459B	FORD TRUCK ; FORD TRUCK B500, F500, B600, B6000, F600, FT600, P500

Heavy Duty Chassis Parts Numerical/Buyers Guide

	Part Number		Application
King Bolt Sets (Cont'd)		King Bolt Sets (Cont'd)	
8462B	CHEVROLET TRUCK ; CHEVROLET TRUCK A60, A80, N80, Q80, V80, B60, B6P, Bruin, C50, C5D, C5H, C5500, Kodiak, C60, C6D, C6H, Kodiak, C65, C70, C7D, Kodiak, C80, E80, L80, M80, U80, D60, H70, H80, H90, J70, J80, J90, L50, L60, M50, M60, M65, M90, N50, N60, Y60, Q60, V60, X60, S50, Q50, S60, T5; GMC TRUCK ; GMC TRUCK B6000, B6P, Brigadier, J8C, J9C, C6000, C6D, Topkick, C6500, C7500, C7D, Topkick, C9500, D9500, F9500, H7500, H8500, H9500, J7500, J8500, J9500, M6000, M6500, M9500, R8500, S6000, T5500, T6000, T6500, T7500, T8500, T9500, W7500, W8500, W9500	8489B	AUTOCAR A42, S42, A64, S64; BROCKWAY ; BROCKWAY SERIES 358, 359, 360, 361, 527, SERIES 450, 450C, 550, 550C, 700, 700C; DODGE TRUCK ; DODGE TRUCK C1000, C700, C800, C850, C900, CN800, CNT800, CN900, CNT900, CT700, CT800, CT900, D1000, DN1000, DNT1000, L700, LN1000, LNT1000, LV1000, LVT1000, LS1000, LT1000; FORD TRUCK ; FORD TRUCK C1100, C600, C700, C800, C8000, CT8000, C850, C900, CT900, C9000, C950, C1000, CT800, CT850, CT950, F1000, F1100, F850, F950, HT950, H1000, L800, LA800, L900, LA900, LL900, LN900, L9000, LN9000, LN800, L8000, LN8000, LNT800, LNT880, LT880, LNT900, LT900 ; FREIGHTLINER OTHER MODELS Conventional and Cab-Over-Engine; KENWORTH ; KENWORTH C500 Conventional, K100 Cab-Over-Engine (To 1986), L700 Cab Forward, W900, W900B, W900L, W900S; MARMON Conventional, COE; NAVISTAR/IHC TRUCK ; NAVISTAR/IHC TRUCK Cargostar Models CO1610, CO1630, CO1710, CO1730, CO1750, CO1810, COF1810, CO1830, CO1850, CO1910, COF1910, CO1950, COF1950, D400, DC400, DCF400, DCF400M, DF400, D405, DC405, DCF405, DCT405, DF405, DT405 Conventional, Fleetstar Models 1900, F1900, T1900, 1; PETERBILT ; PETERBILT 252, 282, 289, 300, 348, 352, 352H, 353, 359, 310, 320, 330, 357, 362, 372, 375, 376, 377, 378, 379, 385, 387; ROCKWELL FF901, FF903; WHITE TRUCK ; WHITE TRUCK WFC-12042T, WFC-12064, WFC-12064T, WFP-6342T, WFP-6364, WFP-6364T, WFP-7564T, WFT-6342T, WFT-6364, WFT-6364T, WFT-7564T, WFT-8164T, WFT-9664T
8462N		8489N	
8471B	FORD TRUCK ; FORD TRUCK B500, F500, B600, B6000, F600, FT600, P500	8490T	CHEVROLET TRUCK ; CHEVROLET TRUCK C50, C5D, C5H, C5500, Kodiak, C60, C6D, C6H, Kodiak; GMC TRUCK ; GMC TRUCK C4500, C5000, C5D, Topkick, C5500, C6000, C6D, Topkick, S5500
8474B	AUTOCAR C85, C85T, C87, C87D, D87-OH, DC102T, DC103T, C9564, DC9564, C9764, C9764S, DC9764, C10364S, DC10364S, DC10464, DC10464S; BROCKWAY SERIES F260L, F260LF, F260LQ, F260T, H260L, H260LF, H257T, N257T, N260L, N260LF, N260LQ, N260T, 2606L; CHEVROLET TRUCK ; CHEVROLET TRUCK D90, J90, M90; DIAMOND T 950, 951; DODGE TRUCK ; DODGE TRUCK C1000, C850, C900, CN900, CNT900, CT800, CT900, LN1000, LNT1000, LV1000, LVT1000, NC1000, NCT1000, NL1000, NLT1000, VL1000, VLT1000, NC900, NCT900; FORD TRUCK ; FORD TRUCK C1100, C900, CT900, C9000, C950, C1000, CT800, CT850, CT950, F1000, F1100, HT950, H1000, NT850, N1000, NT950, T800, T850, T950, W1000, WT1000, W900, WT900, W9000, WT9000; GMC TRUCK ; GMC TRUCK C9500, D9500, F9500, H9500, J8500, J9500, M9500, T9500, W8500, W9500; ROCKWELL FG900, FG903	8491B	CHEVROLET TRUCK ; CHEVROLET TRUCK A60, A80, N80, Q80, V80, B60, B6P, Bruin, C40, C50, C5D, C5H, C5500, Kodiak, C60, C6D, C6H, Kodiak, C65, C70, C7D, Kodiak, C80, E80, L80, M80, U80, D60, H70, H80, J70, L50, L60, M50, M60, M65, N50, N60, Y60, P40, P60, Q60, V60, X60, S50, Q50, S60, T50, T6; GMC TRUCK ; GMC TRUCK B6000, B6P, Brigadier, J8C, J9C, C5000, C5D, Topkick, C5500, C6000, C6D, Topkick, C6500, C7500, C7D, Topkick, E5500, E6500, H5500, H7500, H8500, H9500, J7500, M6000, M6500, P4500, P6000, S5500, S6000, T5500, T6000, T6500, T7500, W7500
8479B	DODGE TRUCK ; DODGE TRUCK ALL (Except W500 4WD), C1000, C500, C600, C700, C800, C850, C900, CT700, CT800, D500, D600, D700, D800, DC700, L600, L700, PC500, PD500, PC600, PD600, S500, S600; FORD TRUCK ; FORD TRUCK B600, B6000, C550, C600, CT600, C700, CT700, C750, C7000, F600, FT600, F700, FT700, F750, F800, F8000, FT800, F850, F950, N600, N6000, N8000, N850, N950, T800; ROCKWELL FC901, FC902, FC903	8491B010	
8479N		8491N	
8484T	CHEVROLET TRUCK ; CHEVROLET TRUCK C40, C50, C5D, C5H, C5500, Kodiak, C60, C6D, C6H, Kodiak, C80, E80, L80, M80, U80, D50, D60, L50, L60, M50, M60, P50, Q60, V60, X60, S50, Q50, S60, T50; GMC TRUCK ; GMC TRUCK C6000, C6D, Topkick, E4500, E5500, H5500, S6000	8492B	CHEVROLET TRUCK ; CHEVROLET TRUCK C40, C50, C5D, C5H, C5500, Kodiak, C60, C6D, C6H, Kodiak, C80, E80, L80, M80, U80, D50, D60, L50, L60, M50, M60, P50, Q60, V60, X60, S50, Q50, S60, T50; GMC TRUCK ; GMC TRUCK C6000, C6D, Topkick, E4500, E5500, H5500, S6000
8488B	FORD TRUCK ; FORD TRUCK B500, F500, B600, B6000, B700, B7000, F600, FT600, F700, FT700, F800, F8000, FT800, LN500, LN600, LN700, M400 Motor Home Chassis, N500, N600, N6000, P500, P600	8492N	
8488B010		8500B	FORD TRUCK ; FORD TRUCK B600, B6000, B700, B7000, C500, C550, C600, CT600, C700, CT700, C750, C7000, C800, C8000, CT8000, C900, CT900, C9000, CT800, F600, FT600, F700, FT700, F750, F800, F8000, FT800, F900, FT900, L800, LA800, L900, LA900, LL900, LN900, L9000, LN9000, LN600, LN7
		8500B010	
		8500N	
		8503B	NAVISTAR/IHC TRUCK ; NAVISTAR/IHC TRUCK CO4000, COF4000, COT4000, D400, DC400, DCF400, DCF400M, DF400, D405, DC405, DCF405, DCT405, DF405, DT405 Conventional, Fleetstar Models 1900, F1900, T1900, 1910A, F1900A, 1950, F1950, T1950, 2000, F2000, T2000, 2010A, F2010A, 2050A, F2050A, 2070A, F2070A,

Numerical/Buyer's Guide

Heavy Duty Chassis Parts Numerical/Buyers Guide

King Bolt Sets (Cont'd)		Part Number	Application
8503B	NAVISTAR/IHC TRUCK ; NAVISTAR/IHC TRUCK CO4000, COF4000, COT4000, D400, DC400, DCF400, DCF400M, DF400, D405, DC405, DCF405, DCT405, DF405, DT405 Conventional, Fleetstar Models 1900, F1900, T1900, 1910A, F1900A, 1950, F1950, T1950, 2000, F2000, T2000, 2010A, F2010A, 2050A, F2050A, 2070A, F2070A,	8518B	AUTOCAR ; AUTOCAR CK64, CK64ST, DC42, K42, KM42, KS42, DC64, DK64, K64, KL64, KM64, KS64, KMS64F, DC87T, DC9364, DC9964, DC10364; BROCKWAY ; BROCKWAY SERIES 358, 359, 360, 361, 527, SERIES 450, 450C, 550, 550C, 700, 700C; CHEVROLET TRUCK ; CHEVROLET TRUCK D90, H70, J70, J80, J90, M90, W70, W7N; DODGE TRUCK ; DODGE TRUCK C800, CN800, CNT800, CN900, CNT900, CT800, CT900, D1000, DN1000, DNT1000, LS1000, LT1000; FORD TRUCK ; FORD TRUCK L800, LA800, LN800, L8000, LN8000, LNT800, LNT900, LT900, LNT8000, LT8000, LNT9000, LT9000, LS800, LT800, LTL800, LTS800, LTS8000, LTS900, LS900, LTS9000, LS9000, N8000, T850, T950; FREIGHTLINER OTHER MODELS Conventional and Cab-Over-Engine; GMC TRUCK ; GMC TRUCK D9500, H7500, J7500, J8500, J9500, M9500, W7500; KENWORTH ; KENWORTH C500 Conventional, K100 Cab-Over-Engine (To 1986), L700 Cab Forward, W900, W900B, W900L, W900S; MACK B53, B57; MARMON Conventional, COE; NAVISTAR/IHC TRUCK ; NAVISTAR/IHC TRUCK Cargostar Models CO1610, CO1630, CO1710, CO1730, CO1750, CO1810, COF1810, CO1830, CO1850, CO1910, COF1910, CO1950, COF1950, CO4000, COF4000, COT4000, D400, DC400, DCF400, DCF400M, DF400, D405, DC405, DCF405, DCT405, DF405, DT405 Conventional, Fleetstar Mo; PETERBILT ; PETERBILT 252, 282, 289, 300, 348, 352, 352H, 353, 359, 310, 320, 330, 357, 362, 372, 375, 376, 377, 378, 379, 385, 387; ROCKWELL ; ROCKWELL FH901, FL901; WHITE TRUCK ; WHITE TRUCK WFC-12042T, WFC-12064, WFC-12064T, WFP-6342T, WFP-6364, WFP-6364T, WFT-6342T, WFT-6364, WFT-6364T, WFT-7564T, WFT-8164T, WFT-9664T
8507B	FORD TRUCK ; FORD TRUCK B700, B7000, C500, C800	8518N	
8507B010	DODGE TRUCK ; DODGE TRUCK C1000, C500, C600, C700, C800, C850, C900, CT700, CT800, D500, D600, D700, D800, DC700, L600, L700, S500, S600; FORD TRUCK ; FORD TRUCK B600, B6000, B700, B7000, C550, C600, CT600, C700, CT700, C750, C7000, C800, F600, FT600, F700, FT700, F750, F800, F8000, FT800, F850, F950, N600, N6000, N8000, N850, N950, T800; ROCKWELL FC901, FC902, FC903	8519B	BROCKWAY SERIES 147WL, 148WD, 148SLD, 155W, 257, 260; CHEVROLET TRUCK 7,8,9 & 10 SERIES; DODGE TRUCK ; DODGE TRUCK ALL (Except W500 4WD), C1000, C700, C800, C850, C900, CN800, CNT800, CN900, CNT900, CT700, CT800, CT900, D1000, D700, D800, L700, LN1000, LNT1000, LV1000, LVT1000, LS1000, LT1000, NC1000, NCT1000, NL1000, NLT1000, VL1000, VLT1000, NC900, NCT900, T,TA,TAL,; FORD TRUCK ; FORD TRUCK B700, B7000, C1100, C600, CT600, C700, CT700, C750, C7000, C800, C8000, CT8000, C850, C900, CT900, C9000, C950, C1000, CT800, CT850, CT950, F1000, F1100, F600, F700, FT700, F750, F800, F8000, FT800, F850, F950, F900, HT950, H1000, L800, LA800, L900, LA900; NAVISTAR/IHC TRUCK ; NAVISTAR/IHC TRUCK Cargostar Models CO1610, CO1630, CO1710, CO1730, CO1750, CO1810, COF1810, CO1830, CO1850, CO1910, COF1910, CO1950, COF1950, Fleetstar Models 1900, F1900, T1900, 1910A, F1900A, 1950, F1950, T1950, 2000, F2000, T2000, 2010A, F2010A, 2050A, F2050A, 2070A, F2; ROCKWELL ; ROCKWELL FD901, FD902, FD903
8507N	FORD TRUCK ; FORD TRUCK B700, B7000, C500, C800		
8514B	AUTOCAR A42, S42, A64, S64; BROCKWAY ; BROCKWAY SERIES 358, 359, 360, 361, 527, SERIES 450, 450C, 550, 550C, 700, 700C; FORD TRUCK ; FORD TRUCK C1100, C600, C700, C800, C8000, CT8000, C850, C900, CT900, C9000, C950, C1000, CT800, CT850, CT950, F1000, F1100, F850, F950, HT950, H1000, N1100, N850, N950, NT850, N1000, NT950, T800, T850, T950, W1000, WT1000, W900, WT900, W9000, WT9000; FREIGHTLINER OTHER MODELS Conventional and Cab-Over-Engine; GMC TRUCK ; GMC TRUCK D9500, F9500; KENWORTH ; KENWORTH C500 Conventional, K100 Cab-Over-Engine (To 1986), L700 Cab Forward, W900, W900B, W900L, W900S; MARMON Conventional, COE; NAVISTAR/IHC TRUCK ; NAVISTAR/IHC TRUCK CO4000, COF4000, COT4000, D400, DC400, DCF400, DCF400M, DF400, D405, DC405, DCF405, DCT405, DF405, DT405 Conventional, Fleetstar Models 1900, F1900, T1900, 1910A, F1900A, 1950, F1950, T1950, 2000, F2000, T2000, 2010A, F2010A, 2050A, F2050A, 2070A, F2070A,; PETERBILT ; PETERBILT 252, 282, 289, 300, 348, 352, 352H, 353, 359, 310, 320, 330, 357, 362, 372, 375, 376, 377, 378, 379, 385, 387; ROCKWELL FE970; WHITE TRUCK ; WHITE TRUCK WFC-12042T, WFC-12064, WFC-12064T, WFP-6342T, WFP-6364, WFP-6364T, WFT-6342T, WFT-6364, WFT-6364T, WFT-7564T, WFT-8164T, WFT-9664T		
8514N			

Heavy Duty Chassis Parts Numerical/Buyers Guide

		Part Number	Application
King Bolt Sets (Cont'd)		King Bolt Sets (Cont'd)	
8519B010	BROCKWAY SERIES 147WL, 148WD, 148SLD, 155W, 257, 260; DODGE TRUCK ; DODGE TRUCK C1000, C700, C800, C850, C900, CN800, CNT800, CN900, CNT900, CT700, CT800, CT900, D1000, D700, D800, L700, LN1000, LNT1000, LV1000, LVT1000, LS1000, LT1000, NC1000, NCT1000, NL1000, NLT1000, VL1000, VLT1000, NC900, NCT900; FORD TRUCK ; FORD TRUCK B700, B7000, C1100, C600, CT600, C700, CT700, C750, C7000, C800, C8000, CT8000, C850, C900, CT900, C9000, C950, C1000, CT800, CT850, CT950, F1000, F1100, F700, FT700, F750, F800, F8000, FT800, F850, F950, F900, HT950, H1000, L800, LA800, L900, LA900, LL90; NAVISTAR/IHC TRUCK ; NAVISTAR/IHC TRUCK Cargostar Models CO1610, CO1630, CO1710, CO1730, CO1750, CO1810, COF1810, CO1830, CO1850, CO1910, COF1910, CO1950, COF1950, Fleetstar Models 1900, F1900, T1900, 1910A, F1900A, 1950, F1950, T1950, 2000, F2000, T2000, 2010A, F2010A, 2050A, F2050A, 2070A, F2; ROCKWELL ; ROCKWELL FD901, FD902, FD903	8567B	NAVISTAR/IHC TRUCK ; NAVISTAR/IHC TRUCK Cargostar Models CO1610, CO1630, CO1710, CO1730, CO1750, CO1810, COF1810, CO1830, CO1850, CO1910, COF1910, CO1950, COF1950, COF5870, D400, DC400, DCF400, DCF400M, DF400, D405, DC405, DCF405, DCT405, DF405, DT405 Conventional, Fleetstar Models 1900, F1900,
		8567N	
		8568B	FORD TRUCK ; FORD TRUCK B600, B6000, B700, B7000, C600, CT600, C700, CT700, C750, C7000, C800, C8000, CT8000, C900, CT900, C9000, CT800, F600, FT600, F700, FT700, F750, F800, F8000, FT800, F900, FT900, L800, LA800, L900, LA900, LL900, LN900, L9000, LN9000, LN600, LN700, LN800, L
		8570B	CHEVROLET TRUCK ; CHEVROLET TRUCK C50, C5D, C5H, C5500, Kodiak, C60, C6D, C6H, Kodiak, P40, P60, S60; GMC TRUCK ; GMC TRUCK C5000, C5D, Topkick, C5500, C6000, C6D, Topkick, P4500, P6000, S6000
8519N	BROCKWAY SERIES 147WL, 148WD, 148SLD, 155W, 257, 260; CHEVROLET TRUCK 7,8,9 & 10 SERIES; DODGE TRUCK ; DODGE TRUCK ALL (Except W500 4WD), C1000, C700, C800, C850, C900, CN800, CNT800, CN900, CNT900, CT700, CT800, CT900, D1000, D700, D800, L700, LN1000, LNT1000, LV1000, LVT1000, LS1000, LT1000, NC1000, NCT1000, NL1000, NLT1000, VL1000, VLT1000, NC900, NCT900, T,TA,TAL.; FORD TRUCK ; FORD TRUCK B700, B7000, C1100, C600, CT600, C700, CT700, C750, C7000, C800, C8000, CT8000, C850, C900, CT900, C9000, C950, C1000, CT800, CT850, CT950, F1000, F1100, F600, F700, FT700, F750, F800, F8000, FT800, F850, F950, F900, HT950, H1000, L800, LA800, L900, LA900; NAVISTAR/IHC TRUCK ; NAVISTAR/IHC TRUCK Cargostar Models CO1610, CO1630, CO1710, CO1730, CO1750, CO1810, COF1810, CO1830, CO1850, CO1910, COF1910, CO1950, COF1950, Fleetstar Models 1900, F1900, T1900, 1910A, F1900A, 1950, F1950, T1950, 2000, F2000, T2000, 2010A, F2010A, 2050A, F2050A, 2070A, F2; ROCKWELL ; ROCKWELL FD901, FD902, FD903	8570B010	CHEVROLET TRUCK ; CHEVROLET TRUCK C50, C5D, C5H, C5500, Kodiak, C60, C6D, C6H, Kodiak; GMC TRUCK ; GMC TRUCK C5500, C6000, C6D, Topkick, S6000
		8570N	CHEVROLET TRUCK ; CHEVROLET TRUCK C50, C5D, C5H, C5500, Kodiak, C60, C6D, C6H, Kodiak, P40, P60, S60; GMC TRUCK ; GMC TRUCK C5000, C5D, Topkick, C5500, C6000, C6D, Topkick, P4500, P6000, S6000
8527B	WESTPORT AXLE ; WESTPORT AXLE F3W-1200, F6W-1200; WHITE TRUCK WHITE AXLES		
8553B	AUTOCAR A42, S42, A64, S64; BROCKWAY ; BROCKWAY SERIES 358, 359, 360, 361, 527, SERIES 450, 450C, 550, 550C, 700, 700C; FREIGHTLINER OTHER MODELS Conventional and Cab-Over-Engine; KENWORTH ; KENWORTH C500 Conventional, K100 Cab-Over-Engine (To 1986), L700 Cab Forward, W900, W900B, W900L, W900S; MARMON Conventional, COE; NAVISTAR/IHC TRUCK ; NAVISTAR/IHC TRUCK D400, DC400, DCF400, DCF400M, DF400, D405, DC405, DCF405, DCT405, DF405, DT405 Conventional, Fleetstar Models 1900, F1900, T1900, 1910A, F1900A, 1950, F1950, T1950, 2000, F2000, T2000, 2010A, F2010A, 2050A, F2050A, 2070A, F2070A, 2110A, Loadstar & School ; PETERBILT ; PETERBILT 252, 282, 289, 300, 348, 352, 352H, 353, 359, 310, 320, 330, 357, 362, 372, 375, 376, 377, 378, 379, 385, 387; ROCKWELL FF921, FF923; WHITE TRUCK ; WHITE TRUCK WFC-12042T, WFC-12064, WFC-12064T, WFP-6342T, WFP-6364, WFP-6364T, WFT-7564T, WFT-6342T, WFT-6364, WFT-6364T, WFT-7564T, WFT-8164T, WFT-9664T		
8560B	DODGE TRUCK ; DODGE TRUCK C500, C600, D600, D700, M400, R400, M600, S500, S600, S700		
8560N	DODGE TRUCK ; DODGE TRUCK C500, C600, D400, D500, D600, D700, DL400, P400, PL400, M400, R400, M500, R500, M600, S500, S600, S700		
8562B	DODGE TRUCK ; DODGE TRUCK CT800, D600, D700, S600, S700		
8562N	DODGE TRUCK ; DODGE TRUCK D600, D700, S600, S700		

Heavy Duty Chassis Parts Numerical/Buyers Guide

Numerical/Buyer's Guide

King Bolt Sets (Cont'd)	
8571B	AUTOCAR ; AUTOCAR CK64, CK64ST, DC42, K42, KM42, KS42, DC64, DK64, K64, KL64, KM64, KS64, KMS64F, DC87T, DC9364, DC9964, DC10364; BLUE BIRD Express Commuter Coach; BROCKWAY ; BROCKWAY SERIES 358, 359, 360, 361, 527, SERIES 450, 450C, 550, 550C, 700, 700C; CHEVROLET TRUCK ; CHEVROLET TRUCK Bison, Bruin, D90, J70, J80, J90, M90, Titan; FORD TRUCK ; FORD TRUCK Aeromax Series, A85, AT85, A95, AT95, C600, CT600, C700, CT700, C750, C7000, C800, C8000, CT8000, C900, CT900, C9000, CT800, L800, LA800, L900, LA900, LL900, LN900, L9000, LN9000, LLA900, LLS900, LTLA900, LTLS900, LN800, L8000, LN8000, LNT800, LNT900, LT9; FREIGHTLINER ; FREIGHTLINER FLB, FLL Series Cab-Over-Engine, FLC112SD Severe-Duty, FLD 112SD, FLD 120SD Conventional cab, Severe Duty, FLD 120 Conventional Cab, Long, Aluminun, FLD 132 Classic XL, Conventional Cab, OTHER MODELS Conventional and Cab-Over-Engine; GMC TRUCK ; GMC TRUCK Astro, D9K, D9L, Brigadier, J8C, J9C, D9500, General, N9E, N9F, J7500, J9500, M9500; KENWORTH ; KENWORTH C500 B Conventional Cab, C500 Conventional, C500B Conventional Cab, K100 (set forward axle), K100E(Set Back Axle), Cab-Over-Engine From 1986, K100 Cab-Over-Engine (To 1986), L700 Cab Forward, T450A, T450B Conventional Cab, T800, T800B, Conventional Cab, ; MACK R600L, R600LS, R700L, R700LS, RWL700S, RWS700S, WL700L WL700LS, WS700L, WS700LS; MARMON ; MARMON COE, Conventional, Conventional, COE; NAVISTAR/IHC TRUCK ; NAVISTAR/IHC TRUCK 2554, 2574, 2654, 2674 Series (Built 1989 & Later), 3700, 3800, 3900 Series, 4600, 4700, 4800, 4900 Series, 7100 Series, 8100, 8200, 8300 Series (Built 1989 & Later), 9200 Series, 9300, 9400 Series, 9600, 9700 Series, Cargostar Models CO1610, CO1630, CO17; PETERBILT ; PETERBILT 252, 282, 289, 300, 348, 352, 352H, 353, 359, 310, 320, 330, 357, 362, 372, 375, 376, 377, 378, 379, 385, 387; ROCKWELL ; ROCKWELL FL931, FL933, FL941, FL943, FL951; VOLVO/WHITE/GMC ; VOLVO/WHITE/GMC AC Series, ACL Series, WG Series, XPEDITOR; WESTERN STAR 3842S, 3864S, 4842, 4864, 4942, 4964, 5842SS, 5864SS, 5942SS, 5964SS, 6964F, 6964S, 6969RL; WHITE TRUCK ; WHITE TRUCK RB2-42T, 4842, 4864, 4942, 4964, RB2-64T, RC2-42T, RC2-64T, RX2-42T, RX2-64T, WFC-12042T, WFC-12064, WFC-12064T, WFP-6342T, WFP-6364, WFP-6364T, WFP-7564T, WFT-6342T, WFT-6364, WFT-6364T, WFT-7564T, WFT-8164T, WFT-9664T
8571C	KENWORTH ; KENWORTH C500 B Conventional Cab, C500 Conventional
8572B	FORD TRUCK ; FORD TRUCK C600, CT600, C700, CT700, C750, C7000, C800, C8000, CT8000, C900, CT900, C9000, CF600, CF700, CF800, CFT800, CL900, CLT900, CL9000, CLT9000, CT800, F600, FT600, F700, FT700, F800, F8000, FT800, F900, FT900, L800, LA800, L900, LA900, LL900, LN900, L9000, L
8573B	FORD TRUCK ; FORD TRUCK C600, CT600, C700, CT700, C750, C7000, C800, C8000, CT8000, C900, CT900, C9000, CF600, CF700, CF800, CFT800, CT800, F600, FT600, F700, FT700, F800, F8000, FT800, F900, FT900, L800, LA800, L900, LA900, LL900, LN900, L9000, LN9000, LN800, L8000, LN8000, LNT
8577B	DANA/SPICER AXLE ; NAVISTAR/IHC TRUCK ; NAVISTAR/IHC TRUCK Cargostar Models CO1610, CO1630, CO1710, CO1730, CO1750, CO1810, COF1810, CO1830, CO1850, CO1910, COF1910, CO1950, COF1950, Fleetstar Models 1900, F1900, T1900, 1910A, F1900A, 1950, F1950, T1950, 2000, F2000, T2000, 2010A, F2010A, 2050A, F2050A, 2070A, F2

Part Number	Application
King Bolt Sets (Cont'd)	
8577B010	DANA/SPICER AXLE ; DANA/SPICER AXLE 02ADA, 02ADB; NAVISTAR/IHC TRUCK Loadstar & School Bus Models 1600, 1700, 1750, 1800, 1850, 1890, F1600, F1700, F1800, F1850, CO1600, CO1700, CO1750, CO1800, CO1850
8577C	DANA/SPICER AXLE ; DANA/SPICER AXLE 02ADA, 02ADB, I50, I60, I60S, I75, I80, I80S; NAVISTAR/IHC TRUCK ; NAVISTAR/IHC TRUCK 3700, 3800, 3900 Series, 4600, 4700, 4800, 4900 Series, 7100 Series, Cargostar Models CO1610, CO1630, CO1710, CO1730, CO1750, CO1810, COF1810, CO1830, CO1850, CO1910, COF1910, CO1950, COF1950, Fleetstar Models 1900, F1900, T1900, 1910A, F1900A, 1950, F195
8577C002	
8579B	NAVISTAR/IHC TRUCK ; NAVISTAR/IHC TRUCK Cargostar Models CO1610, CO1630, CO1710, CO1730, CO1750, CO1810, COF1810, CO1830, CO1850, CO1910, COF1910, CO1950, COF1950, Fleetstar Models 1900, F1900, T1900, 1910A, F1900A, 1950, F1950, T1950, 2000, F2000, T2000, 2010A, F2010A, 2050A, F2050A, 2070A, F2
8579B002	
8581B	NAVISTAR/IHC TRUCK ; NAVISTAR/IHC TRUCK 9600, 9700 Series, Cargostar Models CO1610, CO1630, CO1710, CO1730, CO1750, CO1810, COF1810, CO1830, CO1850, CO1910, COF1910, CO1950, COF1950, CO9670, COF9670, Eagle, Fleetstar Models 1900, F1900, T1900, 1910A, F1900A, 1950, F1950, T1950, 2000, F2000, T20
8581B002	NAVISTAR/IHC TRUCK ; NAVISTAR/IHC TRUCK 9600, 9700 Series, Cargostar Models CO1610, CO1630, CO1710, CO1730, CO1750, CO1810, COF1810, CO1830, CO1850, CO1910, COF1910, CO1950, COF1950, Fleetstar Models 1900, F1900, T1900, 1910A, F1900A, 1950, F1950, T1950, 2000, F2000, T2000, 2010A, F2010A, 2050A
8581N	DANA/SPICER AXLE I108, I120, I132; NAVISTAR/IHC TRUCK ; NAVISTAR/IHC TRUCK 9600, 9700 Series, Cargostar Models CO1610, CO1630, CO1710, CO1730, CO1750, CO1810, COF1810, CO1830, CO1850, CO1910, COF1910, CO1950, COF1950, CO9670, COF9670, Eagle, COF5870, Fleetstar Models 1900, F1900, T1900, 1910A, F1900A, 1950, F1950, T1950, 2000, F
8581N002	DANA/SPICER AXLE I108, I120, I132; NAVISTAR/IHC TRUCK ; NAVISTAR/IHC TRUCK 9600, 9700 Series, Cargostar Models CO1610, CO1630, CO1710, CO1730, CO1750, CO1810, COF1810, CO1830, CO1850, CO1910, COF1910, CO1950, COF1950, COF5870, Fleetstar Models 1900, F1900, T1900, 1910A, F1900A, 1950, F1950, T1950, 2000, F2000, T2000, 2010A, F201
8583B	NAVISTAR/IHC TRUCK ; NAVISTAR/IHC TRUCK Cargostar Models CO1610, CO1630, CO1710, CO1730, CO1750, CO1810, COF1810, CO1830, CO1850, CO1910, COF1910, CO1950, COF1950, Fleetstar Models 1900, F1900, T1900, 1910A, F1900A, 1950, F1950, T1950, 2000, F2000, T2000, 2010A, F2010A, 2050A, F2050A, 2070A, F2
8583N	DANA/SPICER AXLE I90; NAVISTAR/IHC TRUCK ; NAVISTAR/IHC TRUCK Cargostar Models CO1610, CO1630, CO1710, CO1730, CO1750, CO1810, COF1810, CO1830, CO1850, CO1910, COF1910, CO1950, COF1950, Fleetstar Models 1900, F1900, T1900, 1910A, F1900A, 1950, F1950, T1950, 2000, F2000, T2000, 2010A, F2010A, 2050A, F2050A, 2070A, F2
8583N002	
8585B	FORD TRUCK CL900, CLT900, CL9000, CLT9000
8587B	DODGE TRUCK ; DODGE TRUCK M400, R400, M500, R500
8587N	

Heavy Duty Chassis Parts Numerical/Buyers Guide

King Bolt Sets (Cont'd)		Part Number	Application
8590B	BLUE BIRD ; BLUE BIRD All American FE, Wander Lodge M380, Xcel 102; BROCKWAY ; BROCKWAY SERIES 358, 359, 360, 361, 527, SERIES 450, 450C, 550, 550C, 700, 700C; CHEVROLET TRUCK ; CHEVROLET TRUCK Bison, Bruin, S70, S7T, Titan; FREIGHTLINER ; FREIGHTLINER FLB, FLL Series Cab-Over-Engine, FLC 112 Series, FLD 112 Conventional Cab, Medium, Aluminun, FLD 120 Conventional Cab, Long, Aluminun, FLD 132 Classic XL, Conventional Cab, OTHER MODELS Conventional and Cab-Over-Engine; GMC TRUCK ; GMC TRUCK Astro, D9K, D9L, Brigadier, J8C, J9C, General, N9E, N9F, S7500, S7T; KENWORTH ; KENWORTH C500 Conventional, C500B Conventional Cab, K100 (set forward axle), K100E(Set Back Axle), Cab-Over-Engine From 1986, K100 Cab-Over-Engine (To 1986), L700 Cab Forward, T400A, T400B Conventional Cab, T450A, T450B Conventional Cab, T600A, T600B Conventional; MACK R600L, R600LS, R700L, R700LS, RWL700S, RWS700S, WL700L WL700LS, WS700L, WS700LS; MARMON ; MARMON COE, Conventional, Conventional, COE; NAVISTAR/IHC TRUCK ; NAVISTAR/IHC TRUCK 8100, 8200, 8300 Series (Built 1989 & Later), 9200 Series, 9300, 9400 Series, 9600, 9700 Series, CO9670, COF9670, Eagle, S Series Heavy Duty Models 2275, F2275, 2276, F2276, 2375, F2375, 2524, F2524, 2554, F2554, 2574, F2574, 2575, F2575, 2624, F2624, F26; PETERBILT ; PETERBILT 252, 282, 289, 300, 348, 352, 352H, 353, 359, 310, 320, 330, 357, 362, 372, 375, 376, 377, 378, 379, 385, 387; ROCKWELL ; ROCKWELL FF931, FF932, FF933, FF934, FF941, FF942, FF943, FF944; THOMAS BUILT ; THOMAS BUILT ER Series, Saf-T-Liner C2, SCHOOL BUS; VOLVO/WHITE/GMC ; VOLVO/WHITE/GMC AERO Series, AUTOHAULER TRACTORS, WHR, WIL, WIA Series, XPEDITOR; WHITE TRUCK ; WHITE TRUCK RB2-42T, 4842, 4864, 4942, 4964, RB2-64T, RBW-42T, RBW-64T, RC2-42T, RC2-64T, RCW-42T, WSH-42T, WSH-64T, RCW-64T, RX2-42T, RX2-64T, WFC-12042T, WFC-12064, WFC-12064T, WFP-6342T, WFP-6364, WFP-6364T, WFP-7564T, WFT-6342T, WFT-6364, WFT-6364T, WFT-7564T, W	8610B	DANA/SPICER AXLE I90; NAVISTAR/IHC TRUCK ; NAVISTAR/IHC TRUCK Cargostar Models CO1610, CO1630, CO1710, CO1730, CO1750, CO1810, COF1810, CO1830, CO1850, CO1910, COF1910, CO1950, COF1950, S Series Heavy Duty Models 2275, F2275, 2276, F2276, 2375, F2375, 2524, F2524, 2554, F2554, 2574, F2574, 2575, F2575, 2624, F2624.
8592B	MACK ; MACK B42, B67, B70, B61, R600, R685R, R685ST, R686ST, RD400, RD600, R700, U600, U68ST, F700, F786ST, R767ST	8610C	DANA/SPICER AXLE ; DANA/SPICER AXLE I108, I120, I132, I90; NAVISTAR/IHC TRUCK ; NAVISTAR/IHC TRUCK 9600, 9700 Series, Cargostar Models CO1610, CO1630, CO1710, CO1730, CO1750, CO1810, COF1810, CO1830, CO1850, CO1910, COF1910, CO1950, COF1950, COF5870, Paystar Models 5010, 5050, 5070, F5010, F5050, F5070, F5050SF, F5070SF, F5050SF-LW, F5070SF-LW, CO5370.
8593B	MACK ; MACK B42, B67, B70, B61, DM400, DM600, DM606S, DM607S, DM685S, DM685T, DMM600, RD700, MB400, MB600, R400, R600, R685R, R685ST, R686ST, R600L, R600LS, R700L, R700LS, RWL700S, RWS700S, WL700L WL700LS, WS700L, WS700LS, RD400, RD600, R700, U600, U68ST, F700, F786	8611B	BLUE BIRD Wander Lodge 450LXI; FREIGHTLINER ; FREIGHTLINER C112, C120 Century Class, Conventional Cab, FLA, FLP, FLT Series Cab-Over-Engine, FLB, FLL Series Cab-Over-Engine, FLC 112 Series, FLC112SD Severe-Duty, FLD 112 Conventional Cab, Medium, Aluminun, FLD 112SD, FLD 120SD Conventional cab, Severe Duty, FLD; KENWORTH ; KENWORTH K100 (set forward axle), K100E(Set Back Axle), Cab-Over-Engine From 1986, T400A, T400B Conventional Cab, T450A, T450B Conventional Cab, T800, T800B, Conventional Cab, W900, W900B, W900L, W900S; NAVISTAR/IHC TRUCK 9300, 9400 Series; PETERBILT 310, 320, 330, 357, 362, 372, 375, 376, 377, 378, 379, 385, 387; ROCKWELL ; ROCKWELL 17100, 17101, 17111, FF931, FF932, FF941, 942, FF943, FG931, FG933, FG941, FG943; THOMAS BUILT ; THOMAS BUILT ER Series, SCHOOL BUS; VOLVO/WHITE/GMC ; VOLVO/WHITE/GMC ACL Series, AERO Series, AUTOHAULER TRACTORS, WG Series, WHR, WIL, WIA Series, XPEDITOR; WESTERN STAR 3842S, 3864S, 4842, 4864, 4942, 4964, 5842SS, 5864SS, 5942SS, 5964SS, 6964F, 6964S, 6969RL
8601B	MACK ; MACK DM400, DM600, DM606S, DM607S, DM685S, DM685T, DMM600, RD700, MB400, MB600, MC400, MC600, MR400, MR600, R400, R600, R685R, R685ST, R686ST, R600L, R600LS, R700L, R700LS, RWL700S, RWS700S, WL700L WL700LS, WS700L, WS700LS, RD400, RD600, R700, U600, U68ST, F7	8612B	CHEVROLET TRUCK Titan; FREIGHTLINER OTHER MODELS Conventional and Cab-Over-Engine; KENWORTH ; KENWORTH C500 Conventional, K100 Cab-Over-Engine (To 1986), L700 Cab Forward, W900, W900B, W900L, W900S; MARMON Conventional, COE; NAVISTAR/IHC TRUCK ; NAVISTAR/IHC TRUCK 9300, 9400 Series, 9600, 9700 Series, CO9670, COF9670, Eagle, Transtar Models 4200, F4200, 4300, F4300; PETERBILT ; PETERBILT 252, 282, 289, 300, 348, 352, 352H, 353, 359, 310, 320, 330, 357, 362, 372, 375, 376, 377, 378, 379, 385, 387; ROCKWELL FF971; THOMAS BUILT Saf-T-Liner C2
8605B	WESTPORT AXLE ; WESTPORT AXLE F3W-1200, F3W-1600, F6W-1200, F6W-1600; WHITE TRUCK ; WHITE TRUCK RB2-42T, 4842, 4864, 4942, 4964, RB2-64T, RBW-42T, RBW-64T, RC2-42T, RC2-64T, RCW-42T, WSH-42T, WSH-64T, RCW-64T, RX2-42T, RX2-64T	8613B	CHEVROLET TRUCK ; CHEVROLET TRUCK B60, B6P, Bison, Bruin, C60, C6D, C6H, Kodiak, C65, C70, C7D, Kodiak, D90, F90, H70, H80, H90, J70, J80, M60, M65, M90, P60, S70, S7T, T65, T70, Titan, W70, W7N; GMC TRUCK ; GMC TRUCK Astro, D9K, D9L, B6000, B6P, Brigadier, J8C, J9C, C6000, C6D, Topkick, C7500, C7D, Topkick, F9500, General, N9E, N9F, H8500, H9500, J7500, J8500, M9500, P6000, S7500, S7T, T7500
8609B	FORD TRUCK ; FORD TRUCK B500, F500, B600, B6000, B700, B7000, F600, FT600, F700, FT700, LN500, LN600, LN700, M400 Motor Home Chassis, N500, N600, N6000, P500, P600	8616C	BLUE BIRD ; BLUE BIRD Wander Lodge M380, Xcel 102; MARMON ; MARMON COE, Conventional; THOMAS BUILT ER Series
		8617B	DANA/SPICER AXLE I108, I120, I132; NAVISTAR/IHC TRUCK ; NAVISTAR/IHC TRUCK 9600, 9700 Series, CO9670, COF9670, Eagle, COF5870, Paystar Models 5010, 5050, 5070, F5010, F5050, F5070, F5050SF, F5070SF, F5050SF-LW, F5070SF-LW, CO5370, COF5370, S Series Heavy Duty Models 2275, F2275, 2276, F2276, 2375, F2375, 2524, F2524, 2554, F2554

Numerical/Buyer's Guide

Heavy Duty Chassis Parts Numerical/Buyers Guide

	Part Number	Application
King Bolt Sets (Cont'd)	King Bolt Sets (Cont'd)	
8618C EATON EFA-12F3, EFA-13F3, EFA-12F4, EFA-13F5, EFA-18F3, EFA-20F4, EFA-22T2, EFA-22T5, EFA-24T2, EFA-24T5; FREIGHTLINER FLD 120 Conventional Cab, Long, Aluminum; KENWORTH; KENWORTH C500B Conventional Cab, K100 (set forward axle), K100E(Set Back Axle), Cab-Over-Engine From 1986, K300 Cab-Over-engine, T400A, T400B Conventional Cab, T450A, T450B Conventional Cab, T600A, T600B Conventional Cab, T800, T800B, Conventional Cab, W900, W900; MARMON; MARMON COE, Conventional; NAVISTAR/IHC TRUCK; NAVISTAR/IHC TRUCK 9200 Series, 9300, 9400 Series, 9600, 9700 Series, S Series Heavy Duty Models 2275, F2275, 2276, F2276, 2375, F2375, 2524, F2524, 2554, F2554, 2574, F2574, 2575, F2575, 2624, F2624, F2654, 2674, F2674, 2675, F2675; PETERBILT; PETERBILT 252, 282, 289, 300, 348, 352, 352H, 353, 359, 310, 320, 330, 357, 362, 372, 375, 376, 377, 378, 379, 385, 387; VOLVO/WHITE/GMC; VOLVO/WHITE/GMC AERO Series, AUTOHAULER TRACTORS, WG Series, WHR, WIL, WIA Series; WESTERN STAR 3842S, 3864S, 4842, 4864, 4942, 4964, 5842SS, 5864SS, 5942SS, 5964SS, 6964F, 6964S, 6969RL	8641B FORD TRUCK; FORD TRUCK Aeromax Series, A85, AT85, A95, AT95, CF600, CF700, CF800, CFT800, L800, LA800, L900, LA900, LL900, LN900, L9000, LN9000, LLA900, LLS900, LTLA900, LTLS900, LN700, LN800, L8000, LN8000, LNT800, LNT900, LT900, LNT8000, LT8000, LNT9000, LT9000, Louisville Se	
8631B EATON EFA-12F3, EFA-13F3, EFA-12F4, EFA-13F5, EFA-18F3, EFA-20F4, EFA-22T2, EFA-22T5, EFA-24T2, EFA-24T5; NAVISTAR/IHC TRUCK; NAVISTAR/IHC TRUCK 9200 Series, 9300, 9400 Series, 9600, 9700 Series; PETERBILT; PETERBILT 252, 282, 289, 300, 348, 352, 352H, 353, 359, 310, 320, 330, 357, 362, 372, 375, 376, 377, 378, 379, 385, 387	8643B FORD TRUCK; FORD TRUCK C600, CT600, CF600, CF700, CF800, CFT800, CL900, CLT900, CL9000, CLT9000, F600, FT600, F700, FT700, F800, F8000, FT800, F900, FT900, L800, LA800, L900, LA900, LL900, LN900, L9000, LN9000, LN800, L8000, LN8000, LNT800, LNT900, LT900, LNT8000, LT8000, LNT90	
8631C	8645B NAVISTAR/IHC TRUCK; NAVISTAR/IHC TRUCK Cargostar Models CO1610, CO1630, CO1710, CO1730, CO1750, CO1810, COF1810, CO1830, CO1850, CO1910, COF1910, CO1950, COF1950, Fleetstar Models 1900, F1900, T1900, 1910A, F1900A, 1950, F1950, T1950, 2000, F2000, T2000, 2010A, F2010A, 2050A, F2050A, 2070A, F2	
8633B CHEVROLET TRUCK; CHEVROLET TRUCK C70, C7D, Kodiak, T5500, T6500, T7500, T8500; EATON; EATON E1460W, EFA-12F3, EFA-13F3, EFA-12F4, EFA-13F5, EFA-18F3, EFA-20F4, EFA-22T2, EFA-22T5, EFA-24T2, EFA-24T5; KENWORTH; KENWORTH T800 Conventional Cab, T800B Conventional Cab, W900, W900B, W900L, W900S; PETERBILT 310, 320, 330, 357, 362, 372, 375, 376, 377, 378, 379, 385, 387	8647B EATON EFA-12F3, EFA-13F3, EFA-12F4, EFA-13F5, EFA-18F3, EFA-20F4, EFA-22T2, EFA-22T5, EFA-24T2, EFA-24T5; KENWORTH; KENWORTH C500B Conventional Cab, K100 (set forward axle), K100E(Set Back Axle), Cab-Over-Engine From 1986, K300 Cab-Over-engine, T400A, T400B Conventional Cab, T450A, T450B Conventional Cab, T600A, T600B Conventional Cab, T800, T800B, Conventional Cab, W900, W900; NAVISTAR/IHC TRUCK; NAVISTAR/IHC TRUCK 9200 Series, 9300, 9400 Series, 9600, 9700 Series, S Series Heavy Duty Models 2275, F2275, 2276, F2276, 2375, F2375, 2524, F2524, 2554, F2554, 2574, F2574, 2575, F2575, 2624, F2624, F2654, 2674, F2674, 2675, F2675; PETERBILT; PETERBILT 252, 282, 289, 300, 348, 352, 352H, 353, 359, 310, 320, 330, 357, 362, 372, 375, 376, 377, 378, 379, 385, 387; VOLVO/WHITE/GMC; VOLVO/WHITE/GMC AERO Series, AUTOHAULER TRACTORS, WG Series, WHR, WIL, WIA Series; WESTERN STAR 3842S, 3864S, 4842, 4864, 4942, 4964, 5842SS, 5864SS, 5942SS, 5964SS, 6964F, 6964S, 6969RL	
8633C CHEVROLET TRUCK; CHEVROLET TRUCK C70, C7D, Kodiak, T5500, T6500, T7500, T8500; EATON; EATON E1460W, EFA-12F3, EFA-13F3, EFA-12F4, EFA-13F5, EFA-18F3, EFA-20F4, EFA-22T2, EFA-22T5, EFA-24T2, EFA-24T5; GMC TRUCK C7500, C7D, Topkick; KENWORTH; KENWORTH T800 Conventional Cab, T800B Conventional Cab, W900, W900B, W900L, W900S; PETERBILT 310, 320, 330, 357, 362, 372, 375, 376, 377, 378, 379, 385, 387	8653B FORD TRUCK; FORD TRUCK B600, B6000, B700, B7000, F600, FT600, F700, FT700, F800, F8000, FT800, F900, FT900	
8635C BLUE BIRD Wander Lodge 450LXI	8655B DANA/SPICER AXLE; DANA/SPICER AXLE 02ADC, 02ADD, I100S, I120S, I100SG, I120SG; NAVISTAR/IHC TRUCK; NAVISTAR/IHC TRUCK 2554, 2574, 2654, 2674 Series (Built 1989 & Later), 3700, 3800, 3900 Series, 4600, 4700, 4800, 4900 Series, 7100 Series, 8100, 8200, 8300 Series (Built 1989 & Later), 9100 Series Short conventional Cab, 9200 Series, 9300, 9400 Series, 9600, 9700 Series, 9; STERLING TRUCK A, L, S Series	
8637B DANA/SPICER AXLE; DANA/SPICER AXLE 02ADA, 02ADB, D800F, D800N, I50, I60, I60S, I75, I80, I80S; NAVISTAR/IHC TRUCK; NAVISTAR/IHC TRUCK 3700, 3800, 3900 Series, 4600, 4700, 4800, 4900 Series, 7100 Series, Fleetstar Models 1900, F1900, T1900, 1910A, F1900A, 1950, F1950, T1950, 2000, F2000, T2000, 2010A, F2010A, 2050A, F2050A, 2070A, F2070A, 2110A, Loadstar & School Bus Models 1600, 1700, 1	8655C	
8637C DANA/SPICER AXLE; DANA/SPICER AXLE 02ADA, 02ADB, D800F, D800N, I50, I60, I60S, I75, I80, I80S; NAVISTAR/IHC TRUCK; NAVISTAR/IHC TRUCK 3700, 3800, 3900 Series, 4600, 4700, 4800, 4900 Series, 7100 Series, Loadstar & School Bus Models 1600, 1700, 1750, 1800, 1850, 1890, F1600, F1700, F1800, F1850, CO1600, CO1700, CO1750, CO1800, CO1850, M1400, M1600, 1452, 1652 Series Medium Duty, S Serie	8657B DANA/SPICER AXLE; DANA/SPICER AXLE 02ADE, 02ADG, I132SG, I140S, I140SG; NAVISTAR/IHC TRUCK; NAVISTAR/IHC TRUCK 2554, 2574, 2654, 2674 Series (Built 1989 & Later), 3700, 3800, 3900 Series, 4600, 4700, 4800, 4900 Series, 7100 Series, 8100, 8200, 8300 Series (Built 1989 & Later), 9200 Series, 9300, 9400 Series, 9600, 9700 Series, 9800 Series, M1400, M1600, 1452, 1652; STERLING TRUCK A, L, S Series	
8639B FORD TRUCK; FORD TRUCK B600, B6000, B700, B7000, F600, FT600, F700, FT700, F800, F8000, FT800, F900, FT900, L800, LA800, L900, LA900, LL900, LN900, L9000, LN9000, LN800, L8000, LN8000, LS800	8659B CHEVROLET TRUCK; CHEVROLET TRUCK B7T, C50, C5D, C5H, C5500, Kodiak, C60, C6D, C6H, Kodiak, C70, C7D, Kodiak, P60, P6S, T5500, T6500, T7500, T8500; GMC TRUCK; GMC TRUCK B7T, C5000, C5D, Topkick, C6000, C6D, Topkick, C7500, C7D, Topkick, P6000, P6S; ISUZU FSR	
	8660B CHEVROLET TRUCK; CHEVROLET TRUCK B7T, C70, C7D, Kodiak, P60, P6S, T5500, T6500, T7500, T8500; GMC TRUCK; GMC TRUCK B7T, C7500, C7D, Topkick, P6000, P6S; ISUZU; ISUZU FSR, FTR, FVR	

Heavy Duty Chassis Parts Numerical/Buyers Guide

	Part Number	Application
King Bolt Sets (Cont'd)	King Bolt Sets (Cont'd)	
8660B	CHEVROLET TRUCK ; CHEVROLET TRUCK B7T, C70, C7D, Kodiak, P60, P6S, T5500, T6500, T7500, T8500; GMC TRUCK ; GMC TRUCK B7T, C7500, C7D, Topkick, P6000, P6S; ISUZU ; ISUZU FSR, FTR, FVR	
8661B	CHEVROLET TRUCK ; CHEVROLET TRUCK C70, C7D, Kodiak, T5500, T6500, T7500, T8500; GMC TRUCK C7500, C7D, Topkick	
ES434L	WHITE TRUCK WFC-12042T, WFC-12064, WFC-12064T	

Numerical/Buyer's Guide

Heavy Duty Chassis Parts Numerical/Buyers Guide

	Part Number	Application
Tie Rod Ends	Tie Rod Ends	
-	FORD TRUCK L800, LA800	ES187L
8661B	ISUZU ; ISUZU FSR, FTR, FVR	AUTOCAR ; AUTOCAR A42, S42, A64, S64, C85, C85T, C87, C87D, D87-OH, DC102T, DC103T, C9564, DC9564, C9764, C9764S, DC9764, C10364S, DC10364S, DC10464, DC10464S; BROCKWAY ; BROCKWAY SERIES 147WL, 148WD, 148SLD, 155W, 257, 260, SERIES 358, 359, 360, 361, 527, SERIES 450, 450C, 550, 550C, 700, 700C, SERIES F260L, F260LF, F260LQ, F260T, H260L, H260LF, H257T, N257T, N260L, N260LF, N260LQ, N260T, 2606L; CHEVROLET TRUCK ; CHEVROLET TRUCK 7,8,9 & 10 Series, D90, F90, H90, J90, M90; DIAMOND T 720C, 730C, 830C, 901, 910, 910N, 910R, 911N, 920, 952;27460,27465 W/TIMPKEN AXLE; DODGE TRUCK ; DODGE TRUCK ALL (Except W500 4 WD), C1000, C700, C800, C850, C900, CN800, CNT800, CN900, CNT900, CT700, CT800, CT900, D1000, D700, D800, DN1000, DNT1000, L700, LN1000, LNT1000, LV1000, LVT1000, LS1000, LT1000, NC1000, NCT1000, NL1000, NLT1000, VL1000, VLT1000, NC900.; FABCO SDA12,SDA14,SDA16,SDA18,SDA21,SDA23; FORD TRUCK ; FORD TRUCK B7000, C1100, C600, CT600, C700, CT700, C750, C7000, C800, C8000, CT8000, C850, C900, CT900, C9000, C950, C1000, CT800, CT850, CT950, F1000, F1100, F600, F700, FT700, F750, F800, F8000, FT800, F850, F950, HT950, H1000, LN600, LN700, LS800, LT800, LTL800, ; FREIGHTLINER OTHER MODELS Conventional and Cab-Over-Engine; GMC TRUCK ; GMC TRUCK D9500, M9500; KENWORTH ; KENWORTH C500 Conventional, K100 Cab-Over-Engine (To 1986), L700 Cab Forward, W900, W900B, W900L,W900S; MACK ; MACK DM400, DM600, DM606S, DM607S, DM685S, DM685T, DMM600, RD700, MB400, MB600, MC400, MC600, MR400, MR600, R400, R600, R685R, R685ST, R686ST, R600L, R600LS, R700L, R700LS, RWL700S, RWS700S, WL700L WL700LS, WS700L, WS700LS, RD400, RD600, R700, U600, U68ST, F7; MARMON Conventional, COE; NAVISTAR/IHC TRUCK ; NAVISTAR/IHC TRUCK 3700, 3800, 3900 Series, 4600, 4700, 4800, 4900 Series, 7100 Series, Cargostar Models CO1610, CO1630, CO1710, CO1730, CO1750, CO1810, COF1810, CO1830, CO1850, CO1910, COF1910, CO1950, COF1950, CO4000, COF4000, COT4000, D400, DC400, DCF400, DCF400M, DF400.; PETERBILT ; PETERBILT 252, 282, 289, 300, 348, 352, 352H, 353, 359, 310, 320, 330, 357, 362, 372, 375, 376, 377, 378, 379, 385, 387; ROCKWELL ; ROCKWELL 27460-A, 27465-A, FC931, FD901, FD902, FD903, FE900, FE903, FE910, FE970, FF901, FF903, FG900, FG903, FU910; WHITE TRUCK ; WHITE TRUCK WFC-12042T, WFC-12064, WFC-12064T, WFP-6342T, WFP-6364, WFP-6364T, WFP-7564T, WFT-6342T, WFT-6364, WFT-6364T, WFT-7564T, WFT-8164T, WFT-9664T
DS1362S	FORD TRUCK ; FORD TRUCK CF600, CF700, CF800, CFT800	ES187R
DS1363S	FORD TRUCK ; FORD TRUCK F700, FT700, F800, F8000, FT800, F900, FT900, L800, LA800, L900, LA900, LL900, LN900, L9000, LN9000, LLA900, LLS900, LTLA900, LTLS900, LN700, LN800, L8000, LN8000, LNT800, LNT900, LT900, LNT8000, LT8000, LNT9000, LS800, LT800, LTL800, LTS800,LTS80	ES194L
DS1367A	FORD TRUCK ; FORD TRUCK C600, CT600, C800, C8000, CT8000, CF600, CF700, CF800, CFT800, CL900, CLT900, CL9000, CLT9000, CT800, F600, FT600, F700, FT700, F800, F8000, FT800, F900, FT900, L800, LA800, L900, LA900, LL900, LN900, L9000, LN9000, LN800, L8000, LN8000, LNT800, LNT900, LT900, LNT8000, LT8000, LNT9000, LT9000, Louisville Series, L85, LT85, L95, LT95, LS800, LT800, LTL800, LS800, LT	DODGE TRUCK ; DODGE TRUCK ALL (Except W500 4 WD), F,FL, FN,FNL,FS,G,GA SERIES, H, HM,J, JM,K, KM SERIES, M600, R, RA,RAL,RL,RS SERIES, T,TA,TAL,TL,V,VA,VAL,VL,Y, YA,YAL,YL SERIES; FORD TRUCK ; FORD TRUCK B600, B6000, B700, B7000, C550, F600, FT600, F700, FT700, N600, N6000
DS1368A	FORD TRUCK ; FORD TRUCK F700, FT700, F800, F8000, FT800, F900, FT900, L800, LA800, L900, LA900, LL900, LN900, L9000, LN9000, LN800, L8000, LN8000, LNT800, LNT900, LT900, LNT8000, LT8000, LNT9000, LT9000, Louisville Series, L85, LT85, L95, LT95, LS800, LT800, LTL800, LTS800,LTS80	FORD TRUCK C600, CT600
DS1379S	FORD TRUCK ; FORD TRUCK CF600, CF700, CF800, CFT800, F600, FT600, F700, FT700, F800, F8000, FT800, F900, FT900, L800, LA800, L900, LA900, LL900, LN900, L9000, LN9000, LN800, L8000, LN8000, LNT800, LNT900, LT900, LNT8000, LT8000, LNT9000, LS800, LT800, LTL800, LTS800,LTS8	ES187R
DS1380S	FORD TRUCK ; FORD TRUCK L800, LA800, L900, LA900, LL900, LN900, L9000, LN9000, LN800, L8000, LN8000, LNT800, LNT900, LT900, LNT8000, LT8000, LNT9000, LT9000, LS800, LT800, LTL800, LTS800,LTS8000, LTL900, LTA 900, LTL9000, LTS900, LS900, LTS9000, LS9000	ES194L
ES150L	FORD TRUCK ; FORD TRUCK B500, F500, B600, B6000, B700, B7000, F4, F600, FT600, F700, FT700, N500, N600, N6000, P400, P500, P600	DODGE TRUCK ; DODGE TRUCK ALL (Except W500 4 WD), F,FL, FN,FNL,FS,G,GA SERIES, H, HM,J, JM,K, KM SERIES, M600, R, RA,RAL,RL,RS SERIES, T,TA,TAL,TL,V,VA,VAL,VL,Y, YA,YAL,YL SERIES; FORD TRUCK ; FORD TRUCK B600, B6000, B700, B7000, C550, F600, FT600, F700, FT700, N600, N6000
ES150R		FORD TRUCK B600, B6000, B700, B7000, C550, F600, FT600, F700, FT700, N600, N6000
ES158L	DODGE TRUCK ; DODGE TRUCK ALL (Except W500 4 WD), D400, D500, DL400, P400, PL400, F,FL, FN,FNL,FS,G,GA SERIES	ES194R
ES158R		DODGE TRUCK ; DODGE TRUCK ALL (Except W500 4 WD), F,FL, FN,FNL,FS,G,GA SERIES, H, HM,J, JM,K, KM SERIES, M600, R, RA,RAL,RL,RS SERIES, T,TA,TAL,TL,V,VA,VAL,VL,Y, YA,YAL,YL SERIES; FORD TRUCK ; FORD TRUCK B600, B6000, B700, B7000, C550, F600, FT600, F700, FT700, N600, N6000
ES176L	CHEVROLET TRUCK ; CHEVROLET TRUCK 6A (Regular),6B,6C (Heavy Duty), A60, A80, N80, Q80, V80, C50, C5D, Kodiak, C60, C6D, Kodiak, C65, C80, E80, L80, M80, U80, D60, H70, J70, L50, L60, M50, M60, M65, N50, N60, Y60, Q60, V60, X60, S50, Q50, S60, School Bus 6D,6E (Heavy Duty), T50, T60, T65, ; DODGE TRUCK ; DODGE TRUCK D700, R,RA,RAL,RL,RS SERIES, S600, S700, T,TA,TAL,TL,V,VA,VAL,VL,Y, YA,YAL,YL SERIES; GMC TRUCK ; GMC TRUCK C6000, C6D, Topkick, C6500, C9500, D9500, F9500, H7500, H8500, H9500, J7500, J8500, J9500, M6500, M9500, S6000, T6000, T6500, T7500, T8500, T9500, W7500, W8500, W9500	DODGE TRUCK ; DODGE TRUCK ALL (Except W500 4 WD), F,FL, FN,FNL,FS,G,GA SERIES, H, HM,J, JM,K, KM SERIES, M600, R, RA,RAL,RL,RS SERIES, T,TA,TAL,TL,V,VA,VAL,VL,Y, YA,YAL,YL SERIES; FORD TRUCK ; FORD TRUCK B600, B6000, B700, B7000, C550, F600, FT600, F700, FT700, N600, N6000
ES176R		DODGE TRUCK ; DODGE TRUCK ALL (Except W500 4 WD), F,FL, FN,FNL,FS,G,GA SERIES, H, HM,J, JM,K, KM SERIES, M600, R, RA,RAL,RL,RS SERIES, T,TA,TAL,TL,V,VA,VAL,VL,Y, YA,YAL,YL SERIES; FORD TRUCK ; FORD TRUCK B600, B6000, B700, B7000, C550, F600, FT600, F700, FT700, N600, N6000

Heavy Duty Chassis Parts Numerical/Buyers Guide

	Part Number		Application
Tie Rod Ends (Cont'd)		Tie Rod Ends (Cont'd)	
ES2035L	FORD TRUCK ; FORD TRUCK B600, B6000, B700, B7000, B7000, C600, CT600, C700, CT700, C750, C7000, C800, C8000, CT8000, C900, CT900, C9000, CF600, CF700, CF800, CFT800, CT800, F600, FT600, F700, FT700, F800, F8000, FT800, F900, FT900, L800, LA800, L900, LA900, LL900, LN900, L9000, FORD TRUCK ; FORD TRUCK F600, FT600, F700, FT700, F750, F800, F8000, FT800, L800, LA800, LN800, L8000, LN8000	ES2090L	AUTOCAR ; AUTOCAR CK64, CK64ST, DC42, K42, KM42, KS42, DC64, DK64, K64, KL64, KM64, KS64, KMS64F, DC87T, DC9364, DC9964, DC10364; BLUE BIRD Express Commuter Coach; BROCKWAY ; BROCKWAY SERIES 358, 359, 360, 361, 527, SERIES 450, 450C, 550, 550C, 700, 700C; CHEVROLET TRUCK ; CHEVROLET TRUCK Bison, Bruin, C70, C7D, Kodiak, J70, J90, M90, T5500, T6500, T7500, T8500, Titan; DANA/SPICER AXLE ; DANA/SPICER AXLE I100W, I120W, I140W; EATON ; EATON E-1000I, E-1200I, E-1320I, E-1460I, E1320W, E1322W, E1460W, EFA-12F3, EFA-13F3, EFA-12F4, EFA-13F5, EFA-18F3, EFA-20F4, EFA-22T2, EFA-22T5, EFA-24T2, EFA-24T5; FREIGHTLINER ; FREIGHTLINER COLUMBIA, FLB, FLL Series Cab-Over-Engine, FLC112SD Severe-Duty, FLD 112SD, FLD 120SD Conventional cab, Severe Duty, FLD 120 Conventional Cab, Long, Aluminun, FLD 132 Classic XL, Conventional Cab, M2 112, CONVENTIONAL, OTHER MODELS Conventional and Cab-O; GMC TRUCK ; GMC TRUCK Astro, D9K, D9L, Brigadier, J8C, J9C, C7500, C7D, Topkick, D9500, General, N9E, N9F, J7500, J9500, M9500; ISUZU ; ISUZU FTR, FVR, FXR, HTR, HVR, NPR; KENWORTH ; KENWORTH C500 Conventional, C500B Conventional Cab, K100 (set forward axle), K100E(Set Back Axle), Cab-Over-Engine From 1986, K100 Cab-Over-Engine (To 1986), L700 Cab Forward, T450A, T450B Conventional Cab, T800, T800B, Conventional Cab, W900, W900B, W900L, W900S; MACK ; MACK DM400, DM600, DM606S, DM607S, DM685S, DM685T, DM800, DMM600, RD700, MB400, MB600, MC400, MC600, MR400, MR600, R400, R600, R685R, R685ST, R686ST, R600L, R600LS, R700L, R700LS, RWL700S, RWS700S, WL700L WL700LS, WS700L, WS700LS, RD400, RD600, R700; MARMON Conventional, COE; NAVISTAR/IHC TRUCK ; NAVISTAR/IHC TRUCK 2554, 2574, 2654, 2674 Series (Built 1989 & Later), 3700, 3800, 3900 Series, 4600, 4700, 4800, 4900 Series, 7100 Series, 8100, 8200, 8300 Series (Built 1989 & Later), 9200 Series, 9300, 9400 Series, 9600, 9700 Series, Cargostar Models CO1610, CO1630, CO17; PETERBILT ; PETERBILT 252, 282, 289, 300, 348, 352, 352H, 353, 359, 310, 320, 330, 357, 362, 372, 375, 376, 377, 378, 379, 385, 387; ROCKWELL ; ROCKWELL FH945, FH946, FL931, FL933, FL941, FL943, FL951, MFS SERIES; STERLING TRUCK ; STERLING TRUCK A, L, S, Series, Acterra; VOLVO/WHITE/GMC ; VOLVO/WHITE/GMC AC Series, ACL Series, WG Series, XPEDITOR; WESTERN STAR 3842S, 3864S, 4842, 4864, 4942, 4964, 5842SS, 5864SS, 5942SS, 5964SS, 6964F, 6964S, 6969RL; WHITE TRUCK ; WHITE TRUCK RB2-42T, 4842, 4864, 4942, 4964, RB2-64T, RC2-42T, RC2-64T, RX2-42T, RX2-64T, WFC-12042T, WFC-12064, WFC-12064T, WFP-6342T, WFP-6364, WFP-6364T, WFP-7564T, WFT-6342T, WFT-6364, WFT-6364T, WFT-7564T, WFT-8164T, WFT-9664T
ES2036R	FORD TRUCK ; FORD TRUCK B600, B6000, B700, B7000, B7000, C600, CT600, C700, CT700, C750, C7000, C800, C8000, CT8000, C900, CT900, C9000, CF600, CF700, CF800, CFT800, CT800, F600, FT600, F700, FT700, F800, F8000, FT800, F900, FT900, L800, LA800, L900, LA900, LL900, LN900, L9000,		
ES2040R	DODGE TRUCK ; DODGE TRUCK C800, C900		
ES2061L	CHEVROLET TRUCK ; CHEVROLET TRUCK B60, B6P, Bruin, C50, C5D, Kodiak, C60, C6D, Kodiak, C70, C7D, Kodiak, H70, H80, J70, M60, P40, P60, S60, T60, T70, W60, W6N, W70, W7N; FORD TRUCK ; FORD TRUCK B600, B6000, B700, B7000, B7000, F600, FT600, F700, FT700, F800, F8000, FT800, F900, FT900, L800, LA800, L900, LA900, LL900, LN900, L9000, LN9000; GMC TRUCK ; GMC TRUCK B6000, B6P, Brigadier, J8C, J9C, C5000, C5D, Topkick, C5500, C6000, C6D, Topkick, C7500, C7D, Topkick, H7500, J7500, M6000, P4500, P6000, S6000, T6000, T7500, W7500		
ES2061R	FORD TRUCK B7000		
ES2062R	CHEVROLET TRUCK ; CHEVROLET TRUCK B60, B6P, Bruin, C50, C5D, Kodiak, C60, C6D, Kodiak, C70, C7D, Kodiak, H70, H80, J70, M60, P40, P60, S60, T60, T70, W60, W6N, W70, W7N; FORD TRUCK ; FORD TRUCK B600, B6000, B700, B7000, F600, FT600, F700, FT700, F800, F8000, FT800, F900, FT900, L800, LA800, L900, LA900, LL900, LN900, L9000, LN9000; GMC TRUCK ; GMC TRUCK B6000, B6P, Brigadier, J8C, J9C, C5000, C5D, Topkick, C5500, C6000, C6D, Topkick, C7500, C7D, Topkick, H7500, J7500, M6000, P4500, P6000, S6000, T6000, T7500, W7500		
ES2082R	DIVCO UMB8, UML8, 11, 12, 13, 14, 15, 21, 22, 31, 33, 34, 36, 37; DODGE TRUCK ; DODGE TRUCK C500, C600, D400, D500, D600, D700, DC700, DL400, P400, PL400, L600, M400, R400, M500, R500, M600, PC500, PD500, PC600, PD600, S500, S600, S700; FORD TRUCK ; FORD TRUCK B600, B6000, B700, B7000, C550, C600, CT600, F600, FT600, F700, FT700, N600, N6000, T800; ROCKWELL 32500, 33000 Series		
ES2083L			
		ES2090R	EATON E1460W

Numerical/Buyer's Guide

Heavy Duty Chassis Parts Numerical/Buyers Guide

Tie Rod Ends (Cont'd)		Part Number	Application
ES2091R	AUTOCAR ; AUTOCAR CK64, CK64ST, DC42, K42, KM42, KS42, DC64, DK64, K64, KL64, KM64, KS64, KMS64F, DC87T, DC9364, DC9964, DC10364; BLUE BIRD Express Commuter Coach; BROCKWAY ; BROCKWAY SERIES 358, 359, 360, 361, 527, SERIES 450, 450C, 550, 550C, 700, 700C; CHEVROLET TRUCK ; CHEVROLET TRUCK Bison, Bruin, C70, C7D, Kodiak, J70, J90, M90, T5500, T6500, T7500, T8500, Titan; DANA/SPICER AXLE ; DANA/SPICER AXLE I100W, I120W, I140W; EATON ; EATON E-1000I, E-1200I, E-1320I, E-1460I, E1320W, E1322W, E1460W, EFA-12F3, EFA-13F3, EFA-12F4, EFA-13F5, EFA-18F3,EFA-20F4,EFA-22T2,EFA-22T5,EFA-24T2,EFA-24T5; FREIGHTLINER ; FREIGHTLINER COLUMBIA, FLB, FLL Series Cab-Over-Engine, FLC112SD Severe-Duty, FLD 112SD, FLD 120SD Conventional cab, Severe Duty, FLD 120 Conventional Cab, Long, Aluminun, FLD 132 Classic XL,Conventional Cab, M2 112, CONVENTIONAL, OTHER MODELS Conventional and Cab-O; GMC TRUCK ; GMC TRUCK Astro, D9K, D9L, Brigadier, J8C, J9C, C7500, C7D, Topkick, D9500, General, N9E, N9F, J7500, J9500, M9500; ISUZU ; ISUZU FTR, FVR, FXR, HTR, HVR, NPR; KENWORTH ; KENWORTH C500 Conventional, C500B Conventional Cab, K100 (set forward axle), K100E(Set Back Axle), Cab-Over-Engine From 1986, K100 Cab-Over-Engine (To 1986), L700 Cab Forward, T450A, T450B Conventional Cab, T800,T800B, Conventional Cab, W900, W900B, W900L,W900S; MACK ; MACK DM400, DM600, DM606S, DM607S, DM685S, DM685T, DM800, DMM600, RD700, MB400, MB600, MC400, MC600, MR400, MR600, R400, R600, R685R, R685ST, R686ST, R600L, R600LS, R700L, R700LS, RWL700S, RWS700S, WL700L WL700LS, WS700L, WS700LS, RD400, RD600, R700; MARMON Conventional, COE; NAVISTAR/IHC TRUCK ; NAVISTAR/IHC TRUCK 2554, 2574, 2654, 2674 Series (Built 1989 & Later), 3700, 3800, 3900 Series, 4600, 4700, 4800, 4900 Series, 7100 Series, 8100, 8200, 8300 Series (Built 1989 & Later), 9200 Series, 9300, 9400 Series, 9600, 9700 Series, Cargostar Models CO1610, CO1630, CO17; PETERBILT ; PETERBILT 252, 282, 289, 300, 348, 352, 352H, 353, 359, 310, 320, 330, 357, 362, 372, 375, 376, 377, 378, 379, 385, 387; ROCKWELL ; ROCKWELL FH945, FH946, FL931, FL933, FL941, FL943, FL951, MFS SERIES; STERLING TRUCK ; STERLING TRUCK A, L, S, Series, Acterra; VOLVO/WHITE/GMC ; VOLVO/WHITE/GMC AC Series, ACL Series, WG Series, XPEDITOR; WESTERN STAR 3842S, 3864S, 4842, 4864, 4942, 4964, 5842SS, 5864SS, 5942SS, 5964SS, 6964F, 6964S, 6969RL; WHITE TRUCK ; WHITE TRUCK RB2-42T, 4842, 4864, 4942, 4964, RB2-64T, RC2-42T, RC2-64T, RX2-42T, RX2-64T, WFC-12042T, WFC-12064, WFC-12064T, WFP-6342T, WFP-6364, WFP-6364T, WFP-7564T, WFT-6342T, WFT-6364, WFT-6364T, WFT-7564T, WFT-8164T, WFT-9664T	ES2200L	AUTOCAR A42, S42, A64, S64; BROCKWAY ; BROCKWAY SERIES 358, 359, 360, 361, 527, SERIES 450, 450C, 550, 550C, 700, 700C; CHEVROLET TRUCK Titan; FREIGHTLINER OTHER MODELS Conventional and Cab-Over-Engine; GMC TRUCK Astro, D9K, D9L; KENWORTH ; KENWORTH C500 Conventional, K100 Cab-Over-Engine (To 1986), L700 Cab Forward, W900, W900B, W900L,W900S; MARMON Conventional, COE; NAVISTAR/IHC TRUCK ; NAVISTAR/IHC TRUCK 9300, 9400 Series, 9600, 9700 Series, CO4000, COF4000, COT4000, CO9670, COF9670, Eagle, Fleetstar Models 1900, F1900, T1900, 1910A, F1900A, 1950, F1950, T1950, 2000, F2000, T2000, 2010A, F2010A, 2050A, F2050A, 2070A, F2070A, 2110A, Transtar Models 4200, F; PETERBILT ; PETERBILT 252, 282, 289, 300, 348, 352, 352H, 353, 359, 310, 320, 330, 357, 362, 372, 375, 376, 377, 378, 379, 385, 387; ROCKWELL ; ROCKWELL FE970, FF971; WHITE TRUCK ; WHITE TRUCK WFC-12042T, WFC-12064, WFC-12064T, WFP-6342T, WFP-6364, WFP-6364T, WFP-7564T, WFT-6342T, WFT-6364, WFT-6364T, WFT-7564T, WFT-8164T, WFT-9664T
		ES2201R	
		ES2207R	ROCKWELL FDS1807FWD,FDS1805FWD
		ES2208R	NAVISTAR/IHC TRUCK ; NAVISTAR/IHC TRUCK COF5870, Paystar Models 5010, 5050, 5070, F5010, F5050, F5070, F5050SF, F5070SF, F5050SF-LW, F5070SF-LW, CO5370, COF5370; ROCKWELL FDS SERIES; WHITE TRUCK FDS1807(FWD), FDS1805(FWD)
			NAVISTAR/IHC TRUCK Paystar Models 5010, 5050, 5070, F5010, F5050, F5070, F5050SF, F5070SF, F5050SF-LW, F5070SF-LW, CO5370, COF5370; ROCKWELL FDS1807FWD,FDS1805FWD
		ES2209R	KENWORTH ; KENWORTH C500 Conventional, K100 Cab-Over-Engine (To 1986), W900, W900B, W900L,W900S
		ES2210L	KENWORTH ; KENWORTH C500 Conventional, K100 Cab-Over-Engine (To 1986)
		ES2257R	MACK ; MACK DM400, DM600, DM606S, DM607S, DM685S, DM685T, DMM600, RD700, MB400, MB600, R600, R685R, R685ST, R686ST, RD600, R700, U600, U68ST, F700, F786ST, R767ST
		ES235L	CLARK AXLE F-553; NAVISTAR/IHC TRUCK ; NAVISTAR/IHC TRUCK Cargostar Models CO1610, CO1630, CO1710, CO1730, CO1750, CO1810, COF1810, CO1830, CO1850, CO1910, COF1910, CO1950, COF1950, Fleetstar Models 1900, F1900, T1900, 1910A, F1900A, 1950, F1950, T1950, 2000, F2000, T2000, 2010A, F2010A, 2050A, F2050A, 2070A, F2
		ES235R	
		ES2556L	MITSUBISHI Fuso FE434
		ES2557R	
		ES2613L	DANA/SPICER AXLE ; DANA/SPICER AXLE I108, I120, I132, I90; NAVISTAR/IHC TRUCK ; NAVISTAR/IHC TRUCK 9600, 9700 Series, CO9670, COF9670, Eagle, COF5870, S Series Heavy Duty Models 2275, F2275, 2276, F2276, 2375, F2375, 2524, F2524, 2554, F2554, 2574, F2574, 2575, F2575, 2624, F2624, F2654, 2674, F2674, 2675, F2675, S Series Medium Duty Models 1624, 1654,
		ES2614R	
		ES262L	ROCKWELL FAE951
		ES262R	
		ES26L	NAVISTAR/IHC TRUCK Loadstar & School Bus Models 1600, 1700, 1750, 1800, 1850, 1890, F1600, F1700, F1800, F1850, CO1600, CO1700, CO1750, CO1800, CO1850

Heavy Duty Chassis Parts Numerical/Buyers Guide

		Part Number	Application
Tie Rod Ends (Cont'd)		Tie Rod Ends (Cont'd)	
ES26L	CHEVROLET TRUCK ; CHEVROLET TRUCK N,P (First Series), N,P (Second Series),4A,4B, QJ,QK,RJ,RK,SJ,SK,TJ,TK, Y,M,O,P Series except Heavy Duty,COE& School Bus	ES3031L	AUTOCAR ; AUTOCAR CK64, CK64ST, DC42, K42, KM42, KS42, DC64, DK64, K64, KL64, KM64, KS64, KMS64F, DC87T, DC9364, DC9964, DC10364; BLUE BIRD ; BLUE BIRD Express Commuter Coach, Wander Lodge 450LXI, Xcel 102; BROCKWAY ; BROCKWAY SERIES 358, 359, 360, 361, 527, SERIES 450, 450C, 550, 550C, 700, 700C; CHEVROLET TRUCK ; CHEVROLET TRUCK Bison, Bruin, J70, M90, Titan; DANA/SPICER AXLE ; FREIGHTLINER ; FREIGHTLINER FLB, FLL Series Cab-Over-Engine, FLC112SD Severe-Duty, FLD 112SD, FLD 120SD Conventional cab, Severe Duty, FLD 120 Conventional Cab, Long, Aluminun, FLD 132 Classic XL,Conventional Cab, OTHER MODELS Conventional and Cab-Over-Engine; GMC TRUCK ; GMC TRUCK Astro, D9K, D9L, Brigadier, J8C, J9C, General, N9E, N9F, J7500, M9500; KENWORTH ; KENWORTH C500 Conventional, C500B Conventional Cab, K100 (set forward axle), K100E(Set Back Axle), Cab-Over-Engine From 1986, K100 Cab-Over-Engine (To 1986), L700 Cab Forward, T450A, T450B Conventional Cab, T800,T800B, Conventional Cab, W900, W900B, W900L,W900S; MACK R600L, R600LS, R700L, R700LS, RWL700S, RWS700S, WL700L WL700LS, WS700L, WS700LS; MARMON Conventional, COE; NAVISTAR/IHC TRUCK ; NAVISTAR/IHC TRUCK 2554, 2574, 2654, 2674 Series (Built 1989 & Later), 4600, 4700, 4800, 4900 Series, 8100, 8200, 8300 Series (Built 1989 & Later), 9200 Series, 9300, 9400 Series, 9600, 9700 Series, Cargostar Models CO1610, CO1630, CO1710, CO1730, C; PETERBILT ; PETERBILT 252, 282, 289, 300, 348, 352, 352H, 353, 359, 310, 320, 330, 357, 362, 372, 375, 376, 377, 378, 379, 385, 387; ROCKWELL ; ROCKWELL FL931, FL933, FL941, FL943; STERLING TRUCK ; STERLING TRUCK A, L, S, Series, Acterra; VOLVO/WHITE/GMC ; VOLVO/WHITE/GMC AC Series, ACL Series, WG Series, XPEDITOR; WESTERN STAR 3842S, 3864S, 4842, 4864, 4942, 4964, 5842SS, 5864SS, 5942SS, 5964SS, 6964F, 6964S, 6969RL; WHITE TRUCK ; WHITE TRUCK RB2-42T, 4842, 4864, 4942, 4964, RB2-64T, RC2-42T, RC2-64T, RX2-42T, RX2-64T, WFC-12042T, WFC-12064, WFC-12064T, WFP-6342T, WFP-6364, WFP-6364T, WFP-7564T, WFT-6342T, WFT-6364, WFT-6364T, WFT-7564T, WFT-8164T, WFT-9664T
ES26R	NAVISTAR/IHC TRUCK Loadstar & School Bus Models 1600, 1700, 1750, 1800, 1850, 1890, F1600, F1700, F1800, F1850, CO1600, CO1700, CO1750, CO1800, CO1850	ES3031R	ROCKWELL MFS SERIES
ES3026L	CHEVROLET TRUCK ; CHEVROLET TRUCK B60, B6P, C50, C5D, Kodiak, C60, C6D, Kodiak, C70, C7D, Kodiak, P60; GMC TRUCK ; GMC TRUCK B6000, B6P, C5000, C5D, Topkick, C6000, C6D, Topkick, C7500, C7D, Topkick, P6000	ES3032R	NAVISTAR/IHC TRUCK ; NAVISTAR/IHC TRUCK COF5870, Paystar Models 5010, 5050, 5070, F5010, F5050, F5070, F5050SF, F5070SF, F5050SF-LW, F5070SF-LW, CO5370, COF5370
ES3027R		ES3039L	ROCKWELL FDS SERIES
ES3030R	NAVISTAR/IHC TRUCK ; NAVISTAR/IHC TRUCK 2554, 2574, 2654, 2674 Series (Built 1989 & Later), 4600, 4700, 4800, 4900 Series	ES3040R	FORD TRUCK ; FORD TRUCK B7000, F600, FT600, F700, FT700, F800, F8000, FT800, F900, FT900
	AUTOCAR ; AUTOCAR CK64, CK64ST, DC42, K42, KM42, KS42, DC64, DK64, K64, KL64, KM64, KS64, KMS64F, DC87T, DC9364, DC9964, DC10364; BLUE BIRD ; BLUE BIRD Express Commuter Coach, Wander Lodge 450LXI, Xcel 102; BROCKWAY ; BROCKWAY SERIES 358, 359, 360, 361, 527, SERIES 450, 450C, 550, 550C, 700, 700C; CHEVROLET TRUCK ; CHEVROLET TRUCK Bison, Bruin, J70, M90, Titan; DANA/SPICER AXLE ; FREIGHTLINER ; FREIGHTLINER FLB, FLL Series Cab-Over-Engine, FLC112SD Severe-Duty, FLD 112SD, FLD 120SD Conventional cab, Severe Duty, FLD 120 Conventional Cab, Long, Aluminun, FLD 132 Classic XL,Conventional Cab, OTHER MODELS Conventional and Cab-Over-Engine; GMC TRUCK ; GMC TRUCK Astro, D9K, D9L, Brigadier, J8C, J9C, General, N9E, N9F, J7500, M9500; KENWORTH ; KENWORTH C500 Conventional, C500B Conventional Cab, K100 (set forward axle), K100E(Set Back Axle), Cab-Over-Engine From 1986, K100 Cab-Over-Engine (To 1986), L700 Cab Forward, T450A, T450B Conventional Cab, T800,T800B, Conventional Cab, W900, W900B, W900L,W900S; MACK R600L, R600LS, R700L, R700LS, RWL700S, RWS700S, WL700L WL700LS, WS700L, WS700LS; MARMON Conventional, COE; NAVISTAR/IHC TRUCK ; NAVISTAR/IHC TRUCK 2554, 2574, 2654, 2674 Series (Built 1989 & Later), 3700, 3800, 3900 Series, 4600, 4700, 4800, 4900 Series, 8100, 8200, 8300 Series (Built 1989 & Later), 9200 Series, 9300, 9400 Series, 9600, 9700 Series, Cargostar Models CO1610, CO1630, CO1710, CO1730, C; PETERBILT ; PETERBILT 252, 282, 289, 300, 348, 352, 352H, 353, 359, 310, 320, 330, 357, 362, 372, 375, 376, 377, 378, 379, 385, 387; ROCKWELL ; ROCKWELL FL931, FL933, FL941, FL943; STERLING TRUCK ; STERLING TRUCK A, L, S, Series, Acterra; VOLVO/WHITE/GMC ; VOLVO/WHITE/GMC AC Series, ACL Series, WG Series, XPEDITOR; WESTERN STAR 3842S, 3864S, 4842, 4864, 4942, 4964, 5842SS, 5864SS, 5942SS, 5964SS, 6964F, 6964S, 6969RL; WHITE TRUCK ; WHITE TRUCK RB2-42T, 4842, 4864, 4942, 4964, RB2-64T, RC2-42T, RC2-64T, RX2-42T, RX2-64T, WFC-12042T, WFC-12064, WFC-12064T, WFP-6342T, WFP-6364, WFP-6364T, WFP-7564T, WFT-6342T, WFT-6364, WFT-6364T, WFT-7564T, WFT-8164T, WFT-9664T	ES3040L	DODGE TRUCK ; DODGE TRUCK ALL (Except W500 4 WD), C1000, C500, C600, C700, C800, C850, C900, CT700, CT800, D500, D600, D700, D800, DC700, L600, L700, PC500, PD500, PC600, PD600, S500, S600; FORD TRUCK ; FORD TRUCK B600, B6000, C500, C550, C600, CT600, C700, CT700, C750, C7000, C800, F600, FT600, F700, FT700, F750, F800, F8000, FT800, F850, F950, N600, N6000, N8000, N850, N950, T800; ROCKWELL ; ROCKWELL FC901, FC902, FC903, FC921, FDS SERIES, RF SERIES; THOMAS BUILT Saf-T-Liner C2

Numerical/Buyer's Guide

Heavy Duty Chassis Parts Numerical/Buyers Guide

	Part Number		Application
Tie Rod Ends (Cont'd)	Tie Rod Ends (Cont'd)		
ES304R DODGE TRUCK ; DODGE TRUCK ALL (Except W500 4 WD), C1000, C500, C600, C700, C800, C850, C900, CT700, CT800, D500, D600, D700, D800, DC700, L600, L700, PC500, PD500, PC600, PD600, S500, S600; FORD TRUCK ; FORD TRUCK B600, B6000, C500, C550, C600, CT600, C700, CT700, C750, C7000, C800, F600, FT600, F700, FT700, F750, F800, F8000, FT800, F850, F950, N600, N6000, N8000, N850, N950, T800; ROCKWELL ; ROCKWELL FC901, FC902, FC903, FC921; THOMAS BUILT Saf-T-Liner C2	ES3268L	CHEVROLET TRUCK ; CHEVROLET TRUCK B7T, C50, C5D, Kodiak, C60, C6D, Kodiak, C70, C7D, Kodiak, P60, P6S; GMC TRUCK ; GMC TRUCK B7T, C5000, C5D, Topkick, C6000, C6D, Topkick, C7500, C7D, Topkick, P6000, P6S	
ES3086L NAVISTAR/IHC TRUCK ; NAVISTAR/IHC TRUCK 9300, 9400 Series, S Series Medium Duty Models 1624, 1654, 1658, 1723, 1724, 1753, 1754, 1758, 1823, 1824, 1853, 1854, 1858, 1924, F1924, 1925, 1954, F1954, 1955, 1958, 2125, F2125, 2155	ES3269R		
ES3087R	ES3270L	CHEVROLET TRUCK ; CHEVROLET TRUCK B7T, C50, C5D, Kodiak, C60, C6D, Kodiak, C70, C7D, Kodiak, P60, P6S, T5500, T6500, T7500, T8500; GMC TRUCK ; GMC TRUCK B7T, C5000, C5D, Topkick, C6000, C6D, Topkick, C7500, C7D, Topkick, P6000, P6S; ISUZU ; ISUZU FSR, FTR, FVR	
ES3176R FORD TRUCK L800, LA800	ES3271R		
FORD TRUCK ; FORD TRUCK Aeromax Series, A85, AT85, A95, AT95, B7000, CF600, CF700, CF800, CFT800, F600, F600, FT600, F700, F700, FT700, F800, F800, F8000, FT800, F900, FT900, L800, LA800, L900, LA900, LL900, LN900, L9000, LN9000, LLA900, LLS900, LTLA900, LTLS900, LN800, L8000, L	ES3274L	CHEVROLET TRUCK ; CHEVROLET TRUCK B7T, C70, C7D, Kodiak, P60, P6S, T5500, T6500, T7500, T8500; GMC TRUCK ; GMC TRUCK B7T, C7500, C7D, Topkick, P6000, P6S; ISUZU ; ISUZU FSR, FTR, FVR	
ES3177L	ES3275R		
ES3204L DANA/SPICER AXLE ; DANA/SPICER AXLE 02ADA, 02ADB; THOMAS BUILT Type C Saf-T-Liner Vista	ES3283R	FORD TRUCK ; FORD TRUCK Aeromax Series, A85, AT85, A95, AT95, B7000, C600, C700, C800, C900, C9000, CF600, CF700, CF800, CFT800, CT900, F600, F700, F700, FT700, F800, F8000, FT800, F900, FT900, L800, LA800, L900, LA900, LL900, LN900, LLA900, LLS900, LTLA900, LTLS9	
DANA/SPICER AXLE ; DANA/SPICER AXLE I60S, I80S; NAVISTAR/IHC TRUCK ; NAVISTAR/IHC TRUCK 3700, 3800, 3900 Series, 4600, 4700, 4800, 4900 Series, 7100 Series, M1400, M1600, 1452, 1652 Series Medium Duty	ES3284L		
ES3205R	ES3294L	NAVISTAR/IHC TRUCK S Series Medium Duty Models 1624, 1654, 1658, 1723, 1724, 1753, 1754, 1758, 1823, 1824, 1853, 1854, 1858, 1924, F1924, 1925, 1954, F1954, 1955, 1958, 2125, F2125, 2155	
DANA/SPICER AXLE ; DANA/SPICER AXLE 02ADA, 02ADB; THOMAS BUILT Type C Saf-T-Liner Vista	ES3297R	BLUE BIRD ; BLUE BIRD All American, Airtek Suspension, All American, Softek Suspension; EATON EFA-12F3, EFA-13F3, EFA-12F4, EFA-13F5, EFA-18F3, EFA-20F4, EFA-22T2, EFA-22T5, EFA-24T2, EFA-24T5; FREIGHTLINER FLD 120 Conventional Cab, Long, Aluminum; HENDRICKSON AIRTEK 5.36" Beam Drop; KENWORTH ; KENWORTH C500B Conventional Cab, K100 (set forward axle), K100E(Set Back Axle), Cab-Over-Engine From 1986, K300 Cab-Over-engine, T400A, T400B Conventional Cab, T450A, T450B Conventional Cab, T600A, T600B Conventional Cab, T800, T800B, Conventional Cab, W900, W900; NAVISTAR/IHC TRUCK ; NAVISTAR/IHC TRUCK 9200 Series, 9300, 9400 Series, 9600, 9700 Series; PETERBILT 310, 320, 330, 357, 362, 372, 375, 376, 377, 378, 379, 385, 387; VOLVO/WHITE/GMC ; VOLVO/WHITE/GMC AERO Series, AUTOHAULER TRACTORS, WG Series, WHR, WIL, WIA Series; WESTERN STAR 3842S, 3864S, 4842, 4864, 4942, 4964, 5842SS, 5864SS, 5942SS, 5964SS, 6964F, 6964S, 6969RL	
NAVISTAR/IHC TRUCK S Series Medium Duty Models 1624, 1654, 1658, 1723, 1724, 1753, 1754, 1758, 1823, 1824, 1853, 1854, 1858, 1924, F1924, 1925, 1954, F1954, 1955, 1958, 2125, F2125, 2155	ES3298L		
ES3217L DANA/SPICER AXLE ; DANA/SPICER AXLE I140S, I140SA, I146SA; NAVISTAR/IHC TRUCK ; NAVISTAR/IHC TRUCK 2554, 2574, 2654, 2674 Series (Built 1989 & Later), 3700, 3800, 3900 Series, 4600, 4700, 4800, 4900 Series, 7100 Series, 8100, 8200, 8300 Series (Built 1989 & Later), 9200 Series, 9300, 9400 Series, M1400, M1600, 1452, 1652 Series Medium Duty	ES330L	CHEVROLET TRUCK ; CHEVROLET TRUCK C40, C50, C5D, Kodiak, C60, C6D, Kodiak, C80, E80, L80, M80, U80, D50, D60, L50, L60, M50, M60, P50, Q60, V60, X60, S50, Q50, S60, T50; GMC TRUCK ; GMC TRUCK C4500, C5000, C5D, Topkick, C5500, C6000, C6D, Topkick, E4500, E5500, H5500, S5500, S6000	
ES3218R	ES330R		
ES3219L DANA/SPICER AXLE ; DANA/SPICER AXLE I140S, I140SA, I146SA; NAVISTAR/IHC TRUCK ; NAVISTAR/IHC TRUCK 2554, 2574, 2654, 2674 Series (Built 1989 & Later), 3700, 3800, 3900 Series, 4600, 4700, 4800, 4900 Series, 7100 Series, 8100, 8200, 8300 Series (Built 1989 & Later), 9200 Series, 9300, 9400 Series, 9600, 9700 Series, 9800 Series, M1400, M1600, 1452, 1652			
ES3220R			
ES323L FORD TRUCK W900, WT900, W9000, WT9000			
ES323R			
ES325L CHEVROLET TRUCK ; CHEVROLET TRUCK A60, A80, N80, Q80, V80, C80, E80, L80, M80, U80, D60, H70, J70, L50, L60, M60, N60, Y60, T50, T60, T70, T80, W70, W7N, W80; GMC TRUCK ; GMC TRUCK C6500, C9500, D9500, F9500, H7500, H8500, H9500, J7500, J8500, J9500, M6500, M9500, T7500, T8500, T9500, W7500, W8500, W9500; KENWORTH ; KENWORTH L700 Cab Forward, W900; ROCKWELL 27460-A, 27465-A			
ES325R			

Heavy Duty Chassis Parts Numerical/Buyers Guide

	Part Number		Application
Tie Rod Ends (Cont'd)	Tie Rod Ends (Cont'd)		
ES3312R	AUTOCAR A42, S42, A64, S64; BLUE BIRD SCHOOL BUS - Various Thread; BROCKWAY ; BROCKWAY SERIES 358, 359, 360, 361, 527, SERIES 450, 450C, 550, 550C, 700, 700C; CHEVROLET TRUCK ; CHEVROLET TRUCK Bison, Bruin, Titan; FREIGHTLINER ; FREIGHTLINER C112, C120 Century Class, Conventional Cab, FL70, MB70, FL80, MB80, FL106 Business Class, Conventional Cab, FLA, FLP, FLT Series Cab-Over-Engine, FLB, FLL Series Cab-Over-Engine, FLC 112 Series, FLC112SD Severe-Duty, FLD 112 Conventional Cab, Medium, A; GMC TRUCK ; GMC TRUCK Astro, D9K, D9L, Brigadier, J8C, J9C, General, N9E, N9F; KENWORTH ; KENWORTH C500 Conventional, C500B Conventional Cab, K100 (set forward axle), K100E(Set Back Axle), Cab-Over-Engine From 1986, K100 Cab-Over-Engine (To 1986), L700 Cab Forward, T400A, T400B Conventional Cab, T450A, T450B Conventional Cab, T600A, T600B Conventional; MACK R600L, R600LS, R700L, R700LS, RWL700S, RWS700S, WL700L WL700LS, WS700L, WS700LS; MARMON Conventional, COE; NAVISTAR/IHC TRUCK ; NAVISTAR/IHC TRUCK 2554, 2574, 2654, 2674 Series (Built 1989 & Later), 8100, 8200, 8300 Series (Built 1989 & Later), 9200 Series, 9300, 9400 Series, 9600, 9700 Series, 9800 Series, CO9670, COF9670, Eagle, D400, DC400, DCF400, DCF400M, DF400, D405, DC405, DCF405, DCT405, DF4; PETERBILT ; PETERBILT 252, 282, 289, 300, 348, 352, 352H, 353, 359, 310, 320, 330, 357, 362, 372, 375, 376, 377, 378, 379, 385, 387; ROCKWELL ; ROCKWELL 16930, 16931, FD931, FD933, FD961, FF961, FF921, FF923, FF931, FF931A, FF941A, FF932, FF933, FF934, FF941, FF942, FF943, FF944, FG931, FG933, FG941, FG943; THOMAS BUILT SCHOOL BUS; VOLVO/WHITE/GMC ; VOLVO/WHITE/GMC AC Series, ACL Series, AERO Series, AUTOHAULER TRACTORS, WG Series, WHR, WIL, WIA Series, XPEDITOR; WESTERN STAR 3842S, 3864S, 4842, 4864, 4942, 4964, 5842SS, 5864SS, 5942SS, 5964SS, 6964F, 6964S, 6969RL; WHITE TRUCK ; WHITE TRUCK RB2-42T, 4842, 4864, 4942, 4964, RB2-64T, RBW-42T, RBW-64T, RC2-42T, RC2-64T, RCW-42T, WSH-42T, WSH-64T, RCW-64T, RX2-42T, RX2-64T, WFC-12042T, WFC-12064, WFC-12064T, WFP-6342T, WFP-6364, WFP-6364T, WFP-7564T, WFT-6342T, WFT-6364, WFT-6364T, WFT-7564T, W	ES34442R	HENDRICKSON AIRTEK 4.25" Beam Drop
	ES346L	AUTOCAR A42, S42, A64, S64; BROCKWAY ; BROCKWAY SERIES 358, 359, 360, 361, 527, SERIES 450, 450C, 550, 550C, 700, 700C; FORD TRUCK ; FORD TRUCK C1100, C850, C950, C1000, CT800, CT850, CT950, F1000, F1100, F850, F950, HT950, H1000, N1100, N8000, N850, N950, NT850, N1000, NT950, T800, T850, T950, W1000, WT1000; FREIGHTLINER OTHER MODELS Conventional and Cab-Over-Engine; KENWORTH ; KENWORTH C500 Conventional, K100 Cab-Over-Engine (To 1986), L700 Cab Forward, W900, W900B, W900L, W900S; MARMON Conventional, COE; PETERBILT ; PETERBILT 252, 282, 289, 300, 348, 352, 352H, 353, 359, 310, 320, 330, 357, 362, 372, 375, 376, 377, 378, 379, 385, 387; ROCKWELL FF901, FF903; WHITE TRUCK ; WHITE TRUCK WFC-12042T, WFC-12064, WFC-12064T, WFP-6342T, WFP-6364, WFP-7564T, WFT-6342T, WFT-6364, WFT-6364T, WFT-7564T, WFT-8164T, WFT-9664T	
	ES346R	AUTOCAR A42, S42, A64, S64; BROCKWAY ; BROCKWAY SERIES 358, 359, 360, 361, 527, SERIES 450, 450C, 550, 550C, 700, 700C; FORD TRUCK ; FORD TRUCK C1100, C850, C950, C1000, CT800, CT850, CT950, F1000, F1100, F850, F950, HT950, H1000, N1100, N8000, N850, N950, NT850, N1000, NT950, T800, T850, T950, W1000, WT1000; FREIGHTLINER OTHER MODELS Conventional and Cab-Over-Engine; KENWORTH ; KENWORTH C500 Conventional, K100 Cab-Over-Engine (To 1986), L700 Cab Forward, W900, W900B, W900L, W900S; MARMON Conventional, COE; PETERBILT ; PETERBILT 252, 282, 289, 300, 348, 352, 352H, 353, 359, 310, 320, 330, 357, 362, 372, 375, 376, 377, 378, 379, 385, 387; ROCKWELL FDS SERIES, FF901, FF903; WHITE TRUCK ; WHITE TRUCK WFC-12042T, WFC-12064, WFC-12064T, WFP-6342T, WFP-6364, WFP-6364T, WFP-7564T, WFT-6342T, WFT-6364, WFT-6364T, WFT-7564T, WFT-8164T, WFT-9664T	
	ES3476	DANA/SPICER AXLE ; EATON ; EATON E-1000I, E-1200I, E-1320I, E-1460I, E1000W, E1200W, E1201W, E1202I, E1202W, E1203I, E1320W, E1322I; FORD TRUCK ; FORD TRUCK LCFC450, LCFC550; FREIGHTLINER ; FREIGHTLINER C112, C120 CENTURY CLASS, CONVENTIONAL CAB, FCCC, MOTORHOME, FLC 112 Series, FLD 112 Conventional Cab, Medium, Aluminum, FLD 112SD, FLD 120SD Conventional cab, Severe Duty, FLD 132 Classic XL, Conventional Cab; HENDRICKSON ; HENDRICKSON AIRTEK 4.25" Beam Drop, SOFTEK 5.36" BEAM DROP, STEERTEK 4.25" Beam Drop; KENWORTH ; KENWORTH C500B Conventional Cab, K100 (set forward axle), K100E(Set Back Axle), Cab-Over-Engine From 1986, K300 Cab-Over-engine, T2000, T400A, T400B Conventional Cab, T450A, T450B Conventional Cab, T600A, T600B Conventional Cab, T800, T800B, Conventional Cab; MACK CXN612; NAVISTAR/IHC TRUCK ; NAVISTAR/IHC TRUCK 7100 Series, 9200 Series, 9200I, 9400I, 9300, 9400 Series; PETERBILT 310, 320, 330, 357, 362, 372, 375, 376, 377, 378, 379, 385, 387; STERLING TRUCK A, L, S, Series; VOLVO/WHITE/GMC ; VOLVO/WHITE/GMC AUTOHAULER TRACTORS, VNL, VNM Series; WESTERN STAR 123FA, 123SA, 49132EX; WORKHORSE UFO, Motorhome	
ES3328R	ROCKWELL FC901, FC902, FC903		
ES3329L			
ES332L	CHEVROLET TRUCK ; CHEVROLET TRUCK A60, A80, N80, Q80, V80, C40, C50, C5D, Kodiak, C60, C6D, Kodiak, C65, C80, E80, L80, M80, U80, D60, H70, H80, J70, L50, L60, M50, M60, M65, N50, N60, Y60, Q60, V60, X60, S50, Q50, S60, T50, T60, T65, T70, T80, W80; GMC TRUCK ; GMC TRUCK C5500, C6000, C6D, Topkick, C6500, E5500, E6500, H5500, H7500, H8500, H9500, J7500, M6500, S5500, S6000, T5500, T6000, T6500, T7500		
ES332R			
ES3335R	GMC TRUCK W4; ISUZU NPR		
ES3336L			
ES3442R	FORD TRUCK ; FORD TRUCK Aeromax Series, A85, AT85, A95, AT95, CF700, CF800, CFT800, F600, F700, FT700, F800, F8000, FT800, F900, FT900, Louisville Series L85, Louisville Series, L85, LT85, L95, LT95; MACK CXN613; NAVISTAR/IHC TRUCK RE Series, Bus; VOLVO/WHITE/GMC VNL, VNM Series		
ES3443L	FORD TRUCK ; FORD TRUCK Aeromax Series, A85, AT85, A95, AT95, CF700, CF800, CFT800, F600, F700, FT700, F800, F8000, FT800, F900, FT900, Louisville Series L85, Louisville Series, L85, LT85, L95, LT95; HENDRICKSON AIRTEK 4.25" Beam Drop; MACK CXN613; NAVISTAR/IHC TRUCK RE Series, Bus; VOLVO/WHITE/GMC VNL, VNM Series	ES3477	

Numerical/Buyer's Guide

Heavy Duty Chassis Parts Numerical/Buyers Guide

	Part Number	Application
Tie Rod Ends (Cont'd)	Tie Rod Ends (Cont'd)	
<p>ES373L DANA/SPICER AXLE ; DANA/SPICER AXLE I50, I60, I75, I80; FORD TRUCK ; FORD TRUCK B500, F500, B600, B6000, B700, B7000, C500, C550, C600, CT600, C700, CT700, C750, C7000, C800, C8000, CT8000, C900, CT900, C9000, CT800, F600, FT600, F700, FT700, F750, F800, F8000, FT800, F900, FT900, L800, LA800, L900, LA900, LL900, LN900, L9000, LN9000; NAVISTAR/IHC TRUCK ; NAVISTAR/IHC TRUCK Cargostar Models CO1610, CO1630, CO1710, CO1730, CO1750, CO1810, COF1810, CO1830, CO1850, CO1910, COF1910, CO1950, COF1950, Fleetstar Models 1900, F1900, T1900, 1910A, F1900A, 1950, F1950, T1950, 2000, F2000, T2000, 2010A, F2010A, 2050A, F2050A, 2070A, F2</p>	<p>ES423L AUTOCAR ; AUTOCAR A42, S42, A64, S64, CK64, CK64ST, DC42, K42, KM42, KS42, DC64, DK64, K64, KL64, KM64, KS64, KMS64F, DC87T, DC9364, DC9964, DC10364; BLUE BIRD ; BLUE BIRD All American FE, SCHOOL BUS - Various Thread, Ultra FL, Wander Lodge 450LXI, Xcel 102; BROCKWAY ; BROCKWAY SERIES 358, 359, 360, 361, 527, SERIES 450, 450C, 550, 550C, 700, 700C; CHEVROLET TRUCK ; CHEVROLET TRUCK Bison, Bruin, S70, S7T, Titan; DANA/SPICER AXLE ; DODGE TRUCK ; DODGE TRUCK C800, C900, CN800, CNT800, CT800; EATON EFA-12F3, EFA-13F3, EFA-12F4, EFA-13F5, EFA-18F3, EFA-20F4, EFA-22T2, EFA-22T5, EFA-24T2, EFA-24T5; FORD TRUCK ; FORD TRUCK C600, CT600, C700, C700, CT700, C750, C7000, C800, C8000, CT8000, C900, C900, CT900, C9000, C9000, CF600, CF700, CF800, CFT800, CL900, CLT900, CL9000, CLT9000, CT800, CT900, F600, FT600, F700, FT700, F800, F8000, FT800, F900, FT900, L800, LA800, L900, LA9; FREIGHTLINER ; FREIGHTLINER C112, C120 CENTURY CLASS, CONVENTIONAL CAB, COLUMBIA, FL70, MB70, FL80, MB80, FL106 Business Class, Conventional Cab, FLA, FLP, FLT Series Cab-Over-Engine, FLB, FLL Series Cab-Over-Engine, FLC 112 Series, FLC112SD Severe-Duty, FLD 112 Conventional Cab.; GMC TRUCK ; GMC TRUCK Astro, D9K, D9L, Brigadier, J8C, J9C, General, N9E, N9F, H7500, H8500, H9500, J7500, J8500, J9500, M6000, M6500, M9500, P6000, R8500, S6000, S7500, S7T, T5500, T6000, T6500, T7500.; MACK ; MACK DM400, DM600, DM606S, DM607S, DM685S, DM685T, DMM600, RD700, MB400, MB600, R600, R685R, R685ST, R686ST, RD600, R700, U600, U68ST, F700, F786ST, R767ST</p>	
ES373R		
ES376L		
ES376R		
ES405L		
ES405R		
ES411L		
ES411R		
ES416L		
ES416R		
	ES423R	
		FORD TRUCK C800, C8000, CT8000

Heavy Duty Chassis Parts Numerical/Buyers Guide

	Part Number		Application
Tie Rod Ends (Cont'd)		Tie Rod Ends (Cont'd)	
ES423R	AUTOCAR ; AUTOCAR A42, S42, A64, S64, CK64, CK64ST, DC42, K42, KM42, KS42, DC64, DK64, K64, KL64, KM64, KS64, KMS64F, DC87T, DC9364, DC9964, DC10364; BLUE BIRD ; BLUE BIRD All American FE, SCHOOL BUS - Various Thread, Ultra FL, Wander Lodge 450LXI, Xcel 102; BROCKWAY ; BROCKWAY SERIES 358, 359, 360, 361, 527, SERIES 450, 450C, 550, 550C, 700, 700C; CHEVROLET TRUCK ; CHEVROLET TRUCK Bison, Bruin, S70, S7T, Titan; DANA/SPICER AXLE ; DODGE TRUCK ; DODGE TRUCK C800, C900, CN800, CNT800, CT800; EATON EFA-12F3, EFA-13F3, EFA-12F4, EFA-13F5, EFA-18F3, EFA-20F4, EFA-22T2, EFA-22T5, EFA-24T2, EFA-24T5; FORD TRUCK ; FORD TRUCK C600, CT600, C700, C700, CT700, C750, C7000, C800, C8000, CT8000, C900, C900, CT900, C9000, C9000, CF600, CF700, CF800, CFT800, CL900, CLT900, CL9000, CLT9000, CT800, CT900, F600, FT600, F700, FT700, F800, F8000, FT800, F900, FT900, L800, LA800, L900, LA9; FREIGHTLINER ; FREIGHTLINER C112, C120 CENTURY CLASS, CONVENTIONAL CAB, COLUMBIA, FL70, MB70, FL80, MB80, FL106 Business Class, Conventional Cab, FLA, FLP, FLT Series Cab-Over-Engine, FLB, FLL Series Cab-Over-Engine, FLC 112 Series, FLC112SD Severe-Duty, FLD 112 Conventional Cab.; GMC TRUCK ; GMC TRUCK Astro, D9K, D9L, Brigadier, J8C, J9C, General, N9E, N9F, S7500, S7T; HINO 238,268,268A,338; KENWORTH ; KENWORTH C500 Conventional, C500B Conventional Cab, K100 (set forward axle), K100E(Set Back Axle), Cab-Over-Engine From 1986, K100 Cab-Over-Engine (To 1986), K300 Cab-Over-engine, L700 Cab Forward, T400A, T400B Conventional Cab, T450A, T450B Conventional Cab, T6; MACK R600L, R600LS, R700L, R700LS, RWL700S, RWS700S, WL700L, WL700LS, WS700L, WS700LS; MARMON Conventional, COE; NAVISTAR/IHC TRUCK ; NAVISTAR/IHC TRUCK 2554, 2574, 2654, 2674 Series (Built 1989 & Later), 3700, 3800, 3900 Series, 4600, 4700, 4800, 4900 Series, 7100 Series, 8100, 8200, 8300 Series (Built 1989 & Later), 9100 Series Short conventional Cab, 9200 Series, 9300, 9400 Series, 9600, 9700 Series, 9; PETERBILT ; PETERBILT 252, 282, 289, 300, 348, 352, 352H, 353, 359, 310, 320, 330, 357, 362, 372, 375, 376, 377, 378, 379, 385, 387; ROCKWELL ; ROCKWELL 16930, 16931, FD931, FD933, FD961, FF961, FF921, FF923, FF930, FF931, FF931A, FF941A, FF932, FF933, FF934, FF941, FF942, FF943, FF944, FF981, FF982, FF983, FF986, FG931, FG933, FG941, FG943, MFS SERIES; STERLING TRUCK ; STERLING TRUCK A, L, S, Series, Acterra, SC7000, SC8000 CARGO, COE; THOMAS BUILT ; THOMAS BUILT ER Series, Saf-T-Liner, Saf-T-Liner & MVP, SCHOOL BUS; VOLVO/WHITE/GMC ; VOLVO/WHITE/GMC AC Series, ACL Series, AERO Series, AUTOHAULER TRACTORS, WG Series, WHR, WIL, WIA Series, XPEDITOR; WESTERN STAR 3842S, 3864S, 4842, 4864, 4942, 4964, 5842SS, 5864SS, 5942SS, 5964SS, 6964F, 6964S, 6969RL; WESTPORT AXLE F5W-0900; WHITE TRUCK ; WHITE TRUCK RB2-42T, 4842, 4864, 4942, 4964, RB2-64T, RBW-42T, RBW-64T, RC2-42T, RC2-64T, RCW-42T, WSH-42T, WSH-64T, RCW-64T, RX2-42T, RX2-64T, WFC-12042T, WFC-12064T, WFP-6342T, WFP-6364, WFP-6364T, WFP-7564T, WFT-6342T, WFT-6364, WFT-6364T, WFT-7564T, W	AUTOCAR ; AUTOCAR A42, S42, A64, S64, CK64, CK64ST, DC42, K42, KM42, KS42, DC64, DK64, K64, KL64, KM64, KS64, KMS64F, DC87T, DC9364, DC9964, DC10364; BLUE BIRD ; BLUE BIRD Express Commuter Coach, Wander Lodge 450LXI, Xcel 102; BROCKWAY ; BROCKWAY SERIES 358, 359, 360, 361, 527, SERIES 450, 450C, 550, 550C, 700, 700C; CHEVROLET TRUCK ; CHEVROLET TRUCK Bison, Bruin, D90, H70, J70, J80, J90, M90, Titan, W70, W7N; DANA/SPICER AXLE ; DODGE TRUCK ; DODGE TRUCK CN800, CNT800, CN900, CNT900, D1000; FORD TRUCK ; FORD TRUCK C600, C700, C800, C800, C8000, CT8000, C900, C900, CT900, C9000, C9000, CT800, CT850, CT950, CT900, L800, LA800, LN800, L8000, LN8000, LNT800, LNT900, LT900, LNT8000, LT8000, LNT9000, LT9000, LTS900, LS900, LTS9000, LS9000, W900, WT900, W9000, WT9000; FREIGHTLINER ; FREIGHTLINER FLB, FLL Series Cab-Over-Engine, FLC112SD Severe-Duty, FLD 112SD, FLD 120SD Conventional cab, Severe Duty, FLD 120 Conventional Cab, Long, Aluminum, FLD 132 Classic XL, Conventional Cab, OTHER MODELS Conventional and Cab-Over-Engine; GMC TRUCK ; GMC TRUCK Astro, D9K, D9L, Brigadier, J8C, J9C, D9500, General, N9E, N9F, J7500, J8500, J9500, M9500, W7500; KENWORTH ; KENWORTH C500 Conventional, C500B Conventional Cab, K100 (set forward axle), K100E(Set Back Axle), Cab-Over-Engine From 1986, K100 Cab-Over-Engine (To 1986), L700 Cab Forward, T450A, T450B Conventional Cab, T800, T800B, Conventional Cab, W900, W900B, W900L, W900S; MACK ; MACK B53, B57, DM400, DM600, DM606S, DM607S, DM685S, DM685T, DM800, DMM600, RD700, MB400, MB600, MC400, MC600, MR400, MR600, R400, R600, R685R, R685ST, R686ST, R600L, R600LS, R700L, R700LS, RWL700S, RWS700S, WL700L, WL700LS, WS700L, WS700LS, RD400, RD600, R700; MARMON Conventional, COE; NAVISTAR/IHC TRUCK ; NAVISTAR/IHC TRUCK 2554, 2574, 2654, 2674 Series (Built 1989 & Later), 3700, 3800, 3900 Series, 4600, 4700, 4800, 4900 Series, 8100, 8200, 8300 Series (Built 1989 & Later), 9200 Series, 9300, 9400 Series, 9600, 9700 Series, Cargostar Models CO1610, CO1630, CO1710, CO1730, C; PETERBILT ; PETERBILT 252, 282, 289, 300, 348, 352, 352H, 353, 359, 310, 320, 330, 357, 362, 372, 375, 376, 377, 378, 379, 385, 387; ROCKWELL ; ROCKWELL 16930, 16931, 17100, 17101, 17111, FE900, FE903, FE910, FE970, FF901, FF903, FF930, FH901, FL901, FL931, FL933, FL941, FL943; STERLING TRUCK A, L, S, Series; VOLVO/WHITE/GMC ; VOLVO/WHITE/GMC AC Series, ACL Series, WG Series, XPEDITOR; WESTERN STAR 3842S, 3864S, 4842, 4864, 4942, 4964, 5842SS, 5864SS, 5942SS, 5964SS, 6964F, 6964S, 6969RL; WESTPORT AXLE ; WESTPORT AXLE F3W-1200, F3W-1400, F3W-1600, F3W-1800, F6W-1200, F6W-1400, F6W-1600; WHITE TRUCK ; WHITE TRUCK RB2-42T, 4842, 4864, 4942, 4964, RB2-64T, RBW-42T, RBW-64T, RC2-42T, RC2-64T, RCW-42T, WSH-42T, WSH-64T, RCW-64T, RX2-42T, RX2-64T, WFC-12042T, WFC-12064, WFC-12064T, WFP-6342T, WFP-6364, WFP-6364T, WFP-7564T, WFT-6342T, WFT-6364, WFT-6364T, WFT-7564T, W	
ES431L	FABCO SDA12, SDA14, SDA16, SDA18, SDA21, SDA23; NAVISTAR/IHC TRUCK 4600, 4700, 4800, 4900 Series	ES431R	FABCO SDA12, SDA14, SDA16, SDA18, SDA21, SDA23; NAVISTAR/IHC TRUCK 4600, 4700, 4800, 4900 Series
		ES800420	BLUE BIRD ; BLUE BIRD Vision, Airtex Suspension, Vision, Softek Suspension; HENDRICKSON AIRTEK 5.36" Beam Drop
		ES800421	
		ES800422	DANA/SPICER AXLE ; DANA/SPICER AXLE D600, 700, 800, 850; E10011, 10021, 12001, 12021, E13201, 13221, 14601, 14621, EFA10F4, 12F4, 13F5, D850F, D850N
		ES800423	

Numerical/Buyer's Guide

Heavy Duty Chassis Parts Numerical/Buyers Guide

Numerical/Buyer's Guide

Tie Rod Ends (Cont'd)		Part Number	Application
Tie Rod Ends (Cont'd)		Tie Rod Ends (Cont'd)	
ES800423	DANA/SPICER AXLE ; DANA/SPICER AXLE D600, 700, 800, 850; E10011,10021,12001,12021,E13201,13221,14601,14621,EFA10F4,1 2F4,13F5, D850F, D850N		
ES800424	DANA/SPICER AXLE E1460i/w axle model		
ES800425			
ESK371	AUTOCAR A42, S42, A64, S64; BROCKWAY SERIES 450, 450C, 550, 550C, 700, 700C		
	AUTOCAR A42, S42, A64, S64		
	BROCKWAY SERIES 450, 450C, 550, 550C, 700, 700C		

Progressive Diametrical Size Charts Of King Bolt Sets

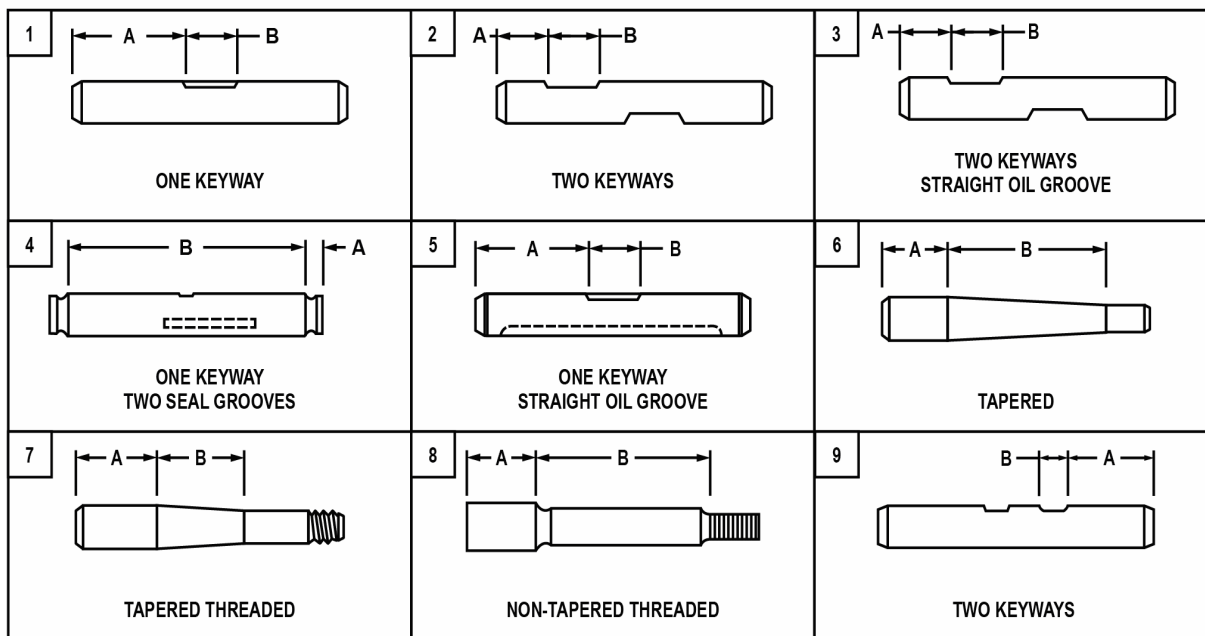

Part No.	Type	Diameter	Length	A	B	Bushing Type
6555B	2	1.921"	9.87"			Metal
6555C	2	1.921"	9.87"			Composite
8001C	9	1.359"	8.07"			Composite
8002C	9	2.046"	10.12"			Composite
8003C	9	2.046"	11.00"			Composite
8004C	9	1.873"	9.06"			Composite
80053B	3	1.484"	8.530"	2.750"	0.560"	Metal
80055B	1	1.811"	10.531"	5.249"	0.375"	Metal
80056B	1	1.811"	10.375"	5.375"	0.375"	Metal
80057B	6	2.098/1.746"	12.840"			Metal
80058B	6	2.125/1.750"	8.750"			Metal
80059B	6	1.186/1.434"	9.410"			Metal
8005C	9	1.794"	9.06"			Composite
80063B	2	1.790"	10.390"			Metal
80063C	2	1.790"	10.390"			Composite
80066B	2	1.484"	8.850"			Metal
80068C	2	1.743"	10.061"	3.557"	0.726"	Composite
80069B	2	1.812"	10.542"	3.342"	0.429"	Metal
8006C	9	1.859"	10.77"			Composite
80070C	2	2.046"	10.120"			Composite
80071C	2	1.794"	10.070"			Composite
80072B	2	1.794"	10.070"			Metal
80073C	2	1.794"	10.070"			Composite
80074B	2	2.046"	11.000"			Metal
80075C	2	2.046"	11.000"			Composite
80076B	1	1.794"	9.060"			Metal
80077B	1	1.872"	9.060"			Metal
80078C	1	1.872"	9.060"			Composite
80079C	1	1.611"	9.660"			Composite
8007C	9	1.998"	9.533"			Composite
8008C	9	1.998"	9.533"			Composite
8207B	1	0.921"	5.125"			Metal
8336B	1	1.109"	6.812"			Metal
8343B	1	1.109"	6.343"			Metal
8357B	1	1.234"	7.500"	3.531"	0.750"	Metal

Progressive Diametrical Size Charts Of King Bolt Sets

Part No.	Type	Diameter	Length	A	B	Bushing Type
8357N	1	1.234"	7.500"	3.531"	0.750"	Nylon
8375B	5	1.234"	7.656"	2.484"	0.594"	Metal
8375B015	5	1.249"	7.656"	2.484"	0.594"	Metal
8385B	5	1.234"	6.750"	2.312"	0.500"	Metal
8385B015	5	1.249"	6.750"	2.312"	0.500"	Metal
8386B	7	1.309/1.607"	9.750"	2.962"	3.288"	Metal
8386N	7	1.309/1.607"	9.750"	2.962"	3.288"	Nylon
8389B	5	1.110"	6.250"	2.094"	0.500"	Metal
8426B	1	1.129"	6.940"			Metal
8428B	1	0.921"	5.640"			Metal
8440B	1	0.822"	5.860"			Metal
8441B	5	1.125"	6.250"	2.094"	0.500"	Metal
8445B	1	0.921"	5.640"	2.590"	0.460"	Metal
8445N	1	0.921"	5.640"	2.590"	0.460"	Nylon
8454B	1	0.937"	6.469"	2.843"	0.438"	Metal
8454N	1	0.937"	6.469"	2.843"	0.438"	Nylon
8456B	2	1.124"	7.190"			Metal
8458B	4	0.922"	6.990"	0.490"	6.005"	Metal
8458B010	4	0.932"	6.990"	0.490"	6.005"	Metal
8459B	4	1.129"	7.670"	53.000"	6.607"	Metal
8462B	7	1.186/1.434"	8.750"	2.609"	3.218"	Metal
8462N	7	1.186/1.434"	8.750"	2.609"	3.218"	Nylon
8464B	1	1.109"	6.343"			Metal
8471B	4	1.129"	7.670"	0.530"	6.607"	Metal
8474B	7	1.400/1.794"	10.688"	3.520"	3.481"	Metal
8474N	7	1.400/1.794"	10.688"	3.520"	3.481"	Nylon
8479B	2	1.234"	7.440"	2.750"	0.440"	Metal
8479N	2	1.234"	7.440"	2.750"	0.440"	Nylon
8484T	1	1.109"	6.344"			Metal
8488B	4	1.231"	7.860"	0.540"	6.784"	Metal
8488B010	4	1.241"	7.860"	0.540"	6.784"	Metal
8489B	2	1.794"	9.120"	3.060"	0.440"	Metal
8489N	2	1.794"	9.120"	3.060"	0.440"	Nylon
8490T	1	1.109"	6.344"	3.000"	0.344"	Metal
8490T010	1	1.119"	6.344"	3.000"	0.344"	Metal
8490T020	1	1.129"	6.344"	3.000"	0.344"	Metal
8491B	1	1.249"	7.890"	3.750"	0.380"	Metal
8491B010	1	1.259"	7.890"	3.750"	0.380"	Metal
8491N	1	1.249"	7.890"	3.750"	0.380"	Nylon
8492B	1	1.109"	6.344"	3.000"	0.344"	Metal
8492B010	1	1.119"	6.344"	3.000"	0.344"	Metal
8492N	1	1.109"	6.344"	3.000"	0.344"	Nylon
8492T	1	1.109"	6.343"			Metal
8500B	4	1.231"	8.910"	0.540"	7.826"	Metal
8500B010	4	1.241"	8.910"	0.540"	7.826"	Metal
8500B015	4	1.246"	8.910"			Metal
8500N	4	1.231"	8.910"	0.540"	7.826"	Nylon
8503B	3	1.609"	9.610"	3.030"	0.560"	Metal
8503N	3	1.609"	9.610"	3.030"	0.560"	Nylon
8507B	2	1.234"	7.440"			Metal
8507B010	2	1.244"	7.440"	2.750"	0.440"	Metal
8507N	2	1.234"	7.440"			Nylon
8514B	2	1.607"	8.812"	3.469"	0.438"	Metal
8514N	2	1.607"	8.812"	3.469"	0.438"	Nylon
8515B	2	1.794"	9.120"			Metal
8518B	2	1.999"	11.040"	4.400"	0.440"	Metal
8518N	2	1.999"	11.040"	4.400"	0.440"	Nylon

Progressive Size Charts

Progressive Diametrical Size Charts Of King Bolt Sets

Part No.	Type	Diameter	Length	A	B	Bushing Type
8519B	2	1.434"	8.500"	3.410"	0.440"	Metal
8519B010	2	1.444"	8.500"	3.410"	0.440"	Metal
8519N	2	1.434"	8.500"	3.410"	0.440"	Nylon
8525B	4	1.231"	7.860"	6.780"	0.540"	Metal
8527B	1	1.811"	10.750"	5.016"	0.345"	Metal
8553B	2	1.794"	10.392"	3.742"	0.562"	Metal
8560B	1	1.234"	6.960"	3.280"	0.400"	Metal
8560N	1	1.234"	6.960"	3.280"	0.400"	Nylon
8562B	1	1.234"	7.640"			Metal
8562N	1	1.234"	7.640"	3.620"	0.400"	Nylon
8567B	2	1.609"	9.660"	3.031"	0.750"	Metal
8567N	2	1.609"	9.660"	3.031"	0.750"	Nylon
8568B	2	1.433"	8.250"	0.660"	0.660"	Metal
8570B	1	1.179"	6.360"	2.990"	0.380"	Metal
8570B010	1	1.189"	6.360"			Metal
8570N	1	1.179"	6.360"	2.990"	0.380"	Nylon
8571B	2	1.999"	11.212"	3.736"	0.562"	Metal
8571C	2	2.000"	11.210"			Composite
8572B	2	1.794"	10.070"	3.560"	0.660"	Metal
8572C	2	1.790"	10.700"			Composite
8573B	2	1.607"	9.080"	2.970"	0.660"	Metal
8577B	1	1.359"	7.970"	2.807"	0.512"	Metal
8577B002	1	1.361"	7.970"	2.807"	0.512"	Metal
8577B010	1	1.369"	7.970"			Metal
8577B015	1	1.374"	7.970"	2.807"	0.512"	Metal
8577C	1	1.359"	7.970"	2.807"	0.512"	Composite
8577C002	1	1.361"	7.970"	2.807"	0.512"	Composite
8579B	1	1.484"	8.850"	3.400"	1.000"	Metal
8579B002	1	1.486"	8.850"	3.400"	1.000"	Metal
8581B	1	1.609"	9.660"	3.500"	1.000"	Metal
8581B002	1	1.611"	9.660"	3.500"	1.000"	Metal
8581N	1	1.609"	9.660"	3.500"	1.000"	Nylon
8581N002	1	1.611"	9.660"	3.500"	1.000"	Nylon
8583B	1	1.609"	9.160"	3.500"	1.000"	Metal
8583N	1	1.609"	9.160"	3.500"	1.000"	Nylon
8583N002	1	1.611"	9.160"	3.500"	1.000"	Nylon
8585B	2	1.794"	10.070"			Metal
8587B	1	1.124"	7.190"	3.384"	1.102"	Metal
8587N	2	1.124"	7.190"			Metal
8590B	2	1.794"	10.392"	3.742"	0.562"	Metal
8592B	6	1.250/1.500"	6.690"	2.025"	3.000"	Metal
8593B	6	1.250/1.500"	7.400"	2.494"	3.000"	Metal
8601B	6	1.375/1.625"	7.470"	2.302"	3.000"	Metal
8605B	1	1.811"	10.531"	5.249"	0.375"	Metal
8609B	1	1.231"	7.860"			Metal
8610B	2	1.609"	9.160"	3.107"	0.525"	Metal
8610C	2	1.609"	9.160"	3.107"	0.525"	Composite
8611B	2	1.790"	10.390"			Metal
8611C	2	1.79"	10.39"			Composite
8612B	2	1.607"	9.380"	3.240"	0.438"	Metal
8613B	1	1.745"	9.380"			Metal
8616C	2	1.794"	10.390"			Composite
8617B	2	1.609"	9.660"	3.031"	0.750"	Metal
8617C	2	1.610"	9.660"			Composite
8618C	1	1.630"	9.200"			Composite
8631B	1	1.625"	9.195"			Metal
8631C	1	1.630"	9.200"			Composite
8633B	1	1.870"	9.970"			Metal

Progressive Diametrical Size Charts Of King Bolt Sets

Part No.	Type	Diameter	Length	A	B	Bushing Type
8633C	1	1.870"	9.970"			Composite
8635C	2	1.790"	10.390"			Composite
8637B	2	1.360"	7.970"			Metal
8637C	2	1.360"	7.970"			Composite
8639B	2	1.300"	7.757"	2.182"	0.580"	Metal
8641B	2	1.610"	9.080"			Composite
8643B	2	1.790"	10.070"			Composite
8645B	3	1.484"	8.850"	3.030"	0.560"	Metal
8647B	1	1.625"	9.200"			Metal
8653B	2	1.435"	8.240"	2.411"	0.723"	Metal
8655B	2	1.921"	9.870"			Metal
8655C	2	1.921"	9.870"			Composite
8657B	2	2.046"	10.120"			Metal
8659B	8	1.614"	8.035"	1.844"	4.590"	Metal
8660B	8	1.892"	9.203"	2.230"	5.255"	Metal
8661B	8	1.892"	9.604"	2.230"	5.627"	Metal
8674B	1	1.625"	9.2"			Metal
BK100N						Metal
BK113N						Metal
BK114N						Metal
BK148N						Metal
BK151						Metal
BK152						Nylon
BK156						Metal
BK167						Metal
BK169						Metal
BK179						Metal
BK180						Metal
BK182						Metal
BK183						Metal
BK188						Metal
BK190						Metal
BK194						Composite
BK200						Metal
BK202						Nylon
BK203						Metal
BK206						Metal
BK212						Metal
BK214						Metal
BK215						Metal
BK223						Nylon
BK231						Nylon
BK233						Nylon
BK234						Nylon
BK235						Nylon
BK237						Nylon
BK238						Nylon
BK239						Nylon
BK240						Nylon
BK243						Metal
BK245						Metal
BK246						Nylon
BK250						Nylon
BK251						Metal
BK252						Metal
BK258						Nylon
BK259						Metal
BK260						Composite
BK265						Metal
BK266						Metal
BK269						Nylon

Progressive Diametrical Size Charts Of King Bolt Sets

Part No.	Type	Diameter	Length	A	B	Bushing Type
BK271						Metal
BK272						Nylon
BK273						Nylon
BK275						Metal
BK276						Metal
BK277						Metal
BK278						Metal
BK279						Metal
BK280						Nylon
BK281						Metal
BK282						Metal
BK283						Metal
BK284						Metal
BK285						Metal
BK389						Metal
BK511						Metal
BK517						Metal
BK527						Metal
BK558						Metal
BK6						Metal

Progressive Size Charts

King Pin Set - Bushings

Part Number	Bushing	Bushing	Bushing
8001C			
8002C			
8003C			
8004C			
80053B	BK251 (4)		
80055B	BK212 (4)		
80056B	BK212 (4)		
80057B			
80058B			
80059B	BK260 (4)	BK194 (2)	
8005C			
80063B	BK265 (4)		
80063C			
80066B	BK251 (4)		
80068C			
80069B			
8006C			
80070C			
80071C			
80072B			
80073C			
80074B			
80075C			
80076B			
80077B			
80078C			
80079C			
8007C			
8207B	BK6 (4)		
8336B	BK100N (4)		
8343B			
8357B	BK156 (4)		
8357N	BK235 (4)		
8375B	BK148N (4)		
8385B	BK169 (4)		
8385B015	BK169 (4)		
8386B	BK151 (4)	BK152 (2)	
8386N	BK223 (4)	BK152 (2)	
8389B	BK167 (4)		
8426B	BK179 (4)		
8428B	BK182 (4)		
8440B			
8441B	BK167 (4)		
8445B	BK182 (4)		
8454B	BK188 (2)	BK190 (2)	
8454N	BK258 (4)		
8456B	BK113N (2)	BK114N (2)	
8458B	BK203 (4)		
8458B010	BK203 (4)		
8459B	BK206 (4)		
8462B	BK200 (2)	BK202 (2)	BK260 (2)
8462N	BK200 (2)	BK233 (2)	BK234 (2)
8471B	BK206 (4)		
8474B	BK214 (4)	BK215 (2)	
8479B	BK180 (4)		

Part Number	Bushing	Bushing	Bushing
8479N	BK237 (4)		
8484T	BK138N (4)		
8488B	BK228 (4)		
8488B010	BK228 (4)		
8489B	BK259 (4)		
8489N	BK238 (4)		
8490T	BK138N (4)		
8491B	BK227 (4)		
8491B010	BK227 (4)		
8491N	BK239 (4)		
8492B	BK138N (4)		
8492N	BK240 (4)		
8500B	BK256 (4)		
8500B010	BK256 (4)		
8500N	BK246 (4)		
8503B	BK252 (4)		
8507B	BK180 (4)		
8507B010	BK180 (4)		
8507N	BK237 (4)		
8514B	BK151 (4)		
8514N	BK223 (4)		
8515B	BK259 (4)		
8518B	BK271 (4)		
8518N	BK272 (4)		
8519B	BK260 (4)		
8519B010	BK260 (4)		
8519N	BK231 (4)		
8527B	BK212 (4)		
8553B	BK265 (4)		
8560B	BK180 (4)		
8560N	BK273 (4)		
8562B			
8562N	BK273 (4)		
8567B	BK252 (4)		
8567N	BK280 (4)		
8568B	BK266 (4)		
8570B	BK270 (4)		
8570B010			
8570N	BK269 (4)		
8571B	BK276 (4)		
8572B	BK277 (4)		
8573B	BK275 (4)		
8577B	BK278 (4)		
8577B010			
8577C			
8577C002			
8579B	BK251 (4)		
8579B002	BK251 (4)		
8581B	BK252 (4)		
8581B002	BK252 (4)		
8581N	BK280 (4)		
8581N002			
8583B	BK252 (4)		
8583N	BK280 (4)		
8583N002			

King Pin Set - Bushings

Part Number	Bushing	Bushing	Bushing
8585B	BK277 (4)		
8587B	BK113N (4)		
8587N	BK279 (4)		
8590B	BK265 (4)		
8592B	BK282 (2)		
8593B	BK281 (2)		
8601B	BK284 (2)	BK283 (2)	
8605B	BK212 (4)		
8609B	BK228 (4)		
8610B	BK252 (4)		
8610C			
8611B	BK265 (4)		
8612B			
8613B	BK285 (4)		
8617B	BK252 (4)		
8618C			
8631B			
8631C			
8633B			
8633C			
8637B	BK278 (4)		
8637C			
8639B			
8641B	BK275 (4)		
8643B	BK277 (4)		
8645B	BK251 (4)		
8647B			
8653B			
8655B			
8655C			
8657B			
8659B			
8660B			
8661B			
BK113N			
BK114N			
BK148N			
BK151			
BK152			
BK156			
BK167			
BK169			
BK179			
BK182			
BK188			
BK190			
BK200			
BK202			
BK203			
BK206			
BK212			
BK223			
BK233			
BK234			
BK235			
BK237			

Part Number	Bushing	Bushing	Bushing
BK238			
BK239			
BK240			
BK243			
BK246			
BK250			
BK251			
BK252			
BK258			
BK259			
BK260			
BK265			
BK266			
BK269			
BK271			
BK272			
BK273			
BK275			
BK276			
BK277			
BK278			
BK279			
BK280			
BK281			
BK282			
BK283			
BK284			
BK285			
BK389			
BK511			
BK527			
BK558			

Progressive Size Charts

King Bolt Bushing To King Bolt Set Crossover

Bushing Number	Comments	Bushing Number	Comments
BK100N	used in 8336B	BK279	used in 8587N
BK113N	used in 8456B, 8587B	BK280	used in 8567N, 8581N, 8583N
BK114N	used in 8456B	BK281	used in 8593B
BK138N	used in 8484T, 8490T, 8492B	BK282	used in 8592B
BK148N	used in 8375B	BK283	used in 8601B
BK151	used in 8386B, 8514B	BK284	used in 8601B
BK152	used in 8386B, 8386N	BK285	used in 8613B
BK156	used in 8357B		
BK167	used in 8389B		
BK169	used in 8385B, 8385B015		
BK180	used in 8479B, 8507B, 8507B010, 8560B		
BK182	used in 8428B, 8445B		
BK194	used in 80059B		
BK200	used in 8462B, 8462N		
BK202	used in 8462B		
BK203	used in 8458B, 8458B010		
BK206	used in 8459B, 8471B		
BK212	used in 80055B, 80056B, 8527B, 8605B		
BK214	used in 8474B		
BK215	used in 8474B		
BK223	used in 8386N, 8514N		
BK227	used in 8491B, 8491B010		
BK228	used in 8488B, 8488B010, 8609B		
BK231	used in 8519N		
BK233	used in 8462N		
BK234	used in 8462N		
BK235	used in 8357N		
BK237	used in 8479N, 8507N		
BK238	used in 8489N		
BK239	used in 8491N		
BK240	used in 8492N		
BK246	used in 8500N		
BK251	used in 80053B, 80066B, 8579B, 8579B002, 8645B		
BK252	used in 8503B, 8567B, 8581B, 8581B002, 8583B, 8610B, 8617B		
BK256	used in 8500B, 8500B010		
BK258	used in 8454N		
BK259	used in 8489B, 8515B		
BK260	used in 80059B, 8462B, 8519B, 8519B010		
BK265	used in 80063B, 8553B, 8590B, 8611B		
BK266	used in 8568B		
BK269	used in 8570N		
BK270	used in 8570B		
BK271	used in 8518B		
BK272	used in 8518N		
BK273	used in 8560N, 8562N		
BK275	used in 8573B, 8641B		
BK276	used in 8571B		
BK277	used in 8572B, 8585B, 8643B		
BK278	used in 8577B, 8637B		

Illustrated King Bolt Sets Listing - By Length

Length	Part Number	Length	Part Number	Length	Part Number
5,13"	8207B	6,25"	8389B	6,34"	8492B
5,64"	8428B	6,25"	8441B	6,34"	8492N
5,64"	8445B	6,34"	8343B	6,36"	8570B
5,64"	8445N	6,34"	8484T	6,36"	8570B010
5,86"	8440B	6,34"	8490T	6,36"	8570N

Illustrated King Bolt Sets Listing - By Length

Length	Part Number	Length	Part Number	Length	Part Number
6,47"	8454B	6,94"	8426B	7,19"	8587B
6,47"	8454N	6,96"	8560B	7,40"	8593B
6,69"	8592B	6,96"	8560N	7,44"	8507B
6,75"	8385B	6,99"	8458B	7,44"	8507N
6,75"	8385B015	6,99"	8458B010	7,47"	8601B
6,81"	8336B	7,19"	8456B	7,50"	8357B

Progressive Size Charts

Illustrated King Bolt Sets Listing - By Length

Length	Part Number	Length	Part Number	Length	Part Number
7,50"	8357N	7,86"	8488B	7,97"	8577B
7,64"	8562B	7,86"	8488B010	7,97"	8577B010
7,64"	8562N	7,86"	8609B	7,97"	8577C
7,66"	8375B	7,89"	8491B	7,97"	8577C002
7,67"	8459B	7,89"	8491B010	7,97"	8637B
7,67"	8471B	7,89"	8491N	8,24"	8653B

Illustrated King Bolt Sets Listing - By Length

Length	Part Number	Length	Part Number	Length	Part Number
8,25"	8568B	8,75"	8462B	8,85"	8579B002
8,50"	8519B	8,75"	8462N	8,85"	8645B
8,50"	8519B010	8,81"	8514B	8,91"	8500B
8,50"	8519N	8,81"	8514N	8,91"	8500B010
8,53"	80053B	8,85"	80066B	8,91"	8500N
8,75"	80058B	8,85"	8579B	9,06"	80076B

Progressive Size Charts

Illustrated King Bolt Sets Listing - By Length

Length	Part Number	Length	Part Number	Length	Part Number
9,06"	80077B	9,16"	8583B	9,20"	8631C
9,06"	80078C	9,16"	8583N	9,20"	8647B
9,08"	8573B	9,16"	8583N002	9,20"	8660B
9,08"	8641B	9,16"	8610C	9,38"	8612B
9,12"	8489B	9,20"	8631B	9,38"	8613B
9,12"	8489N	9,20"	8618C	9,41"	80059B

Illustrated King Bolt Sets Listing - By Length



Length	Part Number	Length	Part Number	Length	Part Number
9,60"	8661B	9,66"	8581B002	9,87"	8655B
9,61"	8503B	9,66"	8581N	9,97"	8633B
9,66"	80079C	9,66"	8581N002	9,97"	8633C
9,66"	8567B	9,66"	8617B	10,06"	80068C
9,66"	8567N	9,75"	8386B	10,07"	80071C
9,66"	8581B	9,75"	8386N	10,07"	80072B

Progressive Size Charts

Illustrated King Bolt Sets Listing - By Length

Length	Part Number	Length	Part Number	Length	Part Number
10,07"	80073C	10,38"	80056B	10,54"	80069B
10,07"	8572B	10,39"	80063B	10,69"	8474B
10,07"	8585B	10,39"	8611B	10,75"	8527B
10,07"	8643B	10,39"	8553B	11,00"	80075C
10,12"	80070C	10,39"	8590B	11,04"	8518B
10,12"	8657B	10,53"	80055B	11,04"	8518N

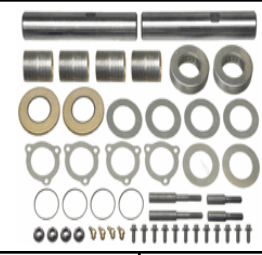
Illustrated King Bolt Sets Listing - By Length

Length	Part Number	Length	Part Number	Length	Part Number
11,21"	8571B				
					
12,84"	80057B				
					

Progressive Size Charts

Progressive Size Charts For Tie Rod Ends

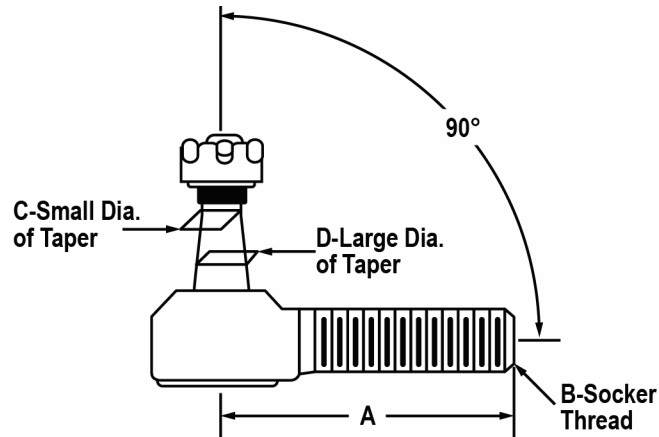

Part No.	Length (A)	Thread (B)	Small Diameter (C)	Large Diameter (D)	Taper	Thread Type
ES150L	3.50"	3/4-16L	0.612"	0.705"	0.744"	External
ES150R	3.50"	3/4-16R	0.612"	0.705"	0.744"	External
ES158L	3.41"	11/16-18L	0.644"	0.734"	0.720"	External
ES158R	3.41"	11/16-18R	0.644"	0.734"	0.720"	External
ES176L	3.75"	1-16L	0.783"	0.874"	0.890"	External
ES176R	3.75"	1-16R	0.783"	0.874"	0.896"	External
ES187L	4.88"	1 1/8-12L	0.967"	1.102"	1.080"	External
ES187R	4.88"	1 1/8-12R	0.967"	1.102"	1.080"	External
ES194L	3.75"	7/8-18L	0.678"	0.781"	0.824"	External
ES194R	3.75"	7/8-18R	0.678"	0.781"	0.824"	External
ES2030R	3.12"	15/16-20R	0.896"	1.030"	1.072"	Internal
ES2035L	5.86"	1-16L	0.783"	0.905"	0.976"	External
ES2036R	5.86"	1-16R	0.783"	0.905"	0.976"	External
ES2040R	5.75"	1 1/4-12R	1.080"	1.250"	1.360"	External
ES2061L	4.93"	1-16L	0.783"	0.905"	0.976"	External
ES2062R	4.93"	1-16R	0.783"	0.905"	0.976"	External
ES2082R	4.44"	7/8-18R	0.664"	0.773"	0.872"	External
ES2083L	4.44"	7/8-18L	0.664"	0.773"	0.872"	External
ES2090L	7.37"	1 1/4-12L	1.080"	1.250"	1.360"	External
ES2091R	7.37"	1 1/4-12R	1.080"	1.250"	1.360"	External
ES2113R	5.75"	1 1/4-12R	1.08"	1.25"	1.36"	External
ES2114R	5.75"	1 1/4-12R	1.08"	1.25"	1.36"	External
ES2116L	5.75"	1 1/4-12L	1.08"	1.25"	1.36"	External
ES2200L	10.50"	1 5/8-12L	0.967"	1.102"		External
ES2201R	10.50"	1 5/8-12R	0.967"	1.102"		External
ES2202R	7.38"	1 1/4-12R	1.08"	1.25"	1.36"	External
ES2203R	5.50"	1 1/4-12R	0.967"	1.102"		External
ES2204R	7.38"	1 1/4-12R	1.08"	1.25"	1.36"	External
ES2207R	5.75"	1 1/4-16R	1.08"			External
ES2208R	5.75"	1 1/4-16R	1.080"	1.250"		External
ES2209R	7.37"	1 1/4-12R	1.08"	1.25"	1.36"	Internal
ES2210L	7.37"	1 1/4-12L	1.08"	1.25"	1.36"	Internal
ES2224L	5.75"	1 1/4-12L	1.117"	1.250"		External
ES2225R	5.75"	1 1/4-12R	1.117"	1.250"		External
ES2257R	4.88"	1 1/8-16R	0.896"	1.030"	1.070"	External
ES235L	3.75"	1-16L	0.664"	0.781"	0.936"	External
ES235R	3.75"	1-16R	0.664"	0.781"	0.936"	External
ES2556L	3.78"	M20X1.5L	0.657"	0.748"		External
ES2557R	3.78"	M20X1.5R	0.657"	0.748"		External
ES2613L	5.44"	1 1/8-14R	0.973"	1.102"		External
ES2614R	5.44"	1 1/8-12R	0.973"	1.102"		External







Progressive Size Charts For Tie Rod Ends

Part No.	Length (A)	Thread (B)	Small Diameter (C)	Large Diameter (D)	Taper	Thread Type
ES262L	3.25"	11/16-18L	0.612"	0.705"		External
ES262R	3.25"	11/16-18R	0.612"	0.705"		External
ES26L	3.55"	13/16-18L	0.612"	0.705"	0.744"	External
ES26R	3.55"	13/16-18R	0.612"	0.705"	0.744"	External
ES3026L	10.80"	1 3/8-12L	0.783"	0.899"		External
ES3027R	10.80"	1 3/8-12R	0.783"	0.899"		External
ES3030R	12.69"	1 7/8-12R	1.080"	1.250"		External
ES3031L	12.69"	1 7/8-12L	1.080"	1.250"		External
ES3032R	5.75"	1 1/4-18R	1.080"	1.250"	1.360"	External
ES3039L	13.25"	1 7/16-12L	0.783"	0.899"		External
ES3040R	13.25"	1 7/16-12R	0.783"	0.899"		External
ES304L	3.90"	1-16L	0.780"	0.905"	1.000"	External
ES304R	3.90"	1-16R	0.780"	0.905"	1.000"	External
ES3086L	10.84"	1 7/8-12L	0.967"	1.102"	1.080"	External
ES3087R	10.84"	1 7/8-12R	0.967"	1.102"	1.080"	External
ES3176R	6.00"	1 1/8-12R	0.967"	1.102"	1.080"	External
ES3177L	6.00"	1 1/8-12L	0.967"	1.102"	1.080"	External
ES3178R	6.38"	1 1/4-12R	0.967"	1.102"	1.080"	External
ES3204L	11.89"	1 3/8-12L	0.762"	0.874"		External
ES3205R	11.89"	1 3/8-12R	0.762"	0.874"		External
ES3214R	12.40"	1 1/4-12R	1.080"	1.250"	1.360"	Internal
ES3216R	4.88"	1 1/8-12R	0.967"	1.102"	1.080"	External
ES3217L	5.44"	1 1/8-12L	0.967"	1.102"	1.080"	External
ES3218R	5.44"	1 1/8-12R	0.967"	1.102"	1.080"	External
ES3219L	9.43"	1 1/8-12L	0.967"	1.102"		External
ES3220R	9.43"	1 1/8-12R	0.967"	1.102"		External
ES323L	4.00"	5/8-18L	0.516"	0.613"	0.776"	External
ES323R	4.00"	5/8-18R	0.516"	0.613"	0.776"	External
ES3252R	5.75"	1 1/4-12R	1.252"	1.252"		External
ES325L	5.50"	1 1/4-12L	0.967"			Internal
ES325R	5.50"	1 1/4-12R	0.967"			Internal
ES3268L	5.02"	1-16L	0.915"	1.024"	0.870"	External
ES3269R	5.02"	1-16R	0.915"	1.024"	0.870"	External
ES3270L	5.44"	1 1/8-12L	0.806"	0.915"	0.870"	External
ES3271R	5.44"	1 1/8-12R	0.806"	0.915"	0.870"	External
ES3274L	5.44"	1 1/8-12L	0.895"	1.038"	1.140"	External
ES3275R	5.44"	1 1/8-12R	0.895"	1.038"	1.140"	External
ES3283R	7.18"	1-16R	0.783"	0.899"	0.930"	External
ES3284L	7.18"	1-16L	0.783"	0.899"	0.930"	External
ES3294R	4.88"	1 1/8-16R	0.967"	0.000"	1.080"	External
ES3297R	8.12"	1 1/4-12R	0.967"	1.107"	1.120"	External
ES3298L	8.12"	1 1/4-12L	0.967"	1.107"	1.120"	External
ES3304R	3.12"	1-16R	0.967"	1.120"	1.080"	Internal
ES330L	5.86"	1-16L	0.780"	0.876"	0.784"	External
ES330R	5.86"	1-16R	0.780"	0.876"	0.784"	External
ES3312R	5.44"	1 1/8-18R	0.967"	1.102"	1.080"	External
ES3328R	4.43"	1-16R	0.780"		0.930"	External
ES3329L	4.43"	1-16L	0.780"		0.930"	External
ES332L	6.50"	1 1/8-16L	0.893"	0.995"		External
ES332R	6.50"	1 1/8-16R	0.893"	0.995"		External
ES3335R	4.13"	M20X1.5R	0.713"			External
ES3336L	4.13"	M20X1.5L	0.713"			External
ES3442R	7.38"	1 1/4-12R	0.967"		1.080"	External
ES3443L	7.38"	1 1/4-12L	0.967"		1.080"	External
ES346L	5.75"	1 1/4-12R	1.080"	1.250"		External
ES346R	5.75"	1 1/4-12L	1.080"	1.250"		External
ES3476	6.00"	1 1/8-12R	0.967"			External
ES3477	6.00"	1 1/8-12L	0.967"			External
ES373L	4.45"	1-16L	0.780"	0.899"	0.928"	External

Progressive Size Charts For Tie Rod Ends

Part No.	Length (A)	Thread (B)	Small Diameter (C)	Large Diameter (D)	Taper	Thread Type
ES373R	4.45"	1-16R	0.780"	0.899"	0.928"	External
ES376L	5.75"	1 1/4-12L	1.08"			External
ES376R	5.75"	1 1/4-12R	1.08"			External
ES405L	4.88"	1 1/8-12L	0.896"	1.030"	1.072"	External
ES405R	4.88"	1 1/8-12R	0.896"	1.030"	1.072"	External
ES411L	9.18"	1 1/8-12L	0.967"	1.102"		External
ES411R	9.18"	1 1/8-12R	0.967"	1.102"		External
ES416L	3.22"					
ES416R	3.22"					
ES423L	5.44"	1 1/8-12L	0.967"	1.107"	1.120"	External
ES423R	5.44"	1 1/8-12R	0.967"	1.107"	1.120"	External
ES431L	5.75"	1 1/4-12L	1.080"	1.250"	1.360"	External
ES431R	5.75"	1 1/4-12R	1.080"	1.250"	1.360"	External
ES434L	5.75"	1 1/4-12L	1.117"	1.250"		External
ES800420	10.32"	1 1/4-12R	0.967"			
ES800421	10.32"	1 1/4-12L	0.967"			
ES800422	9.26"	1 1/4-12R	0.967"			
ES800423	9.26"	1 1/4-12L	0.967"			
ES800424	7.61"					
ES800425	7.61"					
ESK371						

Illustrated Tie Rod Ends Listing - By Length

Length	Part Number	Length	Part Number	Length	Part Number
	ES416L	3,25"	ES262R	3,55"	ES26R
					
	ES416R	3,41"	ES158L	3,75"	ES176L
					
	ES800424	3,41"	ES158R	3,75"	ES176R
					
	ES800425	3,50"	ES150L	3,75"	ES194L
					
	ESK371	3,50"	ES150R	3,75"	ES194R
					
		3,55"	ES26L	3,75"	ES235L
3,25"	ES262L				
					

Progressive Size Charts

Illustrated Tie Rod Ends Listing - By Length

Length	Part Number	Length	Part Number	Length	Part Number
3,75"	ES235R	4,00"	ES323R	4,44"	ES2083L
					
3,78"	ES2556L	4,13"	ES3335R	4,45"	ES373L
					
3,78"	ES2557R	4,13"	ES3336L	4,45"	ES373R
					
3,90"	ES304L	4,43"	ES3328R	4,88"	ES187L
					
3,90"	ES304R	4,43"	ES3329L	4,88"	ES187R
					
4,00"	ES323L	4,44"	ES2082R	4,88"	es2257r
					

Illustrated Tie Rod Ends Listing - By Length

Length	Part Number	Length	Part Number	Length	Part Number
4,88"	ES3216R	5,02"	ES3269R	5,44"	ES3271R
					
4,88"	ES405L	5,44"	ES2613L	5,44"	ES3274L
					
4,88"	ES405R	5,44"	ES2614R	5,44"	ES3275R
					
4,93"	ES2061L	5,44"	ES3217L	5,44"	ES3312R
					
4,93"	ES2062R	5,44"	ES3218R	5,44"	ES423L
					
5,02"	ES3268L	5,44"	ES3270L	5,44"	ES423R
					













Illustrated Tie Rod Ends Listing - By Length

Length	Part Number	Length	Part Number	Length	Part Number
5,50"	ES325L	5,75"	ES376R	5,86"	ES330R
					
5,50"	ES325R	5,75"	ES431L	6,00"	ES3176R
					
5,75"	ES2040R	5,75"	ES431R	6,00"	ES3177L
					
5,75"	ES2208R	5,86"	ES2035L	6,00"	ES3476
					
5,75"	ES346L	5,86"	ES2036R	6,00"	ES3477
					
5,75"	ES376L	5,86"	ES330L	6,50"	ES332L
					
					

Illustrated Tie Rod Ends Listing - By Length

Length	Part Number	Length	Part Number	Length	Part Number
6,50"	ES332R	7,38"	ES3442R	9,26"	ES800422
					
7,18"	ES3283R	7,38"	ES3443L	9,26"	ES800423
					
7,18"	ES3284L	8,12"	ES3297R	9,43"	ES3219L
					
7,37"	ES2090L	8,12"	ES3298L	9,43"	ES3220R
					
7,37"	ES2091R	9,18"	ES411L	10,32"	ES800420
					
7,37"	ES2210L	9,18"	ES411R	10,32"	ES800421
					

Illustrated Tie Rod Ends Listing - By Length

Length	Part Number	Length	Part Number	Length	Part Number
10,50"	ES2200L	11,89"	ES3204L		
					
10,50"	ES2201R	11,89"	ES3205R		
					
10,80"	ES3026L	12,69"	ES3030R		
					
10,80"	ES3027R	12,69"	ES3031L		
					
10,84"	ES3086L	13,25"	ES3039L		
					
10,84"	ES3087R	13,25"	ES3040R		
					

Progressive Size Charts For Drag Links

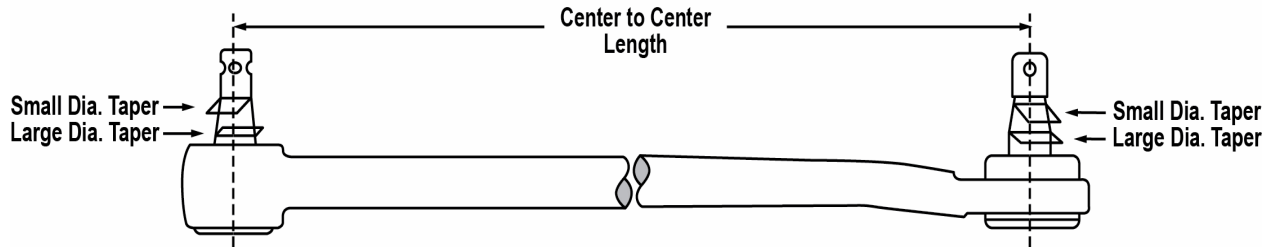

Part No.	Center to Center Length	Thread Size	Number of Studs	First Stud Diameters			Second Stud Diameters		
				Small Diameter	Large Diameter	Thread	Small Diameter	Large Diameter	Thread
DS1020	16.27"	1 1/4-12R	2	1.080"	1.250"	7/8-14	1.080"	1.250"	7/8-14
DS1021	17.65"	n/a	2	0.967"	1.102"	7/8-14	0.967"	1.102"	7/8-14
DS1022	17.13"	1 1/4-12R	2	0.967"	1.102"	7/8-14	0.967"	1.102"	7/8-14
DS1024	18.38"	Assembly	2	1.120"	1.250"	7/8-14	1.120"	1.250"	7/8-14
DS1025	41.29"	Assembly	2	1.117"	1.250"	7/8-14	1.117"	1.250"	7/8-14
DS1026	41.29"	1 1/4-12R	2	1.117"	1.250"	7/8-14	1.117"	1.250"	7/8-14
DS1027	17.40"	1 1/4-12R	2	1.080"	1.250"	7/8-14	1.080"	1.250"	7/8-14
DS1028	17.88"	1 1/4-12R	2	1.080"	1.250"	7/8-14	1.080"	1.250"	7/8-14
DS1030	32.65"	1 1/4-12R	2	0.967"	1.102"	7/8-14	0.967"	1.102"	7/8-14
DS1031	17.37"	1 1/4-12R	2	0.967"	1.102"	7/8-14	0.967"	1.102"	7/8-14
DS1033	16.12"	Assembly	2	1.117"	1.250"	7/8-14	1.117"	1.250"	7/8-14
DS1034	16.84"	n/a	2	0.762"	0.874"	5/8-18	0.762"	0.874"	5/8-18
DS1035	37.07"	n/a	2	0.967"	1.102"	7/8-14	1.080"	1.250"	7/8-14
DS1044	16.89"	n/a	2	0.896"	1.030"		0.896"	1.030"	
DS1064	17.00"	n/a	2	0.783"	0.899"	3/4-16	0.783"	0.899"	3/4-16
DS1067	16.89"	n/a	2	0.896"	1.030"		0.896"	1.030"	
DS1136	13.00"	n/a	2	1.080"	1.250"	7/8-14	1.080"	1.250"	7/8-14
DS1179	14.21"	n/a	2	1.080"	1.250"	7/8-14	1.080"	1.250"	7/8-14
DS1180	31.69"	n/a	2	1.080"	1.250"	7/8-14	1.080"	1.250"	7/8-14
DS1182	29.13"	n/a	2	1.080"	1.250"	7/8-14	1.080"	1.250"	7/8-14
DS1184	44.29"	n/a	2	1.080"	1.250"	7/8-14	1.080"	1.250"	7/8-14
DS1185	14.21"	n/a	2	1.080"	1.250"	7/8-14	1.252"	1.252"	
DS1190	19.29"	n/a	2	0.783"	0.899"	3/4-16	0.967"	1.102"	7/8-14
DS1191	20.66"	n/a	2	0.783"	0.899"	3/4-16	0.783"	0.899"	3/4-16
DS1192	20.30"	n/a	2	0.967"	1.102"	7/8-14	0.967"	1.102"	7/8-14
DS1195	24.12"	n/a	2	0.783"	0.899"	3/4-16	0.783"	0.899"	3/4-16
DS1196	24.12"	n/a	2	0.783"	0.899"	3/4-16	0.783"	0.899"	3/4-16
DS1197	17.62"	n/a	2	0.783"	0.899"	3/4-16	0.783"	0.899"	3/4-16
DS1198	17.53"	n/a	2	0.783"	0.899"	3/4-16	0.783"	0.899"	3/4-16
DS1199	18.50"	n/a	2	0.967"	1.102"	7/8-14	0.967"	1.102"	7/8-14
DS1200	18.58"	n/a	2	0.967"	1.102"	7/8-14	0.967"	1.102"	7/8-14
DS1203	36.15"	n/a	2	0.967"	1.102"	7/8-14	1.080"	1.250"	7/8-14
DS1204	19.23"	n/a	2	0.967"	1.102"	7/8-14	1.080"	1.250"	7/8-14
DS1205	35.00"	n/a	2	0.967"	1.102"	7/8-14	1.080"	1.250"	7/8-14
DS1206	36.31"	n/a	2	0.967"	1.102"	7/8-14	1.080"	1.250"	7/8-14
DS1207	32.62"	n/a	2	0.967"	1.102"	7/8-14	1.080"	1.250"	7/8-14
DS1214	17.68"	n/a	2	0.967"	1.102"	7/8-14	0.967"	1.102"	7/8-14
DS1215	17.47"	n/a	2	0.762"	0.874"	5/8-18	0.762"	0.874"	5/8-18
DS1216	20.65"	n/a	2	0.915"	1.024"		0.915"	1.024"	
DS1217	17.48"	n/a	2	1.038"	1.181"	7/8-14	1.038"	1.181"	7/8-14

Progressive Size Charts For Drag Links

Part No.	Center to Center Length	Thread Size	Number of Studs	First Stud Diameters			Second Stud Diameters		
				Small Diameter	Large Diameter	Thread	Small Diameter	Large Diameter	Thread
DS1218	28.87"	n/a	2	0.967"	1.102"	7/8-14	0.967"	1.102"	7/8-14
DS1219	29.38"	n/a	2	0.967"	1.102"	7/8-14	0.967"	1.102"	7/8-14
DS1220	18.83"	n/a	2	0.967"	1.102"	7/8-14	0.967"	1.102"	7/8-14
DS1221	32.61"	n/a	2	0.967"	1.102"	7/8-14	0.967"	1.102"	7/8-14
DS1234	37.13"	n/a	2	0.967"	1.102"	7/8-14	1.080"	1.250"	7/8-14
DS1253	13.18"	1 1/4-12R	1	1.080"	1.250"	7/8-14			
DS1254	14.18"	1 1/4-12R	1	1.080"	1.250"	7/8-14			
DS1259	20.44"	n/a	2	0.783"		3/4-16	0.915"		
DS1263	29.91"	1 1/4-12R	1	1.080"	1.250"	7/8-14			
DS1264	24.08"	1 1/4-12R	1	0.967"	1.102"	7/8-14			
DS1265	17.53"	n/a	2	0.967"	1.102"	7/8-14	1.080"	1.250"	7/8-14
DS1266	32.53"	n/a	2	0.967"	1.102"	7/8-14	1.080"	1.250"	7/8-14
DS1267	17.53"	n/a	2	0.967"	1.102"	7/8-14	1.080"	1.250"	7/8-14
DS1268	32.53"	n/a	2	0.967"	1.102"	7/8-14	1.080"	1.250"	7/8-14
DS1269	22.61"	n/a	2	0.967"	1.102"	7/8-14	1.080"	1.250"	7/8-14
DS1270	17.91"	n/a	2	0.967"	1.102"	7/8-14	1.080"	1.250"	7/8-14
DS1271	19.47"	n/a	2	0.967"	1.102"	7/8-14	1.080"	1.250"	7/8-14
DS1272	19.43"	n/a	2	0.967"	1.102"	7/8-14	1.080"	1.250"	7/8-14
DS1273	15.75"	n/a	2	0.945"	1.103"	7/8-14	0.945"	1.103"	7/8-14
DS1274	32.58"	n/a	2	0.967"	1.102"	7/8-14	0.967"	1.102"	7/8-14
DS1275	32.03"	n/a	2	0.967"	1.102"	7/8-14	0.967"	1.102"	7/8-14
DS1276	29.44"	n/a	2	0.967"	1.102"	7/8-14	0.967"	1.102"	7/8-14
DS1277	20.28"	n/a	2	0.915"	1.495"	3/4-16	0.915"	1.495"	3/4-16
DS1278	16.85"	n/a	2	1.038"	1.798"	7/8-14	1.038"	1.798"	7/8-14
DS1281	17.96"	n/a	2	0.967"	1.102"	7/8-14	0.967"	1.102"	7/8-14
DS1283	19.29"	1 1/4-12R	2	1.080"	1.250"	7/8-14	1.080"	1.250"	7/8-14
DS1291A	27.56"	1 1/4-12R	2	0.967"	1.102"	7/8-14	0.967"	1.102"	7/8-14
DS1293	33.88"	1 1/4-12R	1	1.080"	1.250"	7/8-14			
DS1294A	29.01"	1 1/4-12R	2	1.080"	1.250"	7/8-14	1.080"	1.250"	7/8-14
DS1295A	29.20"	1 1/4-12R	2	1.080"	1.250"	7/8-14	1.080"	1.250"	7/8-14
DS1298	24.99"	1 1/4-12R	1	1.080"	1.250"	7/8-14			
DS1299A	34.70"	1 1/4-12R	2	1.080"	1.250"	7/8-14	1.080"	1.250"	7/8-14
DS1302	16.50"	n/a	2	0.967"	1.102"	7/8-14	0.967"	1.102"	7/8-14
DS1303	32.85"	n/a	2	0.967"	1.102"	7/8-14	0.967"	1.102"	7/8-14
DS1305	18.45"	n/a	2	0.967"	1.102"	7/8-14	0.967"	1.102"	7/8-14
DS1313	37.18"	1 1/4-12R	1	1.080"	1.250"	7/8-14			
DS1337	31.85"	1 1/4-12R	2	0.896"	1.030"	3/4-16	1.080"	1.250"	7/8-14
DS1340	18.72"	n/a	2	0.967"	1.102"	7/8-14	0.967"	1.102"	7/8-14
DS1344	34.62"	n/a	2	0.967"	1.102"	7/8-14	0.967"	1.102"	7/8-14
DS1350	31.50"	Assembly	2	1.080"	1.250"	7/8-14	1.080"	1.250"	7/8-14
DS1362S	57.63"	1-16	0						
DS1363S	58.63"	1-16	0						
DS1366	21.20"	n/a	2	0.783"	0.903"	3/4-16	0.915"	1.029"	
DS1367A	65.80"	Assembly	2	0.967"	1.102"	7/8-14	0.967"	1.102"	7/8-14
DS1368A	66.03"	Assembly	2	0.967"	1.102"	7/8-14	0.967"	1.102"	7/8-14
DS1369	19.43"	n/a	2	0.967"	1.102"	7/8-14	1.080"	1.250"	7/8-14
DS1370	18.47"	n/a	2	0.967"	1.102"	7/8-14	1.080"	1.250"	7/8-14
DS1371	19.01"	n/a	2	0.967"	1.102"	7/8-14	1.080"	1.250"	7/8-14
DS1379S	59.34"	1 1/8-12	0						
DS1380S	55.49"	1 1/4-12	0						
DS1409	22.61"	n/a	2	0.967"	1.102"	7/8-14	1.080"	1.250"	7/8-14
DS1441	15.28"	n/a	2						
DS1442	18.24"	n/a	2	0.967"		7/8-14	1.080"		7/8-14

Progressive Size Charts

Progressive Size Charts For Drag Links

Part No.	Center to Center Length	Thread Size	Number of Studs	First Stud Diameters			Second Stud Diameters		
				Small Diameter	Large Diameter	Thread	Small Diameter	Large Diameter	Thread
DS1443	26.83"	n/a	2	0.967"		7/8-14	1.080"		7/8-14
DS1444	27.45"	n/a	2	0.967"		7/8-14	1.080"		7/8-14
DS1445	18.65"	n/a	2	0.967"		7/8-14	1.108"		
DS1446	18.42"	n/a	2	0.967"		7/8-14	1.080"		7/8-14
DS1447	18.21"	n/a	2	0.967"		7/8-14	1.080"		7/8-14
DS1448	18.21"	n/a	2	0.967"		7/8-14	1.080"		7/8-14
DS1454	28.25"	1 1/4-12R	2	1.080"		7/8-14	1.080"	1.250"	7/8-14
DS300001	27.75"		2						
DS300002	31.47"		2						
DS584	15.50"								
DS659	15.32"	n/a	2	0.612"	0.701"	9/16-18	0.612"	0.701"	9/16-18
DS685	22.47"	n/a	2	0.612"	0.701"	9/16-18	0.612"	0.701"	9/16-18
DS733	16.25"	n/a	2	0.780"	0.899"	3/4-16	0.780"	0.899"	3/4-16
DS800	16.64"	n/a	2	0.783"	0.899"	3/4-16	0.783"	0.899"	3/4-16
DS803	16.16"	n/a	2	0.783"	0.899"	3/4-16	0.783"	0.899"	3/4-16
DS835	16.75"	n/a	2	0.669"	0.753"	5/8-18	0.669"	0.753"	5/8-18
DS845	19.39"	n/a	2	0.783"	0.899"	3/4-16	0.783"	0.899"	3/4-16
DS867	25.82"	n/a	2	0.664"	0.773"	5/8-18	0.664"	0.773"	5/8-18
DS872	17.02"	n/a	2	0.967"	1.102"	7/8-14	0.967"	1.102"	7/8-14
DS873	15.37"	n/a	2	0.967"	1.102"	7/8-14	0.967"	1.102"	7/8-14
DS880	26.05"	n/a	2	0.762"	0.874"	5/8-18	0.762"	0.874"	5/8-18
DS881	23.78"	n/a	2	0.662"	0.776"	5/8-18	0.662"	0.776"	5/8-18
DS908	18.03"	n/a	2	0.967"	1.102"	7/8-14	1.080"	1.250"	7/8-14
DS910	17.70"	n/a	2	0.896"	1.030"	3/4-16	0.896"	1.030"	3/4-16
DS929	16.75"	n/a	2	0.668"	0.750"	5/8-18	0.668"	0.750"	5/8-18
DS930	24.80"	n/a	2	0.662"	0.776"	5/8-18	0.662"	0.776"	5/8-18
DS938	17.82"	n/a	2	0.896"	1.030"	3/4-16	0.896"	1.030"	3/4-16
DS939	17.82"	n/a	2	0.896"	1.030"	3/4-16	0.896"	1.030"	3/4-16
DS941	17.70"	n/a	2	0.896"	1.030"	3/4-16	0.896"	1.030"	3/4-16
DS943	36.31"	n/a	2	0.967"	1.102"	7/8-14	1.080"	1.250"	7/8-14
DS944	31.93"	n/a	2	0.780"	0.899"	3/4-16	0.780"	0.899"	3/4-16
DS945	15.85"	n/a	2	0.783"	0.899"	3/4-16	0.967"	1.102"	7/8-14
DS946	18.89"	n/a	2	0.783"	0.899"	3/4-16	0.967"	1.102"	7/8-14
DS948	19.25"	n/a	2	0.783"	0.899"	3/4-16	0.783"	0.899"	3/4-16
DS949	19.23"	n/a	2	0.967"	1.102"	7/8-14	1.080"	1.250"	7/8-14
DS952	16.49"	n/a	2	1.080"	1.250"	7/8-14	0.967"	1.102"	7/8-14
DS953	36.63"	n/a	2	0.967"	1.102"	7/8-14	1.080"	1.250"	7/8-14
DS954	18.74"	n/a	2	0.967"	1.102"	7/8-14	1.080"	1.250"	7/8-14
DS955	35.61"	n/a	2	0.967"	1.102"	7/8-14	0.967"	1.102"	7/8-14
DS956	35.37"	n/a	2	0.967"	1.102"	7/8-14	1.080"	1.250"	7/8-14
DS958	19.88"	n/a	2	0.967"	1.102"	7/8-14	1.080"	1.250"	7/8-14
DS963	15.27"	n/a	2	0.967"	1.102"	7/8-14	0.967"	1.102"	7/8-14
DS969	14.13"	n/a	2	0.762"	0.874"		0.762"	0.874"	
DS970	14.75"	n/a	2	0.762"	0.874"		0.762"	0.874"	
DS971	14.80"	n/a	2	0.967"	1.102"	7/8-14	0.967"	1.102"	7/8-14
DS972	14.08"	n/a	2	0.967"	1.102"	7/8-14	0.967"	1.102"	7/8-14
DS973	15.28"	n/a	2	0.967"	1.102"	7/8-14	0.967"	1.102"	7/8-14
DS974	14.45"	n/a	2	0.967"	1.102"	7/8-14	0.967"	1.102"	7/8-14
DS976	14.45"	n/a	2	0.967"	1.102"	7/8-14	0.967"	1.102"	7/8-14
DS977	14.44"	n/a	2	0.762"	0.874"	5/8-18	0.762"	0.874"	5/8-18
DS979	18.14"	n/a	2	0.967"	1.102"	7/8-14	0.967"	1.102"	7/8-14
DS982	17.20"	n/a	2	0.967"	1.102"	7/8-14	0.967"	1.102"	7/8-14
DS983	32.22"	n/a	2	0.748"	0.874"	5/8-18	0.748"	0.874"	5/8-18

Progressive Size Charts For Drag Links

















Part No.	Center to Center Length	Thread Size	Number of Studs	First Stud Diameters			Second Stud Diameters		
				Small Diameter	Large Diameter	Thread	Small Diameter	Large Diameter	Thread
DS986	17.93"	n/a	2	0.967"	1.102"	7/8-14	0.967"	1.102"	7/8-14
DS987	17.96"	n/a	2	0.967"	1.102"	7/8-14	0.967"	1.102"	7/8-14
DS988	17.90"	n/a	2	0.896"	1.030"		0.896"	1.030"	
DS991	18.20"	n/a	2	0.896"	1.030"	3/4-16	0.896"	1.030"	3/4-16
DS992	29.56"	1 1/4-12R	2	1.080"	1.250"	7/8-14	1.080"	1.250"	7/8-14
DS993	29.56"	1 1/4-12R	2	1.080"	1.250"	7/8-14	1.080"	1.250"	7/8-14
DS994	30.56"	1 1/4-12R	2	1.080"	1.250"	7/8-14	1.080"	1.250"	7/8-14
DS995	27.31"	1 1/4-12R	2	1.080"	1.250"	7/8-14	1.080"	1.250"	7/8-14
DS996	26.75"	1 1/4-12R	2	1.080"	1.250"	7/8-14	1.080"	1.250"	7/8-14
DS997	21.50"	Assembly	2	1.080"	1.250"	7/8-14	1.080"	1.250"	7/8-14
DS998	20.85"	1 1/4-12R	2	1.080"	1.250"	7/8-14	1.080"	1.250"	7/8-14
DS999	23.44"	1 1/4-12L	2	1.117"	1.250"	7/8-14	1.117"	1.250"	7/8-14
ES2030R	3.12"								
ES3214R	12.40"								

Progressive Size Charts

Illustrated Drag Link Listing - By Length

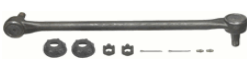

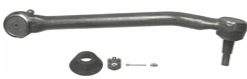







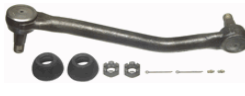







Length	Part Number	Length	Part Number	Length	Part Number
3,12"	ES2030R	14,18"	DS1254	14,75"	DS970
					
12,40"	ES3214R	14,21"	DS1179	14,80"	DS971
					
13,00"	DS1136	14,21"	DS1185	15,27"	DS963
					
13,18"	DS1253	14,44"	DS977	15,28"	DS973
					
14,08"	DS972	14,45"	DS974	15,32"	DS659
					
14,13"	DS969	14,45"	DS976	15,50"	DS584
					

Illustrated Drag Link Listing - By Length

















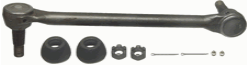

Length	Part Number	Length	Part Number	Length	Part Number
15,75"	DS1273	16,49"	DS952	16,85"	DS1278
					
15,85"	DS945	16,50"	DS1302	16,89"	DS1044
					
16,12"	DS1033	16,64"	DS800	16,89"	DS1067
					
16,16"	DS803	16,75"	DS835	17,00"	DS1064
					
16,25"	DS733	16,75"	DS929	17,02"	DS872
					
16,27"	DS1020	16,84"	DS1034	17,13"	DS1022
					

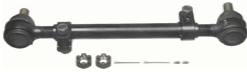
Progressive Size Charts

Illustrated Drag Link Listing - By Length



















Length	Part Number	Length	Part Number	Length	Part Number
17,20"	DS982	17,53"	DS1265	17,70"	DS941
					
17,37"	DS1031	17,53"	DS1267	17,82"	DS938
					
17,40"	DS1027	17,62"	DS1197	17,82"	DS939
					
17,47"	DS1215	17,65"	DS1021	17,88"	DS1028
					
17,48"	DS1217	17,68"	DS1214	17,90"	DS988
					
17,53"	DS1198	17,70"	DS910	17,91"	DS1270
					

Illustrated Drag Link Listing - By Length



















Length	Part Number	Length	Part Number	Length	Part Number
17,93"	DS986	18,21"	DS1447	18,47"	DS1370
					
17,96"	DS1281	18,21"	DS1448	18,50"	DS1199
					
17,96"	DS987	18,24"	DS1442	18,58"	DS1200
					
18,03"	DS908	18,38"	DS1024	18,65"	DS1445
					
18,14"	DS979	18,42"	DS1446	18,72"	DS1340
					
18,20"	DS991	18,45"	DS1305	18,74"	DS954
					

Progressive Size Charts

Illustrated Drag Link Listing - By Length



















Length	Part Number	Length	Part Number	Length	Part Number
18,89"	DS946	19,29"	DS1283	20,28"	DS1277
					
19,01"	DS1371	19,39"	DS845	20,30"	DS1192
					
19,23"	DS1204	19,43"	DS1272	20,44"	DS1259
					
19,23"	DS949	19,43"	DS1369	20,65"	DS1216
					
19,25"	DS948	19,47"	DS1271	20,66"	DS1191
					
19,29"	DS1190	19,88"	DS958	20,85"	DS998
					

Illustrated Drag Link Listing - By Length



















Length	Part Number	Length	Part Number	Length	Part Number
21,20"	DS1366	23,78"	DS881	25,82"	DS867
					
21,50"	DS997	24,08"	DS1264	26,05"	DS880
					
22,47"	DS685	24,12"	DS1195	26,83"	DS1443
					
22,61"	DS1269	24,12"	DS1196	27,31"	DS995
					
22,61"	DS1409	24,80"	DS930	27,45"	DS1444
					
23,44"	DS999	24,99"	DS1298	27,56"	DS1291A
					

Progressive Size Charts

Illustrated Drag Link Listing - By Length







Length	Part Number	Length	Part Number	Length	Part Number
27,75"	DS300001	29,44"	DS1276	31,85"	DS1337
					
28,25"	DS1454	29,91"	DS1263	31,93"	DS944
					
28,87"	DS1218	30,56"	DS994	32,03"	DS1275
					
29,01"	DS1294A	31,47"	DS300002	32,22"	DS983
					
29,13"	DS1182	31,50"	DS1350	32,53"	DS1266
					
29,20"	DS1295A	31,69"	DS1180	32,53"	DS1268
					

Illustrated Drag Link Listing - By Length

Length	Part Number	Length	Part Number	Length	Part Number
32,58"	DS1274	34,62"	DS1344	36,31"	DS943
					
32,61"	DS1221	34,70"	DS1299A	36,63"	DS953
					
32,62"	DS1207	35,00"	DS1205	37,07"	DS1035
					
32,65"	DS1030	35,37"	DS956	37,13"	DS1234
					
32,85"	DS1303	35,61"	DS955	37,18"	DS1313
					
33,88"	DS1293	36,15"	DS1203	41,29"	DS1025
					

Progressive Size Charts

Illustrated Drag Link Listing - By Length

Length	Part Number	Length	Part Number	Length	Part Number
41,29"	DS1026				
					
44,29"	DS1184				
					
55,49"	DS1380S				
					
58,63"	DS1363S				
					
65,80"	DS1367A				
					
66,03"	DS1368A				
					

Interchanges

A/C Delco	Moog No.	A/C Delco	Moog No.	A/C Delco	Moog No.	A/C Delco	Moog No.	Autocar	Moog No.
45A0001	ES26L	45A0732	ES2090L	45B1069	DS1026	45F0131	8560B	836687	8386B
45A0002	ES26R	45B0001	DS584	45B1070	DS983	45F0132	8571B	836687	8386N
45A0003	ES158L	45B0007	DS659	45B1071	DS1025	45F0133	8577B	857328	8386B
45A0004	ES158R	45B0009	DS733	45B1082	DS1182	45F0137	8585B	857328	8386N
45A0008	ES150L	45B0012	DS800	45B1083	DS1184	45F0138	8579B	859552	8514B
45A0009	ES150R	45B0014	DS803	45B1087	DS1180	45F0140	8581B	859552	8514N
45A0010	ES176L	45B0016	DS982	45B1089	DS1205	45F0142	8581N	872469	ES187R
45A0011	ES176R	45B0018	DS988	45B1090	DS1206	45F0143	8583B	872470	ES187L
45A0012	ES187L	45B0021	DS910	45B1091	DS1207	45F0144	8583N	887783A	ES431L
45A0013	ES187R	45B0024	DS845	45B1100	DS1219	45F0145	8567N	887783A	ES431R
45A0014	ES235L	45B0025	DS872	45F0000	8459B	45F0147	8456B	887784A	ES2040R
45A0015	ES235R	45B0026	DS873	45F0000	8471B	45F0147	8587B	887784A	ES431L
45A0018	ES262L	45B0033	DS908	45F0005	8492B	45F0148	8587N	887784A	ES431R
45A0019	ES262R	45B0044	DS991	45F0007	8491B	45F0150	8601B	R200153	8474B
45A0024	ES304L	45B0047	DS997	45F0009	8500B	45F0151	8593B	R200167	8489N
45A0025	ES304R	45B0048	DS998	45F0013	8207B	45F0152	8592B	R200172	8489B
45A0031	ES323L	45B0053	DS952	45F0023	8336B	45F0153	8590B	R200198	8571B
45A0032	ES323R	45B0054	DS970	45F0031	8375B	45F0155	8605B	R230066	ES346R
45A0033	ES330L	45B0056	DS969	45F0038	8385B	45F0158	8610B	R230067	ES346L
45A0034	ES330R	45B0057	DS987	45F0040	8389B	45F0159	8612B	R230074	ES2200L
45A0035	ES332L	45B0058	DS941	45F0042	8386B	45F0160	8613B	R230075	ES2201R
45A0036	ES332R	45B0059	DS946	45F0045	8426B	45F0161	8611B	R230090	ES3312R
45A0042	ES346L	45B0060	DS986	45F0049	8428B	45F0162	8617B	R230091	ES3031L
45A0042	ES376L	45B0061	DS979	45F0051	8462B	45F0163	8618C	R230092	ES3030R
45A0043	ES346R	45B0064	DS949	45F0055	8458B	45F0164	8631C	Autospecialty	Moog No.
45A0043	ES376R	45B0066	DS999	45F0057	8519B	45F0172	8633C	0381005	ES416R
45A0059	ES373L	45B0067	DS1044	45F0060	8454B	45F0173	8639B	0381034	ES416L
45A0060	ES373R	45B0068	DS945	45F0061	8479B	45F0174	8643B	0382035	ES323L
45A0091	ES411L	45B0069	DS958	45F0061	8507B	45F0175	8641B	0382036	ES323R
45A0096	ES416L	45B0070	DS973	45F0062	8386N	45F0178	8637B	0382039	ES2062R
45A0097	ES416R	45B0071	DS971	45F0063	8519N	45F0179	80063C	0386017	ES330L
45A0099	ES423L	45B0073	DS977	45F0064	8479N	45F0180	8645B	0386018	ES330R
45A0100	ES423R	45B0074	DS948	45F0064	8507N	45F0183	8647B	0386019	ES332L
45A0115	ES2040R	45B0077	DS1064	45F0067	8357B	45F0184	8631B	0386020	ES332R
45A0115	ES431L	45B0078	DS1034	45F0068	8527B	45F0194	8659B	0386029	ES3026L
45A0117	ES405L	45B0091	DS938	45F0069	8474B	AMC	Moog No.	0386030	ES3027R
45A0118	ES405R	45B0092	DS939	45F0071	8454N	0943650	ES235L	0387016	ES2082R
45A0191	ES2035L	45B0093	DS1033	45F0074	8488B	0943685	ES235R	0387017	ES2083L
45A0192	ES2036R	45B0094	DS1020	45F0074	8609B	52007118	DS1253	0387023	ES158L
45A0212	ES2061L	45B0095	DS974	45F0078	8484T	J0943650	ES235L	0387024	ES158R
45A0213	ES2062R	45B0096	DS972	45F0079	8489N	J0943685	ES235R	0387037	ES262R
45A0224	ES2083L	45B0100	DS1028	45F0081	8357N	Autocar	Moog No.	0387038	ES262L
45A0225	ES2082R	45B0102	DS976	45F0082	8462N	027091941	8553B	0388002	ES150R
45A0226	ES2091R	45B0104	DS954	45F0083	8445B	1715447	8514B	0388003	ES150L
45A0226	ES2209R	45B0109	DS1185	45F0086	8492N	1715447	8514N	0388004	ES26L
45A0227	ES2090L	45B0110	DS1190	45F0087	8491N	1739844	8518B	0388005	ES26R
45A0227	ES2210L	45B0117	DS1179	45F0088	8343B	1739844	8518N	0388006	ES176L
45A0337	ES194R	45B0119	DS1204	45F0088	8490T	27091941	8553B	1385415	DS685
45A0338	ES194L	45B0130	DS1214	45F0092	8500N	32023	ES2090L	1386402	DS584
45A0345	ES2114R	45B0131	DS1215	45F0096	8445N	340245002	ES2091R	1387405	DS881
45A0346	ES2116L	45B0132	DS1216	45F0098	8503B	340245002	ES2204R	Barcap	Moog No.
45A0346	ES431R	45B0133	DS1217	45F0098	8567B	340245002	ES2209R	A4004	8343B
45A0363	ES2614R	45B1000	DS685	45F0105	8514B	37019	ES423R	A4041	8428B
45A0364	ES2613L	45B1028	DS867	45F0106	8489B	37020	ES423L	A4052	8458B
45A0397	ES2224L	45B1031	DS881	45F0108	8518N	370240004	ES423L	A4057	8456B
45A0397	ES434L	45B1039	DS930	45F0109	8518B	370240004	ES423R	A4058	8454B
45A0398	ES2225R	45B1042	DS996	45F0110	8514N	370240005	ES423R	A4068	8492N
45A0404	ES2207R	45B1043	DS995	45F0115	8553B	37024004	ES423L	A4079	8375B
45A0405	ES2208R	45B1044	DS992	45F0116	8560N	37024005	ES423R	A4080	8357B
45A0441	ES3026L	45B1045	DS994	45F0117	8562N	370245001	ES2090L	A4082	8389B
45A0442	ES3027R	45B1046	DS993	45F0120	8568B	370245001	ES2210L	A4083	8385B
45A0443	ES3032R	45B1056	DS953	45F0124	8570N	370245002	ES2091R	A4087	8386B
45A0611	ES3086L	45B1063	DS943	45F0125	8570B	370245002	ES2209R	A4089	8462B
45A0701	ES3476	45B1064	DS944	45F0128	8572B	370250004	ES423L	A4090	8519B
45A0702	ES3477	45B1065	DS955	45F0129	8573B	370255001	ES2210L	A4092	8507B
45A0731	ES2091R	45B1066	DS956	45F0130	8562B				

Interchanges

Barcap	Moog No.	Beck/Arnley	Moog No.	BWP	Moog No.	Chrysler	Moog No.	Dana	Moog No.
A4094	8386N	1010859	ES405R	M2325	8645B	1879443	ES158R	140TR109	ES3217L
A4096	8492N	1011030	DS977	M2326	8514B	2196044	8474B	140TR110	ES3218R
A4097	8491B	1014133	DS977	M2327	8514N	2275521	8456B	140TR111	ES3219L
A4098	8488B	Bluebird Moog No.		M2331	8553B	2275522	8454B	140TR112	ES3220R
A4099	8514B			M2332	8567B	2275522	8454N	220KK100	80074B
A4115	8519N	61110153	ES423R	M2333	8567N	2275523	8454N	220TR115	ES431L
A4121	8507B	61110154	ES423L	M2334	8568B	2585607	ES376L	220TR116	ES431R
A4122	8462N	R200195	8590B	M2335	8570N	2585608	ES376R	2621012	8490T
A4123	8357N	R201309	80063C	M2336	8518B	2808618	8489B	2621013	8459B
A4124	8445B	R201310	8611B	M2338	8573B	2808618	8489N	2621013	8471B
A4126	8507N	R230068	ES423L	M2339	8571B	3634206	ES2040R	2621016	8492B
A4127	8489N	R230069	ES423R	M2340	8572B	3634206	ES431R	2621017	8491B
A4129	8491N	R230090	ES3312R	M2341	8577B	3634207	ES431L	2621018	8500B
A4152	8500N	Brockway Moog No.		M2342	8579B	3744496	ES423R	2621019	8567N
A4154	8519B	887783A	ES431L	M2343	8581B	3744497	ES423L	2621275	8336B
A4158	8445N	887784A	ES431R	M2344	8581N	3780538	8560B	2621307	8456B
A4160	8567B	R200021	8519B010	M2345	8583N	3780538	8560N	2621336	8375B
A4162	8514B	R200142	8519B	M2346	8592B	3780538	8562B	2621337	8454B
A4170	8500B	R200153	8474B	M2347	8601B	3780538	8562N	2621360	8385B
A4171	8454N	R200154	8519N	M2348	8590B	3780539	8562B	2621361	8389B
A4173	8503B	R200156	8514N	M2349	8605B	3780539	8562N	2621364	8386B
A4174	8645B	R200157	8514B	M2350	8613B	3780543	DS880	2621366	8375B
A4175	8484T	R200167	8489N	M2352	8518N	3780544	DS867	2621386	8426B
A4177	8519B	R200168	8518N	M2353	8593B	3786544	DS867	2621391	8503B
A4179	8514B	R200170	8518B	M2354	8579B	3821771	ES304L	2621406	8462B
A4186	8571B	R200172	8489B	M2357	8577B010	3838004	ES176R	2621407	80059B
A4189	8553B	R200195	8590B	M2358	8612B	3838005	ES176L	2621413	8458B
A4190	8560N	R200198	8571B	M2363	8507B	3838006	ES194R	2621414	8519B
A4191	8562N	R200199	8553B	M2370	8570B	3838006	ES2082R	2621417	8454B
A4194	8568B	R230060	ES187L	M2371	8560N	3838007	ES194L	2621418	8456B
A4195	8570N	R230061	ES187L	M2372	8587N	3838007	ES2083L	2621421	8479B
A4196	8570B	R230061	ES187R	M2373	8583B	4026505	DS881	2621422	8386N
A4197	8571B	R230066	ES346R	M2379	8610B	4026848	8587B	2621425	8519N
A4198	8572B	R230067	ES346L	M2380	8617B	4026848	8587N	2621431	8479N
A4199	8573B	R230068	ES423L	Case Moog No.		4115720	ES194R	2621440	8357B
A4200	8560B	R230069	ES423R	384006R1	ES235R	4115720	ES2082R	2621443	8527B
A4201	8562B	R230070	ES431R	Chrysler Moog No.		4115721	ES194L	2621452	8454N
A4204	8503B	R230071	ES431L	1238394	ES194L	4115721	ES2083L	2621460	8474B
A4205	8577B	R230072	ES2090L	1238394	ES2083L	4131309	DS930	2621461	8488B
A4208	8581B	R230073	ES2091R	1238394	ES2083L	4131318	ES194R	2621462	8491B
A4209	8581N	R230074	ES2200L	1238395	ES194R	4131318	ES2082R	2621464	8489N
A4210	8583B	R230075	ES2201R	1238395	ES2082R	4131319	ES194L	2621466	8357N
A4211	8583N	R230090	ES3312R	1238404	ES158L	4131319	ES2083L	2621467	8462N
A4213	8585B	R230091	ES3031L	1238405	ES158R	4176394	8560B	2621470	8445B
A4216	8592B	R230092	ES3030R	1238406	ES176R	4176394	8560N	2621472	8492N
A4217	8593B	BWP Moog No.		1243756	ES176L	4206505	DS881	2621473	8491N
A4218	8601B	M2300	8490T	1311175	ES158L	951303	ES158L	2621475	8490T
BATCO Moog No.		M2301	8375B	1321101	ES187R	Clark Moog No.		2621483	8500N
171060	8581B	M2303	8389B	1643174	8386B	103227	ES176R	2621489	8445N
171061	8581N	M2304	8385B	1643174	8386N	103228	ES176L	2621490	80053B
171140	8514B	M2305	8386B	1643277	ES187R	263498C91	ES235L	2621491	8503B
171141	8514N	M2306	8462B	1643278	ES187L	263499C91	ES235R	2621491	8567B
171150	8567B	M2307	8458B	1752309	8454B	61556R91	8375B	2621506	8514B
171151	8567N	M2309	8386N	1752310	8456B	Dana Moog No.		2621507	8489B
171158	8489B	M2310	8488B	1795584	ES176L	080TR116	ES3204L	2621512	8518N
171159	8489N	M2311	8519N	1818726	8519B	080TR117	ES3205R	2621513	8518B
171164	8572B	M2312	8519B	1818726	8519N	097TR102	ES3294R	2621514	8514B
171172	8553B	M2315	8489N	1818854	ES304R	101KK111	8637B	2621525	8553B
171174	8590B	M2316	8491N	1818855	ES304L	101KK111	8637C	2621532	8562N
171178	8518B	M2317	8491B	1843208	8479B	101KK113	8577B	2621537	8568B
171179	8518N	M2318	8492N	1843208	8479N	120KK100	8655B	2621548	8570B
171180	8571B	M2319	8492B	1843208	8507B	120KK100	8655C	2621550	8572B
171230	8386B	M2320	8500N	1843208	8507B010	120KK102	8006C	2621550	8573B
171231	8386N	M2321	8500B	1843208	8507N	120TR109	ES423L	2621551	8573B
171260	8601B	M2322	8489B	1879442	ES158R	140KK100	8657B	2621554	8571B
171294	8613B	M2324	8503B						

Interchanges

Interchanges

Dana	Moog No.	Dana	Moog No.	Dana	Moog No.	Dayton Parts (hd)	Moog No.	Dayton Parts (hd)	Moog No.
2621555	8577B	2692244	ES423R	2721595	DS958	300115	8357B	300222	8581N
2621556	8572B	2692311	ES431L	2721596	DS973	300118	8389B	300223	8583B
2621556	8585B	2692312	ES431R	2721597	DS971	300119	8441B	300224	8583N
2621557	8579B	2692314	ES405L	2721599	DS977	300120	8385B	300226	8587B
2621558	8581B	2692315	ES405R	2721600	DS948	300121	8385B015	300227	8585B
2621559	8581N	2692432	ES2030R	2721602	DS1067	300123	8426B	300229	8592B
2621560	8583B	2692437	ES2035L	2721603	DS1064	300124	8428B	300230	8593B
2621561	8583N	2692438	ES2036R	2721604	DS1034	300125	8386B	300231	8601B
2621562	8567N	2692466	ES2061L	2721605	DS1021	300128	8462B	300232	8590B
2621564	8587B	2692467	ES2062R	2721608	DS1203	300129	8458B	300233	8613B
2621565	8454N	2692474	ES405R	2721609	DS963	300130	8458B010	300234	80055B
2621565	8587N	2692475	ES405L	2721619	DS1033	300133	8459B	300235	8605B
2621569	8601B	2692483	ES2083L	2721623	DS1022	300134	8459B	300236	80056B
2621570	8593B	2692484	ES2082R	2721629	DS976	300134	8471B	300238	8577B010
2621571	8592B	2692485	ES2091R	2721644	DS1185	300135	8456B	300240	8612B
2621572	8590B	2692486	ES2090L	2721645	DS1190	300136	8454B	300241	8491B010
2621574	8613B	2692635	ES2082R	2721646	DS1191	300137	8454N	300245	80058B
2621575	80056B	2692636	ES2083L	2721647	DS1192	300140	8479B	300248	8610B
2621576	8605B	2692644	ES431R	2721648	DS1197	300140	8507B	300248	8610C
2621577	80055B	2692663	ES2614R	2721649	DS1198	300142	8527B	300249	8617B
2621579	8610B	2692664	ES2613L	2721650	DS1199	300143	8474B	300250	8581B002
2621580	8612B	2692700	ES2224L	2721651	DS1200	300150	8386N	300255	8562B
2621582	8613B	2692700	ES434L	2721652	DS1179	300152	8484T	300257	80059B
2621583	8611B	2692701	ES2225R	2721654	DS1204	300155	8488B	300257	8618C
2621584	8617B	2692702	ES2257R	2724020	DS685	300156	8488B010	300258	8631C
2621585	8618C	2692703	ES2200L	2724089	DS880	300158	8519N	300260	8639B
2621586	8631C	2692704	ES2201R	2724095	DS867	300159	8519B	300262	8643B
2621589	80057B	2692705	ES2203R	2724103	DS881	300163	8462N	300263	8641B
2621591	80058B	2692710	ES2208R	2724116	DS930	300164	8357N	300264	8611B
2621592	80063C	2692751	ES3026L	2724122	DS996	300165	8445B	300266	80063C
2621594	8633C	2692752	ES3027R	2724123	DS995	300170	8479N	300267	8633C
2621597	8639B	2692753	ES3032R	2724124	DS992	300170	8507N	300268	8637B
2621603	8637B	2695098	ES3030R	2724125	DS994	300171	8489N	300268	8637C
2621604	80063C	2695099	ES3031L	2724126	DS993	300172	8491N	300270	8645B
2692003	ES26L	2695100	ES3039L	2724148	DS908	300173	8491B	300271	8655C
2692004	ES26R	2695101	ES3040R	2724148	DS953	300174	8492N	300274	8647B
2692007	ES158L	2721010	DS659	2724156	DS943	300175	8492B	300275	8631B
2692008	ES158R	2721014	DS733	2724157	DS944	300179	8500N	300276	8655B
2692022	ES150L	2721020	DS800	2724158	DS955	300180	8500B	300276	8655C
2692023	ES150R	2721022	DS803	2724159	DS956	300181	8500B010	300277	80070C
2692032	ES176L	2721029	ES434L	2724162	DS1026	300182	8489B	300277	8657B
2692033	ES176R	2721031	DS835	2724177	DS1182	300186	8445N	300278	80074B
2692041	ES187L	2721033	DS982	2724178	DS1184	300187	80053B	300278	80075C
2692042	ES187R	2721036	DS988	2724180	DS1195	300188	8503B	300281	80068C
2692051	ES235L	2721131	DS910	2724182	DS1180	300194	80066B	300282	8637C
2692052	ES235R	2721134	DS845	2724183	DS1203	300195	8514B	300283	8633B
2692097	ES304L	2721135	DS872	2724184	DS1205	300196	8514N	300284	80063B
2692098	ES304R	2721136	DS873	2724186	DS1207	300204	8553B	300286	8653B
2692124	ES323L	2721150	DS908	309KK102	8610B	300205	8567B	300287	8659B
2692125	ES323R	2721174	DS1064	309KK102	8610C	300206	8567N	300288	8660B
2692128	ES325L	2721203	DS991	309KK103	8610B	300207	8386N	300289	8661B
2692129	ES325R	2721210	DS929	70TR113	ES423R	300207	8568B	300292	80069B
2692138	ES330L	2721211	DS997	70TR114	ES423L	300208	8570N	300293	80076B
2692139	ES330R	2721212	DS998	77TR124	ES176R	300209	8570B	300294	80077B
2692142	ES332L	2721575	DS952	80TR116	ES3204L	300210	8518B	300295	80078C
2692143	ES332R	2721576	DS970	80TR117	ES3205R	300211	8518N	300298	8006C
2692158	ES346L	2721578	DS969	970579	ES800423	300212	8562N	300300	80071C
2692158	ES431R	2721579	DS987	970580	ES800422	300213	8560N	300301	80072B
2692159	ES346R	2721580	DS941	971136	ES800425	300215	8573B	300302	80073C
2692159	ES431L	2721581	DS946	971137	ES800424	300216	8571B	300304	8005C
2692159	ES431R	2721582	DS986	H506993	ES3216R	300217	8572B	300306	8004C
2692189	ES373L	2721583	DS979	SP692645	ES2040R	300218	8577B	300310	8007C
2692190	ES373R	2721590	DS949	Dayton Parts (hd)	Moog No.	300218	8577C	300319	8001C
2692234	ES411L	2721592	DS999	300103	8336B	300219	8587N	300320	8002C
2692235	ES411R	2721593	DS1044	300107	8490T	300220	8579B	300322	8003C
2692243	ES423L	2721594	DS945	300110	8375B	300221	8581B	300336	8008C

Interchanges

Dayton Parts (hd)	Moog No.	Dayton Parts (hd)	Moog No.	Dayton Parts (hd)	Moog No.	Dayton Parts (hd)	Moog No.	Dayton Parts (hd)	Moog No.
300372	8002C	310284	ES2091R	310486	ES3178R	346290	DS1033	346454	DS1302
310100	ES26L	310285	ES3298L	346100	DS1234	346293	DS1034	346455	DS1291A
310101	ES26R	310286	ES3297R	346111	DS659	346296	DS1027	346456	DS1281
310104	ES158L	310290	ES434L	346113	DS685	346297	DS1028	346458	DS1303
310105	ES158R	310291	ES2113R	346118	DS733	346299	DS1030	346461	DS1305
310112	ES150L	310292	ES2114R	346142	DS800	346300	DS1031	346464	DS1299A
310113	ES150R	310292	ES434L	346144	DS803	346305	DS1035	346465	DS1295A
310115	ES176L	310293	ES434L	346157	DS835	346310	DS1044	346466	DS1294A
310116	ES176R	310294	ES2116L	346167	DS845	346338	DS1136	347320	DS1379S
310121	ES187L	310313	ES2200L	346171	DS867	346339	DS1067	347321	DS1379S
310122	ES187R	310314	ES2201R	346176	DS872	346340	DS1190	410433	ES2091L
310129	ES235L	310315	ESK371	346177	DS873	346341	DS1191	410434	ES2091R
310130	ES235R	310317	ES2203R	346182	DS880	346342	DS1192	Diamond-T	Moog No.
310133	ES262L	310318	ES2091R	346188	DS1064	346345	DS1203	35180J	ES187R
310134	ES262R	310318	ES2204R	346189	DS908	346346	DS1195	5180H	ES194R
310142	ES304L	310321	ES2207R	346190	DS910	346347	DS1196	5180H	ES2082R
310143	ES304R	310322	ES2208R	346201	DS929	346348	DS1197	5181H	ES194L
310154	ES323L	310322	ES346L	346208	DS938	346349	DS1198	5181H	ES2083L
310155	ES323R	310323	ES2209R	346209	DS939	346350	DS1199	55181F	ES325L
310158	ES325L	310324	ES2090L	346211	DS941	346351	DS1200	65181F	ES187L
310159	ES325R	310324	ES2210L	346213	DS943	346370	DS1179	6518F	ES187L
310160	ES330L	310326	ES2224L	346214	DS944	346371	DS1180		
310161	ES330R	310327	ES2225R	346215	DS945	346373	DS1182	Eaton	Moog No.
310164	ES332L	310327	ES434L	346216	DS946	346375	DS1184	1006148	ES423L
310165	ES332R	310329	ES2257R	346218	DS948	346376	DS1185	1006149	ES423R
310169	ES346L	310350	ES3086L	346219	DS949	346379	DS1204	1008500	8633B
310169	ES346R	310351	ES3087R	346222	DS952	346383	DS1207	1008500	8633C
310170	ES346L	310380	ES2613L	346223	DS953	346384	DS1214	1009009	ES3298L
310170	ES346R	310381	ES2614R	346224	DS954	346385	DS1215	1009010	ES3297R
310183	ES373L	310392	ES3026L	346225	DS955	346386	DS1218	806355	8618C
310184	ES373R	310393	ES3027R	346226	DS956	346387	DS1219	806355	8647B
310188	ES376L	310395	ES3030R	346227	DS1205	346388	DS1220	806356	8631B
310189	ES376R	310396	ES3031L	346228	DS958	346389	DS1221	806356	8631C
310189	ES431R	310397	ES2090L	346233	DS963	346390	DS1234	811525	8633C
310208	ES405L	310398	ES2091R	346239	DS969	346400	DS1216	815122	ES2090L
310209	ES405R	310399	ES3032R	346240	DS970	346401	DS1217	815122	ES2210L
310215	ES411L	310421	ES3039L	346241	DS971	346404	DS1259	815123	ES2091R
310216	ES3220R	310422	ES3040R	346242	DS972	346405	DS1265	815123	ES2204R
310216	ES411R	310425	ES431R	346243	DS973	346406	DS1266	815123	ES2209R
310220	ES416L	310433	ES2090L	346244	DS974	346407	DS1267	816310	ES2090L
310221	ES416R	310434	ES2091R	346246	DS976	346408	DS1268	816310	ES2210L
310222	ES3217L	310435	ES3252R	346247	DS977	346409	DS1269	816311	ES2091R
310222	ES423L	310436	ES3312R	346249	DS979	346410	DS1270	816311	ES2204R
310223	ES3218R	310437	ES3204L	346252	DS982	346411	DS1271	816311	ES2209R
310223	ES423R	310438	ES3205R	346253	DS983	346412	DS1272	817018	ES3477
310228	ES431L	310455	ES3476	346256	DS986	346413	DS1369	817019	ES3476
310228	ES431R	310456	ES3477	346257	DS987	346414	DS1370	818471	ES2091R
310229	ES2040R	310459	ES431L	346258	DS988	346415	DS1371	818471	ES2204R
310229	ES431L	310460	ES431R	346261	DS991	346416	DS1409	818471	ES2209R
310229	ES431R	310465	ES3329L	346262	DS992	346417	DS1277	818472	ES2090L
310230	ES434L	310466	ES3328R	346263	DS993	346418	DS1278	818472	ES2210L
310264	ES2030R	310467	ES3274L	346264	DS994	346419	DS1274	820626	ES2090L
310266	ES2035L	310468	ES3275R	346265	DS995	346420	DS1275	820626	ES2210L
310267	ES2036R	310469	ES3270L	346266	DS996	346421	DS1276	820627	ES2091R
310268	ES376R	310470	ES3271R	346267	DS997	346423	DS1337	820627	ES2204R
310268	ES431R	310471	ES3177L	346268	DS998	346425	DS1340	820627	ES2209R
310269	ES376L	310472	ES3176R	346273	DS999	346429	DS1344	820694	ES2090L
310271	ES2061L	310473	ES3284L	346277	DS881	346436	DS1350	820694	ES2210L
310272	ES2062R	310474	ES3283R	346278	DS930	346436	DS1366	820695	ES2091R
310277	ES405R	310475	ES3268L	346279	DS1020	346446	DS1442	823078	80076B
310278	ES405L	310476	ES3269R	346279	ES3214R	346447	DS1443	824530	80077B
310281	ES194R	310481	ES3442R	346281	DS1021	346448	DS1444	824920	80078C
310281	ES2082R	310482	ES3443L	346282	DS1022	346449	DS1445	924920	80078C
310282	ES194L	310483	ES3442R	346286	DS1024	346450	DS1446	DL2345	DS992
310282	ES2083L	310484	ES3443L	346287	DS1025	346451	DS1447	DL2346	DS993
310283	ES2090L	310485	ES3216R	346288	DS1026	346452	DS1448	DL2347	DS994

Interchanges

Interchanges

Eaton	Moog No.	Eaton	Moog No.	Eaton	Moog No.	Elgin	Moog No.	Elgin	Moog No.
DL2348	DS998	KP2315	8572B	TE2030	ES423R	KB471	8375B	KB816	8579B
DL2351	DS1020	KP2316	8573B	TE2033	ES2035L	KB471A	8386B	KB817	8581B
DL2356	DS971	KP2317	8570N	TE2034	ES2036R	KB471A	8456B	KB817N	8581N
DL2357	DS973	KP2318	8570B	TE2035	ES2061L	KB472A	8454B	KB818	8583B
DL2358	DS974	KP2320	8577B	TE2036	ES2062R	KB472AN	8454N	KB818N	8583N
DL2359	DS976	KP2321	8585B	TE2037	ES405L	KB477A	8479B	KB819	8585B
DL2360	DS979	KP2322	8579B	TE2038	ES405R	KB477AN	8479N	KB823	8590B
DL2362	DS1025	KP2323	8581B	TE2039	ES194R	KB477ANR	8479N	KB827	8592B
DL2362	DS1026	KP2324	8581N	TE2039	ES2082R	KB477ANR	8507N	KB828	8593B
DL2363	DS1025	KP2325	8583B	TE2040	ES194L	KB477AR	8479B	KB829	8601B
DL2363	DS1026	KP2326	8583N	TE2040	ES2083L	KB477AR	8507B	KB830	8613B
DL2364	DS1033	KP2327	8590B	TE2041	ES2090L	KB478	8357B	KB832	8605B
DL2449	DS986	KP2328	8592B	TE2041	ES2210L	KB478B	8426B	KB835	8610B
DL2450	DS987	KP2329	8593B	TE2042	ES2091R	KB478N	8357N	KB836	8611B
DL2451	DS953	KP2330	8601B	TE2042	ES2204R	KB478NR	8357N	KB837	8612B
DL2452	DS908	KP2331	8613B	TE2042	ES2209R	KB478R	8357B	KB838	8605B
KP2262	8375B	KP2332	80056B	TE2043	ES2113R	KB479X	8527B	KB840	8617B
KP2263	8375B	KP2333	8605B	TE2043	ES2114R	KB480A	8474B	KB841CB	8618C
KP2264	8385B	KP2334	80055B	TE2043	ES376R	KB491	8484T	KB842CB	8631C
KP2265	8389B	KP2335	80057B	TE2043	ES431R	KB491A	8492B	KB843	8639B
KP2266	8386B	KP2336	80058B	TE2045	ES2116L	KB491AN	8492N	KB844	8643B
KP2268	8462B	KP2337	8610B	TE2047	ES3298L	KB492A	8491B	KB845	8641B
KP2269	8456B	KP2339	8612B	TE2048	ES3297R	KB492A	8491N	KB846CB	8633C
KP2269	8458B	KP2340	8617B	TE2454	ES434L	KB492AN	8491N	KB847	8637B
KP2270	8456B	KP2341	8647B	TE2456	ES2225R	KB493	8488B	KB848CB	80063C
KP2271	8386N	KP2344	8488B	TE2545	ES2224L	KB493010	8488B010	Euclid	Moog No.
KP2272	8527B	KP2344	8609B	Elgin	Moog No.	KB493R	8609B	E10099	DS1278
KP2273	8474B	TE2001	ES26L	DS0685	DS685	KB501	8389B	E10100	DS1277
KP2274	8454B	TE2002	ES26R	DS0907	DS1064	KB501015	8441B	E10101	DS1217
KP2275	8489N	TE2003	ES150L	ES0150L	ES150L	KB501R	8389B	E10102	DS1216
KP2276	8462N	TE2004	ES150R	ES0150R	ES150R	KB501R015	8441B	E10104B	8659B
KP2277	8492N	TE2005	ES176L	ES0176L	ES176L	KB502	8385B	E10105B	8660B
KP2278	8491B	TE2006	ES176R	ES0262L	ES262L	KB502015	8385B015	E10106B	8661B
KP2278	8492B	TE2007	ES187L	ES0262R	ES262R	KB504	8489B	E10108	ES3274L
KP2279	8491N	TE2008	ES187R	ES0323L	ES323L	KB504N	8489N	E10109	ES3275R
KP2280	8491B	TE2009	ES235L	ES0323R	ES323R	KB505A	8514B	E10110	ES3270L
KP2281	8336B	TE2010	ES235R	ES0330L	ES330L	KB505AN	8514N	E10111	ES3271R
KP2281	8490T	TE2011	ES304L	ES0330R	ES330R	KB516	80053B	E10112	ES3268L
KP2282	8490T	TE2012	ES304R	ES0373L	ES373L	KB517	8503B	E10113	ES3269R
KP2283	8492N	TE2013	ES330L	ES0373R	ES373R	KB534B	8553B	E10121	DS1299A
KP2283	8500N	TE2014	ES330R	ES2061L	ES2061L	KB537	8568B	E10137	ES3476
KP2284	8500B	TE2015	ES332L	ES2062R	ES2062R	KB538Bi	8560B	E10138	ES3477
KP2285	80053B	TE2016	ES332R	ES2069R	ES405R	KB538BiR	8560B	E10148	ES3204L
KP2286	8503B	TE2017	ES346R	ES2070L	ES405L	KB538N	8560N	E10149	ES3205R
KP2288	8519N	TE2018	ES346L	KB313	8207B	KB538NR	8560N	E11394B	80076B
KP2289	8479B	TE2019	ES373L	KB325	8567B	KB539Bi	8562B	E11790	DS1442
KP2289	8507B	TE2020	ES373R	KB325N	8567N	KB539BiR	8562B	E11813C	8007C
KP2290	8357N	TE2021	ES2113R	KB401	8426B	KB539N	8562N	E4430B	8490T
KP2290	8479N	TE2021	ES2114R	KB420C	8428B	KB539NR	8562N	E4430BTU	8490T
KP2290	8507N	TE2021	ES376L	KB421	8445B	KB546	8573B	E4431B	8375B
KP2291	8514B	TE2021	ES376R	KB421N	8445N	KB547	8571B	E4431BTU	8375B
KP2292	8489B	TE2021	ES431L	KB423	8336B	KB548	8572B	E4432B	8389B
KP2293	8645B	TE2021	ES431R	KB425	8645B	KB550	8587B	E4432BTU	8389B
KP2294	8519B	TE2022	ES2040R	KB444010	8440B	KB550N	8587N	E4433B	8385B
KP2296	8518N	TE2022	ES2113R	KB450A	8386B	KB571	8500B	E4433B15	8385B015
KP2297	8518B	TE2022	ES2114R	KB450AN	8386N	KB571010	8500B010	E4433B15TU	8385B015
KP2298	8514N	TE2022	ES2116L	KB462	8343B	KB571N	8500N	E4433BTU	8385B
KP2305	8553B	TE2022	ES376L	KB462B	8343B	KB571NR	8500N	E4434B	8386B
KP2307	8560B	TE2022	ES376R	KB462B	8490T	KB571R	8500B	E4434BTU	8386B
KP2308	8560N	TE2022	ES431L	KB463	8462B	KB571R010	8500B010	E4434N	8386N
KP2310	8562B	TE2022	ES431R	KB463N	8462N	KB645	8577B	E4434NTU	8386N
KP2310	8562N	TE2023	ES405L	KB465A	8519B	KB645010	8577B010	E4435B	8462B
KP2311	8567B	TE2024	ES405R	KB465AN	8519N	KB700	8518B	E4435BTU	8462B
KP2312	8567N	TE2027	ES411L	KB466	8458B	KB700N	8518N	E4435N	8462N
KP2313	8568B	TE2028	ES411R	KB470	8459B	KB722	8570B	E4435NTU	8462N
KP2314	8571B	TE2029	ES423L	KB470W	8471B	KB722N	8570N	E4436B	8456B

Interchanges

Euclid	Moog No.	Euclid	Moog No.	Euclid	Moog No.	Euclid	Moog No.	Euclid	Moog No.
E4436BTU	8456B	E4454NTU	8518N	E4609TU	ES405R	E4634TU	ES150L	E5342TU	DS953
E4437B	8454B	E4455N	8562B	E4610	ES187L	E4635	ES150R	E5343	DS954
E4437N	8454N	E4455N	8562N	E4610TU	ES187L	E4635TU	ES150R	E5343TU	DS954
E4437NTU	8454N	E4455NTU	8562B	E4611	ES187R	E4636	ES176L	E5344	DS955
E4438B	8479B	E4455NTU	8562N	E4611TU	ES187R	E4636TU	ES176L	E5344TU	DS955
E4438B	8507B	E4456N	8560N	E4612	ES2061L	E4637	ES176R	E5345	DS956
E4438B10	8507B010	E4456NTU	8560N	E4612TU	ES2061L	E4637TU	ES176R	E5345TU	DS956
E4438BTU	8479B	E4457B	8573B	E4613	ES2062R	E4638	ES194L	E5351	DS963
E4438BTU	8507B	E4457BTU	8573B	E4613TU	ES2062R	E4638	ES2083L	E5357	DS969
E4438N	8479N	E4458B	8571B	E4614	ES423L	E4638TU	ES194L	E5357TU	DS969
E4438N	8507N	E4458BTU	8571B	E4614TU	ES423L	E4638TU	ES2083L	E5358	DS970
E4438NTU	8479N	E4459B	8572B	E4615	ES423R	E4639	ES194R	E5358TU	DS970
E4438NTU	8507N	E4459BTU	8572B	E4615TU	ES423R	E4639	ES2082R	E5359	DS971
E4439B	8474B	E4460B	8577B	E4616	ES2040R	E4639TU	ES194R	E5359TU	DS971
E4439BTU	8474B	E4460B	8577C	E4616	ES2113R	E4639TU	ES2082R	E5360	DS972
E4440B	8488B	E4460BTU	8577B	E4616	ES2114R	E4641	ES2207R	E5360TU	DS972
E4440B	8609B	E4461B	8579B	E4616	ES376L	E4641TU	ES2207R	E5361	DS973
E4440B10	8488B010	E4461BTU	8579B	E4616	ES376R	E4642	ES2208R	E5361TU	DS973
E4440B10TU	8488B010	E4462B	8581B	E4616	ES431R	E4642TU	ES2208R	E5362	DS974
E4440BTU	8488B	E4462BTU	8581B	E4616TU	ES2113R	E4693B	8617B	E5362TU	DS974
E4440BTU	8609B	E4462N	8581N	E4616TU	ES2114R	E4695C	80063C	E5363	DS976
E4441B	8519B	E4462NTU	8581N	E4616TU	ES376R	E4696B	8647B	E5363TU	DS976
E4441BTU	8519B	E4463B	8583B	E4616TU	ES431R	E4696C	8618C	E5364	DS977
E4441N	8519N	E4463BTU	8583B	E4617	ES2116L	E4697B	8610B	E5364TU	DS977
E4441NTU	8519N	E4463N	8583N	E4617	ES376L	E5310	DS800	E5366	DS979
E4442B	8489B	E4463NTU	8583N	E4617	ES431L	E5310TU	DS800	E5366TU	DS979
E4442BTU	8489B	E4464B	8585B	E4617TU	ES2116L	E5311	DS803	E5368	DS982
E4442N	8489N	E4465B	8592B	E4617TU	ES376L	E5311TU	DS803	E5368TU	DS982
E4442NTU	8489N	E4465BTU	8592B	E4617TU	ES431L	E5312	DS835	E5369	DS983
E4443B	8491B	E4466B	8593B	E4618	ES2207R	E5312TU	DS835	E5369TU	DS983
E4443BTU	8491B	E4466BTU	8593B	E4618	ES346L	E5314	DS845	E5372	DS986
E4443N	8491N	E4467B	8601B	E4618TU	ES2207R	E5314TU	DS845	E5372TU	DS986
E4443NTU	8491N	E4467BTU	8601B	E4618TU	ES346L	E5315	DS867	E5373	DS987
E4444BTU	8514B	E4468B	8590B	E4619	ES346R	E5315TU	DS867	E5373TU	DS987
E4444B	8492B	E4468BTU	8590B	E4619TU	ES346R	E5319	DS872	E5374	DS988
E4444BTU	8492B	E4469B	8613B	E4620	ES330L	E5319TU	DS872	E5374TU	DS988
E4444N	8492N	E4469BTU	8613B	E4620TU	ES330L	E5320	DS873	E5377	DS991
E4444NTU	8492N	E4470B	80055B	E4621	ES330R	E5320TU	DS873	E5377TU	DS991
E4445B	8500B	E4470BTU	80055B	E4621TU	ES330R	E5323	DS880	E5378	DS992
E4445BTU	8500B	E4471B	8605B	E4622	ES2035L	E5323TU	DS880	E5378TU	DS992
E4445N	8500N	E4471BTU	8605B	E4622TU	ES2035L	E5325	DS908	E5379	DS993
E4445NTU	8500N	E4472B	80056B	E4623	ES2036R	E5325TU	DS908	E5379TU	DS993
E4446B	80053B	E4473B	8454B	E4623TU	ES2036R	E5326	DS910	E5380	DS994
E4446BTU	80053B	E4595B	8612B	E4624	ES332L	E5326TU	DS910	E5380TU	DS994
E4447B	8503B	E4595BTU	8612B	E4624TU	ES332L	E5330	DS938	E5381	DS995
E4447BTU	8503B	E4598B	8527B	E4625	ES332R	E5330TU	DS938	E5381TU	DS995
E4448B	8645B	E4598BTU	8527B	E4625TU	ES332R	E5331	DS939	E5382	DS996
E4448BTU	8645B	E4599B	80058B	E4628	ES2090L	E5331TU	DS939	E5382TU	DS996
E4449B	8514B	E4600	ES235L	E4628	ES2210L	E5332	DS941	E5383	DS997
E4449N	8514N	E4600TU	ES235L	E4628TU	ES2090L	E5332TU	DS941	E5383TU	DS997
E4449NTU	8514N	E4601TU	ES235R	E4628TU	ES2210L	E5334	DS1206	E5384	DS998
E4450B	8553B	E4602	ES304L	E4629	ES2091R	E5334	DS943	E5384TU	DS998
E4450BTU	8553B	E4602TU	ES304L	E4629	ES2204R	E5334TU	DS1206	E5385	DS999
E4451B	8567B	E4603	ES304R	E4629	ES2209R	E5334TU	DS943	E5385TU	DS999
E4451BTU	8567B	E4603TU	ES304R	E4629TU	ES2091R	E5335	DS944	E5386	DS1020
E4451N	8567N	E4604	ES373L	E4629TU	ES2204R	E5335TU	DS944	E5386TU	DS1020
E4451NTU	8567N	E4604TU	ES373L	E4629TU	ES2209R	E5336	DS945	E5387	DS1025
E4452B	8568B	E4605	ES373R	E4630	ES411L	E5336TU	DS945	E5387TU	DS1025
E4452BTU	8568B	E4605TU	ES373R	E4630TU	ES411L	E5337	DS946	E5388	DS1026
E4453B	8570B	E4606	ES405L	E4631	ES411R	E5337TU	DS946	E5388TU	DS1026
E4453BTU	8570B	E4606TU	ES405L	E4631TU	ES411R	E5338	DS948	E5389	DS1033
E4453N	8570N	E4607	ES405R	E4632	ES26L	E5338TU	DS948	E5389TU	DS1033
E4453NTU	8570N	E4607TU	ES405R	E4632TU	ES26L	E5339	DS949	E5390	DS1034
E4454B	8518B	E4608	ES405L	E4633	ES26R	E5341	DS952	E5390TU	DS1034
E4454BTU	8518B	E4608TU	ES405L	E4633TU	ES26R	E5341TU	DS952	E5391	ES2224L
E4454N	8518N	E4609	ES405R	E4634	ES150L	E5342	DS953	E5391	ES434L

Interchanges

Interchanges

Euclid	Moog No.	Euclid	Moog No.	Euclid	Moog No.	Euclid Industries	Moog No.	Euclid Industries	Moog No.
E5391TU	ES2224L	E6818TU	DS1179	E6868BTU	8611B	E10104B	8659B	E4595B	8612B
E5391TU	ES434L	E6819	DS1180	E6869C	8631C	E10105B	8660B	E4598B	8527B
E5392	ES2030R	E6819TU	DS1180	E6869CTU	8631C	E10106B	8661B	E4600	ES235L
E5392TU	ES2030R	E6821	DS1182	E6876C	80066B	E10108	ES3274L	E4601	ES235R
E5393	ES2113R	E6821TU	DS1182	E6876CTU	80066B	E10109	ES3275R	E4602	ES304L
E5393	ES2114R	E6823	DS1184	E6878	DS1031	E10110	ES3270L	E4603	ES304R
E5393	ES376R	E6823TU	DS1184	E6878TU	DS1031	E10111	ES3271R	E4604	ES373L
E5393	ES431R	E6824	DS1185	E6997	DS1136	E10112	ES3268L	E4605	ES373R
E5396	ES2116L	E6824TU	DS1185	E6997TU	DS1136	E10113	ES3269R	E4606	ES405L
E5396	ES376L	E6826	DS1190	E8732	DS1454	E4430B	8490T	E4607	ES405R
E5396	ES431L	E6826TU	DS1190	E8757	ES3298L	E4431B	8375B	E4608	ES405L
E5401	ES2224L	E6827	DS1191	E8758	ES3297R	E4432B	8399B	E4609	ES405R
E5401TU	ES2224L	E6827TU	DS1191	E9881	ES3252R	E4433B	8385B	E4610	ES187L
E5402	ES2225R	E6828	DS1192	E9891	DS1220	E4433B15	8385B015	E4611	ES187R
E5402TU	ES2225R	E6828TU	DS1192	E9893	DS1221	E4434B	8386B	E4612	ES2061L
E5440B	80057B	E6829	DS1195	E9895	DS1340	E4434N	8386N	E4613	ES2062R
E5441B	80059B	E6829TU	DS1195	E9896	DS1274	E4435B	8462B	E4614	ES423L
E5468	DS958	E6830	DS1196	E9897	DS1218	E4435N	8462N	E4615	ES423R
E5468TU	DS958	E6830TU	DS1196	E9898	DS1219	E4436B	8456B	E4616	ES431R
E5469	ES2613L	E6831	DS1197	E9900	DS1344	E4437B	8454B	E4617	ES376R
E5469TU	ES2613L	E6831TU	DS1197	E9901	DS1275	E4437N	8454N	E4618	ES346L
E5470	ES2614R	E6832	DS1198	E9903	DS1276	E4438B	8507B	E4619	ES346R
E5470TU	ES2614R	E6832TU	DS1198	E9903	DS1303	E4438N	8507N	E4620	ES330L
E5484C	8633C	E6833	DS1199	E9906	DS1254	E4439B	8474B	E4621	ES330R
E5488C	8637B	E6833TU	DS1199	E9907	DS1253	E4440B	8488B	E4622	ES2036R
E6135	ES3086L	E6834	DS1200	E9910	DS1293	E4440B10	8488B010	E4623	ES2035L
E6136	ES3087R	E6834TU	DS1200	E9914	DS1281	E4441B	8519B	E4624	ES332L
E6194B	8633B	E6835	DS1203	E9917	DS1298	E4441N	8519N	E4625	ES332R
E6194B	8633C	E6835TU	DS1203	E9918	DS1302	E4442B	8489B	E4628	ES2090L
E6195B	8639B	E6836	DS1204	E9919	ES3178R	E4442N	8489N	E4629	ES2091R
E6196B	8643B	E6836TU	DS1204	E9920	DS1337	E4443B	8491B	E4629	ES2204R
E6197B	8641B	E6837	DS1205	E9922	DS1350	E4443N	8491N	E4630	ES411L
E6199B	80063B	E6837TU	DS1205	E9925	DS1265	E4444B	8492B	E4631	ES411R
E6199C	80063C	E6838	DS1206	E9926	DS1266	E4444N	8492N	E4632	ES26L
E6400	DS881	E6838TU	DS1206	E9927	DS1268	E4445B	8500B	E4633	ES26R
E6400TU	DS881	E6839	DS1207	E9928	DS1267	E4445N	8500N	E4634	ES150L
E6401	DS930	E6839TU	DS1207	E9929	DS1269	E4447B	8503B	E4635	ES150R
E6401TU	DS930	E6844	ES325L	E9930	DS1409	E4448B	8645B	E4636	ES176L
E6452B	8560B	E6845	ES325R	E9931	DS1234	E4449B	8514B	E4637	ES176R
E6452BTU	8560B	E6847	ES2200L	E9932	DS1272	E4449N	8514N	E4638	ES2083L
E6668	ES158L	E6847TU	ES2200L	E9933	DS1270	E4450B	8553B	E4639	ES2082R
E6668TU	ES158L	E6848	ES2201R	E9934	DS1271	E4451B	8567B	E4641	ES2208R
E6697	DS1136	E6848TU	ES2201R	E9935	DS1259	E4451N	8567N	E4642	ES2208R
E6744	ES158R	E6849	ES2203R	E9936	DS1369	E4452B	8568B	E4693B	8617B
E6744TU	ES158R	E6849TU	ES2203R	E9937	DS1366	E4453B	8570B	E4695C	80063C
E6803	DS1021	E6854	ES3026L	E9938	DS1371	E4453N	8570N	E4696C	8618C
E6803TU	DS1021	E6854TU	ES3026L	E9939	DS1370	E4454B	8518B	E4697B	8610B
E6804	DS1022	E6855	ES3027R	E9940	DS1273	E4454N	8518N	E5310	DS800
E6804TU	DS1022	E6855TU	ES3027R	E9941B	8655C	E4455N	8562N	E5311	DS803
E6806	DS1024	E6856	ES3030R	E9942	80070C	E4456N	8560N	E5311TU	DS803
E6806TU	DS1024	E6856TU	ES3030R	E9942B	8001C	E4457B	8573B	E5312	DS835
E6807	DS1027	E6857	ES3031L	E9943B	8653B	E4458B	8571B	E5312TU	DS835
E6807TU	DS1027	E6857TU	ES3031L	E9944	80068C	E4459B	8572B	E5314	DS845
E6808	DS1028	E6858	ES3032R	E9948	ES3214R	E4460B	8577B	E5315	DS867
E6808TU	DS1028	E6858TU	ES3032R	E9949	ES3217L	E4461B	8579B	E5315TU	DS867
E6810	DS1030	E6862	ES2061L	E9950	ES3218R	E4462B	8581B	E5319	DS872
E6810TU	DS1030	E6862TU	ES2061L	E9951	ES3219L	E4462N	8581N	E5319TU	DS872
E6812	DS1035	E6863	ES3039L	E9952	ES3220R	E4463B	8583B	E5320	DS873
E6812TU	DS1035	E6863TU	ES3039L	E9956	ES3216R	E4463N	8583N	E5320TU	DS873
E6815	DS1044	E6864	ES3040R	E9957	DS1379S	E4464B	8585B	E5323	DS880
E6815TU	DS1044	E6864TU	ES3040R	E9958	DS1380S	E4465B	8592B	E5323TU	DS880
E6816	DS1064	E6865B	8336B	E9960	DS1362S	E4466B	8593B	E5325	DS908
E6816TU	DS1064	E6865BTU	8336B	E9962	ES3177L	E4467B	8601B	E5326	DS910
E6817	DS1067	E6868B	80063B	E9964	DS1368A	E4468B	8590B	E5330	DS938
E6817TU	DS1067	E6868B	8611B	E9965	ES3284L	E4469B	8613B	E5331	DS939
E6818	DS1179	E6868BTU	80063B	E9966	ES3283R	E4471B	8605B	E5332	DS941

Interchanges

Euclid Industries	Moog No.	Euclid Industries	Moog No.	Flagg-triangle	Moog No.	Flagg-triangle	Moog No.	Flagg-triangle	Moog No.
E5334	DS943	E6827	DS1191	DS1221	DS1221	ES187R	ES187R	FKP114B	8490T
E5335	DS944	E6829	DS1195	DS1273	DS1273	ES2030R	ES2030R	FKP114B	8492B
E5336	DS945	E6830	DS1196	DS1274	DS1274	ES2061L	ES2061L	FKP11B	8386B
E5337	DS946	E6831	DS1197	DS1275	DS1275	ES2062R	ES2062R	FKP11N	8386N
E5338	DS948	E6832	DS1198	DS1276	DS1276	ES2069R	ES405R	FKP122B	8660B
E5339	DS949	E6833	DS1199	DS1337	DS1337	ES2070L	ES405L	FKP125C	80068C
E5341	DS952	E6834	DS1200	DS1340	DS1340	ES2082R	ES2082R	FKP12B	8389B
E5342	DS953	E6835	DS1203	DS1344	DS1344	ES2083L	ES2083L	FKP16B	8428B
E5343	DS954	E6836	DS1204	DS659	DS659	ES2090L	ES2090L	FKP21B	8454B
E5344	DS955	E6837	DS1205	DS685	DS685	ES2091R	ES2091R	FKP21N	8454N
E5345	DS956	E6838	DS1206	DS733	DS733	ES2200L	ES2200L	FKP23B	8456B
E5357	DS969	E6839	DS1207	DS800	DS800	ES2201R	ES2201R	FKP25B	8458B
E5358	DS970	E6846	ES2114R	DS803	DS803	ES2203R	ES2203R	FKP27B	8462B
E5359	DS971	E6856	ES3030R	DS835	DS835	ES2208R	ES2208R	FKP27N	8462N
E5360	DS972	E6857	ES3031L	DS845	DS845	ES2224L	ES2224L	FKP30B	8474B
E5361	DS973	E6858	ES3032R	DS867	DS867	ES2225R	ES2225R	FKP34N	8500N
E5362	DS974	E6865B	8336B	DS872	DS872	ES2257R	ES2257R	FKP36B	8488B
E5363	DS976	E6868B	8611B	DS873	DS873	ES2613L	ES2613L	FKP36B10	8488B010
E5364	DS977	E6869C	8631C	DS880	DS880	ES2614R	ES2614R	FKP37B	8489B
E5366	DS979	Fabco	Moog No.	DS881	DS881	ES26L	ES26L	FKP37N	8489N
E5368	DS982	363227	ES187L	DS908	DS908	ES26R	ES26R	FKP38B	8490T
E5369	DS983	363228	ES187R	DS910	DS910	ES3026L	ES3026L	FKP39B	8491B
E5372	DS986	363272	ES431R	DS929	DS929	ES3027R	ES3027R	FKP39N	8491N
E5373	DS987	363273	ES431L	DS930	DS930	ES3030R	ES3030R	FKP40B	8492B
E5374	DS988	Flagg-triangle	Moog No.	DS939	DS939	ES3031L	ES3031L	FKP40N	8492N
E5377	DS991	DS1020	DS1020	DS941	DS941	ES3032R	ES3032R	FKP43B	8500B
E5378	DS992	DS1021	DS1021	DS943	DS943	ES3039L	ES3039L	FKP45B	8503B
E5379	DS993	DS1022	DS1022	DS944	DS944	ES3040R	ES3040R	FKP46B	8479B
E5380	DS994	DS1024	DS1024	DS945	DS945	ES304L	ES304L	FKP46B	8507B
E5381	DS995	DS1025	DS1025	DS946	DS946	ES304R	ES304R	FKP46N	8479N
E5382	DS996	DS1026	DS1026	DS948	DS948	ES3086L	ES3086L	FKP46N	8507N
E5383	DS997	DS1027	DS1027	DS949	DS949	ES3087R	ES3087R	FKP49B	8514B
E5384	DS998	DS1028	DS1028	DS952	DS952	ES323L	ES323L	FKP49N	8514N
E5385	DS999	DS1030	DS1030	DS953	DS953	ES323R	ES323R	FKP51B	8645B
E5386	DS1020	DS1031	DS1031	DS954	DS954	ES325L	ES325L	FKP52B	8518B
E5387	DS1025	DS1033	DS1033	DS955	DS955	ES325R	ES325R	FKP52N	8518N
E5388	DS1026	DS1034	DS1034	DS956	DS956	ES330L	ES330L	FKP53B	8519B
E5389	DS1033	DS1035	DS1035	DS958	DS958	ES330R	ES330R	FKP53N	8519N
E5390	DS1034	DS1044	DS1044	DS963	DS963	ES332L	ES332L	FKP59B	8527B
E5391	ES2224L	DS1064	DS1064	DS969	DS969	ES332R	ES332R	FKP62B	8553B
E5392	ES2030R	DS1079	DS1079	DS970	DS970	ES346L	ES346L	FKP66B	8560N
E5393	ES2113R	DS1179	DS1179	DS971	DS971	ES346R	ES346R	FKP67B	8562N
E5396TU	ES2116L	DS1180	DS1180	DS972	DS972	ES373L	ES373L	FKP68B	8567B
E5398	ES2204R	DS1182	DS1182	DS973	DS973	ES373R	ES373R	FKP68N	8567N
E5402	ES2225R	DS1184	DS1184	DS974	DS974	ES405L	ES405L	FKP69B	8568B
E5471	ES2091R	DS1185	DS1185	DS976	DS976	ES405R	ES405R	FKP6B	8357B
E5472	ES2090L	DS1190	DS1190	DS977	DS977	ES411L	ES411L	FKP6N	8357N
E5487B	8641B	DS1191	DS1191	DS979	DS979	ES411R	ES411R	FKP70B	8570B
E6194B	8633B	DS1192	DS1192	DS982	DS982	ES423L	ES423L	FKP70N	8570N
E6194B	8633C	DS1195	DS1195	DS986	DS986	ES423R	ES423R	FKP71B	8571B
E6194C	8633C	DS1197	DS1197	DS987	DS987	ES431L	ES431L	FKP72B	8572B
E6195B	8639B	DS1198	DS1198	DS988	DS988	ES431R	ES376R	FKP73B	8573B
E6196B	8643B	DS1199	DS1199	DS991	DS991	ES431R	ES431R	FKP75B	8577B
E6400	DS881	DS1200	DS1200	DS992	DS992	ES434L	ES434L	FKP76B	8579B
E6401	DS930	DS1203	DS1203	DS993	DS993	FKP100B	80063C	FKP77B	8581B
E6452B	8560B	DS1204	DS1204	DS994	DS994	FKP101B	8631B	FKP77N	8581N
E6744	ES158R	DS1205	DS1205	DS995	DS995	FKP101B	8631C	FKP78B	8583B
E6808	DS1028	DS1207	DS1207	DS996	DS996	FKP104B	8639B	FKP78N	8583N
E6815	DS1044	DS1214	DS1214	DS997	DS997	FKP105B	8643B	FKP79B	8445B
E6816	DS1064	DS1215	DS1215	DS998	DS998	FKP106B	8641B	FKP79B	8585B
E6818	DS1179	DS1216	DS1216	DS999	DS999	FKP109B	8633C	FKP80B	8587N
E6819	DS1180	ES150L	ES150L	ES150L	ES150L	FKP10B	8385B	FKP83B	8592B
E6821	DS1182	ES150R	ES150R	ES150R	ES150R	FKP10B15	8385B015	FKP84B	8593B
E6823	DS1184	ES176L	ES176L	ES176L	ES176L	FKP110B	8637B	FKP85B	8601B
E6824	DS1185	ES176R	ES176R	ES176R	ES176R	FKP111B	80063C	FKP86B	8613B
E6826	DS1190	ES187L	ES187L	ES187L	ES187L	FKP112B	80066B	FKP88B	8605B

Interchanges

Interchanges

Flagg-triangle	Moog No.	Flagg-triangle	Moog No.	Ford	Moog No.	Ford	Moog No.	Ford	Moog No.
FKP89B	80055B	KP234	80055B	C1TZ3A130B	ES2083L	D0HZ3A130A	ES431R	DOHZ3A130B	ES376L
FKP8B	8375B	KP235	80057B	C1TZ3A130B	ES304R	D0HZ3A130B	ES2113R	DOHZ3A131B	ES376R
FKP90B	8590B	KP236	80058B	C1TZ3A130C	ES187R	D0HZ3A130B	ES2114R	E0HZ3304A	DS948
FKP91B	8610B	KP237	8610B	C1TZ3A130D	ES373R	D0HZ3A130B	ES376R	E0HZ3304B	DS949
FKP92B	8611B	KP239	8612B	C1TZ3A131A	ES150L	D0HZ3A130B	ES431R	E3HZ3304A	DS1204
FKP93B	8612B	KP2340	8617B	C1TZ3A131B	ES304L	D0HZ3A130C	ES376R	E3HZ3304B	DS949
FKP94B	80058B	KP2344	8488B	C1TZ3A131C	ES187L	D0HZ3A130C	ES431R	E3HZ3304C	DS958
FKP95B	80057B	Flxible	Moog No.	C1TZ3A131D	ES373L	D0HZ3A130D	ES423R	E3HZ3304D	DS955
FKP96B	8617B	48000100262	DS1273	C1UZ3A130A	ES416R	D0HZ3A131A	ES323L	E3HZ3304E	DS956
FKP98B	8618C	Ford	Moog No.	C1UZ3A131A	ES416L	D0HZ3A131A	ES423L	E3HZ3304F	DS1206
FKP98B	8631B			C2TZ3111A	8357B	D0HZ3A131A	ES431L	E3HZ3304F	DS943
KP2263	8375B	198525	ES194R	C2TZ3111A	8357N	D0HZ3A131B	ES2116L	E3HZ3304F	DS948
KP2264	8385B	198525	ES2082R	C2TZ3111B	8479N	D0HZ3A131B	ES376L	E3HZ3304G	DS1205
KP2265	8389B	7EQ3111	8357B	C2TZ3111B	8507N	D0HZ3A131B	ES431L	E3HZ3304H	DS908
KP2266	8386B	A0AZ3A130A	ES416R	C2TZ3111C	8519N	D0HZ3A131C	ES376L	E3HZ3304J	DS953
KP2268	8462B	A0AZ3A131A	ES416L	C2TZ3111D	8386N	D0HZ3A131C	ES431L	E3HZ3304K	DS1035
KP2269	8458B	A9MY3A131A	ES416L	C2TZ3111E	8474B	D0HZ3A131D	ES423L	E3HZ3304L	DS954
KP2270	8456B	B3T3111A	8426B	C2TZ3111F	8479N	D0TZ3304A	DS873	E3HZ3A130A	ES423R
KP2271	8386N	B3TZ3A130A	ES194R	C2TZ3111F	8507B	D1HZ3111A	8519B	E3HZ3A131A	ES423L
KP2272	8527B	B3TZ3A130A	ES2082R	C2TZ3111F	8507B010	D1HZ3111A	8519B010	E4HZ3280B	DS1367A
KP2273	8474B	B3TZ3A131A	ES194L	C2TZ3111F	8507N	D1HZ3111A	8519N	E4HZ3280BD	DS1367A
KP2274	8454B	B3TZ3A131A	ES2083L	C2TZ3111G	8519N	D1HZ3111B	8489B	E4HZ3280D	DS1367A
KP2275	8489N	B4AZ3A130A	ES416L	C3TZ3111A	80063C	D1HZ3111B	8489N	E4HZ3304A	DS958
KP2276	8462N	B4TZ3A130B	ES187R	C3TZ3111A	8488B	D2TZ3111D	8488B	E4HZ3304B	DS908
KP2277	8492N	B5QH3332B	DS733	C3TZ3111A	8488B010	D2TZ3111D	8488B010	E4HZ3304H	DS908
KP2278	8492B	B5TZ3A130A	ES187R	C3TZ3111A	8609B	D2TZ3111D	8609B	E4HZ3A130A	ES423R
KP2279	8491N	B5TZ3A131A	ES187L	C3TZ3111B	8489B	D3TZ3111A	8500B	E4HZ3A130B	ES423R
KP2280	8491B	B6SZ3A130A	ES416L	C3TZ3111B	8489N	D3TZ3111A	8500B010	E4HZ3A131A	ES423L
KP2281	8336B	B7QH3111A	8519B	C3TZ3111C	8489B	D3TZ3111A10	8500B010	E4HZ3A131B	ES423L
KP2282	8490T	B7QH3111B	8507B	C3TZ3111D	8488B	D4HZ3281A	DS1380S	E5HT3304VA	DS908
KP2283	8492N	B7T3111A	8459B	C3TZ3111D	8488B010	D5HZ3111A	8500B	E5HZ3A130A	ES3442R
KP2284	8500B	B7T3111A	8471B	C4TZ3111A	8488B	D5HZ3111B	8573B	E5HZ3A131A	ES3443L
KP2285	80053B	B7TY3111A	8458B	C4TZ3111A	8488B010	D5HZ3111C	8571B	E7HS3304BA	DS949
KP2286	8503B	B7TZ3111A	8357B	C4TZ3111A	8514N	D5HZ3304A	DS946	E7HZ3304A	DS953
KP2288	8519N	B7TZ3111B	8507B	C4TZ3111B	8514B	D5HZ3304B	DS954	E8HT3304AA	DS1192
KP2289	8479B	B7TZ3111C	8386B	C4TZ3A533A	ESK371	D5HZ3304C	DS946	E8HT3304BB	DS1191
KP2290	8479N	B7TZ3111C	8386N	C5NN3290B	ES187L	D5HZ3304D	DS908	E8HT3304DA	DS1203
KP2291	8514B	B7TZ3111D	8519B	C5TZ3111B	8518B	D5HZ3304F	DS1035	E8HZ3111A	8639B
KP2292	8489B	B7TZ3111F	8479B	C5TZ3111D	8518B	D5HZ3305F	DS1035	E8HZ3304A	DS1192
KP2294	8519B	B7TZ3111F	8507B	C5TZ3130AB	ES346R	D5TZ3111B	8568B	E8HZ3304B	DS1191
KP2296	8518N	B7TZ3111F	8507B010	C5TZ3A130B	ES346R	D5TZ3111C	8571B	E8HZ3304D	DS1190
KP2297	8518B	B7TZ3111G	8519B	C7TZ3111A	8500B	D5TZ3281A	DS1362S	E8HZ3304D	DS1191
KP2298	8514N	B7Y3111A	8458B	C7TZ3111A	8500B010	D5TZ3304A	DS945	E8HZ3304E	DS1203
KP2305	8553B	B7Y3111A	8458B010	C7TZ3111A	8500N	D5TZ3304B	DS952	E8HZ3304EF	DS1203
KP2310	8562N	B8QH3111A	8474B	C7TZ3304A	DS800	D5TZ3304B	DS954	E8HZ3304F	DS1203
KP2311	8567B	B8QH3111B	8386B	C7TZ3A130D	ES373R	D5TZ3A130A	ES2035L	E8HZ3304H	DS1190
KP2312	8567N	B8TZ3111B	8474B	C7TZ3A131D	ES373L	D5TZ3A130A	ES2036R	E8HZ3A130A	ES373R
KP2313	8568B	B8TZ3A130A	ES346R	C8TZ3304A	DS872	D5TZ3A131A	ES2035L	E8HZ3A131A	ES373L
KP2314	8571B	B8TZ3A130B	ES346R	C8TZ3A130A	ES187R	D5TZ3A131A	ES2036R	E8HZ3A131A	ES373R
KP2315	8572B	B8TZ3A130B	ES431R	C9TZ3304A	DS803	D6HZ3111A	8572B	E9HS3304AA	DS1191
KP2316	8573B	B8TZ3A131B	ES346L	CITT3304AD	DS733	D6HZ3111B	8573B	E9HZ3111A	8643B
KP2318	8570B	B8TZ3A131B	ES431L	CITZ3304D	DS733	D6HZ3304A	DS1206	E9HZ3111B	8641B
KP2320	8577B	B8Y3111A	8458B010	D0HZ3111A	8519B	D6HZ3304A	DS943	E9HZ3111C	8653B
KP2321	8585B	C0AZ3A131A	ES416L	D0HZ3111B	8489B	D6HZ3304B	DS956	F0HT3304AA	DS1207
KP2322	8579B	C0TZ3A130A	ES150R	D0HZ3111C	8514B	D6HZ3304C	DS1205	F0HT3304AB	DS1207
KP2323	8581B	C0TZ3A130B	ES150R	D0HZ3111C	8514N	D6HZ3304E	DS944	F0HZ3111A	80068C
KP2324	8581N	C0TZ3A131A	ES150L	D0HZ3111C	8518B	D6HZ3304F	DS955	F0HZ3281A	DS1380S
KP2325	8583B	C0TZ3A131B	ES150L	D0HZ3111C	8518N	D6TZ3111A	8568B	F0HZ3281B	DS1362S
KP2326	8583N	C1TT3304AD	DS733	D0HZ3111D	8474B	D7HZ3111A	8519B	F0HZ3304A	DS1204
KP2327	8590B	C1TT3304D	DS733	D0HZ3111E	8518B	D7HZ3111A	8519N	F0HZ3304B	DS1205
KP2328	8592B	C1TT3304N	DS685	D0HZ3111E	8518N	D7HZ3111B	8573B	F0HZ3304C	DS1206
KP2329	8593B	C1TT3304S	DS659	D0HZ3281A	DS1379S	D8HZ3111A	8585B	F0HZ3304C	DS943
KP2330	8601B	C1TZ3111B	8357B	D0HZ3304A	DS845	D8HZ3304A	DS958	F0HZ3304D	DS1192
KP2331	8613B	C1TZ3111C	8386B	D0HZ3304B	DS953	D9HZ3304F	DS1035	F0HZ3304E	DS1207
KP2332	80056B	C1TZ3A130A	ES150R	D0HZ3A130A	ES323R	D0HZ3111E	8518B	F0HZ3304F	DS1207
KP2333	8605B	C1TZ3A130A	ES176R	D0HZ3A130A	ES423R	DOHZ3111E	8518N	F0HZ3304G	DS1191

Interchanges

Ford	Moog No.	Ford	Moog No.	Freightliner	Moog No.	Freightliner	Moog No.	GMC	Moog No.
F0HZ3A130B	ES2035L	F5HZ3A131AA	ES3443L	A3144P1134	ES423L	L28SV5200A12	ES2209R	12549187	DS1195
F0HZ3A130C	ES2062R	F5HZ3A131B	ES3283R	A3144Q225	ES187L	L28SV5200D12	ES2091R	12549188	DS1196
F0HZ3A130D	ES3039L	F5HZ3A131B	ES3284L	A3144R226	ES187R	L28SV5200D12	ES2204R	12549190	ES2061R
F0HZ3A130E	ES2035L	F5TZ3304AAA	DS958	B1409063002	DS999	L28SV5200D12	ES2209R	12549191	ES2062R
F0HZ3A130E	ES2061L	F68Z3304FB	DS1442	B1490632	DS999	L28SV5201A12	ES2090L	12549192	ES3026L
F0HZ3A130F	ES3039L	F6HZ3111A	80071C	KIT123	8386B	L28SV5201A12	ES2210L	12549193	ES3027R
F0HZ3A131B	ES2036R	F6HZ3111AA	80071C	KIT123	8386N	L28SV5201D12	ES2090L	12549194	ES3268L
F0HZ3A131C	ES2061L	F6HZ3111BB	80072B	KIT144	8386B	L28SV5201D12	ES2210L	12549194	ES3269R
F0HZ3A131D	ES3040R	F6HZ3111CC	80073C	KIT144	8386N	L28SV5207B16	ES2091R	12549195	ES3268L
F0HZ3A131E	ES2036R	F6HZ3304AA	DS1444	KIT156	8514B	L28SV5207B16	ES2204R	12549195	ES3269R
F0HZ3A131F	ES2035L	F6HZ3304BA	DS1443	KIT156	8514N	L28SV5207B16	ES2209R	15501673	DS1044
F0HZ3A131F	ES2036R	F6HZ3304CA	DS1447	KIT157	8514B	R200123	8386N	15501674	DS1067
F0HZ3A131G	ES3040R	F6HZ3304DA	DS1448	KIT157	8514N	R200144	8386B	15506689	DS1064
F1HT3304GA	DS1265	F6HZ3304EA	DS1446	KIT167	8489B	R200156	8514N	15506689	DS1067
F1HT3304JA	DS1266	F6HZ3304FB	DS1442	KIT167	8489N	R200157	8514B	15506690	DS1195
F1HT3304LA	DS1267	F6HZ3304JA	DS1445	KIT168	8518B	R200157	8590B	15506690	DS1196
F1HT3304RA	DS1268	F6HZ3311BB	80072B	KIT168	8518N	R200167	8489N	15506691	DS1196
F1HZ3111A	8639B	F6HZ3311CC	80073C	KIT170	8518B	R200168	8518N	1550690	DS1195
F1HZ3304A	DS1265	F6HZ3A130AA	ES3442R	KIT170	8518N	R200170	8518B	15510849	8590B
F1HZ3304B	DS1265	F6HZ3A131AA	ES3443L	KIT172	8489B	R200172	8489B	15512233	8514B
F1HZ3304C	DS1266	F7HZ3304CA	DS1447	KIT172	8489N	R200195	8590B	15512234	8518B
F1HZ3304D	DS1266	FHZ3A130AA	ES3283R	KIT195	8590B	R200198	8571B	15512235	8489B
F1HZ3304E	DS1268	FOHZ3304B	DS1025	KIT198	8571B	R200199	8553B	15512238	8336B
F1HZ3304F	DS1268	FOHZ3304D	DS1192	KIT199	8553B	R201300	8612B	15512240	8519N
F1HZ3304G	DS1191	FOHZ3A130B	ES2035L	ES405L	ES405L	R201309	80063C	15512338	8612B
F1HZ3304G	DS1267	FOHZ3A130B	ES2036R	L24SV5000H17	ES187R	R201310	8611B	15514804	ES423L
F1HZ3304H	DS1267	FOHZ3A130C	ES2062R	L24SV5001A13	ES187R	R201310	8611B	15514804	ES423L
F1HZ3304J	DS1269	FOHZ3A130D	ES3039L	L24SV5001A14	ES187R	R201315	80063C	15515804	ES423L
F1HZ3304K	DS1409	FOHZ3A130D	ES3039L	L24SV5001D23	ES405R	R230060	ES187L	15515805	ES423R
F1HZ3304L	DS1234	FOHZ3A131B	ES2035L	L24SV5042B12	ES423R	R230061	ES187L	15516689	DS1064
F1HZ3304M	ES3176R	FOHZ3A131C	ES2036R	L24SV5043A14	ES423L	R230061	ES187R	15516779	DS1197
F1HZ3A130A	ES3176R	FOHZ3A131C	ES2061L	L24SV5000A12	ES2203R	R230066	ES346R	15536398	8491B
F1HZ3A130B	ES3176R	FOHZ3A131D	ES3040R	L24VU5183A11	DS1273	R230067	ES346L	15536398	8491B010
F1HZ3A131A	ES3177L	Freightliner	Moog No.	L24VU7074A11	DS1274	R230068	ES423L	15536398	8491N
F2HZ3304B	DS1272	1006148	ES423L	L24VU7110A11	DS1275	R230069	ES423R	15536398	8570B
F2HZ3304C	DS1270	1006149	ES423R	L24VU7116A11	DS1276	R230070	ES431R	15536398	8570N
F2HZ3304D	DS1271	1009009	ES3298L	L24VU8047B11	DS1273	R230071	ES431L	15618118	80063C
F2HZ3304E	DS1259	1009010	ES3297R	L24VU8047B12	DS1273	R230072	ES2090L	15619285	ES3274L
F3HZ3280G	DS1368A	1410281000	DS1220	L28SV5000A14	ES2113R	R230073	ES2091R	15619286	ES3275R
F3HZ3281E	DS1362S	1410281004	DS1221	L28SV5000A14	ES2114R	R230074	ES2200L	15619287	ES3268L
F3HZ3281E	DS1363S	1410281001	DS1340	L28SV5000A14	ES376R	R230075	ES2201R	15619288	ES3268L
F3HZ3304A	DS1259	1410299001	DS1340	L28SV5000A14	ES431R	R230090	ES3312R	15619288	ES3269R
F3HZ3A130B	ES3176R	1412009000	DS1274	L28SV5000A18	ES2113R	R230091	ES3031L	15619560	8659B
F3HZ3A131B	ES3177L	1412098001	DS1218	L28SV5000A18	ES2114R	R230092	ES3030R	15619562	8661B
F4HZ3280C	DS1368A	1412098002	DS1219	L28SV5000A18	ES376R		GMC	15619560	8659B
F4HZ3304A	DS1369	1412098004	DS1344	L28SV5000A18	ES431R		Moog No.	15622057	DS1200
F4HZ3A130AA	ES3283R	1412098005	DS1275	L28SV5000A30	ES2207R	12540328	8659B	15622066	DS1198
F4HZ3A130AA	ES3284L	1412479000	DS30002	L28SV5000H29	ES2113R	12540329	8660B	15622068	ES3026L
F4HZ3A131AA	ES3283R	6804600405	DS1276	L28SV5000H29	ES2114R	12540330	8661B	15622069	ES3027R
F4HZ3A131AA	ES3284L	6814601505	DS1337	L28SV5000H29	ES376R	12541319	ES2090L	15625713	DS1199
F5HZ30130AA	ES3442R	806355	8618C	L28SV5000H29	ES431R	12541319	ES2210L	15647353	DS1278
F5HZ3111A	80069B	817018	ES3477	L28SV5000H35	ES2113R	12541320	ES2091R	15647355	DS1216
F5HZ3280A	DS1368A	817019	ES3476	L28SV5000H35	ES2114R	12541320	ES2204R	15651094	DS1277
F5HZ3281B	DS1363S	823078	80076B	L28SV5000H35	ES376R	12541320	ES2209R	15651099	DS1217
F5HZ3281E	DS1363S	A14095001	DS1350	L28SV5000H35	ES431R	12541348	8633B	15666375	DS1197
F5HZ3304A	DS1366	A1409535001	DS1350	L28SV5001A18	ES2116L	12541348	8633C	15986855	DS1278
F5HZ3304ABA	DS1271	A1409547000	DS1136	L28SV5001A18	ES376L	12548107	ES3274L	15986856	DS1217
F5HZ3304ADA	DS845	A1412349000	DS1276	L28SV5001A18	ES431L	12548107	ES3275R	15986858	DS1216
F5HZ3304AGA	DS1259	A1495470	DS1136	L28SV5003A14	ES346R	12548108	ES3274L	15986859	DS1277
F5HZ3304B	DS1371	A3144C237	ES346L	L28SV5003B18	ES2116L	12548108	ES3275R	2007728	ES405R
F5HZ3304C	DS1370	A3144D238	ES346R	L28SV5003B18	ES376L	12548109	ES3274L	2007731	ES405L
F5HZ3304VA	DS954	A3144D524	ES423R	L28SV5003B18	ES431L	12548110	ES3270L	2010021	8590B
F5HZ3304YA	DS908	A3144E525	ES423L	L28SV5004D1	ES2113R	12548111	ES3271R	2025551	DS983
F5HZ3304ZA	DS1192	A3144F448	ES2091R	L28SV5015A14	ES2208R	12549179	DS986	2036352	8571B
F5HZ3A130AA	ES3442R	A3144G449	ES2090L	L28SV5019A1	ES2224L	12549180	DS987	2037140	ES405R
F5HZ3A130B	ES3283R	A3144K297	ES2040R	L28SV5200A12	ES2091R	12549182	DS1200	2037142	ES405L
F5HZ3A130B	ES3284L	A3144N1132	ES423R	L28SV5200A12	ES2204R	12549183	DS1199	2042171	DS991
						12549186	DS1064		

Interchanges

Interchanges

GMC	Moog No.	GMC	Moog No.	GMC	Moog No.	International	Moog No.	International	Moog No.
2055523	ES2200L	3819404	8491N	798203	ES3030R	1660439C91	DS1293	303138C92	8514B
2055524	ES2201R	3819717	ES332L	798203	ES431R	1661437C92	DS1214	303138C92	8514N
2185126	8336B	3819717	ES332R	798204	ES2090L	1661867C91	DS1215	303138R92	8514B
220TR118	ES3031L	3825931	ES150L	798204	ES2210L	1662305C91	8386N	303138R92	8514N
220TR119	ES3030R	3825932	ES150R	798204	ES3031L	1662306C91	8553B	303139C91	8389B
2224492	8207B	3826596	ES323L	798204	ES431L	1663000C91	ES2091R	303139C92	8489B
2224495	8343B	3826814	ES323R	859552	8514N	1663000C91	ES2204R	303139C92	8489N
2264897	8386B	3828201	ES330L	8875934	ES187L	1663000C91	ES2209R	303140C92	8518B
2264897	8386N	3828202	ES330R	8875935	ES187R	1663910C91	DS1295A	303140C92	8518N
2319824	8462B	3828205	ES332L	8885021	8462B	1664846C92	DS1303	306920C91	80053B
2321013	8462B	3828206	ES332R	8885021	8462N	1665531C91	80063C	306920C92	80053B
2330712	ES176R	3829410	8484T	8885021	8613B	1667329C91	DS1281	306921C93	8503B
2330713	ES176L	3853990	8484T	8885621	8462N	1667556C91	DS1305	346295C91	DS963
2362835	ES176R	3854008	8445B	8885621	8613B	1667772C92	DS1291A	377635C91	ES411L
2362836	ES176L	3854744	8490T	8885856	8462B	1668224C91	ES3204L	377636C91	ES411R
2394913	8474B	3854744	8491B	8885856	8462N	1668225C91	ES3205R	398313C92	DS969
2407799	8474B	3858389	8492B	8885856	8613B	1668407C91	ES3217L	399942C93	8567B
2411261	8357B	3858389	8492N	8885857	8491B	1668408C91	ES3218R	399942C93	8567N
2413344	ES194R	3858390	8491B	8885857	8491B010	1668409C91	ES3219L	400745C92	DS970
2413344	ES2082R	3858390	8491N	8885857	8491N	1668410C91	ES3220R	402032C91	DS971
2413345	ES194L	3864347	ES330L	94419608	ES3335R	1668411C91	8655B	402034C91	DS972
2413345	ES2083L	3864348	ES330R	94419609	ES3336L	1668411C92	8655C	402036C91	DS973
2431372	8462N	3864353	ES332L	A3144D524	ES423R	1668412C91	80070C	402038C91	DS974
2442145	8514B	3864354	ES332R	A3144E525	ES423L	1668412C91	8657B	408547C91	8645B
2442145	8514N	3892946	ES2030R	A3144M533	ES2200L	1668412C92	80070C	408547C93	8645B
2452860	ES2113R	3927941	8445N	A3144N534	ES2201R	1668412C92	8657B	414827C91	ES2113R
2452860	ES2114R	3927942	8492B	R200195	8590B	1668479C91	ES2090L	414827C91	ES2114R
2452860	ES376R	3927942	8492N	R230090	ES3312R	1668479C91	ES3031L	414827C91	ES376R
2452860	ES431L	3927943	8491B	R230091	ES3031L	1668480C91	ES2091R	414827C91	ES431R
2452860	ES431R	3927943	8491B010	R230092	ES3030R	1669501C91	DS1264	438368C91	ES423L
2452861	ES2116L	3927943	8491N	Hendrickson Moog No.		166950C91	DS1264	438369C91	ES423R
2452861	ES376L	462389	ES2061L	60961040	8008C	1672007C91	DS1294A	442353C91	DS1027
2452861	ES431L	462390	ES2062R	66645001	ES800421	1675148C91	DS1298	442354C91	ES2091R
2452861	ES431R	601019	8207B	66645002	ES800420	1676601C91	8518B	442354C91	ES2204R
2452865	8518B	601395	ES26L	Hino Moog No.		1677271C91	ES2091R	442354C91	ES2209R
2452865	8518N	601396	ES26R	R230068	ES423L	1677271C91	ES2204R	442354C92	ES2091R
2453143	ES3216R	669335	DS910	R230069	ES423R	1677271C91	ES2209R	442354C92	ES2204R
2456810	ES187L	671488	ES405L	International Moog No.		1681413C91	8514B	442354C92	ES2209R
2456811	ES187R	671488	ES405R	1009009	ES3298L	1681414C91	8518N	447094C91	ES411L
2465925	ESK371	671489	ES405R	1009010	ES3297R	1685405C91	80074B	447095C91	ES411R
2465926	ESK371	677299	DS938	10QH248P2	ES187L	1685405C91	80075C	449634C91	DS1028
2467322	ES187R	677299	DS939	110362R92	ES187L	194688R91	ES304L	450062C91	ES373R
2467326	ES325R	677300	DS939	110363R92	ES187R	201600R93	8474B	450063C91	ES373L
2467328	ES325L	684196	DS988	134455R91	8441B	2024052C91	DS1294A	452344C91	8553B
2467330	ES325R	685504	ES2113R	134456R91	8385B015	219403R91	ES176L	453831C91	DS1028
2467331	ES325R	685504	ES2114R	155932R92	8386N	219404C91	ES176R	459544C91	DS976
2467332	ES325L	685504	ES376R	1648204C91	8577B	219404R91	ES176R	46502HX	ES26L
2467333	ES325L	685504	ES431R	1648204C91	8577B010	220TR115	ES431L	46502HX	ES26R
2470621	8479B	687108	DS982	1648204C92	8577C002	220TR116	ES431R	46503HX	ES26L
2470621	8507B	690286	DS929	1649637	ES411L	220TR118	ES3031L	46503HX	ES26R
2476922	ES150R	690287	DS835	1649637C91	ES411L	220TR119	ES3030R	465697C91	DS977
2476923	ES150L	694332	8553B	1649638C91	ES411R	229265R91	8514B	470572C91	8583N
3427941	8445N	698571	ES423L	1652578C91	DS1299A	229265R92	8514N	472094C91	8581B
3678189	8484T	698572	ES423R	1654911C91	DS1263	263498C91	ES235L	472094C91	8581N
3691111	8343B	718796	DS986	1654912C91	ES2091R	263499C91	ES235R	473695C91	8577B
3692946	ES2030R	718797	DS1064	1654912C91	ES2204R	3018735R1	ES194L	473695C91	8577B010
3704112	8428B	718798	DS987	1654912C91	ES2209R	3018735R1	ES2083L	473695C91	8577C
3715892	ES330L	720383	DS941	1658897C91	ES3214R	3018736R1	ES194R	473695C91	8577C002
3715892	ES330R	722166	8570B	1658897C92	DS1020	3018736R1	ES2082R	473695C92	8577C
3720696	8445B	722166	8570B010	1658946C91	ES3086L	301873R1	ES194L	474520C91	8571B
3729927	DS584	722166	8570N	1658947C91	ES3087R	301873R1	ES2083L	480645C92	DS979
3745389	ES187L	789203	ES2091R	165894C91	ES3086L	303136C92	8519B	484598C91	DS1030
3745390	ES187R	789204	ES2090L	1660271C91	8637B	303136C92	8519B010	484626C91	DS1031
3799913	ES150L	798203	ES2091R	1660271C92	8637B	303136C92	8519N	486354C91	ES2090L
3799914	ES150R	798203	ES2204R	1660271C92	8637B	303137C92	8386B	486354C91	ES2210L
3819404	8491B	798203	ES2209R	1660271C92	8637C	303137C92	8386N	486355C91	ES2091R

Interchanges

International	Moog No.	International	Moog No.	International	Moog No.	International	Moog No.	International	Moog No.
486355C91	ES2204R	592872C91	ES3032R	FAK4497	8579B	FDL1200	DS1200	FDL996	DS996
486355C91	ES2209R	596653C91	ES3178R	FAK4516	8610B	FDL1203	DS1203	FDL997	DS997
486355C91F	ES2091R	61556R91	8375B	FAK4519	8441B	FDL1204	DS1204	FDL998	DS998
486807C91	ES2203R	69576R92	8386N	FAK4527	8386N	FDL1205	DS1205	FDL999	DS999
486979C91	DS1022	69971R91	8389B	FAK4531	8519B	FDL1206	DS1206	FTR150L	ES150L
486979C92	DS1022	70594R91	8385B	FAK4532	8479B	FDL1207	DS1207	FTR150R	ES150R
488703C91	DS1021	806355	8618C	FAK4532	8507B	FDL1214	DS1214	FTR176L	ES176L
489023C91	DS1034	806356	8631B	FAK4533	8386B	FDL1215	DS1215	FTR176R	ES176R
490424C91	DS1030	806356	8631C	FAK4535	8474B	FDL1216	DS1216	FTR187L	ES187L
490425C91	DS1031	817018	ES3477	FAK4536	8519N	FDL1217	DS1217	FTR187R	ES187R
491611C92	8581B	817019	ES3476	FAK4537	8479N	FDL1218	DS1218	FTR2030R	ES2030R
491666C91	ES2208R	823078	80076B	FAK4537	8507N	FDL1219	DS1219	FTR2035L	ES2035L
492791R91	ES262L	870148R92	8489B	FAK4538	8514N	FDL1220	DS1220	FTR2036R	ES2036R
493092C91	8579B	870148R92	8489N	FAK4539	8514B	FDL1221	DS1221	FTR2061L	ES2061L
493092C91	8579B002	894049R93	ES2200L	FAK4540	8489N	FDL659	DS659	FTR2062R	ES2062R
493092C92	8579B	894050R93	ES2201R	FAK4544	8489B	FDL685	DS685	FTR2069R	ES405R
493092C92	8579B002	894144R91	ES150L	FAK4555	8590B	FDL733	DS733	FTR2070L	ES405L
493094C92	8518N	894145R91	ES150R	FAK4564	8590B	FDL800	DS800	FTR2082R	ES194R
493094C92	8581B	92872C91	ES3032R	FAK4572	8647B	FDL803	DS803	FTR2082R	ES2082R
493094C92	8581N	969055R91	ES2116L	FAK4582	8637B	FDL835	DS835	FTR2083L	ES194L
493094C92	8581N002	969055R91	ES376L	FAK4615	8006C	FDL845	DS845	FTR2083L	ES2083L
493094C93	8581B002	969055R91	ES431L	FAK4626	8001C	FDL867	DS867	FTR2090L	ES2090L
493094C94	8581B002	969055R91	ES431R	FAK4627	8002C	FDL872	DS872	FTR2090L	ES2210L
493094C95	8581N002	969056R91	ES2113R	FAK4628	8003C	FDL873	DS873	FTR2091R	ES2091R
493095C91	8583B	969056R91	ES2114R	FAK5444	8577B	FDL880	DS880	FTR2091R	ES2204R
493095C91	8583N	969056R91	ES376R	FAK5444	8577C	FDL881	DS881	FTR2091R	ES2209R
493095C92	8579B	969056R91	ES431L	FAK5450	80079C	FDL908	DS908	FTR2200L	ES2200L
493095C94	8583N002	969056R91	ES431R	FAK5451	8610B	FDL910	DS910	FTR2201R	ES2201R
493633C95	80079C	A13144E551	ES2208R	FAK5451	8610C	FDL929	DS929	FTR2202R	ES2091R
493652C91	DS1022	A13144E551	ES3032R	FAK5454	8637B	FDL930	DS930	FTR2202R	ES2204R
503100C91	ES3216R	A13144F370	ES2208R	FAK5454	8637C	FDL938	DS938	FTR2202R	ES2209R
503523C91	DS1020	A13144F370	ES3032R	FAK5455	8655B	FDL939	DS939	FTR2203R	ES2203R
503523C92	DS1020	A3144A547	ES2090L	FAK5455	8655C	FDL941	DS941	FTR2204R	ES2091R
503523C93	DS1020	A3144A547	ES2091R	FAK5456	8657B	FDL943	DS1206	FTR2204R	ES2204R
506661C91	ES2613L	A3144J296	ES2208R	FAK5457	80075C	FDL943	DS943	FTR2204R	ES2209R
506662C91	ES2614R	A3144Q225	ES187L	FAK5500	8004C	FDL944	DS944	FTR2207R	ES2207R
506684C91	ES2091R	A3144R226	ES187R	FAK5501	8005C	FDL945	DS945	FTR2208R	ES2208R
506684C91	ES2209R	A3144Z546	ES2091R	FDL1020	DS1020	FDL946	DS946	FTR2224L	ES2224L
507835C91	ES411L	ETN0806355	8618C	FDL1021	DS1021	FDL948	DS948	FTR2225R	ES2225R
507836C91	ES411R	FAK4444	8490T	FDL1022	DS1022	FDL949	DS949	FTR2257R	ES2257R
507837C91	ES423L	FAK4446	8375B	FDL1024	DS1024	FDL952	DS952	FTR235NL	ES235L
507837C91	ES423R	FAK4450	8389B	FDL1025	DS1025	FDL953	DS953	FTR235NR	ES235R
507838C91	ES423L	FAK4451	8385B	FDL1026	DS1026	FDL954	DS954	FTR2613L	ES2613L
507838C91	ES423R	FAK4452	8385B015	FDL1027	DS1027	FDL955	DS955	FTR2614R	ES2614R
532892C91	DS1302	FAK4453	8428B	FDL1028	DS1028	FDL956	DS956	FTR26L	ES26L
549800C91	8590B	FAK4454	8462B	FDL1030	DS1030	FDL958	DS958	FTR26R	ES26R
574878C91	ES3294R	FAK4455	8458B	FDL1031	DS1031	FDL963	DS963	FTR3026L	ES3026L
577682C91	ES2200L	FAK4456	8456B	FDL1033	DS1033	FDL969	DS969	FTR3027R	ES3027R
577683C91	ES2201R	FAK4457	8454B	FDL1034	DS1034	FDL970	DS970	FTR3030R	ES3030R
577684C91	8612B	FAK4458	8454N	FDL1035	DS1035	FDL971	DS971	FTR3030RA	ES3030R
581063C91	ES2091R	FAK4460	8527B	FDL1044	DS1044	FDL972	DS972	FTR3031L	ES3031L
581063C91	ES2204R	FAK4461	8488B	FDL1064	DS1064	FDL973	DS973	FTR3031LA	ES3031L
581064C91	DS1020	FAK4461	8609B	FDL1067	DS1067	FDL974	DS974	FTR3032R	ES3032R
586806C91	8610B	FAK4462	8488B010	FDL1179	DS1179	FDL976	DS976	FTR3033L	ES2090L
586806C92	8610B	FAK4465	8462N	FDL1180	DS1180	FDL977	DS977	FTR3033L	ES2210L
586806C93	8610C	FAK4466	8357N	FDL1182	DS1182	FDL979	DS979	FTR3034R	ES2091R
586809C91	8610B	FAK4467	8491N	FDL1184	DS1184	FDL982	DS982	FTR3034R	ES2204R
588808C91	8617B	FAK4468	8491B	FDL1185	DS1185	FDL983	DS983	FTR3034R	ES2209R
590583C91	ES2090L	FAK4469	8492N	FDL1190	DS1190	FDL986	DS986	FTR3038L	ES2061L
590583C91	ES2210L	FAK4470	8492B	FDL1191	DS1191	FDL987	DS987	FTR3039L	ES3039L
590584C91	ES2090L	FAK4471	8500N	FDL1192	DS1192	FDL988	DS988	FTR3040R	ES3040R
590584C91	ES2091R	FAK4472	8500B	FDL1195	DS1195	FDL991	DS991	FTR304L	ES304L
590584C91	ES2204R	FAK4474	80053B	FDL1196	DS1196	FDL992	DS992	FTR304R	ES304R
590584C91	ES2209R	FAK4475	8503B	FDL1197	DS1197	FDL993	DS993	FTR3056	ES2113R
591945C91	80066B	FAK4477	8645B	FDL1198	DS1198	FDL994	DS994	FTR3056	ES2114R
591945C92	80066B	FAK4495	8577B	FDL1199	DS1199	FDL995	DS995	FTR3056	ES376R

Interchanges

Interchanges

International	Moog No.	Kaiser-Frazer	Moog No.	Kenworth	Moog No.	Kenworth	Moog No.	Mack	Moog No.
FTR3056	ES431R	K125G	8386N	A3144D524	ES423R	R200156	8514N	301SQ44	8518N
FTR323L	ES323L	K165G	8474B	A3144D525	ES423L	R200157	8514B	301SQ45A	8592B
FTR323R	ES323R	K40D	8454B	A3144D549	ES3031L	R200167	8489N	301SQ46A	8593B
FTR325L	ES325L	K40D	8454N	A3144D550	ES3030R	R200168	8518N	301SQ46B	8593B
FTR325R	ES325R	K40F	8458B	A3144E525	ES423L	R200170	8518B	301SQ47CP1	8601B
FTR330L	ES330L	K40G	8445B	A3144F448	ES2091R	R200172	8489B	301SQ52	80058B
FTR330R	ES330R	K40G	8445N	A3144G449	ES2090L	R200195	8590B	301SQA20	8336B
FTR332L	ES332L	K47F	8459B	A3144J296	ES431R	R200198	8571B	301SW44	8518B
FTR332R	ES332R	K48I	8389B	A3144K297	ES2040R	R200199	8553B	301SW45A	8592B
FTR346L	ES346L	K50D	8456B	A3144K297	ES431L	R201300	8612B	8226L24VU5183A1	DS1273
FTR346R	ES346R	K50F	8488B	A3144M533	ES2200L	R201309	80063C	8226L24VU5183A11	DS1273
FTR373L	ES373L	K50SX15	8336B	A3144N534	ES2201R	R201310	8611B	8226L24VU8047B1	DS1273
FTR373R	ES373R	K51G	8490T	A3144Q225	ES187L	R201315	80063C	8226L24VU8047B11	DS1273
FTR376R	ES2113R	K51G	8492B	A3144Q459	ES3312R	R230068	ES423L	A3144D524	ES423R
FTR376R	ES2114R	K51G	8492N	A3144R226	ES187R	R230069	ES423R	A3144E525	ES423L
FTR376R	ES376R	K55D	8560B	A3144R357	ES325L	R230070	ES431R	A3144U438	ES2090L
FTR376R	ES431R	K55D	8560N	A3144R358	ES325R	R230071	ES431L	A3144V437	ES2091R
FTR405L	ES405L	K60F	8357B	A3144U437	ES2090L	R230090	ES3312R	ADL9977	DS300001
FTR405R	ES405R	K60F	8357N	A3144U437	ES2091R	R230091	ES3031L	KIT195	8590B
FTR411L	ES411L	K68I	8385B	A3144V438	ES2090L	R230092	ES3030R	KIT198	8571B
FTR411R	ES411R	K70D	8479B	A3144V438	ES2091R			R200195	8590B
FTR423L	ES423L	K70D	8479N	A3144V438	ES2204R			R200198	8571B
FTR423R	ES423R	K70D	8507B	K162280	DS992	10QH242P1	ES187R	R230090	ES3312R
FTR431L	ES2116L	K70D	8507N	K162311	DS993	10QH243P2	ES187L	R230091	ES3031L
FTR431L	ES376L	K70F	8500B	K162363	DS994	10QH248	ES187R	R230092	ES3030R
FTR431L	ES431L	K70F	8500N	K162375	DS995	10QH248P2	ES187L		
FTR431R	ES2113R	K70G	8491B	K162376	DS996	10QH248P4	ES2116L		
FTR431R	ES2114R	K70G	8491N	K162385	DS997	10QH248P4	ES376L	aremont Corporation	Moog No.
FTR431R	ES376R	K75D	8562B	K162420	DS998	10QH248P5	ES431L	KB391C	8490T
FTR431R	ES431R	K75D	8562N	K162536	DS1454	10QH248P5	ES2091R	KB401	8375B
FTR434L	ES434L	K75F	8568B	KIT123	8386B	10QH248P5	ES2204R	KB408	8357B
FTR8224	ES3204L	K901L	8489B	KIT123	8386N	10QH248P5	ES2209R	KB431	8389B
FTR8225	ES3205R	K901L	8489N	KIT1300	8612B	10QH248P6	ES2090L	KB432	8385B
FTR8407	ES3217L	K921L	8553B	KIT1303	8612B	10QH248P6	ES2210L	KB450	8386B
FTR8408	ES3218R	K931C	8572B	KIT144	8386B	10QH310P1	ES431L	KB463	8462B
FTR8409	ES3219L	K931F	8572B	KIT144	8386N	10QH310P1	ES431R	KB466	8588B
FTR8410	ES3220R	K95F	8573B	KIT156	8514B	10QH310P1	ES2090L	KB471	8456B
R200198	8571B	K95G	8462B	KIT156	8514N	10QH311P1	ES2091R	KB472	8454B
R201309	80063C	K95G	8462N	KIT157	8514B	10QH311P1	ES2091R	KB472D	8454N
R201310	8611B	K970R	8514B	KIT157	8514N	10QH312P1	ES2090L	KB477	8507B
R201315	80063C	K970R	8514N	KIT162280	DS992	10QH312P1	ES2091R	KB480	8474B
R230068	ES423L	K98I	8375B	KIT162311	DS993	10QH38	ES2257R	KB489	8386N
R230069	ES423R	KD901R	8519B	KIT162363	DS994	10QH38	ES405R	KB493	8488B
R230070	ES431R	KD901R	8519N	KIT162375	DS995	10QH39P1	ES431L	KB496	8519N
R230071	ES431L	KH901L	8518B	KIT162376	DS996	10QH39P1	ES431R	KB496B	8519B
R230090	ES3312R	KH901L	8518N	KIT162385	DS997	10QU310P1	ES431L	KB499	8462N
R230091	ES3031L	KH931L	8571B	KIT162420	DS998	13QC3273P13	DS1313	KB501	8445B
R230092	ES3030R			KIT167	8489B	13QC3273P17	DS1254	KB503	8507N
		Kenworth	Moog No.	KIT167	8489N	13QC3273P18	DS1253	KB504	8489N
		1006148	ES423L	KIT167	8489N	18QK201	ES3252R	KB506	8491N
		1006149	ES423R	KIT168	8518B	18QK204M2	ES3252R	KB506B	8491B
8125403280	8659B	1008500	8633C	KIT168	8518N	18QK214	ES3252R	KB507	8492N
8125403290	8660B	1009009	ES3298L	KIT170	8518B	18QK23A	ES2114R	KB507B	8492B
8125403300	8661B	1009010	ES3297R	KIT170	8518N	18QK23A	ES431R	KB509	8500N
8125481070	ES3274L	18QK23A	ES2114R	KIT172	8489B	18QK28A	ES2116L	KB509B	8500B
8125481080	ES3275R	806355	8618C	KIT172	8489N	18QK28A	ES431L	KB517	8503B
8125481100	ES3270L	817018	ES3477	KIT195	8590B	18QK29301	ES431R	KB526B	8514B
8125481110	ES3271R	817019	ES3476	KIT198	8571B	205SQ11	8386B	KB526D	8514N
8889360850	ES2090L	820626	ES2090L	KIT199	8553B	205SQ11	8386N	KB534B	8553B
8889360860	ES2091R	820627	ES2091R	L24SV8101A15	ES2091R	205SQ12	8518B	KB535B	8567B
8944196082	ES3335R	820694	ES2090L	L24SV8101A15	ES2204R	205SQ12	8518N	KB538B	8568B
8944196092	ES3336L	820695	ES2091R	L24SV8101A15	ES2209R	205SQ15	8553B	KB539D	8570N
		823078	80076B	L28SV5052A1	ES2114R	205SQ15	8572B	KB540B	8570B
		A23144M273	ES2200L	L28SV5202A1	ES2209R	301SQ20	8336B	KB541B	8518B
K109I	8645B	A23144N274	ES2201R	L28SV5203A1	ES2210L	301SQ21	8357B	KB542D	8518N
K119I	8567B	A3144C237	ES346L	R200123	8386N	301SQ31C	80057B	KB543D	8562N
K120W	8527B	A3144D238	ES346R	R200144	8386B	301SQ32B	8592B	KB544D	8560N
K125G	8386B					301SQ44	8518B	KB546B	8573B

Interchanges

aremont Corporati	Moog No.	Marmon	Moog No.	McQuay-Norris	Moog No.	McQuay-Norris	Moog No.	Mevotech	Moog No.
KB547B	8571B	R230092	ES3030R	ES323R	ES323R	KA244	8514N	MES2036R	ES2036R
KB548B	8572B	Massey-Ferguson	Moog No.	ES325L	ES325L	KA246	8491B	MES2062R	ES2062R
KB549B	8577B	180381M91	ES416R	ES325R	ES325R	KA247	8519B	MES323L	ES323L
KB550D	8587N	McQuay-Norris	Moog No.	ES330L	ES330L	KA249	8492N	MES323R	ES323R
KB551B	8579B			ES330R	ES330R	KA250	8491N	MES373L	ES373L
KB552B	8581B	DS1034	DS1034	ES332L	ES332L	KA256	8489N	MES373R	ES373R
KB553D	8581N	DS1064	DS1064	ES332R	ES332R	KA257	8489B	MES405L	ES405L
KB554B	8583B	DS584	DS584	ES346L	ES346L	KA258	8462N	MES405R	ES405R
KB555D	8583N	DS659	DS659	ES346L	ES376L	KA261	8514N	MES423L	ES423L
KB558B	8585B	DS685	DS685	ES346R	ES346R	KA264	8500N	MES423R	ES423R
KB560B	8592B	DS733	DS733	ES346R	ES376R	KA269	8514B	MES431L	ES431L
KB561B	8593B	DS800	DS800	ES371K	ESK371	KA274	8454B	MES431R	ES431R
KB562B	8601B	DS803	DS803	ES373L	ES373L	KA277	8518N	Mitsubishi	Moog No.
KB563B	8590B	DS835	DS835	ES373R	ES373R	KA2771	8518N	MW033300	ES2556L
KB565B	8605B	DS845	DS845	ES376L	ES376L	KA278	8518B	MW033301	ES2556L
		DS867	DS867	ES376R	ES376R	KA2781	8518B	MW033301	ES2557R
		DS872	DS872	ES405L	ES405L	KA279	8503B		
Marmon	Moog No.	DS873	DS873	ES405R	ES405R	KA279	8567B	Napa	Moog No.
A23144M273	ES2200L	DS880	DS880	ES411L	ES411L	KA281	8500B	2274240	DS1218
A23144N274	ES2201R	DS881	DS881	ES411R	ES411R	KA281010	8500B010	2621013	8459B
A3144C237	ES346L	DS907	DS1024	ES416L	ES416L	KA282	8519B	2621013	8471B
A3144D238	ES346R	DS908	DS908	ES416R	ES416R	KA286	8488B	2621016	8492B
A3144D524	ES423R	DS910	DS910	ES423L	ES423L	KA286010	8488B010	2621017	8491B
A3144E525	ES423L	DS929	DS929	ES423R	ES423R	KA291	8553B	262101701	8491B010
A3144J296	ES431R	DS930	DS930	ES431L	ES431L	KA292	8514B	2621017010	8491B010
A3144K297	ES2040R	DS948	DS948	ES431R	ES2116L	KA292	8514N	2621018	8500B
A3144K297	ES431L	ES150L	ES150L	ES431R	ES431R	KA293	8514B	262101801	8500B010
A3144M533	ES2200L	ES150R	ES150R	ES434L	ES434L	KA296	8560N	2621018010	8500B010
A3144N534	ES2201R	ES176L	ES176L	ES60L	ES158L	KA297	8562N	2621161	8207B
A3144Q225	ES187L	ES176R	ES176R	ES60R	ES158R	KA298	8492B	2621275	8336B
A3144R226	ES187R	ES187L	ES187L	KA1161	8207B	KA300	8573B	2621307	8456B
A3144U437	ES2090L	ES187R	ES187R	KA12410	8458B010	KA301	8572B	2621331	8343B
A3144U437	ES2091R	ES194L	ES194L	KA124R	8343B	KA302	8571B	2621336	8375B
A3144V438	ES2090L	ES194R	ES194R	KA124R	8490T	KA303	8560B	262135101	8440B
A3144V438	ES2091R	ES2030R	ES2030R	KA127	8357B	KA304	8562B	2621351010	8440B
KIT123	8386B	ES2035L	ES2035L	KA1275	8336B	KA305	8570N	2621360	8385B
KIT123	8386N	ES2036R	ES2036R	KA1360	8385B	KA306	8570B	262136001	8385B015
KIT144	8386B	ES2040R	ES2040R	KA1360015	8385B015	KA307	8577B	2621360015	8385B015
KIT144	8386N	ES2061L	ES2061L	KA1390	8428B	KA308	8585B	2621361	8389B
KIT156	8514B	ES2062R	ES2062R	KA140	8375B	KA309	8583N	262136101	8441B
KIT156	8514N	ES2069R	ES405R	KA1417	8454B	KA310	8581N	2621361015	8441B
KIT157	8514B	ES2070L	ES405L	KA1463	8484T	KA311	8567N	2621364	8386B
KIT157	8514N	ES2082R	ES2082R	KA1489	8445N	KA312	8579B	2621386	8426B
KIT167	8489B	ES2083L	ES2083L	KA161	8336B	KA313	8583B	2621390	8428B
KIT167	8489N	ES2090L	ES2090L	KA164	8389B	KA314	8581B	2621391	8503B
KIT168	8518B	ES2090L	ES2210L	KA164015	8441B	KA315	8456B	2621406	8462B
KIT168	8518N	ES2091R	ES2091R	KA187	8426B	KA315	8587B	2621407	80059B
KIT170	8518B	ES2091R	ES2204R	KA191	8343B	KA316	8587N	2621413	8458B
KIT170	8518N	ES2091R	ES2209R	KA198	8357B	KA317	8519B	262141301	8458B010
KIT172	8489B	ES235L	ES235L	KA205	8445B	KA317	8568B	2621413010	8458B010
KIT172	8489N	ES235NL	ES235L	KA213	8462B	KA321	8590B	2621414	8519B
KIT195	8590B	ES235NR	ES235R	KA214	8458B	KA323	8592B	262141401	8519B010
KIT198	8571B	ES235R	ES235R	KA214010	8458B010	KA324	8593B	2621417	8454B
KIT199	8553B	ES2614	ES2614R	KA217	8459B	KA325	8601B	2621421	8479B
R200123	8386N	ES262L	ES262L	KA218	8519N	KA326	8605B	2621421	8507B
R200144	8386B	ES262R	ES262R	KA219	8479B	KA331	8613B	2621422	8386N
R200156	8514N	ES26L	ES26L	KA219	8507B	KS304	8562N	2621425	8519N
R200157	8514B	ES26R	ES26R	KA221	8474B			2621431	8479N
R200167	8489N	ES3026L	ES3026L	KA224	8454N	MERIT	Moog No.	2621431	8507N
R200168	8518N	ES3027R	ES3027R	KA227	8386N	R201475	8007C	2621440	8357B
R200170	8518B	ES3032R	ES3032R	KA234	8527B	Mevotech	Moog No.	2621443	8527B
R200172	8489B	ES304L	ES304L	KA236	8386B	MDS1064	DS1064	2621445	8474B
R200195	8590B	ES304R	ES304R	KA237	8357N	MDS949	DS949	2621452	8454N
R200198	8571B	ES3056	ES2113R	KA238	8386N	MES150L	ES150L	2621461	8488B
R200199	8553B	ES3056	ES2114R	KA239	8507N	MES150R	ES150R	2621461	8609B
R201300	8612B	ES323L	ES323L	KA241	8488B	MES2035L	ES2035L	262146101	8488B010
R230090	ES3312R								
R230091	ES3031L								

Interchanges

Interchanges

Napa	Moog No.	Napa	Moog No.	Napa	Moog No.	Napa	Moog No.	Napa	Moog No.
2621461010	8488B010	2621594	8633B	2692314	ES405L	2693328	ES3335R	2721631	DS954
2621463	8484T	2621594	8633C	2692315	ES405R	2693357	ES2556L	2721633	DS1136
2621464	8489N	2621597	8639B	2692432	ES2030R	2693358	ES2557R	2721644	DS1185
2621466	8357N	2621598	8643B	2692437	ES2035L	2695098	ES3030R	2721645	DS1190
2621467	8462N	2621599	8641B	2692438	ES2036R	2695099	ES3031L	2721646	DS1191
2621470	8445B	2621603	8637B	2692466	ES2061L	2695100	ES3039L	2721647	DS1192
2621472	8492N	2621604	80063B	2692467	ES2062R	2695101	ES3040R	2721648	DS1197
2621473	8491N	2621604	80063C	2692474	ES405R	2695564	DS1253	2721649	DS1198
2621475	8343B	2621605	80066B	2692475	ES405L	2695565	DS1254	2721650	DS1199
2621475	8490T	2621609	8618C	2692483	ES2083L	2696104	DS1362S	2721651	DS1200
2621483	8500N	2621609	8647B	2692484	ES2082R	2696105	DS1363S	2721652	DS1179
2621489	8445N	2621610	8631B	2692485	ES2091R	2696106	DS1379S	2721654	DS1204
2621490	80053B	2621635	8655B	2692485	ES2204R	2696107	DS1380S	2721735	DS1214
2621491	8503B	2621637	8653B	2692485	ES2209R	2699501	DS1367A	2721736	DS1215
2621491	8567B	2621638	80068C	2692486	ES2090L	2699502	DS1368A	2721737	DS1216
2621506	8514B	2621639	80069B	2692486	ES2210L	2721004	DS584	2721738	DS1217
2621507	8489B	2621640	8659B	2692635	ES194R	2721010	DS659	2721742	DS1305
2621509	8645B	2621641	8660B	2692636	ES194L	2721014	DS733	2721744	DS1302
2621512	8518N	2621642	8661B	2692644	ES2113R	2721020	DS800	2721745	DS1278
2621513	8518B	2621647	80071C	2692644	ES2114R	2721022	DS803	2721746	DS1265
2621514	8514N	2621648	80072B	2692645	ES2116L	2721031	DS835	2721747	DS1267
2621525	8553B	2621649	80073C	2692645	ES431R	2721033	DS982	2721748	DS1270
2621529	8560N	2621651	80074B	2692663	ES2613L	2721036	DS988	2721749	DS1281
2621532	8562N	2621652	80076B	2692663	ES2614R	2721131	DS910	2721750	DS1370
2621537	8568B	2621653	80077B	2692664	ES2613L	2721134	DS845	2721751	DS1272
2621547	8570N	2621654	80078C	2692700	ES2224L	2721135	DS872	2721752	DS1369
2621548	8570B	2623292	ES3284L	2692700	ES434L	2721136	DS873	2721753	DS1271
262154801	8570B010	26236600002	80079C	2692701	ES2225R	2721150	DS908	2721754	DS1277
2621548010	8570B010	2691014	ESK371	2692702	ES2257R	2721203	DS991	2721755	DS1259
2621550	8572B	2692003	ES26L	2692703	ES2200L	2721210	DS929	2721756	DS1366
2621551	8573B	2692004	ES26R	2692704	ES2201R	2721211	DS997	2721757	DS1269
2621552	8562B	2692007	ES158L	2692709	ES2207R	2721212	DS998	2721764	DS1220
2621553	8560B	2692008	ES158R	2692710	ES2208R	2721575	DS952	2721777	DS1273
2621554	8571B	2692022	ES150L	2692751	ES3026L	2721576	DS970	2721778	DS1283
2621555	8577B	2692023	ES150R	2692752	ES3027R	2721578	DS969	2721779	DS1340
262155501	8577B010	2692032	ES176L	2692753	ES3032R	2721579	DS987	2721780	DS1371
2621555010	8577B010	2692033	ES176R	2692939	ES3252R	2721580	DS941	2721781	DS1409
2621556	8585B	2692041	ES187L	2692940	ES3297R	2721581	DS946	2721783	DS1442
2621557	8579B	2692042	ES187R	2692941	ES3298L	2721582	DS986	2721784	DS1445
2621558	8581B	2692051	ES235L	2692942	ES3219L	2721583	DS979	2721785	DS1446
262155800	8581B002	2692052	ES235R	2692943	ES3220R	2721590	DS949	2721786	DS1447
2621558002	8581B002	2692064	ES262L	2692944	ES3218R	2721592	DS999	2724020	DS685
2621559	8581N	2692065	ES262R	2692945	ES3217L	2721593	DS1044	2724089	DS880
2621560	8583B	2692097	ES304L	2692948	ES3086L	2721594	DS945	2724095	DS867
2621561	8583N	2692098	ES304R	2692949	ES3087R	2721595	DS958	2724103	DS881
2621562	8567N	2692124	ES323L	2692951	ES3178R	2721596	DS973	2724116	DS930
2621564	8456B	2692125	ES323R	2692952	ES3214R	2721597	DS971	2724122	DS996
2621564	8587B	2692138	ES330L	2692954	DS1293	2721599	DS977	2724123	DS995
2621565	8587N	2692139	ES330R	2692963	ES3216R	2721600	DS948	2724124	DS992
2621569	8601B	2692142	ES332L	2693039	ES3476	2721602	DS1067	2724125	DS994
2621570	8593B	2692143	ES332R	2693040	ES3477	2721603	DS1064	2724126	DS993
2621571	8592B	2692158	ES346L	2693089	ES3268L	2721604	DS1034	2724148	DS953
2621572	8590B	2692158	ES376L	2693090	ES3269R	2721605	DS1021	2724156	DS943
2621575	80056B	2692159	ES346R	2693091	ES3270L	2721609	DS963	2724157	DS944
2621576	8605B	2692159	ES376R	2693092	ES3271R	2721617	DS938	2724158	DS955
2621577	80055B	2692159	ES431R	2693093	ES3274L	2721618	DS939	2724159	DS956
2621579	8610B	2692189	ES373L	2693094	ES3275R	2721619	DS1033	2724162	DS1026
2621580	8612B	2692190	ES373R	2693152	ES3177L	2721620	DS1020	2724163	DS983
2621582	8613B	2692234	ES411L	2693153	ES3176R	2721621	DS974	2724164	DS1025
2621583	8611B	2692235	ES411R	2693293	ES3283R	2721622	DS972	2724165	DS1030
2621584	8617B	2692240	ES416L	2693294	ES3312R	2721623	DS1022	2724167	DS1035
2621585	8618C	2692241	ES416R	2693295	ES3329L	2721624	DS1024	2724177	DS1182
2621586	8631C	2692243	ES423L	2693296	ES3328R	2721625	DS1027	2724178	DS1184
2621589	80057B	2692244	ES423R	2693297	ES3443L	2721626	DS1028	2724180	DS1195
2621591	80058B	2692311	ES2040R	2693298	ES3442R	2721628	DS1031	2724181	DS1196
2621592	80063C	2692311	ES431L	2693327	ES3336L	2721629	DS976	2724182	DS1180

Interchanges

Napa	Moog No.	Navistar	Moog No.	Navistar	Moog No.	Perfect Circle	Moog No.	Perfect Circle	Moog No.
2724183	DS1203	306920C91	8590B	588808C91	8617B	2621421	8507B	2621592	80063C
2724184	DS1205	306921C93	8503B	590583C91	ES2090L	2621422	8386N	2621594	8633C
2724185	DS1206	317416C92	8474B	590584C91	ES2091R	2621425	8519N	2621597	8639B
2724186	DS1207	346754C92	ES416L	591945C91	8645B	2621431	8507N	2621598	8643B
2724195	DS1219	371416C91	8514N	592872C91	ES3032R	2621440	8357B	2621599	8641B
2724203	DS1294A	377635C91	ES411L	597258C91	8571B	2621443	8527B	2621603	8637B
2724204	DS1291A	377636C91	ES411R	61556R91	8375B	2621445	8474B	2621608	8492B
2724205	DS1295A	398313C92	DS969	69576R92	8386N	2621452	8454N	2621609	8618C
2724207	DS1303	399942C91	8567B	69971R91	8389B	2621461	8488B	2621610	8631B
2724210	DS1264	399942C93	8567B	70594R91	8385B	2621461010	8488B010	2691014	ESK371
2724211	DS1298	399942C93	8567N	868292R91	ES416L	2621463	8484T	2692003	ES26L
2724213	DS1263	400745C92	8568B	870148R91	8489N	2621464	8489N	2692004	ES26R
2724214	DS1337	402032C91	DS971	870148R92	8489N	2621466	8357N	2692007	ES158L
2724215	DS1266	402034C91	DS972	894049R93	ES187L	2621467	8462N	2692008	ES158R
2724216	DS1268	402036C91	DS973	894050R93	ES187R	2621470	8445B	2692022	ES150L
2724219	DS1344	402038C91	DS974	894144R91	ES150L	2621472	8492N	2692023	ES150R
2724220	DS1299A	408547C91	8645B	894145R91	ES150R	2621473	8491N	2692032	ES176L
2724222	DS1313	408547C93	8645B	966157R92	8518N	2621475	8490T	2692033	ES176R
2724240	DS1218	438368C91	ES423L	969055R91	ES431L	2621482	8489B	2692041	ES187L
2724241	DS1221	438369C91	ES423R	969056R91	ES431R	2621483	8500N	2692042	ES187R
2724263	DS1234	447094C91	ES411L	974012R91	8386B	2621489	8445N	2692047	ES194L
2724265	DS1275	447095C91	ES411R	974012R91	8386N	2621491	8567B	2692048	ES194R
2724266	DS1276	449634C91	DS1028	ETN08060355	8618C	2621506	8514B	2692051	ES235L
2724267	DS1350	450062C91	ES373R	L24SV5051A12	ES3294R	2621508	8567B	2692052	ES235R
2724268	DS1443	450063C91	ES373L	Pai	Moog No.	2621509	8645B	2692064	ES262L
2724269	DS1444	452344C91	8553B	AKP3490	8601B	2621510	8519B	2692065	ES262R
HKP3060	8657B	453831C91	DS1028	AKP9220	8593B	2621512	8518N	2692068	ES416L
HKP3200	80075C	459544C91	DS976	AKP9250	8592B	2621513	8518B	2692085	ES416L
Navistar	Moog No.	46502HX	ES26R	AKP9821	8518N	2621514	8514N	2692097	ES304L
110362R91	ES187L	46503HX	ES26L	AKP9822	8590B	2621525	8553B	2692098	ES304R
110362R92	ES187R	465697C91	DS977	AKP9823	8571B	2621529	8560N	2692124	ES323L
110363R92	ES187R	470572C91	8583N	ARE9950	ES431R	2621532	8562N	2692125	ES323R
127241R91	ES235L	470752C9	8583B	ARE9955	ES187R	2621537	8568B	2692138	ES330L
127242R91	ES235R	472093C91	8645B	ARE9970	ES405R	2621547	8570N	2692139	ES330R
134455R91	8441B	472094C91	8581B	ARE9984	ES187L	2621548	8570B	2692142	ES332L
134456R91	8385B015	472095C91	8577B	ARE9990	ES431L	2621548010	8570B010	2692143	ES332R
151007R91	8519N	473695C91	8577B	Perfect Circle	Moog No.	2621550	8572B	2692158	ES346L
155932R91	8386B	474520C91	8571B	2621012	8490T	2621551	8573B	2692159	ES346R
155932R92	8386N	480645C91	DS979	2621013	8471B	2621552	8562B	2692189	ES373L
1648204C91	8577B	480645C92	DS979	2621016	8492B	2621553	8560B	2692190	ES373R
1649637C91	ES411L	485033C92	DS979	2621017	8491B	2621554	8571B	2692234	ES411L
1649638C91	ES411R	486354C91	ES2090L	2621017010	8491B010	2621555	8577B	2692235	ES411R
1658897C92	DS1020	486355C91	ES2091R	2621018	8500B	2621555010	8577B010	2692240	ES416L
1660271	8637B	489023C91	DS1034	2621018010	8500B010	2621556	8585B	2692241	ES416R
1660272C91	ES373R	491611C92	8581B	2621019	8503B	2621557	8579B	2692243	ES423L
1660273C91	ES373L	491665C91	ES2207R	2621161	8207B	2621558	8581B	2692244	ES423R
1661437C92	DS1214	491666C91	ES2208R	2621275	8336B	2621558002	8581B002	2692311	ES431L
1661867C91	DS1215	493092C91	8579B	2621331	8343B	2621559	8581N	2692312	ES431R
1668412C92	8657B	493093C91	8581B	2621336	8375B	2621560	8583B	2692314	ES405L
185120R91	ES262L	493094C92	8581B	2621336	8375B	2621561	8583N	2692315	ES405R
185121R91	ES262R	493095C91	8583B	2621351010	8440B	2621562	8567N	2692316	ES176L
194688R91	ES304L	493095C92	8579B	2621360	8385B	2621564	8587B	2692317	ES176R
201600R93	8474B	503523C91	DS1020	2621360015	8385B015	2621565	8587N	2692432	ES2030R
219403R91	ES176L	506661C91	ES2613L	2621361	8389B	2621569	8601B	2692437	ES2035L
219404R91	ES176R	506662C91	ES2614R	2621361015	8441B	2621570	8593B	2692438	ES2036R
229265R91	8514B	506684C91	ES2204R	2621364	8386B	2621571	8592B	2692447	ES2040R
263498C91	ES235L	507835C91	ES411L	2621386	8426B	2621572	8590B	2692466	ES2061L
263499C91	ES235R	507836C91	ES411R	2621390	8428B	2621574	8613B	2692467	ES2062R
303136C92	8519B	507837C91	ES423L	2621391	8503B	2621576	8605B	2692474	ES405R
303137C92	8386B	507838C91	8590B	2621404	8445B	2621579	8610B	2692475	ES405L
303138C92	8514B	549800C91	8590B	2621406	8462B	2621580	8612B	2692483	ES2083L
303138C92	8514N	577684C91	8612B	2621413	8458B	2621582	8613B	2692484	ES2082R
303138R92	8514B	581063C91	ES2204R	2621413010	8458B010	2621583	8611B	2692485	ES2091R
303139C91	8389B	586806C91	8610B	2621414	8519B	2621584	8617B	2692486	ES2090L
303139C92	8489N	586806C92	8610B	2621417	8454B	2621585	8618C	2692635	ES194R
303140C92	8518B	586809C91	8610B	2621418	8456B	2621586	8631C	2692636	ES194L

Interchanges

Interchanges

Perfect Circle	Moog No.	Perfect Circle	Moog No.	Peterbilt	Moog No.	Rockwell	Moog No.	Rockwell	Moog No.
2692644	ES2114R	2724089	DS880	A3144M533	ES2200L	A23144M273	ES2200L	KIT195	8590B
2692645	ES2116L	2724095	DS867	A3144N534	ES2201R	A23144N274	ES2201R	KIT198	8571B
2692663	ES2613L	2724103	DS881	A3144Q225	ES187L	A23144V386	ES176R	KIT199	8553B
2692664	ES2614R	2724116	DS930	A3144Q226	ES187R	A3102R1916	DS1379S	R200001	8490T
2692700	ES2224L	2724122	DS996	A3144R226	ES187R	A3102Y3457	DS1379S	R200003	8375B
2692701	ES2225R	2724123	DS995	A3144U437	ES2090L	A3144A547	ES2090L	R200006	8357B
2692709	ES2207R	2724124	DS992	A3144V438	ES2091R	A3144A547	ES2210L	R200007	8389B
2692710	ES2208R	2724125	DS994	KIT123	8386B	A3144C185	ES194L	R200008	8385B
2721004	DS584	2724126	DS993	KIT123	8386N	A3144C185	ES2083L	R200009	8385B015
2721010	DS659	2724148	DS953	KIT144	8386B	A3144C237	ES346R	R200010	8428B
2721014	DS733	2724156	DS943	KIT144	8386N	A3144C549	ES3031L	R200011	8462B
2721020	DS800	2724158	DS955	KIT156	8514B	A3144D186	ES194R	R200012	8458B
2721022	DS803	2724159	DS956	KIT156	8514N	A3144D186	ES2082R	R200013	8456B
2721029	ES434L	2724162	DS1026	KIT157	8514B	A3144D238	ES346R	R200014	8454B
2721031	DS835	2724164	DS1025	KIT157	8514N	A3144D524	ES423R	R200015	8454N
2721033	DS982	2724177	DS1182	KIT167	8489B	A3144D550	ES3030R	R200016	8507B010
2721036	DS988	2724178	DS1184	KIT167	8489N	A3144E525	ES423R	R200017	8527B
2721131	DS910	2724180	DS1195	KIT168	8518B	A3144E551	ES3032R	R200018	8488B
2721134	DS845	2724181	DS1196	KIT168	8518N	A3144F448	ES2091R	R200018	8609B
2721135	DS872	2724182	DS1180	KIT170	8518B	A3144F448	ES2204R	R200019	8488B010
2721136	DS873	2724183	DS1203	KIT170	8518N	A3144F448	ES2209R	R200021	8519B010
2721150	DS908	2724184	DS1205	KIT172	8489B	A3144F526	ES3312R	R200022	8462N
2721187	DS881	2724185	DS1206	KIT172	8489N	A3144G449	ES2090L	R200023	8357N
2721203	DS991	2724186	DS1207	KIT195	8590B	A3144G449	ES2210L	R200024	8491N
2721210	DS929	Peterbilt	Moog No.	KIT198	8571B	A3144J296	ES2113R	R200025	8491B
2721211	DS997			KIT199	8553B	A3144J296	ES2114R	R200026	8492N
2721212	DS998	1002163	DS1179	R201309	80063C	A3144J296	ES376R	R200027	8492B
2721575	DS952	1002253	DS1283	R201310	8611B	A3144J296	ES431R	R200028	8500N
2721576	DS970	1002260	DS1180	R201315	80063C	A3144K297	ES2116L	R200029	8500B
2721578	DS969	1002301	DS1182	R230068	ES423L	A3144K297	ES376L	R200031	80053B
2721579	DS987	1002417	DS1184	R230069	ES423R	A3144K297	ES431L	R200032	8503B
2721580	DS941	1002419	DS1185	R230070	ES431R	A3144M195	ES176L	R200034	8645B
2721581	DS946	1002498	DS1179	R230071	ES431L	A3144M533	ES2200L	R200042	8567B
2721582	DS986	1002499	DS1180	R230072	ES2090L	A3144N456	ES423R	R200043	8567N
2721583	DS979	1002601	DS1182	R230073	ES2091R	A3144N458	ES423L	R200044	8568B
2721590	DS949	1002602	DS1184	R230090	ES3312R	A3144N534	ES2201R	R200045	8570N
2721592	DS999	1002603	DS1185	R230091	ES3031L	A3144Q225	ES187L	R200046	8570B
2721593	DS1044	1006148	ES423R	R230092	ES3030R	A3144Q459	ES3312R	R200047	8562B
2721594	DS945	1006149	ES423L	Reo	Moog No.	A3144R226	ES187R	R200047	8562N
2721595	DS958	1008500	8633C	1059D1	ES187L	A3144R356	ES325R	R200048	8560N
2721596	DS973	1009009	ES3298L	1293D1	ES304R	A3144S357	ES325L	R200050	8573B
2721597	DS971	1009010	ES3297R	1294D1	ES304L	A3144U385	ES304L	R200051	8572B
2721599	DS977	102163	DS1179	718114K2	ES176R	A3144V386	ES304R	R200052	8577B
2721600	DS948	102260	DS1180	718115K2	ES176L	A3144Z546	ES2091R	R200053	8587N
2721603	DS1064	102301	DS1182	780D1	ES194R	A3144Z546	ES2204R	R200054	8579B
2721604	DS1034	102417	DS1184	780D1	ES2082R	A3144Z546	ES2209R	R200055	8581B
2721617	DS938	102419	DS1185	815D1	ES194L	A3144Z547	ES2090L	R200056	8581N
2721618	DS939	806355	8618C	815D1	ES2083L	KIT123	8386N	R200057	8583B
2721619	DS1033	817018	ES3477	887783K2	ES2116L	KIT1300	8612B	R200058	8583N
2721620	DS1020	817019	ES3476	887783K2	ES376L	KIT1310	80063B	R200060	8587B
2721621	DS974	820626	ES2090L	887783K2	ES431L	KIT1310	8611B	R200061	8585B
2721622	DS972	820627	ES2091R	887784K2	ES2113R	KIT1315	80063C	R200063	8592B
2721626	DS1028	820694	ES2090L	887784K2	ES2114R	KIT142	8519B	R200064	8593B
2721629	DS976	820695	ES2091R	887784K2	ES376R	KIT143	8479B	R200065	8601B
2721631	DS954	823078	80076B	887784K2	ES431R	KIT143	8507B	R200066	8613B
2721644	DS1185	A23144M273	ES2200L	Rockwell	Moog No.	KIT144	8386B	R200067	80055B
2721645	DS1190	A23144N274	ES2201R	220TR118	ES3031L	KIT153	8474B	R200068	8605B
2721646	DS1191	A3144C237	ES346L	220TR119	ES3030R	KIT154	8519N	R200069	80056B
2721647	DS1192	A3144D238	ES346R	A13144E551	ES3032R	KIT155	8479N	R200071	80058B
2721648	DS1197	A3144D524	ES423R	A13144F370	ES2208R	KIT156	8507N	R200072	80057B
2721649	DS1198	A3144E525	ES423L	A13144J296	ES2207R	KIT157	8514N	R200073	8610B
2721650	DS1199	A3144E525	ES423L	A13144L194	ES304R	KIT157	8514B	R200074	8617B
2721651	DS1200	A3144F448	ES2091R	A13144M195	ES304R	KIT167	8489N	R200123	8386N
2721652	DS1179	A3144G449	ES2090L	A23144J192	ES187R	KIT168	8518N	R200141	80059B
2721654	DS1204	A3144J296	ES431R	A23144K193	ES187L	KIT170	8518B	R200142	8519B
2724020	DS685	A3144K297	ES431L			KIT172	8489B	R200143	8479B

Interchanges

Interchanges

Rockwell	Moog No.	Rockwell	Moog No.	Rockwell	Moog No.	Rockwell	Moog No.	Rockwell	Moog No.
R200143	8507B	R230039	ES2083L	R230209	ES3026L	R250073	DS1185	R250364	DS1277
R200144	8386B	R230040	ES434L	R230210	ES3027R	R250085	DS1028	R250365	DS1278
R200153	8474B	R230041	ES2113R	R230213	ES2090L	R250089	DS1190	R250366	DS1281
R200154	8519N	R230041	ES2114R	R230213	ES2210L	R250090	DS1033	R250367	DS1293
R200155	8479N	R230042	ES2116L	R230217	ES3086L	R250091	DS1025	R250370	DS1298
R200155	8507N	R230051	ES2203R	R230218	ES3087R	R250092	DS1026	R250371	DS1299A
R200156	8514N	R230052	ES2204R	R230231	ES2613L	R250093	DS1024	R250372	DS1302
R200157	8514B	R230055	ES2210L	R230400	ES158L	R250095	DS1191	R250373	DS1303
R200167	8489N	R230056	ES2225R	R230401	ES158R	R250096	DS1192	R250377	DS1313
R200168	8518N	R230060	ES187L	R230405	ES2030R	R250098	DS1203	R250378	DS1337
R200170	8518B	R230061	ES187L	R230410	ES3178R	R250099	DS1195	R250380	DS1340
R200172	8489B	R230061	ES187R	R230411	ES3214R	R250100	DS1196	R250384	DS1344
R200195	8590B	R230062	ES187L	R230412	ES3216R	R250101	DS1197	R250390	DS1362S
R200198	8571B	R230062	ES304L	R230413	ES3217L	R250102	DS1198	R250391	DS1363S
R200199	8553B	R230063	ES304R	R230414	ES3218R	R250103	DS1199	R250392	DS1366
R200219	8441B	R230064	ES325L	R230415	ES3219L	R250104	DS1200	R250393	DS1367A
R200226	8445B	R230065	ES325R	R230416	ES3220R	R250105	DS1204	R250394	DS1368A
R200232	8560B	R230066	ES346R	R230417	ES3252R	R250112	DS1214	R250395	DS1369
R200234	80059B	R230067	ES346L	R230418	ES3283R	R250113	DS1215	R250396	DS1370
R200235	8562B	R230068	ES423L	R230419	ES3284L	R250114	DS1216	R250397	DS1371
R200250	8633C	R230069	ES423R	R230420	ES3297R	R250115	DS1206	R250398	DS1379S
R200251	8631C	R230070	ES2113R	R230421	ES3298L	R250116	DS1205	R250399	DS1380S
R200265	8471B	R230070	ES2114R	R230423	ES3312R	R250117	DS1204	R250400	DS1409
R200266	8500B010	R230070	ES376R	R250001	DS1064	R250119	DS1217	ROCKWELL OE	Moog No.
R200267	8618C	R230070	ES431L	R250002	DS880	R250120	DS1218	A13144J296	ES2207R
R200268	8637B	R230070	ES431R	R250004	DS659	R250121	DS1219	A13144J296	ES2208R
R200269	8647B	R230071	ES2116L	R250006	DS685	R250122	DS1220	A13144L194	8474B
R200270	8631B	R230071	ES376L	R250009	DS733	R250123	DS1221	A13144M195	8527B
R200271	8484T	R230071	ES431L	R250012	DS800	R250300	DS867	A3144A547	ES2090L
R200272	8639B	R230071	ES431R	R250014	DS803	R250303	DS872	A3144C549	ES3031L
R200273	8643B	R230072	ES2090L	R250015	DS835	R250306	DS930	A3144D238	ES346R
R200275	8641B	R230072	ES2210L	R250019	DS845	R250309	DS938	A3144D524	ES423R
R200277	80066B	R230073	ES2091R	R250020	DS873	R250310	DS939	A3144D550	ES3030R
R201300	8612B	R230073	ES2204R	R250025	DS908	R250311	DS941	A3144E525	ES423L
R201309	80063C	R230073	ES2209R	R250026	DS910	R250313	DS1206	A3144E551	ES3032R
R201310	80063B	R230074	ES2200L	R250032	DS945	R250313	DS943	A3144F448	ES2091R
R201310	8611B	R230075	ES2201R	R250033	DS948	R250314	DS944	A3144G449	ES2090L
R201315	80063C	R230076	ES2207R	R250034	DS949	R250318	DS954	A3144J192	ES187R
R230000	ES26L	R230077	ES2208R	R250035	DS952	R250319	DS955	A3144J296	ES431L
R230001	ES26R	R230077	ES346L	R250036	DS953	R250320	DS956	A3144K297	ES431R
R230002	ES150L	R230080	ESK371	R250037	DS958	R250323	DS963	A3144L194	ES176R
R230003	ES150R	R230081	ES262R	R250043	DS969	R250326	DS977	A3144N456	ES423L
R230004	ES176L	R230082	ES262L	R250044	DS970	R250328	DS982	A3144N533	8612B
R230005	ES176R	R230086	ES3328R	R250045	DS971	R250329	DS983	A3144N534	8612B
R230006	ES235L	R230087	ES3329L	R250046	DS972	R250333	DS991	A3144O226	ES187R
R230007	ES235R	R230088	ES187R	R250047	DS973	R250334	DS1021	A3144P458	ES423R
R230008	ES330L	R230089	ES187L	R250048	DS974	R250335	DS1022	A3144Q225	ES187L
R230009	ES330R	R230090	ES3312R	R250049	DS976	R250337	DS1027	A3144U385	ES304L
R230012	ES332L	R230091	ES3030R	R250051	DS979	R250339	DS1030	A3144U388	ES2091R
R230013	ES332R	R230091	ES3031L	R250052	DS986	R250340	DS1031	A3144U438	ES2090L
R230018	ES373L	R230092	ES3030R	R250053	DS987	R250345	DS1044	A3144V386	ES304R
R230019	ES373R	R230092	ES3031L	R250054	DS988	R250346	DS1067	A3144V437	ES2091R
R230023	ES376R	R230095	ES3032R	R250055	DS992	R250347	DS1203	A3144Z546	ES2091R
R230024	ES405L	R230102	ES2091R	R250056	DS993	R250348	DS1207	KIT108	8336B
R230025	ES405R	R230102	ES2204R	R250057	DS994	R250349	DS1234	KIT123	8386B
R230028	ES411L	R230102	ES2209R	R250058	DS995	R250350	DS1253	KIT123	8386N
R230029	ES411R	R230103	ES2090L	R250059	DS996	R250351	DS1254	KIT1309	80063C
R230030	ES2035L	R230103	ES2210L	R250060	DS997	R250353	DS1259	KIT1309	8611B
R230031	ES2036R	R230104	ES3030R	R250061	DS998	R250356	DS1263	KIT1310	8611B
R230034	ES2061L	R230105	ES3031L	R250062	DS999	R250357	DS1265	KIT142	8519B
R230035	ES2062R	R230114	ES2113R	R250063	DS1020	R250358	DS1267	KIT142	8519N
R230036	ES405R	R230114	ES2114R	R250066	DS1034	R250359	DS1268	KIT143	8507B
R230037	ES405L	R230114	ES376R	R250067	DS1179	R250360	DS1269	KIT143	8507N
R230038	ES194R	R230114	ES431R	R250068	DS1180	R250361	DS1270	KIT144	8386B
R230038	ES2082R	R230117	ES3039L	R250070	DS1182	R250362	DS1271	KIT144	8386N
R230039	ES194L	R230118	ES3040R	R250072	DS1184	R250363	DS1272	KIT146	8474B

Interchanges

Interchanges

ROCKWELL OE	Moog No.	Sealed Power	Moog No.	Sealed Power	Moog No.	Sealed Power	Moog No.	Spicer	Moog No.
KIT153	8474B	802332R	ES332R	804948	DS948	808506B10	8491B010	4011013	ES187R
KIT154	8519B	802346L	ES346L	804949	DS949	808507	8492N	4011014	ES235L
KIT154	8519N	802346R	ES346R	804952	DS952	808507B	8492B	4011015	ES235R
KIT155	8507B	802373L	ES373L	804953	DS953	808509	8500N	4011018	ES262L
KIT155	8507N	802373R	ES373R	804954	DS954	808509B	8500B	4011019	ES262R
KIT156	8514B	802376L	ES376L	804955	DS955	808509B10	8500B010	4011024	ES304L
KIT156	8514N	802376R	ES376R	804956	DS956	808510B	8489B	4011025	ES304R
KIT157	8514N	802405L	ES405L	804958	DS958	808515	8445N	4011031	ES323L
KIT167	8489B	802405R	ES405R	804969	DS969	808517	8503B	4011032	ES323R
KIT167	8489N	802411L	ES411L	804970	DS970	808524B	8645B	4011033	ES330L
KIT168	8518B	802411R	ES411R	804971	DS971	808526B	8514B	4011034	ES330R
KIT168	8518N	802416L	ES416L	804972	DS972	808526D	8514N	4011035	ES332L
KIT170	8518B	802416R	ES416R	804973	DS973	808534B	8553B	4011036	ES332R
KIT170	8518N	802423L	ES423L	804974	DS974	808535B	8567B	4011042	ES346L
KIT172	8489B	802423R	ES423R	804976	DS976	808535D	8567N	4011042	ES376L
KIT172	8489N	802431L	ES431L	804977	DS977	808538B	8568B	4011043	ES346R
KIT195	8590B	802431R	ES431R	804979	DS979	808539D	8570N	4011059	ES373L
KIT198	8571B	802434L	ES434L	804980	DS979	808540B	8570B	4011060	ES373R
KIT199	8553B	80260L	ES158L	804982	DS982	808541B	8518B	4011091	ES411L
T138	8519B	80260R	ES158R	804983	DS983	808542D	8518N	4011092	ES411R
		8041020	DS1020	804986	DS986	808543D	8562B	4011096	ES416L
		8041025	DS1025	804987	DS987	808543D	8562N	4011097	ES416R
802150L	ES150L	8041026	DS1026	804988	DS988	808544D	8560B	4011099	ES423L
802150R	ES150R	8041028	DS1028	804991	DS991	808544D	8560N	4011100	ES423R
802176L	ES176L	8041033	DS1033	804992	DS992	808546B	8573B	4011115	ES2040R
802176R	ES176R	8041034	DS1034	804993	DS993	808547B	8571B	4011115	ES431L
802187L	ES187L	8041044	DS1044	804994	DS994	808548B	8572B	4011117	ES405L
802187R	ES187R	8041064	DS1064	804995	DS995	808549B	8577B	4011118	ES405R
8022030R	ES2030R	8041190	DS1190	804996	DS996	808550D	8587N	4011188	ES2030R
8022035L	ES2035L	8041191	DS1191	804997	DS997	808551B	8579B	4011191	ES2035L
8022036R	ES2036R	8041192	DS1192	804998	DS998	808552B	8581B	4011192	ES2036R
8022040R	ES2040R	8041195	DS1195	804999	DS999	808553D	8581N	4011212	ES2061L
8022061L	ES2061L	8041196	DS1196	808129N	8336B	808554B	8583B	4011213	ES2062R
8022062R	ES2062R	8041197	DS1197	808391C	8490T	808555D	8583N	4011217	ES405R
8022069R	ES405R	8041198	DS1198	808401N	8375B	808557B	8587B	4011218	ES405L
8022070L	ES405L	8041199	DS1199	808408	8357B	808558B	8585B	4011224	ES2083L
8022082R	ES2082R	8041200	DS1200	808431	8389B	808560B	8592B	4011225	ES2082R
8022083L	ES2083L	8041203	DS1203	80843115	8441B	808561B	8593B	4011226	ES2091R
8022090L	ES2090L	8041204	DS1204	808432	8385B	808562B	8601B	4011226	ES2209R
8022091R	ES2091R	8041205	DS1205	80843215	8385B015	808563B	8590B	4011227	ES2090L
8022113R	ES2113R	8041206	DS1206	808446	8426B	808565B	8605B	4011227	ES2210L
8022114R	ES2114R	8041207	DS1207	808448	8428B	808567B	8613B	4011337	ES194R
8022116L	ES2116L	804584	DS584	808450	8386B	808570B	8612B	4011338	ES194L
8022204R	ES2204R	804659	DS659	808463	8462B	808571B	8610B	4011345	ES2114R
8022207R	ES2207R	804685	DS685	808466	8458B	808572B	8617B	4011346	ES2116L
8022208R	ES2208R	804733	DS733	80846610	8458B010	808582	8611B	4011346	ES431R
8022209R	ES2209R	804800	DS800	808470N	8471B	808584	8618C	4011354	ES187R
8022210L	ES2210L	804803	DS803	808471	8456B	808585	8571B	4011363	ES2614R
8022224L	ES2224L	804835	DS835	808472	8454B	808586	8631C	4011364	ES2613L
8022225R	ES2225R	804845	DS845	808472D	8454N	808587	8639B	4011397	ES2224L
802235L	ES235L	804867	DS867	808477	8507B	808588	8643B	4011397	ES434L
802235R	ES235R	804872	DS872	808479	8527B	808589	8641B	4011398	ES2225R
802260L	ES158L	804873	DS873	808480	8474B	808590	8572B	4011399	ES2257R
802260R	ES158R	804880	DS880	808489	8386N	808591	8633C	4011400	ES2200L
8022613L	ES2613L	804881	DS881	808493	8488B	808596	8585B	4011401	ES2201R
8022614R	ES2614R	804908	DS908	80849310	8488B010	8087	8207B	4011404	ES2207R
802262L	ES262L	804910	DS910	808496	8519N			4011405	ES2208R
802262R	ES262R	804929	DS929	808496B	8519B			4011441	ES3026L
80226L	ES26L	804930	DS930	808499	8462N	4011001	ES26L	4011442	ES3027R
80226R	ES26R	804938	DS938	808500	8357N	4011002	ES26R	4011443	ES3032R
802304L	ES304L	804939	DS939	808501	8445B	4011003	ES158L	4011602	ES3252R
802304R	ES304R	804941	DS941	808503	8507N	4011004	ES158R	4011603	ES3297R
802323L	ES323L	804943	DS943	808503B	8507B	4011008	ES150L	4011604	ES3298L
802323R	ES323R	804944	DS944	808504	8489N	4011009	ES150R	4011605	ES3219L
802330L	ES330L	804945	DS945	808506	8491N	4011010	ES176L	4011606	ES3220R
802330R	ES330R	804946	DS946	808506B	8491B	4011011	ES176R	4011607	ES3218R
802332L	ES332L					4011012	ES187L		

Interchanges

Interchanges

Spicer	Moog No.	Spicer	Moog No.	Spicer	Moog No.	Spicer	Moog No.	Spicer	Moog No.
4011608	ES3217L	4351067	DS1044	4401031	DS881	5301052	80059B	5301152	8592B
4011611	ES3086L	4351068	DS945	4401039	DS930	5301055	8458B	5301153	8590B
4011612	ES3087R	4351069	DS958	4401042	DS996	5301055010	8458B010	5301154	80056B
4011614	ES3178R	4351070	DS973	4401043	DS995	5301057	8519B	5301155	8605B
4011615	ES3214R	4351071	DS971	4401044	DS992	5301057010	8519B010	5301156	80055B
4011617	DS1293	4351073	DS977	4401045	DS994	5301060	8454B	5301158	8610B
4011626	ES3216R	4351074	DS948	4401046	DS993	5301061	8479B	5301159	8612B
4011701	ES3476	4351076	DS1067	4401056	DS953	5301061	8507B	5301160	8613B
4011702	ES3477	4351077	DS1064	4401063	DS943	5301062	8386N	5301161	8611B
4011731	ES2091R	4351078	DS1034	4401064	DS944	5301063	8519N	5301162	8617B
4011732	ES2090L	4351079	DS1021	4401065	DS955	5301064	8479N	5301163	8618C
4011752	ES3268L	4351083	DS963	4401066	DS956	5301064	8507N	5301164	8631C
4011753	ES3269R	4351091	DS938	4401069	DS1026	5301067	8357B	5301167	80057B
4011754	ES3270L	4351092	DS939	4401070	DS983	5301068	8527B	5301169	80058B
4011755	ES3271R	4351093	DS1033	4401071	DS1025	5301069	8474B	5301172	8633C
4011756	ES3274L	4351094	DS1020	4401072	DS1030	5301071	8454N	5301173	8639B
4011757	ES3275R	4351095	DS974	4401074	DS1035	5301074	8488B	5301174	8643B
4011815	ES3177L	4351096	DS972	4401082	DS1182	5301074	8609B	5301175	8641B
4011816	ES3176R	4351097	DS1022	4401083	DS1184	5301074010	8488B010	5301178	8637B
4011955	ES3284L	4351098	DS1024	4401085	DS1195	5301078	8484T	5301179	80063C
4011956	ES3283R	4351099	DS1027	4401086	DS1196	5301079	8489N	5301180	8645B
4011957	ES3312R	4351100	DS1028	4401087	DS1180	5301081	8357N	5301183	8647B
4011960	ES3443L	4351101	DS1031	4401088	DS1203	5301082	8462N	5301184	8631B
4011961	ES3442R	4351102	DS976	4401089	DS1205	5301083	8445B	5301187	8633B
4011990	ES3336L	4351104	DS954	4401090	DS1206	5301086	8492N	5301188	80063B
4011991	ES3335R	4351106	DS1136	4401091	DS1207	5301087	8491N	5301189	8655B
4012020	ES2556L	4351109	DS1185	4401100	DS1219	5301088	8343B	5301190	8657B
4012021	ES2557R	4351110	DS1190	4401104	DS1294A	5301088	8490T	5301191	8653B
4051045	ES3030R	4351111	DS1191	4401105	DS1291A	5301092	8500N	5301192	80068C
4051046	ES3031L	4351112	DS1192	4401106	DS1295A	5301096	8445N	5301193	80069B
4051047	ES3039L	4351113	DS1197	4401108	DS1303	5301097	80053B	5301194	8659B
4051048	ES3040R	4351114	DS1198	4401111	DS1264	5301098	8503B	5301195	8660B
4051146	DS1253	4351115	DS1199	4401112	DS1298	5301098	8567B	5301196	8661B
4051147	DS1254	4351116	DS1200	4401114	DS1263	5301105	8514B	5301197	80071C
4101082	DS1362S	4351117	DS1179	4401115	DS1337	5301106	8489B	5301198	80072B
4101083	DS1363S	4351119	DS1204	4401116	DS1266	5301107	8645B	5301199	80073C
4101084	DS1379S	4351130	DS1214	4401117	DS1268	5301108	8518N	5301200	80074B
4101085	DS1380S	4351131	DS1215	4401120	DS1344	5301109	8518B	5301201	80076B
4151000	DS1367A	4351132	DS1216	4401121	DS1299A	5301110	8514N	5301202	80077B
4151001	DS1368A	4351133	DS1217	4401123	DS1313	5301115	8553B	5301203	80078C
4351001	DS584	4351136	DS1305	4401139	DS1218	5301116	8560N	5301213	80079C
4351007	DS659	4351138	DS1302	4401140	DS1221	5301117	8562N	6211184	K100034
4351009	DS733	4351139	DS1278	4401162	DS1234	5301120	8568B	6211185	K100035
4351012	DS800	4351140	DS1265	4401166	DS1350	5301124	8570N	SP621016	8490T
4351014	DS803	4351141	DS1267	4401167	DS1443	5301125	8570B	SP621016	8492B
4351016	DS982	4351142	DS1270	4401168	DS1444	5301125010	8570B010	SP621017	8491B
4351018	DS988	4351143	DS1281	5301000	8459B	5301128	8572B	SP621018	8500B
4351021	DS910	4351144	DS1370	5301000	8471B	5301129	8573B	SP621018	8500N
4351024	DS845	4351145	DS1272	5301005	8492B	5301130	8562B	SP621275	8336B
4351025	DS872	4351146	DS1369	5301007	8491B	5301131	8560B	SP621336	8375B
4351026	DS873	4351147	DS1271	5301007010	8491B010	5301132	8571B	SP621360	8385B
4351033	DS908	4351148	DS1277	5301009	8500B	5301133	8577B	SP621361	8389B
4351044	DS991	4351149	DS1259	5301009010	8500B010	5301133010	8577B010	SP621364	8386B
4351046	DS929	4351150	DS1366	5301013	8207B	5301137	8585B	SP621391	8503B
4351047	DS997	4351151	DS1269	5301023	8336B	5301138	8579B	SP621406	8462B
4351048	DS998	4351158	DS1220	5301031	8375B	5301140	8581B	SP621413	8458B
4351053	DS952	4351171	DS1273	5301034010	8440B	5301140002	8581B002	SP621414	8519B
4351054	DS970	4351172	DS1283	5301038	8385B	5301142	8581N	SP621418	8456B
4351056	DS969	4351174	DS1371	5301038015	8385B015	5301143	8583B	SP621421	8507B
4351057	DS987	4351175	DS1409	5301040	8389B	5301144	8583N	SP621422	8386B
4351058	DS941	4351177	DS1442	5301040015	8441B	5301145	8567N	SP621422	8386N
4351059	DS946	4351178	DS1445	5301042	8386B	5301147	8456B	SP621425	8519N
4351060	DS986	4351179	DS1446	5301045	8426B	5301147	8587B	SP621431	8507N
4351061	DS979	4351180	DS1447	5301049	8428B	5301148	8587N	SP621440	8357N
4351064	DS949	4401000	DS685	5301050	8503B	5301150	8601B	SP621443	8527B
4351066	DS999	4401028	DS867	5301051	8462B	5301151	8593B	SP621452	8454N

Interchanges

Spicer	Moog No.	Spicer	Moog No.	Spicer	Moog No.	Stemco	Moog No.	Sterling	Moog No.
SP621460	8474B	SP692097	ES304L	SP721600	DS948	K165G	8474B	R230105	ES3031L
SP621461	8488B	SP692098	ES304R	SP721603	DS1064	K180E	8633C	R230129	ES411R
SP621464	8489B	SP692138	ES330L	SP721604	DS1034	K309I	8583B	R230130	ES411L
SP621464	8489N	SP692139	ES330R	SP721617	DS938	K309I	8583N	R230139	ES3476
SP621467	8462N	SP692142	ES332L	SP721618	DS939	K310L	8610B	R230140	ES3477
SP621472	8492N	SP692143	ES332R	SP721619	DS1033	K50D	8587B		Studebaker Moog No.
SP621473	8491N	SP692158	ES346L	SP721620	DS1020	K50D	8587N	666193	ES262R
SP621483	8500N	SP692158	ES376L	SP721621	DS974	K50F	8488B	666194	ES262L
SP621491	8567B	SP692159	ES346R	SP721622	DS972	K50F	8609B		Thomas Moog No.
SP621506	8514B	SP692159	ES376R	SP721626	DS1028	K51G	8343B		
SP621507	8489B	SP692189	ES373L	SP721629	DS976	K51G	8484T	1661437C91	DS1214
SP621509	8645B	SP692190	ES373R	SP721644	DS1185	K533M	8601B	1661867C91	DS1215
SP621512	8518N	SP692234	ES411L	SP721646	DS1191	K534M	8592B	R200195	8590B
SP621513	8518B	SP692235	ES411R	SP721647	DS1192	K535M	8593B	R201300	8612B
SP621525	8553B	SP692243	ES423L	SP721648	DS1197	K55G	8570B	R201310	8611B
SP621529	8560N	SP692243	ES431R	SP721649	DS1198	K55G	8570N	R201315	80063C
SP621532	8562N	SP692244	ES423R	SP721652	DS1179	K60F	8357B	R230062	80063B
SP621537	8568B	SP692311	ES431L	SP724020	DS685	K60F	8357N	R230062	ES304L
SP621547	8570N	SP692314	ES405L	SP724089	DS880	K70D	8479B	R230063	ES304R
SP621548	8570B	SP692315	ES405R	SP724095	DS867	K70D	8479N	R230068	ES423L
SP621550	8572B	SP692432	ES2030R	SP724103	DS881	K70D	8507B	R230069	ES423R
SP621551	8573B	SP692437	ES2036R	SP724116	DS930	K70D	8507N	R230074	ES2200L
SP621554	8571B	SP692438	ES2035L	SP724122	DS996	K70F	8500N	R230075	ES2201R
SP621555	8577B	SP692466	ES2061L	SP724123	DS995	K70G	8491B	R230129	ES411R
SP621556	8585B	SP692467	ES2062R	SP724124	DS992	K70G	8491N	R230130	ES411L
SP621557	8579B	SP692474	ES405R	SP724125	DS994	K72F	8639B	R230558	ES3204L
SP621557	8581N	SP692475	ES405L	SP724126	DS993	K75F	8568B	R230559	ES3205R
SP621558	8581B	SP692485	ES2091R	SP724148	DS953	K76F	8653B		TRW (Competitor) Moog No.
SP621558	8581N	SP692486	ES2090L	SP724156	DS943	K80G	8659B	13100027	K100027
SP62155802	8581B002	SP692635	ES2082R	SP724157	DS1044	K901L	8489B	13100028	K100028
SP621559	8581N	SP692636	ES2083L	SP724157	DS944	K901L	8489N	13100029	K100029
SP621560	8583B	SP692644	ES2114R	SP724162	DS1026	K921L	8553B	13100030	K100030
SP621560	8583N	SP692645	ES2040R	SP724163	DS983	K931L	8590B	13100031	K100031
SP621561	8583N	SP692645	ES2116L	SP724164	DS1025	K931L	8611B	13100032	K100032
SP621562	8567N	SP692663	ES2614R	SP724177	DS1182	K941F	8572B	13100033	K100033
SP621564	8587B	SP692664	ES2613L	SP724180	DS1195	K941FA	8585B	13100034	K100034
SP621564	8587N	SP692700	ES2224L	SP724181	DS1196	K942F	8643B	13100035	K100035
SP621569	8601B	SP692701	ES2225R	SP724182	DS1180	K95F	8573B	13100036	K100036
SP621570	8593B	SP692709	ES2208R	SP724184	DS1205	K95G	8462B	13100037	K100037
SP621571	8592B	SP721010	DS659	SP724185	DS1206	K95G	8462N	13100038	K100038
SP621572	8590B	SP721020	DS800	SP724186	DS1207	K96F	8641B	13100039	K100039
SP621576	8605B	SP721022	DS803			K970R	8514B	13100040	K100040
SP621579	8610B	SP721031	DS835	Stemco Moog No.		K970R	8514N	13100041	K100041
SP621580	8612B	SP721033	DS982	K101I	8577B	K971R	8612B	13100042	K100042
SP621582	8613B	SP721036	DS988	K102I	8637B	K98I	8375B	13100043	K100043
SP621583	80063C	SP721134	DS845	K108I	8579B	KD901R	8519B	13100044	K100044
SP621583	8611B	SP721135	DS872	K108I	8645B	KD901R	8519N	13100045	K100045
SP621584	8617B	SP721136	DS873	K110G	8660B	KH901L	8518B	DS1020	DS1020
SP621585	8618C	SP721150	DS908	K119I	8503B	KH901L	8518N	DS1021	DS1021
SP621586	8631B	SP721203	DS991	K120E	8618C	KH931L	8571B	DS1022	DS1022
SP621586	8631C	SP721210	DS929	K120E	8647B			DS1024	DS1024
SP621592	8611B	SP721211	DS997	K120G	8661B	Sterling Moog No.		DS1025	DS1025
SP621594	8633C	SP721212	DS998	K120I	8655B	120KK102	8006C	DS1026	DS1026
SP621597	8639B	SP721311	DS910	K120W	8527B	120TR109	ES423L	DS1027	DS1027
SP621598	8643B	SP721575	DS952	K121E	8631C	120TR110	ES423R	DS1028	DS1028
SP621599	8641B	SP721576	DS970	K121G	8613B	220TR116	ES431R	DS1030	DS1030
SP692003	ES26L	SP721578	DS969	K122E	80076B	220TR117	ES431L	DS1031	DS1031
SP692004	ES26R	SP721579	DS987	K125G	8386B	817018	ES3477	DS1033	DS1033
SP692022	ES150L	SP721580	DS941	K125G	8386N	817019	ES3476	DS1034	DS1034
SP692023	ES150R	SP721581	DS946	K126W	8605B	D5HZ3111C	8571B	DS1035	DS1035
SP692032	ES176L	SP721582	DS986	K139I	8581B	R201315	80063B	DS1044	DS1044
SP692033	ES176R	SP721583	DS979	K140I	8581N	R201470	80063C	DS1064	DS1064
SP692041	ES187L	SP721592	DS999	K140I	8567B	R230068	ES423L	DS1067	DS1067
SP692042	ES187R	SP721596	DS973	K140I	8567N	R230069	ES423R	DS1136	DS1136
SP692051	ES235L	SP721597	DS971	K140I	8617B	R230072	ES2090L	DS1179	DS1179
SP692052	ES235R	SP721599	DS977	K146E	80077B	R230073	ES2091R	DS1180	DS1180
				K160S	80074B	R230104	ES3030R		

Interchanges

TRW (Competitor)	Moog No.	TRW (Competitor)	Moog No.	TRW (Competitor)	Moog No.	TRW (Competitor)	Moog No.	TRW (Competitor)	Moog No.
DS1182	DS1182	DS1369	DS1369	DS995	DS995	ES3220R	ES3220R	K446	8426B
DS1184	DS1184	DS1370	DS1370	DS996	DS996	ES323L	ES323L	K448	8428B
DS1185	DS1185	DS1371	DS1371	DS997	DS997	ES323R	ES323R	K450	8386B
DS1190	DS1190	DS1379S	DS1379S	DS998	DS998	ES3252R	ES3252R	K463	8462B
DS1191	DS1191	DS1380S	DS1380S	DS999	DS999	ES3268L	ES3268L	K466	8458B
DS1192	DS1192	DS1409	DS1409	ES150L	ES150L	ES3269R	ES3269R	K46610	8458B010
DS1195	DS1195	DS1442	DS1442	ES150R	ES150R	ES3270L	ES3270L	K470	8459B
DS1196	DS1196	DS1443	DS1443	ES176L	ES176L	ES3271R	ES3271R	K470N	8471B
DS1197	DS1197	DS1444	DS1444	ES176R	ES176R	ES3274L	ES3274L	K471	8456B
DS1198	DS1198	DS1445	DS1445	ES187L	ES187L	ES3275R	ES3275R	K472	8454B
DS1199	DS1199	DS1446	DS1446	ES187R	ES187R	ES3283R	ES3283R	K472D	8454N
DS1200	DS1200	DS1447	DS1447	ES2030R	ES2030R	ES3284L	ES3284L	K477	8479B
DS1203	DS1203	DS1448	DS1448	ES2035L	ES2035L	ES3294R	ES3294R	K477	8507B
DS1204	DS1204	DS1454	DS1454	ES2036R	ES2036R	ES3297R	ES3297R	K479	8527B
DS1205	DS1205	DS300002	DS300002	ES2061L	ES2061L	ES3298L	ES3298L	K480	8474B
DS1206	DS1206	DS584	DS584	ES2062R	ES2062R	ES330L	ES330L	K489	8386N
DS1207	DS1207	DS659	DS659	ES2069R	ES405R	ES330R	ES330R	K493	8488B
DS1214	DS1214	DS685	DS685	ES2070L	ES405L	ES3312R	ES3312R	K493	8609B
DS1215	DS1215	DS733	DS733	ES2082R	ES194R	ES3328R	ES3328R	K49310	8488B010
DS1216	DS1216	DS800	DS800	ES2082R	ES2082R	ES3329L	ES3329L	K496	8519N
DS1217	DS1217	DS803	DS803	ES2083L	ES194L	ES332L	ES332L	K496B	8519B
DS1218	DS1218	DS835	DS835	ES2083L	ES2083L	ES332R	ES332R	K499	8462N
DS1219	DS1219	DS845	DS845	ES2090L	ES2090L	ES3335R	ES3335R	K500	8357N
DS1220	DS1220	DS867	DS867	ES2090L	ES2210L	ES3336L	ES3336L	K501	8445B
DS1221	DS1221	DS872	DS872	ES2091R	ES2091R	ES3442R	ES3442R	K503	8479N
DS1234	DS1234	DS873	DS873	ES2091R	ES2204R	ES3443L	ES3443L	K503	8507N
DS1235	DS1253	DS880	DS880	ES2091R	ES2209R	ES346L	ES346L	K504	8489N
DS1254	DS1254	DS881	DS881	ES2200L	ES2200L	ES346R	ES346R	K506	8491N
DS1259	DS1259	DS908	DS908	ES2201R	ES2201R	ES3476	ES3476	K506B	8491B
DS1263	DS1263	DS910	DS910	ES2203R	ES2203R	ES3477	ES3477	K506B10	8491B010
DS1264	DS1264	DS929	DS929	ES2207R	ES2207R	ES373L	ES373L	K507	8492N
DS1265	DS1265	DS930	DS930	ES2208R	ES2208R	ES373R	ES373R	K507B	8492B
DS1266	DS1266	DS938	DS938	ES2224L	ES2224L	ES405L	ES405L	K509	8500N
DS1267	DS1267	DS939	DS939	ES2225R	ES2225R	ES405R	ES405R	K509B	8500B
DS1268	DS1268	DS941	DS941	ES2257R	ES2257R	ES411L	ES411L	K509B10	8500B010
DS1269	DS1269	DS943	DS1206	ES235NL	ES235L	ES411R	ES411R	K510B	8489B
DS1270	DS1270	DS943	DS943	ES235NR	ES235R	ES416L	ES416L	K515	8445B
DS1271	DS1271	DS944	DS944	ES2556L	ES2556L	ES416R	ES416R	K516	80053B
DS1272	DS1272	DS945	DS945	ES2557R	ES2557R	ES423L	ES423L	K517	8503B
DS1273	DS1273	DS946	DS946	ES2613L	ES2613L	ES423R	ES423R	K524B	8645B
DS1274	DS1274	DS948	DS948	ES2614R	ES2614R	ES431L	ES2116L	K526B	8514B
DS1275	DS1275	DS949	DS949	ES262L	ES262L	ES431L	ES376L	K526D	8514N
DS1276	DS1276	DS952	DS952	ES262R	ES262R	ES431L	ES431L	K534B	8553B
DS1277	DS1277	DS953	DS953	ES26L	ES26L	ES431R	ES2113R	K535B	8567B
DS1278	DS1278	DS954	DS954	ES26R	ES26R	ES431R	ES2114R	K535D	8567N
DS1281	DS1281	DS955	DS955	ES3026L	ES3026L	ES431R	ES376R	K538B	8568B
DS1283	DS1283	DS956	DS956	ES3027R	ES3027R	ES431R	ES431R	K539D	8570N
DS1291A	DS1291A	DS958	DS958	ES3030R	ES3030R	ES434L	ES434L	K540B	8570B
DS1293	DS1293	DS969	DS969	ES3031L	ES3031L	ES60L	ES158L	K540B010	8570B010
DS1294A	DS1294A	DS970	DS970	ES3032R	ES3032R	ES60R	ES158R	K541B	8518B
DS1295A	DS1295A	DS971	DS971	ES3039L	ES3039L	ES800420	ES800420	K542D	8518N
DS1298	DS1298	DS972	DS972	ES3040R	ES3040R	ES800421	ES800421	K543D	8562B
DS1299A	DS1299A	DS973	DS973	ES304L	ES304L	ES800422	ES800422	K543D	8562N
DS1302	DS1302	DS974	DS974	ES304R	ES304R	ES800423	ES800423	K544B	8560B
DS1303	DS1303	DS976	DS976	ES3086L	ES3086L	ES800424	ES800424	K544D	8560N
DS1305	DS1305	DS977	DS977	ES3087R	ES3087R	ES800425	ES800425	K546B	8573B
DS1313	DS1313	DS979	DS979	ES3176R	ES3176R	ESK371	ESK371	K547B	8571B
DS1337	DS1337	DS982	DS982	ES3177L	ES3177L	K129N	K336B	K548B	8572B
DS1340	DS1340	DS983	DS983	ES3178R	ES3178R	K365N	8440B	K549B	8577B
DS1344	DS1344	DS986	DS986	ES3204L	ES3204L	K391C	8490T	K549B010	8577B010
DS1350	DS1350	DS987	DS987	ES3205R	ES3205R	K401N	8375B	K549C	8577C
DS1362S	DS1362S	DS988	DS988	ES3214R	ES3214R	K408	8357B	K549C002	8577C002
DS1363S	DS1363S	DS991	DS991	ES3216R	ES3216R	K431	8389B	K550D	8587N
DS1366	DS1366	DS992	DS992	ES3217L	ES3217L	K43115	8441B	K551B	8579B
DS1367A	DS1367A	DS993	DS993	ES3218R	ES3218R	K432	8385B	K551B002	8579B002
DS1368A	DS1368A	DS994	DS994	ES3219L	ES3219L	K43215	8385B015	K552B	8581B

Interchanges

Interchanges

TRW (Competitor)	Moog No.	TRW (Competitor)	Moog No.	TRW (Competitor)	Moog No.	TRW (Competitor)	Moog No.	TRW (Competitor)	Moog No.
K552B2	8581B002	L16RT796A16	DS1362S	L20LV5264A13	ES3204L	L20SV8052A13	ES3328R	L20VU5070A12	DS977
K553D	8581N	L16RT796A17	DS1362S	L20LV7023B12	ES3040R	L20SV8052B13	ES373R	L20VU5081A11	DS1034
K553D002	8581N002	L16RT961A11	DS1363S	L20LV7023B13	ES3040R	L20SV8052C13	ES3312R	L20VU5081B11	DS1034
K554B	8583B	L16RT961A12	DS1363S	L20LV7024B12	ES3039L	L20SV8055A13	ES373L	L20VU5082A12	DS983
K555D	8583N	L16SV5000A15	ES262L	L20LV7024B13	ES3039L	L20SV8056A13	ES373R	L20VU5094A11	DS1215
K555D002	8583N002	L16SV5001A15	ES262R	L20LV8000A12	ES3040R	L20SV8100D12	ES423L	L20VU5094A12	DS1215
K557B	8587B	L16SV5050A12	ES26L	L20LV8000A13	ES3040R	L20SV8101A15	ES2614R	L20VU5206A11	DS1302
K558B	8585B	L16SV5050A13	ES26L	L20LV8001A13	ES3039L	L20SV8101D12	ES423R	L20VU7002C12	DS1064
K560B	8592B	L16SV5051A12	ES26R	L20LV8007A13	ES411L	L20SV8102B12	ES3270L	L20VU7004B11	DS1195
K561B	8593B	L16SV5051A13	ES26R	L20LV8088A13	ES411R	L20SV8102G12	ES3270L	L20VU7004B12	DS1195
K562B	8601B	L17SV5050A12	ES26L	L20LV8114A13	ES3040R	L20SV8103B12	ES3271R	L20VU7012B11	DS1196
K563B	8590B	L17SV5050A13	ES26L	L20LV8114B12	ES3040R	L20SV8103F12	ES3271R	L20VU7012B12	DS1196
K564B	80055B	L17SV5051A12	ES26R	L20LV8115A13	ES3039L	L20SV8109A12	ES3216R	L20VU7025A11	DS1197
K565B	8605B	L17SV5051A13	ES26R	L20LV8115B12	ES3039L	L20SV8110B21	ES187R	L20VU7025A12	DS1197
K566B	80056B	L17SV5100B13	ES158L	L20SV4000B16	ES373L	L20SV8110E12	ES405R	L20VU7033A11	DS1190
K567B	8613B	L17SV5101B14	ES158R	L20SV4000C14	ES373L	L20SV8110E13	ES405R	L20VU7033A12	DS1190
K570B	8612B	L17SV5109A13	ES158R	L20SV4000C16	ES373L	L20SV8111B19	ES187L	L20VU7034A11	DS1198
K571B	8610B	L17SV5111A13	ES158L	L20SV4000F12	ES373L	L20SV8111E12	ES405L	L20VU7034A12	DS1198
K571C	8610C	L17SV5352A15	ES262L	L20SV4000F14	ES373L	L20SV8111E13	ES405L	L20VU7038A11	DS1191
K572B	8617B	L17SV5353A15	ES262R	L20SV4001B16	ES373R	L20SV8118B12	ES3294R	L20VU7038A12	DS1191
K573B	80057B	L18RT0633A17	DS1379S	L20SV4001C15	ES373R	L20SV8126A13	ES2613L	L20VU7041A12	DS1216
K574B	80058B	L18RT0734A18	DS1380S	L20SV4001C17	ES373R	L20SV8132A12	ES2257R	L20VU8000A12	DS1191
K575B	80059B	L18RT633A12	DS1379S	L20SV4001G12	ES373R	L20SV8150B12	ES3476	L20VU8001A11	DS1214
K582	80063B	L18RT633A13	DS1379S	L20SV4001G14	ES373R	L20SV8151B12	ES3477	L20VU8001A12	DS1214
K582	8611B	L18RT633A14	DS1379S	L20SV5000A16	ES176L	L20SV8153A12	ES332L	L20VU8005A11	DS1259
K583	80063C	L18RT633A17	DS1379S	L20SV5000A17	ES176L	L20SV8158B12	ES3477	L20VU8005A12	DS1259
K584	8618C	L18SV5000A12	ES2082R	L20SV5000B14	ES304L	L20SV8200A12	ES2036R	L20VU8009A11	DS979
K586	8631C	L18SV5000A13	ES2082R	L20SV5000B17	ES304L	L20SV8200B12	ES2036R	L20VU8009B11	DS979
K587	8639B	L18SV5000A15	ES2082R	L20SV5001A14	ES176R	L20SV8201A12	ES2035L	L20VU8010A11	DS1302
K588	8643B	L18SV5001A12	ES2083L	L20SV5001A17	ES176R	L20SV8201B12	ES2035L	L20VU8010A12	DS1302
K589	8641B	L18SV5001A13	ES2083L	L20SV5001A24	ES176R	L20SV8202A12	ES3283R	L20VU8012A11	DS1303
K591	8633C	L18SV5100A16	ES150L	L20SV5001B15	ES304R	L20SV8203A12	ES3284L	L20VU8012A12	DS1303
K591B	8633B	L18SV5100A18	ES150L	L20SV5001B19	ES304R	L20SV8204B12	ES3283R	L20VU8013A11	DS1281
K592	8637B	L18SV5101A16	ES150R	L20SV5013D14	ES176L	L20SV8205B11	ES3284L	L20VU8013A12	DS1281
K592C	8637C	L18SV5101A20	ES150R	L20SV5014C21	ES176R	L20SV8205B12	ES3284L	L20VU8015A11	DS1305
K593	80063C	L18SV5150A13	ES2083L	L20SV5014D14	ES176R	L20SV8236A13	ES2030R	L20VU8015A12	DS1305
K593B	80063B	L18SV5150D12	ES2083L	L20SV5025A11	ES330R	L20SV8256B12	ES3312R	L20VU8018A12	DS1190
K595	80066B	L18SV5151A13	ES2082R	L20SV5026A11	ES330L	L20SV8275A13	ES3027R	L20VU8020B11	DS948
K602	8655B	L18SV5151D12	ES2082R	L20SV7000A11	ES2062R	L20SV8275A14	ES3027R	L20VU8022B12	DS1195
K602C	8655C	L18SV5452A12	ES235R	L20SV7000A12	ES2062R	L20SV8275B12	ES3027R	L20VU8024B12	DS1196
K606C	80068C	L18SV5452A14	ES235R	L20SV7000A13	ES2062R	L20SV8276A13	ES3026L	L20VU8025A12	DS1197
K607B	8653B	L18SV5453A12	ES235L	L20SV7000A20	ES2062R	L20SV8276A14	ES3026L	L20VU8026A12	DS1198
K608	8484T	L18SV5453A14	ES235L	L20SV7001A11	ES2061L	L20SV8276B12	ES3026L	L20VU8027A12	DS1216
K609	8647B	L18SV8000A14	ES176R	L20SV7001A12	ES2061L	L20SV8301A11	ES325L	L20VU8031A12	DS1064
K610	8631B	L18SV8001A15	ES176L	L20SV7001A13	ES2061L	L20SV8308A11	ES325R	L20VU8032A11	DS1277
K612B	80069B	L18SV8009A14	ES304L	L20SV7001A17	ES2061L	L20VU4002A12	DS800	L20VU8032A12	DS1277
K618C	8659B	L18SV8020A14	ES304R	L20SV7001B12	ES2061L	L20VU4002B11	DS800	L20VU8037A11	DS1366
K619C	8660B	L18SV8052A12	ES330R	L20SV7025A12	ES2035L	L20VU4009B11	DS803	L20VU8037A12	DS1366
K620C	8661B	L18SV8053A12	ES330L	L20SV7025A13	ES2035L	L20VU4010B11	DS845	L20VU8043A11	DS800
K623	8657B	L18VU5000A12	DS659	L20SV7025B12	ES2035L	L20VU4019A13	DS946	L20VU8044A11	DS803
K623C	80070C	L18VU5000A13	DS659	L20SV7026A12	ES2036R	L20VU4019B12	DS946	L20VU8045A11	DS845
K624C	80071C	L18VU5002A12	DS685	L20SV7026A13	ES2036R	L20VU4023A12	DS945	L20VU8047A11	DS946
K625	80072B	L18VU5002A13	DS685	L20SV7026B12	ES2036R	L20VU4023A13	DS945	L20VU8048A11	DS945
K626C	80073C	L18VU5048A12	DS867	L20SV7152A12	ES3268L	L20VU4026A12	DS944	L20VU8049B11	DS944
K627	80074B	L18VU5077A12	DS930	L20SV7153A12	ES3269R	L20VU4026A13	DS944	L20VU8054A12	DS1366
K627C	80075C	L18VU8000A11	DS1215	L20SV7175A12	ES3027R	L20VU4029A12	DS948	L20VU8057A12	DS1021
K628	80076B	L18VU8000A12	DS1215	L20SV7176A12	ES3026L	L20VU4029A13	DS948	L20VU8061A12	DS971
K629	80077B	L20SV80003A12	DS1034	L20SV8000D14	ES2061L	L20VU4072A12	DS1191	L20VU8062A12	DS972
K630C	80078C	L18VU8005A12	DS969	L20SV8000E12	ES3268L	L20VU4073A12	DS1190	L20VU8063A12	DS973
K631C	80079C	L18VU8006A12	DS970	L20SV8001D13	ES2062R	L20VU5002A12	DS733	L20VU8064A12	DS974
K7	8207B	L18VU8014A13	DS733	L20SV8002C12	ES3268L	L20VU5002A13	DS733	L20VU8065A12	DS976
L16RT0796A17	DS1362S	L18VU8015A11	DS880	L20SV8003C12	ES3269R	L20VU5054A11	DS969	L20VU8070A11	DS982
L16RT0961A12	DS1363S	L18VU8016A12	DS977	L20SV8003E12	ES3269R	L20VU5054A12	DS969	L20VU8083A13	DS873
L16RT0969A12	DS1363S	L20LV5263A12	ES3205R	L20SV8051A13	ES3329L	L20VU5056A11	DS970	L20VU8088A13	DS872
L16RT796A12	DS1362S	L20LV5263A13	ES3205R	L20SV8051B14	ES373L	L20VU5056A12	DS970	L20VU8092A12	DS963
L16RT796A13	DS1362S	L20LV5264A12	ES3204L	L20SV8051C13	ES3329L	L20VU5066A12	DS880	L24LV5144A12	ES411L

Interchanges

TRW (Competitor)	Moog No.	TRW (Competitor)	Moog No.	TRW (Competitor)	Moog No.	TRW (Competitor)	Moog No.	TRW (Competitor)	Moog No.
L24LV5145A12	ES411R	L24SV5551A11	ES332R	L24SV8376C12	ES3177L	L24VU4019D12	DS954	L24VU7001A11	DS987
L24LV5324A12	ES411R	L24SV5700A12	ES2203R	L24SV8454B12	ES3030R	L24VU4021D12	DS1035	L24VU7001A12	DS987
L24LV5324A13	ES411R	L24SV5700A14	ES2203R	L24SV8455B12	ES3031L	L24VU4021D13	DS1035	L24VU7006A12	DS958
L24LV5325A12	ES411L	L24SV5750A14	ES2200L	L24SV8477A12	ES3086L	L24VU4033D12	DS953	L24VU7006B11	DS958
L24LV5325A13	ES411L	L24SV5750B11	ES2200L	L24SV8478A12	ES3087R	L24VU4034F12	DS908	L24VU7010A11	DS1205
L24LV7049A12	ES3220R	L24SV5750B12	ES2200L	L24TV8130A01	DS1293	L24VU4042C13	DS943	L24VU7011B11	DS953
L24LV7050A12	ES3219L	L24SV5751A14	ES2201R	L24TV8130C01	DS1293	L24VU4042D12	DS943	L24VU7015A12	DS908
L24LV8063A11	ES3220R	L24SV5751B11	ES2201R	L24TV8148A01	DS1264	L24VU4043C13	DS956	L24VU7015A13	DS908
L24LV8063A13	ES3220R	L24SV5751B12	ES2201R	L24TV8148B01	DS1264	L24VU4043D12	DS956	L24VU7015B11	DS908
L24LV8064A11	ES3219L	L24SV5755A12	ES3086L	L24TV8194B01	DS1253	L24VU4044C13	DS955	L24VU7025A11	DS1204
L24LV8064A13	ES3219L	L24SV5755A13	ES3086L	L24TV8312B01	DS1313	L24VU4044D12	DS955	L24VU7038A11	DS1220
L24LV8127A12	ES3214R	L24SV5756A12	ES3087R	L24TV8314B01	DS1254	L24VU4051D12	DS958	L24VU7042A11	DS1277
L24LV8127A14	ES3214R	L24SV5756A13	ES3087R	L24VC124	ES2091R	L24VU4053B13	DS949	L24VU7043A11	DS1340
L24LV8128A12	DS1263	L24SV6050A12	ES2200L	L24VT5206A12	DS1030	L24VU4053D12	DS949	L24VU7050B11	DS1179
L24LV8128B12	DS1263	L24SV6051A12	ES2201R	L24VT5207A12	DS1031	L24VU4055B12	DS1204	L24VU7050B12	DS1179
L24LV8133A12	DS1298	L24SV6100H13	ES325R	L24VT5209A11	DS1022	L24VU4058A11	DS1192	L24VU7050C11	DS1185
L24LV8133D12	DS1298	L24SV6150F13	ES325L	L24VT5209A12	DS1022	L24VU4058A12	DS1192	L24VU7050C12	DS1185
L24LV8441A13	ES3219L	L24SV7002A16	ES423R	L24VT5290A12	DS1022	L24VU4060A11	DS1203	L24VU7051A11	DS1180
L24LV8442A13	ES3220R	L24SV7002C12	ES3218R	L24VT5378A11	DS1291A	L24VU4060A12	DS1203	L24VU7051B11	DS1180
L24SV4000K13	ES423R	L24SV7003A16	ES423L	L24VT5522A11	DS1299A	L24VU4062A11	DS1207	L24VU7051B12	DS1180
L24SV4001M13	ES423L	L24SV7003B12	ES3217L	L24VT7001B11	DS1283	L24VU4064A11	DS1265	L24VU7056A12	DS1203
L24SV5000A14	ES187L	L24SV7104A11	ES2091R	L24VT7019A11	DS1367A	L24VU4065A11	DS1266	L24VU7056A13	DS1203
L24SV5000A15	ES187L	L24SV7202A12	ES3274L	L24VT7034A11	DS1337	L24VU4066A11	DS1267	L24VU7058A11	DS949
L24SV5000A23	ES187L	L24SV7203A12	ES3275R	L24VT7035A11	DS1454	L24VU4067A11	DS1268	L24VU7063A11	DS1182
L24SV5000A42	ES187L	L24SV8000C17	ES423L	L24VT8001C11	DS1454	L24VU5068B11	DS939	L24VU7063A12	DS1182
L24SV5000H12	ES405L	L24SV8000E12	ES3217L	L24VT8003A11	DS1367A	L24VU5068B12	DS939	L24VU7066A11	DS1192
L24SV5000H13	ES405L	L24SV8000E13	ES3217L	L24VT8003B11	DS1367A	L24VU5070B12	DS938	L24VU7066B12	DS1192
L24SV5000H17	ES405L	L24SV8001D17	ES423R	L24VT8019A11	DS1283	L24VU5084A12	DS872	L24VU7074A11	DS1274
L24SV5000H18	ES405L	L24SV8001E12	ES3218R	L24VT8019A12	DS1283	L24VU5084A13	DS872	L24VU7076A12	DS1200
L24SV5000H19	ES405L	L24SV8001E13	ES3218R	L24VT8019B11	DS1283	L24VU5103B12	DS988	L24VU7077A12	DS1199
L24SV5001A13	ES187R	L24SV8002B12	ES3274L	L24VT8025B11	DS998	L24VU5104C11	DS910	L24VU7079A11	DS1221
L24SV5001A14	ES187R	L24SV8002L12	ES3274L	L24VT8026B12	DS1024	L24VU5104C12	DS910	L24VU7088A11	DS1207
L24SV5001A37	ES187R	L24SV8003B12	ES3275R	L24VT8042A11	DS1337	L24VU5106A11	DS963	L24VU7089A11	DS1184
L24SV5001A53	ES187R	L24SV8003G12	ES3275R	L24VT8042B11	DS1337	L24VU5106A12	DS963	L24VU7089A12	DS1184
L24SV5001A54	ES187R	L24SV8100A13	ES2090L	L24VT8128A11	DS1299A	L24VU5127A13	DS873	L24VU7091A11	DS1278
L24SV5001A55	ES187R	L24SV8100F12	ES3443L	L24VT8128B11	DS1299A	L24VU5130A11	DS972	L24VU7091A12	DS1278
L24SV5001D18	ES405R	L24SV8101A12	ES2091R	L24VT8132A11	DS1295A	L24VU5130A12	DS972	L24VU7102A11	DS1218
L24SV5001D19	ES405R	L24SV8101A15	ES2091R	L24VT8132B11	DS1295A	L24VU5131A11	DS974	L24VU7103A11	DS1219
L24SV5001D23	ES405R	L24SV8101A21	ES2091R	L24VT8133A11	DS1294A	L24VU5131A12	DS974	L24VU7105A11	DS1344
L24SV5001D24	ES405R	L24SV8101A21	ES2204R	L24VT8133D11	DS1294A	L24VU5133A11	DS971	L24VU7106A11	DS1265
L24SV5001D25	ES405R	L24SV8101C12	ES2091R	L24VT8148A11	DS1291A	L24VU5133A12	DS971	L24VU7106A12	DS1265
L24SV5008A12	ES3216R	L24SV8101D12	ES2091R	L24VT8148B11	DS1291A	L24VU5137A11	DS973	L24VU7107A11	DS1266
L24SV5009A18	ES431L	L24SV8101K12	ES3442R	L24VT8234A11	DS1368A	L24VU5137A12	DS973	L24VU7107A12	DS1266
L24SV5021A12	ES2257R	L24SV8102A14	ES2090L	L24VT8234B11	DS1368A	L24VU5176A11	DS976	L24VU7108A11	DS1267
L24SV5021A13	ES2257R	L24SV8103A12	ES2091R	L24VT8234C11	DS1368A	L24VU5176A12	DS976	L24VU7108A12	DS1267
L24SV5042A10	ES423R	L24SV8103A14	ES2091R	L24VT8265C11	DS1033	L24VU5182A11	DS941	L24VU7109A11	DS1268
L24SV5042A12	ES423R	L24SV8111A12	ES2091R	L24VT8266D11	DS1025	L24VU5182A12	DS941	L24VU7110A11	DS1275
L24SV5042A14	ES423R	L24SV8200A16	ES431L	L24VT8267A12	DS1020	L24VU5183A11	DS1273	L24VU7112A11	DS1269
L24SV5042B12	ES423R	L24SV8200N12	ES434L	L24VT8269B11	DS1027	L24VU5188A11	DS979	L24VU7113A11	DS1409
L24SV5042B13	ES431R	L24SV8201A13	ES431R	L24VT8282B11	DS1350	L24VU5188A12	DS979	L24VU7115A11	DS1234
L24SV5042B17	ES423R	L24SV8204B19	ES346L	L24VT8283A12	DS1030	L24VU5199A11	DS1021	L24VU7116A11	DS1276
L24SV5042C12	ES2614R	L24SV8205D14	ES3252R	L24VT8284A12	DS1031	L24VU5199A12	DS1021	L24VU7118A11	DS1270
L24SV5042C13	ES2614R	L24SV8205H13	ES3252R	L24VT8286B11	DS1022	L24VU5206A11	DS1302	L24VU7119A11	DS1271
L24SV5043A10	ES423L	L24SV8206A13	ES2224L	L24VT8299A12	DS999	L24VU5209A11	DS991	L24VU7120A11	DS1272
L24SV5043A14	ES423L	L24SV8207C16	ES346R	L24VT8406B11	DS1028	L24VU5210A11	DS988	L24VU8000A11	DS1185
L24SV5043B12	ES423L	L24SV8208B12	ES431L	L24VT8541B11	DS992	L24VU5216A11	DS982	L24VU8000B11	DS1185
L24SV5043B13	ES423L	L24SV8209B12	ES431R	L24VT8542B11	DS995	L24VU5224A11	DS1044	L24VU8000B12	DS1185
L24SV5043B18	ES423L	L24SV8209F12	ES2225R	L24VT8547B11	DS997	L24VU5224B11	DS1044	L24VU8000C11	DS1179
L24SV5044A12	ES3312R	L24SV8214A13	ES2208R	L24VT8565B11	DS993	L24VU5225A11	DS1067	L24VU8000D12	DS1185
L24SV5050A12	ES2613L	L24SV8218B12	ES3032R	L24VT8572B11	DS994	L24VU5225A12	DS1067	L24VU8000E11	DS1185
L24SV5050A13	ES2613L	L24SV8312A12	ES3178R	L24VT8573B11	DS996	L24VU5237A11	DS1214	L24VU8000E12	DS1185
L24SV5051A12	ES3294R	L24SV8312B12	ES3178R	L24VT8576B11	DS1026	L24VU5237A12	DS1214	L24VU8000F11	DS1179
L24SV5102A11	ES2030R	L24SV8334A14	ES2203R	L24VT869B11	DS1337	L24VU5240A11	DS1303	L24VU8000G11	DS1179
L24SV5102A13	ES2030R	L24SV8339A12	ES3177L	L24VU4018C12	DS952	L24VU5241A11	DS1281	L24VU8001A11	DS1180
L24SV5162A12	ES3178R	L24SV8348A12	ES3176R	L24VU4018C13	DS952	L24VU5243A11	DS1305	L24VU8001B11	DS1180
L24SV5550A11	ES332L	L24SV8375C12	ES3176R	L24VU4019C13	DS954	L24VU7000A12	DS986	L24VU8001C11	DS1179

Interchanges

TRW (Competitor)	Moog No.	TRW (Competitor)	Moog No.	TRW (Competitor)	Moog No.	TRW (Competitor)	Moog No.	Volvo	Moog No.
L24VU8001D11	DS1180	L24VU8088A12	DS1370	L28SV5200A12	ES2091R	L28VT5683A11	DS1294A	1006148	ES423R
L24VU8003A11	DS1182	L24VU8092A12	DS1035	L28SV5200A13	ES2091R	L28VU5038A12	DS1136	1006149	ES423L
L24VU8003A12	DS1182	L24VU8093A12	DS956	L28SV5200C13	ES2091R	L28VU5055A11	DS1185	1009009	ES3298L
L24VU8010A11	DS1302	L24VU8095B11	DS1446	L28SV5200C14	ES2091R			1009010	ES3297R
L24VU8010A12	DS1302	L24VU8097B11	DS1447	L28SV5200D12	ES2091R	Unimotive	Moog No.	27092962	ES2224L
L24VU8015A12	DS958	L24VU8098B11	DS1448	L28SV5200E13	ES2091R	KB391C	8490T	27092963	ES2225R
L24VU8016A12	DS908	L24VU8104A11	DS1371	L28SV5201A11	ES2090L	KB401	8375B	370240004	ES423L
L24VU8017A12	DS1204	L24VU8104A12	DS1371	L28SV5201A12	ES2090L	KB408	8357B	370240005	ES423R
L24VU8018A12	DS1192	L24VU8105B11	DS1444	L28SV5201A13	ES2090L	KB431	8389B	370245001	ES2090L
L24VU8019A12	DS1207	L24VU8108B11	DS1442	L28SV5201D12	ES2090L	KB432	8385B	370245002	ES2091R
L24VU8020A11	DS1265	L24VU8128B11	DS1445	L28SV5201E13	ES2090L	KB450	8386B	389050001	DS1024
L24VU8020A12	DS1265	L24VU8152B11	DS1136	L28SV5202A1	ES2091R	KB463	8462B	389050003	DS1025
L24VU8021A11	DS1266	L24VU8158B11	DS1443	L28SV5202A1	ES2204R	KB466	8458B	389050016	DS1026
L24VU8021A12	DS1266	L24VU8161A12	DS1370	L28SV5202A1	ES2209R	KB471	8456B	389050023	DS1033
L24VU8022A11	DS1267	L24VU8162A12	DS1371	L28SV5202A24	ES2209R	KB472	8454B	806355	8618C
L24VU8022A12	DS1267	L24VU8174A13	DS952	L28SV5203A15	ES2210L	KB472D	8454N	817018	ES3477
L24VU8023A11	DS1268	L24VU8175A13	DS955	L28SV5207B14	ES2091R	KB477	8507B	817019	ES3476
L24VU8023A12	DS1268	L24VU8238A12	DS1067	L28SV5207B16	ES2091R	KB480	8474B	823078	80076B
L24VU8025A11	DS1269	L24VU8240B12	DS988	L28SV5207B30	ES2209R	KB493	8488B	R200195	8590B
L24VU8025A12	DS1269	L24VU8241A11	DS991	L28SV5207B34	ES2209R	KB495	8458B	R200198	8571B
L24VU8026A11	DS1409	L24VU8243B11	DS1044	L28SV5211A16	ES2091R	KB496	8519N	R201309	80063C
L24VU8026A12	DS1409	L24VU8268B11	DS1136	L28SV5211B12	ES2091R	KB496B	8519B	R201310	8611B
L24VU8027A12	DS1234	L28LV5522A11	DS1263	L28SV5211B23	ES2091R	KB499	8462N	R201315	80063C
L24VU8028A12	DS1220	L28LV5537B12	ES3214R	L28SV5211D12	ES2091R	KB501	8445B	R230070	ES431R
L24VU8029A12	DS1221	L28LV5683A11	DS1298	L28SV5216A12	ES2090L	KB503	8507N	R230071	ES431L
L24VU8030A12	DS1217	L28SV5000A14	ES431R	L28SV5218A17	ES2210L	KB504	8489N	R230090	ES3312R
L24VU8031A12	DS1218	L28SV5000A18	ES431R	L28SV5218A20	ES2210L	KB506	8491N	R230091	ES3031L
L24VU8031B12	DS1218	L28SV5000A26	ES431R	L28SV5275A13	ES3031L	KB506B	8491B	R230092	ES3030R
L24VU8032A12	DS1219	L28SV5000A29	ES431L	L28SV5276A13	ES3030R	KB507	8492N		
L24VU8033A12	DS943	L28SV5000B22	ES2225R	L28SV5325A13	ES3031L	KB507B	8492B	Western Star	Moog No.
L24VU8033B11	DS943	L28SV5000H19	ES2113R	L28SV5326A13	ES3030R	KB509	8500N	1006148	ES423R
L24VU8034A12	DS1205	L28SV5000H29	ES431R	L28TV5378A01	DS1264	KB509B	8500B	1006149	ES423L
L24VU8038A12	DS986	L28SV5000H35	ES431R	L28TV5394A1	DS1313	KB510B	8489B	1009009	ES3298L
L24VU8039A12	DS987	L28SV5000M12	ES3252R	L28TV5398A1	DS1254	KB517	8503B	1009010	ES3297R
L24VU8040A12	DS953	L28SV5001A12	ES431L	L28TV5400A01	DS1253	KB523B	8567B	806355	8618C
L24VU8041A12	DS1203	L28SV5001A14	ES431L	L28TV5400A1	DS1253	KB524B	8645B	R200198	8571B
L24VU8042A12	DS1200	L28SV5001A18	ES431L	L28TV5567A01	DS1293	KB526B	8514B	R201309	80063C
L24VU8043A12	DS1199	L28SV5001A23	ES431L	L28VT5162A11	DS1027	KB526D	8514N	R201310	8611B
L24VU8044A11	DS1184	L28SV5001A26	ES431L	L28VT5182A11	DS1028	KB534B	8553B	R201315	80063C
L24VU8044A12	DS1184	L28SV5001A29	ES431R	L28VT5182A12	DS1028	KB535B	8567B	R230068	ES423L
L24VU8047B11	DS1273	L28SV5001B14	ES434L	L28VT5187A11	DS997	KB538B	8568B	R230069	ES423R
L24VU8047B12	DS1273	L28SV5001H23	ES2116L	L28VT5187A12	DS997	KB539D	8570N	R230070	ES431R
L24VU8050A12	DS1340	L28SV5002A15	ES431R	L28VT5192A11	DS992	KB540B	8570B	R230071	ES431L
L24VU8052A11	DS1274	L28SV5002A18	ES431R	L28VT5192A12	DS992	KB541B	8518B	R230072	ES2090L
L24VU8052A12	DS1274	L28SV5003A13	ES346R	L28VT5197A11	DS994	KB542D	8518N	R230073	ES2091R
L24VU8055A11	DS1344	L28SV5003A14	ES346R	L28VT5197A12	DS994	KB543D	8562N	R230090	ES3312R
L24VU8055A12	DS1344	L28SV5003A16	ES376L	L28VT5199A11	DS995	KB544D	8560N	R230091	ES3031L
L24VU8056A11	DS1275	L28SV5003B12	ES431L	L28VT5199A12	DS995	KB546B	8573B	R230092	ES3030R
L24VU8056A12	DS1275	L28SV5003B15	ES431L	L28VT5209A12	DS996	KB547B	8571B	Westport Axle	Moog No.
L24VU8059A11	DS1278	L28SV5003B18	ES431L	L28VT5224A12	DS1024	KB548B	8572B	143640004	ES431R
L24VU8059A12	DS1278	L28SV5003C17	ES2224L	L28VT5224A13	DS1024	KB549B	8577B	143640005	ES431L
L24VU8067A12	DS954	L28SV5004D1	ES2113R	L28VT5225A12	DS1025	KB550B	8587B	216446	8527B
L24VU8068A11	DS949	L28SV5004D1	ES431R	L28VT5241A12	DS1026	KB550D	8587N	217016A	80056B
L24VU8068A12	DS949	L28SV5007A15	ES346L	L28VT5250A11	DS998	KB551B	8579B	217175	80055B
L24VU8070A11	DS982	L28SV5007A16	ES346L	L28VT5250A12	DS998	KB552B	8581B	370904405	8605B
L24VU8072A11	DS1270	L28SV5007A17	ES376R	L28VT5308A12	DS1033	KB553D	8581N	370905004	8605B
L24VU8072A12	DS1270	L28SV5007C19	ES431R	L28VT5311A11	DS993	KB554B	8583B	370905005	8605B
L24VU8073A11	DS1271	L28SV5007C22	ES431R	L28VT5311A12	DS993	KB555D	8583N	R230068	ES423L
L24VU8073A12	DS1271	L28SV5015A14	ES2208R	L28VT5312A11	DS1020	KB557B	8587B	R230069	ES423R
L24VU8074A11	DS1272	L28SV5015A15	ES2208R	L28VT5312A12	DS1020	KB558B	8585B	White	Moog No.
L24VU8074A12	DS1272	L28SV5019A1	ES434L	L28VT5359A11	DS999	KB560B	8592B	027092084	ES423L
L24VU8085A11	DS1369	L28SV5041A12	ES3032R	L28VT5359A12	DS999	KB561B	8593B	027092085	ES423R
L24VU8085A12	DS1369	L28SV5052A1	ES431R	L28VT5468A11	DS1350	KB562B	8601B	027092962	ES2224L
L24VU8086A11	DS1276	L28SV5053B12	ES431R	L28VT5522A11	DS1299A	KB563B	8590B	027092963	ES2225R
L24VU8086A12	DS1276	L28SV5105B12	ES2091R	L28VT5537A11	DS1020	KB565B	8605B	216446	8527B
L24VU8088A11	DS1370	L28SV5111A11	ES2204R	L28VT5618A11	DS1295A	KB567B	8613B	217016A	80056B

Interchanges

Interchanges

White	Moog No.	White	Moog No.
217175	80055B	KIT168	8518N
27092962	ES2224L	KIT170	8518B
27092963	ES2225R	KIT170	8518N
370240004	ES423L	KIT172	8489B
370240005	ES423R	KIT172	8489N
370245001	ES2090L	KIT195	8590B
370245002	ES2090L	KIT198	8645B
370245002	ES2091R	KIT199	8553B
370905005	8605B	L28SV5004D1	ES2113R
389050001	DS1024	L28SV5004D13	ES2113R
389050003	DS1025	L28SV5019A1	ES434L
389050016	DS1026	R200195	8590B
389050023	DS1033	R200198	8571B
471632	ES194L	R230070	ES431R
471632	ES2083L	R230071	ES431L
471633	ES194R	R230074	ES2200L
471633	ES2082R	R230075	ES2201R
718114	ES176R	R230090	ES3312R
718115	ES176L	R230091	ES3031L
839307B	ES431L	R230092	ES3030R
839307B	ES431R	V1110067	ES2210L
839308B	ES2040R	V1110068	ES2204R
839308B	ES431L		
839308B	ES431R		
872469	ES187R		
872470	ES187L		
883234	ES304L		
883234	ES304R		
887783A	ES2116L		
887783A	ES376L		
887783A	ES431L		
887784A	ES2113R		
887784A	ES2114R		
887784A	ES376R		
887784A	ES431R		
A13144F370	ES2208R		
A2144Q225	ES187L		
A3144525	ES2208R		
A3144C237	ES346L		
A3144C237	ES346R		
A3144D238	ES346L		
A3144D238	ES346R		
A3144D524	ES423R		
A3144E525	ES423L		
A3144F448	ES2091R		
A3144G449	ES2090L		
A3144J296	ES431R		
A3144K297	ES2040R		
A3144K297	ES431L		
A3144K297	ES431R		
A3144Q225	ES187L		
A3144R226	ES187R		
A3144U385	ES304L		
A3144U438	ES2090L		
A3144V386	ES304R		
A3144V437	ES2091R		
B1490632	DS999		
KIT123	8568B		
KIT144	8568B		
KIT156	8514B		
KIT156	8514N		
KIT157	8514B		
KIT157	8514N		
KIT167	8489B		
KIT167	8489N		
KIT168	8518B		

National[®] Oil Seals

NEW!

National[®] Introduces the Most Innovative Technology in Sealing!

National[®]
**DYNAMIC
EDGE**[™]
TECHNOLOGY

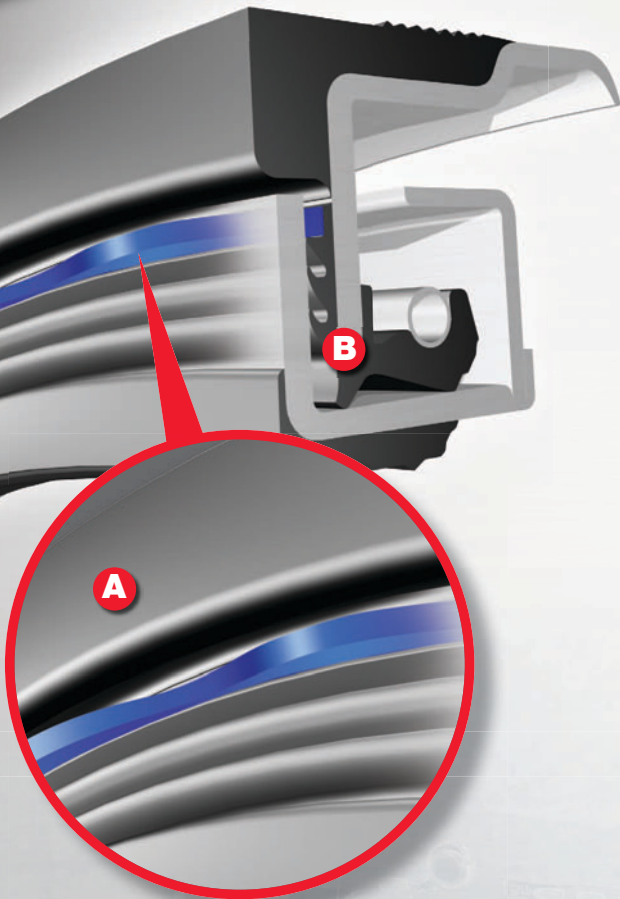

- A** Dynamic Edge[™] pumping feature deflects contamination away from the face of the seal
- B** Four floating points of contact lock out dirt and moisture

The National[®] Oil Seals “Red” 37 Series that help keep your fleet on the road mile after mile is now enhanced with National Dynamic Edge[™] technology. This innovative dirt exclusion system is engineered to deflect dirt and moisture away from wheel end components. The key to National Dynamic Edge[™] technology is a patent pending sinusoidal wave that actually creates a pumping action to aggressively push dirt away from the seal.

Manufactured with dependable, abrasion resistant nitrile, the spring-loaded main lip delivers positive sealing with reduced shaft interference. Unitized construction provides greater structural integrity, easier installation and main lip protection.

For the latest technology and engineering innovation — no seal performs like National!

 **FEDERAL
MOGUL**

MOOG[®]

STEERING & SUSPENSION

NOTICE! / AVIS! / ¡ADVERTENCIA!

The parts listed in this catalog are designed to replace the worn or non-functioning original equipment parts in vehicles as produced by the vehicle factory. These parts are not designed for installation on vehicles where the suspension and/or steering systems have been modified for any other purpose.

Les pièces listées dans ce catalogue sont conçues pour remplacer les pièces d'équipement d'origine usées ou qui ne fonctionnent pas sur le véhicule tel qu'il a été fabriqué en usine. Ces pièces ne sont pas conçues pour être installées sur des véhicules dont les systèmes de suspension et/ou de direction ont été modifiés dans un autre but.

Las piezas que aparecen en este catálogo se han concebido para sustituir piezas originales desgastadas o que funcionan mal en vehículos tal y como salieron de fábrica. Estas piezas no se han pensado para instalarse en vehículos donde el sistema de suspensión y/o el de dirección ya han sido modificados con cualquier finalidad.

Federal-Mogul Corporation
Southfield, MI 48033

www.federalmogul.com

For parts lookup, visit
Pour les pièces de choix, visitez www.FMe-cat.com
Para la búsqueda de repuestos, visite

tech line:
ligne de technologie: **1-800-325-8886**
línea de tecnología:

moogproblemsolver.com