

Lüfterkomponenten

Fan components

Composants de ventilateur a rotation

Ventilatorcomponenten

Componentes de ventiladores

Componenti di ventilatori

вентиляторов регулируемого

Podzespoły szybkoobrotowych

Εξαρτήματα ανεμιστήρων

Ventilátorkomponensek

Componentes de ventiladores

Fan kisim





www.beru.com/Awarded_Quality



automechanika
greendirectory











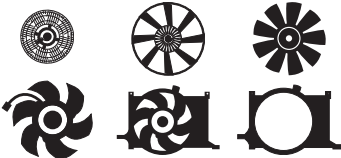

www.beru.com



LESERWAHL
BEST BRAND 2010
2. PLATZ
auto
motor
and
sport

www.beru.com

	 2		
	 28		
	 108		
	 136		
	 151		
	 156		
	 162		
	 185		
	 186		
<p>Ausgabe 06/11 Mit Erscheinen dieser Ausgabe werden alle seitherigen Ausgaben ungültig.</p> <p>With the publication of this issue, all previous issues become invalid.</p>	<p>Cette nouvelle édition rend caduques les éditions précédentes</p> <p>Met het verschijnen van deze uitgave worden alle voorgaande uitgaven ongeldig</p> <p>Con la publicación de esta edición pierden su validez todas las ediciones publicadas hasta ahora.</p>	<p>Con la comparsa della presente edizione tutte le edizioni precedenti non sono più valide.</p> <p>С опубликованием данного издания все предыдущие издания теряют силу.</p> <p>Wrzaz z ukazaniem się niniejszego wydania wszystkie poprzednie tracą ważność.</p>	<p>Με την κυκλοφορία της παρούσας έκδοσης ακυρώνονται όλες οι προηγούμενες εκδόσεις.</p> <p>Ennek a kiadásnak a megjelenésé val az összes korábban közölt adat elveszíti érvényességét.</p> <p>Com o surgimento desta edição, todas as anteriores deixam de ser válidas</p>

i **Weitere Anwendungen siehe auch**
For further applications see
Pour déterminer les autres affectations
veuillez vous référer à
Zie voor verdere toepassingen ook
Para más aplicaciones véase también

Altre applicazioni vedi
Дальнейшие использования см. также
Pozostałe zastosowanie patrz również
Περαιτέρω εφαρμογές βλέπε επίσης στο
További alkalmazásokat lásd-nál
Para outras aplicações, ver também



www.beru.com/produktfinder

www.tecdoc.net

	<p>Hubraum Capacity Cylindrée Motorinhoud Cilindrada Cilindrata Рабочий объем rojemnosć skokowa Κυβισμός Lökettérfogat Cilindrada Silindir hacmi</p>		<p>Elektrischer Lüfter mit Zarge electrical fan with frame ventilateur électrique avec châssis elektrische ventilator met omlijsting ventilador eléctrico con bastidor ventilatore elettrico con intelaiatura электрический вентилятор с рамой elektryczny wentylator z ramą ηλεκτρικός ανεμιστήρας με πλαίσιο elektromos ventilátor kerettel ventilador eléctrico com resguardo Davlumbazlı elektrikli fan</p>
	<p>Baujahr Year Année de fabrication Bouwjaar Año de modelo Anno di costr. Год изготовления rok produkcji Ετος κατασκευής Gyártási év Ano de construção Üretim yılı</p>		<p>Lüfterrad mit X Schaufeln Fan wheel with X blades Roues de ventilateur avec X lames Ventilatorwielen met X bladen Ruedas de ventiladores con X palas Ventole con X palette Рабочее колесо вентилятора с X лопатками Wimiki wentylatorów z X łopatkami Πτερωτές ανεμιστήρων με X πτερύγια X lapátos ventilátorkerekek Rodas de ventilador com X pás X kanatlı fan çarkı</p>
	<p>Motorbezeichnung Engine type Désignation du moteur Motoraand. Designación del motor Denom. Motore Обозн. двигателя ozn. silnika Όνομ. κινητήρα Motormegj Designação do motor Motor tanımı</p>		<p>Höhe Lüfterrad Fan wheel height Hauteur roue de ventilateur Hoogte ventilatorwiel Altura rueda del ventilador Altezza della ventola Высота рабочего колеса вентилятора Wysokość wimnika wentylatora Πτερωτή υψηλής απόδοσης Ventilátorkerék magassága Altura roda do ventilador Fan çarkı yüksekliği</p>
	<p>Lüfterkupplung Fan clutch Embrayage de ventilateur Ventilatorkoppeling Acoplamiento del ventilador Giunto d'azionamento per ventilatore Муфта вентилятора Sprzęgło wentylatora Συμπλέκτης ανεμιστήρα Ventilátorkuplung Acoplamento do ventilador Fan kaplini</p>		<p>Mit Klimaanlage With A/C Avec climatisation Met airconditioning Con aire acondicionado Con climatizzatore С кондиционером Z klimatyzacją Με σύστημα κλιματισμού Klímaberendezéssel Com ar condicionado Klima sistemli</p>
	<p>Lüfterrad Fan wheel Roue de ventilateur Ventilatorwiel Rueda del ventilador Ventola Крыльчатка вентилятора Wimik wentylatora Πτερωτή ανεμιστήρα Ventilátorkerék Roda do ventilador Fan çarkı</p>		<p>Mit Anhängervorrichtung With clutch device Avec dispositif d'attache Met trekhaak Con dispositivo de suspensión Con dispositivo di agganciamento С прицепным устройством Z zawieszaniem Με διάταξη ρυμούλκησης Vonóhoroggal Com dispositivo de acoplamento Asma tertibatlı</p>
	<p>Lüfterkupplungskit Fan clutch kit Kit d'embrayage ventilateur Ventilatorkoppelingkit Kit de acoplamientos de ventiladores Giunti d'azionamento per ventilatore in kit Комплект муфт вентиляторов Zestaw sprzęgło z wentylatorem Σετ του συμπλέκτη ανεμιστήρα Ventilátorkuplung-készlet Kit de acoplamentos de ventilador Fan kaplini kiti</p>		<p>Für tropisches Klima For tropical climate Pour climat tropical Voor tropisch klimaat Para clima tropical Per clima tropicale Для тропического климата Do klimatu tropikalnego Για τροπικό κλίμα Trópusi éghajlathoz Para clima tropical Tropik klima için</p>
	<p>Zarge Frame Châssis Omlijsting Bastidor Intelaiatura Рама Rama Ράμα πλαίσιο Keret Resguardo Davlumbaz</p>		<p>Einschränkungen Restrictions Restrictions Beperkingen Limitaciones Restrizioni Ograniczenia Οграничения Ograniczenia Περιορισμοί Korlátozások Limitações Sınırlamalar</p>
	<p>Elektrischer Lüfter electrical fan ventilateur électrique elektrische ventilator ventilador eléctrico ventilatore elettrico электрический вентилятор elektryczny wentylator ηλεκτρικός ανεμιστήρας elektromos ventilátor ventilador eléctrico Elektrikli fan</p>		<p>Manuelle Schaltung Manual transmission Boîte manuelle Handmatige schakeling Conexión manual Comando manuale Ручное переключение Manualna skrzynia biegów Συμβατικό κιβώτιο ταχυτήτων Kézi kapcsolás Ligaçao manual Mekanik geçiş</p>

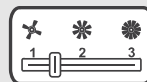

Automatische Schaltung
Automatic transmission
Boîte automatique
Automatische schakeling
Conexión automática
Comando automatico
Автоматическое переключение
Automatyczna skrzynia biegów
Αυτόματο κιβώτιο ταχυτήτων
Automatikus kapcsolás
Ligação automática
Otomatik geçiş



Leistungsstufen
Power stages
Etages de puissance
Vermogenstrappen
Niveles de potencia
Livelli di potenza
Ступени мощности
Stopnie mocy
Βαθμίδες απόδοσης
Teljesítményfokozatok
Níveis de potência
Güç kademeleri

Eine Vielzahl verschiedener elektrischer Lüfter, Lüfterkupplungen, Lüfterräder und Lüfter-Kupplungs-Kits für Pkws, Leicht-Lkws, Nfz und Landwirtschaftsfahrzeuge bietet das Original BorgWarner BERU Systems Markensortiment. Das umfangreiche Lüfterprogramm wird permanent weiter ausgebaut.

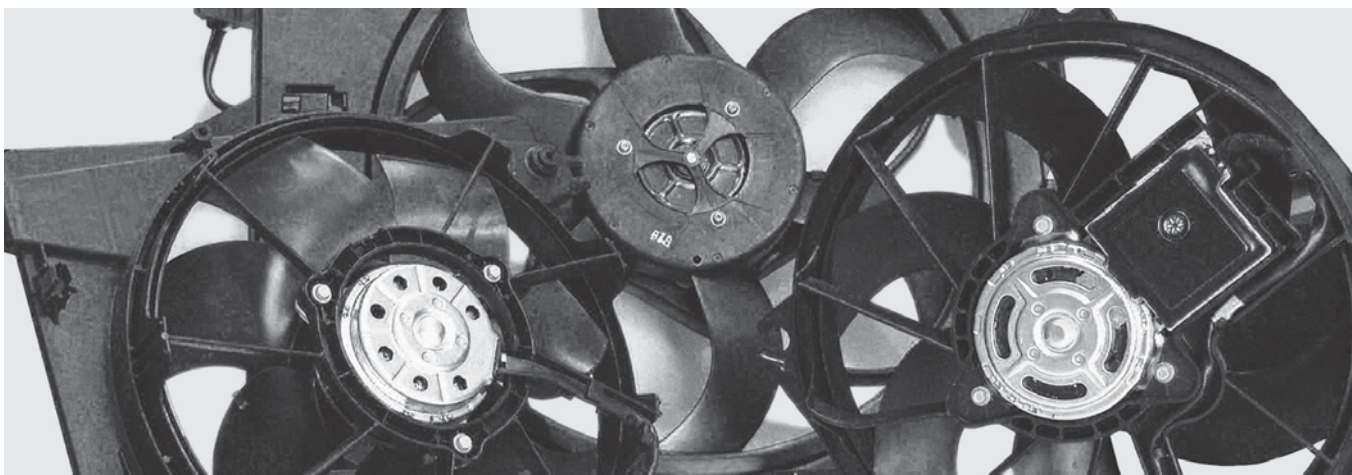

Elektrische Lüfter im Komplett-Set, für klassische Pkw-Anwendungen mit niedrigem Kühlungsbedarf.

Visco-Kupplungen – großes Leistungsspektrum

Die Leistung der Visco-Kupplungen variiert entsprechend der jeweiligen Fahrzeuganwendung von 3 kW (z. B. für Mercedes-Benz Sprinter) bis zu 50 kW (z. B. für Mercedes-Benz Actros). Wegen der bei großen Nfz erforderlichen hohen Kühlleistungen werden Visco-Kupplungen üblicherweise an Fahrzeugen mit längs eingebautem Motor eingesetzt, wie z. B. an Kippnern, Betonmischern, Abschlepp-Lkws oder Reisebussen.



Visco-Kupplung



Visctronic®-Lüfterkupplung

Elektrische Lüfter für niedrigere Leistungsklassen

Diese kraftstoffsparenden, leisen und wartungsfreien Lüfter in OE-Qualität decken klassische Pkw-Anwendungen mit quer eingebautem Motor ab, z. B. Audi, Opel, Hyundai, Fiat, Mercedes-Benz und Renault.

Zunächst sind die elektrischen Pkw-Lüfter als vormontiertes Komplett-Set aus Lüftermotor mit Rad und Lüftergehäuse erhältlich, für einen Lüftertausch mit wenigen Handgriffen. Künftig werden auch Einzelkomponenten wie Lüftergehäuse und Lüftermotoren ins BERU Sortiment aufgenommen

Visctronic®-Lüfterkupplung: exakt dosierte Frischluft

Ein technisches Highlight sind Visctronic®-Lüfterkupplungen. Sie werden vom Motorsteuergerät elektronisch angesteuert und erlauben eine variable Lüftergeschwindigkeit in Abhängigkeit von der aktuell benötigten Kühlluftmenge. Das spart Kraftstoff und stellt sicher, dass der Motor und die Zusatzaggregate wie Ölkühler, Ladeluftkühler, Retarderbremse oder Klimakondensator in jeder Fahrsituation die optimale Kühlung erhalten.

Ausfall – Ursachen und Abhilfe

Die häufigsten Gründe für Ersatzbedarf eines Lüfters sind Beschädigung durch Fremdeinwirkung (z. B. Unfall), Verschmutzung sowie mangelhafte Wartung oder nicht sachgerechte Lagerung. Hier ein kurzer Überblick über die Ursachen, die zur Fehlfunktion des Lüfters führen können, unterschieden nach vom Lüfter abhängigen und unabhängigen Ursachen. Unser Tipp: Sind keine sichtbaren Schäden an der Kupplung erkennbar, zunächst die unabhängigen Ursachen prüfen.

Entscheidend: die korrekte Lagerung

Wichtig für Handel und Werkstatt: Das Lager der Visco-Kupplung sollte möglichst immer nach oben zeigen. Wird die Kupplung längere Zeit anders herum gelagert, besteht die Gefahr, dass das Visco-Öl über den Arbeitsraum der Visco-Kupplung in das Kugellager eindringt und dort das Kugellager-Fett angreift, was wiederum zu einer Verkürzung der Lebensdauer führen kann.

URSACHE UNABHÄNGIG VON DER LÜFTERKUPPLUNG		
URSACHE	AUSWIRKUNG	ABHILFE
Kühler ist verschmutzt.	Unzureichende Kühlung des Kühlwassers. Dadurch gelangt zu wenig erwärmte Luft an das Bimetall der Visco-Kupplung.	Kühlerlamellen vorsichtig säubern / mit Pressluft frei blasen.
Kühlsystem enthält zu wenig Kühlflüssigkeit.	Motortemperatur übersteigt die zulässigen Grenzwerte.	Ausreichend Kühlflüssigkeit nachfüllen.
Schläuche für Kühlsystem sind verengt oder geknickt.	Kein ausreichender Durchfluss des Kühlmittels, Motortemperatur übersteigt die zulässigen Grenzwerte.	Kühlmittel-Schläuche auf Verlegung bzw. Verengung überprüfen.
Durch Zusatz-Ein-/Anbauten verringerter Luftdurchsatz des Kühlers (Zusatz-Scheinwerfer/ zusätzliche Abdeckplatte im Wintereinsatz vor dem Motorkühler ...)	Keine ausreichende Motorkühlung.	Ein-/Anbauteile entfernen oder anderweitig anbringen.

URSACHE IN DER LÜFTERKUPPLUNG		
URSACHE	AUSWIRKUNG	ABHILFE
Visco-Kupplung ist undicht.	Silikonöl ist ausgelaufen. Die erforderliche Lüfterdrehzahl wird nicht erreicht.	Visco-Kupplung ist zu erneuern.
Bimetallspirale wurde beschädigt oder manipuliert. Halterung des Bimetalls ist beschädigt/ verstellt, so dass diese ihre kalibrierte Position verloren hat.	Lüfter läuft permanent zu schnell oder zu langsam, oder schaltet zu spät oder zu früh. Die korrekte Werkseinstellung wurde verstellt. Ventil in der Lüfterkupplung kann nicht mehr korrekt regeln.	Visco-Kupplung ist zu erneuern, da der korrekte Schaltpunkt durch die Werkstatt nicht eingestellt werden kann.
Silikonöl wurde überhitzt und ist verkocht. Hierdurch verwandelt es sich in eine zähe Masse und verklebt den Arbeitsspalt.	Der Lüfter läuft permanent mit und kann im Stand nicht frei gedreht werden. Die Motortemperatur erreicht nicht die vorgeschriebene Betriebstemperatur.	Visco-Kupplung ist zu erneuern.
Das Kippspiel im Kugellager ist zu groß.	Beide Kupplungsscheiben haben kein ausreichendes Spiel mehr zueinander. Die Wandungen berühren sich und zerstören sich selbst. Es kommt zu Metallabrieb. Silikonöl verdickt und verstopft die Bohrung für den Fluid-Rücklauf.	Visco-Kupplung ist zu erneuern. Achtung: Vor dem Einbau einer neuen Visco-Kupplung ist die Ausfallursache der alten Visco-Kupplung zu klären/beseitigen (z.B. Unwucht durch gebrochenes Lüfterblatt, Rundläufe Anflanschung, Unwucht Anflanschadapter).
Ausgleichsgewicht fehlt am Lüfterrad.	Geräusche und Vibrationen am Lüfterrad, hoher Verschleiß der Lager.	Lüfterrad ersetzen bzw. Lüfterrad ausbalancieren.

URSACHE IM UMFELD DER ELEKTRISCHEN LÜFTUNG		
URSACHE	AUSWIRKUNG	ABHILFE
Elektromotor defekt.	Lüfter dreht nicht.	Lüfter ersetzen bzw. Elektromotor erneuern.
Elektrischer Widerstand ist defekt.	Eine oder mehrere Drehzahlstufen sind ohne Funktion.	Elektrische Widerstandseinheit erneuern.
Elektronische Steuereinheit ist defekt.	Die unterschiedlichen Drehzahlstufen sind ohne Funktion bzw. Lüfter dreht permanent.	Elektronische Steuereinheit erneuern.
Sicherung für elektrischen Lüfter-/Kühlsystem ist durchgebrannt.	Elektrischer Lüfter dreht nicht	Stromaufnahme des Elektromotors prüfen bzw. Elektromotor erneuern.
Temperaturschalter im Kühlkreislauf ist defekt.	Lüfter dreht nicht, da kein Signal vom Temperaturschalter vorhanden.	Temperaturschalter erneuern.

The original BorgWarner brand range, available to workshops through BERU Systems, offers numerous different electrical fans, fan clutches, fan wheels and fan clutch kits for cars, light trucks, utility vehicles and agricultural vehicles. The comprehensive range of fans is constantly being expanded.

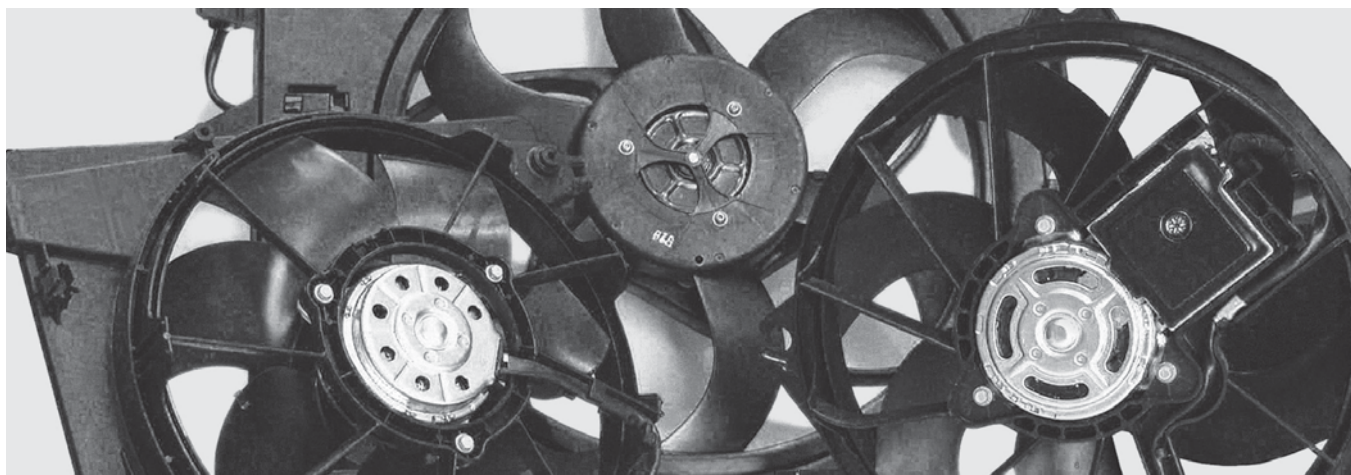

Complete set of electrical fans for traditional applications in cars with low cooling requirements.

Visco clutches - wide power range

The power output of Visco clutches varies, according to the vehicle application in question, from 3 kW (for the Mercedes-Benz Sprinter, for example) to 50 kW (e.g. for the Mercedes-Benz Actros). Due to the high cooling power required for large utility vehicles, Visco clutches are generally installed in vehicles with lengthways mounted engines, such as on tippers, concrete mixers, towing trucks or passenger buses.



Visco clutches



Visctronic® fan clutch

Electrical fans for lower power classes

These fuel-saving, quiet and maintenance-free OE-quality fans cover traditional car applications with cross-mounted engines, such as Audi, Opel, Hyundai, Fiat, Mercedes-Benz and Renault.

The electrical fans for cars are initially available as a complete pre-assembly, consisting of fan motor with wheel and fan housing, enabling the fan to be replaced with just a few maneuvers. In future the BERU range will also include individual components such as the fan housing and fan motors.

Visctronic® fan clutch: precisely metered outside air

Visctronic® fan clutches are a technical highlight. They are controlled electronically by the motor control unit, enabling variable fan speeds, depending on the actual amount of cooling air required. This saves fuel and ensures that the engine and the add-on units such as the oil cooler, charge air cooler, retarding brake and air conditioning condenser will maintain optimum cooling in every driving condition.

Failure - causes and remedies

The most frequent reasons for replacing a fan are damage caused by an extraneous force (e.g. accident) or dirt, as well as inadequate maintenance or improper storage. Here is a brief overview of the causes, which may cause the fan to malfunction, differentiated according to the causes which are dependent and independent of the fan. Our tip: If there is no visible damage on the clutch, first check the non-dependent causes.

Crucial point: correct storage.

Important for retailers and workshops : The Visco clutch bearing should as far as possible always be stored pointing upwards. If the clutch is stored for a long time the other way round, there is a risk that the Visco oil will penetrate inside the ball bearing, through the working area of the Visco clutch, and will affect the ball bearing grease there, which could cause a reduction in service life.

CAUSES INDEPENDENT OF THE FAN CLUTCH		
CAUSES	EFFECT	REMEDY
Cooler is dirty.	Cooling water inadequately cooled. As a result, too little heated air reaches the bimetal of the Visco clutch.	Carefully clean cooler blades/blow off cooler blades with compressed air.
Cooling system contains too little coolant.	Engine temperature exceeds the permitted limit values.	Top up with adequate coolant.
Hoses for cooling system are constricted or kinked.	Coolant flow is inadequate, engine temperature exceeds the permitted limit values.	Check that coolant hoses are installed correctly and not constricted.
Reduced air throughput from cooler caused by additional installations and fixtures (additional headlamp/additional cover plate in front of engine cooler for winter use ...)	Inadequate engine cooling	Remove the installations/fixtures or attach them in a different way

CAUSE IN THE FAN CLUTCH		
CAUSES	EFFECT	REMEDY
Visco clutch is leaking.	Silicone oil emerging. The required fan speed is not reached.	Visco clutch must be replaced.
Bimetallic helix has been damaged or tampered with. Holder for the bimetal is damaged/out of alignment and has therefore lost its calibrated position.	Fan constantly runs too fast or too slow, or actuates too late or too early. The correct factory setting has been misaligned. Valve in the fan clutch can no longer maintain correct control.	Visco clutch must be replaced, because the correct actuation point cannot be adjusted at the workshop.
Silicone oil has overheated and boiled away. This causes it to turn into a stiff paste and clog the working gap.	The fan runs continuously and cannot be rotated freely when at a standstill. The engine temperature does not reach the stipulated operating temperature.	Visco clutch must be replaced.
The tilting clearance inside the ball bearing is too big.	The two clutch disks no longer have adequate clearance from one another. The walls are touching each other and are suffering damage. This results in metal abrasion. Silicone oil is congealing and blocking the fluid return bore.	Visco clutch must be replaced. Caution: Before installing a new Visco clutch, clarify/eliminate the cause of the failure of the old Visco clutch (e.g. imbalance due to broken fan blade, concentricity of flange connection, imbalance of flange-mounted adapter).
No balancing weight at fan wheel	Noise and vibration at the fan wheel, higher wear at bearing	Replace or rebalance the fan wheel

NO BALANCING WEIGHT AT FAN WHEEL		
CAUSES	EFFECT	REMEDY
Faulty electrical motor	Fan does not rotate	Replace the fan or renew the electrical motor
Electrical resistance faulty	One or more speed stages are not operating	Replace the electrical resistance unit
Electronic control unit is faulty	The various speed stages are not operating, or the fan is rotating constantly	Replace the electronic control unit
Fuse for electrical fan/cooling system has blown	Electrical fan does not rotate	Check current draw of electrical motor and/or replace electrical motor
Temperature switch inside cooler circuit is faulty	Fan does not rotate because no signal is present from the temperature switch	Replace temperature switch

La gamme d'équipement d'origine du groupe BorgWarner accessible aux ateliers via BERU Systems offre une multitude de différents ventilateurs électriques, d'embrayages de ventilateur, de roues de ventilateur et de kits d'embrayage de ventilateur pour les voitures de tourisme, camionnettes, véhicules utilitaires et machines agricoles. La vaste gamme de ventilateurs est constamment élargie.

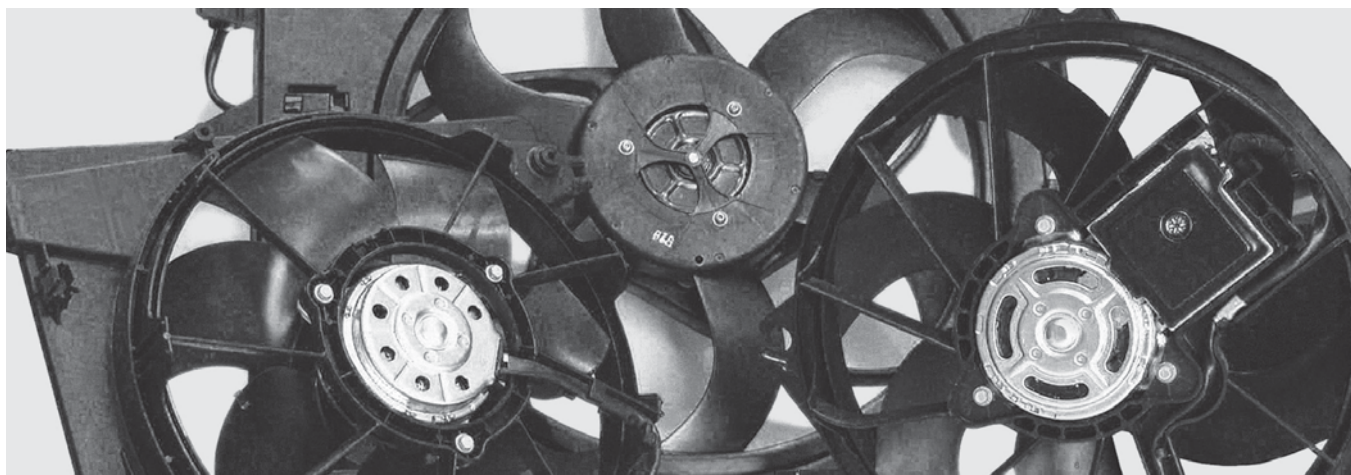

Ventilateurs électriques en kit complet pour les applications classiques dans le domaine des voitures de tourisme avec un faible besoin en refroidissement.

Visco-coupleurs – une vaste plage de puissance

La puissance des visco-coupleurs varie en fonction de l'utilisation respective du véhicule entre 3 kW (par ex. pour Mercedes-Benz Sprinter) et un maximum de 50 kW (par ex. pour Mercedes-Benz Actros). En raison des puissances frigorifiques élevées requises dans le cas des grands véhicules utilitaires, les visco-coupleurs sont généralement utilisés sur les véhicules avec un moteur monté en sens longitudinal comme par ex. les camions à benne basculante, les bétonnières à malaxeur, les dépanneuses ou les cars.

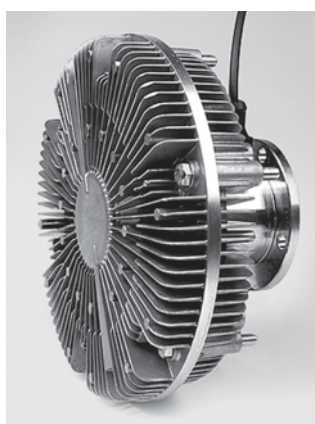

Visco-coupleurs



Embrayage de ventilateur Visctronic®

Ventilateurs électriques pour catégories de puissance faibles

Ces ventilateurs économes en carburant, silencieux et sans entretien en qualité première monte couvrent les applications classiques dans le domaine des voitures de tourisme avec un moteur transversal, par ex. Audi, Opel, Hyundai, Fiat, Mercedes-Benz et Renault.

Les ventilateurs électriques pour les voitures de tourisme sont actuellement disponibles sous forme de kit complet préassemblé composé du moteur de ventilateur avec roue et boîtier de ventilateur permettant un remplacement du ventilateur en quelques manipulations. Prochainement, les composants individuels tels que le boîtier du ventilateur et les moteurs de ventilateur seront également intégrés dans la gamme d'équipement de BERU.

Embrayage de ventilateur Visctronic® : de l'air frais dosé avec précision

Les embrayages de ventilateur Visctronic® sont un must technologique. Ils sont commandés par électronique au moyen de l'appareil de commande du moteur et permettent de moduler la vitesse du ventilateur en fonction de la quantité d'air nécessaire à un moment donné. Cela permet d'économiser du carburant et assure un refroidissement optimal du moteur et des groupes supplémentaires tels que le refroidisseur d'huile, le refroidisseur d'air de suralimentation, le frein à retardement ou le condensateur de climatisation dans toutes les situations de conduite.

Panne – causes et remèdes

Les raisons les plus courantes pour le besoin de pièces de rechange pour un ventilateur sont l'endommagement pour des raisons externes (par ex. accident), l'encrassement ainsi qu'un entretien insuffisant ou un stockage inapproprié. Voici un bref aperçu des causes pouvant provoquer un dysfonctionnement du ventilateur, classées en causes dépendant du ventilateur et indépendantes du ventilateur. Notre conseil : si l'embrayage ne présente pas de dommages visibles, vérifier dans un premier temps les causes indépendantes.

Avantage décisif : le stockage correct

Important pour les commerces et les ateliers : le palier du visco-coupleur devrait toujours être orienté vers le haut si possible. Si le coupleur est stocké dans l'autre sens pendant une période prolongée, l'huile visco risque de pénétrer dans le roulement à billes à travers le compartiment de travail du visco-coupleur et d'y altérer la graisse du roulement à billes pouvant alors entraîner une réduction de la durée de vie.

CAUSE INDÉPENDANTE DE L'EMBRAYAGE DE VENTILATEUR

CAUSE	EFFET	REMÈDES
Le radiateur est encrassé.	Refroidissement insuffisant de l'eau de refroidissement. Le bimétal du visco-coupleur ne reçoit par conséquent pas assez d'air réchauffé.	Nettoyer les lamelles de radiateur / les souffler à l'air comprimé avec prudence.
Le système de refroidissement ne contient pas assez de liquide de refroidissement.	La température du moteur dépasse les valeurs limite admissibles.	Faire l'appoint de liquide de refroidissement.
Les flexibles pour le système de refroidissement présentent des rétrécissements ou sont tordus.	Débit insuffisant du réfrigérant, la température du moteur dépasse les valeurs limite admissibles.	Contrôler la pose des flexibles de réfrigérant et vérifier s'ils présentent des rétrécissements.
Débit d'air du radiateur réduit par des pièces incorporées / rapportées supplémentaires (phares supplémentaires / plaque de couverture supplémentaire en cas d'utilisation en hiver en amont du radiateur du moteur ...)	refroidissement insuffisant du moteur	Retirer les pièces incorporées / rapportées ou les fixer ailleurs

CAUSE DUE À L'EMBRAYAGE DE VENTILATEUR

CAUSE	EFFET	REMÈDES
Le visco-coupleur n'est pas étanche.	Fuite d'huile silicone. Le ventilateur n'atteint pas la vitesse de rotation requise.	Le visco-coupleur doit être remis à neuf.
La spirale bimétallique a été endommagée ou manipulée. Le logement du bimétal a été endommagé / déréglé de sorte qu'elle a perdu sa position calibrée.	La ventilateur tourne constamment trop rapidement ou trop lentement ou commute trop tard ou trop tôt. Le réglage usine correct a été altéré. La valve dans l'embrayage de ventilateur ne parvient plus à effectuer de réglage correct.	Le visco-coupleur doit être remis à neuf car le point de commutation correct ne peut pas être réglé par l'atelier.
L'huile silicone a surchauffé et s'est évaporée. Il se transforme alors en masse visqueuse et encolle l'interstice de travail.	Le ventilateur tourne constamment et ne peut pas être tourné librement à l'arrêt. La température du moteur n'atteint pas la température de service prescrite.	Le visco-coupleur doit être remis à neuf.
Le jeu de basculement dans le roulement à billes est trop important.	Les deux disques d'embrayage n'ont plus suffisamment de jeu l'un par rapport à l'autre. Les parois se touchent et se détruisent elles-mêmes. Des résidus d'abrasion métalliques se produisent. L'huile silicone s'épaissit et bouche l'alésage pour le reflux de fluide.	Le visco-coupleur doit être remis à neuf. Attention : avant le montage d'un nouveau visco-coupleur, la cause de la panne de l'ancien visco-coupleur doit être identifiée / éliminée (par ex. défaut d'équilibrage dû à une pale de ventilateur cassée, concentricité raccord par bride, défaut d'équilibrage adaptateur de bride).
Le contrepois manque sur la roue de ventilateur	Bruits et vibrations sur la roue de ventilateur, usure élevée des paliers	Remplacer la roue de ventilateur ou l'équilibrer le cas échéant

CAUSE EN RAPPORT AVEC LA VENTILATION ÉLECTRIQUE

CAUSE	EFFET	REMÈDES
Moteur électrique défectueux	Le ventilateur ne tourne pas	Remplacer le ventilateur ou remettre à neuf le moteur électrique
La résistance électrique est défectueuse	un ou plusieurs niveaux de vitesse de rotation ne fonctionnent pas	Remettre à neuf l'unité de résistance électrique
L'unité de commande électronique est défectueuse.	les différents niveaux de vitesse de rotation ne fonctionnent pas ou le ventilateur tourne en permanence	Remettre à neuf l'unité de commande électronique
Le fusible pour le ventilateur électrique / le système de refroidissement a fondu	Le ventilateur électrique ne tourne pas	Contrôler le courant absorbé par le moteur électrique ou remettre à neuf le moteur électrique
L'interrupteur thermostatique dans le circuit de refroidissement est défectueux	Le ventilateur ne tourne pas en raison de l'absence de signal venant de l'interrupteur thermostatique	Remettre à neuf l'interrupteur thermostatique

Veel verschillende elektrische ventilatoren, ventilatorkoppelingen, schoepenwielen van ventilatoren en ventilator-koppelingskits voor personenauto's, lichte vrachtauto's, bestelwagens en landbouwvoertuigen worden geboden door het originele BorgWarner merkassortiment, dat via BERU Systems voor werkplaatsen toe-gankelijk is. Het omvangrijke ventilatorprogramma wordt permanent verder uitgebreid.

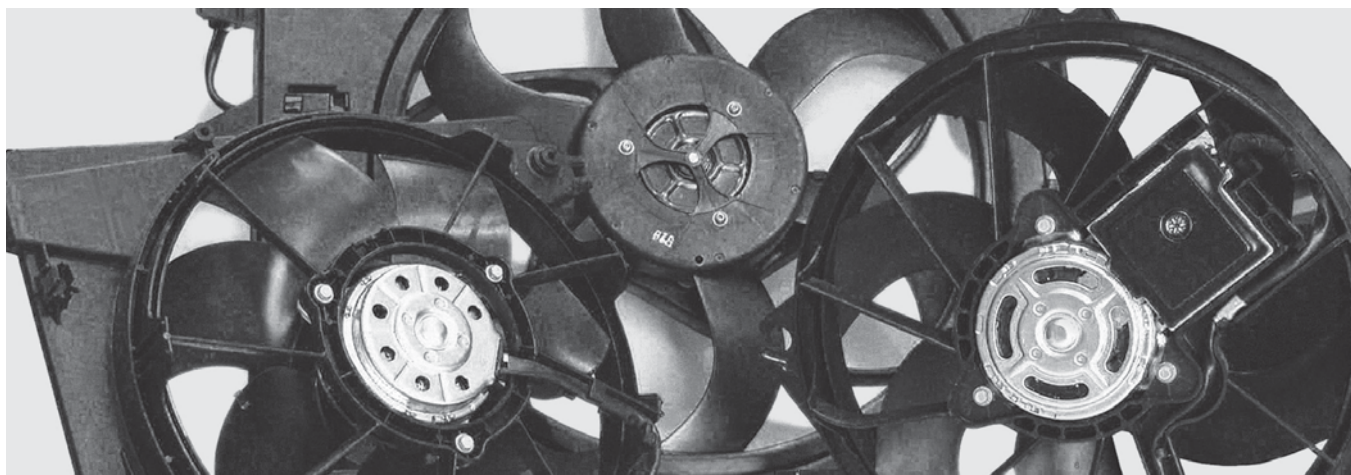

Elektrische ventilatoren in een complete set, voor klassieke personenauto-toepassingen met een lage behoefte aan koeling.

Visco-koppelingen – groot vermogenspectrum

Het vermogen van de Visco-koppelingen varieert conform de betreffende voertuigtoepassing van 3 kW (bijv. voor Mercedes-Benz Sprinters) tot en met 50 kW (bijv. voor Mercedes-Benz Actros). Vanwege de bij grote bestelwagens vereiste grote koelvermogens worden Visco-koppelingen normaliter bij voertuigen met in lengterichting gemonteerde motor toegepast, zoals bijv. bij kiepauto's, betonmixers, takelwagens of reisbussen.



Visco-koppelingen



Visctronic®-ventilator-koppeling

Elektrische ventilatoren voor lagere vermogensklassen

Deze brandstofbesparende, stille en onderhoudsvrije ventilatoren in OE-kwaliteit dekken klassieke personenauto-toepassingen met dwars gemonteerde motor af, bijv. Audi, Opel, Hyundai, Fiat, Mercedes-Benz en Renault.

Voorlopig zijn de elektrische personenautoventilatoren te koop als voorgemonteerde complete set met schoepenwiel en ventilator-behuizing, voor ventilatorvervanging met slechts enkele handgrepen. In de toekomst worden ook losse componenten zoals ventilatorbehuizing en ventilatormotoren in het BERU assortiment opgenomen

Visctronic®-ventilator-koppeling: exact gedoseerde frisse lucht

Visctronic®-ventilator-koppelingen zijn een technisch highlight. Zij worden door het motorbesturingsapparaat elektronisch aangestuurd en maken een variabele ventilatorsnelheid afhankelijk van het actueel vereiste koelluchtvolume mogelijk. Dat bespaart brandstof en waarborgt dat de motor en de aanvullende aggregaten zoals oliekoeler, interkoeler, retarderrem of aircocondensator in elke rij situatie de optimale koeling krijgen.

Uitvallen – oorzaken en oplossing

De meest frequente oorzaken voor het moeten vervangen van een ventilator zijn beschadiging door inwerking van buitenaf (bijv. ongeval), vervuiling en gebrekkig onderhoud of ondoelmatige lagering. Hier een kort overzicht van de oorzaken die kunnen leiden tot een storing van de ventilator, onderscheiden volgens van de ventilator afhankelijke en onafhankelijke oorzaken. Onze tip: Als er geen zichtbare schade aan de koppeling te herkennen valt, eerst de onafhankelijke oorzaken controleren.

Beslissend: de correcte lagering

Belangrijk voor handel en werkplaats: Het lager van de Visco-koppeling moet zo mogelijk altijd naar boven liggen. Als de koppeling vrij lang andersom wordt gelagerd, bestaat het gevaar dat de Visco-olie via de werkruimte van de Visco-koppeling het kogellager binnendringt en daar het kogellageretvet aantast, wat weer tot een verkorting van de levensduur kan leiden.

OORZAAK ONAFHANKELIJK VAN DE VENTILATORKOPPELING		
OORZAAK	UITWERKING	OPLOSSING
Koeler is vervuild.	Onvoldoende koeling van het koelwater. Daardoor bereikt te weinig verwarmde lucht het bimetaal van de Visco-koppeling.	Ventilatorlamellen voorzichtig schoonmaken/met perslucht schoonblazen.
Koelsysteem krijgt te weinig koelvloeistof.	Motortemperatuur is hoger dan de toegestane grenswaarden.	Voldoende koelvloeistof bijvullen.
Slangen voor koelsysteem zijn vernauwd of geknikt.	Onvoldoende doorstroming van het koelmiddel, motortemperatuur is hoger dan de toegestane grenswaarden.	Koelmiddelslangen controleren op verplaatsing c.q. vernauwing.
Door extra in-/aangebouwde onderdelen verminderde luchtdoorvoer van de koeler (extra schijnwerper/extra afdekplaat tijdens wintergebruik vóór de motorkoeler...)	Onvoldoende motorkoeling	In-/aanbouwonderdelen verwijderen of op een andere manier aanbrengen

OORZAAK IN DE VENTILATORKOPPELING		
OORZAAK	UITWERKING	OPLOSSING
Visco-koppeling lekt.	Siliconenvloeistof is uitgelopen. Het vereiste ventilatortoerental wordt niet bereikt.	Visco-koppeling moet worden vervangen.
Bimetalen spiraal werd beschadigd of gemanipuleerd. Houder van het bimetaal is beschadigd/versteld, zodat deze zijn gekalibreerde positie verloren heeft.	Ventilator loopt permanent te snel of te langzaam, of schakelt te laat of te vroeg. De correcte fabrieksinstelling werd versteld. Klep in de ventilatorkoppeling kan niet meer correct regelen.	Visco-koppeling moet worden vervangen, omdat het correcte schakelpunt door de werkplaats niet kan worden ingesteld.
Siliconenvloeistof werd oververhit en is verkookt. Hierdoor verandert deze in een taaie massa en plakt de werkspleet vast.	De ventilator loopt permanent mee en kan in de stand niet vrij worden gedraaid. De motortemperatuur bereikt niet de voorgeschreven bedrijfstemperatuur.	Visco-koppeling moet worden vervangen.
De kantelspeling in het kogellager is te groot.	Beide koppelingsschijven hebben niet genoeg speling meer t.o.v. elkaar. De wanden raken elkaar en vernielen zichzelf. Er ontstaat metaalgruis. Siliconenvloeistof verdikt en verstopt de uitboring voor de vloeistofretourleiding.	Visco-koppeling moet worden vervangen. Attentie: Voordat een nieuwe Visco-koppeling wordt ingebouwd, moet de oorzaak voor het uitvallen van de oude Visco-koppeling worden opgehelderd/opgelost (bijv. onbalans door gebroken ventilatorblad, draaiarmen flensbevestiging, onbalans flensadapter).
Balanceergewicht ontbreekt bij het schoepenwiel van de ventilator	Geluiden en trillingen bij het schoepenwiel van de ventilator, grote slijtage van de lagers	Schoepenwiel van ventilator vervangen c.q. schoepenwiel van ventilator uitbalanceren

OORZAAK IN DE OMGEVING VAN DE ELEKTRISCHE VENTILATIE		
OORZAAK	UITWERKING	OPLOSSING
Elektromotor defect	Ventilator draait niet	Ventilator vervangen c.q. elektromotor vervangen
Elektrische weerstand is defect	Eén of meer toerentalstanden hebben geen functie	Elektrische weerstandunit vervangen
Elektronische regelunit is defect	De verschillende toerentalstanden hebben geen functie c.q. ventilator draait permanent	Elektronische regelunit vervangen
Zekering voor elektrisch ventilator-/koelsysteem is doorgebrand	Elektrische ventilator draait niet	Stroomopname van de elektromotor controleren c.q. elektromotor vervangen
Temperatuurschakelaar in de koelercirculatie is defect	Ventilator draait niet, omdat er geen signaal is van de temperatuurschakelaar	Temperatuurschakelaar vervangen

El surtido BorgWarner original, accesible para los talleres a través de BERU Systems, ofrece una amplia variedad de diferentes ventiladores eléctricos, acoplamientos de ventilador, ruedas de ventilador y kits de acoplamientos de ventilador para turismos, camiones ligeros, vehículos utilitarios y vehículos agrícolas. El extenso programa de ventiladores sigue ampliándose constantemente.

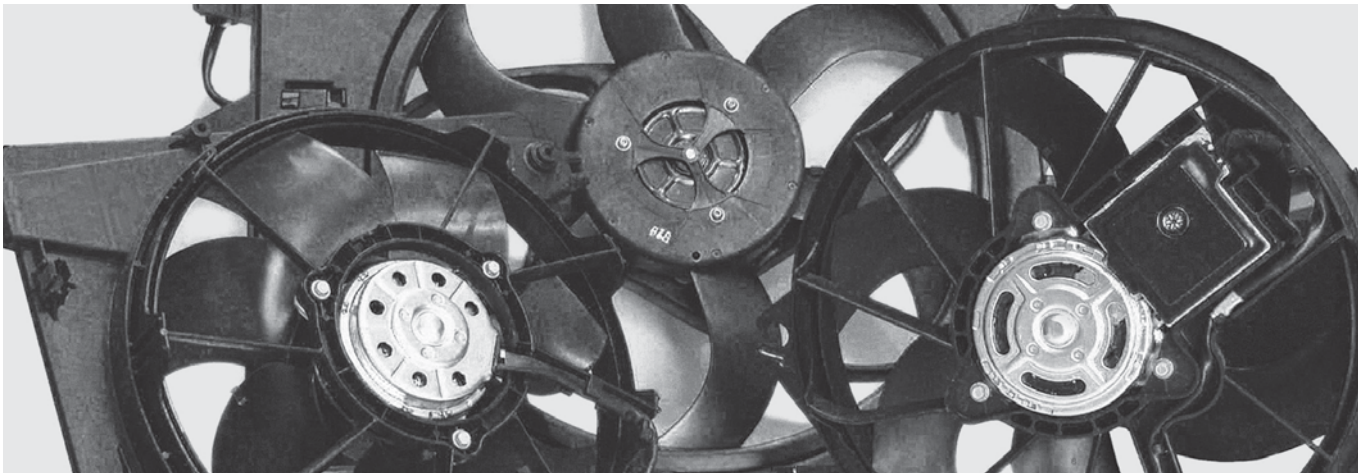

Ventiladores eléctricos en un kit completo, para aplicaciones tradicionales de turismos con reducida necesidad de refrigeración.

Acoplamientos Visco: amplio espectro energético

La potencia de los acoplamientos Visco varía, en función de la correspondiente aplicación del vehículo, desde 3 kW (p. ej. para Mercedes-Benz Sprinter) hasta 50 kW (p. ej. para Mercedes-Benz Actros). Normalmente, y debido a la mayor necesidad de refrigeración de los vehículos utilitarios, el montaje de los acoplamientos Visco en los vehículos se realiza con el motor en posición longitudinal, como, por ejemplo, en volquetes, camiones hormigoneras, vehículos tractores o autobuses.



Acoplamientos Visco



Acoplamiento de ventilador Visctronic®

Ventiladores eléctricos para tipos de potencia reducidos

Estos ventiladores silenciosos, ahorradores de combustible y libres de mantenimiento en calidad de equipo original cubren las aplicaciones tradicionales de turismos con motores de montaje transversal, por ejemplo Audi, Opel, Hyundai, Fiat, Mercedes-Benz y Renault.

Los ventiladores eléctricos para turismos están disponibles como kit completo premontado compuesto de motor del ventilador, rueda y carcasa del ventilador, para realizar un cambio de ventilador en pocos pasos. Próximamente se incluirán también componentes individuales como carcasas y motores de ventilador en el surtido de BERU

Acoplamiento de ventilador Visctronic®: aire fresco exactamente dosificado

Un hito tecnológico son los acoplamientos de ventilador Visctronic®. Se controlan electrónicamente por la unidad de control del motor y permiten una velocidad variable del aire en función de la cantidad de aire de refrigeración necesaria en el momento. Esto ahorra combustible y asegura que el motor y los componentes adicionales, como radiador de aceite, ventilador de aire de carga, freno del retardador o condensador de climatizador obtengan la refrigeración óptima en cada situación de conducción.

Avería: causas y ayuda

Los motivos más frecuentes de sustitución de un ventilador son daños producidos por causas ajenas (p. ej. accidentes), suciedad, mantenimiento insuficiente o almacenamiento inadecuado. A continuación le ofrecemos un esquema de los motivos que pueden provocar una avería en el funcionamiento del ventilador, diferenciados en función de si dependen o no del ventilador. Nuestro consejo: si no se detectan daños visibles en el acoplamiento, compruebe primero los motivos independientes.

Decisivo: el almacenamiento correcto

Importante para el comercio y el taller: el almacenamiento del acoplamiento Visco debería realizarse siempre orientado hacia arriba, en la medida de lo posible. Si el acoplamiento se almacena al revés durante un tiempo prolongado, existe el peligro de que el aceite Visco penetre en el rodamiento de bolas a través del espacio de trabajo del acoplamiento Visco, atacando allí a la grasa del rodamiento de bolas, lo que puede conllevar una reducción de la vida útil.

MOTIVOS QUE NO DEPENDEN DEL ACOPLAMIENTO DE VENTILACIÓN		
MOTIVOS	CONSECUENCIA	SOLUCIÓN
El radiador está sucio.	Refrigeración insuficiente del agua de refrigeración. El aire caliente que pasa a la espiral bimetálica del acoplamiento Visco es insuficiente.	Limpiar las láminas del ventilador con cuidado/ secar con aire a presión.
El líquido refrigerante del sistema de refrigeración es insuficiente.	La temperatura del motor sobrepasa el valor límite permitido.	Llenar con suficiente fluido refrigerante.
Los tubos flexibles del sistema de refrigeración están contraídos o doblados.	Flujo de refrigerante insuficiente, la temperatura del motor supera el valor límite permitido.	Comprobar desplazamientos o estrecheces en los tubos flexibles de refrigerante.
Flujo de aire reducido del radiador (faros adicionales/cubierta adicional en el servicio de invierno delante del radiador del motor...) debido a piezas de montaje/acoplamiento adicionales.	No hay una refrigeración del motor suficiente.	Retirar las piezas de montaje/acoplamiento o colocarlas de otro modo.

MOTIVOS QUE SÍ DEPENDEN DEL ACOPLAMIENTO DE VENTILACIÓN		
MOTIVOS	CONSECUENCIA	SOLUCIÓN
El acoplamiento Visco no es estanco.	Hay fugas de aceite de silicona. No se alcanza la velocidad requerida del ventilador.	Debe renovarse el acoplamiento Visco.
La espiral bimetálica se ha dañado o ha sido manipulada. El soporte de la espiral bimetálica está dañado/desajustado de tal forma, que ha perdido su posición calibrada.	El ventilador funciona permanentemente demasiado rápido o demasiado lento, o se desconecta demasiado pronto o demasiado tarde. Se ha perdido el ajuste correcto de taller. La válvula del acoplamiento de ventilación ya no puede regular correctamente.	Debe renovarse el acoplamiento Visco, ya que no es posible ajustar en el taller el punto de conmutación correcto.
El aceite de silicona se ha sobrecalentado y cocido. Si ocurre esto, el aceite se transforma en una masa dura y se adhiere a la ranura de trabajo.	El funcionamiento del ventilador depende de ella y, por tanto, no puede girar de forma independiente. El motor no alcanza la temperatura de servicio prescrita.	Debe renovarse el acoplamiento Visco.
El juego de volqueo en el rodamiento de bolas es demasiado grande.	El juego de los dos discos del acoplamiento ya no es suficiente. Las paredes entran en contacto y se destruyen mutuamente. Se produce desgaste del metal. El aceite de silicona aumenta su densidad y atasca el orificio de retorno de fluidos.	Debe renovarse el acoplamiento Visco. Atención: antes del montaje de un nuevo acoplamiento Visco, debe determinarse la causa de la avería del acoplamiento antiguo (p. ej. desequilibrio por rotura de alguna paleta del ventilador, rotor embridado, desequilibrio en el adaptador de embridado).
Falta el peso de compensación en la rueda del ventilador	Ruidos o vibraciones en la rueda del ventilador, desgaste elevado de los cojinetes	Sustituir la rueda del ventilador o equilibrarla.

CAUSA EN EL ENTORNO DE LA VENTILACIÓN ELÉCTRICA		
MOTIVOS	CONSECUENCIA	SOLUCIÓN
Motor eléctrico defectuoso	El ventilador no gira	Sustituir el ventilador o renovar el motor eléctrico
Resistencia eléctrica defectuosa	Una o varias etapas de velocidad sin funcionamiento	Sustituir la unidad de resistencia eléctrica
Unidad de control electrónica defectuosa	Las diferentes etapas de velocidad no funcionan o el ventilador gira permanentemente	Renovar la unidad de control eléctrica
Fusible para el sistema del ventilador/sistema de refrigeración eléctrico quemado	El ventilador eléctrico no gira	Comprobar el consumo de corriente del motor eléctrico o renovar el motor eléctrico
Termostato automático del circuito de refrigeración defectuoso	El ventilador no gira, ya que no hay señal del termostato automático	Renovar el termostato automático

L'originale gamma BorgWarner, accessibile alle officine tramite BERU Systems, offre diversi ventilatori elettrici, giunti d'azionamento per ventilatore, ventole e kit di giunti d'azionamento per ventilatori per autovetture, veicoli commerciali leggeri, veicoli industriali e mezzi agricoli. L'ampia gamma di ventilatori continuerà a essere ampliata.

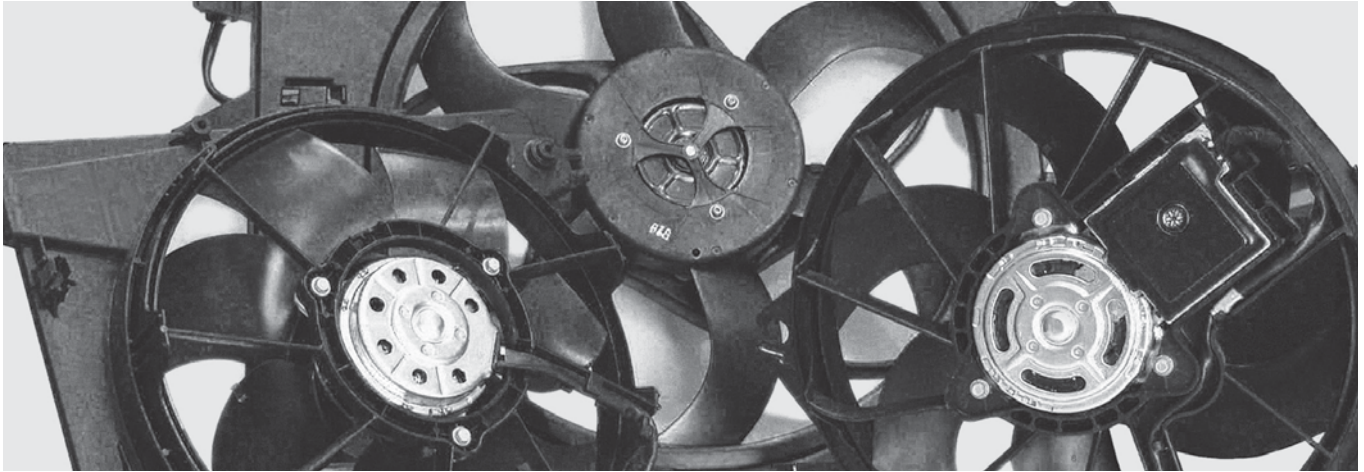

Ventilatori elettrici con set completo per applicazioni classiche per autovetture con una domanda di raffreddamento ridotta.

Giunti d'azionamento viscoso: ampio spettro prestazionale

La potenza dei giunti d'azionamento viscoso varia a seconda delle rispettive applicazioni automobilistiche da 3 kW (ad es. per Mercedes-Benz Sprinter) a 50 kW (ad es. per Mercedes-Benz Actros). Date le elevate potenze di raffreddamento necessarie per i veicoli industriali, i giunti d'azionamento viscoso vengono solitamente inseriti nei veicoli con motore installato longitudinalmente, come ad es. ribaltabili, betoniere, camion rimorchio o autobus turistici.



Giunti d'azionamento viscoso



Giunto d'azionamento per ventilatore Visctronic®

Ventilatori elettrici per classi di potenza inferiori

Questi ventilatori di qualità originale a risparmio di carburante, silenziosi ed esenti da manutenzione, sono adatti alle applicazioni classiche per autovetture con motore installato trasversalmente, ad es. Audi, Opel, Hyundai, Fiat, Mercedes-Benz e Renault.

Per il momento i ventilatori elettrici per auto sono disponibili come set completo premontato composto da motore con ventola e involucro del ventilatore: in questo modo la sostituzione del ventilatore richiede meno operazioni. In futuro anche i singoli componenti, quali alloggiamento e motori del ventilatore, verranno inseriti nella gamma BERU

Giunto d'azionamento per ventilatore Visctronic®: aria fresca dosata con precisione

Un importante elemento tecnico sono i giunti d'azionamento per ventilatore Visctronic®. Vengono comandati elettronicamente dalla centralina elettronica del motore e consentono una velocità del ventilatore variabile in base alla quantità di aria fredda necessaria. Si risparmia così carburante e si garantisce che motore e gruppi supplementari, quali refrigeratore d'olio, intercooler, freno retarder o condensatore del climatizzatore, ricevano il raffreddamento ottimale in ogni situazione di guida.

Guasto: cause e rimedi

Le cause più comuni per una sostituzione del ventilatore sono danni causati da influssi esterni (ad es. incidente), sporcizia e manutenzione carente oppure uno stoccaggio non corretto. Viene qui offerta una breve panoramica sulle cause che possono provocare un malfunzionamento del ventilatore, suddivise tra cause che dipendono dal ventilatore e che non dipendono da esso. Il nostro consiglio: se non vi sono danni visibili sul giunto d'azionamento, controllare prima le cause non dipendenti.

Decisivo: uno stoccaggio corretto

Importante per commercio e officina: il cuscinetto del giunto d'azionamento viscoso dovrebbe essere possibilmente sempre rivolto verso l'alto. Se il giunto d'azionamento viene conservato in un'altra posizione per un lungo periodo, sussiste il pericolo che l'olio viscoso penetri attraverso l'interspazio di lavoro del giunto d'azionamento viscoso nel cuscinetto a sfera e danneggi il grasso del cuscinetto a sfera, provocando così una riduzione della durata di utilizzo.

CAUSA NON DIPENDENTE DAL GIUNTO D'AZIONAMENTO PER VENTILATORE

CAUSA	EFFETTO	RIMEDIO
Il ventilatore è sporco.	Insufficiente raffreddamento dell'acqua. Nel bi-metallo del giunto d'azionamento viscoso viene immessa una quantità insufficiente d'aria.	Pulire con cautela le lamelle del radiatore/pulirle con aria compressa.
Insufficiente quantità di fluido refrigerante nel sistema di raffreddamento.	La temperatura del motore supera i valori limite ammissibili.	Rifornire una sufficiente quantità di fluido refrigerante.
I tubi del sistema di raffreddamento sono ristretti o piegati.	Mancanza di flusso sufficiente del refrigerante, la temperatura del motore supera i valori limite ammessi.	Controllare l'installazione e la strozzatura dei tubi del refrigerante.
Portata d'aria ridotta del ventilatore per le parti incassate/montate supplementari (fanale supplementare/piastra di copertura supplementare nell'uso invernale davanti al radiatore...)	Raffreddamento del motore insufficiente	Rimuovere le parti incassate/montate o sistemarle in altro modo

CAUSA NEL GIUNTO D'AZIONAMENTO PER VENTILATORE

CAUSA	EFFETTO	RIMEDIO
Il giunto d'azionamento viscoso non è a tenuta.	Fuoriuscita di olio al silicone. La ventola non raggiunge il numero di giri richiesto.	Il giunto d'azionamento viscoso si deve sostituire.
Danneggiamento o manipolazione della spirale di bi-metallo. Supporto del bi-metallo danneggiato/spostato, con conseguente perdita della sua posizione calibrata.	Il ventilatore gira in permanenza troppo velocemente o lentamente, o si accende troppo presto o troppo tardi. È stata variata la corretta regolazione effettuata in fabbrica. La valvola del giunto d'azionamento del ventilatore non è più in grado di regolare correttamente.	È necessario sostituire il giunto d'azionamento viscoso, poiché il corretto punto di comando non può essere regolato in un'officina.
Olio al silicone surriscaldato e di conseguenza consumato. In seguito a questo inconveniente si trasforma in una massa densa che si incolla nella fessura di lavoro.	Il ventilatore gira in permanenza e di conseguenza non può essere girato liberamente in stato fermo. La temperatura del motore non raggiunge la temperatura di esercizio prescritta.	Il giunto d'azionamento viscoso si deve sostituire.
Gioco di ribaltamento eccessivo nel cuscinetto a sfera.	Ambedue i dischi del giunto d'azionamento non presentano un sufficiente gioco reciproco. Le pareti sono in contatto tra di loro e si distruggono da sé. Si verifica una usura del metallo. L'olio al silicone si condensa e intasa il foro per il riflusso del fluido.	Il giunto d'azionamento viscoso si deve sostituire. Attenzione: prima di montare un nuovo giunto d'azionamento viscoso, chiarire/eliminare la causa del guasto del vecchio giunto d'azionamento viscoso (ad es. squilibrio dovuto a palette della ventola rotta, collegamento flangiato ai circuiti, squilibrio adattatore flangia).
Peso di bilanciamento mancante sulla ventola	Rumori e vibrazioni sulla ventola, elevata usura del cuscinetto	Sostituire la ventola o equilibrare la ventola

CAUSA NELLA ZONA CIRCOSTANTE ALLA VENTILAZIONE ELETTRICA

CAUSA	EFFETTO	RIMEDIO
Motore elettrico difettoso	Il ventilatore non gira	Sostituire il ventilatore o il motore elettrico
Resistenza elettrica difettosa	Uno o più livelli del numero di giri sono senza funzione	Sostituire l'unità di resistenza elettrica
Centralina di controllo elettronica difettosa	I diversi livelli del numero di giri sono senza funzione o il ventilatore gira in permanenza	Sostituire la centralina di controllo elettronica
Fusibile per il sistema del ventilatore/di raffreddamento elettrico fulminato	Il ventilatore elettrico non gira	Controllare l'assorbimento di corrente del motore elettrico o sostituirlo
Interruttore di temperatura nel circuito del ventilatore difettoso	Il ventilatore non gira, nessun segnale dell'interruttore di temperatura	Sostituire l'interruttore di temperatura

Большое количество различных электрических вентиляторов, муфт вентиляторов, крыльчаток вентиляторов и комплектов муфт вентиляторов для легковых автомобилей, легких грузовых автомобилей, грузовых автомобилей и сельскохозяйственных транспортных средств предлагает фирменный ассортимент Original BorgWarner, который доступен для автомастерских через системы BERU. Огромная программа вентиляторов постоянно расширяется.

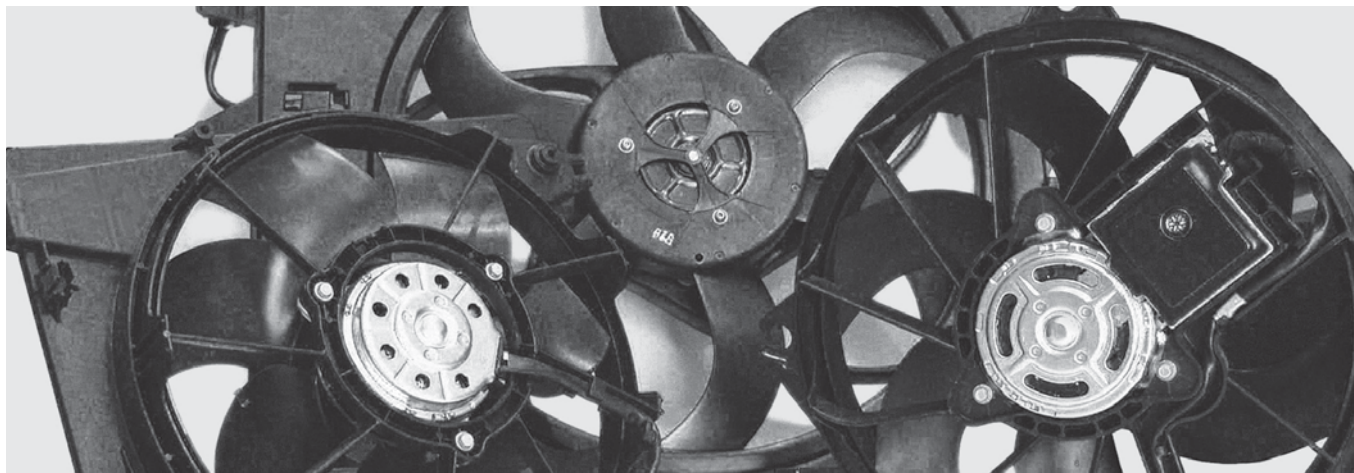

Электрические вентиляторы в комплектном наборе, для классических видов применения легковых автомобилей с низкими требованиями охлаждения.

Муфты Visco – большой спектр

мощности Мощность муфт Visco изменяется согласно соответствующему виду применения автомобиля от 3 кВт (напр., для Mercedes-Benz Sprinter) до 50 кВт (напр., для Mercedes-Benz Actros). Из-за необходимых высоких мощностей охлаждения в грузовых автомобилях муфты Visco обычно применяются на автомобилях с продольно установленным двигателем, как, напр., на грузовых автомобилях с опрокидывающимся кузовом, бетономешалках, автомобилях-тягачах или междугородных автобусах.



Муфты Visco



Муфта вентилятора Visctronic®

Электрические вентиляторы для более низких классов мощности

Эти топливозономные, малолитражные и необслуживаемые вентиляторы качества OE распространяются на классические виды применения легковых автомобилей с поперечно встроенным двигателем, напр., Audi, Opel, Hyundai, Fiat, Mercedes-Benz и Renault.

Вначале электрические вентиляторы для легковых автомобилей поставляются как предварительно смонтированный комплектный набор из двигателя вентилятора с крыльчаткой и корпуса вентилятора, для возможности замены вентилятора несколькими ручными приемами. В будущем также отдельные компоненты, как, напр., корпус вентилятора и двигатели вентилятора, будут включаться в ассортимент фирмы BERU

Муфта вентилятора Visctronic®: точное дозирование свежего воздуха

Муфты вентилятора Visctronic® являются технической новинкой. Они запускаются электронным образом устройством управления двигателем и позволяют иметь изменяемую скорость вращения вентилятора в зависимости от фактически необходимого количества охлажденного воздуха. Это экономит топливо и обеспечивает то, что двигатель и такие дополнительные агрегаты, как маслоохладитель, промежуточный охладитель, тормоз-замедлитель или конденсатор кондиционера, в любой дорожной ситуации получают оптимальное охлаждение.

Выход из строя – причины и способы устранения

Самыми частыми причинами необходимости замены вентилятора являются повреждение от внешнего источника (напр., авария), загрязнения и также недостаточного техобслуживания или ненадлежащего хранения. Здесь приводится краткий обзор причин, которые могут привести к неисправности вентилятора, различаются по зависимым и независимым от вентилятора причинам. Наш совет: Если нельзя распознать видимые повреждения на муфте, сначала проверить независимые причины.

Решающий фактор: правильное хранение

Важно для торговых предприятий и автомастерских: Подшипник муфты Visco должен по возможности всегда быть направлен вверх. Если муфта длительное время хранится иным образом, существует опасность проникновения масла Visco через рабочее пространство муфты Visco в шарикоподшипник и неблагоприятного воздействия там на консистентную смазку подшипника, что, в свою очередь, может привести к сокращению срока службы.

ПРИЧИНА, НЕЗАВИСИМАЯ ОТ МУФТЫ ВЕНТИЛЯТОРА		
ПРИЧИНА	РЕЗУЛЬТАТ	УСТРАНЕНИЕ
Охладитель загрязнен.	Недостаточное охлаждение охлаждающей воды. Тем самым слишком мало подогретого воздуха попадает на биметалл муфты Visco.	Осторожно прочистить/продуть сжатым воздухом пластины охладителя.
Система охлаждения получает слишком мало охлаждающей жидкости.	Температура двигателя превышает допустимые предельные значения.	Дополнить достаточное количество охлаждающей жидкости.
Шланги для системы охлаждения пережаты или согнуты.	Отсутствие достаточного потока хладагента, температура двигателя превышает допустимые предельные значения.	Проверить шланги для охлаждающей жидкости на правильность прокладки или пережимы.
Уменьшенный из-за дополнительных монтажных/навесных деталей проход воздуха в охладителе (дополнительные фары/дополнительная защитная крышка перед охладителем двигателя в зимний период эксплуатации ...)	отсутствие достаточного охлаждения двигателя	Снять монтажные и навесные детали или разместить в другом месте

ПРИЧИНА В МУФТЕ ВЕНТИЛЯТОРА		
ПРИЧИНА	РЕЗУЛЬТАТ	УСТРАНЕНИЕ
Муфта Visco негерметична.	Вытекло силиконовое масло. Не достигается необходимая частота вращения вентилятора.	Необходимо заменить муфту Visco.
Была повреждена или обработана биметаллическая спираль. Держатель биметалла поврежден/разрегулирован, так что он утратил свою откалиброванную позицию.	Вентилятор вращается слишком быстро или слишком медленно, или переключается слишком поздно или слишком рано. Правильная заводская настройка была разрегулирована. Клапан в муфте вентилятора больше нельзя правильно регулировать.	Необходимо заменить муфту Visco, так как в автомастерской невозможно настроить правильную точку переключения.
Силиконовое масло было перегрето и уварилось. Тем самым оно преобразуется в вязкую массу и склеивает рабочий зазор.	Вентилятор вращается постоянно и не может вращаться свободно в состоянии покоя. Температура двигателя не достигает предписанной рабочей температуры.	Необходимо заменить муфту Visco.
Зазор опрокидывания в шарикоподшипнике слишком большой.	Оба диска муфты больше не имеют достаточного зазора относительно друг друга. Стенки касаются друг друга и сами разрушаются. Это приводит к износу металла. Силиконовое масло загустевает и засоряет отверстие для возвратного потока жидкой среды.	Необходимо заменить муфту Visco. Внимание: Перед монтажом новой муфты Visco необходимо выяснить/устранить причину выхода из строя старой муфты Visco (напр., дисбаланс от разбитой лопасти вентилятора, концентричные вращения фланцевого соединения, дисбаланс прифланцованного переходника).
Противовес отсутствует на крыльчатке вентилятора	Шумы и вибрации на крыльчатке вентилятора, высокий износ подшипника	Заменить крыльчатку вентилятора или отбалансировать крыльчатку вентилятора

ПРИЧИНА В ОКРУЖАЮЩЕЙ СРЕДЕ ЭЛЕКТРИЧЕСКОГО ВЕНТИЛЯТОРА		
ПРИЧИНА	РЕЗУЛЬТАТ	УСТРАНЕНИЕ
Электродвигатель неисправный	Вентилятор не вращается	Заменить вентилятор или электродвигатель
Электрическое сопротивление неисправно	одна или несколько ступеней частоты вращения не работают	Заменить электрический резисторный блок
Электронный блок управления неисправный	различные ступени частоты вращения не работают или вентилятор постоянно вращается	Заменить электронный блок управления
Предохранитель для электрического вентилятора/системы охлаждения сгорел	Электрический вентилятор не вращается	Проверить потребление тока электродвигателя или заменить электродвигатель
Температурный выключатель в контуре охладителя неисправный	Вентилятор не вращается, так как отсутствует сигнал от температурного выключателя	Заменить температурный выключатель

Cały szereg różnych wentylatorów elektrycznych, sprzęgieł wentylatorów, wirników wentylatorów i zestawów sprzęgieł wentylatorów do samochodów osobowych, lekkich samochodów ciężarowych, pojazdów użytkowych i pojazdów rolniczych oferuje oryginalny asortyment marki BorgWarner, dostępny dla warsztatów poprzez system BERU. Program produkcyjny wentylatorów jest nieprzerwanie rozbudowywany.

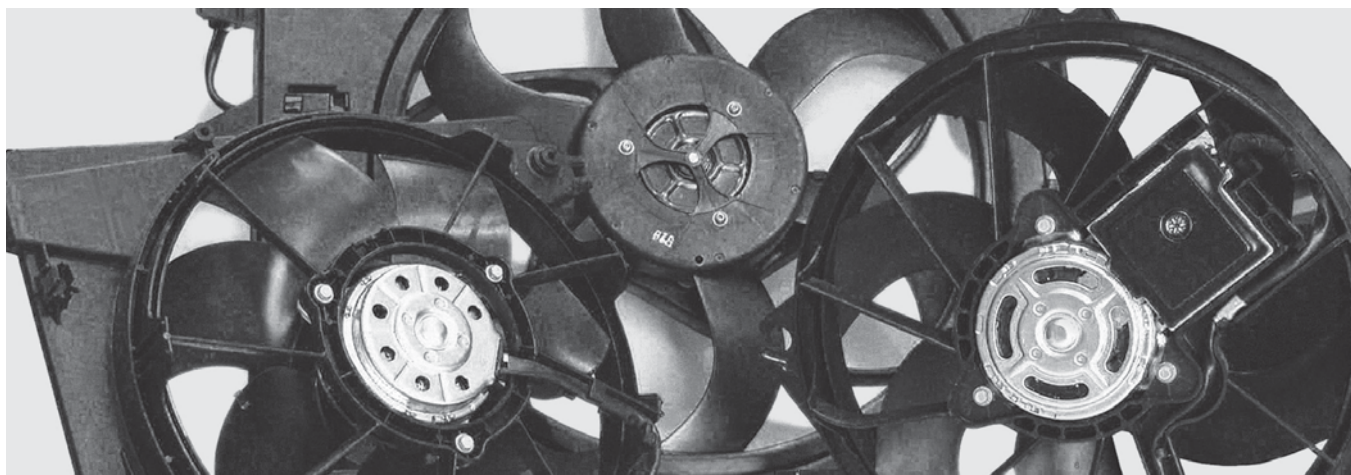

Elektryczne wentylatory w kompletnych zestawach, do klasycznych zastosowań w samochodach osobowych z niewielkim zapotrzebowaniem na chłodzenie.

Sprzęgła wiskotyczne – duże spektrum mocy

Moc sprzęgieł wiskotycznych waha się zależnie od zastosowania pojazdu od 3 kW (np. przy samochodzie Mercedes-Benz Sprinter) do 50 kW (np. Mercedes-Benz Actros). Ze względu na konieczną przy pojazdach użytkowych dużą moc chłodzącą sprzęgła wiskotyczne w tych pojazdach, np. w wywrotkach, betoniarkach, holownikach czy autokarach są montowane przy wzdłużnie montowanych silnikach.



Sprzęgła wiskotyczne



Sprzęgło wentylatora Visctronic®

Elektryczne wentylatory niższej klasy mocy

Te oszczędzające paliwo, ciche i bezobsługowe wentylatory o jakości rynku pierwotnego pokrywają klasyczne zapotrzebowania samochodów osobowych z poprzecznie montowanymi silnikami, np. Audi, Opel, Hyundai, Fiat, Mercedes-Benz i Renault.

Na razie elektryczne wentylatory do samochodów osobowych dostępne są jako wstępnie zmontowane, kompletne zestawy składające się z silnika wentylatora z kołem oraz obudową wentylatora, służące do wymiany wentylatora w zaledwie kilku ruchach. W przyszłości w asortymencie BERU znajdą się również poszczególne komponenty, takie jak obudowy wentylatorów czy silniki wentylatorów

Sprzęgło wentylatora Visctronic®: dokładne dozowanie świeżego powietrza

Najnowocześniejszą technikę reprezentują sprzęgła wentylatorów Visctronic®. Są one sterowane elektronicznie przez sterownik silnika i pozwalają na zmienną prędkość wentylatora zależnie od koniecznej aktualnie ilości chłodzącego powietrza. Pozwala to oszczędzać paliwo i gwarantuje, że silnik oraz agregaty pomocnicze, takie jak chłodnica powietrza doładowującego, retarder i kondensator klimatyzacji mają w każdej sytuacji optymalne chłodzenie.

Awaria – Przyczyny i pomoc

Najczęstszą przyczyną konieczności wymiany wentylatora są uszkodzenia spowodowane zewnętrznymi czynnikami (np. wypadek), zabrudzeniem oraz brakiem konserwacji lub nieprawidłowym przechowywaniem. Poniżej krótki przegląd przyczyn, które mogą prowadzić do nieprawidłowego działania wentylatora, podzielone na przyczyny zależne i niezależne od wentylatora. Nasza wskazówka: Jeśli nie stwierdza się wyraźnych uszkodzeń sprzęgła, należy sprawdzić najpierw przyczyny niezależne.

Decydujące: właściwe ułożyskowanie

Ważne dla handlu i warsztatów: Łożysko sprzęgła wiskotycznego powinno zawsze jeśli to możliwe być skierowane do góry. Jeśli sprzęgło jest składowane przez dłuższy czas w innej pozycji istnieje zagrożenie, że olej wiskotyczny przedostanie się poprzez przestrzeń roboczą sprzęgła wiskotycznego do łożyska kulkowego i tam uszkodzi smar łożyskowy, co z kolei doprowadzi do skrócenia jego trwałości.

PRZYCZYNA NIEZALEŻNA OD SPRĘGŁA WENTYLATORA		
PRZYCZYNA	SKUTEK	POMOC
Chłodnica jest zabrudzona.	Niewystarczające chłodzenie wody chłodzącej. Powoduje to, że do bimetalu sprzęgła wiskotycznego dociera za mało ogrzane powietrze.	Ostrożnie oczyścić lamele chłodzące/ przedmuchać sprężonym powietrzem.
System chłodzący otrzymuje zbyt mało płynu chłodzącego.	Temperatura silnika przekracza dopuszczalne wartości graniczne.	Uzupełnić płyn chłodzący.
Przewężone lub załamane węże systemu chłodzenia.	Niewystarczający przepływ środka chłodzącego, temperatura silnika przekracza dopuszczalną wartość graniczną.	Sprawdzić ułożenie (przewężenia) węży płynu chłodzącego.
Ograniczony przelot powietrza przez chłodnicę z powodu wmontowanych/ dołączonych dodatkowo części (dodatkowe reflektory/ dodatkowe osłony na chłodnicę podczas zimy ...)	Niewystarczające chłodzenie silnika	Usunąć wmontowane/ dołączone części i zamocować inaczej
PRZYCZYNA W SPRĘGŁE WENTYLATORA		
PRZYCZYNA	SKUTEK	POMOC
Sprzęgło wiskotyczne jest nieszczelne.	Wyciekł olej silikonowy. Nie jest osiągnięta konieczna prędkość obrotowa wentylatora.	Konieczna wymiana sprzęgła wiskotycznego.
Uszkodzona lub przestawiona została spirala bimetalowa. Uszkodzony/ przestawiony uchwyt spirali bimetalowej, co spowodowało utratę jej skalibrowanej pozycji.	Wentylator pracuje w sposób ciągły za szybko lub za wolno, albo załącza się zbyt późno lub zbyt wcześnie. Przesławione zostało właściwe, fabryczne ustawienie. Zawór sprzęgła wentylatora nie reguluje już w prawidłowy sposób.	Konieczna wymiana sprzęgła wiskotycznego, ponieważ w warsztacie nie jest możliwe właściwe ustawienie punktu załączania.
Olej silikonowy został przegrzany i jest zużyty. Zmienił się w ciągliwą masę, sklejącą szczelinę roboczą.	Wentylator pracuje w sposób ciągły i nie można nim na postoju swobodnie obrócić. Silnik nie osiąga zalecanej temperatury roboczej.	Konieczna wymiana sprzęgła wiskotycznego.
Luz w łożysku kulkowym jest za duży.	Tarcze sprzęgłowe nie mają już między sobą wystarczającego luzu. Ścianki dotykają się i nie niszczą się wzajemnie. Powstaje metalowy ścier. Olej silikonowy zagęszcza się i zatyka otwór powrotu cieczy.	Konieczna wymiana sprzęgła wiskotycznego. Uwaga: Przed zamontowaniem nowego sprzęgła wiskotycznego należy wyjaśnić/ zlikwidować przyczynę uszkodzenia starego sprzęgła wiskotycznego (np. niewyważenie spowodowane wyłamaniem skrzydła wentylatora, biciem kołnierza, niewyważenie adaptera kołnierza do przykręcania).
Brak ciężarka wyważającego na wirniku wentylatora	Hałasy i wibracje na wirniku wentylatora, duże zużycie łożysk	Wymienić wirnik wentylatora, ewentualnie wyważyć wirnik
PRZYCZYNA W OTOCZENIU ELEKTRYCZNEGO WENTYLATORA		
PRZYCZYNA	SKUTEK	POMOC
Uszkodzony silnik elektryczny	Wentylator nie obraca się	Wymienić wentylator lub silnik elektryczny
Uszkodzony elektryczny opornik	Nie działa jeden lub więcej stopni obrotów	Wymienić elektryczny moduł oporowy
Uszkodzony sterownik elektroniczny	Nie działają różne stopnie prędkości obrotowej lub wentylator obraca się bez przerwy	Wymienić sterownik elektroniczny
Przepalony bezpiecznik elektrycznego wentylatora/ systemu chłodzenia	Elektryczny wentylator nie obraca się	Sprawdzić pobór prądu przez silnik elektryczny, w razie potrzeby wymienić silnik
Wyłącznik termiczny w obwodzie chłodzenia jest uszkodzony	Wentylator nie obraca się, ponieważ brak jest sygnału z wyłącznika termicznego	Wymienić wyłącznik termiczny

Ένα μεγάλο αριθμό διαφόρων ηλεκτρικών ανεμιστήρων, συμπλεκτών ανεμιστήρα, φτερωτών ανεμιστήρα και σετ συμπλέκτη ανεμιστήρων για Ι.Χ., ελαφρά φορτηγά, επαγγελματικά φορτηγά οχήματα και αγροτικά οχήματα προσφέρει η γκάμα γνήσιων προϊόντων BorgWarner, η οποία είναι διαθέσιμη στα συνεργεία μέσω του BERU Systems. Το πλούσιο πρόγραμμα ανεμιστήρων βρίσκεται σε συνεχή επέκταση.

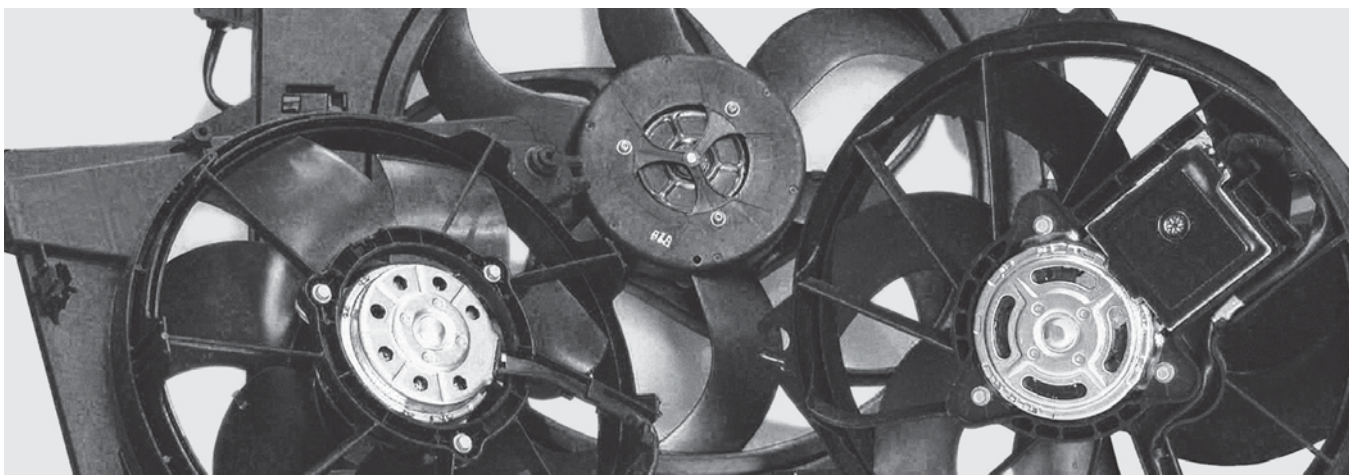

Ηλεκτρικοί ανεμιστήρες σε πλήρες σετ, για κλασικές εφαρμογές σε Ι.Χ. με μικρές ανάγκες ψύξης.

Συμπλέκτες Visco – μεγάλο φάσμα απόδοσης

Η απόδοση των συμπλεκτών Visco ποικίλλει ανάλογα με την εκάστοτε εφαρμογή στο όχημα από 3 kW (π.χ. για Mercedes-Benz Sprinter) έως και 50 kW (π.χ. για Mercedes-Benz Actros). Σε μεγάλα επαγγελματικά οχήματα που απαιτούν υψηλές ψυκτικές αποδόσεις οι συμπλέκτες Visco χρησιμοποιούνται συνήθως σε οχήματα με κινητήρα σε διαμήκη εγκατάσταση, όπως π.χ. σε ανατρεπόμενα, μπετονιέρες, φορτηγά ρυμούλκησης ή λεωφορεία.

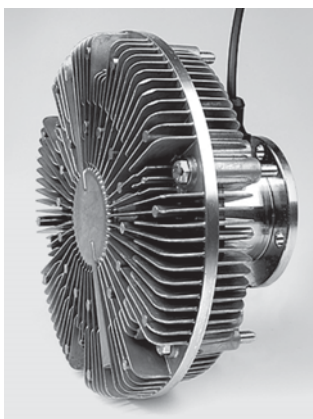

Συμπλέκτες Visco



Συμπλέκτης ανεμιστήρα Visctronic®

Ηλεκτρικοί ανεμιστήρες για χαμηλές κατηγορίες απόδοσης

Αυτοί οι αθόρυβοι και ασυντηρητικοί ανεμιστήρες οικονομικής κατανάλωσης καυσίμου σε ποιότητα αυθεντικών ανταλλακτικών καλύπτουν κλασικές εφαρμογές σε Ι.Χ. με εγκάρσιο κινητήρα, π.χ. Audi, Opel, Hyundai, Fiat, Mercedes-Benz και Renault.

Προς το παρόν οι ηλεκτρικοί ανεμιστήρες για Ι.Χ. είναι διαθέσιμοι ως προσαρμοσμένο πλήρες σετ αποτελούμενο από το μοτέρ με τη φτερωτή και το πλαίσιο του ανεμιστήρα, για αντικατάσταση ανεμιστήρα με λίγες μόνο κινήσεις. Μελλοντικά θα συμπεριληφθούν στη γκάμα προϊόντων BERU και μεμονωμένα εξαρτήματα όπως πλαίσια ανεμιστήρα και μοτέρ ανεμιστήρα

Συμπλέκτης ανεμιστήρα Visctronic®: ακριβής δοσिमέτρηση φρέσκου αέρα

Οι συμπλέκτες ανεμιστήρα Visctronic® είναι ένα τεχνολογικό Highlight. Ελέγχονται ηλεκτρονικά από τη μονάδα ελέγχου του κινητήρα και επιτρέπουν μεταβλητή ταχύτητα ανεμιστήρα ανάλογα με την τρέχουσα απαιτούμενη ποσότητα αέρα ψύξης. Και αυτό σημαίνει οικονομία καυσίμων και διασφαλίζει το γεγονός ότι ο κινητήρας και οι βοηθητικοί μηχανισμοί όπως ψύκτης λαδιού, ενδιάμεσος ψύκτης, φρένο συστήματος επιβράδυνσης ή συμπυκνωτής κλιματιστικού τροφοδοτούνται σε κάθε περίπτωση οδήγησης με την ιδανική ψύξη.

Βλάβη – Αιτίες και Αντιμετώπιση

Οι συχνότερες αιτίες για την αντικατάσταση ενός ανεμιστήρα είναι ζημιές εξαιτίας ξένης επίδρασης (π.χ. ατύχημα), ρύποι όπως επίσης ελλιπής συντήρηση ή ακατάλληλη αποθήκευση. Εδώ μία σύντομη επισκόπηση σχετικά με τις αιτίες, οι οποίες μπορεί να προκαλέσουν δυσλειτουργίες του ανεμιστήρα, και μάλιστα αιτίες εξαρτώμενες και ανεξάρτητες του ανεμιστήρα. Η συμβουλή μας: Εάν δεν υπάρχουν ορατές ζημιές στο συμπλέκτη, ελέγχετε πρώτα τις ανεξάρτητες αιτίες.

Αποφασιστικό: η σωστή αποθήκευση

Σημαντικό για το εμπόριο και τα συνεργεία: Το έδρανο του συμπλέκτη Visco θα πρέπει να δείχνει εφόσον είναι δυνατό πάντα προς τα πάνω. Εάν αποθηκευτεί ο συμπλέκτης για μεγάλο χρονικό διάστημα διαφορετικά, υπάρχει ο κίνδυνος να διεισδύσει το λάδι Visco μέσω του χώρου εργασίας του συμπλέκτη Visco στο ένσφαιρο έδρανο και να προσβάλλει εκεί το λιπαντικό του ένσφαιρου εδράνου, πράγμα το οποίο ενδέχεται να μειώσει τη διάρκεια ζωής.

ΑΙΤΙΑ ΑΝΕΞΑΡΤΗΤΗ ΑΠΟ ΤΟ ΣΥΜΠΛΕΚΤΗ ΑΝΕΜΙΣΤΗΡΑ		
ΑΙΤΙΑ	AUSWIRKUNG	ABHILFE
Ψυγείο είναι λερωμένο.	Ανεπαρκής ψύξη του νερού ψύξης. Εξαιτίας αυτού εισέρχεται ελάχιστος θερμός αέρας στο διμεταλλικό του συμπλέκτη Visco.	Καθαρίζετε προσεκτικά ελάσματα ανεμιστήρα/ φύσημα με πεπιεσμένο αέρα.
Σύστημα ψύξης περιέχει ελάχιστο ψυκτικό υγρό.	Θερμοκρασία κινητήρα υπερβαίνει τις επιτρεπτές οριακές τιμές.	Συμπληρώνετε επαρκές ψυκτικό υγρό.
Λάστιχα συστήματος ψύξης είναι κουλουριασμένα ή λυγισμένα.	Δεν υπάρχει επαρκής ροή ψυκτικού υγρού, θερμοκρασία κινητήρα υπερβαίνει τις επιτρεπτές οριακές τιμές.	Ελέγχετε λάστιχα ψυκτικού υγρού σχετικά με κουλούριασμα ή στένωση.
Εξαιτίας πρόσθετων εξαρτημάτων μειωμένη ροή μάζας αέρα του ψυγείου (πρόσθετοι προβολείς/ πρόσθετη πλάκα κάλυψης το χειμώνα μπροστά από το ψυγείο κινητήρα ...)	Δεν υπάρχει επαρκής ψύξη κινητήρα	Απομακρύνετε ή μεταποτίζετε πρόσθετα εξαρτήματα

ΑΙΤΙΑ ΣΤΟ ΣΥΜΠΛΕΚΤΗ ΑΝΕΜΙΣΤΗΡΑ		
ΑΙΤΙΑ	AUSWIRKUNG	ABHILFE
Συμπλέκτης Visco δεν είναι στεγανός.	Έγινε διαρροή λαδιού σιλικόνης. Δεν επιτυγχάνεται ο απαραίτητος αριθμός στροφών ανεμιστήρα.	Συμπλέκτης Visco πρέπει να ανανεωθεί.
Διμεταλλικό σπирάλ έχει βλάβη ή παραποϊήθηκε. Στήριγμα διμεταλλικού σπирάλ έχει βλάβη/ απορυθμίστηκε, έτσι ώστε έχασε τη βαθμονομημένη θέση του.	Ανεμιστήρας λειτουργεί συνεχώς πολύ γρήγορα ή πολύ αργά, ή ενεργοποιείται πολύ αργά ή πολύ νωρίς. Έγινε αλλαγή της σωστής εργοστασιακής ρύθμισης. Βαλβίδα στο συμπλέκτη ανεμιστήρα δεν μπορεί πλέον να ρυθμίσει σωστά.	Συμπλέκτης Visco πρέπει να ανανεωθεί, διότι δεν είναι εφικτή η σωστή ρύθμιση του σημείου αλλαγής στο συνεργείο.
Λάδι σιλικόνης υπερθερμάνθηκε και έβρασε. Εξαιτίας αυτού μετετρέπεται σε γλοιώδη μάζα και κολλάει την εγκοπή εργασίας.	Ο ανεμιστήρας λειτουργεί συνεχώς και δεν μπορεί να περιστραφεί ελεύθερα σε θέση ακινησίας. Η θερμοκρασία κινητήρα δεν επιτυγχάνει την προδιαγεγραμμένη θερμοκρασία λειτουργίας.	Συμπλέκτης Visco πρέπει να ανανεωθεί.
Το διάκενο ανατροπής στο ένσφαιρο έδρανο είναι πολύ μεγάλο.	Και οι δύο δίσκοι συμπλέκτη δεν έχουν πλέον επαρκές διάκενο μεταξύ τους. Τα τοιχώματα εφάπτονται και αυτοκαταστρέφονται. Γίνεται τριβή μετάλλων. Λάδι σιλικόνης παχύρευστο και βουλώνει τη διάτρηση για την επιστροφή του υγρού.	Συμπλέκτης Visco πρέπει να ανανεωθεί. Προσοχή: Πριν από την εγκατάσταση του νέου συμπλέκτη Visco πρέπει να εντοπιστεί/ απομακρυνθεί η αιτία βλάβης του παλιού συμπλέκτη Visco (π.χ. σφάλμα ζυγοστάθμισης εξαιτίας σπασμένου φύλλου φτερωτής, κανονική λειτουργία σύνδεσης φλάντζας, σφάλμα ζυγοστάθμισης προσαρμογέα φλάντζας).
Λείπει αντισταθμιστικό βάρος στη φτερωτή	Θόρυβοι και δονήσεις στη φτερωτή, υψηλή φθορά εδράνου	Αντικαταστήστε φτερωτή ή προσβείτε σε εξισορρόπηση φτερωτής.

ΑΙΤΙΑ ΣΤΟ ΠΕΡΙΒΑΛΛΟΝ ΤΟΥ ΗΛΕΚΤΡΙΚΟΥ ΑΕΡΙΣΜΟΥ		
ΑΙΤΙΑ	ΑΠΟΤΕΛΕΣΜΑ	ΑΝΤΙΜΕΤΩΠΙΣΗ
Ηλεκτρικό μοτέρ με βλάβη	Ανεμιστήρας δεν περιστρέφεται	Αντικαταστήστε ανεμιστήρα ή ανανεώστε ηλεκτρικό μοτέρ
Ηλεκτρική αντίσταση με βλάβη	Μία ή περισσότερες βαθμίδες αριθμού στροφών χωρίς λειτουργία	Ανανεώστε ηλεκτρική μονάδα αντίστασης
Ηλεκτρονική μονάδα ελέγχου με βλάβη	Οι διάφορες βαθμίδες αριθμού στροφών είναι χωρίς λειτουργία ή ανεμιστήρας περιστρέφεται συνεχώς	Ανανεώστε ηλεκτρονική μονάδα ελέγχου
Ασφάλεια ηλεκτρικού ανεμιστήρα/συστήματος ψύξης έχει καεί	Ηλεκτρικός ανεμιστήρας δεν περιστρέφεται	Ελέγχετε ρεύμα εισόδου του ηλεκτρικού μοτέρ ή ανανεώστε ηλεκτρικό μοτέρ
Διακόπτης θερμοκρασίας στο κύκλωμα ψύξης με βλάβη	Ανεμιστήρας δεν περιστρέφεται, διότι δεν υπάρχει σήμα από το διακόπτη θερμοκρασίας	Ανανεώστε διακόπτη θερμοκρασίας

Különböző elektromos ventilátorok, ventilátorkuplungok, ventilátorkerekek és ventilátorkuplung-készletek sokaságát kínálja személygépkocsikhoz, könnyű tehergépkocsikhoz, haszonjárművekhez és mezőgazdasági járművekhez az eredeti BorgWarner márkasorozat, amelyhez a műhelyek a BERU Systems cégen keresztül juthatnak hozzá. A terjedelmes ventilátorprogram folyamatosan bővül.

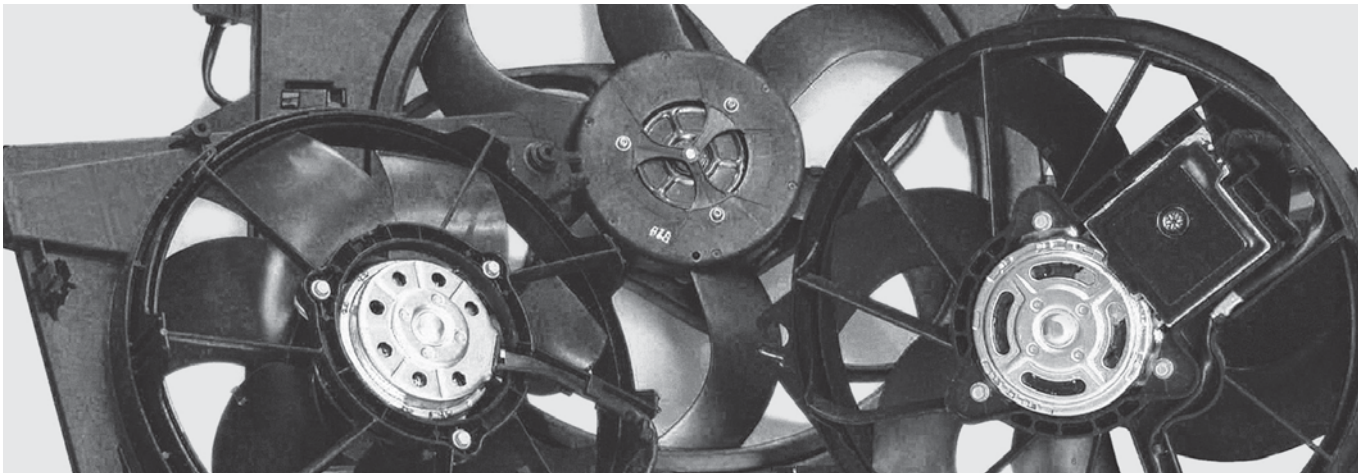

Elektromos ventilátorok komplett készletben klasszikus személygépkocsis alkalmazásokhoz, kis hűtési igényvel.

Viszkokuplungok – széles teljesítményspektrum.

A viszkokuplungok teljesítménye a mindenkori járműalkalmazásoknak megfelelően 3 kW-tól (pl. Mercedes-Benz Sprinter autóhoz) 50 kW-ig (pl. Mercedes-Benz Actros) terjed. A nagy haszonjárműveknél szükséges jelentős hűtőteljesítmények miatt a viszkokuplungokat általában hosszmotoros járműveknél használják, mint pl. billencsek, betonkeverők, vontató tehergépkocsik vagy turistabuszok.

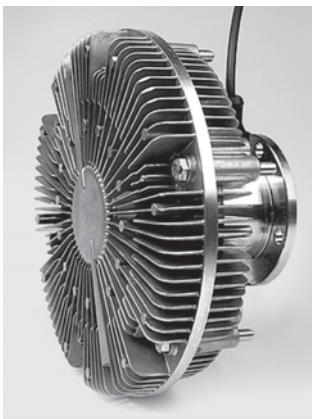

Viszkokuplungok



Visctronic® ventilátorkuplung

Elektromos ventilátorok alacsonyabb teljesítményosztályokhoz

Ezek az üzemanyag-takarékos, halk és karbantartást nem igénylő, gyári beszállítói minőségű ventilátorok a klasszikus, keresztmotoros személygépkocsikhoz készülnek, mint pl. Audi, Opel, Hyundai, Fiat, Mercedes-Benz és Renault.

Egyelőre ventilátormotorból, kerékből és ventilátorházból álló, előszerelt komplett készletként kaphatók a személygépkocsikhoz való elektromos ventilátorok, hogy csak néhány kézmozdulatra legyen szükség a ventilátor cseréjéhez. A jövőben egyedi alkatrészek is bekerülnek majd a BERU választékába, például ventilátorházak és ventilátormotorok

Visctronic® ventilátorkuplung: pontosan adagolt friss levegő

Fontos műszaki újdonságot jelentenek a Visctronic® ventilátorkuplungok. Ezeket a motor vezérlőegysége vezérli elektronikusan, és a hűtőlevegő mindenkor szükséges mennyiségétől függően változó ventilátorsebességeket tesznek lehetővé. Ezzel üzemanyag takarítható meg, és biztosítható, hogy a motor és a kiegészítő egységek, mint az olajhűtő, a töltőlevegő-hűtő, a retarderfék vagy a klímalecsapató minden menethelyzetben optimális hűtést kapjon.

Meghibásodás – okok és megoldás

A ventilátor cseréjét többnyire külső behatások miatti károsodás (pl. baleset), elszennyeződés, valamint helytelen karbantartás vagy szakszerűtlen tárolás teszi szükségessé. Következzen egy rövid áttekintés azokról az okokról, amelyek a ventilátor hibás működését okozhatják, különbséget téve a ventilátortól függő és az attól független okok között. Javaslatunk: Ha nincsenek látható károk a kuplungon, akkor először vizsgáljuk meg a ventilátortól független okokat.

Döntő fontosságú: a helyes tárolás.

Kereskedők és műhelyek számára fontos: A viszkokuplung csapágyának lehetőség szerint mindig felfelé kell állnia. Ha hosszabb időn keresztül fordítva tárolja a kuplungot, akkor fennáll annak a veszélye, hogy a viszkoolaj a viszkokuplung munkaterén keresztül bejut a golyócsapágyba, és ott károsítja a golyócsapágy zsírlját, ami az élettartam csökkenését okozhatja.

VENTILÁTORUKPLUNGÓL FÜGGETLEN OK		
OK	HATÁS	MEGOLDÁS
Elszennyeződött a hűtő.	A hűtővíz nem kielégítő hűtése. Emiatt túl kevés felmelegített levegő jut a viszkokuplung bimetáljához.	Óvatosan tisztítsa meg a hűtőlamellákat/ fűvassa őket tisztára sűrített levegővel.
Túl kevés a hűtőfolyadék a hűtőrendszerben.	A motor hőmérséklete túllépi a megengedett határértékeket.	Töltsön után elegendő hűtőfolyadékot.
Beszűkültek vagy megtörtek a hűtőrendszer tömlői.	Nem kielégítő a hűtőfolyadék áramlása, a motor hőmérséklete túllépi a megengedett határértékeket.	Ellenőrizni kell a hűtőrendszer tömlőinek vezetését, ill. beszűkülését.
Kiegészítésként be-/ráépített alkatrészek miatt lecsökkent a hűtő levegőátbocsátása (kiegészítő fényszórók, téltre felszerelt terelőlemez a hűtő előtt stb.)	Nem kielégítő a motor hűtése	Távolítsa el a be-/rászerelt alkatrészeket vagy szerelje fel őket másképp

VENTILÁTORUKPLUNGÓL FÜGGŐ OK		
OK	HATÁS	MEGOLDÁS
Szivárog a viszkokuplung.	Kifolyt a szilikonolaj. A ventilátor nem éri el a szükséges fordulatszámot.	Ki kell cserélni a viszkokuplungot.
Károsodott vagy manipulálták a bimetál spirált. Megsérült/elállítódott a bimetál tartója, ezért elvesztette a kalibrált pozícióját.	A ventilátor állandóan túl gyorsan vagy túl lassan forog, túl későn vagy túl korán kapcsol be. Elállítódott a helyes gyári beállítás. A ventilátorkuplungban lévő szelep nem tud megfelelően szabályozni.	Ki kell cserélni a viszkokuplungot, mert a műhelyben nem állítható be a helyes kapcsolási pont.
Túlhevült és megfőtt a szilikonolaj. Ezért sűrű masszává változott, és eltömíti a munkarést.	Folyamatosan forog a ventilátor, és álló helyzetben nem lehet szabadon forgatni. A motor hőmérséklete nem éri el az előírt üzemi hőmérsékletet.	Ki kell cserélni a viszkokuplungot.
Túl nagy a dőlési holtjáték a golyócsapágyban.	A két kuplungtárcsának nincs már megfelelő holtjátéka egymáshoz képest. Érintkeznek és tönkreteszik magukat az elválasztó falak. Kopik a fém. Besűrűsödik a szilikonolaj, és eltömíti a folyadék visszafolyójának furatát.	Ki kell cserélni a viszkokuplungot. Figyelem: Új viszkokuplung beszerelése előtt tisztázni kell, és meg kell szüntetni a régi viszkokuplung meghibásodásának az okát (pl. kiegyensúlyozatlanság letört ventilátorlapát miatt, a felfogatás körkörös forgása, felfogató adapter kiegyensúlyozatlansága).
Hiányzik egy kiegyensúlyozó súly a ventilátorkeréken	Zajok és rezgések a ventilátorkeréknél, a csapágyak jelentős kopása	Cserélje ki, ill. egyensúlyozza ki a ventilátorkeréket

AZ ELEKTROMOS VENTILÁTOROK KÖRNYEZETÉTŐL FÜGGŐ OK		
OK	HATÁS	MEGOLDÁS
Meghibásodott a villanymotor	Nem forog a ventilátor	Cserélje ki a ventilátort, ill. a villanymotort
Meghibásodott az elektromos ellenállás	Egy vagy több fordulatszám-fokozat nem működik	Cserélje ki az elektromos ellenállás egységet
Meghibásodott az elektronikus vezérlőegység	A különböző fordulatszám-fokozatok nem működnek, ill. folyamatosan forog a ventilátor	Cserélje ki az elektronikus vezérlőegységet
Kiolvadt az elektromos ventilátor-/hűtőrendszer biztosítóka	Nem forog az elektromos ventilátor	Ellenőrizze a villanymotor áramfelvételét, ill. cserélje ki a villanymotort
Meghibásodott a hűtőrendszerben található hőmérséklet-kapcsoló	Nem forog a ventilátor, mert nem érkezik jel a hőmérséklet-kapcsolótól	Cserélje ki a hőmérséklet-kapcsolót

O sortimento original BorgWarner disponível nas oficinas através da BERU Systems oferece inúmeros ventiladores eléctricos, acoplamentos de ventilador, rodas de ventilador e kits de acoplamentos de ventilador para veículos ligeiros, camiões ligeiros, veículos utilitários e veículos agrícolas. O abrangente programa de ventiladores sofre ampliações constantes.

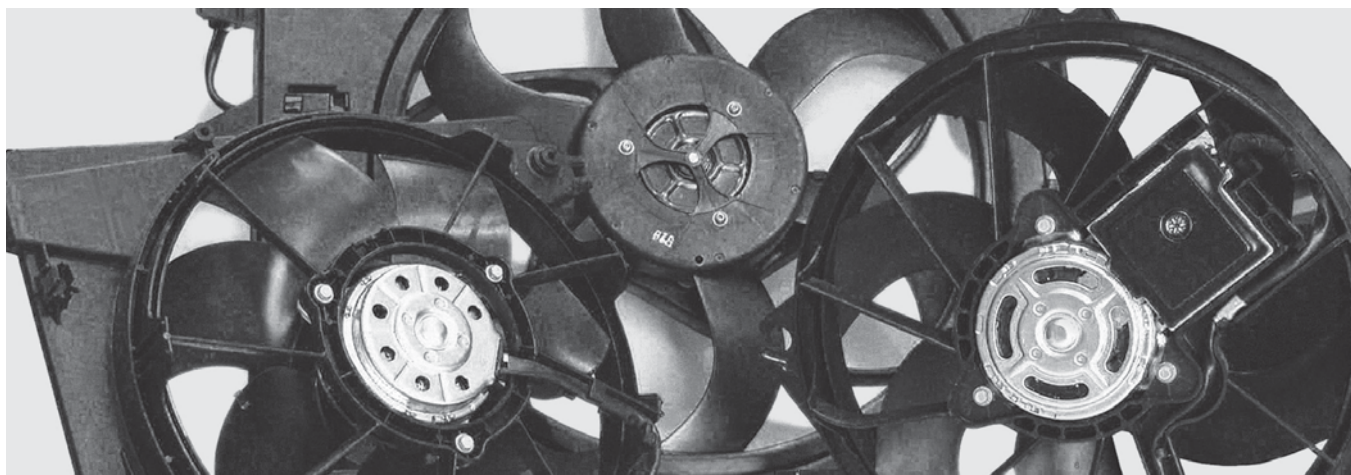

Ventiladores eléctricos em kit completo, para aplicações clássicas de veículos ligeiros com pouca necessidade de arrefecimento.

Acoplamentos viscosos – grande espectro de potência

A potência dos acoplamentos viscosos varia em função da respectiva aplicação no veículo entre 3 kW (p. ex. para Mercedes-Benz Sprinter) e 50 kW (p. ex. para Mercedes-Benz Actros). Devido às elevadas potências de arrefecimento necessárias em veículos utilitários grandes, os acoplamentos viscosos usam-se, normalmente, em veículos com motor longitudinal, como p. ex. em camiões basculantes, betoneiras, camiões de reboque ou autocarros de viagem.



Acoplamentos viscosos



Acoplamento do ventilador Visctronic®

Ventiladores eléctricos para classes de potência mais baixas

Estes ventiladores económicos, silenciosos e isentos de manutenção com qualidade OE cobrem as aplicações clássicas de veículos ligeiros com o motor montado na transversal, p. ex. Audi, Opel, Hyundai, Fiat, Mercedes-Benz e Renault.

Actualmente, os ventiladores eléctricos para veículos ligeiros estão disponíveis sob a forma de um kit completo pré-montado com motor do ventilador com roda e caixa do ventilador, para que a substituição do ventilador se processe com poucas intervenções. Futuramente, o sortimento BERU incluirá também componentes individuais como caixas e motores de ventilador

Acoplamento do ventilador Visctronic®: ar fresco doseado com precisão

Um destaque tecnológico são os acoplamentos de ventilador Visctronic®. São activados electronicamente pelo aparelho de comando do motor e permitem uma velocidade variável do ventilador em função da quantidade de ar frio actualmente necessária. Isso economiza combustível e assegura que o motor e os grupos adicionais, como radiador do óleo, o intercooler, o travão retardador ou o condensador do ar condicionado, conseguem o melhor arrefecimento em qualquer situação de condução.

Falha – causas e solução

Os motivos mais frequentes para a necessidade de substituição de um ventilador são os danos por acção externa (p. ex. acidente), sujidade e manutenção deficiente ou acondicionamento incorrecto. Apresentamos uma breve vista geral sobre as causas que podem provocar o mau funcionamento do ventilador, distinguindo entre as que dependem e as que não dependem do ventilador. A nossa sugestão: se não forem visíveis danos no acoplamento, verificar primeiro as causas que são independentes.

O acondicionamento correcto é decisivo

Importante para comércio e oficinas: tanto quanto possível, o rolamento do acoplamento viscoso tem de apontar sempre para cima. Se o acoplamento for acondicionado de outra forma durante muito tempo, existe o perigo de o óleo viscoso penetrar no rolamento de esferas através da área de trabalho do acoplamento viscoso e atacar a massa lubrificante do rolamento de esferas, o que pode provocar uma redução da vida útil.

CAUSA INDEPENDENTE DO ACOPLAMENTO DO VENTILADOR		
CAUSA	EFEITO	SOLUÇÃO
O radiador está sujo.	Arrefecimento insuficiente da água de refrigeração. Desta forma, entra uma quantidade de ar aquecido insuficiente no bimetálico do acoplamento viscoso.	Limpar cuidadosamente as lamelas do radiador/ soprando com ar comprimido.
O sistema de arrefecimento tem pouco líquido de arrefecimento.	A temperatura do motor ultrapassa os valores-limite permitidos.	Encher com líquido de arrefecimento suficiente.
As mangueiras do sistema de arrefecimento estão estreitadas ou vincadas.	Não há fluxo suficiente de refrigerante, a temperatura do motor ultrapassa os valores-limite permitidos.	Verificar se as mangueiras de refrigerante estão fora do sítio ou estreitadas.
Caudal de ar do radiador reduzido devido a peças de montagem/acrescentos adicionais (faróis adicionais/placa de cobertura adicional na utilização durante o inverno antes do radiador do motor...)	Arrefecimento do motor insuficiente	Remover as peças de montagem/os acrescentos ou colocá-los de outra forma

CAUSA NO ACOPLAMENTO DO VENTILADOR		
CAUSA	EFEITO	SOLUÇÃO
O acoplamento viscoso tem fugas.	O óleo de silicone vazou. O número de rotações do ventilador necessário não foi atingido.	É preciso substituir o acoplamento viscoso.
A espiral em bimetálico foi danificada ou manipulada. O suporte do bimetálico está danificado/deslocado, tendo perdido a sua posição calibrada.	O ventilador funciona permanentemente de forma demasiado rápida ou demasiado lenta ou comuta demasiado tarde ou demasiado cedo. Foi ajustada a definição de fábrica correcta. A válvula no acoplamento do ventilador já não consegue efectuar uma regulação correcta.	O acoplamento viscoso tem de ser substituído, dado que não se consegue regular o ponto de comutação através da oficina.
O óleo de silicone foi sobreaquecido e evaporou-se. Assim, transformou-se numa massa dura e cola a folga de trabalho.	O ventilador funciona permanentemente em concomitância e não pode ser rodado livremente durante a paragem. A temperatura do motor não atinge o valor de serviço prescrito.	É preciso substituir o acoplamento viscoso.
A folga de inclinação no rolamento de esferas é excessiva.	Os dois discos do acoplamento já não têm folga suficiente um em relação ao outro. As paredes tocam-se e destroem-se. Dá-se a abrasão do metal. O óleo de silicone torna-se espesso e obstrui o furo para o retorno do fluido.	É preciso substituir o acoplamento viscoso. Atenção: antes da montagem de um novo acoplamento viscoso, é preciso tratar/eliminar a causa das falhas do acoplamento viscoso antigo (p. ex. desequilíbrio devido à pá do ventilador partida, concentricidades de flangeamento, desequilíbrio do adaptador flangeado).
Falta de contrapeso na roda do ventilador	Ruídos e vibrações na roda do ventilador, elevado desgaste dos rolamentos	Substituir ou equilibrar a roda do ventilador

CAUSA NAS PROXIMIDADES DA VENTILAÇÃO ELÉCTRICA		
CAUSA	EFEITO	SOLUÇÃO
Motor eléctrico com defeito	O ventilador não roda	Substituir o ventilador ou o motor eléctrico
Resistência eléctrica com defeito	Um ou mais níveis de rotação não funcionam	Substituir a unidade de resistência eléctrica
Unidade de comando electrónica com defeito	Os vários níveis de rotação não funcionam ou o ventilador roda permanentemente	Substituir a unidade de comando electrónica
O fusível para o sistema do ventilador eléctrico/ de arrefecimento está queimado	O ventilador eléctrico não roda	Verificar o consumo de corrente do motor eléctrico ou substituir o motor eléctrico
O interruptor da temperatura no circuito do radiador tem defeito	O ventilador não roda por não haver sinal do interruptor da temperatura	Substituir o interruptor da temperatura

BERU Systems üzerinden servislerin erişimine sunulan orijinal BorgWarner marka çeşitleri, binek araçlar, ticari araçlar ve tarımsal araçlar için çok sayıda elektrikli fan, fan kaplinleri, fan çarkları ve fan kaplini kitleri içermektedir. Kapsamlı fan programı sürekli olarak geliştirilmektedir.

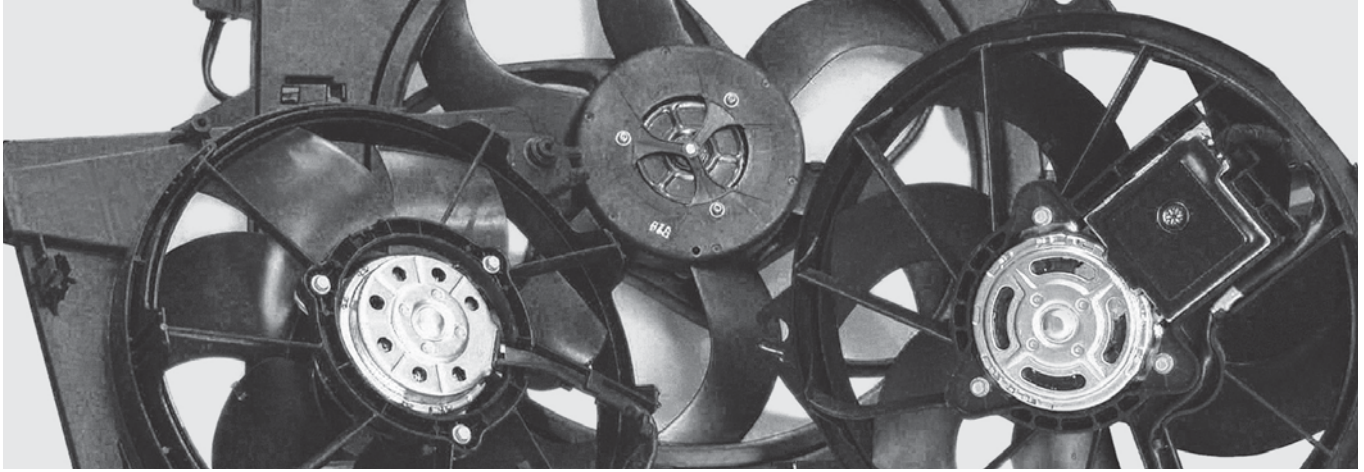

Komple set olarak düşük soğutma ihtiyacı olan binek araç uygulamaları için elektrikli fanlar.

Visco kaplinler - Büyük güç yelpazesi

Visco kaplinlerin gücü, ilgili araç uygulamasına bağlı olarak 3 kW (örn. Mercedes-Benz Sprinter için) ile 50 kW (örn. Mercedes-Benz Actros için) arasında değişir. Büyük ticari araçlarda gerekli olan yüksek soğutma kapasiteleri nedeniyle, Visco kaplinler genelde örn. damperli kamyonlar, beton mikserleri, çekici kamyonlar veya seyahat otobüsleri gibi boylamasına takılmış motora sahip araçlarda kullanılır.



Visco kaplinler



Visctronic® fan kaplini

Düşük güç sınırları için elektrikli fanlar

Yakıt tasarrufu sağlayan, sessiz, bakım gerektirmeyen ve OE kalitesindeki fanlar, örn. Audi, Opel, Hyundai, Fiat, Mercedes-Benz ve Renault marka araçlara enine takılan motorlardaki klasik binek araç uygulamalarını karşılamaktadır.

Binek araç fanları, çarkla birlikte fan motoru ve fan muhafazasından oluşan ve ön montajı yapılmış komple set olarak temin edilebilir; fanın değiştirilmesi için az sayıda el müdahalesi gerekir. Gelecekte, fan muhafazası ve fan motorları gibi münferit bileşenler de BERU çeşitleri arasına katılacak

Visctronic® fan kaplini: Doğru şekilde dozlanan taze hava

Visctronic® fan kaplinleri teknolojik olarak öne çıkan bir üründür. Motor kontrol ünitesi tarafından elektronik olarak devreye sokulurlar ve ihtiyaç duyulan soğutma havası miktarına bağlı olarak değişken fan hızlarına olanak sağlarlar. Bu özellik, yakıt tasarrufu sağlar ve motorun ve yağ soğutucusunun, ara soğutucu, Retarder fren veya klima kondansatörü gibi ek ünitelerin her sürüş durumunda optimum soğutma almalarını garanti eder.

Devre dışı kalma - Nedenleri ve yardım

Bir fanın en sık karşılaşılan değiştirilme ihtiyacı, dış etkiler (örn. kaza), kirlenme ve eksik bakım ya da tekniğe uygun şekilde depolanmamasıdır. Fana bağlı ve fandan bağımsız nedenlere göre ayrılmış şekilde bir fanın hatalı çalışmasına neden olabilecek kısa bir genel bakışı burada bulabilirsiniz. Önerimiz: Kaplinde görülür hasarlar yoksa, önce fandan bağımsız nedenleri kontrol edin.

Belirleyici olan: Doğru depolama

Satış ve servis için önemli olan: Visco kaplininin yatağı mümkün olduğunca her zaman yukarı bakmalıdır. Kaplin uzun süre başka şekilde depolanırsa, Visco yağının Visco kaplindeki çalışma bölmesinden bilyeli rulmana girmesi ve burada bilyeli rulman gresine yapışması tehlikesi oluşur; bunun sonucunda kullanım ömrü kısalabilir.

FAN KAPLININDEN BAĞIMSIZ NEDEN		
NEDEN	ETKİSİ	ÇÖZÜM
Radyatör kirlenmiş.	Soğutma suyunun yetersiz düzeyde soğutulması. Bunun sonucunda, çok az ısınan hava Visco kaplinin bimetel kısmına ulaşır.	Radyatör lamellerini dikkatlice temizleyin/ lamellere basınçlı hava püskürtün.
Soğutma sisteminde çok az soğutma suyu var.	Motor sıcaklığı izin verilen sınır değerleri aşıyor.	Yeterli soğutma suyu ekleyin.
Soğutma sistemi hortumları daralmış veya bükülmüş.	Soğutma suyunun debisi yetersiz, motor sıcaklığı izin verilen sınır değerleri aşıyor.	Soğutma suyu hortumlarını döşeme veya daralma açısından kontrol edin.
Montaj parçalarının eklenmesi nedeniyle radyatörün hava debisi azalmış (ek fan/kış aylarında motor radyatörünün önüne takılan ek koruyucu plaka ...)	Yeterli motor soğutması yok	Montaj parçalarını çıkartın veya başka şekilde takın

FAN KAPLINİNDEKİ NEDEN		
NEDEN	ETKİSİ	ÇÖZÜM
Visco kaplin sızdırıyor.	Silikon yağ boşalmış. Gerekli fan devrine ulaşılmıyor.	Visco kaplin yenilenmelidir.
Bimetel spiral hasar görmüş veya değiştirilmiş. Bimetel tutucusu hasarlı/ayarı değişmiş ve bu nedenle, kalibre edilmiş konumunu kaybetti.	Fan sürekli olarak çok hızlı ya da yavaş çalışıyor veya çok geç ya da erken devreye giriyor. Doğru fabrika ayarı değişmiş. Fan kaplinindeki valf doğru ayar yapamıyor.	Doğru geçiş noktası servis tarafından ayarlanamayacağı için, Visco kaplin yenilenmelidir.
Silikon yağ aşırı ısınmış veya kömürleşmiş. Bunun sonucunda, sert bir kütleye dönüşüyor ve çalışma boşluğuna yapışıyor.	Fan sürekli olarak birlikte çalışıyor ve durma anında serbestçe döndürülemiyor. Motor sıcaklığı öngörülen çalışma sıcaklığına ulaşmıyor.	Visco kaplin yenilenmelidir.
Bilyeli rulmandaki oynama boşluğu çok fazla.	Her iki kaplin balatası birbirine yeterli boşluğa sahip değil. Duvarlar birbirine değişiyor ve kendi kendilerini tahrip ediyor. Metal aşınması oluşuyor. Silikon yağ kalınlaşmış ve akışkan geri akış deliğini tıkkıyor.	Visco kaplin yenilenmelidir. Dikkat: Yeni bir Visco kaplin takılmadan önce, eski Visco kaplinin devre dışı kalma nedeni belirlenmeli/giderilmelidir (örn. kırılmış fan kanadı nedeniyle balans bozukluğu, flanşlama parçasının düzgün çalışması, flanşlama adaptöründe balans bozukluğu).
Fan çarkındaki balans ağırlığı eksik	Fan çarkında ses ve titreşim, rulmanda aşırı aşınma	Fan çarkını değiştirin veya fan çarkının balansını alın

ELEKTRİKLİ HAVALANDIRMA ORTAMINDAKİ NEDEN		
NEDEN	ETKİSİ	ÇÖZÜM
Elektrik motoru arızalı	Fan dönmüyor	Fanı değiştirin veya elektrik motorunu yenileyin
Elektrikli direnç arızalı	Bir ya da birden çok devir kademesi çalışmıyor	Elektrikli direnç ünitesini yenileyin
Elektronik kumanda ünitesi arızalı	Farklı devir kademeleri çalışmıyor veya fan sürekli dönmüyor	Elektronik kumanda ünitesini yenileyin
Elektrikli fan/soğutma sisteminin sigortası yanmış	Elektrikli fan dönmüyor	Elektrik motorunun akım çekişini kontrol edin veya elektrik motorunu yenileyin
Soğutma devir daimindeki sıcaklık şalteri arızalı	Sıcaklık şalterinden sinyal gelmediği için fan dönmüyor	Sıcaklık şalterini yenileyin

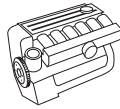
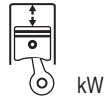

AUDI

A3 Cabriolet										
2.0 TFSI	2.0	147	04.08-	CCZA/CAWB				LE 035	LE 584	LE 584Z
A4 (8D2, B5)										
1.6	1.6	74	01.95-07.00	AHL/ADP/ARM/ANA				LK 001	LE 502	LR 002
1.6	1.6	75	07.00-11.00	ALZ	4)			LK 001	LE 506	LR 002
									LE 583	
								LK 001		LR 002
1.8	1.8	85	04.95-11.00	AFY				LK 001	LE 502	LR 002
1.8	1.8	92	01.95-11.00	AVW/ADR/APT/ARG	4)			LK 001	LE 506	LR 002
									LE 583	
								LK 001		LR 002
1.8 T	1.8	110	01.95-11.00	ARK/AEB/ANB/APU/AWT	4)			LK 001	LE 506	LR 002
									LE 583	
								LK 001		LR 002
1.8 T	1.8	132	12.97-11.00	AJL				LK 001	LE 502	LR 002
1.8 T quattro	1.8	110	01.95-11.00	ARK/AEB/ANB/APU/AWT				LK 001	LE 502	LR 002
1.9 TDI	1.9	55	12.95-11.00	AFF				LK 001	LE 502	LR 002
1.9 TDI	1.9	66	01.95-11.00	1Z/AHU/AHH				LK 001	LE 502	LR 002
1.9 TDI	1.9	81	10.95-11.00	AVG/AFN				LK 001		LR 002
1.9 TDI	1.9	85	03.00-11.00	AJM				LK 001	LE 502	LR 002
1.9 TDI quattro	1.9	85	03.00-11.00	ATJ/AJM	4)			LK 001	LE 506	LR 002
									LE 583	
								LK 001		LR 002
1.9 TDI quattro	1.9	85	03.00-11.00	AJM						LR 002
2.4	2.4	120	08.97-11.00	AMM/APZ/AJG	4)				LE 506	LR 001
									LE 583	
								LK 004		LR 001
2.4	2.4	121	03.97-11.00	AML/ARJ/ALF/AGA/APS	4)				LE 506	LR 001
									LE 583	
								LK 004		LR 001
2.4 quattro	2.4	121	03.97-11.00	AML/ARJ/ALF/AGA/APS				LK 004	LE 502	LR 001
2.4 quattro	2.4	120	08.97-11.00	APZ				LK 004	LE 502	LR 001
								LK 004		LR 001
								LK 004		LR 001
							Chassis 8D-X-200000 →	LK 004		
2.5 TDI	2.5	110	09.97-11.00	AFB/AKN				LK 002	LE 502	LR 001
2.6 quattro	2.6	110	01.95-11.00	ABC				LK 004	LE 502	LR 001
								LK 004		LR 001
							→ Chassis 8D-X-199999	LK 004		LR 001
S4 quattro	2.7	195	09.97-11.00	AGB/AZB				LK 004		LR 001
							Chassis 8D-X-200000 →	LK 004		LR 001
2.8	2.8	128	09.95-07.97	AAH				LK 004	LE 502	LR 001
2.8	2.8	142	10.96-11.00	APR/ACK/ALG/AQD/AMX				LK 004	LE 502	LR 001
								LK 004		LR 001
A4 (8E2, B6)										
1.6	1.6	75	11.00-12.04	ALZ				LE 002		LR 002
1.8 T	1.8	110	11.00-07.02	AVJ				LK 001		LR 002
								LE 002		LR 002



kW

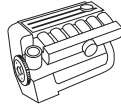

AUDI							
A4 (8E2, B6)							
1.8 T	1.8	120	07.02-12.04	BFB/BKB		LE 002	
1.8 T	1.8	140	11.02-12.04	BEX		LE 002	
1.9 TDI	1.9	74	05.01-12.04	AVB		LK 001	LR 002
1.9 TDI	1.9	96	11.00-12.04	AWX/AVF		LK 001	LR 002
1.9 TDI quattro	1.9	96	11.01-12.04	AVF		LK 001	LR 002
2.0	2.0	96	11.00-12.04	ALT		LE 002	
2.0 FSI	2.0	110	07.02-12.04	AWA		LE 002	
2.4	2.4	120	09.01-12.04	AMM			LE 504
						LK 004	LR 001
A4 Avant (8D5, B5)							
1.6	1.6	74	03.96-07.00	AHL/ADP/ARM/ANA			LE 502
						LK 001	LR 002
1.6	1.6	75	07.00-09.01	ALZ	4)		LE 506
							LE 583
						LK 001	LR 002
1.8	1.8	85	07.95-09.01	AFY			LE 502
						LK 001	LR 002
1.8	1.8	92	02.96-09.01	AVV/ADR/APT/ARG	4)		LE 506
							LE 583
						LK 001	LR 002
1.8 quattro	1.8	85	07.95-09.01	AFY			LE 502
						LK 001	LR 002
1.8 quattro	1.8	92	01.96-09.01	ADR/APT/ARG			LE 502
						LK 001	LR 002
1.8 T	1.8	110	03.96-09.01	ARK/AEB/ANB/APU/AWT	4)		LE 506
							LE 583
						LK 001	LR 002
1.8 T	1.8	110	09.01-07.02	AVJ		LE 002	
1.8 T	1.8	120	07.02-12.04	BFB		LE 002	
1.8 T	1.8	132	12.97-09.01	AJL			LE 502
						LK 001	LR 002
1.8 T	1.8	140	11.02-12.04	BEX		LE 002	
1.8 T quattro	1.8	110	01.96-09.01	ARK/AEB/ANB/APU/AWT			LE 502
						LK 001	LR 002
1.8 T quattro	1.8	132	12.97-09.01	AJL			LE 502
						LK 001	LR 002
1.9 TDI	1.9	55	03.96-09.01	AFF			LE 502
						LK 001	LR 002
1.9 TDI	1.9	66	02.96-09.01	1Z/AHU/AHH			LE 502
						LK 001	
1.9 TDI	1.9	66	02.96-09.01	AHH/AHU			LR 002
1.9 TDI	1.9	81	02.96-09.01	AVG/AFN			LE 502
						LK 001	LR 002
1.9 TDI	1.9	85	03.00-09.01	AJM			LE 502
						LK 001	LR 002
1.9 TDI quattro	1.9	81	09.96-09.01	AVG/AFN			LE 583
						LK 001	LR 002
1.9 TDI quattro	1.9	85	03.00-09.01	ATJ/AJM	4)		LE 506
							LE 583
						LK 001	
1.9 TDI quattro	1.9	85	03.00-09.01	AJM			LR 002
2.4	2.4	120	08.97-09.01	AMM/APZ/AJG	4)		LE 506
							LE 583
						LK 004	LR 001
2.4	2.4	121	03.97-09.01	AML/ARJ/ALF/AGA/APS	4)		LE 506
							LE 583
						LK 004	LR 001

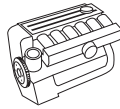
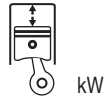

AUDI

A4 Avant (8D5, B5)

2.4 quattro	2.4	120	08.97-09.01	APZ		LK 004	LE 502	LR 001
					Chassis 8D-X-200000 →	LK 004		
2.4 quattro	2.4	121	03.97-09.01	AML/ARJ/ALF/AGA/APS		LK 004	LE 502	LR 001
2.5 TDI	2.5	110	09.97-09.01	AFB/AKN		LK 002	LE 502	
2.5 TDI quattro	2.5	110	09.97-09.01	AFB/AKN		LK 002	LE 502	
2.6	2.6	102	01.96-07.97	ACZ		LK 004	LE 502	
2.6	2.6	110	02.96-09.01	ABC		LK 004	LE 502	LR 001
					→ Chassis 8D-X-199999	LK 004		
2.8	2.8	128	03.96-09.96	AAH		LK 004	LE 502	LR 001
2.8	2.8	142	10.96-09.01	APR/ACK/ALG/AQD/AMX		LK 004	LE 502	LR 001
2.8 quattro	2.8	128	01.96-09.96	AAH		LK 004	LE 502	LR 001
2.8 quattro	2.8	142	10.96-09.01	APR/ACK/ALG/AQD/AMX		LK 004	LE 502	LR 001
RS4 quattro	2.6	280	05.00-09.01	AZR/ASJ		LK 004		LR 001
S4 quattro	2.8	195	09.97-09.01	AGB/AZB	Chassis 8D-X-200000 →	LK 004		

A4 Avant (8E5, B6)

1.6	1.6	75	09.01-12.04	ALZ		LE 002		LR 002
1.8 T quattro	1.8	110	09.01-07.02	AVJ		LE 002		
1.8 T quattro	1.8	120	07.02-12.04	BFB		LE 002		
1.8 T quattro	1.8	140	11.02-12.04	BEX		LE 002		
1.9 TDI	1.9	74	11.01-12.04	AVB		LK 001		LR 002
1.9 TDI	1.9	96	09.01-12.04	AWX/AVF		LK 001		
1.9 TDI	1.9	96	09.01-12.04	AVF				LR 002
1.9 TDI quattro	1.9	96	11.01-12.04	AVF		LK 001		LR 002
2.0	2.0	96	09.01-12.04	ALT		LE 002		
2.0 FSI	2.0	110	07.02-12.04	AWA		LE 002		
2.4	2.4	120	09.01-12.04	AMM			LE 504	

A6 (4A, C4)

1.8	1.8	92	12.95-10.97	ADR		LE 004		
1.8 quattro	1.8	92	12.95-10.97	ADR		LE 004		
						LK 003		
1.9 TDI	1.9	66	06.94-10.97			LE 004		
2.0	2.0	74	06.94-10.97	AAE		LE 004		
2.0	2.0	85	06.94-10.97	ABK		LE 004		
2.0	2.0	79	08.95-07.96	ADW		LE 004		
2.0 16V	2.0	103	06.94-10.97	ACE		LE 004		
2.0 16V quattro	2.0	103	06.94-10.97	ACE		LE 004		
2.3 quattro	2.3	98	06.94-12.95	AAR		LE 006		
2.3	2.3	98	06.94-12.95	AAR		LE 006		
						LK 005		
2.4	2.4	110	07.95-06.96	AFM		LE 004		
2.5 TDI	2.5	84	01.95-10.97	AAT		LE 006		
						LK 005		
2.5 TDI	2.5	85	06.94-10.97	AAT		LE 006		
						LK 005		
2.5 TDI	2.5	103	08.94-10.97	AEL		LE 006		
						LK 005		



kW

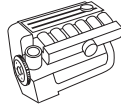

AUDI									
A6 (4A, C4)									
2.6	2.6	102	06.94-10.97	ACZ					LE 004
2.6	2.6	110	06.94-10.97	ABC					LE 004
2.6 quattro	2.6	110	06.94-10.97	ABC					LK 003
2.8	2.8	120	08.95-07.96	AEJ					LE 004
2.8	2.8	128	06.94-10.97	AEJ/AAH/AFC					LE 004
2.8	2.8	142	12.95-10.97	ACK			4)		LE 506
									LK 004
2.8 quattro	2.8	128	06.94-10.97	AEJ/AAH					LK 003
2.8 quattro	2.8	142	12.95-10.97	ACK					LE 004
									LK 004
S6 Plus quattro	4.2	240	04.96-10.97	AHK					LE 006
S6 Turbo quattro	2.2	169	06.94-10.97	AAN					LE 006
									LK 003
A6 (4B, C5)									
1.8	1.8	85	05.97-01.05	AFY					LE 502
									LK 001
									LR 002
1.8	1.8	92	12.01-	ANQ/ARH/AJP/AQE					LE 502
1.8	1.8	92	07.97-01.05	ANQ/ARH/AJP/AQE					LE 503
1.8	1.8	92	07.97-01.05	ARH/AJP/AQE					LK 001
1.8 T	1.8	110	12.01-	ARK/AEB/ANB/APU/AWT					LK 001
									LE 502
1.8 T	1.8	110	01.97-01.05	ARK/AEB/ANB/APU/AWT					LE 503
1.8 T	1.8	132	12.01-	AJL					LE 502
1.8 T	1.8	132	12.97-01.05	AJL					LE 503
									LK 001
1.8 T quattro	1.8	110	12.01-	ARK/AEB/ANB/APU/AWT					LE 502
1.8 T quattro	1.8	110	02.97-01.05	ARK/AEB/ANB/APU/AWT					LE 503
									LK 001
									LR 002
1.8 T quattro	1.8	132	12.01-	AJL					LE 502
1.8 T quattro	1.8	132	12.97-01.05	AJL					LE 503
									LK 001
									LR 002
1.9 TDI	1.9	81	04.97-10.00	AVG/AFN					LE 502
1.9 TDI	1.9	81	04.97-10.00	AFN					LK 001
1.9 TDI	1.9	85	07.00-01.05	AJM					LE 503
									LK 001
									LR 002
1.9 TDI	1.9	96	08.01-01.05	AWX/AVF					LE 503
									LK 001
									LR 002
2.0	2.0	96	08.01-01.05	ALT					LE 002
2.4	2.4	100	07.98-01.05	ARN/ASM/ALW					LE 503
2.4	2.4	100	12.01-	ARN/ASM/ALW					LE 502
2.4	2.4	115	12.01-	APC					LE 502
2.4	2.4	115	02.97-01.05	APC					LE 583
2.4	2.4	120	12.01-	AMM/APZ/AJG					LE 502
2.4	2.4	120	02.97-01.05	AMM/APZ/AJG					LE 503
									LK 004
2.4	2.4	121	12.01-	AML/ARJ/ALF/AGA/APS					LE 502
2.4	2.4	121	02.97-01.05	AML/ARJ/ALF/AGA/APS					LE 503
									LK 004
2.4	2.4	125	08.01-01.05	BDV					LE 503
									LK 004
2.4 quattro	2.4	115	08.98-07.99	APC					LE 502
2.4 quattro	2.4	120	12.01-	APZ/AJG					LE 502
2.4 quattro	2.4	120	02.97-01.05	APZ/AJG					LE 503
									LK 004
2.5 TDI	2.5	110	12.01-	AFB/AKN					LE 502
2.5 TDI	2.5	110	07.97-01.05	AFB/AKN					LE 503
									LK 002
2.5 TDI	2.5	114	08.01-01.05	AYM					LE 503
									LK 002

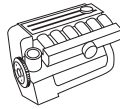
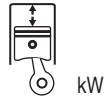

AUDI

A6 (4B, C5)

2.5 TDI	2.5	120	07.02-01.05	BCZ/BDG/BFC	LK 002	LE 503	
2.5 TDI	2.5	132	12.01-	BAU/AKE/BND/BDH		LE 502	
2.5 TDI	2.5	132	02.00-01.05	BAU/AKE/BND/BDH		LE 503	
2.5 TDI	2.5	132	02.00-01.05	BAU/AKE/BDH	LK 002		
2.5 TDI quattro	2.5	110	12.01-	AFB/AKN		LE 502	
2.5 TDI quattro	2.5	110	07.97-01.05	AFB/AKN	LK 002	LE 503	
2.5 TDI quattro	2.5	132	12.01-	BAU/AKE/BDH		LE 502	
2.5 TDI quattro	2.5	132	02.00-01.05	BAU/AKE/BDH	LK 002	LE 503	
2.7 T	2.7	169	12.01-	AJK		LE 501	
2.7 T	2.7	169	02.99-01.05	AJK	LK 004	LE 583	
2.7 T quattro	2.7	169	12.01-	AJK		LE 501	
2.7 T quattro	2.7	169	12.97-01.05	AJK	LK 004	LE 583	
2.7 T quattro	2.7	184	08.01-01.05	BES/ARE		LE 505	
2.8	2.8	132	10.97-07.98	AGE	LK 001	LE 502	
2.8	2.8	140	12.01-	BBG/ATX		LE 502	
2.8	2.8	140	07.99-01.05	BBG/ATX		LE 503	
2.8	2.8	140	07.99-01.05	ATX	LK 001		
2.8	2.8	142	12.01-	APR/ACK/ALG/AQD/AMX		LE 502	
2.8	2.8	142	02.97-01.05	APR/ACK/ALG/AQD/AMX	LK 004	LE 503	LR 001
2.8 quattro	2.8	132	01.98-04.00	AGE		LE 502	
2.8 quattro	2.8	140	07.99-05.01	ATX		LE 583	
2.8 quattro	2.8	142	12.01-	APR/ACK/ALG/AQD/AMX		LE 502	
2.8 quattro	2.8	142	02.97-01.05	APR/ACK/ALG/AQD/AMX	LK 004	LE 503	LR 001
3.0	3.0	162	08.01-01.05	ASN		LE 503	
4.2 quattro	4.2	220	11.98-01.05	ARS/ASG	LK 003		
S6 quattro	4.2	250	09.99-01.05	AQJ/ANK	LK 003		
A6 Avant (4A, C4)							
1.8	1.8	92	12.95-12.97	ADR	LE 004		
1.8 quattro	1.8	92	12.95-12.97	ADR	LE 004		
1.9 TDI	1.9	66	06.94-12.97	1Z/AHU	LK 003		
2.0	2.0	74	06.94-12.97	AAE	LE 004		
2.0	2.0	79	08.95-07.96	ADW	LE 004		
2.0	2.0	85	06.94-12.97	ABK	LE 004		
2.0 16V	2.0	103	06.94-12.97	ACE	LE 004		
2.0 16V quattro	2.0	103	06.94-12.97	ACE	LE 004		
2.3	2.3	98	06.94-12.95	AAR	LE 006		
2.3 quattro	2.3	98	06.94-12.95	AAR	LK 005		
2.3 quattro	2.3	98	06.94-12.95	AAR	LE 006		
2.4	2.4	110	07.96-12.97	AFM	LK 003		
2.5 TDI	2.5	84	01.95-12.97	AAT	LE 004		
2.5 TDI	2.5	85	06.94-12.97	AAT	LK 005		
2.5 TDI	2.5	85	06.94-12.97	AAT	LE 006		
2.5 TDI	2.5	103	08.94-12.97	AEL	LK 005		
2.5 TDI	2.5	103	08.94-12.97	AEL	LE 006		
2.5 TDI quattro	2.5	103	07.95-12.97	AEL	LK 005		
2.5 TDI quattro	2.5	103	07.95-12.97	AEL	LE 006		
2.6	2.6	102	06.94-02.97	ACZ	LK 005		
2.6	2.6	110	06.94-12.97	ABC	LE 004		



kW

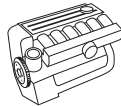

AUDI									
A6 Avant (4A, C4)									
2.6 quattro	2.6	110	06.94-12.97	ABC					LE 004 LK 003
2.8	2.8	120	08.95-07.96	AEJ					LE 004
2.8	2.8	128	06.94-12.97	AEJ/AAH					LE 004
2.8 quattro	2.8	128	06.94-12.97	AEJ/AAH					LE 004 LK 003
2.8	2.8	142	12.95-12.97	ACK			4)		LE 506 LK 004
2.8 quattro	2.8	142	12.95-12.97	ACK					LE 004 LK 004
S6 Turbo quattro	2.2	169	06.94-12.97	AAN					LE 006 LK 003
S6 4.2 quattro	4.2	213	06.94-12.97	AEC					LE 006
S6 Plus quattro	4.2	240	04.96-12.97	AHK					LE 006
A6 Avant (4B, C5)									
1.8	1.8	85	12.01-	AFY					LE 502
1.8	1.8	85	02.98-01.05	AFY				LK 001	LR 002
1.8	1.8	92	12.01-	ARH/AJP/AQE					LE 502
1.8	1.8	92	12.97-01.05	ARH/AJP/AQE					LE 503
1.8 T	1.8	110	12.01-	ARK/AEB/ANB/APU/AWT				LK 001	LR 002
1.8 T	1.8	110	12.97-01.05	ARK/AEB/ANB/APU/AWT					LE 502 LE 503
1.8 T	1.8	132	12.01-	AJL				LK 001	LR 002
1.8 T	1.8	132	04.99-01.05	AJL					LE 502 LE 503
1.9 TDI	1.9	81	02.98-04.01	AFN					LK 001 LE 502
1.9 TDI	1.9	85	07.00-01.05	AJM					LK 001 LE 503
1.9 TDI	1.9	96	08.01-01.05	AWX/AVF					LK 001 LE 503
2.0	2.0	96	08.01-01.05	ALT					LK 001 LE 502
2.4	2.4	100	12.01-	ARN/ASM/ALW					LE 502
2.4	2.4	100	07.98-01.05	ARN/ASM/ALW					LE 503
2.4	2.4	115	12.01-	APC					LE 502
2.4	2.4	115	12.97-01.05	APC					LE 503
2.4	2.4	120	12.01-	AMM/APZ/AJG					LE 502
2.4	2.4	120	12.97-01.05	AMM/APZ/AJG					LE 503
2.4	2.4	121	12.01-	AML/ARJ/ALF/AGA/APS				LK 004	LE 502
2.4	2.4	121	12.97-01.05	AML/ARJ/ALF/AGA/APS					LE 503
2.4	2.4	125	08.01-01.05	BDV					LK 004 LE 503
2.4 quattro	2.4	115	08.98-05.01	APC					LK 004 LE 502
2.4 quattro	2.4	120	12.01-	APZ/AJG					LE 502
2.4 quattro	2.4	120	12.97-01.05	APZ/AJG					LE 503
2.5 TDI	2.5	110	12.01-	AFB/AKN					LK 004 LE 502
2.5 TDI	2.5	110	12.97-01.05	AFB/AKN					LE 503
2.5 TDI	2.5	114	08.01-01.05	AYM					LK 002 LE 503
2.5 TDI	2.5	120	07.02-01.05	BCZ/BDG/BFC					LK 002 LE 503
2.5 TDI	2.5	132	12.01-	BAU/AKE/BDH					LK 002 LE 502
2.5 TDI	2.5	132	02.00-01.05	BAU/AKE/BDH					LE 503
2.7 T	2.7	169	12.01-	AJK					LK 002 LE 501

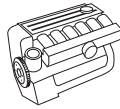
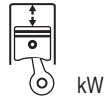

AUDI

A6 Avant (4B, C5)

2.7 T	2.7	169	02.99-01.05	AJK			LE 583	
						LK 004		
2.7 T quattro	2.7	169	12.01-	AJK/AZA			LE 501	
2.7 T quattro	2.7	169	12.97-01.05	AJK/AZA			LE 583	
2.7 T quattro	2.7	169	12.97-12.01	AJK		LK 004		
2.7 T quattro	2.7	184	08.01-01.05	BES/ARE			LE 505	
2.8	2.8	132	12.97-07.98	AGE			LE 502	
						LK 001		
2.8	2.8	140	12.01-	ATX			LE 502	
2.8	2.8	140	07.99-01.05	ATX			LE 583	
						LK 001		
2.8	2.8	142	12.01-	APR/ACK/ALG/AQD/AMX			LE 502	
2.8	2.8	142	12.97-01.05	APR/ACK/ALG/AQD/AMX			LE 503	
						LK 004		LR 001
2.8 quattro	2.8	142	12.01-	APR/ACK/ALG/AQD/AMX			LE 502	
2.8 quattro	2.8	142	12.97-01.05	APR/ACK/ALG/AQD/AMX			LE 503	
						LK 004		LR 001
3.0	3.0	162	08.01-01.05	ASN			LE 503	
4.2 quattro	4.2	220	11.98-01.05	ARS/ASG		LK 003		
S6 quattro	4.2	250	09.99-01.05	AQJ/ANK		LK 003		
A8 (4D2, 4D8)								
2.5 TDI	2.5	110	01.97-04.00	AFB/AKN			LE 502	
2.5 TDI	2.5	132	09.00-09.02	AKE			LE 502	
2.5 TDI quattro	2.5	110	07.97-04.00	AFB/AKN			LE 502	
2.5 TDI quattro	2.5	132	09.00-09.02	AKE			LE 502	
2.8	2.8	120	07.95-03.96	AEJ			LE 502	
						LK 004		
					Chassis F4D-S-004301 →	LK 004		LR 001
2.8	2.8	128	03.94-03.96	AAH			LE 502	
					→ Chassis 4D-X-004999	LK 004		
					Chassis F4D-S-004301 →	LK 004		LR 001
2.8	2.8	142	04.96-09.02	APR/ACK/ALG/AQD/AMX			LE 502	
2.8	2.8	142	04.96-09.02	APR/AQD/AMX		LK 004		
					Chassis F4D-S-004301 →	LK 004		LR 001
2.8 quattro	2.8	120	07.95-03.96	AEJ			LE 502	
						LK 004		
					Chassis F4D-S-004301 →	LK 004		LR 001
2.8 quattro	2.8	128	03.94-03.96	AAH			LE 502	
						LK 004		
					Chassis F4D-S-004301 →	LK 004		LR 001
2.8 quattro	2.8	142	04.96-09.02	APR/ACK/AQD/AMX			LE 502	
2.8 quattro	2.8	142	04.96-09.02	APR/AQD/AMX		LK 004		
					Chassis F4D-S-004301 →	LK 004		LR 001
3.3 TDI quattro	3.3	165	06.00-09.02	AKF			LE 502	
3.7	3.7	169	07.95-12.98	AEW			LE 502	
						LK 003		
3.7	3.7	191	11.98-09.02	AKC/AQG			LE 502	
						LK 003		
3.7 quattro	3.7	169	07.95-11.98	AKJ/AEW			LE 502	
3.7 quattro	3.7	169	07.95-11.98	AEW		LK 003		
3.7 quattro	3.7	191	11.98-09.02	AKC/AQG			LE 502	
						LK 003		



kW

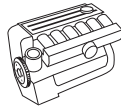

AUDI							
A8 (4D2, 4D8)							
4.2 quattro	4.2	175	02.99-04.00	ARU		LK 003	LE 502
4.2 quattro	4.2	180	03.94-07.96	AEM			LE 502
4.2 quattro	4.2	210	07.95-09.98	AGH			LE 502
4.2 quattro	4.2	220	03.94-11.98	AKG/ABZ			LE 502
4.2 quattro	4.2	228	11.98-09.02	AUW/AQF/AUX			LE 502
4.2 quattro	4.2	228	11.98-09.02	AQF/AUW		LK 003	
S 8 quattro	4.2	250	07.96-06.99	AHC/AKH			LE 502
S 8 quattro	4.2	265	06.99-09.02	AQH/AVP			LE 502
						LK 003	
6.0 W12 quattro	6.0	309	01.01-09.02	AZC			LE 502
ALLROAD (4BH)							
2.5 TDI quattro	2.5	132	05.00-08.05	BAU/AKE			LE 505
2.7 T quattro	2.7	184	05.00-08.05	BES/ARE			LE 505
CABRIOLET (8G7, B4)							
1.8	1.8	92	01.97-08.00	ADR		LK 001	
1.9 TDI	1.9	66	06.95-08.00	1Z/AHU		LE 004	
						LK 001	
2.0 E	2.0	85	01.93-07.98	ABK		LE 004	
2.0 16V	2.0	103	06.95-07.96	ACE		LE 004	
2.3 E	2.3	98	05.91-07.94	NG		LE 008	
2.6	2.6	102	05.95-08.00	ACZ		LE 004	
2.6	2.6	110	06.93-08.00	ABC		LE 004	
						LK 001	
2.8	2.8	128	11.92-08.00	AAH		LE 004	
						LK 001	
COUPE (81, 85)							
1.6	1.6	55	07.80-08.81	YN		LE 001	
1.8	1.8	55	08.81-07.83	DD		LE 001	
					2)	LE 007	
1.8 GT	1.8	65	04.86-10.88	SF		LE 001	
					2)	LE 007	
1.8 GT	1.8	66	09.82-10.88	DS/JV		LE 001	
					2)	LE 007	
1.8 GT	1.8	79	08.86-10.87	PV		LE 001	
					2)	LE 007	
1.8 GT	1.8	82	08.86-10.88	DZ		LE 001	
					2)	LE 007	
1.8 GT quattro	1.8	66	09.85-10.88	DS/NE/JN		LE 001	
					2)	LE 007	
1.8 GT quattro	1.8	82	12.84-10.88	DZ		LE 001	
					2)	LE 007	
1.9	1.9	85	08.80-07.83	WN		LE 001	
2.0	2.0	85	09.83-07.86	JS/HP		LE 001	
2.1 GT	2.1	96	09.82-08.84	KE/KL		LE 001	
2.2 quattro	2.2	100	10.84-10.88	KV		LE 001	
2.2 GT	2.2	100	09.84-10.88	KV/HY		LE 001	
COUPE (89, 8B)							
2.0 16 V	2.0	101	01.92-07.92	6A		LE 004	
2.0 16 V	2.0	103	08.92-12.96	ACE		LE 004	
2.3	2.3	98	03.90-12.96	NG		LE 008	
2.3	2.3	100	10.88-07.94	NG		LE 008	
2.3 quattro	2.3	98	05.90-12.96	NG		LE 008	
2.3 quattro	2.3	100	11.88-12.92	NG		LE 008	
2.6	2.6	110	08.92-12.96	ABC		LE 004	
2.6 quattro	2.6	110	08.92-12.96	ABC		LE 004	
2.8	2.8	128	09.91-12.96	AAH		LE 004	
2.8 quattro	2.8	128	08.91-12.96	AAH		LE 004	
S2 quattro	2.2	169	10.92-12.96	ABY		LE 008	

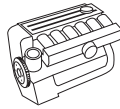
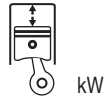

AUDI

TT (8N3)

1.8 T	1.8	110	09.02-06.06	AUM	2)	LE 003
1.8 T	1.8	120	09.05-06.06	BVP	2)	LE 003
1.8 T	1.8	132	10.98-06.06	AWP/AJQ/APP/ARY/AUQ/ATC	2)	LE 003
1.8 T	1.8	140	09.05-06.06	BVR	2)	LE 003
1.8 T quattro	1.8	132	10.98-06.06	AWP/AJQ/ARY/ATC	2)	LE 003
1.8 T quattro	1.8	140	09.05-06.06	BVR	2)	LE 003
1.8 T quattro	1.8	165	10.98-06.06	BAM/APX/AMU	2)	LE 003
1.8 T quattro	1.8	176	03.05-06.06	BFV	2)	LE 003
3.2 VR6 quattro	3.2	184	07.03-06.06	BPF/BHE	2)	LE 003

TT Roadster (8N9)

1.8 T	1.8	110	01.01-06.06	AUM	2)	LE 003
1.8 T	1.8	120	09.05-06.06	BVP	2)	LE 003
1.8 T	1.8	132	10.99-06.06	AWP/AJQ/APP/AUQ/ATC	2)	LE 003
1.8 T	1.8	140	09.05-06.06	BVR	2)	LE 003
1.8 T quattro	1.8	132	02.00-06.06	AWP/AJQ/ARY/ATC	2)	LE 003
1.8 T quattro	1.8	140	09.05-06.06	BVR	2)	LE 003
1.8 T quattro	1.8	165	10.99-06.06	BAM/APX/AMU	2)	LE 003
3.2 VR6 quattro	3.2	184	07.03-06.06	BPF/BHE	2)	LE 003

50

0.8	0.8	25	01.76-07.78	HE		LE 001
1.1	1.1	37	08.74-07.78	HB		LE 001
1.1	1.1	44	08.74-07.77	HC		LE 001
					2)	LE 007
1.3	1.3	43	01.77-07.78	HJ		LE 001
1.3	1.3	44	08.77-07.78	HH		LE 001
					2)	LE 007

80, Avant

1.3	1.3	40	05.72-07.78	ZA	2)	LE 007
1.3	1.3	40	09.78-07.81	FY		LE 001
					2)	LE 007
1.3	1.3	44	05.72-07.78	ZF	2)	LE 007
1.3	1.3	44	09.78-07.81	FZ		LE 001
					2)	LE 007
1.3	1.3	44	09.78-07.86	EP		LE 001
					2)	LE 007
1.4	1.4	48	08.86-07.88	SE		LE 001
1.5	1.5	55	05.72-08.75	ZB/YJ	2)	LE 007
1.5	1.5	63	05.72-07.76	ZC	2)	LE 007
1.6 D	1.6	40	09.86-08.91	JK	2)	LE 007
1.6	1.6	51	08.78-07.81	YT/YY		LE 001
1.6	1.6	51	08.87-09.91	PP		LE 001
					2)	LE 007
1.6	1.6	52	09.91-12.94	ABM	2)	LE 007
1.6	1.6	54	02.86-07.86	SA		LE 001
					2)	LE 007
1.6	1.6	55	09.75-07.78	YN	2)	LE 007
1.6	1.6	55	08.78-07.86	DT		LE 001
					2)	LE 007
1.6	1.6	55	08.78-07.86	WV/YN		LE 001
					2)	LE 007
1.6	1.6	55	09.86-08.91	RN		LE 001
					2)	LE 007
1.6 TD	1.6	59	09.86-08.91	RA/SB	2)	LE 007
1.6	1.6	63	09.75-07.78	YP	2)	LE 007
1.6	1.6	63	08.78-02.83	YP		LE 001
					2)	LE 007
1.6 GT	1.6	74	09.73-07.76	XX	2)	LE 007
1.6	1.6	75	08.90-10.91	ABB		LE 001
1.6 GTE	1.6	81	01.76-07.78	YS	2)	LE 007



kW

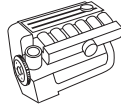

AUDI						
80, Avant						
1.6 GLE	1.6	81	01.79-12.86	YZ		LE 001
					2)	LE 007
1.8	1.8	55	10.86-01.90	RU		LE 001
1.8	1.8	65	02.86-07.86	SF		LE 001
					2)	LE 007
1.8 S	1.8	65	09.86-12.90	SF		LE 001
					2)	LE 007
1.8	1.8	66	01.83-08.86	DS		LE 001
					2)	LE 007
1.8 CC quattro (85Q)	1.8	66	08.84-08.86	NE/JV		LE 001
					2)	LE 007
1.8 S	1.8	66	09.86-10.91	NE/PM/JN		LE 001
1.8	1.8	68	08.83-08.86	JN		LE 001
					2)	LE 007
1.8 GTE	1.8	81	08.85-07.86	PV		LE 001
					2)	LE 007
1.8 GTE	1.8	82	10.84-08.86	DZ		LE 001
1.8 E	1.8	82	06.86-08.91	DZ		LE 001
					2)	LE 007
1.8	1.8	83	09.86-07.88	SD		LE 001
1.9 TD	1.9	55	09.91-12.94	AAZ		LE 004
1.9 TDI	1.9	66	09.91-12.94	1Z		LE 004
1.9 TDI	1.9	66	07.92-01.96	1Z		LE 004
2.0	2.0	66	09.91-12.94	ABT		LE 004
					2)	LE 007
2.0	2.0	66	07.92-01.96	ABT		LE 004
2.0	2.0	85	10.83-09.84	JS/HP		LE 001
2.0 quattro (85Q)	2.0	85	10.83-09.84	JS		LE 001
2.0 E	2.0	85	09.91-12.94	ABK		LE 004
2.0 E quattro	2.0	85	09.91-12.94	ABK		LE 004
2.0 E	2.0	85	07.92-01.96	ABK		LE 004
2.0 E 16V	2.0	101	03.90-09.91	6A		LE 004
2.0 E 16V	2.0	103	08.92-12.94	ACE		LE 004
2.0 E 16V	2.0	103	02.93-01.96	ACE		LE 004
2.2 S2 quattro	2.2	169	02.93-12.94	ABY		LE 008
2.3 E	2.3	98	09.91-12.94	NG		LE 008
2.3 E	2.3	98	07.92-01.96	NG		LE 008
2.6	2.6	110	07.92-12.94	ABC		LE 004
2.6	2.6	110	07.92-01.96	ABC		LE 004
2.8	2.8	128	09.91-12.94	AAH		LE 004
						LE 004
2.8	2.8	128	09.91-01.96	AAH		LE 004
90						
2.0 quattro	2.0	101	08.89-07.90	6A		LE 001
2.3 E	2.3	98	04.87-09.91	NG		LE 008
2.3 E	2.3	100	04.87-07.91	NG		LE 008
2.3 E 20V	2.3	123	04.90-07.91	7A		LE 008
2.3 E 20V	2.3	125	08.88-07.91	7A		LE 008
100						
1.6	1.6	63	08.76-07.82	YV		LE 001
					2)	LE 007
1.6	1.6	63	07.77-02.83	YV		LE 001
					2)	LE 007
1.8	1.8	55	08.82-12.84	RS/DR		LE 001
1.8	1.8	55	08.82-12.87	RS/DR	2)	LE 007
1.8	1.8	65	02.86-07.88	SH	2)	LE 007
1.8	1.8	65	02.86-07.90	SH	2)	LE 007
1.8	1.8	66	08.83-07.89	JW /NP/DS	2)	LE 007
1.8 KAT	1.8	66	03.85-11.90	PH/4B	2)	LE 007

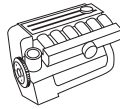
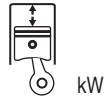

AUDI

100

2.0 D	2.0	51	08.82-07.88	CN		LE 008
2.0 D	2.0	51	03.83-11.90	CN		LE 008
2.0 D Turbo	2.0	64	08.82-02.88	DE		LE 008
2.0 TD	2.0	64	03.83-10.87	DE		LE 008
2.0 TD	2.0	74	03.88-11.90	NC		LE 008
2.0 D Turbo	2.0	74	03.88-11.90	NC		LE 008
2.0	2.0	74	12.90-06.94	AAE		LE 004
2.0 E	2.0	74	09.91-06.94	AAE		LE 004
2.0	2.0	83	08.86-11.87	SL		LE 008
2.0	2.0	85	06.76-08.78	WA	2)	LE 007
2.0	2.0	85	08.77-07.80	WA	2)	LE 007
						LE 001
2.0	2.0	85	08.84-12.87	KP		LE 008
2.0 E	2.0	85	01.85-12.87	KP		LE 008
2.0 KAT	2.0	85	01.88-11.90	RT		LE 008
2.0 E KAT	2.0	85	01.88-11.90	RT		LE 008
2.0 E	2.0	85	12.90-06.94	ABK/AAD		LE 004
2.0 E quattro	2.0	85	12.90-07.92	AAD		LE 004
2.0 E	2.0	85	09.91-06.94	ABK/AAD		LE 004
2.0 E 16V	2.0	103	01.92-06.94	ACE		LE 004
2.2	2.2	85	10.84-09.86	KZ		LE 008
2.2	2.2	101	08.84-12.88	KU		LE 008
2.2 KAT	2.2	101	06.89-11.90	KU/HX		LE 008
2.2 Turbo	2.2	121	08.86-11.90	MC		LE 008
2.3 E	2.3	98	12.90-06.94	AAR		LE 006
						LK 005
2.3 E	2.3	98	09.91-06.94	AAR		LE 006
						LK 005
						LE 004
2.3	2.3	100	08.86-11.90	NF		LE 008
2.3 E	2.3	100	10.86-11.90	NF		LE 008
2.4 D	2.4	60	08.89-07.91	3D		LE 008
2.4 D	2.4	60	08.89-11.90	3D		LE 008
2.4 D	2.4	60	12.90-06.94	AAS		LE 006
						LK 005
2.5 TDI	2.5	85	12.90-12.92	AAT/ABP		LK 005
2.5 TDI	2.5	85	12.90-06.94	AAT/ABP		LE 006
2.5 TDI	2.5	88	01.90-11.90	1T		LE 008
2.6	2.6	102	07.93-06.94	ACZ		LE 004
2.6	2.6	110	03.92-06.94	ABC		LE 004
2.8 E	2.8	128	12.90-06.94	AAH		LE 004
						LK 005
2.8 E	2.8	128	09.91-06.94	AAH		LE 004
						LK 005
S4 Turbo quattro	2.2	169	08.91-06.94	AAN		LE 006
						LK 005
200						
2.1 5 E	2.1	100	08.83-07.84	WC		LE 008
2.1 Turbo	2.1	134	08.83-01.88	KG		LE 008
2.2	2.2	101	08.84-07.85	KU		LE 008
2.2 Turbo	2.2	121	08.85-09.91	MC		LE 008
2.2 Turbo	2.2	140	02.88-12.90	2B		LE 008
2.2 Turbo	2.2	147	02.88-12.90	1B		LE 008
2.1 Turbo quattro	2.1	134	09.83-01.88	KG		LE 008
2.2 Turbo quattro	2.2	147	02.88-12.91	1B		LE 008



kW

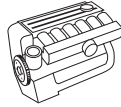

BMW							
3 (E21)							
320	2.0	80	08.75-08.77	M 10 B 20		LK 012	
323 i	2.3	105	01.78-08.82	M 20 B 23		LK 012	
3 (E30)							
320 i	2.0	92	09.82-12.85	M 20 B 20		LK 012	
320 i	2.0	95	12.85-06.91	M 20 B 20		LK 012	
320 i	2.0	110	12.85-06.90			LK 012	
323 i	2.3	102	09.82-08.83	M 20 B 23		LK 012	
323 i	2.3	110	09.83-08.86	M 20 B 23		LK 012	
324 d	2.4	63	09.85-08.91	M 21 D 24 W		LK 007	
324 td	2.4	85	09.87-08.91	M 21 D 24/M 21 D 24 WA		LK 007	
325 e 2.7	2.7	90	10.83-12.88	M 20 B 27		LK 012	
325 e 2.7	2.7	95	01.85-08.87	M 20 B 27		LK 012	
325 i	2.5	125	12.86-06.91	M 20 B 25		LK 012	
325 i	2.5	126	09.83-11.89	M 20 B 25		LK 012	
325 i X	2.5	126	03.86-12.87	M 20 B 25		LK 012	
3 (E36)							
316 i	1.6	73	09.90-09.93	M 40 B 16 (Kat.)			LE 508
316 i	1.6	75	07.93-07.96	M 43 B 16			LE 508
316 i	1.6	75	09.90-09.93	M 43 B 16/M 40 B 16			LE 508
318 i	1.8	83	12.90-10.93	M 40 B 18			LE 508
318 i	1.8	85	10.93-07.96	M 43 B 18			LE 508
318 is	1.8	103	03.93-07.96	M 42 B 18			LE 508
318 is	1.9	103	09.95-07.96	M 44 B 19			LE 508
318 tds	1.7	66	01.95-02.98	M 41 D 18 (Inter.)			LE 507
						LK 007	
325 td	2.5	85	09.91-02.98	M 51 D 25			LE 507
						LK 008	
325 tds	2.5	105	05.93-02.98	M 51 D 25 (Inter.)			LE 507
						LK 008	
328 i	2.8	142	01.95-02.98	M 52 B 28/M 52 B 28 TU			LE 508
					3)	LK 011	LR 003
M3 3.0	3.0	210	08.94-09.95	S 50 B 30		LK 011	LR 003
M3 3.2	3.2	236	09.95-02.98	S 50 B 32		LK 011	LR 003
3 (E46)							
320 i	2.0	125	09.00-02.05	M54226S1/M 54 B 22			LR 003
320 i Automatic	2.0	125	09.00-02.05	M54226S1/M 54 B 22		LK 011	
320 i Automatic	2.0	110	03.98-09.00	M 52 B 20/M 52 B (20 6 S3) Vanos		LK 011	
323 i	2.5	125	03.98-09.00	M 52 B 25 TU/M 52 B 25 (Vanos)			LR 003
323 i Automatic	2.5	125	03.98-09.00	M 52 B 25 TU/M 52 B 25 (Vanos)		LK 011	
325 i	2.5	141	09.00-02.05	M54256S5/M 54 B 25			LR 003
325 i Automatic	2.5	141	09.00-02.05	M54256S5/M 54 B 25		LK 011	
325 xi	2.5	141	09.00-02.05	M54256S5			LR 003
325 xi Automatic	2.5	141	09.00-02.05	M54256S5		LK 011	
328 i	2.8	142	02.98-06.00	M 52 B 28		LK 011	LR 003
330 i	3.0	170	06.00-02.05	M54306S3/M 54 B 30			LR 003
330 i Automatic	3.0	170	06.00-02.05	M54306S3/M 54 B 30		LK 011	
330 xi	3.0	170	06.00-02.05	M54306S3			LR 003
330 xi Automatic	3.0	170	06.00-02.05	M54306S3		LK 011	
3 Cabriolet (E30)							
320 i	2.0	95	04.86-10.93	M 20 B 20		LK 012	
325 i	2.5	125	09.87-10.93	M 20 B 25		LK 012	
325 i	2.5	126	12.85-12.87	M 20 B 25		LK 012	
3 Cabriolet (E36)							
318 i	1.8	85	01.94-07.96	M 43 B 18			LE 508
320 i	2.0	110	12.93-04.99	M 52 B 20/M 50 B 20 TU/ M 50 B (20 6 S2) Vanos/ M 50 B 20/M 52 B (20 6 S3) Vanos	4)		LE 508
							LR 003
325 i	2.5	141	03.93-03.95	M 50 B 25/M 50 B 25 TU	3)	LK 011	LR 003



kW

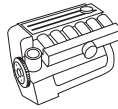

BMW

3 Cabriolet (E36)

M3 3.0	3.0	210	01.94–10.95	S 50 B 30	LK 011	LR 003
M3 3.2	3.2	236	10.95–04.99	S 50 B 32	LK 011	LR 003

3 Cabriolet (E46)

320 Ci	2.2	125	09.00–	M54226S1/M 54 B 22		LR 003
320 Ci Automatic	2.2	125	09.00–	M54226S1/M 54 B 22	LK 011	
323 Ci	2.5	125	04.00–09.00	M 52 B 25 (Vanos)	LK 011	LR 003
325 Ci	2.5	141	09.00–	M54256S5	LK 011	LR 003
330 Ci	3.0	170	06.00–	M54306S3	LK 011	LR 003

3 Compact (E36)

318 tds	1.7	66	01.95–08.00	M 41 D 18 (Inter.)		LE 507
					LK 007	
323 ti	2.5	125	08.97–08.00	M 52 B 25 (Vanos)		LE 508
						LR 003

3 Compact (E46)

325 ti	2.5	141	06.01–02.05	M54256S5/M 54 B 25	LK 011	LR 003
--------	-----	-----	-------------	--------------------	--------	--------

3 Coupe (E36)

316 i	1.6	75	09.93–07.96	M 43 B 16		LE 508
318 is	1.8	103	09.92–10.95	M 42 B 18		LE 508
318 is	1.9	103	09.95–07.96	M 44 B 19		LE 508
320 i	2.0	110	03.92–04.99	M 50 B (20 6 S2) Vanos/ M 52 B (20 6 S3) Vanos		LE 508

					3)	LK 011
320 i	2.0	110	03.92–04.99	M 52 B (20 6 S3) Vanos	LK 011	LR 003

323 i 2.5	2.5	125	03.95–04.99	M 52 B 25 (Vanos)		LE 508
					3)	LK 011
						LR 003

325 i	2.5	141	03.92–04.99	M 50 B 25/M 50 B 25 TU/ M 50 B 25 (Vanos)		LE 508
-------	-----	-----	-------------	--	--	--------

					3)	LK 011
						LR 003

328 i	2.8	142	01.95–04.99	M 52 B 28/M 52 B 28 TU		LE 508
-------	-----	-----	-------------	------------------------	--	--------

					3)	LK 011
						LR 003

M3 3.0	3.0	210	10.92–01.95	S 50 B 30	LK 011	LR 003
M3 3.0	3.0	217	01.95–10.95	S 50 B 30	LK 011	LR 003
M3 3.2	3.2	236	10.95–04.99	S 50 B 32	LK 011	LR 003

3 Coupe (E46)

320 Ci	2.0	110	08.99–09.00	M 52 B 20/M 52 B (20 6 S4)		LR 003
320 Ci Automatic	2.0	110	08.99–09.00	M 52 B 20/M 52 B (20 6 S4)	LK 011	
320 Ci	2.2	125	09.00–	M54226S1/M 54 B 22		LR 003
320 Ci Automatic	2.2	125	09.00–	M54226S1/M 54 B 22	LK 011	
323 Ci	2.5	125	04.99–09.00	M 52 B 25 (Vanos)	LK 011	LR 003
325 Ci	2.5	141	09.00–	M54256S5	LK 011	LR 003
328 Ci	2.8	142	04.99–06.00	M 52 B 28	LK 011	LR 003
330 xi Automatic	3.0	170	06.00–	M54306S3	LK 011	

						LR 003
--	--	--	--	--	--	--------

3 Touring (E30)

320 i	2.0	95	01.88–12.91	M 20 B 20	LK 012	
324 td	2.4	85	01.88–06.93	M 21 D 24/M 21 D 24 WA	LK 007	
325 i	2.5	125	07.87–03.93	M 20 B 25	LK 012	
325 i X	2.5	125	06.88–10.93	M 20 B 25	LK 012	

3 Touring (E36)

316 i	1.6	75	01.96–10.99	M 43 B 16		LE 508
318 i	1.8	85	07.95–07.96	M 43 B 18		LE 508
318 tds	1.7	66	01.95–10.99	M 41 D 18 (Inter.)		LE 507
320 i	2.0	110	01.95–10.99	M 52 B 20/M 50 B 20 TU/M 50 B 20/ M 52 B (20 6 S3) Vanos		LE 508

					3)	LK 011
						LR 003

325 tds	2.5	105	01.95–10.99	M 51 D 25 (Inter.)		LE 507
					LK 008	



kW

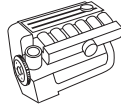

BMW							
3 Touring (E36)							
328 i	2.8	142	01.95-10.99	M 52 B 28/M 52 B 28 TU		LE 508	
						LK 007	LR 003
					3)	LK 011	
3 Touring (E46)							
320 i	2.0	110	10.99-09.00	M 52 B 20/M 52 B (20 6 S3) Vanos			LR 003
320 i Automatic	2.0	110	10.99-09.00	M 52 B 20/M 52 B (20 6 S3) Vanos		LK 011	
320 i	2.2	125	09.00-02.05	M54226S1/M 54 B 22			LR 003
320 i Automatic	2.2	125	09.00-02.05	M54226S1/M 54 B 22		LK 011	
325 i	2.5	141	09.00-02.05	M54256S5/M 54 B 25			LR 003
325 i Automatic	2.5	141	09.00-02.05	M54256S5/M 54 B 25		LK 011	
325 xi	2.5	141	09.00-02.05	M54256S5			LR 003
325 xi Automatic	2.5	141	09.00-02.05	M54256S5		LK 011	
328 i	2.8	142	10.99-06.00	M 52 B 28		LK 011	LR 003
330 i	3.0	170	06.00-02.05	M54306S3/M 54 B 30			LR 003
330 xi	3.0	170	06.00-02.05	M54306S3			LR 003
330 xi Automatic	3.0	170	06.00-02.05	M54306S3		LK 011	
5 (E12)							
520	2.0	85	08.72-08.77	M 10 B 20		LK 012	
525	2.5	107	08.73-10.76	M 30 B 25		LK 012	
525	2.5	110	08.76-05.81	M 30 B 25		LK 012	
528	2.8	121	01.75-08.77	M 30 B 28		LK 012	
528	2.8	125	01.75-08.77	M 30 B 28		LK 012	
528 i	2.8	130	04.77-05.81	M 30 B 28		LK 012	
528 i	2.8	135	04.77-05.81	M 30 B 28		LK 012	
M 535 i	3.5	160	06.80-08.81	M 30 B 35 (Motronic,9.3:1)		LK 012	
5 (E28)							
520 i	2.0	92	06.81-12.87	M 20 B 20		LK 012	
520 i	2.0	95	08.85-12.87	M 20 B 20		LK 012	
520 i	2.0	110	12.86-06.90			LK 012	
524 d	2.4	63	03.86-12.87	M 21 D 24 W		LK 012	
524 td	2.4	85	09.83-12.87	M 21 D 24/M 21 D 24 WA		LK 012	
525 i	2.5	110	06.81-12.87			LK 012	
525 e 2.7	2.7	90	09.81-12.87	M 20 B 27		LK 012	
525 e 2.7	2.7	92	05.83-12.87	M 20 B 27		LK 012	
525 e 2.7	2.7	95	12.84-12.87	M 20 B 27		LK 012	
528 i	2.8	135	06.81-12.87	M 30 B 28		LK 012	
535 i, M 535 i	3.4	136	01.85-12.87	M 30 B 35		LK 012	
535 i, M 535 i	3.4	141	01.85-12.87	M 30 B 35 (Motronic)		LK 012	
535 i, M 535 i	3.4	160	01.85-12.87	M 30 B 35		LK 012	
M5 3.5	3.5	211	08.85-12.87	S 38 B 35		LK 012	
5 (E34)							
518 i	1.8	83	08.89-09.95	M 40 B 18			LE 507
518 i	1.8	85	08.89-09.95	M 43 B 18			LE 507
520 i	2.0	95	01.88-08.91	M 20 B 20			LE 507
					3)	LK 011	
520 i 24V	2.0	110	09.89-09.95	M 50 B 20 TU/M 50 B (20 6 S2) Vanos/ M 50 B 20/M 50 B (20 6 S1)			LE 507
					5)		LR 003
520 i 24V	2.0	110	09.89-09.95	M 50 B (20 6 S2) Vanos			LR 003
524 td	2.4	85	03.88-09.95	M 21 D 24/M 21 D 24 WA			LE 507
						LK 007	
525 i	2.5	125	01.88-08.91	M 20 B 25			LE 507
525 i 24V	2.5	141	09.89-09.95	M 50 B 25/M 50 B 25 TU/ M 52 B 25 (Vanos)			LE 507
					3)	LK 011	
						LK 011	LR 003
525 i X 24V	2.5	141	10.91-09.95	M 52 B 25 (Vanos)			LE 507
							LR 003
525 td	2.5	85	04.93-09.95	M 51 D 25			LE 507
						LK 007	

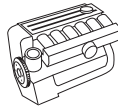
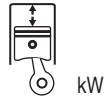

BMW

5 (E34)

525 tds	2.5	105	09.91-09.95	M 51 D 25 (Inter.)		LK 007	LE 507
530 i	3.0	138	01.88-08.91	M 30 B 30			LE 507
							LR 003
530 i V8	3.0	160	09.92-09.95	M 60 B 30		LK 010	LE 507
							LR 004
535 i	3.4	155	01.88-09.95	M 30 B 35			LE 507
							LR 003
M5	3.5	210	12.87-12.88				LE 507
M5 3.6	3.5	232	10.88-05.92	S 38 B 36			LE 507
M5 3.6 KAT	3.5	232	10.88-05.92	S 38 B 36 (Kat)			LE 507
M5 3.8	3.5	250	03.92-09.95	S 38 B 38			LE 507
540 i V8	4.0	210	09.92-09.95	M 60 B 40		LK 010	LE 507
							LR 004

5 (E39)

520 i	2.0	100	04.99-06.03	M 52 B (20 6 S3) Vanos		LK 011	
520 i	2.0	110	01.96-08.98	M 52 B (20 6 S3) Vanos	1) 3)	LK 011	
520 i	2.0	110	01.96-09.00	M 52 B (20 6 S3) Vanos			LR 003
520 i	2.0	125	09.00-06.03	M 54 B 22		LK 011	LR 003
523 i	2.5	125	11.95-09.98	M 52 B 25 TU/M 52 B 25 (Vanos)	1) 3)	LK 011	
523 i	2.5	125	10.98-09.00	M 52 B 25 TU/M 52 B 25 (Vanos)		LK 011	
523 i	2.5	125	11.95-09.00	M 52 B 25 TU/M 52 B 25 (Vanos)			LR 003
525 i	2.5	141	09.00-06.03	M54256S5/M 54 B 25		LK 011	LR 003
525 td	2.5	85	01.97-06.03	M 51 D 25		LK 008	
525 tds	2.5	105	01.96-06.03	M 51 D 25 (Inter.)		LK 008	
528 i	2.8	142	11.95-09.98	M 52 B 28/M 52 B 28 TU	1) 3)	LK 011	
528 i	2.8	142	10.98-09.00	M 52 B 28/M 52 B 28 TU		LK 011	
528 i	2.8	142	11.95-09.00	M 52 B 28/M 52 B 28 TU			LR 003
530 d	3.0	135	08.98-09.00	M 57 D 30		LK 009	
530 d	3.0	142	09.00-06.03	M 57 D 30		LK 009	
530 i	3.0	170	09.00-06.03	M54306S3/M 54 B 30		LK 011	LR 003
535 i	3.5	173	04.96-03.99	M 62 B (35 8 S1)/M 62 B 35		LK 010	LR 004
535 i	3.5	180	04.99-06.03	M 62 B (35 8 S2)/M 62 B 35 TU		LK 010	LR 004
540 i	4.4	210	04.96-06.03	M 62 B 44 TU/M 62 B 44/M62448S2		LK 010	
M5	4.9	294	10.98-06.03	S 38 B 49/S 62 B 50			LR 004

5 Touring (E34)

518 i	1.8	83	03.93-09.94	M 40 B 18			LE 507
518 g	1.8	85	11.95-06.96	M 43 B 18			LE 507
518 i	1.8	85	09.94-01.97	M 43 B 18			LE 507
520 i	2.0	110	11.91-01.97	M 50 B 20 TU/M 50 B (20 6 S2) Vanos/ M 50 B 20/M 50 B (20 6 S1)	5)		LE 507
520 i	2.0	110	11.91-01.97	M 50 B (20 6 S2) Vanos			LR 003
525 i	2.5	141	11.91-01.97	M 50 B 25/M 50 B 25 TU			LE 507
							LR 003
525 i X	2.5	141	02.92-01.97	M 50 B 25/M 52 B 25 (Vanos)			LE 507
525 i X	2.5	141	02.92-01.97	M 50 B 25			LR 003
525 td	2.5	85	03.93-01.97	M 51 D 25			LE 507
						LK 007	
525 tds	2.5	105	12.91-01.97	M 51 D 25 (Inter.)			LE 507
						LK 007	
530 i V8	3.0	160	09.92-01.97	M 60 B 30			LE 507
						LK 010	LR 004
540 i	4.0	210	09.93-01.97	M 60 B 40			LE 507
						LK 010	LR 004
M5 3.8	3.8	250	09.94-01.97	S 38 B 38			LE 507

5 Touring (E39)

520 i	2.0	110	01.97-09.98	M 52 B 20/M 52 B (20 6 S4)/ M 52 B (20 6 S3) Vanos	1) 3)	LK 011	
520 i	2.0	110	10.98-09.00	M 52 B 20/M 52 B (20 6 S4)/ M 52 B (20 6 S3) Vanos		LK 011	



kW

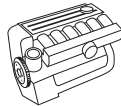

BMW							
5 Touring (E39)							
520 i	2.0	110	01.97-09.00	M 52 B (20 6 S4)			LR 003
520 i	2.0	100	04.99-05.04	M 52 B (20 6 S3) Vanos	LK 011		
520 i	2.2	125	09.00-05.04	M 54 B 22	LK 011		LR 003
523 i	2.5	125	01.97-09.98	M 52 B 25 TU/M 52 B 25 (Vanos) ^{1) 3)}	LK 011		
523 i	2.5	125	10.98-09.00	M 52 B 25 TU/M 52 B 25 (Vanos)	LK 011		
523 i	2.5	125	01.97-09.00	M 52 B 25 TU/M 52 B 25 (Vanos)			LR 003
525 i	2.5	141	09.00-05.04	M54256S5/M 54 B 25	LK 011		LR 003
525 tds	2.5	105	03.97-05.04	M 51 D 25 (Inter.)	LK 008		
528 i	2.8	142	01.97-09.98	M 52 B 28/M 52 B 28 TU ^{1) 3)}	LK 011		
528 i	2.8	142	10.98-09.00	M 52 B 28/M 52 B 28 TU	LK 011		
528 i	2.8	142	01.97-09.00	M 52 B 28/M 52 B 28 TU			LR 003
530 i	3.0	170	09.00-05.04	M54306S3/M 54 B 30	LK 011		LR 003
540 i	4.4	210	01.97-05.04	M 62 B 44 TU/M 62 B 44/M62448S2	LK 010		
6 (E24)							
628 CSi	2.8	135	09.79-08.87	M 30 B 28	LK 012		
630 CS	3.0	135	04.76-08.79	M 30 B 30	LK 012		
630 CS	3.0	136	04.76-08.79	M 30 B 30	LK 012		
633 CSi	3.3	145	09.78-08.84	M 30 B 32	LK 012		
633 CSi	3.2	147	04.76-09.78		LK 012		
635 CSi	3.4	136	01.85-05.89	M 30 B 35 (Motronic,8:1,Kat.)	LK 012		
635 CSi	3.4	141	04.85-09.90	M 30 B 35	LK 012		
635 CSi	3.4	155	08.87-05.89	M 30 B 35	LK 012		
635 CSi	3.5	160	06.78-08.88	M 30 B 35 (L-Jetronic,10:1)/ M 30 B 35 (Motronic,10:1)/ M 30 B 35 (Motronic,9.3:1) ³⁾	LK 012		
M 635 CSi	3.5	191	10.86-10.88	S 38 B 35 (Kat)	LK 012		
M 635 CSi	3.5	211	03.84-05.89	S 38 B 35	LK 012		
7 (E23)							
728 i	2.8	135	07.78-08.86	M 30 B 28	LK 012		
730	3.0	135	05.77-08.79	M 30 B 30	LK 012		
733 i	3.2	145	05.77-09.79	M 30 B 32	LK 012		
735 i	3.4	136	01.85-08.86	M 30 B 35 (Motronic,8:1,Kat.)	LK 012		
735 i	3.4	141	04.85-08.86	M 30 B 35 (Motronic)	LK 012		
735 i	3.5	160	09.79-08.86	M 30 B 35 (Motronic,10:1)/ M 30 B 35 (Motronic,9.3:1)	LK 012		
745 i	3.2	185	04.80-04.83	M 30 B 32 (Turbo)	LK 006		
745 i	3.4	185	05.83-08.86	M 30 B 35	LK 012		
7 (E32)							
730 i,iL	3.0	145	12.86-09.94	M 30 B 30		LE 507	
							LR 003
730 i,iL	3.0	138	12.86-09.94	M 30 B 30		LE 507	
							LR 003
730 i,iL V8	3.0	160	04.92-09.94	M 60 B 30		LE 507	
					LK 010		LR 004
735 i,iL	3.4	155	09.86-09.92	M 30 B 35		LE 507	
							LR 003
735 i,iL	3.4	162	09.86-12.87	M 30 B 35 (Motronic,9.2:1)		LE 507	
							LR 003
740 i,iL V8	4.0	210	04.92-09.94	M 60 B 40		LE 507	
					LK 010		LR 004
750 i,iL V12	5.0	220	09.87-09.94	M 70 B 50		LE 507	
					LK 010		LR 004
7 (E38)							
725 tds	2.5	105	04.96-11.01	M 51 D 25 (Inter.)	LK 008		
728 i,iL	2.8	142	08.95-11.01	M 52 B 28/M 52 B 28 TU	LK 011		
728 i,iL	3.0	142	08.95-11.01	M 52 B 28/M 52 B 28 TU			LR 003
730 d	3.0	142	04.00-11.01	M57306D1	LK 009		
730 i,iL	3.0	155	10.94-11.01	M 60 B 30	LK 010		
730 i,iL	3.0	160	10.94-11.01	M 60 B 30	LK 010		LR 004
735 i,iL	3.5	173	01.96-11.01	M 62 B (35 8 S1)/M 62 B 35	LK 010		LR 004



kW

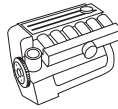

BMW								
7 (E38)								
740 i,iL	4.0	210	10.94–11.01	M 60 B 40		LK 010	LR 004	
740 i,iL	4.4	210	01.96–11.01	M 62 B 44 TU/M 62 B 44/M62448S2		LK 010	LR 004	
750 i,iL	5.4	240	12.94–11.01	M 73 B 54		LK 010	LR 004	
7 (E65, E66)								
740 d	3.9	190	10.02–	N67398D1		LK 009		
8 (E31)								
840 i	4.0	210	02.93–02.96	M 60 B 40		LK 010	LE 507	
							LR 004	
840 Ci	4.4	210	01.96–12.99	M 62 B 44 TU/M 62 B 44		LK 010	LE 507	
							LR 004	
850 i,Ci	5.0	220	04.90–10.94	M 70 B 50		LK 010	LE 507	
							LR 004	
850 Ci	5.4	240	09.94–12.99	M 73 B 54		LK 010	LE 507	
							LR 004	
850 CSi	5.6	280	04.93–12.96	M 70 B 56		LK 010	LE 507	
							LR 004	
X5 (E53)								
3.0 d	2.9	135	05.01–	M57306D1		LK 009		
3.0 i	3.0	170	05.00–	M54306S3/M 54 B 30			LR 003	
Z3								
1.8	1.8	85	10.95–06.96	M 43 B 18			LE 508	
1.9	1.9	103	10.95–06.96	M 44 B 19			LE 508	
2.0	2.0	110	04.99–01.03	M 52 B 20/M 52 B (20 6 S4)		LK 011	LR 003	
2.2	2.2	125	08.00–01.03	M54226S1/M 54 B 22		LK 011	LR 003	
2.8	2.8	141	04.97–06.00	M 52 B 28/M 52 B 28 TU		LK 011	LR 003	
3.0	3.0	170	06.00–01.03	M54306S3/M 54 B 30		LK 011	LR 003	
M 3.2	3.2	236	03.97–06.01	S 50 B 32		LK 011	LR 003	
M 3.2	3.2	239	06.01–01.03	S 54 B 32 (32 6 S4)/S 54 B 32			LR 003	
Z3 Coupe								
2.8	2.8	141	07.97–06.00	M 52 B 28		LK 011	LR 003	
3.0	3.0	170	06.00–06.03	M54306S3		LK 011	LR 003	
M 3.2	3.2	236	02.98–06.01	S 50 B 32		LK 011	LR 003	
M 3.2	3.2	239	06.01–06.03	S54326S4/S 54 B 32			LR 003	
2000-3.2 Coupe (E9)								
2.5 CS	2.5	110	09.74–03.76	M 30 B 25		LK 012		
3.0 CS	3.0	132	05.71–03.76			LK 012		
3.0 Csi	3.0	147	07.71–03.76			LK 012		
2500-3.3 (E3)								
2500	2.5	110	10.68–04.77	M 30 B 25		LK 012		
2800	2.8	125	10.68–07.75	M 30 B 28		LK 012		
2.8 L	2.8	125	02.75–04.77	M 30 B 28		LK 012		
3.0 L	3.0	132	02.75–04.77			LK 012		
3.0 S	3.0	132	05.71–04.77			LK 012		
3.0 Si	3.0	143	10.75–04.77			LK 012		
3.0 Si	3.0	147	07.71–09.75			LK 012		
3.3 L	3.3	140	01.74–09.76	M 30 B 33 (35/40 INAT)		LK 012		
CITROËN								
BERLINGO (MF)								
1.4 i (MFKFX)	1.4	55	07.96–	KFX (TU3JP)/KFW (TU3JP)		LE 010		
1.6 HDI 75	1.6	55	07.05–	DV6B			LE 509	
1.6 HDI 90	1.6	66	07.05–	DV6ATED4			LE 509	
1.8 D (MFA9A)	1.8	43	07.98–	A9A (XUD7)		LE 026		
1.9 D (MFDJY)	1.9	50	07.96–	D9B (XUD9A/L)/DJY (XUD9A)		LE 026		
1.9 D (MFWJZ)	1.9	51	07.98–	WJY (DW8B)/WJZ (DW8)			LE 509	
1.9 D 4WD (MFWJZ)	1.9	51	07.98–	WJZ (DW8)			LE 509	
2.0 HDi	2.0	66	11.02–10.05	DW10TD			LE 509	
2.0 HDI 90 (MFRHY)	2.0	66	12.99–	RHY (DW10TD)		LE 009		
BERLINGO Kasten (M.)								
1.4 i (MBKFX)	1.4	55	07.96–	KFX (TU3JP)/KFW (TU3JP)		LE 010		



kW

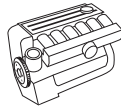

CITROËN

BERLINGO Kasten (M_)

1.6 HDi 75	1.6	55	07.05-	DV6B	LE 509
1.6 HDi 90	1.6	66	07.05-	DV6ATED4	LE 509
1.9 D 70 4WD	1.9	51	07.98-	WJZ (DW8)	LE 509
1.9 D 70 (MBWJZ, MCWJZ)	1.9	51	04.99-	WJZ (DW8)	LE 009
2.0 HDi 90 4WD	2.0	66	11.00-	RHY (DW10TD)	LE 509
2.0 HDi 90 (MBRHY, MCRHY)	2.0	66	12.99-	RHY (DW10TD)	LE 009

JUMPY (U6U)

2.0 HDi 110	2.0	80	03.00-	RHZ (DW10ATED)	LE 509
-------------	-----	----	--------	----------------	---------------

JUMPY Pritsche/Fahrgestell (BU_, BV_, BW_, BX_)

2.0 HDi 95	2.0	69	10.99-	RHX	LE 509
2.0 HDi	2.0	80	12.03-10.06		LE 509
1.6 i	1.6	65	03.93-01.98	BFZ (XU5JP)	LE 011
1.8 i	1.8	74	03.93-01.98	LFZ (XU7JP)	LE 011
1.8 i 16V	1.8	81	06.95-01.98	LFY (XU7JP4)	LE 011
1.9 D	1.9	50	06.94-01.98	DJZ (XUD9Y)	LE 011
1.9 D	1.9	51	06.94-01.98	D9B (XUD9A/L)	LE 011
1.9 SD	1.9	55	02.96-01.98	DHW (XUD9SD)	LE 011
1.9 Turbo D	1.9	66	10.94-01.98	DHX (XUD9TF/BTF)/DHY (XUD9TE/Y)	LE 011
2.0 i	2.0	89	03.93-01.98	RFX (XU10J2C)	LE 011
2.0 i 16V	2.0	97	06.95-01.98	RFV (XU10J4R)	LE 011
2.0 i 16V	2.0	110	06.94-01.98	RFT (XU10J4/Z)	LE 011
2.0 i 16V	2.0	112	03.93-01.98	RFY (XU10J4/Z)	LE 011
2.0 Turbo	2.0	108	06.95-01.98	RGX (XU10J2TE)	LE 011
2.1 Turbo D 12V	2.1	80	06.95-01.98	P8C (XUD11BTE)	LE 011

XANTIA Break (X1)

1.8 i	1.8	74	06.95-01.98	LFZ (XU7JP)	LE 011
1.8 i 16V	1.8	81	06.95-01.98	LFY (XU7JP4)	LE 011
1.9 SD	1.9	55	04.97-01.98	DHW (XUD9SD)	LE 011
1.9 Turbo D	1.9	66	06.95-01.98	DHX (XUD9TF/BTF)/DHY (XUD9TE/Y)/ D8B (XUD9TF)	LE 011
2.0 i	2.0	89	06.95-01.98	RFX (XU10J2C)	LE 011
2.0 i 16V	2.0	97	06.95-01.98	RFV (XU10J4R)	LE 011
2.0 Turbo	2.0	108	06.95-01.98	RGX (XU10J2TE)	LE 011
2.1 Turbo D 12V	2.1	80	06.96-01.98	P8C (XUD11BTE)	LE 011

XANTIA (X2)

1.8 i 16V	1.8	81	01.98-04.03	LFY (XU7JP4)	LE 025
1.9 Turbo D	1.9	66	01.98-04.03	DHX (XUD9TF/BTF)/DHY (XUD9TE/Y)	LE 025
2.0 i 16V	2.0	97	01.98-04.03	RFV (XU10J4R)	LE 025
2.0 Turbo	2.0	108	01.98-04.03	RGX (XU10J2TE)	LE 025
2.1 Turbo D 12V	2.1	80	01.98-02.99	P8C (XUD11BTE)	LE 025

XANTIA Break (X2)

1.8 i 16V	1.8	81	01.98-04.03	LFY (XU7JP4)	LE 025
1.9 Turbo D	1.9	66	01.98-04.03	DHX (XUD9TF/BTF)/D8B (XUD9TF)	LE 025
2.0 i 16V	2.0	97	01.98-04.03	RFV (XU10J4R)	LE 025
2.0 Turbo	2.0	108	01.98-04.03	RGX (XU10J2TE)	LE 025
2.1 Turbo D 12V	2.1	80	01.98-02.99	P8C (XUD11BTE)	LE 025

XSARA (N1)

1.4 i	1.4	55	04.97-03.05	KFX (TU3JP)/KFW (TU3JP)	LE 010
1.6 i	1.6	65	04.97-09.00	NFZ (TU5JP)	LE 010
1.9 D	1.9	50	04.97-09.00	DJY (XUD9A)	LE 009
1.9 D	1.9	51	07.98-03.05	WJY (DW8B)/WJZ (DW8)	LE 009
1.9 TD	1.9	66	04.97-09.00	DHY (XUD9TE/Y)	LE 009
2.0 16V	2.0	97	07.98-09.00	RFV (XU10J4R)	LE 010

XSARA Break (N2)

1.4 i	1.4	55	10.97-08.05	KFX (TU3JP)/KFW (TU3JP)	LE 010
1.6 i	1.6	65	10.97-09.00	NFZ (TU5JP)	LE 010
1.9 D	1.9	50	10.97-09.00	DJY (XUD9A)	LE 009
1.9 D	1.9	51	07.98-08.05	WJY (DW8B)/WJZ (DW8)	LE 009
1.9 D	1.9	55	01.98-09.00	DHV (XUD9BSD)	LE 009
1.9 TD	1.9	66	10.97-09.00	DHY (XUD9TE/Y)	LE 009

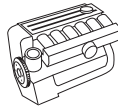
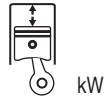

CITROËN

XSARA Coupe (N0)

1.4 i	1.4	55	03.98–03.05	KFX (TU3JP)/KFW (TU3JP)	LE 010	
1.8 i	1.8	66	02.98–09.00	LFX (XU7JB)	LE 010	
1.9 D	1.9	50	02.98–09.00	DJY (XUD9A)	LE 009	
1.9 D	1.9	51	02.99–03.05	WJY (DW8B)/WJZ (DW8)	LE 009	
1.9 TD	1.9	66	02.98–09.00	DHY (XUD9TE/Y)	LE 009	

XSARA PICASSO (N68)

1.6 16V	1.6	80	09.05–	NFU (TU5JP4)		LE 581
1.6 HDi	1.6	80	05.04–	DV6TED4		LE 509
1.6 HDi	1.6	66	09.05–			LE 509
2.0 HDi	2.0	66	12.99–	RHY (DW10TD)		LE 509

ZX (N2)

1.1	1.1	40	03.91–08.93	H1A/H1B	LE 010	
1.1	1.1	44	03.91–06.97	HDZ (TU1M)	LE 010	
1.4	1.4	55	03.91–06.97	KDZ (TU3M/Z)	LE 010	
1.4 i	1.4	55	03.91–06.97	KDZ (TU3M/Z)/KFX (TU3JP)/ KDX (TU3M/Z)	LE 010	
1.6 i	1.6	65	03.91–06.97	BFZ (XU5JP)/BDY (XU5M)	LE 010	
1.8 D	1.8	44	06.93–06.97	161A (XUD7)	LE 010	
1.8 i	1.8	74	07.92–06.97	LFZ (XU7JP)	LE 010	
1.8 i 16V	1.8	81	01.96–06.97	LFY (XU7JP4)	LE 010	
1.9 i	1.9	88	03.91–06.97	DKZ (XU9JA)	LE 010	
1.9 D	1.9	47	03.91–06.97	DJZ (XUD9Y)	LE 010	
1.9 D	1.9	50	06.94–06.97	D9B (XUD9A/U)	LE 010	
1.9 TD	1.9	66	07.92–06.97	DHY (XUD9TE/Y)	LE 010	
2.0 i 16V	2.0	110	06.94–06.97	RFT (XU10J4/Z)	LE 010	
2.0 i 16V	2.0	112	07.92–10.94	RFT (XU10J4/Z)/RFY (XU10J4/Z)	LE 010	
2.0 i 16V	2.0	120	05.96–06.97	RFS (XU10J4RS)	LE 010	

ZX Break (N2)

1.4 i	1.4	55	10.93–10.97	KFX (TU3JP)/KDX (TU3M/Z)/ KDY (TU3M)	LE 010	
1.6 i	1.6	65	10.93–10.97	BFZ (XU5JP)/BDY (XU5M)	LE 010	
1.8 D	1.8	44	10.93–10.97	161A (XUD7)	LE 010	
1.8 i	1.8	74	10.93–10.97	LFZ (XU7JP)	LE 010	
1.9 D	1.9	47	10.93–10.97	DJZ (XUD9Y)	LE 010	
1.9 D	1.9	50	06.94–10.97	D9B (XUD9A/U)	LE 010	
1.9 TD	1.9	66	10.93–10.97	DHY (XUD9TE/Y)	LE 010	

FIAT

BRAVA (182)

1.2 16V 80	1.2	59	10.00–10.01	188 A5.000		LE 521
1.2 16V 80	1.2	60	12.98–10.00	182 B2.000		LE 521
1.6 16V (182.BH)	1.6	66	10.95–10.01	182 A6.000		LE 521
1.6 16V (182.BB)	1.6	76	02.96–10.01	182 A4.000		LE 521
1.8 GT 16V	1.8	83	10.95–10.01	182 A2.000		LE 524
1.9 TD 75 S	1.9	55	03.96–10.01	182 A8.000		LE 524
1.9 TD 100 S	1.9	74	03.96–10.01	182 A7.000		LE 524

BRAVO (182)

1.2 16V 80	1.2	59	10.00–10.01	188 A5.000		LE 521
1.2 16V 80	1.2	60	12.98–10.00	182 B2.000		LE 521
1.6 16V (182.AH)	1.6	66	10.95–04.98	182 A6.000		LE 521
1.6 16V (182.AB)	1.6	76	03.96–10.01	182 A4.000		LE 521
1.6	1.6	76	09.00–02.02	182 B6.000		LE 521
1.8 GT	1.8	83	10.95–12.99	182 A2.000		LE 524
1.9 TD 75 S	1.9	55	03.96–10.01	182 A8.000		LE 524
1.9 TD 100 S	1.9	74	03.96–10.01	182 A7.000		LE 524
2.0 HGT 20V	2.0	108	10.95–07.98	182 A1.000		LE 524
2.0 HGT 20V	2.0	113	07.98–10.01	182 B7.000		LE 524

CINQUECENTO (170)

0.9 i.e. S (170AF, 170CF)	0.9	29	07.91–07.99	1170 A1.000/1170 A1.046		LE 511
0.9 (170AB)	0.9	30	07.91–12.93	170 A1.000		LE 511



kW

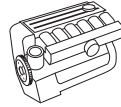

FIAT						
CINQUECENTO (170)						
0.9 i.e. (170AC)	0.9	30	07.91-12.93	170 A1.046		LE 511
DOBLO (119)						
1.2 (223AXA1A)	1.2	48	03.01-	223 A5.000		LE 530
1.6 16V (223AXD1A)	1.6	76	10.01-	182 B6.000		LE 526
1.6 Natural Power	1.6	76	09.02-	182 B6.000		LE 526
1.9 D	1.9	46	03.01-	223 A6.000		LE 529
1.9 JTD	1.9	74	10.01-	182 B9.000/223 B2.000		LE 518
1.9 JTD	1.9	77	07.03-	223 B1.000/223 A7.000		LE 518
1.9 D Multijet	1.9	88	10.05-	186A9.000		LE 518
DOBLO Cargo (223)						
1.2 (223ZX1A)	1.2	48	03.01-	223 A5.000		LE 530
1.6 16V (223ZXD1A)	1.6	76	10.01-	182 B6.000		LE 526
1.6 Natural Power	1.6	76	09.02-	182 B6.000		LE 526
1.9 D	1.9	46	03.01-	223 A6.000		LE 529
1.9 JTD	1.9	74	10.01-	182 B9.000		LE 518
1.9 JTD	1.9	77	07.03-	223 B1.000/223 A7.000		LE 518
GRANDE PUNTO (199)						
1.2	1.2	48	10.05-	199 A4.000		LE 522
1.3 D Multijet	1.3	55	10.05-	199 A2.000		LE 525
1.3 D Multijet	1.3	66	10.05-	199 A3.000		LE 525
1.4	1.4	57	10.05-	350 A1.000		LE 522
1.4 16V	1.4	70	10.05-	199 A6.000		LE 522
1.4 T-Jet	1.4	88	09.07-	198 A4.000		LE 522
1.4 Abarth	1.4	114	12.07-			LE 522
1.9 D Multijet	1.9	88	10.05-	939 A1.000		LE 532
1.9 D Multijet	1.9	96	10.05-	199 A5.000		LE 532
IDEA						
1.2 16V	1.2	59	01.04-	188 A5.000		LE 551
1.4	1.4	57	10.05-	350 A1.000		LE 550
1.4 16V	1.4	70	01.04-	843 A1.000		LE 550
MAREA (185)						
1.2 16V	1.2	60	10.98-	182 B2.000		LE 521
1.6	1.6	76	09.00-08.02	182 B6.000		LE 521
1.6 100 16V	1.6	76	09.96-	182 A4.000		LE 521
1.6 100 16V Bipower	1.6	76	04.99-	186 A4.000/185 A3.000 → VET-Nr. 20552936		LE 521
1.8 115 16V	1.8	83	09.96-	182 A2.000		LE 524
1.9 TD 100	1.9	74	09.96-	182 A7.000		LE 534
1.9 TD 75	1.9	55	09.96-	182 A8.000		LE 534
MAREA Weekend (185)						
1.2 16V	1.2	60	10.98-	182 B2.000		LE 521
1.6	1.6	76	09.00-08.02	182 B6.000		LE 521
1.6 100 16V	1.6	76	09.96-	182 A4.000		LE 521
1.8 115 16V	1.8	83	09.96-	182 A2.000		LE 524
1.9 TD 100	1.9	74	09.96-	182 A7.000/182 B9.000		LE 534
1.9 TD 75	1.9	55	09.96-	182 A8.000		LE 534
MULTIPLA (186)						
1.6	1.6	68	05.04-08.05	182 B6.000 → VET-Nr. 2178783		LE 521
1.6	1.6	74	03.01-08.05	182 B6.000 → VET-Nr. 2178783		LE 521
1.6	1.6	76	09.00-02.01	182 B6.000 → VET-Nr. 2178783		LE 521
1.6 100 16V	1.6	76	04.99-	182 A4.000 → VET-Nr. 2178783		LE 521
1.6 16V Bipower	1.6	76	04.99-	186 A4.000 → VET-Nr. 2178783		LE 521
1.6 16V Bipower	1.6	76	10.01-	182 B6.000 → VET-Nr. 2178783		LE 521
1.6 16V Blupower	1.6	70	04.02-	182 B6.000 → VET-Nr. 2178783		LE 521
1.6 16V Blupower	1.6	70	04.99-	186 A3.000 → VET-Nr. 2178783		LE 521
1.9 JTD	1.9	88	04.02-	186A9.000		LE 524
1.9 JTD 105	1.9	77	01.00-	182 B4.000		LE 524
1.9 JTD 110	1.9	81	03.01-07.02	186 A6.000		LE 524
1.9 JTD 115	1.9	85	07.02-	186 A8.000		LE 524

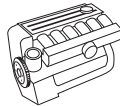
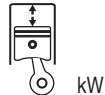

FIAT

PUNTO (176)

55 1.1	1.1	40	09.93-09.99	176 A6.000/176 B2.000	LE 514
60 1.2	1.2	43	01.94-09.99	176 A7.000	LE 515
60 1.2	1.2	44	03.94-09.99	176 B1.000/176 B4.000	LE 514
85 16V 1.2	1.2	63	04.97-09.99	176 B9.000	LE 515
90 1.6	1.6	65	01.94-04.97	176 A9.000	LE 515

PUNTO (188)

1.2 60	1.2	44	09.99-	188 A4.000	LE 512
				1)	LE 516
1.2 16V 80	1.2	59	09.99-	188 A5.000	LE 512
1.2 Natural Power	1.2	44	09.03-	188 A4.000	LE 536
1.3 JTD 16V	1.3	51	06.03-	188 A9.000	LE 531
1.9 DS 60	1.9	44	09.99-	188 A3.000	LE 535

PUNTO Cabriolet (176C)

60 1.2	1.2	44	05.95-06.00	176 B1.000/176 B4.000	LE 514
85 16V 1.2	1.6	63	04.97-06.00	176 B9.000	LE 515
90 1.6	1.6	65	04.94-04.97	176 A9.000	LE 515

PUNTO EVO

1.2	1.2	48	10.09-	199 A4.000	LE 522
1.4	1.4	57	10.09-	350 A1.000	LE 522

PUNTO Van (176L)

1.1	1.1	40	04.96-02.00	176 B2.000	LE 514
-----	-----	----	-------------	------------	---------------

PUNTO Van (188AX)

1.2 60	1.2	44	06.02-	188 A4.000	LE 536
1.9 D 60	1.9	44	02.00-	188 A3.000	LE 535

SEICENTO (187)

0.9 (187AXA, 187AXA1A)	0.9	29	01.98-	1170 A1.046	LE 517
1.1 (187AXB, 187AXB1A)	1.1	40	01.98-	187 A1.000/176 B2.000	LE 517
Elektra		30	01.99-		LE 513

SEICENTO Van (187)

0.9 (187AXA)	0.9	29	01.98-	1170 A1.046	LE 520
1.1 (187CXB/C)	1.1	40	01.98-	176 B2.000	LE 520

STILO (192)

1.2 16V (192_XA1B)	1.2	59	02.02-	188 A5.000	LE 519
1.4 16V	1.4	66	03.05-	192 B2.000	LE 519
1.4 16V	1.4	70	01.04-	843 A1.000	LE 519
1.6 16V (192_XB1A)	1.6	76	10.01-	182 B6.000	LE 519
1.8 16V	1.8	98	10.01-	192 A4.000	LE 528
1.9 D Multijet	1.9	74	09.05-	192 A9.000	LE 519
1.9 D Multijet	1.9	88	09.05-	192 A8.000	LE 519
1.9 D Multijet	1.9	110	09.05-	937 A5.000	LE 519
1.9 JTD	1.9	59	02.02-	192 A3.000	LE 519
1.9 JTD	1.9	66	09.04-	192 B5.000	LE 519
1.9 JTD	1.9	85	10.01-	192 A1.000/937 A7.000	LE 519
1.9 JTD	1.9	103	01.04-	192 A5.000	LE 520
2.4 20V	2.4	125	10.01-	192 A2.000	LE 533

STILO Multi Wagon (192)

1.4 16V	1.4	66	03.05-	192 B2.000	LE 523
1.4 16V	1.4	70	01.04-	843 A1.000	LE 523
1.6 16V	1.6	76	01.03-	182 B6.000	LE 519
1.8 16V	1.8	98	01.03-	192 A4.000	LE 528
1.9 D	1.9	66	09.04-	192 B5.000	LE 519
1.9 D Multijet	1.9	74	09.05-	192 A9.000	LE 519
1.9 D Multijet	1.9	88	09.05-	192 A8.000	LE 519
1.9 D Multijet	1.9	110	09.05-	937 A5.000	LE 519
1.9 JTD	1.9	59	01.03-	192 A3.000	LE 519
1.9 JTD	1.9	85	01.03-	192 A1.000/937 A7.000	LE 519
1.9 JTD	1.9	103	01.04-	192 A5.000	LE 520

UNO (146A/E)

1.3 Turbo i.e.	1.3	74	09.89-03.91	146 A2.246	LE 527
1.3 Turbo i.e.	1.3	77	04.85-08.89	146 A2.000	LE 527



kW

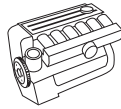

FIAT						
UNO (146A/E)						
50 1.1	1.1	37	01.86–12.89	146 A4.044		LE 527
50 1.1	1.1	37	01.90–12.93	156 C.046		LE 527
50 i.e. 1.1	1.1	36	06.92–12.93	146 C3.000		LE 527
55 1.1	1.1	40	01.83–08.89	138 B.000		LE 527
60 1.1	1.1	42	04.89–12.92	160 A3.000		LE 527
60 1.1	1.1	43	05.85–08.89	146 A4.048		LE 527
70 1.3	1.3	48	05.85–08.89	149 A7.000		LE 527
75 i.e. 1.5	1.5	55	10.85–12.93	149 C1.000/138 C2.048		LE 527
FORD						
ESCORT V (GAL)						
1.8 16V XR3i	1.8	77	02.92–12.92	RDA		LE 012
1.8 16V XR3i	1.8	96	02.92–12.92	RQB		LE 012
ESCORT VI (GAL)						
1.4	1.4	52	09.92–01.95	F6F/F6G		LE 012
1.4	1.4	55	01.94–01.95	FUH		LE 012
1.6 i 16V	1.6	65	01.94–01.95	L1H		LE 012
1.6 i 16V	1.6	66	09.92–01.95	L1E		LE 012
1.8 16V XR3i	1.8	96	09.92–01.95	RQB		LE 012
1.8 i 16V	1.8	77	09.92–01.95	RDA		LE 012
1.8 XR3i 16V 4x4	1.8	77	08.93–01.95	RDA		LE 012
1.8 XR3i 16V 4x4	1.8	96	08.93–01.95	RQB		LE 012
ESCORT VI Cabriolet (ALL)						
1.6 16V XR3i	1.6	66	12.92–01.95	L1E		LE 012
1.6 i 16V	1.6	65	02.94–01.95	L1H		LE 012
1.8 16V XR3i	1.8	77	12.92–01.95	RDA		LE 012
1.8 16V XR3i	1.8	96	12.92–01.95	RQB		LE 012
ESCORT VI Kombi (GAL)						
1.6 i 16V	1.6	65	01.94–01.95	L1H		LE 012
1.6 i 16V	1.6	66	09.92–01.95	L1E		LE 012
1.8 i 16V	1.8	77	01.93–01.95	RDA		LE 012
1.8 i 16V	1.8	96	02.93–01.95	RQB		LE 012
ESCORT VI Stufenheck (GAL)						
1.4	1.4	55	08.93–01.95	F4B/FUH		LE 012
1.6 i 16V	1.6	66	08.93–01.95	L1E/L1K		LE 012
ESCORT VII (GAL, AAL, ABL)						
1.4	1.4	55	01.95–10.98	F4B		LE 012
1.8 16V	1.8	85	01.95–10.98	RKC		LE 012
ESCORT VII Cabriolet (ALL)						
1.4	1.4	55	02.95–08.98	F4B		LE 012
1.6 16V XR3i	1.6	66	02.95–09.99	L1E		LE 012
1.8 16V XR3i	1.8	85	10.95–08.98	RKC		LE 012
ESCORT VII Kombi (GAL, ANL)						
1.4	1.4	55	01.95–02.99	F4B/FUH		LE 012
1.6 16V	1.6	66	01.95–02.99	L1E		LE 012
1.8 16V	1.8	85	01.95–02.99	RKC		LE 012
ESCORT VII Stufenheck (GAL, AFL)						
1.4	1.4	55	01.95–02.99	F4B/FUH		LE 012
1.6 i 16V	1.6	66	01.95–02.99	L1E/L1K		LE 012
FIESTA III (GFJ)						
1.3 KAT	1.3	44	05.91–01.97	J6B		LE 583
1.4	1.4	52	03.89–12.95	F6E		LE 012
1.4	1.4	54	03.89–12.95	FUG/FUJ		LE 012
1.4 KAT	1.4	54	03.89–12.95	F4A		LE 012
1.6 XR2i	1.6	76	03.89–03.93	LJD		LE 012
GALAXY (WGR)						
1.9 TDI	1.9	66	03.95–05.06	ANU/AHU/1Z		LE 030
2.0 i	2.0	85	11.95–05.06	NSE/ZVSA		LE 030
ORION III (GAL)						
1.4	1.4	52	07.90–12.93	F6F/F6G		LE 012

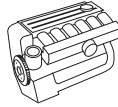
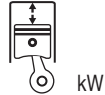

FORD

ORION III (GAL)							
1.6 i 16V	1.6	66	07.92-12.93	L1E/L1K			LE 012
1.8 i 16V	1.8	77	02.92-12.93	RDA			LE 012
SIERRA Kombi (BNC)							
2.0	2.0	66	08.82-10.84	NYT			LK 091
SIERRA Schrägheck (GBC)							
2.0	2.0	66	08.82-10.84	NYT			LK 091
TRANSIT Bus							
2.4 TDCi	2.4	103	07.06-	H9FB			LKK 012
TRANSIT (E_)							
2.5 DI (EBS, EDS, EDL, ESS, EUS)	2.5	51	08.91-07.94	4FA /4BC/4CC			LK 017
2.5 DI (EBL, ECL, EDS, EDL)	2.5	56	07.94-12.99	4HC /4HB		1)	LK 014
							LK 015
2.5 DI (EBS, EDS, EGL, ESS, EUS)	2.5	59	09.91-07.94	4DA			LK 017
2.5 TD (EB_, ED_, ES_)	2.5	55	08.94-06.00	4HD/4HA			LK 016
2.5 TD (EBL, EDL, EDS, EGL, ESL, ESS, EUS)	2.5	63	01.95-03.00	4GF/4GB/4GC /4GA/4GE/4GD			LK 016
2.5 TD (EBS, EBL, ECL, EDS, EDL, ESS, EUS)	2.5	63	10.92-07.94	4GB/4GC /4GA			LK 017
2.5 TD (ECL, EDL, EDS, ESL, ESS, EUS)	2.5	74	07.94-03.00	4EB/4EC			LK 016
2.5 TD (ECL, EDS, EDL, EGL, ESS, EUS)	2.5	74	09.91-07.94	4EA			LK 017
TRANSIT Bus (FD_, FB_, FS_, FZ_, FC_)							
2.4 DI [RWD] (F_B_, F_C_)	2.4	55	01.00-05.06	F4FA			LKK 001
2.4 DI (F_B_, F_C_, F_A_)	2.4	66	01.00-05.06	D2FA/D2FB/D2FE			LKK 001
2.4 DI [RWD] (F_B_, F_C_, F_A_)	2.4	88	01.00-05.06	D4FA			LKK 001
2.4 TDCi	2.4	101	03.04-05.06	H9FA			LKK 001
2.4 TDE	2.4	85	03.04-05.06	FXFA			LKK 001
2.4 TDE (F_C_, F_B_, F_A_)	2.4	92	07.01-05.06	DOFA			LKK 001
TRANSIT Bus (T_)							
2.5 D (TBS, TCL, TCS, TEL, TES)	2.5	50	12.85-01.89	4AB		→ Ford 79GB-8A61-6A1C	LK 013
						→ Ford 6176701	LK 017
						→ Ford 88VB-8A61-6AA	LK 017
2.5 D (TBS, TEL, TES)	2.5	52	09.88-09.92	4BA/4CA/4AB		→ Ford 79GB-8A61-6A1C	LK 013
						→ Ford 6176701	LK 017
						→ Ford 88VB-8A61-6AA	LK 017

HYUNDAI

ACCENT (LC)							
1.3	1.3	55	01.00-	G4E-A			LE 544
1.3	1.3	62	08.02-				LE 544
1.3	1.3	63	01.00-	G4E-A			LE 544
1.5	1.5	66	01.00-	G4EB			LE 544
1.5	1.5	75	09.00-	G4EC-G			LE 544
1.5 CRDi	1.5	60	04.02-	D3-EA			LE 546
1.6	1.6	77	12.02-	G4ED-G			LE 544
ACCENT (X-3)							
1.3	1.3	44	10.94-01.00	G4EH			LE 540
1.3	1.3	55	10.94-01.00	G4EH			LE 540
1.3 i 12V	1.3	62	10.94-01.00	G4EH			LE 540
1.5 i 12V	1.5	65	10.94-01.00	G4EK			LE 540
1.5 i 16V	1.5	73	12.95-01.00	G4ER			LE 540
ACCENT Stufenheck (LC)							
1.3	1.3	55	01.00-	G4E-A			LE 544
1.3	1.3	63	01.00-	G4E-A			LE 544
1.5 CRDi	1.5	60	01.02-	D3-EA			LE 546

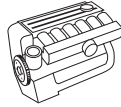

kW

HYUNDAI
ACCENT Stufenheck (LC)

 1.6 1.6 77 12.02- G4ED-G **LE 544**
ACCENT Stufenheck (X-3)

 1.3 1.3 44 10.94-01.00 G4EH **LE 540**

 1.3 1.3 55 10.94-01.00 G4EH **LE 540**

 1.3 i 12V 1.3 62 10.94-01.00 G4EH **LE 540**

 1.5 i 12V 1.5 65 10.94-01.00 G4EK **LE 540**

 1.5 i 16V 1.5 73 10.95-01.00 G4ER **LE 540**
ATOS (MX)

 1.0 i 1.0 40 02.98-03.02 G4HC **LE 543**

 1.0 i 1.0 43 03.01- G4HC-E **LE 543**
COUPE (RD)

 1.6 16V 1.6 85 03.98-04.02 G4GR **LE 542**

 1.6 i 16V 1.6 84 12.96-04.02 4G61 **LE 542**

 2.0 16V 2.0 99 03.01-04.02 G4DF **LE 542**

 2.0 16V 2.0 102 08.96-04.02 G4GF **LE 542**
GETZ (TB)

 1.1 1.1 46 09.02- G4HD **LE 538**

 1.3 1.3 60 09.02- G4E-A **LE 538**

 1.3 1.3 63 09.03- G4E-A **LE 538**

 1.5 CRDi 1.5 60 03.03- D3-EA **LE 538**

 1.5 CRDi 1.5 65 08.05- **LE 538**

 1.5 CRDi GLS 1.5 81 08.05- D4FA **LE 538**

 1.6 1.6 77 09.02- G4ED-G **LE 538**
LANTRA II (J-2)

 1.5 12V 1.5 65 12.96-09.00 G4EK **LE 542**

 1.6 16V 1.6 84 11.95-09.00 4G61 **LE 542**

 1.6 i 1.6 66 11.95-09.00 G4GR **LE 542**

 1.8 16V 1.8 94 11.95-09.00 G4GM **LE 542**

 2.0 16V 2.0 102 08.96-09.00 G4GF **LE 542**
LANTRA II Wagon (J2)

 1.5 12V 1.5 65 04.97- G4EK **LE 542**

 1.6 16V 1.6 84 02.96- 4G61 **LE 542**

 1.6 i 1.6 66 02.96- G4GR **LE 542**

 1.8 16V 1.8 94 02.96- G4GM **LE 542**

 2.0 16V 2.0 102 12.96- G4GF **LE 542**
MATRIX (FC)

 1.5 CRDi 1.5 60 10.01- D3-EA **LE 546**

 1.5 CRDi 1.5 75 12.04- D4FA **LE 546**

 1.5 CRDi VGT 1.5 81 08.05- D4FA **LE 546**

 1.6 1.6 76 06.01- G4ED-G **LE 539**

 1.8 1.8 90 06.01- G4GB-G **LE 539**
SANTA FÉ (CM)

 2.2 CRDi 2.2 102 03.06- **LE 545**

 2.2 CRDi 2.2 114 03.06- D4EB **LE 545**

 2.2 CRDi GLS 2.2 110 03.06- D4EB **LE 545**

 2.7 2.7 125 03.06- **LE 545**

 2.7 V6 GLS 2.7 139 03.06- G6EA **LE 545**
SANTA FÉ (SM)

 2.0 2.0 99 08.01- G4BP **LE 541**

 2.0 CRDi 2.0 83 08.01- D4EA **LE 541**

 2.4 16V 2.4 100 02.01- G4JS-G **LE 541**

 2.4 16V 2.4 107 02.01- G4JS-G **LE 541**

 2.7 V6 4x4 2.7 127 02.01- G6BA-G **LE 541**
SONATA IV (EU4)

 2.7 V6 2.7 127 10.01-11.04 G6BA-G **LE 547**
XG

 25 2.5 120 12.98- **LE 547**

 30/300 3.0 138 12.98- G6CT-G **LE 547**

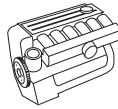
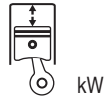

JEEP

CHEROKEE (KJ)

2.5 CRD	2.5	105	09.01-	R 425 DOHC	1)	LE 031	
---------	-----	-----	--------	------------	----	--------	--

KIA

CARENS II (FJ)

2.0 CRDi	2.0	83	07.02-	D4EA		LE 548	
2.0 CRDi	2.0	103	11.05-	D4EA		LE 548	

MAGENTIS (GD)

2.5 V6	2.5	124	05.01-			LE 547	
--------	-----	-----	--------	--	--	--------	--

LANCIA

MUSA

1.4	1.4	57	09.05-	350 A1.000		LE 550	
1.4	1.4	70	10.04-	843 A 1.000		LE 550	

Y (840A)

1.1 (840AE)	1.1	40	11.95-09.03	176 B2.000		LE 514	
1.2 (840AA, 840AF1A)	1.2	44	01.00-09.03	840 A3.000/188 A4.000		LE 549	
1.2 16V (840AD)	1.2	63	01.00-09.03	176 B9.000		LE 549	
1.2 16V (840AG1A)	1.2	59	10.00-09.03	188 A5.000		LE 549	
1.4 12V (840AB)	1.4	59	01.00-09.03	840 A2.000		LE 549	
1.4 12V (840AC)	1.4	55	01.00-09.03	840 A4.000		LE 549	

YPSILON

1.2	1.2	44	10.03-	188 A4.000		LE 551	
1.2	1.2	59	10.03-	188 A5.000		LE 551	
1.4	1.4	57	02.06-	350 A1.000		LE 550	
1.4 16V	1.4	70	10.03-	843 A 1.000		LE 550	

LANDROVER

DEFENDER (LD)

2.5 Td5 4WD	2.5	90	06.98-			LK 026	
-------------	-----	----	--------	--	--	--------	--

DEFENDER Station Wagon (LD)

3.9 V8	3.9	136	11.98-				LR 016
--------	-----	-----	--------	--	--	--	--------

DISCOVERY I (LJ, LG)

3.9 V8	3.9	134	09.93-10.98	36 D/35 D			LR 016
--------	-----	-----	-------------	-----------	--	--	--------

DISCOVERY II (LJ, LT)

4.0 V8	4.0	136	11.98-06.04				LR 016
--------	-----	-----	-------------	--	--	--	--------

DISCOVERY III (TAA)

5.0 V8	5.0	375	09.09-				LR 016
--------	-----	-----	--------	--	--	--	--------

MERCEDES-BENZ

190 (W201)

2.0 (201.023)	2.0	75	01.86-05.90	M 102.924			LE 557
2.0 (201.023)	2.0	77	09.84-05.90	M 102.924			LE 557
D 2.0 (201.122)	2.0	53	08.83-08.89	OM 601.911			LE 557
D 2.0 (201.122)	2.0	55	08.89-08.93	OM 601.911			LE 557
D 2.5 (201.126)	2.5	66	04.85-08.93	OM 602.911			LE 555
						LK 045	
D 2.5 (201.126)	2.5	69	08.89-08.93	OM 602.911			LE 555
						LK 045	
E 1.8 (201.018)	1.8	80	04.90-08.93	M 102.910			LE 553
E 2.0	2.0	87	01.85-08.93	M 102.962			LE 557
E 2.0 (201.024)	2.0	83	02.85-12.86	M 102.961/M 102.962			LE 555
E 2.0 (201.024)	2.0	85	02.85-12.86	M 102.962			LE 555
E 2.0 (201.024)	2.0	90	10.82-06.93	M 102.961/M 102.962			LE 555
E 2.3 (201.028)	2.3	100	10.86-08.93	M 102.985			LE 555
E 2.6	2.6	122	09.86-12.89	M 103.942			LE 557
E 2.6	2.6	122	09.86-12.89	M 103.942	Mot.Nr. 62 010 349 →	LK 035	
					Mot.Nr. 60 007 451 →	LK 035	
						LK 052	



kW

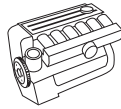

MERCEDES-BENZ

190 (W201)

E 2.6 (201.029)	2.6	118	09.86-08.93	M 103.942			LE 557
E 2.6 (201.029)	2.6	118	09.86-08.93	M 103.942	Mot.Nr. 62 010 349 →	LK 035	
					Mot.Nr. 60 007 451 →	LK 035	
						LK 052	
Turbo-D 2.5 (201.128)	2.5	90	02.88-08.93	OM 602.961			LE 557
Turbo-D 2.5 (201.128)	2.5	93	02.88-08.93	OM 602.961			LE 557

CABRIOLET (A124)

300 CE-24 (124.061)	3.0	162	04.92-06.93	M 104.980			LE 013
							LK 037

C-KLASSE (W202)

C 180 (202.018)	1.8	89	11.94-05.00	M 111.921	↔ rechts	LE 014	
					↔ links		LE 554
C 180 (202.018)	1.8	90	03.93-05.00	M 111.921/M 111.920	↔ rechts	LE 014	
					↔ links		LE 554
						LK 038	
C 200 (202.020)	2.0	100	01.94-05.00	M 111.945/M 111.941	↔ rechts	LE 014	
					↔ links		LE 554
						LK 038	
C 200 D (202.120)	2.0	55	03.93-05.00	OM 601.913	↔ rechts	LE 014	
					↔ links		LE 554
						LK 046	
C 200 D (202.122)	2.0	65	10.96-05.00	OM 604.915	↔ rechts	LE 014	
					↔ links		LE 554
						LK 046	
C 200 Kompressor (202.025)	2.0	132	10.95-05.00	M 111.944	↔ rechts	LE 014	
					↔ links		LE 554
						LK 038	
C 200 Kompressor (202.025)	2.0	141	11.96-05.00	M 111.944	↔ rechts	LE 014	
					↔ links		LE 554
						LK 038	
C 220 (202.022)	2.2	110	03.93-05.00	M 111.961	↔ rechts	LE 014	
					↔ links		LE 554
						LK 038	
C 220 D	2.2	55	07.96-05.00	OM 604.910		LK 046	
C 220 D (202.121)	2.2	70	08.93-05.00	OM 604.910	↔ rechts	LE 014	
					↔ links		LE 554
						LK 046	
C 230 Kompressor (202.024)	2.3	142	10.95-05.00	M 111.975	↔ rechts	LE 014	
					↔ links		LE 554
						LK 038	
C 230	2.3	110	06.96-06.97	M 111.974		LK 038	
C 240 (202.026)	2.4	125	06.97-05.00	M 112.910	↔ rechts	LE 014	
					↔ links		LE 554
						LK 060	
C 250 D (202.125)	2.5	83	05.93-05.00	OM 605.910	↔ rechts	LE 014	
					↔ links		LE 554
						LK 045	
C 250 Turbo-D (202.128)	2.5	110	10.95-05.00	OM 605.960	↔ rechts	LE 014	
					↔ links		LE 554
C 280 (202.028)	2.8	142	05.93-05.00	M 104.941	↔ rechts	LE 014	
					↔ links		LE 554
						LK 037	
C 280 (202.029)	2.8	145	06.97-05.00	M 112.920	↔ rechts	LE 014	
					↔ links		LE 554
						LK 060	
C 36 AMG (202.028)	3.6	206	05.94-05.00	M 104.941 (AMG 3.6)	↔ rechts	LE 014	
					↔ links		LE 554
						LK 037	



¹⁾ Mit Klimaanlage

²⁾ Mit Anhängervorrichtung

³⁾ Für tropisches Klima

⁴⁾ Automatik

⁵⁾ Schaltgetriebe

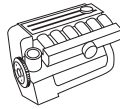
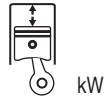

MERCEDES-BENZ

C-KLASSE (W202)

C 43 AMG (202.033)	4.3	225	08.97-05.00	M 113.944	↔ rechts	LE 014	
					↔ links		LE 554
						LK 060	

C-KLASSE Kombi (S202)

C 180 T (202.078)	1.8	90	06.96-09.00	M 111.921/M 111.920	↔ rechts	LE 014	
					↔ links		LE 554
						LK 038	
C 200 T (202.080)	2.0	100	06.96-03.01	M 111.945/M 111.941	↔ rechts	LE 014	
					↔ links		LE 554
						LK 038	
C 200 T D (202.180)	2.0	65	10.96-03.01	OM 604.915		LK 046	
C 200 T Kompressor (202.082)	2.0	141	11.96-03.01	M 111.944		LK 038	
C 220 T D	2.2	55	06.96-03.01	OM 604.910		LK 046	
C 220 T D (202.182)	2.2	70	06.96-09.98	OM 604.910		LK 046	
C 230 T Kompressor (202.085)	2.3	142	06.97-09.00	M 111.975		LK 038	
C 240 T (202.086)	2.4	125	06.97-09.00	M 112.910	↔ rechts	LE 014	
					↔ links		LE 554
						LK 060	
C 240 T (202.088)	2.6	125	09.00-03.01	M 112.915		LK 060	
C 280 T (202.089)	2.8	145	06.97-03.01	M 112.920	↔ rechts	LE 014	
					↔ links		LE 554
						LK 060	
C 43 AMG (202.093)	4.3	225	08.97-03.01	M 113.944		LK 060	

CLK (C208)

200 (208.335)	2.0	100	06.97-06.02	M 111.945/M 111.941		LK 038	
200 Kompressor (208.345)	2.0	141	06.97-06.00	M 111.944	↔ rechts	LE 014	
					↔ links		LE 554
						LK 038	
230 Kompressor (208.347)	2.3	142	06.97-06.00	M 111.975/M 111.973	↔ rechts	LE 014	
					↔ links		LE 554
						LK 038	
230 Kompressor (208.348)	2.3	145	06.00-06.02	M 111.982		LE 034	
430 (208.370)	4.3	205	07.98-06.02	M 113.943	↔ rechts	LE 014	
					↔ links		LE 554
					Chassis F198564 →	LK 060	
					Chassis T102653 →	LK 060	
55 AMG (208.374)	5.5	255	08.99-06.02	M 113.981/M 113.984	↔ rechts	LE 014	
					↔ links		LE 554
55 AMG (208.374)	5.5	255	08.99-06.02	M 113.984	Chassis F198564 →	LK 060	

CLK Cabriolet (A208)

200 (208.435)	2.0	100	03.98-03.02	M 111.945/M 111.941		LK 038	
200 Kompressor (208.445)	2.0	141	03.98-06.00	M 111.944	↔ rechts	LE 014	
					↔ links		LE 554
						LK 038	
230 Kompressor (208.447)	2.3	142	03.98-06.00	M 111.975/M 111.973	↔ rechts	LE 014	
					↔ links		LE 554
						LK 038	
430 (208.470)	4.3	205	09.98-03.02	M 113.943	↔ rechts	LE 014	
					↔ links		LE 554
					Chassis F198564 →	LK 060	
					Chassis T102653 →	LK 060	

COUPE (C124)

220 CE (124.042)	2.2	110	10.92-05.93	M 111.960			LE 553
						LK 038	
230 CE (124.043)	2.3	100	03.87-12.92	M 102.982			LE 555



kW

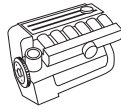

MERCEDES-BENZ

COUPE (C124)

230 CE (124.043)	2.3	97	03.87-12.92	M 102.982			LE 555
230 CE (124.043) KAT	2.3	97	06.89-12.92	M 102.982			LE 555
300 CE	3.0	138	03.87-12.89	M 103.983		LK 037	
300 CE (124.050)	3.0	132	03.87-05.93	M 103.983			LE 555
						LK 037	
300 CE-24 (124.051)	3.0	162	09.89-12.92	M 104.980		LE 013	
					1)	LK 053	
320 CE (124.052)	3.2	162	10.92-05.93	M 104.992		LE 013	
					1)	LK 053	

E-KLASSE (W124)

E 200 (124.019)	2.0	100	06.93-06.95	M 111.940			LE 553
						LK 038	
E 200 D (124.120)	2.0	55	06.93-06.95	OM 601.912			LE 555
						LK 045	
E 220 (124.022)	2.2	110	06.93-06.95	M 111.960			LE 553
						LK 038	
E 250 D (124.126, 124.129)	2.5	83	07.93-06.95	OM 605.911			LE 555
						LK 045	
E 250 Turbo-D (124.128)	2.5	93	06.93-06.95	OM 602.962			LE 555
E 280 (124.028)	2.8	145	06.93-06.95	M 104.942		LE 013	
						LK 037	
E 300 4-matic (124.230)	3.0	132	06.93-06.95	M 103.985			LE 555
						LK 037	
E 300 D (124.131)	3.0	100	07.93-06.95	OM 606.910			LE 555
						LK 045	
E 300 Turbo-D (124.133)	3.0	108	06.93-06.95	OM 603.960			LE 555
E 300 Turbo-D 4-matic (124.333)	3.0	108	06.93-06.95	OM 603.963			LE 555
E 320 (124.032)	3.2	162	06.93-06.95	M 104.992		LE 013	
						LK 037	
E 420 (124.034)	4.2	205	06.93-06.95	M 119.975		LE 013	
						LK 043	
E 500 (124.036)	5.0	235	06.93-06.95	M 119.974		LE 013	
						LK 043	
E 60 AMG (124.036)	6.0	280	05.94-06.95			LE 013	

E-KLASSE (W210)

E 200 (210.035)	2.0	100	06.95-08.00	M 111.942		↔ rechts	LE 014
						↔ links	LE 554
E 200 D (210.003)	2.0	65	01.96-03.02	OM 604.917			LK 046
E 220 D	2.2	55	05.96-03.02	OM 604.912			LK 046
E 220 D (210.004)	2.2	70	06.95-07.99	OM 604.912			LK 046
E 230 (210.037)	2.3	110	06.95-06.97	M 111.970		↔ rechts	LE 014
						↔ links	LE 554
E 240 (210.061)	2.4	125	06.97-08.00	M 112.911			LE 552
					Chassis X065665 →		LK 060
					Chassis B438527 →		LK 060
E 250 D (210.010)	2.5	83	06.95-07.99	OM 605.912			LK 045
E 280 (210.053)	2.8	142	01.96-06.97	M 104.945			LK 054
E 280 (210.063)	2.8	150	12.96-03.02	M 112.921			LE 552
					Chassis B438527 →		LK 060
					Chassis X065665 →		LK 060
E 290 Turbo-D (210.017)	2.9	95	03.96-07.99	OM 602.982			LK 045
E 300 D (210.020)	3.0	100	06.95-06.97	OM 606.912			LK 045
E 300 Turbo-D (210.025)	3.0	130	12.96-07.99	OM 606.962			LK 047
E 320 (210.055)	3.2	162	06.95-06.97	M 104.995			LK 054



1) Mit Klimaanlage

2) Mit Anhängervorrichtung

3) Für tropisches Klima

4) Automatik

5) Schaltgetriebe

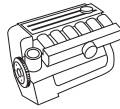
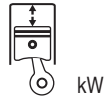

MERCEDES-BENZ

E-KLASSE (W210)

E 320 (210.065)	3.2	165	06.97-03.02	M 112.941				LE 552
					Chassis B438527 →	LK 060		
					Chassis X065665 →	LK 060		
E 430 (210.070)	4.3	205	06.97-03.02	M 113.940				LE 552
E 55 AMG (210.074)	5.4	260	08.97-03.02	M 113.980				LE 552
E-KLASSE Cabriolet (A124)								
E 200 (124.060)	2.0	100	06.93-03.98	M 111.940			LK 038	
E 220 (124.062)	2.2	110	06.93-03.98	M 111.960				LE 553
E 320 (124.066)	3.2	162	06.93-03.98	M 104.992/M 104.995			LK 038	
							LE 013	
							LK 037	
E 36 AMG (124.066)	3.6	200	05.94-03.98	M 104.992 (AMG 3.6)			LE 013	
							LK 037	
E-KLASSE Coupe (C124)								
E 200 (124.040)	2.0	100	06.93-06.97	M 111.940				LE 553
							LK 038	
E 220 (124.042)	2.2	110	06.93-06.97	M 111.960				LE 553
							LK 038	
E 320 (124.052)	3.2	162	06.93-06.97	M 104.992			LE 013	
							LK 037	
E 36 AMG (124.052)	3.6	200	05.94-06.97	M 104.992 (AMG 3.6)			LE 013	
							LK 037	
E 36 AMG (124.052)	3.6	195	06.93-04.95	M 104.992 (AMG 3.6)			LE 013	
							LK 037	
E-KLASSE Kombi (S124)								
E 200 T (124.079)	2.0	100	06.93-06.96	M 111.940				LE 553
							LK 038	
E 220 T (124.082)	2.2	110	06.93-06.96	M 111.960				LE 553
							LK 038	
E 250 T D (124.186)	2.5	83	06.93-06.96	OM 605.911				LE 555
							LK 045	
E 280 T (124.088)	2.8	142	06.93-06.96	M 104.942			LE 013	
							LK 037	
E 280 T (124.088)	2.8	145	06.93-06.96	M 104.942			LE 013	
							LK 037	
E 280 T (124.088)	2.8	145	06.93-06.95	M 104.942			LK 052	
E 300 T 4-matic (124.290)	3.0	132	06.93-06.96	M 103.985				LE 555
							LK 037	
E 300 T D (124.191)	3.0	100	06.93-06.96	OM 606.910				LE 555
							LK 045	
E 300 T Turbo-D (124.193)	3.0	108	06.93-06.96	OM 603.960				LE 555
E 300 T Turbo-D 4-matic (124.393)	3.0	108	06.93-06.96	OM 603.963				LE 555
E 300 TE-24 AMG (124.091)	3.0	162	06.93-06.96	M 104.980			LE 013	
E 320 T (124.092)	3.2	162	06.93-06.96	M 104.992			LE 013	
							LK 037	
E 36 T AMG (124.092)	3.6	200	05.94-06.96	M 104.992 (AMG 3.6)			LE 013	
							LK 037	
E-KLASSE Kombi (S210)								
E 200 T (210.235)	2.0	100	06.96-08.00	M 111.942		↔ rechts	LE 014	
					1) ↔ links			LE 554
					1)		LK 038	
E 230 T (210.237)	2.3	110	06.96-06.97	M 111.970		↔ rechts	LE 014	
					1) ↔ links			LE 554
					1)		LK 038	



kW

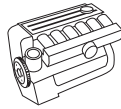

MERCEDES-BENZ

E-KLASSE Kombi (S210)

E 240 T (210.261)	2.4	125	06.97-03.03	M 112.911			LE 552
					Chassis X065665 →	LK 060	
					Chassis B438527 →	LK 060	
E 250 T D (210.210)	2.5	83	06.96-07.99	OM 605.912		LK 045	
E 280 T (210.263)	2.8	150	12.96-03.03	M 112.921	Chassis X065665 →	LK 060	
					Chassis B438527 →	LK 060	
E 280 T 4-matic (210.281)	2.8	150	12.96-03.03	M 112.921			LE 552
					Chassis X065665 →	LK 060	
					Chassis B438527 →	LK 060	
E 290 T Turbo-D (210.217)	2.9	95	06.96-07.99	OM 602.982		LK 045	
E 300 T Turbo-D (210.225)	3.0	130	12.96-07.99	OM 606.962		LK 047	
E 320 T (210.265)	3.2	165	12.96-03.03	M 112.941			LE 552
					Chassis X065665 →	LK 060	
					Chassis B438527 →	LK 060	
E 430 T (210.270)	4.3	205	06.97-03.03	M 113.940			LE 552
E 55 T AMG (210.274)	5.4	260	08.97-03.03	M 113.980			LE 552
G-KLASSE (W460)							
300 GD (460.3)	3.0	83	03.79-07.93	OM 603.912		LK 045	
G-KLASSE (W463)							
300 GE (463)	3.0	128	06.90-	M 103.987	463.227/228	LK 036	
300 GE (463.227, 463.228)	3.0	125	06.90-	M 103.987	463.227/228	LK 036	
G 270 CDI (463.322, 463.323)	2.7	115	10.01-	OM 612.966			LE 557
G 320 (463.230, 463.231)	3.2	155	09.94-12.97	M 104.996		LK 036	
G 320 (463.232, 463.233)	3.2	158	07.97-	M 112.945	→ Chassis 110196	LK 060	
G 36 AMG	3.6	200	01.95-	M104.996	463.208	LK 036	
G 500 E (463.228)	5.0	177	09.93-	M 117.965	463.228	LK 041	
G-KLASSE Geländewagen offen (W463)							
320 GE (463.208)	3.2	155	09.94-11.97	M 104.996	Chassis X127404 →	LK 036	
G 320 (463.209)	3.2	158	11.97-	M 112.945	→ Chassis 110196	LK 060	
KOMBI Kombi (S124)							
200 T (124.080)	2.0	77	01.86-05.90	M 102.922			LE 555
200 T (124.080)	2.0	80	09.85-08.89	M 102.922			LE 555
200 T D (124.180)	2.0	53	09.85-08.91	OM 601.912			LE 555
						LK 045	
200 T D (124.180)	2.0	55	09.88-08.91	OM 601.912			LE 555
						LK 045	
200 TE (124.081)	2.0	87	09.88-08.92	M 102.963			LE 555
200 TE (124.079)	2.0	100	10.92-06.93	M 111.940			LE 553
						LK 038	
220 TE (124.082)	2.2	110	10.92-05.93	M 111.960			LE 553
						LK 038	
230 TE (124.083)	2.3	97	09.85-08.92	M 102.982			LE 555
230 TE (124.083) KAT	2.3	97	06.89-08.92	M 102.982			LE 555
230 TE (124.083)	2.3	100	09.85-08.92	M 102.982			LE 555
250 T D (124.185)	2.5	66	09.85-06.93	OM 602.912			LE 555
						LK 045	
250 T D (124.185)	2.5	69	01.89-06.93	OM 602.912			LE 555
						LK 045	
250 TD Turbo (124.128)	2.5	93	03.88-07.93	OM 602.962			LE 555



kW

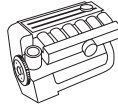

MERCEDES-BENZ

KOMBI Kombi (S124)

280 TE (124.088)	2.8	145	10.92-06.93	M 104.942		LE 013	
						LK 037	
300 T D (124.190)	3.0	80	09.86-06.93	OM 603.912			LE 555
						LK 045	
300 T D (124.190)	3.0	81	01.89-06.93	OM 603.912			LE 555
						LK 045	
300 T D (124.190)	3.0	83	01.89-06.93	OM 603.912			LE 555
						LK 045	
300 T Turbo-D (124.193)	3.0	108	01.89-06.93	OM 603.960			LE 555
300 T Turbo-D 4-matic (124.393)	3.0	105	09.86-01.89	OM 603.963			LE 555
300 TE (124.090)	3.0	132	01.86-08.92	M 103.983			LE 555
						LK 037	
300 TE (124.090)	3.0	138	01.86-12.89	M 103.983			LE 555
						LK 037	
300 TE 4-matic (124.290)	3.0	132	09.86-06.93	M 103.985			LE 555
						LK 037	
300 TE-24 (124.091)	3.0	162	09.89-08.92	M 104.980		LE 013	
						LK 037	
320 TE (124.092)	3.2	162	10.92-06.93	M 104.992		LE 013	
						LK 037	
350 SE,SEL (116.028, 116.029)	3.5	143	03.76-03.80	M 116.985		LK 040	
350 SE,SEL (116.028, 116.029)	3.5	147	08.72-02.76	M 116.983		LK 040	
350 SE,SEL (116.028, 116.029)	3.5	151	03.76-03.80	M 116.985		LK 040	
450 SE,SEL (116.032)	4.5	165	01.73-04.80	M 117.983/M 117.986		LK 040	
450 SE,SEL (116.033)	4.5	160	12.75-04.80	M 117.986		LK 040	
S-KLASSE (W126)							
260 SE (126.020)	2.6	118	09.85-06.91	M 103.941			LE 555
						LK 037	
260 SE (126.020)	2.6	122	09.85-06.91	M 103.941			LE 555
						LK 037	
300 SE,SEL (126.024, 126.025)	3.0	132	01.86-06.91	M 103.981			LE 555
						LK 037	
300 SE,SEL (126.024, 126.025)	3.0	138	09.85-12.89	M 103.981			LE 555
						LK 037	
380 SE,SEL (126.032)	3.8	150	12.79-08.85	M 116.963			LE 555
380 SE,SEL (126.032)	3.8	160	12.85-12.86	M 116.961			LE 555
						LK 058	
420 SE,SEL	4.2	165	10.85-06.91	M 116.965		LK 041	
420 SE,SEL	4.2	170	10.85-12.87	M 116.965		LK 041	
420 SE,SEL (126.034)	4.2	150	10.85-06.91	M 116.965			LE 555
						LK 041	
420 SE,SEL (126.034)	4.2	160	10.85-12.87	M 116.965			LE 555
						LK 041	
500 SE,SEL	5.0	185	09.87-06.91	M 117.965		LK 041	
500 SE,SEL	5.0	195	09.87-06.91	M 117.965		LK 041	
500 SE,SEL (126.036)	5.0	164	09.85-06.91	M 117.965			LE 555
					AMG	LK 041	
500 SE,SEL (126.036)	5.0	170	12.79-08.85	M 117.961/M 117.963			LE 555
500 SE,SEL (126.036)	5.0	170	12.79-08.85	M 117.961	Mot.Nr. 001681	LK 040	
					Mot.Nr. 001682 →	LK 058	
500 SE,SEL (126.036)	5.0	177	12.79-08.85	M 117.961/M 117.963			LE 555
500 SE,SEL (126.036)	5.0	177	12.79-08.85	M 117.961	Mot.Nr. 001681	LK 040	
					Mot.Nr. 001682 →	LK 058	
500 SE,SEL (126.036)	5.0	180	09.85-06.91	M 117.965			LE 555
					AMG	LK 041	
500 SE,SEL KAT	5.0	185	06.89-06.91	M 117.965	AMG	LK 041	
560 SE,SEL	5.6	205	08.87-06.91	M 117.968	AMG	LK 041	
560 SE,SEL	5.6	220	10.85-06.91	M 117.968	AMG	LK 041	
560 SE,SEL (126.038)	5.6	178	10.85-06.91	M 117.968			LE 555
					AMG	LK 041	



kW

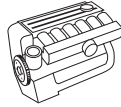

MERCEDES-BENZ

S-KLASSE (W126)

560 SE,SEL (126.038) 5.6 200 10.85-12.87 M 117.968

AMG

LK 041 LE 555

S-KLASSE (W140)

3.2 3.2 162 10.95-08.98 M 104.990

LK 054

300 SE 2.8 (140.028) 2.8 145 01.93-10.98 M 104.944

LK 054

300 SE,SEL/S320 (140.032, 140.033) 3.2 170 03.91-10.98 M 104.990/M 104.994

LK 054

400 SE,SEL/S420 (140.042, 140.043) 4.2 210 02.91-10.98 M 119.971

LK 042

500 SE,SEL (140.050, 140.051) 5.0 240 02.91-10.98 M 119.970

LK 042

600 SE,SEL (140.056, 140.057) 6.0 300 04.91-12.92 M 120.980

LK 044

S 280 (140.028) 2.8 142 02.93-10.98 M 104.944

LK 054

S 420 (140.042) 4.2 205 01.93-10.98 M 119.971

LK 042

S 500 (140.050, 140.051) 5.0 235 01.93-10.98 M 119.970/M 119.980

LK 042

S 600 (140.056, 140.057) 6.0 290 01.93-10.98 M 120.982/M 120.980

LK 044

S-KLASSE Coupe (C126)

380 SEC (126.043) 3.8 150 10.81-07.85 M 116.963

LK 041

420 SEC (126.046) 4.2 150 10.85-06.91 M 116.965

LE 555

LK 041

420 SEC (126.046) 4.2 160 10.85-12.87 M 116.965

LE 555

LK 041

420 SEC (126.046) 4.2 165 10.85-06.91 M 116.965

LE 555

LK 041

500 SEC (126.044) 5.0 164 10.85-06.91 M 117.965

LE 555

AMG

LK 041

500 SEC (126.044) 5.0 170 10.81-08.85 M 117.963

LE 555

LK 041

500 SEC (126.044) 5.0 180 09.85-06.91 M 117.965

LE 555

AMG

LK 041

500 SEC (126.044) 5.0 185 08.87-06.91 M 117.965

LE 555

AMG

LK 041

500 SEC (126.044) 5.0 195 09.85-06.91 M 117.965

AMG

LK 041

500 SEC KAT 5.0 185 06.89-06.91 M 117.965

AMG

LK 041

560 SEC (126.045) 5.6 178 10.85-06.91 M 117.968

LE 555

AMG

LK 041

560 SEC (126.045) 5.6 200 10.85-12.87 M 117.968

LE 555

AMG

LK 041

560 SEC (126.045) 5.6 205 10.85-06.91 M 117.968

LE 555

AMG

LK 041

560 SEC (126.045) 5.6 220 10.85-12.89 M 117.968

LE 555

AMG

LK 041

S-KLASSE Coupe (C140)

SEC/CL 420 (140.063) 4.2 205 10.94-02.99 M 119.971/M 119.981

LK 042

SEC/CL 500 (140.070) 5.0 235 10.92-02.99 M 119.970

LK 042

SEC/CL 600 (140.076) 6.0 290 09.92-02.99 M 120.982/M 120.980

LK 044

SL (R107)

350 SL (107.043) 3.5 143 05.71-02.80 M 116.982/M 116.984

LK 040

380 SL (107.045) 3.8 160 09.80-08.81 M 116.960

LK 058

380 SL (107.045) 3.8 150 09.80-08.85 M 116.962

LK 041

420 SL (107.047) 4.2 150 01.86-08.89 M 116.964

LK 041

420 SL (107.047) 4.2 160 01.86-08.89 M 116.964

LK 041

450 SL (107.044) 4.5 160 09.75-10.80 M 117.985/M 117.982

LK 040

450 SL (107.044) 4.5 165 10.72-10.80 M 117.985/M 117.982

LK 040

500 SL (107.046) 5.0 164 01.86-08.89 M 117.964

AMG

LK 041

500 SL (107.046) 5.0 170 05.80-12.85 M 117.960

Mot.Nr. 001681

LK 040

Mot.Nr. 001682 →

LK 058

500 SL (107.046) 5.0 177 05.80-12.81 M 117.960

Mot.Nr. 001681

LK 040

Mot.Nr. 001682 →

LK 058

500 SL (107.046) 5.0 180 01.86-08.89 M 117.960

Mot.Nr. 001681

LK 040

Mot.Nr. 001682 →

LK 058

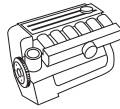
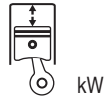

MERCEDES-BENZ

SL (R129)							
280 (129.058)	2.8	142	08.93–10.01	M 104.943			LE 556
						LK 054	
280 (129.059)	2.8	150	05.98–10.01	M 112.923/M 112.925			LE 556
						LK 060	
300 SL (129.060)	3.0	140	03.89–08.93	M 103.984			LE 556
						LK 054	
300 SL-24 (129.061)	3.0	170	03.89–07.93	M 104.981			LE 556
						LK 054	
320 (129.063)	3.2	170	09.93–10.01	M 104.991			LE 556
						LK 054	
320 (129.064)	3.2	165	05.98–10.01	M 112.943			LE 556
						LK 060	
500 (129.067)	5.0	235	09.92–10.01	M 119.982/M 119.972			LE 556
500 (129.068)	5.0	225	05.98–10.01	M 113.961			LE 556
500 SL (129.066)	5.0	240	09.89–08.92	M 119.960/M 119.972			LE 556
						LK 042	
600 (129.076)	6.0	290	07.92–10.01	M 120.983/M 120.981			LK 044
SL Coupe (C107)							
350 SLC (107.023)	3.5	143	03.76–02.80	M 116.982/M 116.984			LK 040
350 SLC (107.023)	3.5	147	01.72–02.76	M 116.982/M 116.984			LK 040
380 SLC (107.025)	3.8	160	07.80–08.81	M 116.960			LK 058
450 SLC (107.024)	4.5	160	09.75–08.79	M 117.985/M 117.982			LK 040
450 SLC (107.024)	4.5	165	01.73–11.75	M 117.985/M 117.982			LK 040
450 SLC 5.0 (107.026)	5.0	177	06.78–02.80	M 117.960	Mot.Nr. 001681		LK 040
					Mot.Nr. 001682 →		LK 058
SLK (R170)							
200 Kompressor	2.0	141	10.96–03.00	M 111.943			LK 038
200	2.0	100	09.96–03.00	M 111.946			LK 038
230 Kompressor	2.3	142	09.96–03.00	M 111.973			LK 038
SPRINTER 2-t (901, 902)							
208 CDI	2.1	60	04.00–05.06	OM 611.987			LE 553
208 D	2.3	58	02.95–04.00	OM 601.943			LE 553
						LK 050	
210 D	2.9	75	03.97–04.00	OM 602.980	Chassis P649732 →		LK 051
212 D	2.9	90	02.95–04.00	OM 602.980	Chassis P649732 →		LK 051
213 CDI	2.1	95	04.00–05.06	OM 611.981			LE 553
214	2.3	105	02.95–05.06	M 111.979/M 111.984			LE 553
						LK 050	
214 NGT	2.3	92	04.00–05.06	M 111.984			LE 553
						LK 050	
SPRINTER 3-t (903)							
308 CDI	2.1	60	04.00–05.06	OM 611.987			LE 553
308 D	2.3	58	02.95–04.00	OM 601.943			LE 553
						LK 050	
310 D 4x4	2.9	75	05.97–08.02	OM 602.980	Chassis P649732 →		LK 051
311 CDI	2.1	80	04.00–05.06	OM 611.981			LE 553
312 D 2.9	2.9	90	02.95–04.00	OM 602.980	Chassis P649732 →		LK 051
313 CDI	2.1	95	04.00–05.06	OM 611.981			LE 553
314	2.3	105	02.95–05.06	M 111.979/M 111.984			LK 050
314 NGT	2.3	92	04.00–05.06	M 111.984			LK 050
316 CDI	2.7	115	04.00–05.06	OM 612.981			LE 553
SPRINTER 4-t (904)							
408 CDI	2.1	60	04.00–05.06	OM 611.987			LE 553
408 D	2.3	58	02.96–05.06	OM 601.943			LE 553
						LK 050	



kW

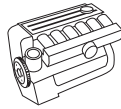

MERCEDES-BENZ

SPRINTER 4-t (904)

410 D	2.9	75	02.96-05.06	OM 602.980	Chassis P649732 →	LK 051	
411 CDI	2.1	80	04.00-05.06	OM 611.981			LE 553
412 D	2.9	90	02.96-05.06	OM 602.980	Chassis P649732 →	LK 051	
413 CDI	2.1	95	04.00-05.06	OM 611.981			LE 553
414	2.3	105	02.96-05.06	M 111.979/M 111.984			LE 553
						LK 050	
416 CDI	2.7	115	04.00-05.06	OM 612.981			LE 553

SPRINTER 5-t (906)

509 CDI	2.1	65	06.06-	OM 646.984			LE 035
---------	-----	----	--------	------------	--	--	--------

Stufenheck (W124)

200 (124.020)	2.0	75	01.86-05.90	M 102.922			LE 555
200 (124.020)	2.0	80	12.85-05.90	M 102.922			LE 555
200 D (124.120)	2.0	53	12.84-08.89	OM 601.912			LE 555
						LK 045	
200 D (124.120)	2.0	55	08.89-06.93	OM 601.912			LE 555
						LK 045	
200 E (124.019)	2.0	100	10.92-06.93	M 111.940			LE 553
						LK 038	
200 E (124.021)	2.0	87	09.88-08.92	M 102.963			LE 555
200 E (124.021)	2.0	90	09.88-12.89	M 102.963			LE 555
220 E (124.022)	2.2	110	10.92-06.93	M 111.960			LE 553
						LK 038	
230 E (124.023)	2.3	97	12.84-03.92	M 102.982			LE 555
230 E (124.023)	2.3	100	01.85-06.93	M 102.982			LE 555
230 E (124.023) KAT	2.3	97	06.89-06.93	M 102.982			LE 555
250 D (124.125)	2.5	66	04.85-06.93	OM 602.912			LE 555
						LK 045	
250 D (124.125)	2.5	69	01.89-06.93	OM 602.912			LE 555
						LK 045	
250 Turbo-D (124.128)	2.5	93	09.88-06.93	OM 602.962			LE 555
260 E (124.026)	2.6	118	09.85-08.92	M 103.940			LE 555
						LK 037	
260 E (124.026)	2.6	122	09.85-12.89	M 103.940			LE 555
						LK 037	
260 E 4-matic (124.226)	2.6	118	09.86-08.92	M 103.943			LE 555
						LK 037	
260 E 4-matic (124.226)	2.6	122	12.86-12.89	M 103.940			LE 555
						LK 037	
280 E (124.028)	2.8	145	10.92-06.93	M 104.942			LE 013
						LK 037	
300 D (124.130)	3.0	80	12.84-08.89	OM 603.912			LE 555
						LK 045	
300 D (124.130)	3.0	81	06.90-06.93	OM 603.912			LE 555
						LK 045	
300 D (124.130)	3.0	83	08.89-06.93	OM 603.912			LE 555
						LK 045	
300 D 4-matic (124.330)	3.0	80	09.86-08.92	OM 603.913			LE 555
						LK 045	
300 D 4-matic (124.330)	3.0	83	08.89-06.93	OM 603.913			LE 555
						LK 045	
300 E	3.0	138	01.85-12.85	M 103.980			LK 037
300 E	3.0	138	06.85-08.92	M 103.983			LK 037
300 E (124.030)	3.0	132	08.85-08.92	M 103.983			LE 555
						LK 037	
300 E 4-matic (124.230)	3.0	132	09.86-06.93	M 103.985			LE 555
						LK 037	
300 E-24 (124.031)	3.0	162	09.88-08.92	M 104.980			LE 013
						LK 037	



¹⁾ Mit Klimaanlage

²⁾ Mit Anhängervorrichtung

³⁾ Für tropisches Klima

⁴⁾ Automatik

⁵⁾ Schaltgetriebe

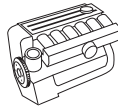
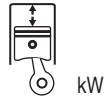

MERCEDES-BENZ

Stufenheck (W124)					
300 Turbo-D (124.133)	3.0	105	09.86-09.88	OM 603.960/OM 603.963	LE 555
300 Turbo-D (124.133)	3.0	108	09.88-06.93	OM 603.960	LE 555
320 E (124.032)	3.2	162	10.92-06.93	M 104.992	LK 013 LK 037
400 E 4.2 (124.034)	4.0	205	10.92-06.93	M 119.975	LE 013 LK 043
500 E (124.036)	5.0	240	01.91-06.93	M 119.974	LE 013 LK 043
T1 (601)					
208 D 2.3	2.3	58	10.88-02.96	OM 601.940	LK 059
208 D 2.3	2.3	60	10.88-02.96	OM 601.940	LK 059
210 2.3	2.3	77	05.89-02.96	M 102.945	LK 059
T1 (602)					
308 D 2.3	2.3	58	05.90-02.96	OM 601.940	LK 059
308 D 2.3	2.3	60	06.89-02.96	OM 601.940	LK 059

MITSUBISHI

L 300 Bus (L03_P/G, L0_2P)					
1.6 (L032P, L062P)	1.6	48	09.81-10.86	4G32	LK 068
1.6 (L032P, L062P)	1.6	51	11.84-02.87	4G32	LK 068
L 300 Bus (P0_W, P1_W, P2_W)					
2.0 (P03W)	2.0	64	11.86-	G63B	LK 070
2.0 (P03W, P03V, P13V)	2.0	66	11.86-	4G63	LK 070
2.0 4WD (P23V, P23W)	2.0	65	12.86-	4G63	LK 070
2.0 4WD (P23W)	2.0	66	11.86-	4G63	LK 070
2.4 (P04W, P14V, P04V)	2.4	82	11.90-	4G64	LK 070
2.4 4WD (P24W, P24V)	2.4	80	11.86-12.90	G64B	LK 070
2.4 4WD (P24W, P24V)	2.4	82	11.90-	4G64	LK 070
L 300 Pritsche/Fahrgestell (P1_T)					
2.0 (P13T)	2.0	85	07.94-	4 G 63	LK 070

OPEL

ASTRA F (56_, 57_)					
1.4	1.4	60	09.92-09.98	14 SE	Chassis S5060107 → LE 016 LE 563
1.4 i	1.4	44	09.91-09.98	C 14 NZ	Chassis S5060107 → LE 016 LE 563
1.4 i 16V	1.4	66	02.96-09.98	X 14 XE	Chassis S4000001 → LE 016 LE 563
1.4 Si	1.4	60	03.92-09.98	C 14 SE	Chassis S5060107 → Chassis S5060107 → LE 016 LE 563
1.6	1.6	55	09.95-09.98	16 NZR/16 LZ2	Chassis S5060107 → LE 016 LE 563
1.6 i	1.6	52	05.93-07.96	X 16 SZ	Chassis S4000001 → LE 016 LE 563
1.6 i	1.6	55	03.92-09.98	C 16 NZ/X 16 SZR	LE 016 LE 563
1.6 i	1.6	55	08.96-09.98	X 16 SZR	Chassis S5060107 → LE 016 LE 563
1.6 i 16V	1.6	74	08.94-09.98	X 16 XEL	Chassis S2559352 → LE 016 LE 563
1.6 Si	1.6	74	05.92-12.94	C 16 SE	Chassis S5060107 → LE 016 LE 563
1.7 D	1.7	44	09.94-09.98	17 DR	LE 563



kW

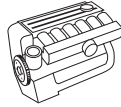

OPEL

ASTRA F (56_, 57_)

1.7 TD	1.7	50	11.94-09.98	X 17 DTL	Chassis S2559352 →	LE 563
1.7 TDS	1.7	60	03.92-09.98	17 DT (TC4EE1)/X 17 DT (TC4EE1)	Chassis S5060107 →	LE 563
1.8 i	1.8	66	03.92-09.98	C 18 NZ	Chassis S2559352 →	LE 563
1.8 i 16V	1.8	92	06.93-10.94	C 18 XE	Chassis S5060107 →	LE 563
1.8 i 16V	1.8	85	11.94-09.98	C 18 XEL/X 18 XE	Chassis S2559352 →	LE 563
2.0 i	2.0	85	03.92-09.98	C 20 NE	Chassis S2559352 →	LE 563
2.0 i 16V	2.0	100	02.95-09.98	X 20 XEV	Chassis S5060107 →	LE 563

ASTRA F Cabriolet (53_B)

1.4 i 16V	1.4	66	01.96-03.01	X 14 XE	Chassis S5060107 →	LE 016 LE 563
1.4 Si	1.4	60	05.93-03.01	C 14 SE	Chassis S2559352 →	LE 016 LE 563
1.6 i	1.6	52	03.93-08.96	X 16 SZ		LE 016
1.6 i	1.6	52	09.94-08.96	X 16 SZ		LE 563
1.6 i	1.6	55	01.96-03.01	X 16 SZR	Chassis S2559352 →	LE 016 LE 563
1.8 i 16V	1.8	85	11.94-03.01	C 18 XEL/X 18 XE	Chassis S4000001 →	LE 563

ASTRA F Caravan (51_, 52_)

1.4	1.4	60	09.92-01.98	14 SE	Chassis S2559352 →	LE 563
1.4 i	1.4	44	09.91-01.98	C 14 NZ	Chassis S2559352 →	LE 016 LE 563
1.4 i 16V	1.4	66	02.96-01.98	X 14 XE	Chassis S5060107 →	LE 016 LE 563
1.4 Si	1.4	60	03.92-01.98	C 14 SE	Chassis S4000001 →	LE 016 LE 563
1.6	1.6	55	09.95-01.98	16 NZR/16 LZ2	Chassis S4000001 →	LE 563
1.6 i	1.6	52	05.93-07.96	X 16 SZ	Chassis S5060107 →	LE 016 LE 563
1.6 i	1.6	55	09.91-01.98	C 16 NZ/X 16 SZR		LE 016
1.6 i	1.6	55	09.94-01.98	C 16 NZ/X 16 SZR		LE 563
1.6 i 16V	1.6	74	08.94-01.98	X 16 XEL		LE 563
1.6 Si	1.6	74	03.92-12.94	C 16 SE		LE 016
1.6 Si	1.6	74	09.94-12.94	C 16 SE		LE 563
1.7 D	1.7	44	07.92-01.98	17 DR	Chassis S4000001 →	LE 563
1.7 TD	1.7	50	11.94-01.98	X 17 DTL	Chassis S5060107 →	LE 563
1.7 TDS	1.7	60	12.91-01.98	17 DT (TC4EE1)/X 17 DT (TC4EE1)	Chassis S2559352 →	LE 563
1.8 i	1.8	66	09.94-01.98	C 18 NZ		LE 563
1.8 i 16V	1.8	85	07.94-01.98	C 18 XEL/X 18 XE	Chassis S2559352 →	LE 563

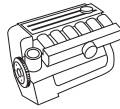
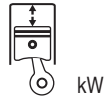

OPEL

ASTRA F Caravan (51_, 52_)

1.8 i 16V	1.8	92	06.93-01.98	C 18 XE	Chassis S5060107 →	LE 563
2.0 i 16V	2.0	100	02.95-01.98	X 20 XEV	Chassis S5060107 →	LE 563
2.0 i 16V	2.0	110	09.94-01.98	C 20 XE		LE 563

ASTRA F CC (53_, 54_, 58_, 59_)

1.4	1.4	60	09.94-01.98	14 SE		LE 563
1.4 i	1.4	44	03.92-01.98	C 14 NZ		LE 016
					Chassis S5060107 →	LE 563
1.4 i 16V	1.4	66	01.96-01.98	X 14 XE		LE 016
					Chassis S2559352 →	LE 563
1.4 Si	1.4	60	03.92-01.98	C 14 SE		LE 016
					Chassis S4000001 →	LE 563
1.6	1.6	55	09.95-01.98	16 NZR/16 LZ2	Chassis S2559352 →	LE 563
1.6 i	1.6	52	05.93-07.96	X 16 SZ		LE 016
					Chassis S4000001 →	LE 563
1.6 i	1.6	55	09.91-01.98	C 16 NZ/X 16 SZR		LE 016
1.6 i	1.6	55	09.94-01.98	C 16 NZ/X 16 SZR		LE 563
1.6 i 16V	1.6	74	08.94-01.98	X 16 XEL		LE 563
1.6 Si	1.6	74	03.92-12.94	C 16 SE		LE 016
					Chassis S5060107 →	LE 563
1.7 D	1.7	44	07.92-01.98	17 DR	Chassis S5060107 →	LE 563
1.7 TD	1.7	50	11.94-01.98	X 17 DTL	Chassis S4000001 →	LE 563
1.7 TDS	1.7	60	09.94-01.98	17 DT (TC4EE1)/X 17 DT (TC4EE1)		LE 563
1.8 i	1.8	66	09.91-01.98	C 18 NZ	Chassis S5060107 →	LE 563
1.8 i 16V	1.8	85	09.94-01.98	C 18 XEL/X 18 XE	Chassis S2559352 →	LE 563
2.0 GSI 16V	2.0	110	09.91-01.98	C 20 XE	Chassis S5060107 →	LE 563
2.0 i	2.0	85	09.94-01.98	C 20 NE		LE 563
2.0 i 16V	2.0	100	02.95-01.98	X 20 XEV	Chassis S4000001 →	LE 563

ASTRA F CLASSIC CC

1.2 i	1.2	48	03.98-08.00	X 12 XE		LE 016
1.4 i	1.4	66	03.98-08.00	X 14 XE		LE 016
1.7 TD	1.7	50	03.98-08.00	X 17 DTL		LE 016
1.8 i	1.8	85	03.98-08.00	X 18 XE1		LE 016
2.0 Di	2.0	60	03.98-08.00	X 20 DTL		LE 016
2.0 DTi	2.0	74	08.99-08.00	X 20 DTH		LE 016
2.0 i	2.0	100	03.98-08.00	X 20 XEV		LE 016
2.0 i	2.0	118	10.99-08.00	X 20 XER		LE 016

ASTRA F Van (55_)

1.4 i	1.4	44	10.91-01.99	C 14 NZ		LE 016
1.4 i	1.4	44	09.94-01.99	C 14 NZ		LE 563
1.6 i	1.6	52	02.93-07.96	X 16 SZ		LE 016
					Chassis S2559352 →	LE 563
1.6 i	1.6	55	10.91-04.93	C 16 NZ		LE 016
1.7 D	1.7	44	09.94-01.99	17 DR		LE 563
1.7 TD	1.7	50	08.94-01.99	X 17 DTL		LE 563



kW

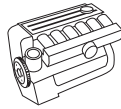

OPEL

ASTRA H

1.3 CDTI	1.3	66	08.05-	Z 13 DTH		LE 572
					1) → Chassis 62087950	LE 573
					1) → Chassis 65016699	LE 573
					1) → Chassis 68026623	LE 573
					1) Chassis 62087951 →	LE 574
					1) Chassis 65016700 →	LE 574
					1) Chassis 68026624 →	LE 574
1.4	1.4	59	04.04-10.04	Z 14 XEL		LE 023
1.4	1.4	66	03.04-	Z 14 XEP		LE 023
1.6	1.6	77	03.04-	Z 16 XEP		LE 022
1.6	1.6	85	12.06-	Z 16 XER		LE 022
1.6 CNG	1.6	69	11.05-	Z 16 YNG		LE 022
1.6 Turbo	1.6	132	02.07-	Z 16 LET		LE 574
1.7 CDTI	1.7	59	03.04-	Z 17 DTL	5)	LE 572
					1)	LE 574
1.7 CDTI	1.7	74	03.04-	Z 17 DTH	Chassis 52000001 →	LE 572
					5)	LE 572
					1)	LE 574
1.7 CDTI	1.7	81	02.07-	A 17 DTR	1) → Chassis 65016699	LE 573
1.7 CDTI	1.7	92	02.07-	Z 17 DTR	1) → Chassis 65016699	LE 573
1.8	1.8	92	03.04-	Z 18 XE		LE 022
					1) → Chassis 52083982	LE 574
					1) → Chassis 55084253	LE 574
					1) → Chassis 58055665	LE 574
1.8	1.8	103	01.06-	Z 18 XER		LE 022
1.9 CDTI	1.9	74	09.05-	Z 19 DT		LE 572
					1)	LE 574
1.9 CDTI 16V	1.9	88	04.04-	Z 19 DTJ	5)	LE 572
					1)	LE 573
1.9 CDTI	1.9	88	06.04-	Z 19 DT		LE 572
					1)	LE 574
1.9 CDTI	1.9	110	09.04-	Z 19 DTH	5)	LE 572
					1)	LE 573
2.0 Turbo	2.0	125	03.04-	Z 20 LEL		LE 572
					1)	LE 574
2.0 Turbo	2.0	147	09.04-	Z 20 LER		LE 572
					1)	LE 574
2.0 Turbo	2.0	177	03.05-	Z 20 LEH		LE 572
					1)	LE 573

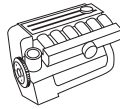
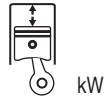
**OPEL****ASTRA H Caravan**

1.3 CDTI	1.3	66	08.05-	Z 13 DTH		LE 572
					1) → Chassis 62087950	LE 573
					1) → Chassis 65016699	LE 573
					1) → Chassis 68026623	LE 573
					1) Chassis 62087951 →	LE 574
					1) Chassis 65016700 →	LE 574
					1) Chassis 68026624 →	LE 574
1.4	1.4	66	08.04-	Z 14 XEP		LE 023
1.6	1.6	77	08.04-	Z 16 XEP		LE 022
1.6	1.6	85	12.06-	Z 16 XER		LE 022
1.6 CNG	1.6	69	11.05-	Z 16 YNG		LE 022
1.6 Turbo	1.6	132	02.07-	Z 16 LET		LE 574
1.7 CDTI	1.7	59	08.04-	Z 17 DTL	5)	LE 572
1.7 CDTI	1.7	74	08.04-	Z 17 DTH		LE 572
					5) Chassis 52000001 →	LE 572
1.7 CDTI	1.7	81	02.07-	A 17 DTR	1) → Chassis 65016699	LE 573
1.7 CDTI	1.7	92	02.07-	A 17 DTR	→ Chassis 65016699	LE 573
1.8	1.8	92	08.04-	Z 18 XE		LE 022
					1) → Chassis 52083982	LE 574
					1) → Chassis 55084253	LE 574
					1) → Chassis 58055665	LE 574
1.8	1.8	103	08.05-	Z 18 XER		LE 022
1.9 CDTI	1.9	74	09.05-	Z 19 DT	5)	LE 572
						LE 574
1.9 CDTI	1.9	88	09.05-	Z 19 DT		LE 572
					1)	LE 574
1.9 CDTI	1.9	110	09.04-	Z 19 DTH	5)	LE 572
					1)	LE 573
1.9 CDTI 16V	1.9	88	08.04-	Z 19 DTJ	1)	LE 573
2.0 Turbo	2.0	125	08.04-	Z 20 LEL	1)	LE 574
						LE 572
2.0 Turbo	2.0	147	09.04-	Z 20 LER		LE 572
					1)	LE 574
ASTRA J						
1.7 CDTI	1.7	81	12.09-	A 17 DTJ	1) Chassis 82000001 →	LE 574
					1) Chassis 85000001 →	LE 574
					1) Chassis 88000001 →	LE 574
CALIBRA A (85_)						
2.0 i	2.0	85	09.94-07.97	C 20 NE		LE 563
2.0 i 16V	2.0	100	02.94-07.97	X 20 XEV	Chassis S90000763 →	LE 563
2.0 i 16V 4x4	2.0	100	09.94-07.97	X 20 XEV		LE 563
2.0 i 4x4	2.0	85	09.94-07.97	C 20 NE		LE 563
2.0 i Turbo 4x4	2.0	150	03.92-07.97	C 20 LET	Chassis S90000763 →	LE 563



kW

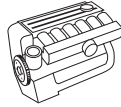

OPEL							
CALIBRA A (85_)							
2.5 i V6	2.5	125	04.93-07.97	X 25 XE/C 25 XE	→ Chassis S1,T9		LE 563
COMBO							
1.6	1.6	64	10.01-	Z 16 SE		LE 017	LE 559
CORSA A CC (93_, 94_, 98_, 99_)							
1.6 GSI	1.6	55	08.88-09.92	C 16 NZ		LE 016	
1.6 GSI	1.6	74	05.88-03.92	E 16 SE		LE 016	
1.6 GSI KAT	1.6	74	02.92-03.93	C 16 SE		LE 016	
CORSA B (73_, 78_, 79_)							
1.0 i 12V	1.0	40	11.96-09.00	X 10 XE	Chassis S4000001 →		LE 563
1.2 i	1.2	33	03.93-09.00	C 12 NZ/X 12 SZ		LE 016	
					Chassis S4000001 →		LE 563
1.2 i	1.2	33	09.94-09.00	12 NZ			LE 563
1.2 i 16V	1.2	48	03.98-09.00	X 12 XE	Chassis S6000001 →		LE 563
1.4 i	1.4	44	03.93-09.00	C 14 NZ/X 14 SZ		LE 016	
1.4 Si	1.4	60	03.93-09.00	C 14 SE		LE 016	
					Chassis S6000001 →		LE 563
1.7 D	1.7	44	02.96-09.00	17 D (4EE1)/X 17 D (4EE1)	Chassis S4000001 →		LE 563
CORSA C (F08, F68)							
1.0	1.0	43	09.00-	Z 10 XE		LE 017	LE 559
1.0	1.0	44	06.03-	Z 10 XEP	→ Chassis 53028730	LE 015	
							LE 561
1.2	1.2	55	09.00-	Z 12 XE		LE 017	LE 559
1.2 Twinport	1.2	59	07.04-	Z 12 XEP	→ Chassis 53028730	LE 015	
							LE 561
1.3 CDTI	1.3	51	06.03-	Z 13 DT	Chassis 63/64/66000001 →	LE 018	
						LE 021	
1.4	1.4	66	09.00-	Z 14 XE		LE 017	LE 559
1.4 Twinport	1.4	66	06.03-	Z 14 XEP	→ Chassis 53028730	LE 015	
							LE 561
1.6	1.6	71	08.05-07.06		Chassis 43/44/46000001 →	LE 015	
1.7 CDTI	1.7	74	06.03-	Z 17 DTH	Chassis 63/64/66000001 →	LE 018	
						LE 021	
1.7 DI	1.7	48	09.00-	Y 17 DTL	Chassis 33/34/36000001 →	LE 019	
							LE 561
1.7 DTI	1.7	55	09.00-	Y 17 DT		LE 021	LE 561
1.8	1.8	92	09.00-	Z 18 XE		LE 017	LE 559
CORSA D							
1.0	1.0	44	07.06-	Z 10 XEP		LE 564	LE 564Z
1.2	1.2	59	07.06-	Z 12 XEP		LE 564	LE 564Z
1.2 ecoFLEX	1.2	57	09.09-			LE 565	
1.3 CDTI	1.3	55	07.06-	Z 13 DTJ		LE 578	
1.3 CDTI	1.3	66	07.06-	Z 13 DTH		LE 578	
1.4	1.4	66	07.06-	Z 14 XEP		LE 564	LE 564Z
1.4 ecoFLEX	1.4	64	09.09-			LE 565	
1.6 Turbo	1.6	110	02.07-	Z 16 LEL		LE 579	
1.6 Turbo	1.6	141	02.07-	Z 16 LER		LE 579	
1.7 CDTI	1.7	92	07.06-	Z 17 DTR		LE 578	

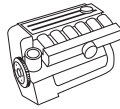

kW

OPEL
SIGNUM

1.8	1.8	90	05.03–	Z 18 XE		LE 020	LE 566	LE 566Z
1.8	1.8	103	09.05–	Z 18 XER		LE 020	LE 566	LE 566Z
1.9 CDTI	1.9	74	08.05–	Z 19 DT			LE 567	
1.9 CDTI	1.9	88	04.04–	Z 19 DT			LE 567	
1.9 CDTI	1.9	110	04.04–	Z 19 DTH			LE 567	
2.0 DTI	2.0	74	05.03–	Y 20 DTH			LE 567	
2.0 Turbo	2.0	129	05.03–	Z 20 NET			LE 567	
2.2 direct	2.2	114	05.03–	Z 22 YH		LE 020	LE 566	LE 566Z
2.2 DTI	2.2	92	05.03–	Y 22 DTR			LE 567	
2.8 V6 Turbo	2.8	169	09.05–	Z 28 NEL			LE 567	
2.8 V6 Turbo	2.8	184	01.06–	Z 28 NET			LE 567	
3.2 V6	3.2	155	05.03–	Z 32 SE			LE 567	

TIGRA TwinTop

1.3 CDTI	1.3	51	06.04–	Z 13 DT	Chassis 6E000001 →	LE 018		
						LE 021		
1.4	1.4	66	06.04–	Z 14 XEP	→ Chassis 4E999999	LE 015		
						LE 021	LE 562	
1.8	1.8	92	06.04–	Z 18 XE		LE 015	LE 562	

VECTRA A (86_, 87_)

1.6	1.6	60	09.88–05.93	16 SV		LE 016	LE 558	LE 558Z
1.6 i	1.6	55	09.88–10.90	E 16 NZ		LE 016		
1.6 i	1.6	52	09.93–11.95	X 16 SZ		LE 016		
1.6 i	1.6	55	09.94–11.95	16 LZ2			LE 563	
1.6 i KAT	1.6	55	09.88–11.95	C 16 NZ2/C 16 NZ		LE 016		
					Chassis S7000002 →		LE 563	
1.8 i KAT	1.8	66	03.90–11.95	C 18 NZ		LE 016		
1.8 S	1.8	65	09.88–07.89	E 18 NVR		LE 016		
1.8 S	1.8	66	09.89–10.90	18 SV		LE 016		
1.8 S 4x4	1.8	65	01.89–07.89	E 18 NVR		LE 016		
2.0 i 16V	2.0	100	06.94–11.95	X 20 XEV	Chassis S7000002 →		LE 563	
2.0 i 16V 4x4	2.0	100	06.94–11.95	X 20 XEV			LE 563	
2.0 i 4x4 KAT	2.0	85	01.89–11.95	C 20 NE	Chassis S5060107 →		LE 563	
2.0 i KAT	2.0	85	09.88–11.95	C 20 NE	Chassis S7000002 →		LE 563	
2.0 i Turbo 4x4	2.0	150	06.94–11.95	C 20 LET	Chassis S5060107 →		LE 563	
2000/GT 16V 4x4 KAT	2.0	110	02.90–11.95	C 20 XE	Chassis S7000002 →		LE 563	
2000/GT 16V KAT	2.0	110	09.94–11.95	C 20 XE			LE 563	

VECTRA B (36_)

1.6 i	1.6	55	10.95–04.02	X 16 SZR			LE 558	LE 558Z
1.6 i 16V	1.6	74	10.95–04.02	Z 16 XE/X 16 XEL/Y 16 XE			LE 558	LE 558Z
1.8 i 16V	1.8	85	10.95–09.00	X 18 XE1			LE 558	LE 558Z
2.0 DI 16V	2.0	60	11.96–04.02	X 20 DTL			LE 558	LE 558Z
2.0 i 16V	2.0	100	10.95–09.00	X 20 XEV/C 20 SEL			LE 558	LE 558Z
2.2 i 16V	2.2	108	09.00–04.02	Z 22 SE			LE 558	LE 558Z
2.5 i V6	2.5	125	10.95–09.00	X 25 XE			LE 558	LE 558Z

VECTRA B Caravan (31_)

1.6 i	1.6	55	11.96–06.00	X 16 SZR			LE 558	LE 558Z
1.6 i 16V	1.6	74	11.96–07.02	Z 16 XE/X 16 XEL/Y 16 XE			LE 558	LE 558Z
1.8 i 16V	1.8	85	11.96–09.00	X 18 XE1			LE 558	LE 558Z
2.0 DI 16V	2.0	60	11.96–06.00	X 20 DTL			LE 558	LE 558Z
2.0 i 16V	2.0	100	11.96–09.00	X 20 XEV/C 20 SEL			LE 558	LE 558Z
2.5 i V6	2.5	125	11.96–09.00	X 25 XE			LE 558	LE 558Z



kW

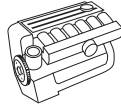

OPEL						
VECTRA B CC (38_)						
1.6 i	1.6	55	10.95-07.03	X 16 SZR		LE 558 LE 558Z
1.6 i 16V	1.6	74	10.95-07.02	Z 16 XE/X 16 XEL/Y 16 XE		LE 558 LE 558Z
1.8 i 16V	1.8	85	10.95-09.00	X 18 XE1		LE 558 LE 558Z
2.0 DI 16V	2.0	60	11.96-06.00	X 20 DTL		LE 558 LE 558Z
2.0 i 16V	2.0	100	10.95-09.00	X 20 XEV/C 20 SEL		LE 558 LE 558Z
2.5 i V6	2.5	125	10.95-09.00	X 25 XE		LE 558 LE 558Z
VECTRA C						
1.6	1.6	77	01.06-	Z 16 XEP	LE 020	LE 566 LE 566Z
1.6 16V	1.6	74	06.04-	Z 16 XE	LE 020	LE 566 LE 566Z
1.8	1.8	81	04.02-	Z 18 XEL	LE 020	LE 566 LE 566Z
1.8	1.8	103	01.06-	Z 18 XER	LE 020	LE 566 LE 566Z
1.8 16V	1.8	90	04.02-	Z 18 XE	LE 020	LE 566 LE 566Z
2.0 16V Turbo	2.0	129	03.03-	Z 20 NET		LE 567
2.0 DTI 16V	2.0	74	04.02-	Y 20 DTH		LE 567
2.2 16V	2.2	108	04.02-	Z 22 SE	LE 020	LE 566 LE 566Z
2.2 direct	2.2	114	10.03-	Z 22 YH	LE 020	LE 566 LE 566Z
2.2 DTI 16V	2.2	92	04.02-	Y 22 DTR		LE 567
3.2 V6	3.2	155	08.02-	Z 32 SE		LE 567
VECTRA C Caravan						
1.6	1.6	77	01.06-	Z 16 XEP		LE 567
1.6 16V	1.6	74	06.04-	Z 16 XE	LE 020	LE 566 LE 566Z
1.8	1.8	90	10.03-	Z 18 XE	LE 020	LE 566 LE 566Z
1.8	1.8	103	01.06-	Z 18 XER	LE 020	LE 566 LE 566Z
1.9 CDTI	1.9	74	10.05-	Z 19 DT		LE 571
1.9 CDTI	1.9	88	04.04-	Z 19 DT		LE 571
1.9 CDTI	1.9	110	04.04-	Z 19 DTH		LE 571
2.0 DTI	2.0	74	10.03-	Y 20 DTH		LE 567
2.0 Turbo	2.0	129	10.03-	Z 20 NET		LE 567
2.2 direct	2.2	114	10.03-	Z 22 YH	LE 020	LE 566 LE 566Z
2.2 DTI	2.2	92	10.03-	Y 22 DTR		LE 567
3.2 V6	3.2	155	10.03-	Z 32 SE		LE 567
VECTRA C GTS						
1.6	1.6	74	08.05-	Z 16 XE	LE 020	LE 566 LE 566Z
1.6	1.6	77	01.06-	Z 16 XEP	LE 020	LE 566 LE 566Z
1.8	1.8	103	01.06-	Z 18 XER	LE 020	LE 566 LE 566Z
1.8 16V	1.8	90	08.02-	Z 18 XE	LE 020	LE 566 LE 566Z
1.9 CDTI	1.9	74	10.05-	Z 19 DT		LE 571
1.9 CDTI	1.9	88	04.04-	Z 19 DT		LE 571
1.9 CDTI	1.9	110	04.04-	Z 19 DTH		LE 571
2.0 16V Turbo	2.0	129	03.03-	Z 20 NET		LE 567
2.0 DTI 16V	2.0	74	08.02-	Y 20 DTH		LE 567
2.2 16V	2.2	108	08.02-	Z 22 SE	LE 020	LE 566 LE 566Z
2.2 direct	2.2	114	10.03-	Z 22 YH	LE 020	LE 566 LE 566Z
2.2 DTI 16V	2.2	92	08.02-	Y 22 DTR		LE 567
3.2 V6	3.2	155	08.02-	Z 32 SE		LE 567
ZAFIRA						
1.6	1.6	69	01.06-	Z 16 YNG	LE 022	
1.6	1.6	77	07.05-	Z 16 XEP	LE 022	
1.6	1.6	85	01.08-	Z 16 XER	LE 022	
				Chassis 52083983 →		LE 575
				Chassis 55084254 →		LE 575
				Chassis 58055666 →		LE 575
1.6 CNG Turbo	1.6	110	02.09-	Z 16 XNT		LE 572
					1)	LE 574

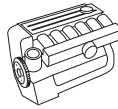
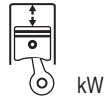

OPEL

ZAFIRA						
1.7 CDTI	1.7	81	01.08-	A 17 DTJ/Z17DTJ		LE 573
					1) Chassis 82000001 →	LE 574
					1) Chassis 85000001 →	LE 574
					1) Chassis 88000001 →	LE 574
					1) Chassis 8G000001 →	LE 574
1.8	1.8	103	07.05-	Z 18 XEP/Z 18 XER		LE 022
					Chassis 52083983 →	LE 575
					Chassis 55084254 →	LE 575
					Chassis 58055666 →	LE 575
1.9 CDTI	1.9	74	07.05-	Z 19 DT	→ Chassis 62079391	LE 573
					→ Chassis 6G099332	LE 573
					Chassis 62079391 →	LE 572
					Chassis 6G099333 →	LE 572
1.9 CDTI	1.9	88	07.05-	Z 19 DT	→ Chassis 6G099332	LE 573
					→ Chassis 62079391	LE 573
					Chassis 62079391 →	LE 572
					Chassis 6G099333 →	LE 572
1.9 CDTI	1.9	110	07.05-	Z 19 DTH		LE 573
2.2	2.2	110	07.05-	Z 22 YH		LE 572
					1)	LE 574
2.0	2.0	147	07.05-	Z 20 LER		LE 572
					1)	LE 574

PEUGEOT

106 II (1)						
1.0 i	1.0	33	05.96-	CDY (TU9M)		LE 510
1.0 i	1.0	37	01.97-	CDZ (TU9M)		LE 510
1.1 i	1.1	40	01.97-	HDY (TU1M)		LE 510
1.1 i	1.1	44	05.96-	HDZ (TU1M)/HFX (TU1JP)		LE 510
1.4 i	1.4	55	05.96-	KFX (TU3JP)/KFW (TU3JP)		LE 510
1.6 i	1.6	65	05.96-	NFZ (TU5JP)		LE 510
1.6 i	1.6	74	05.96-	NFW (TU5J2)/NFY (TU5J2)		LE 510
1.6 S16	1.6	87	05.96-	NFX (TU5J4)		LE 510
206 (2A/C, T3E)						
1.1 i	1.1	44	09.98-	HFZ (TU1JP)/HFX (TU1JP)	LE 024	LE 580
1.4 16V	1.4	65	10.03-	KFU (ET3J4)	LE 024	
1.4 HDi eco 70	1.4	50	09.01-	8HZ (DV4TD)/8HX (DV4TD)	LE 024	
1.4 i	1.4	55	09.98-	KFX (TU3JP)/KFW (TU3JP)	LE 024	LE 580
1.6 16V	1.6	80	12.00-	NFU (TU5JP4)	LE 024	LE 580
1.6 i	1.6	65	09.98-12.00	NFZ (TU5JP)	LE 024	LE 580
1.9 D	1.9	51	09.98-11.01	WJZ (DW8)	LE 024	LE 580
2.0 HDI 90	2.0	66	12.99-	RHY (DW10TD)	LE 024	
2.0 RC	2.0	130	07.03-	RFK (EW10J4S)	LE 024	
2.0 S16	2.0	99	04.99-10.00	RFR (DEW10J4)	LE 024	LE 580
2.0 S16	2.0	100	10.00-	RFN (EW10J4)	LE 024	LE 580



kW

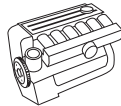

PEUGEOT

206 CC (2D)

1.6 16V	1.6	80	09.00-	NFU (TU5JP4)	LE 024	LE 580
2.0 S16	2.0	100	09.00-	RFN (EW10J4)	LE 024	LE 580

206 SW (2E/K)

1.1	1.1	44	07.02-	HFX (TU1JP)	LE 024	
1.4	1.4	55	07.02-	KFW (TU3JP)	LE 024	
1.4 16V	1.4	65	10.03-	KFU (ET3J4)	LE 024	
1.4 HDi	1.4	50	07.02-	8HX (DV4TD)	LE 024	
1.6 16V	1.6	80	07.02-	NFU (TU5JP4)	LE 024	
2.0 16V	2.0	100	07.02-	RFN (EW10J4)	LE 024	
2.0 HDi	2.0	66	07.02-	RHY (DW10TD)	LE 024	

306 (7A, 7C, N3, N5)

1.8 D	1.8	43	05.93-05.01	A9A (XUD7)	LE 009	
1.9 D	1.9	50	06.94-05.01	DJY (XUD9A)	LE 009	
1.9 D	1.9	51	09.98-05.01	WJY (DW8B)/WJZ (DW8)	LE 009	
1.9 D	1.9	55	03.98-05.01	DHV (XUD9BSD)	LE 009	
1.9 DT	1.9	66	05.93-05.01	DHY (XUD9TE)	LE 009	
2.0 16V	2.0	97	03.97-05.01	RFV (XU10J4R)	LE 010	

306 (7B, N3, N5)

1.6	1.6	72	10.00-05.01	NFT	LE 010	
1.9 SLD	1.9	50	06.94-05.01	DJY (XUD9A)	LE 009	
1.9 D	1.9	51	09.98-05.01	WJY (DW8B)/WJZ (DW8)	LE 009	
1.9 D	1.9	55	03.98-05.01	DHV (XUD9BSD)	LE 009	
1.9 SRDT	1.9	66	06.94-05.01	DHY (XUD9TE)	LE 009	
2.0	2.0	97	03.97-05.01	RFV (XU10J4R)	LE 010	

306 Break (7E, N3, N5)

1.6	1.6	65	03.97-10.00	NFZ (TU5JP)	LE 010	
1.6	1.6	72	10.00-04.02	NFT	LE 010	
1.9 D	1.9	50	03.97-04.02	DJY (XUD9A)	LE 009	
1.9 D	1.9	51	09.98-04.02	WJY (DW8B)/WJZ (DW8)	LE 009	
1.9 D	1.9	55	03.98-04.02	DHV (XUD9BSD)	LE 009	
1.9 TD	1.9	66	02.97-04.02	DHY (XUD9TE)	LE 009	
2.0	2.0	97	03.97-04.02	RFV (XU10J4R)	LE 010	

306 Cabriolet (7D, N3, N5)

1.6	1.6	72	10.00-04.02	NFT	LE 010	
2.0 16V	2.0	97	03.97-04.02	RFV (XU10J4R)	LE 010	

307 SW (3H)

1.6 16V	1.6	80	03.02-	NFU (TU5JP4)	LE 024	
2.0 16V	2.0	100	03.02-	RFN (EW10J4)	LE 024	
2.0 16V	2.0	103	03.05-	RFJ (EW10A)	LE 024	

406 (8B)

1.6	1.6	65	11.95-05.04	BFZ (XU5JP)	LE 009	
1.8	1.8	66	05.97-05.04	LFX (XU7JB)	LE 009	
1.8 16V	1.8	81	11.95-10.00	LFY (XU7JP4)	LE 009	
2.0 HDi 90	2.0	66	02.99-05.04	RHY (DW10TD)		LE 581
2.0 HDi 110	2.0	79	08.01-05.04	RHZ (DW10ATED)/RHS (DW10ATED)		LE 581
2.0 HDi 110	2.0	80	06.98-08.01	RHZ (DW10ATED)	LE 009	LE 581
2.0 16V	2.0	97	11.95-05.04	RFV (XU10J4R)	LE 009	
2.0 16V	2.0	100	08.00-05.04	RFN (EW10J4)	LE 009	
2.1 TD 12V	2.1	80	01.96-05.04	P8C (XUD11BTE)	LE 009	
2.2 HDi	2.2	98	03.00-05.04	4HX (DW12TED4/FAP)		LE 581

406 Break (8E/F)

1.8	1.8	66	05.97-10.04	LFX (XU7JB)	LE 009	
1.8 16V	1.8	81	10.96-10.00	LFY (XU7JP4)	LE 009	
1.9 D	1.9	55	10.96-10.04	DHW (XUD9SD)	LE 009	
2.0 HDi 90	2.0	66	02.99-10.04	RHY (DW10TD)		LE 581
2.0 HDi 110	2.0	79	08.01-10.04	RHZ (DW10ATED)/RHS (DW10ATED)		LE 581
2.0 HDi 110	2.0	80	02.99-04.04	RHZ (DW10ATED)	LE 009	LE 581
2.0 16V	2.0	97	10.96-10.04	RFV (XU10J4R)	LE 009	
2.0 16V	2.0	100	10.00-10.04	RFN (EW10J4)	LE 009	
2.1 TD 12V	2.1	80	10.96-10.04	P8C (XUD11BTE)	LE 009	

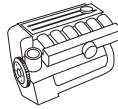
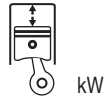
PEUGEOT

406 Break (8E/F)							
2.2 HDI	2.2	98	03.00–10.04	4HX (DW12TED4/FAP)		LE 581	
406 Coupe (8C)							
2.0 16V	2.0	97	03.97–12.04	RFV (XU10J4R)	LE 009		
2.0 16V	2.0	100	10.00–12.04	RFN (EW10J4)	LE 009		
607 (9D, 9U)							
2.0	2.0	100	02.00–	RFN (EW10J4)		LE 581	
2.0 HDi	2.0	79	03.01–07.04	RHS (DW10ATED)		LE 581	
2.0 HDI	2.0	80	05.00–	RHZ (DW10ATED)		LE 581	
2.2 16V	2.2	116	02.00–	3FZ (EW12J4)		LE 581	
2.2 HDI	2.2	98	02.00–	4HX (DW12TED4/FAP)		LE 581	
3.0 V6 24V	3.0	152	02.00–	XFX (ES9J4S)		LE 581	
PARTNER							
1.1	1.1	44	06.96–	HDZ (TU1M)		LE 509	
1.4	1.4	54	11.02–10.06			LE 509	
1.6 16V	1.6	80	07.01–	NFU (TU5JP4)		LE 509	
1.6 HDi 75	1.6	55	02.06–			LE 509	
1.6 HDi 90	1.6	66	02.06–	9HX (DV6ATED4)		LE 509	
1.9 D	1.9	51	06.96–	WJY (DW8B)/WJZ (DW8)	LE 009		
2.0 HDI	2.0	66	02.00–	RHY (DW10TD)	LE 009		

PUCH

G-MODELL (W 463)							
300 GE	3.0	125	06.90–	M 103.987	LK 036		
G 36 AMG	3.6	200	01.95–		LK 036		

RENAULT

19 II (B/C53_)							
1.4	1.4	55	01.92–12.95	E7J 742		LE 582	
1.8	1.8	79	05.94–12.95	F3P 765/F3P 682		LE 582	
1.8	1.8	81	04.92–05.94	F3P 700		LE 582	
21 Stufenheck (L48_)							
1.7	1.7	54	07.86–02.94	F3N 726 /F2N 750		LE 582	
1.7	1.7	55	03.86–12.87	F2N 712		LE 582	
1.7	1.7	64	06.87–04.89	F2N 752		LE 582	
1.7	1.7	65	03.86–03.93	F2N 710		LE 582	
1.7	1.7	66	09.89–02.94	F3N 723/F3N 722		LE 582	
1.7	1.7	69	03.86–02.94	F3N 723/F3N 722		LE 582	
21 Kombi (K48_)							
1.7	1.7	54	05.88–06.93	F3N 726		LE 582	
1.7	1.7	54	06.86–12.89	F2N 750		LE 582	
1.7	1.7	55	06.86–03.93	F2N 712		LE 582	
1.7	1.7	64	06.87–04.89	F2N 752		LE 582	
1.7	1.7	65	10.86–12.88	F2N 710		LE 582	
1.7	1.7	66	10.89–12.93	F3N 723/F3N 722		LE 582	
1.7	1.7	69	06.86–12.89	F3N 723/F3N 722		LE 582	
25 (B29_)							
2.0	2.0	74	04.84–12.92	J6R 763/J6R 707/J6R 760/J6R 706/ J6R 762		LE 582	
2.0 12V	2.0	99	06.89–12.92	J7R 726		LE 582	
2.2	2.2	79	09.86–12.92	J7T 708/J7T 733 /J7T 732		LE 582	
2.2	2.2	91	04.84–12.89	J7T 730/J7T 731		LE 582	
CLIO I (B/C57_, 5/357_)							
1.2	1.2	43	05.90–09.98	E7F 750/E7F 700/E7F 708		LE 582	
1.4	1.4	58	01.91–09.98	E7J 719 /E7J 718/E7J 754		LE 582	
1.8	1.8	65	01.91–09.98	F3P 710 /F3P 714		LE 582	
1.8 Rsi	1.8	79	08.95–09.98	F3P 758		LE 582	
ESPACE II (J/S63_)							
2.0	2.0	76	01.91–10.96	J7R 768		LE 582	
2.2	2.2	79	01.91–10.96	J7T 772/J7T 776/J7T 773		LE 582	
2.8 V6	2.8	110	01.91–10.96	Z7W 717/Z7W 712/Z7W 713		LE 582	



kW

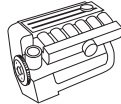

RENAULT

SUPER 5 (B/C40)

1.0	1.0	30	10.84-10.88	C1C 700				LE 582
1.1	1.1	33	01.86-03.95	C1E 752/C1E 750/C1E 756/C1E 760				LE 582
1.1	1.1	34	10.84-10.88	C1E 752/C1E 750/C1E 754				LE 582
1.4	1.4	43	10.85-12.96	C3J 700/C3J 702/C3J 760				LE 582
1.4	1.4	43	10.84-06.88	C1J 780/C1J 768				LE 582
1.4	1.4	49	06.87-07.89	C2J 782				LE 582
1.4	1.4	52	10.84-07.89	C2J 789/C2J 700/C2J 780/C2J 781/ C2J 788/C2J 798				LE 582
1.7	1.7	54	10.86-03.95	F3N 716 /F3N 717				LE 582
1.7	1.7	64	06.87-03.95	F2N 742/F2N 740				LE 582

MASTER I

28-35 2.0	2.0	58	10.86-07.98	J5R 718				LE 582
28-35 2.0	2.0	58	10.86-07.98	J5R 728				LE 582
28-35 2.1 D	2.1	44	08.80-07.98	J8S 330				LE 582

SAAB

9-3 (YS3D)

2.0 i	2.0	96	02.98-09.02	B204I				LE 568
2.0 Turbo	2.0	110	01.01-09.02	B205E				LE 568
2.0 Turbo	2.0	113	10.98-09.02	B204E				LE 568
2.0 Turbo	2.0	136	02.98-09.02	B205L/B204L				LE 568
2.0 Turbo	2.0	151	10.99-09.02	B205R				LE 568
2.2 TiD	2.2	85	02.98-11.00	X 22 DTH/D223L				LE 568
2.2 TiD	2.2	92	11.00-09.02	D223L				LE 568
2.3 i	2.3	110	02.98-09.02	B234I				LE 568

9-3 Cabriolet (YS3D)

2.0 Turbo	2.0	113	10.98-08.03	B204E				LE 568
2.0 Turbo	2.0	136	02.98-08.03	B205L/B204L				LE 568
2.3 i	2.3	110	02.98-08.03	B234I				LE 568

SEAT

ALHAMBRA (7V8, 7V9)

1.8 T 20V	1.8	110	10.97-	AWC/AJH				LE 502
1.9 TDI	1.9	66	04.96-	ANU/1Z/AHU				LE 502
							LK 001	
1.9 TDI	1.9	81	08.96-06.00	AVG/AFN				LE 502
							LK 001	
2.0 i	2.0	85	04.96-	ATM/ADY				LE 502

ALTEA (5P1)

1.4 16V	1.4	63	05.06-	BXW			LE 035	LE 584	LE 584Z
1.4 TSI	1.4	92	11.07-	CAXC			LE 035	LE 584	LE 584Z
1.6	1.6	75	03.04-	BGU/BSF/BSE			LE 035	LE 584	LE 584Z
1.6 TDI	1.6	77	10.09-	CAYC			LE 035	LE 584	LE 584Z
1.9 TDI	1.9	77	04.04-	BXE/BKC/BJB/BLS			LE 035	LE 584	LE 584Z
2.0 FSI	2.0	110	05.04-	BLR/BLY/BVZ/BVY			LE 035	LE 584	LE 584Z
2.0 TDI	2.0	100	03.04-	AZV			LE 035	LE 584	LE 584Z
2.0 TDI	2.0	103	11.05-	BMM			LE 035	LE 584	LE 584Z
2.0 TDI	2.0	125	03.06-	CEGA/BMN			LE 035	LE 584	LE 584Z
2.0 TDI 16V	2.0	103	03.04-	BKD			LE 035	LE 584	LE 584Z
2.0 TFSI	2.0	147	04.06-	BWA			LE 035	LE 584	LE 584Z

ALTEA XL (5P5)

1.4 16V	1.4	63	10.06-	BXW			LE 035	LE 584	LE 584Z
1.4 TSI	1.4	92	11.07-	CAXC			LE 035	LE 584	LE 584Z
1.6	1.6	75	10.06-	BSF/BSE			LE 035	LE 584	LE 584Z
1.6 TDI	1.6	77	10.09-	CAYC			LE 035	LE 584	LE 584Z
1.9 TDI	1.9	77	10.06-	BXE/BLS			LE 035	LE 584	LE 584Z
2.0 FSI	2.0	110	10.06-	BVZ/BVY			LE 035	LE 584	LE 584Z
2.0 TDI	2.0	103	10.06-	BMM			LE 035	LE 584	LE 584Z
2.0 TDI	2.0	125	06.07-	BMN			LE 035	LE 584	LE 584Z
2.0 TDI 16V	2.0	103	10.06-	BKD			LE 035	LE 584	LE 584Z

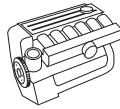
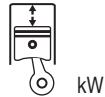

SEAT

ALTEA XL (5P5)									
2.0 TFSI 4x4	2.0	147	06.07-	BWA			LE 035	LE 584	LE 584Z
AROSA (6H)									
1.0	1.0	37	05.97-06.04	AER/ANV/ALD/ALL/AUC	2)		LE 003		
					2) 3)		LE 033		
1.4	1.4	44	05.97-06.04	AEX/AKV/ANW/AKK/APQ/AUD	2)		LE 003		
					2) 3)		LE 033		
							LE 036		
1.4 16V	1.4	74	01.00-06.04	ANM/AFK/AUB/AQQ	2)		LE 003		
					2) 3)		LE 033		
1.4 TDI	1.4	55	01.00-06.04	AMF			LE 030		
CORDOBA (6K2/C2)									
1.0 CL	1.0	33	02.93-06.96	AAU			LE 001		
1.0 i	1.0	37	09.96-06.99	AER			LE 001		
					2)		LE 007		
1.4 i	1.4	44	06.94-06.99	AEX/AKV/ABD/ANX/APQ	2)		LE 007		
							LE 027		
1.4 i 16V	1.4	74	09.96-06.99	AFH			LE 001		
					2)		LE 007		
1.6 i	1.6	55	02.93-06.99	ABU/ALM/AEE			LE 001		
					2)		LE 007		
1.6 i	1.6	55	05.94-06.99	1F			LE 027		
1.6 i	1.6	74	07.96-06.99	AFT			LE 027		
1.8 i	1.8	66	02.93-06.99	ADZ/ABS			LE 027		
1.8 i 16V	1.8	95	10.93-08.96	ADL			LE 027		
1.9 D	1.9	47	01.96-08.96	1Y			LE 001		
1.9 D	1.9	50	02.93-08.96	1Y			LE 001		
1.9 SDI	1.9	47	08.96-06.99	AEY			LE 001		
					2)		LE 007		
1.9 TD	1.9	55	02.93-08.96	AAZ			LE 027		
1.9 TDI	1.9	66	08.96-06.99	1Z/AHU			LE 027		
1.9 TDI	1.9	81	03.97-06.99	AFN			LE 027		
2.0 i	2.0	85	02.93-06.99	2E/AGG			LE 027		
2.0 i 16V	2.0	110	08.96-06.99	ABF			LE 027		
CORDOBA (6L2)									
1.2	1.2	47	10.02-	AZQ/BME		→ 6L-5-172 659	LE 036		
1.2	1.2	47	10.02-	AZQ/BME			LE 039	LE 585	
1.2 12V	1.2	51	05.06-	BXV			LE 044	LE 585	
1.4 16V	1.4	55	09.02-	BBY/BKY	2)		LE 003		
					2) 3)		LE 033		
						→ Chassis 6L-5-008000	LE 036		
							LE 039		
1.4 16V	1.4	63	05.06-	BXW			LE 036	LE 585	
1.4 16V	1.4	74	10.02-	BBZ			LE 036	LE 587	
1.4 TDI	1.4	51	05.05-	BNM			LE 044	LE 587	
1.4 TDI	1.4	55	10.02-	AMF			LE 044	LE 587	
1.4 TDI	1.4	59	06.05-	BMS/BNV			LE 044	LE 587	
1.6	1.6	74	04.03-	BAH			LE 036	LE 587	
1.6 16V	1.6	77	11.06-	BTS			LE 036	LE 585	
1.9 SDI	1.9	47	09.02-	ASY		→ Chassis 6L-5-008000	LE 036		
							LE 039	LE 585	
1.9 TDI	1.9	74	09.02-	BMT/AXR/ATD	1)		LE 005		
						→ Chassis 6L-5-008000	LE 036		
1.9 TDI	1.9	96	10.02-	BLT/ASZ	1)		LE 005		
							LE 036		
2.0	2.0	85	09.02-	AZL/BBX	1)		LE 005		
							LE 036		



kW

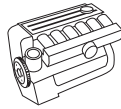

SEAT

CORDOBA Vario (6K5)

1.4 i	1.4	44	09.96-06.99	AEX/AKV/ANX/APQ	2)	LE 007	
						LE 027	
1.6 i	1.6	55	09.96-06.99	ALM/AEE		LE 001	
					2)	LE 007	
1.6 i	1.6	55	05.97-06.99	1F		LE 027	
1.6 i	1.6	74	09.96-06.99	AFT		LE 027	
1.9 SDI	1.9	47	09.96-06.99	AEY		LE 001	
					2)	LE 007	
1.9 TDI	1.9	66	08.96-06.99	1Z/AHU		LE 027	
1.9 TDI	1.9	81	07.97-06.99	AFN		LE 027	

IBIZA II (6K1)

1.0	1.0	33	03.93-09.96	AAU		LE 001	
					2)	LE 007	
1.0 i	1.0	37	09.96-08.99	AER		LE 001	
					2)	LE 007	
1.3 i	1.3	40	03.93-08.99	2G/AAV	2)	LE 007	
1.4 i	1.4	44	09.93-08.99	AEX/AKV/ABD/APQ	2)	LE 007	
						LE 027	
1.4 i 16V	1.4	74	09.96-08.99	AFH		LE 001	
					2)	LE 007	
1.6 i	1.6	55	03.93-08.99	ABU/ALM/AEE		LE 001	
					2)	LE 007	
1.6 i	1.6	55	09.94-06.99	1F		LE 027	
1.6 i	1.6	74	04.96-08.99	AFT		LE 027	
1.8 i	1.8	66	03.93-08.99	ADZ/ABS		LE 027	
1.8 i 16V	1.8	95	11.93-08.96	ADL		LE 027	
1.9 D	1.9	47	04.93-08.96	1Y		LE 001	
1.9 D	1.9	50	10.94-08.96	1Y		LE 001	
1.9 SDI	1.9	47	08.96-08.99	AEY		LE 001	
					2)	LE 007	
1.9 TD	1.9	55	03.93-08.96	AAZ		LE 027	
1.9 TDI	1.9	66	08.96-08.99	1Z/AHU		LE 027	
2.0 i	2.0	85	03.93-08.99	2E/AGG		LE 027	
2.0 i 16V	2.0	110	08.96-08.99	ABF		LE 027	

IBIZA IV (6L1)

1.2	1.2	44	06.07-05.08	BBM		LE 044	LE 585
1.2	1.2	47	02.02-06.06	AZQ/BME		LE 036	LE 585
1.2 12V	1.2	51	05.06-	BXV		LE 044	LE 585
1.4 16V	1.4	55	02.02-12.07	BBY/BKY	2)	LE 003	
					2) 3)	LE 033	
					→ Chassis 6L-5-008000	LE 036	
						LE 039	
1.4 16V	1.4	63	05.06-	BXW		LE 036	LE 585
1.4 16V	1.4	74	02.02-	BBZ/AUB		LE 036	LE 587
1.4 TDI	1.4	51	05.05-	BNM		LE 044	LE 587
1.4 TDI	1.4	55	05.02-12.05	AMF		LE 044	LE 587
1.4 TDI	1.4	59	06.05-	BMS/BNV		LE 044	LE 585
1.6	1.6	74	02.03-	BAH		LE 036	LE 587
1.6 16V	1.6	77	11.06-	BTS		LE 036	LE 585
1.8 T Cupra R	1.8	132	01.04-02.08	BBU/BLZ	1)	LE 005	
						LE 036	
1.8 T FR	1.8	110	12.03-05.08	BKV/BJX	1)	LE 005	
						LE 036	
1.9 SDI	1.9	47	02.02-12.05	ASY		→ Chassis 6L-5-008000	LE 036
						LE 039	LE 585

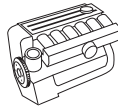
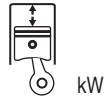

SEAT

IBIZA IV (6L1)

1.9 TDI	1.9	74	02.02-	BMT/AXR/ATD	1)	LE 005 LE 036 → Chassis 6L-5-008000		
						LE 044	LE 585	
1.9 TDI	1.9	96	02.02-	BLT/ASZ	1)	LE 005 LE 036		
1.9 TDI Cupra R	1.9	118	03.04-02.08	BPX/BUK	1)	LE 005 LE 044	LE 587	
2.0	2.0	85	04.02-	AZL/BBX	1)	LE 005 LE 036	LE 587	

IBIZA V (6J5)

1.2	1.2	51	03.08-	BZG/CGPA			LE 585	
1.4	1.4	63	03.08-	BXW		LE 036	LE 585	
1.4 TDI	1.4	59	07.08-	BMS			LE 585	
1.4 TSI	1.4	110	06.09-	CAVF		LE 035	LE 584	LE 584Z
1.6	1.6	77	05.08-	BTS			LE 585	
1.9 TDI	1.9	66	07.08-	BXJ			LE 585	
1.9 TDI	1.9	77	03.08-	BLS			LE 585	

IBIZA V SPORTCOUPE (6J1)

1.2	1.2	51	07.08-	BZG/CGPA			LE 585	
1.4	1.4	63	07.08-	CGGB/BXW		LE 036		
1.4 TDI	1.4	59	07.08-	BMS			LE 585	
1.4 TSI	1.4	110	06.09-	CAVF		LE 035	LE 584	LE 584Z
1.4 TSI	1.4	132	06.09-	CAVE		LE 035	LE 584	LE 584Z
1.6	1.6	77	07.08-	BTS			LE 585	
1.9 TDI	1.9	77	07.08-	BLS			LE 585	

INCA (6K9)

1.4 i	1.4	44	11.95-06.03	AEX/AKV/APQ/AUD			LE 027	
1.6 i	1.6	55	11.95-05.98	1F			LE 027	
1.6 i	1.6	55	11.95-05.98	AEE	2)		LE 007	
1.7 D	1.7	42	09.96-06.03	AHB	2)		LE 007	
1.9 D	1.9	47	11.95-06.03	1Y			LE 027	
1.9 SDI	1.9	47	11.95-06.03	AYQ/AEY	2)		LE 007 LE 027	

LEON (1M1)

1.4 16V	1.4	55	11.99-06.06	AHW/AXP/BCA/APE	2)		LE 003	
1.6	1.6	74	11.99-06.06	AKL/AEH	2)		LE 003	
1.6 16 V	1.6	77	09.00-06.06	AUS/BCB/AZD	2)		LE 003	
					2) 3)		LE 033	
1.8 20V	1.8	92	11.99-06.06	AGN/APG	2)		LE 003	
					2) 3)		LE 033	
1.8 20V T	1.8	132	11.99-06.06	APP/AUQ	2)		LE 003	
					2) 3)		LE 033	
1.8 20V T 4	1.8	132	11.99-06.06	AJQ/ARY	2)		LE 003	
					2) 3)		LE 033	
1.9 SDI	1.9	50	11.99-06.06	AQM	2)		LE 003	
					2) 3)		LE 033	
1.9 TDI	1.9	66	11.99-06.06	AGR/ALH	2)		LE 003	
					2) 3)		LE 033	
1.9 TDI	1.9	74	10.05-06.06	AXR	2) 3)		LE 033 LE 045	
1.9 TDI	1.9	81	11.99-06.06	AHF/ASV	2)		LE 003	
					2) 3)		LE 033	
1.9 TDI	1.9	96	05.03-06.06	ASZ	2)		LE 003	

LEON (1P1)

1.4 16V	1.4	63	06.06-	BXW		LE 035	LE 584	LE 584Z
1.4 TSI	1.4	92	11.07-	CAXC		LE 035	LE 584	LE 584Z
1.6	1.6	75	07.05-	CCSA/BSF/BSE		LE 035	LE 584	LE 584Z
1.6 LPG	1.6	75	12.09-	CHGA		LE 035	LE 584	LE 584Z
1.9 TDI	1.9	77	07.05-	BXE/BKC/BLS		LE 035	LE 584	LE 584Z



kW

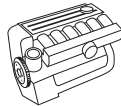

SEAT

LEON (1P1)									
2.0 FSI	2.0	110	07.05-	BLR/BLY/BVZ/BVY			LE 035	LE 584	LE 584Z
2.0 TDI	2.0	100	07.05-	AZV			LE 035	LE 584	LE 584Z
2.0 TDI	2.0	103	10.05-	BMM			LE 035	LE 584	LE 584Z
2.0 TDI	2.0	125	05.06-	CEGA/BMN			LE 035	LE 584	LE 584Z
2.0 TDI 16V	2.0	103	07.05-	BKD			LE 035	LE 584	LE 584Z
2.0 TFSI	2.0	136	09.05-05.06	BWA1			LE 035	LE 584	LE 584Z
2.0 TFSI	2.0	147	05.05-	BWA			LE 035	LE 584	LE 584Z
2.0 TFSI	2.0	177	11.06-	BWJ/CDLD			LE 035	LE 584	LE 584Z
2.0 TFSI	2.0	155	06.09-	CCZB			LE 035	LE 584	LE 584Z
2.0 TFSI	2.0	195	09.09-	CDLA			LE 035	LE 584	LE 584Z
TOLEDO I (1L)									
1.6 i	1.6	52	05.91-12.93	1F		2)	LE 007		
							LE 027		
1.6 i	1.6	54	05.91-03.99	EZ/ABN/1F		2)	LE 007		
							LE 027		
1.6 i	1.6	55	01.93-03.99	1F		2)	LE 007		
							LE 027		
1.6 i	1.6	74	11.96-03.99	AFT			LE 027		
1.8 16V	1.8	98	05.91-03.99	KR			LE 041		
1.8 16V	1.8	92	05.91-03.99	PL			LE 041		
1.8 GT	1.8	102	05.91-11.92	KR			LE 041		
1.8 i	1.8	65	05.91-12.96	RP			LE 041		
1.8 i	1.8	66	11.93-12.96	ADZ/ABS			LE 027		
1.9 D	1.9	47	12.95-03.99	1Y			LE 027		
1.9 D	1.9	50	05.91-03.99	1Y			LE 027		
1.9 TD	1.9	55	05.91-03.99	AAZ			LE 027		
1.9 TDI	1.9	66	08.95-03.99	1Z/AHU			LE 027		
1.9 TDI	1.9	81	11.96-03.99	AFN		2)	LE 007		
							LE 027		
2.0 i	2.0	85	05.91-03.99	2E/AGG			LE 027		
2.0 i 16V	2.0	110	11.93-03.99	ABF			LE 027		
TOLEDO II (1M2)									
1.4 16V	1.4	55	07.99-05.06	AHW/AXP		2)	LE 003		
						2) 3)	LE 033		
1.6	1.6	74	04.99-09.00	AKL/AEH		2)	LE 003		
						2) 3)	LE 033		
1.6 16V	1.6	77	09.00-05.06	AUS/BCB/AZD		2)	LE 003		
						2) 3)	LE 033		
1.8 20V	1.8	92	04.99-05.06	AGN/APG		2)	LE 003		
						2) 3)	LE 033		
1.8 20VT	1.8	132	05.01-05.06	AUQ		2)	LE 003		
						2) 3)	LE 033		
1.9 TDI	1.9	66	04.99-05.06	AGR/ALH		2)	LE 003		
						2) 3)	LE 033		
1.9 TDI	1.9	81	04.99-05.06	AHF/ASV		2)	LE 003		
						2) 3)	LE 033		
1.9 TDI	1.9	96	05.03-05.06	ASZ		2)	LE 003		
						2) 3)	LE 033		
2.3 V5	2.3	110	04.99-05.01	AGZ		2)	LE 003		
						2) 3)	LE 033		
2.3 V5 20V	2.3	125	05.01-05.06	AQN		2)	LE 003		
						2) 3)	LE 033		
TOLEDO III (5P2)									
1.6	1.6	75	10.04-05.09	BGU/CCSA/BSF/BSE			LE 035	LE 584	LE 584Z
1.9 TDI	1.9	77	10.04-	BXE/BKC/BJB/BLS			LE 035	LE 584	LE 584Z
2.0 FSI	2.0	110	10.04-	BLR/BLY/BVZ/BVY			LE 035	LE 584	LE 584Z
2.0 TDI	2.0	100	09.04-05.09	AZV			LE 035	LE 584	LE 584Z
2.0 TDI	2.0	103	11.05-05.09	BMM			LE 035	LE 584	LE 584Z
2.0 TDI	2.0	125	01.06-05.09	CEGA/BMN			LE 035	LE 584	LE 584Z
2.0 TDI 16V	2.0	103	04.04-05.09	BKD			LE 035	LE 584	LE 584Z

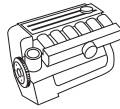
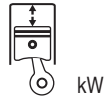
SEAT
TOLEDO III (5P2)

2.0 TFSI	2.0	147	11.05-05.09	BWA	LE 035	LE 584	LE 584Z
----------	-----	-----	-------------	-----	--------	--------	---------

SKODA
FABIA

1.2	1.2	44	12.06-	BBM/CHFA		LE 585	
1.2	1.2	51	01.07-	CEVA/BZG/CGPA		LE 585	
1.4	1.4	63	01.07-	BXW	LE 028	LE 585	
1.4 TDI	1.4	59	01.07-	BMS/BNV		LE 585	
1.6	1.6	77	04.07-	BTS	LE 036	LE 585	
1.9 TDI	1.9	77	04.07-	BSW/BLS		LE 585	

FABIA (6Y2)

1.0	1.0	37	12.99-08.02	AQV/ARV	2)	LE 003	
					2) 3)	LE 033	
1.2	1.2	40	08.02-03.08	AWY/BMD		LE 028	LE 585
1.2	1.2	47	01.03-03.08	AZQ/BME		LE 036	LE 585
1.4	1.4	44	08.00-08.02	AZF/AZE	2)	LE 003	
					2) 3)	LE 033	
1.4	1.4	50	08.99-03.08	AME/ATZ/AQW	2)	LE 003	
					2) 3)	LE 033	
1.4 16V	1.4	55	12.99-03.08	BBY/BKY/AUA	2)	LE 003	
					2) 3)	LE 033	
1.4 16V	1.4	55	12.99-03.08	BBY/BKY/AUA	→ 6Y-44118 574	LE 036	
						LE 039	
1.4 16V	1.4	74	12.99-03.08	BBZ/AUB		LE 036	LE 585
1.4 TDI	1.4	51	10.05-03.08	BNM		LE 044	LE 587
1.4 TDI	1.4	55	04.03-03.08	AMF		LE 028	LE 587
1.4 TDI	1.4	59	10.05-03.08	BNV		LE 044	LE 587
1.9 SDI	1.9	47	12.99-03.08	ASY		LE 028	LE 585
1.9 TDI	1.9	74	01.00-03.08	AXR/ATD	1)	LE 005	
					→ Chassis 6Y-54377711	LE 036	
1.9 TDI RS	1.9	96	06.03-03.08	BLT/ASZ	1)	LE 005	
						LE 036	LE 587
2.0	2.0	85	12.99-03.08	AQY/AZL	1)	LE 005	
						LE 036	LE 587

FABIA Combi

1.2	1.2	44	10.07-	BBM/CHFA		LE 585	
1.2	1.2	51	10.07-	CEVA/BZG/CGPA		LE 585	
1.4	1.4	63	10.07-	BXW	LE 028	LE 585	
1.4 TDI	1.4	59	10.07-	BMS/BNV		LE 585	
1.6	1.6	77	10.07-	BTS	LE 036	LE 585	
1.9 TDI	1.9	77	10.07-	BSW/BLS		LE 585	

FABIA Combi (6Y5)

1.2	1.2	40	07.01-12.07	AWY/BMD		LE 028	LE 585
1.2	1.2	47	01.03-12.07	AZQ/BME		LE 036	LE 585
1.4	1.4	44	04.00-12.07	AZF/AZE	2)	LE 003	
					2) 3)	LE 033	
1.4	1.4	50	04.00-12.07	AME/ATZ/AQW	2)	LE 003	
					2) 3)	LE 033	
1.4 16V	1.4	55	05.00-12.07	BBY/BKY/AUA	2)	LE 003	
					2) 3)	LE 033	
1.4 16V	1.4	55	05.00-12.07	BBY/BKY/AUA	→ 6Y-44118 574	LE 036	
						LE 039	
1.4 16V	1.4	59	04.06-12.07	BUD		LE 028	LE 585
1.4 16V	1.4	74	04.00-12.07	BBZ/AUB		LE 036	LE 585
1.4 TDI	1.4	51	10.05-12.07	BNM		LE 044	LE 587
1.4 TDI	1.4	55	04.03-12.07	AMF		LE 028	LE 587
1.4 TDI	1.4	59	10.05-12.07	BNV		LE 044	LE 587
1.9 SDI	1.9	47	04.00-12.07	ASY	→ 6Y-44118 574	LE 036	
1.9 SDI	1.9	47	04.00-12.07	ASY		LE 039	LE 587



kW

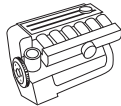

SKODA

FABIA Combi (6Y5)

1.9 TDI	1.9	74	04.00-12.07	AXR/ATD	1)	LE 005	
					→ Chassis 6Y-54377711	LE 036	
						LE 044	LE 585
2.0	2.0	85	04.00-12.07	AZL	1)	LE 005	
						LE 036	LE 587

FABIA Praktik

1.2	1.2	40	07.01-12.07	AWY/BMD		LE 036	
1.2	1.2	47	01.03-12.07	AZQ/BME		LE 036	
1.4	1.4	50	07.01-12.07	AME/ATZ/AQW	2)	LE 003	
					2) 3)	LE 033	
1.9 SDI	1.9	47	07.01-12.07	ASY	→ 6Y-44118 574	LE 036	
1.9 SDI	1.9	47	07.01-12.07	ASY		LE 039	

FABIA Stufenheck (6Y3)

1.2	1.2	40	07.01-12.07	AWY/BMD		LE 036	LE 587
1.2	1.2	47	01.03-12.07	AZQ/BME		LE 028	LE 585
1.4	1.4	44	04.00-08.02	AZF/AZE	2)	LE 003	
					2) 3)	LE 033	
1.4	1.4	50	07.01-12.07	AME/AQW	2)	LE 003	
					2) 3)	LE 033	
1.4 16V	1.4	55	10.99-12.07	BBY/BKY/AUA	2)	LE 003	
					2) 3)	LE 033	
1.4 16V	1.4	55	10.99-12.07	BBY/BKY/AUA	→ 6Y-44118 574	LE 036	
						LE 039	
1.4 16V	1.4	59	04.06-12.07	BUD		LE 028	LE 585
1.4 16V	1.4	74	12.99-12.07	BBZ/AUB		LE 036	LE 585
1.4 TDI	1.4	51	10.05-12.07	BNM		LE 044	LE 587
1.4 TDI	1.4	55	04.03-12.07	AMF		LE 028	LE 587
1.4 TDI	1.4	59	10.05-12.07	BNV		LE 044	LE 587
1.9 SDI	1.9	47	11.99-12.07	ASY		LE 039	LE 585
1.9 TDI	1.9	74	01.00-12.07	AXR/ATD	1)	LE 005	
					→ Chassis 6Y-54377711	LE 036	
2.0	2.0	85	12.99-12.07	AZL	1)	LE 005	
						LE 036	

OCTAVIA (1U2)

1.4	1.4	44	04.99-	AMD	2)	LE 003	
					2) 3)	LE 033	
1.4 16V	1.4	55	09.00-	AXP/BCA	2)	LE 003	
					2) 3)	LE 033	
						LE 040	
1.6	1.6	55	09.96-09.00	AEE	2)	LE 003	
					2) 3)	LE 033	
						LE 040	
1.6	1.6	74	02.97-	AKL/AEH	2)	LE 003	
					2) 3)	LE 033	
						LE 040	
1.6	1.6	75	11.00-	AVU/BFQ	2)	LE 003	
					2) 3)	LE 033	
						LE 040	
1.8	1.8	92	09.96-	AGN	2)	LE 003	
						LE 028	
1.8 T	1.8	110	08.97-	ARX/ARZ/AGU/AUM	2)	LE 003	
						LE 028	
1.8 T 4x4	1.8	110	05.01-	ARX/AGU/AUM	2)	LE 003	
						LE 028	
1.9 SDI	1.9	50	06.97-	AQM/AGP	2)	LE 003	
					2) 3)	LE 033	
1.9 TDI	1.9	66	09.96-	AGR/ALH	2)	LE 003	
					2) 3)	LE 033	

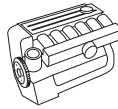
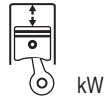

SKODA

OCTAVIA (1U2)

1.9 TDI	1.9	74	10.05-	AXR		LE 028		
1.9 TDI	1.9	81	08.97-	AHF/ASV	2)	LE 003		
					2) 3)	LE 033		
1.9 TDI	1.9	96	01.03-	ASZ	1)	LE 005		
					2) 3)	LE 033		
						LE 045		
2.0	2.0	85	04.99-	APK/AZH/AQY/AEG	2)	LE 003		
					2) 3)	LE 033		
RS 1.8 T	1.8	132	05.01-	AUQ	2)	LE 003		
						LE 028		

OCTAVIA (1Z3)

1.4	1.4	55	05.04-	BCA	2)	LE 003		
					2) 3)	LE 033		
						LE 035		
1.4	1.4	59	06.04-	BUD		LE 035	LE 584	LE 584Z
1.6	1.6	75	06.04-	BGU/CCSA/BSF/BSE		LE 035	LE 584	LE 584Z
1.6 FSI	1.6	85	02.04-	BLF		LE 035	LE 584	LE 584Z
1.9 TDI	1.9	77	06.04-	BXE/BKC/BJB/BLS		LE 035	LE 584	LE 584Z
2.0 TDI	2.0	100	02.04-	AZV		LE 035	LE 584	LE 584Z
2.0 TDI	2.0	103	11.05-	BMM		LE 035	LE 584	LE 584Z
2.0 TDI	2.0	125	04.06-	CEGA/BMN		LE 035	LE 584	LE 584Z
2.0 TDI 16V	2.0	103	02.04-	BKD		LE 035	LE 584	LE 584Z

OCTAVIA Combi (1U5)

1.4 16V	1.4	55	08.00-	AXP/BCA	2)	LE 003		
					2) 3)	LE 033		
						LE 040		
1.6	1.6	55	07.98-	AEE	2)	LE 003		
					2) 3)	LE 033		
						LE 040		
1.6	1.6	74	07.98-	AKL/AEH	2)	LE 003		
					2) 3)	LE 033		
						LE 040		
1.6	1.6	75	09.00-	AVU/BFQ	2)	LE 003		
					2) 3)	LE 033		
						LE 040		
1.8 20V	1.8	92	07.98-	AGN	2)	LE 003		
						LE 028		
1.8 T	1.8	110	07.98-	ARX/ARZ/AGU/AUM	2)	LE 003		
						LE 028		
1.9 SDI	1.9	50	07.98-	AQM/AGP	2)	LE 003		
					2) 3)	LE 033		
1.9 TDI	1.9	66	07.98-	AGR/ALH	2)	LE 003		
					2) 3)	LE 033		
1.9 TDI	1.9	74	08.00-	AXR/ATD	2)	LE 003		
					2) 3)	LE 033		
1.9 TDI	1.9	81	07.98-	AHF/ASV	2)	LE 003		
					2) 3)	LE 033		
1.9 TDI	1.9	96	01.03-	ASZ	2)	LE 003		
					2) 3)	LE 033		
2.0	2.0	85	04.99-	APK/AZH/AZJ/AQY/AEG	2)	LE 003		
					2) 3)	LE 033		
2.0 4x4	2.0	88	01.00-	ATF		LE 028		
RS 1.8 T	1.8	132	08.02-	AUQ	2)	LE 003		
						LE 028		

OCTAVIA Combi (1Z5)

1.4	1.4	59	05.06-	BUD		LE 035	LE 584	LE 584Z
1.6	1.6	75	09.04-	BGU/CCSA/BSF/BSE		LE 035	LE 584	LE 584Z
1.6 FSI	1.6	85	02.04-	BLF		LE 035	LE 584	LE 584Z
1.9 TDI	1.9	77	09.04-	BXE/BKC/BJB/BLS		LE 035	LE 584	LE 584Z
2.0 FSI	2.0	110	11.04-	BVX/BLY/BLR/BVZ/BVY		LE 035	LE 584	LE 584Z



kW

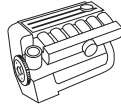

SKODA

OCTAVIA Combi (1Z5)

2.0 TDI	2.0	103	11.05-	BMM	LE 035	LE 584	LE 584Z
2.0 TDI	2.0	125	04.06-	CEGA/BMN	LE 035	LE 584	LE 584Z
2.0 TDI 16V	2.0	100	02.04-	AZV	LE 035	LE 584	LE 584Z
2.0 TDI 16V	2.0	103	02.04-	BKD	LE 035	LE 584	LE 584Z

ROOMSTER (5J)

1.2	1.2	47	05.06-01.07	BME	LE 044	LE 585	
1.2	1.2	51	01.07-	BZG/CGPA	LE 044	LE 585	
1.4	1.4	63	09.06-	BXW	LE 028	LE 585	
1.4 TDI	1.4	51	07.06-	BNM	LE 044	LE 587	
1.4 TDI	1.4	59	09.06-	BMS/BNV	LE 044	LE 585	
1.6	1.6	77	09.06-	BTS	LE 036	LE 585	
1.9 TDI	1.9	77	09.06-	BSW/BLS	LE 044	LE 585	

SUPERB (3T4)

1.4 TSI	1.4	92	07.08-	CAXC	LE 035	LE 584	LE 584Z
1.9 TDI	1.9	77	03.08-	BXE/BLS	LE 035	LE 584	LE 584Z
2.0 TDI	2.0	103	03.08-	BMP	LE 035	LE 584	LE 584Z
2.0 TDI 16V	2.0	103	01.09-	CFFB/CLJA/BKD	LE 035	LE 584	LE 584Z

SUPERB (3U4)

1.8 T	1.8	110	02.02-03.08	AWT		LE 503	
					LK 001		LR 002
1.9 TDI	1.9	74	08.02-10.05	AVB		LE 503	
					LK 001		LR 002
1.9 TDI	1.9	96	02.02-03.08	AWX/AVF		LE 503	
1.9 TDI	1.9	96	02.02-03.08	AWX	LK 001		LR 002
2.0	2.0	85	02.02-03.08	AZM		LE 503	
					LK 001		LR 002
2.0 TDI	2.0	103	10.05-03.08	BSS		LE 503	
2.5 TDI	2.5	114	02.02-08.03	AYM		LE 503	
2.5 TDI	2.5	120	06.03-03.08	BDG		LE 503	
2.8 V6	2.8	142	02.02-03.08	AMX		LE 503	
					LK 004		LR 001

SUPERB Kombi (3T5)

1.4 TSI	1.4	92	10.09-	CAXC	LE 035	LE 584	LE 584Z
2.0 TDI 16V	2.0	103	10.09-	CFFB/CLJA/BKD	LE 035	LE 584	LE 584Z

YETI

1.8 TSI 4x4	1.8	118	05.09-	CDA A	LE 035	LE 584	LE 584Z
2.0 TDI	2.0	81	11.09-	CFHA	LE 035	LE 584	LE 584Z
2.0 TDI 4x4	2.0	103	05.09-	CBDB/CFHC	LE 035	LE 584	LE 584Z
2.0 TDI 4x4	2.0	125	11.09-	CEGA/CFJA	LE 035	LE 584	LE 584Z

TOYOTA

HIACE II Kasten (H20)

2.4 D	2.4	55	05.84-11.89	2L	LK 080		
2.4 D (H5G)	2.4	55	08.84-08.89	2L	LK 080		

HIACE III Kasten (H50)

2.4 D 4WD	2.4	55	08.89-08.95	2L	LK 080		
2.4 Diesel	2.4	55	02.90-08.95	2L	LK 080		
2.4 D (LH102)	2.4	55	08.89-08.95	2L	LK 080		

HIACE IV Kasten

2.4 D (LXH12_, LXH22_)	2.4	58	08.95-	2L	LK 080		
2.4 D	2.4	58	08.95-	2L	LK 080		

LAND CRUISER (LJ7_)

2.4 D (LJ70_)	2.4	53	11.84-10.85	2L	LK 080		
2.4 TD (LJ70_, LJ73_)	2.4	63	10.85-05.90	2L-T	LK 080		

VAUXHALL

ASTRA Mk III

1.4 i	1.4	44	09.91-09.98	C 14 NZ	LE 016		
1.4 i	1.4	44	09.94-09.98	C 14 NZ		LE 563	
1.4 i	1.4	60	03.92-09.98	C 14 SE	LE 016		

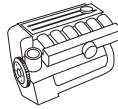
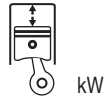

VAUXHALL

ASTRA Mk III					
1.4 i	1.4	60	09.94-09.98	C 14 SE	LE 563
1.4 i 16V	1.4	66	02.96-09.98	X 14 XE	LE 016 LE 563
1.6 i	1.6	52	08.94-07.96	X 16 SZ	LE 016
1.6 i	1.6	52	09.94-07.96	X 16 SZ	LE 563
1.6 i	1.6	55	03.92-09.98	C 16 NZ/X 16 SZR	LE 016
1.6 i	1.6	55	09.94-09.98	C 16 NZ/X 16 SZR	LE 563
1.6 i	1.6	74	05.92-12.94	C 16 SE	LE 016
1.6 i	1.6	74	09.94-12.94	C 16 SE	LE 563
1.6 i 16V	1.6	74	08.94-09.98	X 16 XEL	LE 016 LE 563
1.7 D	1.7	44	09.94-09.98	17 DR	LE 563
1.7 TD	1.7	50	11.94-09.98	X 17 DTL	LE 563
1.7 TD	1.7	60	09.94-09.98	17 DT (TC4EE1)	LE 563
1.8 i	1.8	66	09.94-09.98	C 18 NZ	LE 563
1.8 i 16V	1.8	85	09.94-12.96	C 18 XEL	LE 563
1.8 i 16V	1.8	92	09.94-10.94	C 18 XE	LE 563
2.0 i	2.0	85	09.94-09.98	C 20 NE	LE 563
2.0 i 16V	2.0	100	02.95-09.98	X 20 XEV	LE 563
ASTRA Mk III CC					
1.4 i	1.4	44	09.91-02.98	C 14 NZ	LE 016
1.4 i	1.4	44	09.94-02.98	C 14 NZ	LE 563
1.4 i	1.4	60	03.92-02.98	C 14 SE	LE 016
1.4 i	1.4	60	09.94-02.98	C 14 SE	LE 563
1.4 i 16V	1.4	66	02.96-02.98	X 14 XE	LE 016 LE 563
1.4 S	1.4	55	09.91-02.98	14 NV	LE 016
1.4 S	1.4	55	09.94-02.98	14 NV	LE 563
1.6 i	1.6	52	07.94-02.98	X 16 SZ	LE 016 LE 563
1.6 i	1.6	55	09.94-02.98	C 16 NZ/E 16 NZ	LE 563
1.6 i	1.6	74	03.92-02.98	C 16 SE	LE 016
1.6 i	1.6	74	09.94-02.98	C 16 SE	LE 563
1.6 i 16V	1.6	74	09.94-02.98	X 16 XEL	LE 563
1.7 D	1.7	42	09.94-02.98	17 D	LE 563
1.7 D	1.7	44	09.94-12.94	17 DR	LE 563
1.7 TD	1.7	50	11.94-02.98	X 17 DTL	LE 563
1.7 TD	1.7	60	09.94-02.98	17 DT (TC4EE1)	LE 563
1.8 i	1.8	66	09.94-02.98	C 18 NZ	LE 563
1.8 i 16V	1.8	85	09.94-02.98	C 18 XEL	LE 563
1.8 i 16V	1.8	92	09.94-02.98	C 18 XE	LE 563
2.0 i	2.0	85	09.94-02.98	C 20 NE	LE 563
2.0 i 16V	2.0	100	09.94-02.98	X 20 XEV	LE 563
2.0 i 16V	2.0	110	09.94-02.98	C 20 XE	LE 563
ASTRA Mk III Convertible					
1.4 i	1.4	60	05.93-03.01	C 14 SE	LE 016
1.4 i	1.4	60	09.94-03.01	C 14 SE	LE 563
1.4 i 16V	1.4	66	01.96-03.01	X 14 XE	LE 016 LE 563
1.6	1.6	74	09.94-08.95	C 16 SE	LE 563
1.6 i	1.6	52	03.93-08.96	X 16 SZ	LE 016
1.6 i	1.6	52	09.94-08.96	X 16 SZ	LE 563
1.6 i	1.6	55	01.96-03.01	X 16 SZR	LE 016 LE 563
1.8	1.8	92	09.94-08.96	C 18 XE	LE 563
1.8 16V	1.8	85	11.94-03.01	X 18 XE/C 18 XEL	LE 563
2.0 i	2.0	85	09.94-10.94	C 20 NE	LE 563
ASTRA Mk III Estate					
1.4 i	1.4	44	09.91-02.98	C 14 NZ	LE 016
1.4 i	1.4	44	09.94-02.98	C 14 NZ	LE 563
1.4 i	1.4	60	03.91-02.98	C 14 SE	LE 016
1.4 i	1.4	60	09.94-02.98	C 14 SE	LE 563
1.4 i 16V	1.4	66	02.96-01.98	X 14 XE	LE 016 LE 563
1.4 S	1.4	55	09.91-02.98	14 NV	LE 016
1.4 S	1.4	55	09.94-02.98	14 NV	LE 563
1.6 i	1.6	52	07.94-02.98	X 16 SZ	LE 016 LE 563



kW

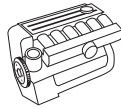

VAUXHALL

ASTRA Mk III Estate

1.6 i	1.6	55	09.91-02.98	C 16 NZ/E 16 NZ	LE 016	
1.6 i	1.6	55	09.94-02.98	C 16 NZ/E 16 NZ		LE 563
1.6 i 16V	1.6	74	01.94-02.98	X 16 XEL	LE 016	
1.6 i 16V	1.6	74	09.94-02.98	X 16 XEL		LE 563
1.6 Si	1.6	74	03.91-12.94	C 16 SE	LE 016	
1.6 Si	1.6	74	09.94-12.94	C 16 SE		LE 563
1.7 D	1.7	42	09.94-02.98	17 D		LE 563
1.7 D	1.7	44	09.94-12.94	17 DR		LE 563
1.7 TD	1.7	50	09.94-02.98	X 17 DTL		LE 563
1.7 TD	1.7	60	09.94-02.98	17 DT (TC4EE1)		LE 563
1.8 i	1.8	66	09.94-02.98	C 18 NZ		LE 563
1.8 i 16V	1.8	85	09.94-02.98	C 18 XEL		LE 563
1.8 i 16V	1.8	92	09.94-02.98	C 18 XE		LE 563
2.0 i	2.0	85	09.94-02.98	C 20 NE		LE 563
2.0 i 16V	2.0	100	09.94-02.98	X 20 XEV		LE 563

CALIBRA

2.0 i	2.0	85	09.94-07.97	C 20 NE		LE 563
2.0 i 16V	2.0	100	09.94-07.97	X 20 XEV		LE 563
2.0 i Turbo 4x4	2.0	150	09.94-07.97	C 20 LET		LE 563
2.5 i V6	2.5	125	09.94-07.97	X 25 XE/C 25 XE		LE 563

CAVALIER Mk III (87)

1.6	1.6	60	09.88-05.93	16 SV	LE 016	
1.6 i	1.6	52	09.93-11.95	X 16 SZ	LE 016	
1.6 i	1.6	55	09.88-11.95	E 16 NZ	LE 016	
1.8	1.8	66	09.88-10.92	C 18 NZ/18 SV	LE 016	
1.8 i KAT	1.8	66	03.90-11.95	C 18 NZ	LE 016	
2.0 i 16V	2.0	110	09.94-11.95	C 20 XE		LE 563
2.0 i KAT	2.0	85	09.94-11.95	C 20 NE		LE 563
2.0 i Turbo 4x4	2.0	150	09.94-11.94	C 20 LET		LE 563
2.0 SRi 16V	2.0	100	09.94-11.95	X 20 XEV		LE 563

CAVALIER Mk III CC

1.6	1.6	60	09.88-05.93	16 SV	LE 016	
1.6 i	1.6	52	09.93-11.95	X 16 SZ	LE 016	
1.6 i	1.6	55	09.88-11.95	E 16 NZ	LE 016	
1.8	1.8	66	09.88-10.90	C 18 NZ/18 SV	LE 016	
1.8 i KAT	1.8	66	03.90-11.95	C 18 NZ	LE 016	
2.0 i 16V	2.0	100	09.94-11.95	X 20 XEV		LE 563
2.0 i 16V	2.0	110	09.94-11.95	C 20 XE		LE 563
2.0 i KAT	2.0	85	09.94-11.95	C 20 NE		LE 563
2.5 V6	2.5	125	09.94-11.95	C 25 XE		LE 563

COMBO

1.6	1.6	64	10.01-	Z 16 SE	LE 017	LE 559
-----	-----	----	--------	---------	--------	--------

CORSA

1.0 i 12V	1.0	40	11.96-09.00	X 10 XE		LE 563
1.2 i	1.2	33	03.93-09.00	C 12 NZ/X 12 SZ	LE 016	
1.2 i	1.2	33	09.94-09.00	C 12 NZ/X 12 SZ		LE 563
1.2 i 16V	1.2	48	03.98-09.00	X 12 XE		LE 563
1.4 i	1.4	44	03.93-09.00	C 14 NZ/X 14 SZ	LE 016	
1.4 i S	1.4	60	09.94-09.00	C 14 SE		LE 563
1.7 D	1.7	44	02.96-09.00	17 D (4EE1)/X 17 D (4EE1)		LE 563

CORSA Mk II

1.0 12V	1.0	43	09.00-10.03	Z 10 XE	LE 017	LE 559
1.0 12V	1.0	44	11.03-	Z 10 XEP	LE 015	→ 54150309
1.0 12V	1.0	44	11.03-	Z 10 XEP		LE 562
1.2 16V	1.2	55	09.00-	Z 12 XE	LE 017	LE 559
1.2 16V Dualfuel	1.2	55	08.01-	Z 12 XE	LE 015	Chassis 23/24/ 26000001 →
						LE 562
1.3 CDTI 16V	1.3	52	04.04-	Z 13 DT	LE 018	Chassis 63/64/ 66000001 →

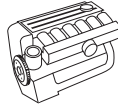
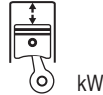

VAUXHALL

CORSA Mk II							
1.4 16V	1.4	66	09.00-	Z 14 XE		LE 017	LE 559
1.7 CDTI 16V	1.7	74	04.04-	Z 17 DTH L2946		LE 018	
1.7 CDTI 16V	1.7	74	04.04-	Z 17 DTH		LE 021	
1.7 DI 16V	1.7	48	09.00-	Y 17 DTL	Chassis 33/34/ 36000001 →	LE 019	
						LE 021	
1.7 DTI 16V	1.7	55	09.00-	Y 17 DT		LE 021	
1.8 16V	1.8	92	09.00-	Z 18 XE		LE 017	LE 559
CORSA Mk III							
1.0	1.0	44	07.06-	Z 10 XEP			LE 564 LE 564Z
1.2	1.2	59	07.06-	Z 12 XEP			LE 564 LE 564Z
1.3 CDTI	1.3	55	07.06-	Z 13 DTJ			LE 578
1.3 CDTI	1.3	66	07.06-	Z 13 DTH			LE 578
1.4	1.4	66	07.06-	Z 14 XEP			LE 564 LE 564Z
1.6 Turbo	1.6	141	02.07-	Z 16 LER			LE 578
1.7 CDTI	1.7	92	07.06-	A 17 DTR			LE 578
CORSAVAN							
1.4 i	1.4	44	01.94-09.00	C 14 NZ		LE 016	
1.4 i	1.4	44	09.94-09.00	C 14 NZ			LE 563
1.5 D	1.5	37	08.94-12.95	15 D			LE 563
1.7 D	1.7	44	09.94-09.00	17 D (4EE1)/X 17 D (4EE1)			LE 563
CORSAVAN MK II							
1.2 16V	1.2	55	09.00-	Z 12 XE		LE 017	LE 559
1.2 16V Dualfuel	1.2	55	08.01-	Z 12 XE	Chassis 23/24/ 26000001 →	LE 015	
							LE 562
1.7 DI 16V	1.7	48	09.00-	Y 17 DTL	→ Chassis 53/54/ 56999999	LE 019	
						LE 021	
1.7 DTI 16V	1.7	55	09.00-	Y 17 DT		LE 021	
NOVA CC							
1.6 GSI	1.6	74	05.88-03.92	E 16 SE		LE 016	
1.6 GSI KAT	1.6	74	02.92-03.93	C 16 SE		LE 016	
TIGRA TwinTop							
1.3 CDTI	1.3	51	06.04-	Z 13 DT	Chassis 6E000001 →	LE 018	
						LE 021	
1.4	1.4	66	06.04-	Z 14 XEP	→ Chassis 4E999999	LE 015	
							LE 562
1.8	1.8	92	06.04-	Z 18 XE		LE 015	LE 562

VOLVO

240 (P242, P244)							
2.0	2.0	60	08.74-07.76	B 20 A		LK 084	
2.0	2.0	66	08.76-07.79	B 19 A		LK 084	
2.0	2.0	71	09.78-08.83	B 19 A/B 19 K		LK 084	
2.0	2.0	76	08.84-07.85	B 200 K		LK 084	
2.1	2.1	71	08.74-07.75	B 21 A		LK 084	
2.1	2.1	74	08.75-07.80	B 21 A		LK 084	
2.1	2.1	79	08.80-07.84	B 21 A		LK 084	
2.1	2.1	90	08.74-07.80	B 21 E		LK 084	
2.1 Turbo	2.1	114	08.80-07.84	B 21 ET		LK 084	
2.3	2.3	100	08.80-07.83	B 23 E/B 230 FX		LK 084	
2.3	2.3	103	08.78-07.80	B 23 E		LK 084	
2.3	2.3	81	08.84-07.86	B 230 A		LK 084	
2.3	2.3	82	08.80-07.84	B 23 A		LK 084	
2.3	2.3	83	08.86-07.87	B 230 F		LK 084	
2.3	2.3	85	08.86-12.88	B 230 K		LK 084	
2.3	2.3	96	08.83-07.85	B 230 E		LK 084	



kW

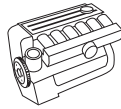

VOLVO

240 (P242, P244)

2.3	2.3	98	08.84-12.89	B 23 E	LK 084
2.3 i KAT	2.3	85	08.86-07.93	B 230 F	LK 084

240 Kombi (P245)

2.0	2.0	60	08.74-07.75	B 20 A	LK 084
2.0	2.0	66	08.76-01.82	B 19 A	LK 084
2.0	2.0	71	08.80-12.84	B 19 A/B 19 K	LK 084
2.0	2.0	76	08.84-07.85	B 200 K	LK 084
2.0	2.0	86	08.83-07.93	B 200 E	LK 084
2.1	2.1	71	08.74-07.75	B 21 A	LK 084
2.1	2.1	74	08.75-07.80	B 21 A	LK 084
2.1	2.1	79	08.80-07.84	B 21 A	LK 084
2.1	2.1	80	08.80-07.84	B 21 F	LK 084
2.1	2.1	90	08.74-07.79	B 21 E	LK 084
2.1 Turbo	2.1	114	08.80-07.85	B 21 ET	LK 084
2.3	2.3	100	01.83-12.84	B 23 E	LK 084
2.3	2.3	81	08.84-07.86	B 230 A	LK 084
2.3	2.3	82	08.80-07.84	B 23 A	LK 084
2.3	2.3	83	08.86-07.87	B 230 F	LK 084
2.3	2.3	85	08.86-12.88	B 230 K	LK 084
2.3	2.3	96	08.84-07.85	B 230 E	LK 084
2.3	2.3	98	08.84-12.88	B 23 E	LK 084
2.3 KAT	2.3	100	08.91-07.92	B 230 F	LK 084
2.3 i KAT	2.3	85	08.86-07.93	B 230 F	LK 084

740 (744)

2.0	2.0	89	08.85-07.92	B 200 G	LK 084
2.3	2.3	83	09.85-12.89	B 230 F	LK 084
2.3	2.3	84	08.84-07.90	B 23 A/B 230 F	LK 084
2.3	2.3	85	08.87-07.92	B 230 F	LK 084
2.3	2.3	86	08.86-07.88	B 230 K	LK 084
2.3	2.3	95	08.83-07.84	B 23 E	LK 084
2.3	2.3	96	08.84-07.88	B 230 E	LK 084
2.3	2.3	100	08.88-07.90	B 230 FB	LK 084
2.3	2.3	111	08.88-08.92	B 234 F	LK 084
2.3	2.3	114	08.88-07.91	B 234 F	LK 084
2.3	2.3	117	08.87-07.89	B 234 F	LK 084

740 Kombi (745)

2.3	2.3	83	08.85-12.89	B 230 F	LK 084
2.3	2.3	84	09.85-07.90	B 230 K	LK 084
2.3	2.3	85	08.87-07.92	B 230 F	LK 084
2.3	2.3	100	08.89-07.90	B 230 FB	LK 084
2.3	2.3	111	07.89-08.92	B 234 F	LK 084
2.3	2.3	114	08.88-07.90	B 234 F	LK 084
2.3	2.3	117	08.87-07.89	B 234 F	LK 084
2.4 TD Interc.	2.4	90	08.86-07.88	D 24 TIC	LK 083

760 (704, 764)

2.3 Turbo (704)	2.3	127	08.82-07.84	B 23 ET	LK 085
2.3 Turbo (704)	2.3	134	08.84-10.88	B 230 ET	LK 085
2.4 TD Interc. (704)	2.4	85	08.87-07.92	D 24 TIC	→ Volvo 1328835 → Volvo 1274963
2.4 Turbo Diesel (704)	2.4	80	04.87-07.92	D 24 T	LK 085
2.4 Turbo Diesel (704)	2.4	82	08.82-07.87	D 24 T	LK 085
2.8	2.8	95	01.82-12.87	B 28 A	LK 085
2.8 (704)	2.8	105	05.86-08.91	B 280 F	LK 085
2.8 (704, 764)	2.8	115	08.81-07.88	B 280 E/B 28 E	LK 085
2.8 (764)	2.8	108	08.86-07.90	B 280 F	LK 085

760 Kombi (704, 765)

2.4 TD Interc. (765)	2.4	85	08.87-07.92	D 24 TIC	→ Volvo 1328835 → Volvo 1274963
2.8 (765)	2.8	95	05.86-12.87	B 28 A	LK 085
2.8 (765)	2.8	105	05.86-08.91	B 280 F	LK 085



¹⁾ Mit Klimaanlage

²⁾ Mit Anhängervorrichtung

³⁾ Für tropisches Klima

⁴⁾ Automatik

⁵⁾ Schaltgetriebe

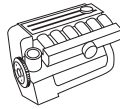
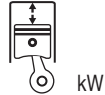

VOLVO							
760 Kombi (704, 765)							
2.8 (765)	2.8	115	08.86–08.90	B 280 E/B 28 E			LK 085
940 (944)							
2.3	2.3	85	08.92–07.94	B 230 FD			LK 084
2.3	2.3	96	08.90–12.94	B 230 G/B 230 FB			LK 084
2.4 TD Intercooler	2.4	90	08.90–12.94	D 24 TIC			LK 083
940 II (944)							
2.3	2.3	85	08.94–07.95	B 230 FD			LK 084
2.3	2.3	96	08.94–10.98	B 230 FB			LK 084
2.4 TD Interc.	2.4	90	08.94–10.98	D 24 TIC			LK 083
940 II Kombi (945)							
2.3	2.3	85	08.94–07.95	B 230 FD			LK 084
2.3	2.3	96	08.94–10.98	B 230 FB			LK 084
2.3 ti	2.3	99	01.95–10.98	B 230 FK			LK 084
2.4 TD Interc.	2.4	90	08.94–10.98	D 24 TIC			LK 083
960 (964)							
2.4 TD Interc.	2.4	85	09.91–07.94	D 24 TIC	→ Volvo 1328835		LK 083
					→ Volvo 1274963		LK 085
2.9	2.9	150	08.90–07.94	B 6304 F			LK 085
960 II (964)							
2.5	2.5	125	07.94–12.96	B 6254 S			LK 085
2.9	2.9	150	07.94–12.96	B 6304 S			LK 085
960 II Kombi (965)							
2.5	2.5	125	08.94–12.96	B 6254 S			LK 085
2.9	2.9	150	09.94–12.96	B 6304 S			LK 085

VW							
BORA (1J2)							
1.4 16V	1.4	55	03.00–05.05	AHW/AXP/BCA/APE/AKQ	2)		LE 003
					2) 3)		LE 033
							LE 040
1.6	1.6	74	10.98–05.05	AKL/APF/AEH	2)		LE 003
					2) 3)		LE 033
1.6 16V	1.6	77	05.00–05.05	AUS/ATN/BCB/AZD	2)		LE 003
					2) 3)		LE 033
							LE 040
1.6 FSI	1.6	81	01.02–05.05	BAD	2)		LE 003
					2) 3)		LE 033
							LE 040
1.8	1.8	92	10.98–05.05	AGN/BAF	2)		LE 003
1.8 T	1.8	110	05.00–05.05	ARX/BAE/AGU/AUM	1)		LE 005
1.8 T	1.8	132	03.02–05.05	AUQ	2)		LE 003
							LE 028
1.9 SDI	1.9	50	10.98–05.05	AGP/AQM	2)		LE 003
					2) 3)		LE 033
1.9 TDI	1.9	66	10.98–06.01	AGR/ALH	2)		LE 003
					2) 3)		LE 033
1.9 TDI	1.9	74	09.00–05.05	AXR/ATD	2)		LE 003
					2) 3)		LE 033
1.9 TDI	1.9	81	10.98–06.01	AHF/ASV	2)		LE 003
					2) 3)		LE 033
1.9 TDI	1.9	85	12.98–06.01	AJM/AUY	2)		LE 003
							LE 028
1.9 TDI	1.9	85	12.98–06.01	AJM			LK 001
1.9 TDI	1.9	96	11.00–05.05	ASZ			LE 003
					2) 3)		LE 033
1.9 TDI 4motion	1.9	66	02.99–06.01	AGR	2)		LE 003
					2) 3)		LE 033
							LE 045
1.9 TDI 4motion	1.9	74	09.00–05.05	ATD	2)		LE 003
					2) 3)		LE 033



kW

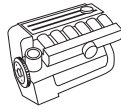

VW

BORA (1J2)

1.9 TDI 4motion	1.9	85	02.99-06.01	AJM/AUY	2)	LE 003	
						LE 028	
1.9 TDI 4motion	1.9	85	02.99-06.01	AJM		LK 001	
1.9 TDI 4motion	1.9	96	11.00-05.05	ASZ	2)	LE 003	
					2) 3)	LE 033	
2.0	2.0	85	10.98-05.05	APK/AZH/AZJ/AQY/AZG/BBW	2)	LE 003	
					2) 3)	LE 033	
2.0 4motion	2.0	85	04.00-05.05	AZH/AZJ	2)	LE 003	
					2) 3)	LE 033	
2.3 V5	2.3	110	10.98-10.00	AGZ	2)	LE 003	
					2) 3)	LE 033	
						LE 045	
2.3 V5 4motion	2.3	110	12.98-10.00	AGZ	2)	LE 003	
					2) 3)	LE 033	
						LE 045	

BORA Kombi (1J6)

1.4 16V	1.4	55	09.01-05.05	AHW/AXP/BCA	2)	LE 003	
					2) 3)	LE 033	
						LE 040	
1.6	1.6	74	05.99-05.05	AKL/APF/AEH	2)	LE 003	
					2) 3)	LE 033	
1.6	1.6	75	08.00-05.05	AVU/BFQ	2)	LE 003	
					2) 3)	LE 033	
1.6 16V	1.6	77	02.00-05.05	AUS/ATN/BCB/AZD	2)	LE 003	
					2) 3)	LE 033	
						LE 040	
1.6 FSI	1.6	81	01.02-05.05	BAD	2)	LE 003	
					2) 3)	LE 033	
1.8 4motion	1.8	92	05.99-05.05	AGN	2)	LE 003	
1.8 T	1.8	110	05.00-05.05	ARX/AGU/AUM	1)	LE 005	
1.8 T	1.8	132	05.02-05.05	AUQ	1)	LE 005	
					2) 3)	LE 033	
						LE 045	
1.9 SDi	1.9	50	06.01-05.05	AQM		LE 028	
1.9 TDI	1.9	66	05.99-06.01	AGR	2)	LE 003	
					2) 3)	LE 033	
						LE 045	
1.9 TDI	1.9	74	09.00-05.05	AXR/ATD	2)	LE 003	
					2) 3)	LE 033	
1.9 TDI	1.9	81	05.99-06.01	AHF/ASV	2)	LE 003	
						LE 028	
1.9 TDI	1.9	85	05.99-06.01	AJM/AUY	2)	LE 003	
						LE 028	
1.9 TDI	1.9	85	05.99-06.01	AJM		LK 001	
1.9 TDI	1.9	96	11.00-05.05	ASZ	2)	LE 003	
					2) 3)	LE 033	
1.9 TDI 4motion	1.9	74	09.00-05.05	ATD	2)	LE 003	
					2) 3)	LE 033	
1.9 TDI 4motion	1.9	85	05.99-06.01	AJM/AUY	2)	LE 003	
						LE 028	
1.9 TDI 4motion	1.9	85	05.99-06.01	AJM		LK 001	
1.9 TDI 4motion	1.9	96	11.00-05.05	ASZ	2)	LE 003	
					2) 3)	LE 033	
2.0	2.0	85	05.99-05.05	APK/AZH/AZJ/AQY/AZG	2)	LE 003	
					2) 3)	LE 033	
2.0 4motion	2.0	85	04.00-05.05	AZH/AZJ	2)	LE 003	
					2) 3)	LE 033	
2.3 V5	2.3	110	05.99-10.00	AGZ	2)	LE 003	
						LE 045	

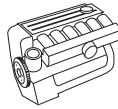
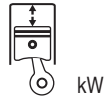

VW

BORA Kombi (1J6)

2.3 V5 4motion	2.3	110	05.99-10.00	AGZ	2)	LE 003		
						LE 045		

CADDY I (14)

1.5	1.5	51	08.82-07.83	JB	2)	LE 007		
1.6	1.6	55	01.83-07.92	EW	2)	LE 007		
1.6 D	1.6	40	08.82-07.92	JK/ME	2)	LE 007		
1.8	1.8	70	08.85-07.92	JH	2)	LE 007		

CADDY II (9K9A)

1.9 D	1.9	47	11.95-01.04	1Y		LE 027		
1.9 SDI	1.9	47	11.95-01.04	AYQ/AEY	2)	LE 007		
						LE 027		
1.9 TDI	1.9	66	09.96-01.04	1Z/AHU/ALH		LE 027		
60 1.4	1.4	44	11.95-01.04	AEX/APQ/AUD		LE 027		
75 1.6	1.6	55	11.95-09.00	AEE	2)	LE 007		
75 1.6	1.6	55	11.95-05.97	1F		LE 027		

CADDY II (9K9B)

1.4	1.4	44	11.95-01.04	AEX/AKV/APQ/AUD		LE 027		
1.6	1.6	55	11.95-05.97	1F		LE 027		
1.6	1.6	55	06.97-09.00	AEE	2)	LE 007		
1.9 D	1.9	47	11.95-01.04	1Y		LE 027		
1.9 SDI	1.9	47	11.95-01.04	AYQ/AEY	2)	LE 007		
						LE 027		
1.9 TDI	1.9	66	10.96-01.04	ALE/AHU/ALH		LE 027		

CADDY III (2KA, 2KH)

1.4	1.4	55	03.04-	BCA		LE 035	LE 584	LE 584Z
1.4 16V	1.4	59	05.06-	BUD		LE 046		
1.6	1.6	75	04.04-	BGU/BSF/BSE		LE 035	LE 584	LE 584Z
1.9 TDI	1.9	55	09.05-	BSU		LE 035	LE 584	LE 584Z
1.9 TDI	1.9	77	04.04-	BJB/BLS		LE 035	LE 584	LE 584Z
2.0 EcoFuel	2.0	80	04.06-	BSX		LE 035	LE 584	LE 584Z
2.0 SDI	2.0	51	03.04-	BST/BDJ		LE 035	LE 584	LE 584Z
2.0 TDI	2.0	103	09.07-	BMM		LE 035	LE 584	LE 584Z

CADDY III (2KB, 2KJ)

1.4	1.4	55	03.04-	BCA		LE 035	LE 584	LE 584Z
1.6	1.6	75	04.04-	BGU/BSF/BSE		LE 035	LE 584	LE 584Z
1.9 TDI	1.9	55	09.05-	BSU		LE 035	LE 584	LE 584Z
1.9 TDI	1.9	77	04.04-	BJB/BLS		LE 035	LE 584	LE 584Z
					Chassis 70251 →		LE 584	LE 584Z
1.9 TDI 4motion	1.9	77	05.08-	BLS		LE 035	LE 584	LE 584Z
2.0 EcoFuel	2.0	80	04.06-	BSX		LE 035	LE 584	LE 584Z
2.0 SDI	2.0	51	03.04-	BST/BDJ		LE 035	LE 584	LE 584Z
2.0 TDI	2.0	103	09.07-	BMM		LE 035	LE 584	

CORRADO (53I)

1.8 16V	1.8	100	04.89-07.92	KR	2)	LE 007		
2.9 VR6	2.9	140	08.91-12.95	ABV		LE 027		

DERBY (86)

0.9	0.9	29	02.77-09.81	HA		LE 001		
					2)	LE 007		
1.1	1.1	37	02.77-09.81	HB		LE 001		
					2)	LE 007		
1.3	1.3	43	02.77-09.81	HJ		LE 001		
1.3	1.3	44	02.77-09.81	HH		LE 001		
					2)	LE 007		

DERBY (86C, 80)

1.0	1.0	29	10.81-12.84	GL		LE 001		
					2)	LE 007		
1.0	1.0	33	08.81-12.84	HZ		LE 001		
					2)	LE 007		



kW

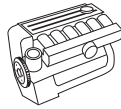

VW

DERBY (86C, 80)

1.1	1.1	37	10.81-07.83	HB		LE 001		
					2)	LE 007		
1.3	1.3	37	08.83-12.84	HW		LE 001		
1.3	1.3	40	08.83-12.84	HK		LE 001		
					2)	LE 007		
1.3	1.3	44	08.81-07.83	HH		LE 001		
					2)	LE 007		
1.3	1.3	55	09.82-12.84	GK		LE 001		
					2)	LE 007		

EOS (1F7)

1.4 TSI	1.4	90	05.08-	CAXA		LE 035	LE 584	LE 584Z
1.4 TSI	1.4	118	05.08-	CAVD		LE 035	LE 584	LE 584Z
1.6 FSI	1.6	85	06.06-	BLF		LE 035	LE 584	LE 584Z
2.0 FSI	2.0	110	03.06-	BVZ/BVY		LE 035	LE 584	LE 584Z
2.0 TDI	2.0	103	06.06-05.08	BMM		LE 035	LE 584	LE 584Z
2.0 TFSI	2.0	147	03.06-	BWA/BPY/CBFA/CCZA/CAWB/CCTA		LE 035	LE 584	LE 584Z
3.6 V6	3.6	191	05.09-	CDVA		LE 035	LE 584	LE 584Z

FOX (5Z1)

1.2	1.2	40	04.05-	BMD		LE 028	LE 585	
1.4	1.4	55	04.05-	BKR	→ Chassis 5Z-60025500	LE 036		
						LE 039	LE 585	
1.4 TDI	1.4	51	04.05-	BNM		LE 044	LE 587	

GOLF I (17)

1.1	1.1	37	04.74-07.83	GG/FA		LE 001		
					2)	LE 007		
1.1	1.1	38	01.81-07.83	FJ		LE 001		
					2)	LE 007		
1.1	1.1	44	01.81-07.83	HC		LE 001		
1.3	1.3	43	08.82-12.83	GS		LE 001		
1.3	1.3	44	08.79-07.83	GF		LE 001		
					2)	LE 007		
1.5	1.5	51	08.77-07.83	JB		LE 001		
					2)	LE 007		
1.5	1.5	51	04.74-12.75	FH		LE 001		
					2)	LE 007		
1.5 D	1.5	37	08.76-07.80	CK		LE 001		
					2)	LE 007		
1.6	1.6	51	08.75-07.77	FT		LE 001		
1.6	1.6	55	08.75-02.84	FN/FP/EM		LE 001		
					2)	LE 007		
1.6	1.6	55	01.83-02.84	EW/HN		LE 001		
					2)	LE 007		
1.6 D	1.6	40	08.80-07.83	JK/CR		LE 001		
					2)	LE 007		
1.6 D	1.6	44	01.82-07.84			LE 001		
1.6 GTI	1.6	81	08.76-07.82	EG		LE 001		
					2)	LE 007		
1.6 TD	1.6	51	03.82-07.83	CY		LE 001		
					2)	LE 007		
1.6 TD	1.6	55	08.83-07.85			LE 001		
1.8 GTI	1.8	82	08.82-12.83	JJ/DX		LE 001		
					2)	LE 007		

GOLF I Cabriolet (155)

1.3	1.3	40	08.83-07.86	HK		LE 001		
1.5	1.5	51	01.79-11.83	JB		LE 001		
					2)	LE 007		
1.6	1.6	51	08.83-07.87	EWA		LE 001		
1.6	1.6	53	04.86-02.90	RE		LE 001		
					2)	LE 007		

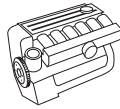
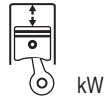

VW

GOLF I Cabriolet (155)

1.6	1.6	55	08.83-04.92	EW/HN		LE 001
					2)	LE 007
1.6	1.6	81	08.79-07.82	EG		LE 001
					2)	LE 007
1.8	1.8	66	08.83-09.92	EX		LE 001
					2)	LE 007
1.8	1.8	70	08.83-04.93	JH		LE 041
1.8	1.8	72	08.89-03.93	2H		LE 041
1.8	1.8	82	08.82-12.89	EV/PB/DX		LE 001

GOLF II (19E, 1G1)

1.0	1.0	33	11.83-08.85	GN		LE 001
					2)	LE 007
1.0	1.0	37	08.85-10.91	HZ		LE 001
					2)	LE 007
1.3	1.3	37	08.85-12.87	NU		LE 001
1.3	1.3	40	08.83-06.87	MH/HK		LE 001
					2)	LE 007
1.3	1.3	43	08.83-10.86	GT		LE 001
1.3 KAT	1.3	40	06.86-12.92	NZ/2G/MH		LE 001
					2)	LE 007
1.6	1.6	51	10.86-12.92	PN		LE 001
					2)	LE 007
1.6	1.6	53	02.86-10.91	RF		LE 001
					2)	LE 007
1.6	1.6	55	08.83-07.92	HM/ABN/EZ		LE 001
					2)	LE 007
1.6 D	1.6	40	08.83-10.91	ME/JP		LE 001
					2)	LE 007
1.6 TD	1.6	44	08.89-10.91	1V		LE 007
1.6 TD	1.6	51	08.83-10.91	JR/MF		LE 007
1.6 TD	1.6	59	04.89-10.91	RA/SB		LE 007
1.8	1.8	62	08.86-01.90	RH		LE 001
					2)	LE 007
1.8	1.8	66	08.84-10.91	GX/GU/HV		LE 001
					2)	LE 007
1.8 Syncro	1.8	66	02.86-07.91	GX/GU		LE 001
					2)	LE 007
1.8 GTI	1.8	79	08.85-10.87	RD		LE 041
1.8 GTI	1.8	82	08.83-10.91	EV/GZ/PB/DX		LE 001
					2)	LE 007
1.8 GTI 16V	1.8	95	02.86-10.91	PL		LE 001
					2)	LE 007
1.8 GTI 16V	1.8	102	02.86-06.90	KR		LE 001
					2)	LE 007
1.8 GTI KAT	1.8	79	01.87-10.91	PF		LE 001
1.8 i KAT	1.8	66	08.87-10.91	GX/RP		LE 001
					2)	LE 007
1.8 i Syncro KAT	1.8	66	08.87-10.91	RP		LE 001
					2)	LE 007

GOLF III (1H1)

1.4	1.4	40	11.91-08.97	AEX/ABD		LE 029
1.4	1.4	44	10.91-08.97	AEX/ABD		LE 029
1.6	1.6	55	09.92-08.97	ABU/AEA/AEE		LE 029
1.6	1.6	74	07.95-08.97	AEK/AFT/AKS		LE 029
1.8	1.8	55	11.91-08.97	AAM		LE 029
1.8	1.8	66	11.91-08.97	ACC/ADZ/ABS		LE 029
1.8 Syncro (1HX1)	1.8	66	01.93-08.97	ADZ/ABS		LE 029
1.9 D	1.9	48	11.91-08.97	1Y		LE 038
1.9 SDI	1.9	47	07.95-08.97	AEY		LE 029
1.9 TD,GTD	1.9	55	11.91-08.97	AAZ		LE 042



kW

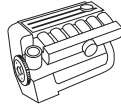

VW

GOLF III (1H1)

1.9 TDI	1.9	66	09.93-08.97	ALE/1Z/AHU		LE 029
1.9 TDI	1.9	81	04.96-08.97	AFN		LE 029
1.9 TDI Syncro (1HX1)	1.9	66	08.95-08.97	ALE/1Z/AHU		LE 029
2.0	2.0	85	11.91-08.97	ADY/AKR/2E/AGG		LE 029
2.0 Syncro (1HX1)	2.0	85	08.95-08.97	AGG		LE 029
2.0 GL	2.0	79	08.95-09.97	AEP		LE 029
2.0 GTI 16V	2.0	110	08.92-08.97	ABF		LE 029
2.8 VR6	2.8	128	01.92-01.96	AAA		LE 043
2.8 VR6	2.8	120	08.95-09.97	AAA	→ Chassis 1H-TP049074	LE 043

GOLF III Cabriolet (1E7)

1.6	1.6	74	10.94-05.98	AEK/AFT/AKS		LE 029
1.8	1.8	55	07.93-05.98	AAM		LE 029
1.8	1.8	66	07.93-05.98	ADZ/ABS		LE 029
1.9 TDI	1.9	66	08.95-05.98	ALE/1Z/AHU		LE 029
1.9 TDI	1.9	81	07.96-05.98	AFN		LE 029
2.0	2.0	85	07.93-05.98	ADY/AKR/2E/AGG		LE 029

GOLF III Variant (1H5)

1.4	1.4	40	07.93-04.99	ABD		LE 029
1.4	1.4	44	07.93-04.99	AEX/ABD/APQ		LE 029
1.6	1.6	55	07.93-12.97	ABU/AEA/AEE		LE 029
1.6	1.6	74	07.94-04.99	AEK/AFT/AKS		LE 029
1.8	1.8	55	07.93-04.99	ANN/AAM		LE 029
1.8	1.8	66	07.93-04.99	ADZ/ABS/ANP		LE 029
1.8 Syncro	1.8	66	10.94-04.99	ADZ		LE 029
1.9 D	1.9	48	07.93-04.99	1Y		LE 038
1.9 SDI	1.9	47	07.95-04.99	AEY		LE 029
1.9 TD	1.9	55	07.93-04.99	AAZ		LE 042
1.9 TDI	1.9	66	03.94-04.99	ALE/1Z/AHU		LE 029
1.9 TDI	1.9	81	04.96-04.99	AFN		LE 029
1.9 TDI Syncro	1.9	66	07.95-04.99	ALE/1Z/AHU		LE 029
2.0	2.0	79	08.95-04.96	AEP		LE 029
2.0	2.0	85	07.93-04.99	ADY/AKR/2E/AGG		LE 029
2.0 Syncro	2.0	85	08.95-04.99	AGG		LE 029

GOLF IV (1J1)

1.4 16V	1.4	55	08.97-06.05	AHW/AXP/BCA/APE/AKQ	2)	LE 003
					2) 3)	LE 033
1.6	1.6	74	08.97-02.00	AKL/APF/AEH	2)	LE 003
					2) 3)	LE 033
						LE 045
1.6	1.6	75	08.00-06.05	AVU/BFQ/BJH	2)	LE 003
					2) 3)	LE 033
1.6	1.6	78	08.03-06.05	AWB		LE 028
1.6 16V	1.6	77	02.00-06.05	AUS/ATN/BCB/AZD	2)	LE 003
					2) 3)	LE 033
1.6 FSI	1.6	81	01.02-06.05	BAD	2)	LE 003
					2) 3)	LE 033
						LE 040
1.8	1.8	92	08.97-06.05	AGN/BAF	2)	LE 003
					2) 3)	LE 033
						LE 045
1.8 4motion	1.8	92	05.98-06.05	AGN	2)	LE 003
					2) 3)	LE 033
1.8 T	1.8	110	08.97-06.05	ARZ/AQA/AGU/AUM/AWD	2)	LE 003
					2) 3)	LE 033
1.8 T GTI	1.8	132	08.01-06.05	AUQ	2)	LE 003
					2) 3)	LE 033
1.9 SDI	1.9	50	08.97-06.05	AGP/AQM	2)	LE 003
					2) 3)	LE 033

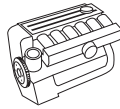
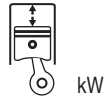

VW

GOLF IV (1J1)

1.9 TDI	1.9	66	10.97-05.04	AGR/ALH	2) 2)3)	LE 003 LE 033
1.9 TDI	1.9	74	09.00-06.05	AXR/ATD	2) 2)3)	LE 003 LE 033
1.9 TDI	1.9	81	08.97-05.04	AHF/ASV	2) 2)3)	LE 003 LE 033
1.9 TDI	1.9	85	12.98-06.01	AJM/AUY	2) 2)3)	LE 003 LE 033 LE 045
1.9 TDI	1.9	85	12.98-06.01	AJM		LK 001
1.9 TDI	1.9	96	11.00-06.05	ASZ	2) 2)3)	LE 003 LE 033
1.9 TDI 4motion	1.9	66	07.98-04.02	AGR/ALH	2) 2)3)	LE 003 LE 033
1.9 TDI 4motion	1.9	74	09.00-06.05	ATD	2) 2)3)	LE 003 LE 033
1.9 TDI 4motion	1.9	85	09.99-06.01	AJM/AUY	2) 2)3)	LE 003 LE 033 LE 045
1.9 TDI 4motion	1.9	85	09.99-06.01	AJM		LK 001
1.9 TDI 4motion	1.9	96	11.00-06.05	ASZ	2) 2)3)	LE 003 LE 033
2.0	2.0	85	07.98-06.05	APK/AZJ/AQY/AZG	2) 2)3)	LE 003 LE 033
2.0 4motion	2.0	85	10.00-06.05	AZH/AZJ	2) 2)3)	LE 003 LE 033
2.3 V5	2.3	110	08.97-10.00	AGZ	2) 2)3)	LE 003 LE 033 LE 045
2.3 V5 4motion	2.3	110	12.98-10.00	AGZ	2) 2)3)	LE 003 LE 033 LE 045

GOLF IV Cabriolet (1E7)

1.6	1.6	74	06.98-06.02	AFT/AKS		LE 038
1.8	1.8	55	06.98-06.02	ANN/AAM		LE 038
1.8	1.8	66	06.98-06.02	ADZ/ANP		LE 038
1.9 TDI	1.9	66	06.98-06.02	ALE/AHU		LE 038
1.9 TDI	1.9	81	06.98-06.02	AVG/AFN		LE 038
2.0	2.0	85	06.98-06.02	ATU/AKR/AWF/AGG/AWG		LE 038

GOLF IV Variant (1J5)

1.4 16V	1.4	55	05.99-06.06	AHW/AXP/BCA/APE/AKQ	2) 2)3)	LE 003 LE 033
1.6	1.6	74	05.99-02.00	AKL/APF/AEH	2) 2)3)	LE 003 LE 033
1.6	1.6	75	08.00-06.06	AVU	2) 2)3)	LE 003 LE 033 LE 045
1.6 16V	1.6	77	02.00-06.06	AUS/ATN/BCB/AZD	2) 2)3)	LE 003 LE 033
1.6 FSI	1.6	81	01.02-06.06	BAD	2) 2)3)	LE 003 LE 033
1.8 4motion	1.8	92	05.99-06.06	AGN	2) 2)3)	LE 003 LE 033 LE 045
1.8 T	1.8	110	05.00-06.06	ARZ/AQA/AGU/AUM/AWD	2) 2)3)	LE 003 LE 033
1.9 SDI	1.9	50	05.99-06.06	AGP/AQM	2) 2)3)	LE 003 LE 033
1.9 TDI	1.9	66	05.99-05.06	AGR/ALH	2) 2)3)	LE 003 LE 033



kW

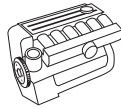

VW

GOLF IV Variant (1J5)

1.9 TDI	1.9	74	09.00-06.06	AXR/ATD	2)	LE 003		
					2) 3)	LE 033		
1.9 TDI	1.9	81	05.99-06.01	AHF/ASV	2)	LE 003		
					2) 3)	LE 033		
						LE 045		
1.9 TDI	1.9	85	08.99-06.01	AJM/AUY	2)	LE 003		
						LE 028		
1.9 TDI	1.9	96	11.00-06.06	ASZ	2)	LE 003		
					2) 3)	LE 033		
1.9 TDI 4motion	1.9	66	05.99-04.02	AGR/ALH	2)	LE 003		
						LE 045		
1.9 TDI 4motion	1.9	74	09.00-06.06	ATD	2)	LE 003		
					2) 3)	LE 033		
1.9 TDI 4motion	1.9	85	05.99-06.01	AJM	2)	LE 003		
						LE 028		
1.9 TDI 4motion	1.9	96	11.00-06.06	ASZ	2)	LE 003		
					2) 3)	LE 033		
2.0	2.0	85	05.99-06.06	APK/AZJ/AQY	2)	LE 003		
2.0 4motion	2.0	85	10.00-06.06	AZH/AZJ	2)	LE 003		
					2) 3)	LE 033		
2.0 Bi-Fuel	2.0	85	02.02-06.06	BEH	2)	LE 003		
						LE 028		
2.3 V5	2.3	110	05.99-06.06	AGZ	2)	LE 003		
					2) 3)	LE 033		
						LE 045		
2.3 V5 4motion	2.3	110	05.99-06.06	AGZ	2)	LE 003		
					2) 3)	LE 033		
						LE 045		

GOLF PLUS (5M1, 521)

1.4 16V	1.4	55	01.05-	BCA		LE 035	LE 584	LE 584Z
1.4 16V	1.4	59	01.05-	BUD/CGGA		LE 035	LE 584	LE 584Z
1.4 TSI	1.4	90	06.07-	CAXA		LE 035	LE 584	LE 584Z
1.4 TSI	1.4	118	06.08-	CAVD		LE 035	LE 584	LE 584Z
1.4 TSI	1.4	125	05.06-	BLG		LE 035	LE 584	LE 584Z
1.6	1.6	75	05.05-	CCSA/BSF/BSE		LE 035	LE 584	LE 584Z
1.6 FSI	1.6	85	01.05-	BLF		LE 035	LE 584	LE 584Z
1.6 MultiFuel	1.6	75	11.07-	CCSA/CHGA		LE 035	LE 584	LE 584Z
1.6 TDI	1.6	77	03.09-	CAYC		LE 035	LE 584	LE 584Z
1.9 TDI	1.9	77	01.05-	BXE/BKC/BLS		LE 046		
2.0 FSI	2.0	110	05.05-	BLY/BLR/BVZ/BVY		LE 035	LE 584	LE 584Z

GOLF V (1K1)

1.4 16V	1.4	55	10.03-	BCA	1)	LE 005		
						LE 035		
1.4 16V	1.4	59	05.06-	BUD		LE 035	LE 584	LE 584Z
1.4 FSI	1.4	66	10.03-	BKG/BLN		LE 035	LE 584	LE 584Z
1.4 TSI	1.4	90	05.07-	CAXA		LE 035	LE 584	LE 584Z
1.4 TSI	1.4	125	11.05-	BLG		LE 035	LE 584	LE 584Z
1.6	1.6	75	01.04-	BGU/BSF/BSE		LE 035	LE 584	LE 584Z
1.6 FSI	1.6	85	10.03-	BLF/BLP/BAG		LE 035	LE 584	LE 584Z
1.9 TDI	1.9	66	05.04-	BXF/BXJ/BRU		LE 035	LE 584	LE 584Z
1.9 TDI	1.9	77	10.03-	BXE/BKC/BLS		LE 035	LE 584	LE 584Z
1.9 TDI 4motion	1.9	77	08.04-	BXE/BKC/BLS		LE 035	LE 584	LE 584Z
2.0 FSI	2.0	110	01.04-	BVX/BLX/BLY/BLR/AXW/BVZ/BVY		LE 035	LE 584	LE 584Z
2.0 FSI 4motion	2.0	110	08.04-	BVX/BLX		LE 035	LE 584	LE 584Z
2.0 SDI	2.0	55	01.04-	BDK		LE 035	LE 584	LE 584Z
2.0 TDI	2.0	100	10.03-	AZV/CBDA		LE 035	LE 584	LE 584Z
2.0 TDI	2.0	103	12.04-	BMM		LE 035	LE 584	LE 584Z
2.0 TDI	2.0	125	11.05-	BMN		LE 035	LE 584	LE 584Z
2.0 TDI 4motion	2.0	103	08.04-	BMM		LE 035	LE 584	LE 584Z
2.0 TDI 16V	2.0	103	10.03-	BKD		LE 035	LE 584	LE 584Z



1) Mit Klimaanlage

2) Mit Anhängervorrichtung

3) Für tropisches Klima

4) Automatik

5) Schaltgetriebe

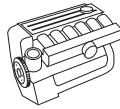
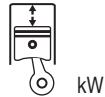

VW									
GOLF V (1K1)									
2.0 TDI 16V 4motion	2.0	103	08.04-	BKD			LE 035	LE 584	LE 584Z
GOLF V Variant (1K5)									
1.4	1.4	59	06.07-	BUD			LE 035	LE 584	LE 584Z
1.4 TSI	1.4	90	06.07-	CAXA			LE 035	LE 584	LE 584Z
1.4 TSI	1.4	118	07.08-	CAVD			LE 035	LE 584	LE 584Z
1.4 TSI	1.4	125	06.07-	BLG			LE 035	LE 584	LE 584Z
1.6	1.6	75	06.07-	CCSA/BSF/BSE			LE 035	LE 584	LE 584Z
1.9 TDI	1.9	77	06.07-	BXE/BKC/BLS			LE 035	LE 584	LE 584Z
1.9 TDI 4motion	1.9	77	01.08-	BLS			LE 035	LE 584	LE 584Z
2.0 TDI	2.0	100	06.07-	AZV			LE 035	LE 584	LE 584Z
2.0 TDI	2.0	103	06.07-	BMM			LE 035	LE 584	LE 584Z
2.0 TDI 16V	2.0	103	06.07-	CBDB/BKD			LE 035	LE 584	LE 584Z
2.0 TDI 4motion	2.0	100	06.07-	AZV			LE 035	LE 584	LE 584Z
GOLF VI (5K1)									
1.4 TSI	1.4	90	10.08-	CAXA			LE 035	LE 584	LE 584Z
1.4 TSI	1.4	118	10.08-	CAVD			LE 035	LE 584	LE 584Z
1.6	1.6	75	10.08-	CCSA/BSF/BSE			LE 035	LE 584	LE 584Z
1.6 TDI	1.6	77	02.09-	CAYC			LE 035	LE 584	LE 584Z
2.0 TDI	2.0	81	10.08-	CBDC			LE 035	LE 584	LE 584Z
GOLF VI Variant (AJ5)									
1.4	1.4	59	07.09-	BUD			LE 035	LE 584	LE 584Z
1.4 TSI	1.4	90	07.09-	CAXA			LE 035	LE 584	LE 584Z
1.4 TSI	1.4	118	07.09-	CAVD			LE 035	LE 584	LE 584Z
1.6	1.6	75	07.09-	CCSA/BSF/BSE			LE 035	LE 584	LE 584Z
1.6 TDI	1.6	77	07.09-	CAYC			LE 035	LE 584	LE 584Z
1.6 TDI 4motion	1.6	77	07.09-	CAYC			LE 035	LE 584	LE 584Z
2.0 TDI	2.0	103	07.09-	CBDB			LE 035	LE 584	LE 584Z
JETTA I (16)									
1.1	1.1	37	08.78-02.84	GG/FA			LE 001		
						2)	LE 007		
1.3	1.3	43	08.82-02.84	GS			LE 001		
1.3	1.3	44	08.79-02.84	GF			LE 001		
						2)	LE 007		
1.5	1.5	51	08.78-02.84	JB			LE 001		
						2)	LE 007		
1.5 D	1.5	37	08.78-07.80	CK			LE 001		
						2)	LE 007		
1.6	1.6	55	08.81-07.83	EM			LE 001		
1.6	1.6	55	08.82-07.83	EW			LE 001		
1.6	1.6	63	08.78-02.84	FR			LE 001		
						2)	LE 007		
1.6 D	1.6	40	08.80-02.84	JK/CR			LE 001		
						2)	LE 007		
1.6 GLI	1.6	81	08.78-07.82	EG			LE 001		
						2)	LE 007		
1.6 TD	1.6	51	03.82-02.84	CY			LE 001		
						2)	LE 007		
1.7	1.7	57	08.80-07.84				LE 001		
1.8	1.8	82	08.82-02.84	JJ/DX			LE 001		
						2)	LE 007		
JETTA II (19E, 1G2)									
1.3	1.3	40	01.84-06.87	MH/HK			LE 001		
						2)	LE 007		
1.3	1.3	43	01.84-10.86	GT			LE 001		
1.3 KAT	1.3	40	06.87-12.91	NZ/2G/MH			LE 001		
						2)	LE 007		
1.6	1.6	51	10.86-10.91	PN			LE 001		
						2)	LE 007		
1.6	1.6	53	03.86-10.91	RF			LE 001		
						2)	LE 007		



kW

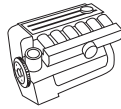

VW

JETTA II (19E, 1G2)

1.6	1.6	55	01.84-07.92	HM/ABN/EZ		LE 001		
					2)	LE 007		
1.6 D	1.6	40	01.84-10.91	ME/JP		LE 001		
					2)	LE 007		
1.6 TD	1.6	44	01.90-10.91	1V	2)	LE 007		
1.6 TD	1.6	51	01.84-10.91	JR/MF	2)	LE 007		
1.6 TD	1.6	59	04.89-10.91	RA/SB	2)	LE 007		
1.7	1.7	57	08.83-07.85			LE 001		
1.8	1.8	62	08.86-01.90	RH		LE 001		
					2)	LE 007		
1.8	1.8	66	08.84-10.91	GX/GU/HV		LE 001		
					2)	LE 007		
1.8	1.8	79	08.85-10.87	RD		LE 001		
					2)	LE 007		
1.8	1.8	82	01.84-10.91	EV/GZ/PB		LE 001		
					2)	LE 007		
1.8 KAT	1.8	66	08.87-10.91	GX/RP		LE 001		
					2)	LE 007		
1.8 KAT	1.8	79	01.87-10.91	PF		LE 001		
					2)	LE 007		
1.8 Syncro	1.8	62	08.87-07.88	RH		LE 001		
1.8 Syncro	1.8	66	08.87-12.88	RP		LE 001		
					2)	LE 007		
1.8 Syncro	1.8	72	08.88-07.91	1P		LE 001		
1.8 16V	1.8	95	08.86-10.91	PL	2)	LE 007		
1.8 16V	1.8	102	06.87-12.89	KR		LE 001		
					2)	LE 007		

JETTA III (1K2)

1.4 TSI	1.4	103	07.06-	BMJ		LE 046		
1.4 TSI	1.4	118	07.08-	CAVD		LE 035	LE 584	LE 584Z
1.4 TSI	1.4	125	07.06-	BLG		LE 046		
1.6	1.6	75	10.05-	CCSA/BSF/BSE		LE 035	LE 584	LE 584Z
1.6 FSI	1.6	85	09.05-	BLF		LE 035	LE 584	LE 584Z
1.6 TDI	1.6	77	06.09-	CAYC		LE 035	LE 584	LE 584Z
2.0 TDI	2.0	100	09.05-	AZV/CBDA		LE 035	LE 584	LE 584Z

LT 28-35 II (2DM)

2.5 SDI	2.5	55	07.96-07.06	AGX			LKK 025	
2.5 TDI	2.5	61	05.01-07.06	BBE			LKK 025	
2.5 TDI	2.5	66	05.99-07.06	APA			LKK 025	
2.5 TDI	2.5	70	05.01-07.06	BBF			LKK 025	
2.5 TDI	2.5	75	05.96-08.99	AHD			LKK 025	
2.5 TDI	2.5	80	05.99-07.06	AVR/ANJ			LKK 025	

LT 28-46 II (2DX0AE)

2.5 SDI	2.5	55	09.96-07.06	AGX			LKK 025	
2.5 TDI	2.5	61	05.01-07.06	BBE			LKK 025	
2.5 TDI	2.5	66	05.99-07.06	APA			LKK 025	
2.5 TDI	2.5	70	05.01-07.06	BBF			LKK 025	
2.5 TDI	2.5	75	05.96-08.99	AHD			LKK 025	
2.5 TDI	2.5	80	05.99-07.06	AVR/ANJ			LKK 025	

LUPO (6X1, 6E1)

1.0	1.0	37	09.98-07.05	AER/ALD/ANV/ALL/AUC	2) 3)	LE 033		
						LE 036		
1.2 TDI 3L	1.2	45	07.99-07.05	AYZ/ANY		LE 036		
1.4	1.4	44	10.00-07.05	AUD	2) 3)	LE 033		
						LE 045		
1.4 16V	1.4	55	09.98-07.05	AHW/APE/BBY/AKQ/AUA	2) 3)	LE 033		
						LE 036		
1.4 16V	1.4	74	08.99-07.05	ANM/AFK/AUB/AQQ	2) 3)	LE 033		
						LE 045		

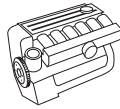
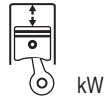

VW

LUPU (6X1, 6E1)

1.4 FSI	1.4	77	02.01-07.05	ARR	2) 3)	LE 033	
						LE 045	
1.4 TDI	1.4	55	01.99-07.05	AMF		LE 030	
1.6 GTI	1.6	92	09.00-07.05	AVY		LE 030	
1.7 SDI	1.7	44	09.98-07.05	AKU	2) 3)	LE 033	
						LE 045	

NEW BEETLE (9C1, 1C1)

1.4	1.4	55	11.01-	BCA	1)	LE 005	
						LE 036	
1.6	1.6	74	10.99-09.00	AWH	2)	LE 003	
					2) 3)	LE 033	
						LE 036	
1.6	1.6	75	06.00-	AYD/BFS	2)	LE 003	
						LE 036	
1.8 T	1.8	110	10.99-	AWW/APH/AVC/AGU/AWU/BKF	2)	LE 003	
					2) 3)	LE 033	
						LE 036	
1.8 T	1.8	132	11.01-06.05	AWP/BNU	1)	LE 005	
1.9 TDI	1.9	66	01.98-06.04	ALH	2)	LE 003	
					2) 3)	LE 033	
						LE 036	
1.9 TDI	1.9	74	02.01-	BEW/ATD	1)	LE 005	
						LE 036	
1.9 TDI	1.9	77	07.05-	BSW		LE 036	
2.0	2.0	85	01.98-	APK/AZJ/AVH/AQY/AEG/BEV/BHP/ BER/AZG/CBPA/BEJ	1)	LE 003	
					2) 3)	LE 033	
						LE 036	
RSI 3.2 (1C9)	3.2	165	04.00-05.01	AXJ	2)	LE 003	

NEW BEETLE Cabriolet (1Y7)

1.4	1.4	55	01.03-	BCA	1)	LE 005	
						LE 036	
1.6	1.6	75	01.03-	BFS	1)	LE 005	
						LE 036	
1.8 T	1.8	110	01.03-	AWW/AWU/BKF	1)	LE 005	
						LE 036	
1.9 TDI	1.9	74	06.03-	AXR	1)	LE 005	
1.9 TDI	1.9	77	07.05-	BSW		LE 036	
2.0	2.0	85	09.02-	AZJ/BEV/BDC/BGD	1)	LE 005	
						LE 036	

PASSAT (32)

1.3	1.3	40	05.73-07.80	FY	2)	LE 007	
1.3	1.3	44	05.73-01.78	ZF	2)	LE 007	
1.3	1.3	40	05.73-01.78	ZA	2)	LE 007	
1.5	1.5	55	07.73-12.75	ZB/YJ	2)	LE 007	
1.5	1.5	63	05.73-12.75	ZC	2)	LE 007	
1.6	1.6	63	08.75-07.80	YP	2)	LE 007	

PASSAT (32B)

1.3	1.3	40	08.80-07.83	FY		LE 001	
					2)	LE 007	
1.3	1.3	44	08.80-07.86	FZ		LE 001	
					2)	LE 007	
1.3	1.3	44	08.80-07.86	EP/EU		LE 001	
					2)	LE 007	
1.6	1.6	51	08.87-03.88	PP		LE 001	
					2)	LE 007	
1.6	1.6	53	02.86-03.88	RL		LE 001	
					2)	LE 007	
1.6	1.6	55	08.80-03.88	WV/YN		LE 001	
					2)	LE 007	



kW

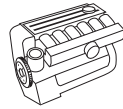

VW							
PASSAT (32B)							
1.6	1.6	55	08.80-03.88	DT		LE 001	
					2)	LE 007	
1.6	1.6	63	01.81-02.83	YP		LE 001	
					2)	LE 007	
1.6 D	1.6	40	08.80-03.88	JK/CR	2)	LE 007	
1.6 TD	1.6	51	04.82-03.88	CY		LE 041	
1.6 TD	1.6	59	05.86-03.88	RA		LE 041	
1.8	1.8	64	05.86-03.88	RM		LE 001	
					2)	LE 007	
1.8	1.8	66	01.83-03.88	DS/JN/JV		LE 001	
					2)	LE 007	
1.8	1.8	82	12.83-03.88	DZ		LE 001	
2.0	2.0	85	08.83-03.88	JS/HP	2)	LE 007	
2.2	2.2	85	08.85-03.88	KX	2)	LE 007	
2.2	2.2	100	01.85-03.88	KV	2)	LE 007	
PASSAT (3A2, 35I)							
1.6	1.6	53	02.88-09.91	EZ /1F		LE 001	
					2)	LE 007	
1.6	1.6	55	02.88-12.88	EZ		LE 001	
					2)	LE 007	
1.6	1.6	74	10.94-08.96	AEK/AFT		LE 029	
1.6 TD	1.6	59	08.88-09.93	RA/SB		LE 038	
1.8	1.8	55	08.90-08.96	AAM		LE 001	
					2)	LE 007	
1.8	1.8	66	02.88-08.96	RP/ADZ/ABS		LE 001	
					2)	LE 007	
1.8	1.8	79	04.88-07.93	PF	2)	LE 007	
1.8	1.8	82	04.88-07.92	PB	2)	LE 007	
1.8 16V	1.8	100	04.88-12.89	KR		LE 029	
1.8 GL	1.8	102	08.91-09.93	KR		LE 029	
1.9 D	1.9	50	05.89-10.93	1Y		LE 027	
1.9 TD	1.9	55	03.91-08.96	AAZ		LE 027	
1.9 TDI	1.9	66	10.93-08.96	1Z/AHU		LE 029	
1.9 TDI	1.9	81	03.96-08.96	AFN		LE 029	
2.0	2.0	79	03.95-08.96	AEP		LE 029	
2.0	2.0	85	02.90-08.96	ADY/2E/AGG		LE 029	
2.0 Syncro	2.0	85	10.90-08.96	ADY/2E/AGG		LE 029	
2.0 16V	2.0	110	01.94-08.96	ABF		LE 029	
2.0 16V	2.0	100	08.88-09.93	9A		LE 029	
2.8 VR6	2.8	128	06.91-08.96	AAA		LE 027	
2.8 VR6	2.8	128	01.94-08.96	AAA		LE 032	
PASSAT (3B2)							
1.6	1.6	74	10.96-11.00	AHL/ADP/ARM/ANA		LK 001	LE 502
1.6	1.6	74	10.96-11.00	AHL/ARM/ANA			LR 002
1.8	1.8	85	01.97-11.00	AFY		LE 502	LR 002
						LK 001	LR 002
1.8	1.8	92	10.96-11.00	ADR/APT/ARG		LE 502	LR 002
						LK 001	LR 002
1.8 Syncro/4motion	1.8	92	10.96-11.00	ADR/APT/ARG		LE 502	LR 002
						LK 001	LR 002
1.8 T	1.8	110	10.96-11.00	AEB/ANB/APU		LE 502	LR 002
						LK 001	LR 002
1.8 T	1.8	110	10.96-11.00	AEB/APU			LR 002
1.8 T Syncro	1.8	110	11.96-08.00	AEB		LE 502	
1.9 TDI	1.9	66	10.96-11.00	AHU/AHH		LE 502	
						LK 001	LR 002
1.9 TDI	1.9	74	02.00-11.00	AVB		LK 001	LR 002
1.9 TDI	1.9	81	10.96-11.00	AVG/AFN		LE 502	LR 002
						LK 001	LR 002

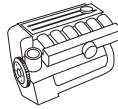
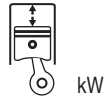

VW

PASSAT (3B2)

1.9 TDI	1.9	85	08.98–11.00	ATJ/AJM		LE 506	
					LK 001		LR 002
1.9 TDI 4motion	1.9	85	08.99–11.00	ATJ/AJM		LE 502	
1.9 TDI 4motion	1.9	85	08.99–11.00	ATJ	LK 001		LR 002
1.9 TDI Syncro/4motion	1.9	81	10.96–11.00	AVG/AFN		LE 502	
					LK 001		
1.9 TDI Syncro/4motion	1.9	81	10.96–11.00	AFN			LR 002
2.0	2.0	88	04.00–11.00	ASU/AUZ		LE 502	
2.0 4motion	2.0	88	04.00–11.00	ASU		LE 502	
2.3 VR5	2.3	110	10.96–11.00	AGZ		LE 502	
					LK 001		LR 002
2.3 VR5 Syncro/4motion	2.3	110	10.97–11.00	AGZ		LE 502	
					LK 001		LR 002
2.5 TDI	2.5	110	07.98–11.00	AKN/AFB		LE 502	
					LK 002		
2.5 TDI Syncro/4motion	2.5	110	12.98–11.00	AKN/AFB		LE 502	
					LK 002		
2.8 Syncro	2.8	132	05.97–09.99	AGE		LE 502	
2.8 V6	2.8	132	05.97–09.99	AGE		LE 502	
					LK 004		LR 001
2.8 V6	2.8	140	09.99–11.00	BBG/ATX		LE 502	
2.8 V6	2.8	140	09.99–11.00	ATX	LK 004		LR 001
2.8 V6	2.8	142	08.96–11.00	APR/ACK/AQD		LE 502	
					LK 004		LR 001
2.8 V6 4motion	2.8	140	09.99–11.00	ATX		LE 502	
					LK 004		LR 001
2.8 V6 Syncro/4motion	2.8	142	10.96–11.00	APR/ACK/ALG/AQD		LE 502	
2.8 V6 Syncro/4motion	2.8	142	11.98–11.00	APR/ACK/ALG/AQD	LK 004		LR 001

PASSAT (3B3)

1.6	1.6	75	11.00–05.05	ALZ		LE 503	
					LK 001		LR 002
1.8 T	1.8	125	02.01–05.05	AWM			LR 002
1.8 T 20V	1.8	110	11.00–05.05	AWT/AWL		LE 503	
1.8 T 20V	1.8	110	11.00–05.05	AWT	LK 001		LR 002
1.9 TDI	1.9	74	11.00–05.05	AVB		LE 506	
					LK 001		LR 002
1.9 TDI	1.9	96	11.00–05.05	AWX/AVF		LE 503	
					LK 001		LR 002
1.9 TDI 4motion	1.9	96	11.00–05.05	AVF		LE 503	
					LK 001		LR 002
2.0	2.0	85	11.00–05.05	AZM/BFF		LE 503	
2.0	2.0	85	11.00–05.05	AZM	LK 001		LR 002
2.0	2.0	96	11.01–05.05	ALT	LK 001		LR 002
2.0 4motion	2.0	85	11.00–05.05	AZM		LE 503	
					LK 001		LR 002
2.0 TDI	2.0	100	12.03–05.05	BGW/BHW			LR 002
2.3 V5	2.3	125	11.00–05.05	AZX	LK 001		LR 002
2.3 V5 4motion	2.3	125	11.00–05.05	AZX	LK 001		LR 002
2.5 TDI	2.3	110	11.00–05.05	AKN/AFB		LE 503	
2.5 TDI 4motion	2.3	110	11.00–05.05	AKN/AFB		LE 503	
2.8 4motion	2.8	142	11.00–05.05	ATQ/AMX		LE 503	
					LK 004		LR 001

PASSAT (3C2)

1.4 TSI	1.4	90	05.07–	CAXA	LE 035	LE 584	LE 584Z
1.6	1.6	75	05.05–	BSF/BSE	LE 035	LE 584	LE 584Z
1.6 FSI	1.6	85	03.05–	BLF	LE 035	LE 584	LE 584Z
1.6 TDI	1.6	77	08.09–	CAYC	LE 035	LE 584	LE 584Z
2.0 FSI	2.0	110	03.05–	BLY/BLR/BVZ/BVY	LE 035	LE 584	LE 584Z
2.0 FSI 4motion	2.0	110	09.05–	BVX/BLX/BLY	LE 035	LE 567	LE 584Z



kW

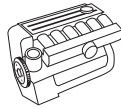

VW

PASSAT Stufenheck (32B)

1.6	1.6	51	08.87-03.88	PP		LE 001
					2)	LE 007
1.6 TD	1.6	51	01.85-03.88	CY		LE 041
1.6	1.6	53	01.85-03.88	RL		LE 001
					2)	LE 007
1.6	1.6	55	01.85-03.88	DT		LE 001
					2)	LE 007
1.8	1.8	64	05.86-03.88	RM		LE 001
					2)	LE 007
1.8	1.8	66	01.85-03.88	DS/JN		LE 001
					2)	LE 007
2.2	2.2	85	01.85-03.88	KX		LE 007

PASSAT Variant (32B)

1.3	1.3	40	08.80-07.83	FY		LE 001
					2)	LE 007
1.3	1.3	44	08.80-07.86	FZ		LE 001
					2)	LE 007
1.3	1.3	44	08.80-07.86	EP/EU		LE 001
					2)	LE 007
1.6	1.6	51	08.87-03.88	PP		LE 001
					2)	LE 007
1.6	1.6	53	02.86-03.88	RL		LE 001
					2)	LE 007
1.6	1.6	55	08.80-03.88	WV/YN		LE 001
					2)	LE 007
1.6	1.6	55	08.80-03.88	DT		LE 001
					2)	LE 007
1.6	1.6	63	01.81-02.83	YP		LE 001
					2)	LE 007
1.6 D	1.6	40	08.80-03.88	JK/CR		LE 007
1.6 TD	1.6	51	04.82-03.88	CY		LE 041
1.8	1.8	64	05.86-03.88	RM		LE 001
					2)	LE 007
1.8	1.8	66	01.83-03.88	DS/JN/JV		LE 001
					2)	LE 007
1.8	1.8	82	12.83-03.88	DZ		LE 001
1.8 Syncro	1.8	66	01.86-03.88	DS/JN		LE 001
					2)	LE 007
1.9	1.9	85	01.81-07.83	WN		LE 007
					2)	LE 007
2.0	2.0	85	08.83-03.88	JS/HP		LE 007
					2)	LE 007
2.0 Syncro	2.0	85	05.84-03.88	JS		LE 007
					2)	LE 007
2.2	2.2	85	08.85-03.88	KX		LE 007
					2)	LE 007
2.2	2.2	100	01.85-03.88	KV		LE 007
					2)	LE 007
2.2 Syncro	2.2	88	08.85-03.88	JT		LE 007

PASSAT Variant (33)

1.3	1.3	40	05.73-07.80	FY		LE 007
					2)	LE 007
1.3	1.3	40	05.73-01.78	ZA		LE 007
					2)	LE 007
1.3	1.3	44	10.73-01.78	ZF		LE 007
					2)	LE 007
1.5	1.5	55	10.73-08.75	ZB/YJ		LE 007
					2)	LE 007
1.5	1.5	63	10.73-12.75	ZC		LE 007
					2)	LE 007
1.6	1.6	55	02.76-07.80	YN		LE 007
					2)	LE 007
1.6	1.6	63	08.75-07.80	YP		LE 007
					2)	LE 007
1.6 D	1.6	40	02.79-07.80	CR		LE 007

PASSAT Variant (3A5, 35I)

1.6	1.6	53	04.88-09.91	EZ /1F		LE 001
					2)	LE 007
1.6	1.6	55	04.88-12.88	EZ		LE 001
					2)	LE 007
1.6	1.6	74	07.94-12.95	AEK/AFT		LE 029
1.6 TD	1.6	59	08.88-09.93	RA/SB		LE 038

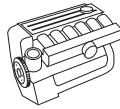
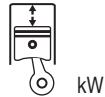

VW

PASSAT Variant (3A5, 35I)

1.8	1.8	55	08.90-05.97	AAM		LE 001	
					2)	LE 007	
1.8	1.8	66	02.88-05.97	RP/ADZ/ABS		LE 001	
					2)	LE 007	
1.8	1.8	79	04.88-07.90	PF	2)	LE 007	
1.8	1.8	82	04.88-07.92	PB	2)	LE 007	
1.8	1.8	102	08.91-09.93	KR		LE 029	
1.8 16V	1.8	100	04.88-12.89	KR		LE 029	
1.9 D	1.9	50	05.89-10.93	1Y		LE 027	
1.9 TD	1.9	55	03.91-05.97	AAZ		LE 027	
1.9 TDI	1.9	66	10.93-05.97	1Z/AHU		LE 029	
1.9 TDI	1.9	81	03.96-05.97	AFN		LE 029	
2.0	2.0	79	03.95-08.96	AEP		LE 029	
2.0	2.0	85	02.90-05.97	ADY/2E/AGG		LE 029	
2.0 Syncro	2.0	85	10.90-05.97	ADY/2E/AGG		LE 029	
2.0 16V	2.0	100	08.88-09.93	9A		LE 029	
2.0 16V	2.0	110	01.94-05.97	ABF		LE 029	
2.8 VR6	2.8	128	06.91-05.97	AAA		LE 027	
2.8 VR6	2.8	128	01.94-05.97	AAA		LE 032	
2.9 VR6 Syncro	3.2	135	01.94-05.97	ABV		LE 032	

PASSAT Variant (3B5)

1.6	1.6	74	06.97-11.00	AHL/ADP/ARM/ANA		LK 001	LE 502
1.6	1.6	74	06.97-11.00	AHL/ARM/ANA			LR 002
1.8	1.8	85	06.97-11.00	AFY		LK 001	LE 502
							LR 002
1.8	1.8	92	06.97-11.00	ADR/APT/ARG		LK 001	LE 502
							LR 002
1.8 Syncro/4motion	1.8	92	06.97-11.00	ADR/APT/ARG		LK 001	LE 502
							LR 002
1.8 T	1.8	110	06.97-11.00	AEB/ANB/APU		LK 001	LE 502
							LR 002
1.8 T	1.8	110	06.97-11.00	AEB/APU			LR 002
1.9 TDI	1.9	66	06.97-11.00	AHU/AHH		LK 001	LE 502
							LR 002
1.9 TDI	1.9	74	02.00-11.00	AVB		LK 001	LR 002
1.9 TDI	1.9	81	06.97-11.00	AVG/AFN		LK 001	LE 502
							LR 002
1.9 TDI	1.9	85	08.98-11.00	ATJ/AJM		LK 001	LE 506
							LR 002
1.9 TDI 4motion	1.9	85	08.99-11.00	ATJ		LK 001	LE 502
							LR 002
1.9 TDI Syncro/4motion	1.9	81	06.97-11.00	AVG/AFN		LK 001	LE 502
							LR 002
2.0	2.0	88	04.00-11.00	ASU/AUZ			LE 502
2.0 4motion	2.0	88	04.00-11.00	ASU/AUZ			LE 502
2.3 VR5	2.3	110	06.97-11.00	AGZ		LK 001	LE 502
							LR 002
2.3 VR5 Syncro/4motion	2.3	110	10.97-11.00	AGZ		LK 001	LE 502
							LR 002
2.5 TDI	2.5	110	07.98-11.00	AKN/AFB		LK 002	LE 502
							LR 002
2.5 TDI Syncro/4motion	2.5	110	12.98-11.00	AKN/AFB		LK 002	LE 502
							LR 002
2.8 Syncro	2.8	132	05.97-09.99	AGE			LE 502
2.8 V6	2.8	132	09.97-09.99	AGE			LE 502
						LK 004	LR 001
2.8 V6	2.8	140	09.99-11.00	ATX		LK 004	LE 502
							LR 001



kW

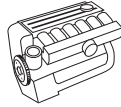

VW

PASSAT Variant (3B5)

2.8 V6	2.8	142	06.97-11.00	APR/ACK/AQD		LE 502	
					LK 004		LR 001
2.8 V6 4motion	2.8	140	09.99-11.00	ATX		LE 502	
					LK 004		LR 001
2.8 V6 Syncro/4motion	2.8	142	06.97-11.00	APR/ACK/ALG/AQD		LE 502	
					LK 004		LR 001

PASSAT Variant (3B6)

1.6	1.6	75	11.00-05.05	ALZ		LE 503	
					LK 001		LR 002
1.8 T 20V	1.8	110	11.00-05.05	AWT		LE 503	
					LK 001		LR 002
1.9 TDI	1.9	74	11.00-05.05	AVB		LE 506	
					LK 001		LR 002
1.9 TDI	1.9	96	11.00-05.05	AWX/AVF		LE 503	
					LK 001		LR 002
1.9 TDI 4motion	1.9	96	11.00-05.05	AVF		LE 503	
					LK 001		LR 002
2.0	2.0	85	11.00-05.05	AZM		LE 503	
					LK 001		LR 002
2.0	2.0	96	11.01-05.05	ALT		LE 503	
					LK 001		LR 002
2.0 4motion	2.0	85	11.00-05.05	AZM		LE 503	
					LK 001		LR 002
2.0 TDI	2.0	100	12.03-05.05	BGW/BHW		LE 503	
					LK 001		LR 002
2.3 VR5	2.3	125	11.00-05.05	AZX		LE 503	
					LK 001		LR 002
2.3 VR5 4motion	2.3	125	11.00-05.05	AZX		LE 503	
					LK 001		LR 002
2.5 TDI	2.5	110	11.00-05.05	AKN/AFB		LE 503	
					LK 001		LR 002
2.5 TDI 4motion	2.5	110	11.00-05.05	AKN/AFB		LE 503	
					LK 001		LR 002
2.8 4motion	2.8	142	11.00-05.05	ATQ/AMX		LE 503	
					LK 004		LR 001

PASSAT Variant (3C5)

1.4 TSI	1.4	90	05.07-	CAXA		LE 035	LE 584	LE 584Z
1.6	1.6	75	08.05-	BSF/BSE		LE 035	LE 584	LE 584Z
1.6 FSI	1.6	85	08.05-	BLF		LE 035	LE 584	LE 584Z
1.6 TDI	1.6	77	08.09-	CAYC		LE 035	LE 584	LE 584Z
2.0 FSI	2.0	110	08.05-	BLY/BLR/BVZ/BVY		LE 035	LE 584	LE 584Z
2.0 FSI 4motion	2.0	110	09.05-	BVX/BLX/BLY		LE 035	LE 584	LE 584Z

POLO (6N1)

1.7 SDI		42	04.97-10.99	AHG		LE 030		
100 1.4 16V	1.4	74	04.96-10.99	AFH	2)	LE 003		
					2) 3)	LE 033		
						LE 045		
120 1.6 16V GTI	1.6	88	09.98-10.99	AJV	2) 3)	LE 033		
						LE 045		
45 1.0	1.0	33	10.94-09.96	AEV		LE 030		
50 1.0	1.0	37	09.96-10.99	AER/ALL	2)	LE 003		
					2) 3)	LE 033		
						LE 045		
55 1.3	1.3	40	10.94-07.95	ADX		LE 030		
55 1.4	1.4	40	08.95-10.99	AEX	2)	LE 003		
						LE 027		
					2) 3)	LE 033		
60 1.4	1.4	44	07.95-10.99	AEX/AKV/APQ	2)	LE 003		
						LE 027		
					2) 3)	LE 033		
60 1.7 SDI	1.7	44	08.97-10.99	AKU		LE 030		
64 1.9 D	1.9	47	10.94-10.99	AEF		LE 030		
64 1.9 SDI	1.9	47	07.96-10.99	AGD		LE 030		
75 1.6	1.6	55	10.94-10.99	AEA/AEE/AHS	2) 3)	LE 033		
						LE 036		

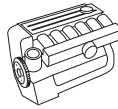
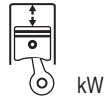

VW								
POLO (6N2)								
1.0	1.0	37	10.99-09.01	ALD/AUC	2) 3)	LE 033		
						LE 045		
1.4	1.4	40	10.99-09.01	AKP		LE 036		
1.4	1.4	44	10.99-09.01	AKK/AUD		LE 036		
1.4 16V	1.4	55	10.99-09.01	AHW/APE/AUA	2) 3)	LE 033		
						LE 036		
1.4 16V	1.4	74	10.99-09.01	AFK/AUB/AQQ		LE 036		
1.4 TDI	1.4	55	10.99-09.01	AMF		LE 030		
1.6 16V GTI	1.6	92	10.99-09.01	AVY/ARC		LE 030		
1.7 SDI	1.7	44	10.99-09.01	AKU		LE 030		
1.9 D	1.9	47	10.99-09.01	AEF		LE 030		
1.9 SDI	1.9	47	10.99-09.01	ASX/AGD		LE 030		
POLO (6R_)								
1.2 TSI	1.2	77	11.09-	CBZB			LE 585	
1.6 TDI	1.6	66	06.09-	CAYB			LE 585	
1.6 TDI	1.6	77	06.09-	CAYC		LE 035	LE 584	LE 584Z
POLO (86)								
0.8	0.8	25	09.75-09.81	HE		LE 001		
0.9	0.9	29	09.75-09.81	HA		LE 001		
					2)	LE 007		
1.1	1.1	37	03.75-09.81	HB		LE 001		
					2)	LE 007		
1.1	1.1	44	03.75-09.81	HC		LE 001		
					2)	LE 007		
1.3	1.3	44	12.76-09.81	HH		LE 001		
					2)	LE 007		
POLO (86C, 80)								
0.9	0.9	29	10.81-12.81	HA		LE 001		
					2)	LE 007		
1.0	1.0	29	10.81-10.86	GL		LE 001		
					2)	LE 007		
1.0	1.0	33	08.85-01.92	HZ		LE 001		
					2)	LE 007		
1.0 KAT	1.0	33	08.89-09.94	AAU/AAK/ACM		LE 001		
					2)	LE 007		
1.1	1.1	37	10.81-09.89	HB		LE 001		
					2)	LE 007		
1.3	1.3	37	08.83-07.85	HW		LE 001		
1.3	1.3	40	08.83-07.88	MH/HK		LE 001		
					2)	LE 007		
1.3	1.3	43	10.81-07.82	HJ/GT		LE 001		
1.3	1.3	44	10.81-07.83	HH		LE 001		
					2)	LE 007		
1.3	1.3	55	09.82-09.89	GK		LE 001		
					2)	LE 007		
1.3 KAT	1.3	40	07.87-09.94	NZ/2G/MH/AAV		LE 001		
					2)	LE 007		
1.3 KAT	1.3	55	10.89-03.91	3F		LE 001		
1.3 D	1.3	33	08.86-07.90	MN		LE 041		
1.4 D	1.4	35	10.90-09.94	1W		LE 029		
POLO (9N_)								
1.2	1.2	40	01.02-05.07	AWY/BMD		LE 036	LE 585	
1.2	1.2	44	05.07-	BBM		LE 039	LE 585	
1.2 12V	1.2	47	10.01-07.07	AZQ/BME		LE 036	LE 585	
1.2 12V	1.2	51	05.07-	BZG		LE 036	LE 585	
1.4 16V	1.4	55	10.01-05.08	BBY/BKY/AUA	1)	LE 005		
					2) 3)	LE 033		
						LE 036		
1.4 16V	1.4	59	05.06-	BUD		LE 028	LE 585	
1.4 16V	1.4	74	10.01-05.08	BBZ/AUB		LE 036	LE 585	



kW

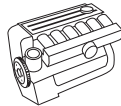

VW

POLO (9N_)

1.4 FSI	1.4	63	02.02-07.06	AXU		LE 036	LE 585
1.4 TDI	1.4	51	04.05-	BNM/BWB		LE 044	LE 587
1.4 TDI	1.4	55	10.01-06.05	AMF/BAY		LE 044	LE 587
1.4 TDI	1.4	59	04.05-	BMS/BNV		LE 044	LE 585
1.6 16V	1.6	77	05.06-	BTS		LE 036	LE 585
1.8 GTI	1.8	110	09.05-	BJX	1)	LE 005	
						LE 036	
1.8 GTi Cup Edition	1.8	132	05.06-	BBU	1)	LE 005	
						LE 036	
1.9 SDI	1.9	47	10.01-	ASY		LE 036	LE 585
1.9 TDI	1.9	74	10.01-	BMT/AXR/ATD	1)	LE 005	
						LE 036	
1.9 TDI	1.9	96	11.03-	BLT/ASZ	1)	LE 005	
						LE 036	

POLO CLASSIC (6KV2)

2.0	2.0	85	08.99-09.01	ADC		LE 038	
57 1.7 SDI	1.7	42	07.97-09.01	AKW		LE 001	
60 1.4	1.4	44	12.95-09.01	AEX/AKV/ANW/AKK/APQ/AUD	2)	LE 003	
					2) 3)	LE 007	
						LE 033	
64 1.9 SDI	1.9	47	12.95-08.99	AEY		LE 001	
75 1.4 16V	1.4	55	10.99-09.01	APE/AUA	2)	LE 003	
					2) 3)	LE 033	
						LE 036	
75 1.6	1.6	55	11.95-09.01	ALM/AEE	2)	LE 001	
					2) 3)	LE 003	
						LE 033	
75 1.6	1.6	55	11.95-09.97	1F		LE 027	
90 1.8	1.8	66	01.97-09.01	ADD		LE 038	
90 1.9 TDI	1.9	66	09.96-09.01	ALE/AHU/AGR/ALH		LK 001	

POLO CLASSIC (86C, 80)

1.0	1.0	33	01.85-09.94	AAU/HZ/AAK	2)	LE 007	
1.3	1.3	40	01.85-07.87	MH/HK	2)	LE 007	
1.3 KAT	1.3	40	07.87-09.94	NZ/MH	2)	LE 007	
1.3 D	1.3	33	08.86-12.88	MN	2)	LE 007	
1.4 D	1.4	35	10.90-09.94	1W	2)	LE 007	

POLO Coupe (86C, 80)

1.0	1.0	29	05.82-10.86	GL		LE 001	
					2)	LE 007	
1.0	1.0	33	08.85-01.92	HZ		LE 001	
					2)	LE 007	
1.0 KAT	1.0	33	08.89-09.94	AAU/AAK/ACM		LE 001	
					2)	LE 007	
1.1	1.1	37	10.81-07.83	HB		LE 001	
					2)	LE 007	
1.3	1.3	40	08.83-06.87	MH/HK		LE 001	
					2)	LE 007	
1.3	1.3	44	10.81-07.83	HH		LE 001	
1.3	1.3	55	09.82-09.89	GK		LE 001	
					2)	LE 007	
1.3	1.3	57	03.91-09.94	3F		LE 001	
					2)	LE 007	
1.3 KAT	1.3	40	07.87-08.94	NZ/2G/MH/AAV		LE 001	
					2)	LE 007	
1.3 KAT	1.3	55	10.89-09.94	3F		LE 001	
					2)	LE 007	
1.3 D	1.3	33	08.86-08.90	MN	2)	LE 007	
1.3 G40	1.3	85	01.87-08.90	PY	2)	LE 007	
1.3 G40	1.3	83	08.90-09.94	PY	2)	LE 007	
1.4 D	1.4	35	08.90-09.94	1W	2)	LE 007	

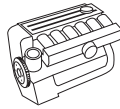
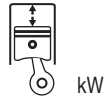

VW									
POLO Kasten (6NF)									
1.0	1.0	33	10.94-12.99	AAU					LE 030
1.4	1.4	44	05.98-12.99	AEX/APQ	2)				LE 003
					2) 3)				LE 027
									LE 033
1.7 SDI	1.7	44	08.97-12.99	AKU					LE 030
1.9 D	1.9	47	10.94-12.99	AEF					LE 030
1.9 SDI	1.9	47	07.96-12.99	AGD					LE 030
POLO Kasten (86CF)									
1.0	1.0	33	08.92-07.94	AAU					LE 001
					2)				LE 007
1.3	1.3	40	08.92-07.94	AAV					LE 001
					2)				LE 007
1.4 D	1.4	35	08.92-07.94	1W					LE 007
POLO Stufenheck									
1.4	1.4	55	07.03-	BBY/BKY	1)				LE 005
					2) 3)				LE 033
									LE 036
1.4	1.4	74	11.03-	BBZ					LE 036 LE 585
1.4 TDI	1.4	55	07.03-	BAY					LE 044 LE 587
1.6	1.6	74	09.02-	BAH					LE 036
1.9 SDI	1.9	47	09.02-	ASY					LE 036 LE 585
1.9 TDi	1.9	74	09.02-	ATD					LE 036
POLO Variant (6KV5)									
1.4	1.4	40	12.98-09.01	AKP					LE 007
1.4	1.4	44	05.97-09.01	AEX/AKV/ANW/AKK/APQ/AUD	2)				LE 003
					2) 3)				LE 027
									LE 033
1.4 16V	1.4	55	10.99-09.01	APE/AUA	2)				LE 003
									LE 036
1.6	1.6	55	05.97-09.01	ALM/AEE	2)				LE 003
					2) 3)				LE 033
									LE 036
1.6	1.6	74	05.97-09.01	AKL/APF/AEH/AUR/AFT					LE 038
1.8	1.8	66	05.97-09.01	ADZ					LE 038
1.9 SDI	1.9	47	06.97-09.01	AEY	2)				LE 007
									LE 027
1.9 TDI	1.9	66	05.97-09.01	AHU					LK 001
1.9 TDI	1.9	81	06.98-09.01	AFN					LK 001
SANTANA									
1.8	1.8	66	08.84-07.94	DS					LE 001
1.8 GL	1.8	68	05.91-07.94						LE 001
1.8 GL	1.8	71	08.84-07.94						LE 001
SANTANA (32B)									
1.3	1.3	44	08.81-07.83	FZ					LE 001
					2)				LE 007
1.3 CX	1.3	44	08.84-12.85	EP					LE 001
1.6	1.6	55	08.81-12.84	WV					LE 001
					2)				LE 007
1.6	1.6	55	08.81-12.84	DT					LE 001
					2)				LE 007
1.6	1.6	63	08.81-12.82	YP					LE 001
					2)				LE 007
1.6 D	1.6	40	08.81-12.84	JK/CR	2)				LE 007
1.6 TD	1.6	51	12.81-12.84	CY					LE 041
1.8	1.8	66	01.83-12.84	DS					LE 001
					2)				LE 007
1.9	1.9	85	08.81-07.83	WN	2)				LE 007
2.0	2.0	85	08.83-12.84	JS/HP	2)				LE 007
SCIROCCO (137)									
1.4 TSI	1.4	90	09.08-	CAXA					LE 035 LE 584 LE 584Z



kW

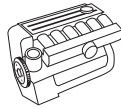

VW									
SCIROCCO (137)									
1.4 TSI	1.4	118	09.08-	CAVD			LE 035	LE 584	LE 584Z
2.0 R	2.0	195	11.09-	CDLA			LE 035	LE 584	LE 584Z
2.0 TDI	2.0	103	09.08-	CBDB			LE 035	LE 584	LE 584Z
2.0 TDI	2.0	125	05.09-	CBBB			LE 035	LE 584	LE 584Z
2.0 TSI	2.0	147	09.08-	CAWB			LE 035	LE 584	LE 584Z
2.0 TSI	2.0	155	11.09-	CCZB			LE 035	LE 584	LE 584Z
SCIROCCO (53)									
1.1	1.1	37	04.74-07.79	FA			LE 001		
						2)	LE 007		
1.3	1.3	44	08.79-07.80	GF			LE 001		
						2)	LE 007		
1.5	1.5	51	08.77-07.80	JB			LE 001		
						2)	LE 007		
1.5	1.5	51	02.74-12.75	FH			LE 001		
						2)	LE 007		
1.5	1.5	55	02.74-08.75	ZB/YJ			LE 001		
						2)	LE 007		
1.5	1.5	63	02.74-12.77	ZC			LE 001		
						2)	LE 007		
1.6	1.6	51	08.75-07.77	FT			LE 001		
1.6	1.6	55	08.75-07.79	FN/FP			LE 001		
						2)	LE 007		
1.6	1.6	63	08.75-07.80	FR			LE 001		
						2)	LE 007		
1.6	1.6	81	06.76-07.80	EG			LE 001		
						2)	LE 007		
SCIROCCO (53B)									
1.3	1.3	44	08.80-12.83	GF			LE 001		
						2)	LE 007		
1.5	1.5	51	08.80-12.83	JB			LE 001		
						2)	LE 007		
1.6	1.6	51	08.83-07.84	EWA			LE 001		
						2)	LE 007		
1.6	1.6	53	04.86-07.90	RE			LE 001		
						2)	LE 007		
1.6	1.6	55	01.83-12.89	EW			LE 001		
						2)	LE 007		
1.6	1.6	63	08.80-04.84	FR			LE 001		
						2)	LE 007		
1.6	1.6	81	08.80-07.82	EG			LE 001		
						2)	LE 007		
1.8	1.8	66	08.83-07.92	EX			LE 001		
						2)	LE 007		
1.8	1.8	70	11.85-07.92	JH			LE 001		
1.8	1.8	82	08.82-12.89	EV/JJ/PB/DX			LE 001		
						2)	LE 007		
1.8 16V	1.8	95	03.86-07.92	PL			LE 001		
						2)	LE 007		
1.8 16V	1.8	102	10.85-07.89	KR			LE 001		
						2)	LE 007		
SHARAN (7M8, 7M9, 7M6)									
1.8 T 20V	1.8	110	09.97-	AWC/AJH				LE 502	
1.9 TDI	1.9	66	09.95-	ANU/1Z/AHU				LE 502	
1.9 TDI	1.9	81	09.96-04.00	AVG/AFN				LE 502	
2.0	2.0	85	09.95-	ATM/ADY				LE 502	
TOURAN (1T1, 1T2)									
1.4 FSI	1.4	125	12.06-	BLG/CAVB			LE 035	LE 584	LE 584Z
1.4 TSI	1.4	103	02.06-	BMY/CAVC			LE 035	LE 584	LE 584Z
1.4 TSI EcoFuel	1.4	110	05.09-	CDGA			LE 035	LE 584	LE 584Z
1.6	1.6	75	07.03-	BGU/BSF/BSE			LE 035	LE 584	LE 584Z

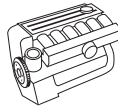
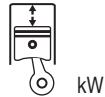
VW
TOURAN (1T1, 1T2)

1.6 FSI	1.6	85	02.03-	BLF/BLP/BAG	LE 035	LE 584	LE 584Z
1.9 TDI	1.9	66	11.04-	BXF/BXJ/BRU	LE 035	LE 584	LE 584Z
1.9 TDI	1.9	74	02.03-	AVQ	LE 035	LE 584	LE 584Z
1.9 TDI	1.9	77	08.03-	BXE/BKC/BLS	LE 035	LE 584	LE 584Z
2.0 EcoFuel	2.0	80	02.06-	BSX	LE 046		
2.0 FSI	2.0	110	10.03-	BLX/BLY/BLR/AXW	LE 035	LE 584	LE 584Z
2.0 TDI	2.0	100	02.03-	AZV	LE 035	LE 584	LE 584Z
2.0 TDI	2.0	103	12.05-	BMM	LE 035	LE 584	LE 584Z
2.0 TDI	2.0	125	12.05-	BMN	LE 035	LE 584	LE 584Z
2.0 TDI 16V	2.0	103	08.03-	BKD	LE 035	LE 584	LE 584Z

TRANSPORTER T4 (70XB, 70XC, 7DB, 7DW)

1.8	1.8	49	12.90-07.92	PD	LE 034		
1.9 D	1.9	44	09.90-04.03	1X	LE 034		
1.9 TD	1.9	50	10.92-04.03	ABL	LE 034		
2.0	2.0	62	09.90-04.03	AAC	LE 034		
2.4 D	2.4	55	08.97-04.03	AJA	LE 034		
2.4 D	2.4	57	09.90-04.98	AAB	LE 034		
2.4 D Syncro	2.4	57	10.92-09.98	AAB	LE 034		
2.5	2.5	81	11.90-04.03	AEN/AAF/ACU/AEU	LE 034		
2.5	2.5	85	08.96-04.03	AVT/AET/APL	LE 034		
2.5 Syncro	2.5	81	11.92-04.03	AEN/AAF/ACU/AEU	LE 034		
2.5 Syncro	2.5	85	07.96-04.03	AVT/AET/APL	LE 034		
2.5 TDI	2.5	65	05.98-04.03	AJT/AYY	LE 034		
2.5 TDI	2.5	75	09.95-04.03	AYC/AXL/AUF/ACV	LE 034		
2.5 TDI	2.5	111	05.98-04.03	AXG/AHY	LE 034		
2.5 TDI Syncro	2.5	75	01.96-04.03	AXL/ACV	LE 034		
2.8 VR 6	2.8	103	11.95-04.00	AES	LE 034		

VENTO (1H2)

1.4	1.4	40	11.91-09.98	AEX/ABD	LE 029		
1.4	1.4	44	11.91-09.98	AEX/ABD	LE 029		
1.6	1.6	55	09.92-09.98	ABU/AEA/AEE	LE 029		
1.6	1.6	74	10.94-09.98	AEK/AFT	LE 029		
1.8	1.8	55	11.91-09.98	AAM	LE 029		
1.8	1.8	66	11.91-09.98	ADZ/ABS	LE 029		
1.9 D	1.9	48	11.91-09.98	1Y	LE 038		
1.9 SDI	1.9	47	04.97-09.98	AEY	LE 029		
1.9 TD	1.9	55	11.91-09.98	AAZ	LE 042		
1.9 TDI	1.9	66	09.93-09.98	ALE/1Z/AHU	LE 029		
1.9 TDI+D2	1.9	81	04.96-09.98	AFN	LE 042		
2.0	2.0	85	11.91-09.98	ADY/AKR/2E/AGG	LE 029		
2.0 GL	2.0	79	05.96-12.97	AEP	LE 029		
2.8 VR6	2.8	120	08.95-01.96	AAA	LE 043		
2.8 VR6	2.8	128	01.92-01.96	AAA	LE 043		

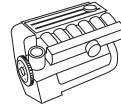

kW

IVECO
EuroCargo

60 E 14	3.908	100	01.91-12.96		LK 088
60 E 14 K	3.908	100	01.91-12.96		LK 088
65 E 14	3.908	100	01.91-12.00		LK 088
65 E 14 K	3.908	100	01.91-12.00	8040.45.4000	LK 088
75 E 14	3.908	100	01.91-		LK 088
75 E 14 K	3.908	100	01.97-		LK 088
80 E 18	5.861	130	01.91-	8060.25V.4000	LK 088
80 E 18	5.861	130	01.91-		LK 088
80 E 18 K	5.861	130	01.91-	8060.25V.4000	LK 088
100 E 15	5.861	105	01.91-		LK 088
100 E 18	5.861	130	01.91-	8060.25V.4000	LK 088
100 E 18 K	5.861	130	01.91-	8060.25V.4000	LK 088
120 E 18	5.861	130	01.92-	8060.25V.4080	LK 088
120 E 18 K	5.861	130	01.92-	8060.25V.4080	LK 088
130 E 18	5.861	130	01.92-		LK 088
130 E 18 K	5.861	130	01.92-	8060.25V.4080	LK 088
135 E 18 W	5.861	130	01.97-		LK 088
135 E 18 WR	5.861	130	01.93-12.96		LK 088
135 E 23 W	5.861	167	01.97-		LK 088
135 E 23 WR	5.861	167	01.93-12.96		LK 088
150 E 18	5.861	130	01.92-	8060.25V.4080	LK 088
150 E 18 K	5.861	130	01.92-		LK 088
170 E 18 K, 180 E 18 K	5.861	130	01.94-	8060.25V.4800	LK 088
170 E 18, 180 E 18	5.861	130	01.94-	8060.25V.4800	LK 088
170 E 23 K, 180 E 23 K	5.816	167	01.94-		LK 088
170 E 23, 180 E 23	5.816	167	01.94-		LK 088

MAN
F 2000

19.233 FCNG	11.967	170	09.96-	E 2866 DF 01	LK 092	LR 020
19.233 FKNG	11.967	170	03.00-	E 2866 DF 01	LK 092	LR 020
19.273 F, FL, FLL	9.973	198	01.94-12.95		LK 092	LR 020
19.273 FA	9.973	198	01.94-12.95	D 2865 LF22	LK 092	LR 020
19.273 FAK	9.973	198	01.94-12.95	D 2865 LF22	LK 092	LR 020
19.273 FK	9.973	198	01.94-12.95		LK 092	LR 020
19.273 FS, 19.273 FLS	9.973	198	01.94-12.95	D 2865 LF22	LK 092	LR 020
19.293 FAC	9.973	213	01.94-	D 2865 LF20	LK 092	LR 020
19.293 FAK	9.973	213	01.94-	D 2865 LF24	LK 092	LR 020
19.293 FAS	9.973	213	01.94-	D 2865 LF20	LK 092	LR 020
19.293 FC, 19.293 FLC, 19.293 FLLC	9.973	213	01.94-		LK 092	LR 020
19.293 FK, 19.293 FLK	9.973	213	01.94-		LK 092	LR 020
19.293 FS, 19.293 FLS, 19.293 FLLS	9.973	213	01.94-		LK 092	LR 020
19.314 FAC	11.967	228	05.01-		LK 092	LR 020
19.314 FAK, FA-KI	11.967	228	05.01-		LK 092	LR 020
19.314 FAS	11.967	228	06.98-	D 2866 LF34	LK 092	LR 020
19.314 FC, FLC, FLLC, FLLW, FRC, FLRC, FLLRC, FLL, FLLR, F-N	11.967	228	06.98-	D 2866 LF34	LK 092	LR 020
19.314 FK, FLK, F-KI, FL-KI	11.967	228	06.98-	D 2866 LF34	LK 092	LR 020
19.314 FS, FLS, FLLS, FRS, FLRS, FLLRS	11.967	228	06.98-		LK 092	LR 020
19.323 FAC	9.973	235	01.94-12.95	D 2865 LF23	LK 092	LR 020
19.323 FAK	9.973	235	01.94-12.95	D 2865 LF23	LK 092	LR 020
19.323 FAS	9.973	235	01.94-12.95	D 2865 LF23	LK 092	LR 020
19.323 FC, 19.323 FLC, 19.323 FLLC	9.973	235	01.94-12.95	D 2865 LF23	LK 092	LR 020
19.323 FK, 19.323 FLK	9.973	235	01.94-12.95	D 2865 LF23	LK 092	LR 020
19.323 FS, 19.323 FLS, 19.323 FLLS	9.973	235	01.94-12.95	D 2865 LF23	LK 092	LR 020
19.343 FAC	9.973	250	01.94-	D 2865 LF21	LK 092	LR 020
19.343 FAK	9.973	250	01.94-	D 2865 LF21	LK 092	LR 020
19.343 FAS	9.973	250	01.94-	D 2865 LF21	LK 092	LR 020
19.343 FC, 19.343 FLC, 19.343 FLLC	9.973	250	01.94-		LK 092	LR 020
19.343 FK, 19.343 FLK	9.973	250	01.94-		LK 092	LR 020
19.343 FS, 19.343 FLS, 19.343 FLLS	9.973	250	01.94-		LK 092	LR 020
19.364 FAC	11.967	265	06.98-	D 2866 LF35	LK 092	LR 020



kW

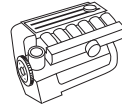

MAN

F 2000

19.364 FAK, FA-KI	11.967	265	06.98-		LK 092	LR 020
19.364 FAS	11.967	265	06.98-	D 2866 LF35	LK 092	LR 020
19.364 FC, FLC, FLLC, FLLW, FRC, FLRC, FLLRC, FLL, FLLR, F-N	11.967	265	06.98-		LK 092	LR 020
19.364 FK, FLK, F-KI, FL-KI	11.967	265	06.98-	D 2866 LF35	LK 092	LR 020
19.364 FS, FLS, FLLS, FRS, FLRS, FLLRS	11.967	265	06.98-	D 2866 LF35	LK 092	LR 020
19.373 FAC	11.967	272	01.94-12.95		LK 092	LR 020
19.373 FAK, FA-KI	11.967	272	01.94-12.95	D 2866 LF21	LK 092	LR 020
19.373 FAS	11.967	272	01.94-12.95	D 2866 LF21	LK 092	LR 020
19.373 FC, FLC, FLLC, FRC, FLRC, F-NL	11.967	272	01.94-12.95	D 2866 LF21	LK 092	LR 020
19.373 FK, FLK, F-KI, FL-KI	11.967	272	01.94-12.95	D 2866 LF21	LK 092	LR 020
19.373 FS, FLS, FLLS, FRS, FLRS, FLLRS	11.967	272	01.94-12.95		LK 092	LR 020
19.403 FAC	11.967	294	01.94-	D 2866 LF20	LK 092	LR 020
19.403 FAK, FA-KI	11.967	294	01.94-	D 2866 LF20	LK 092	LR 020
19.403 FAS	11.967	294	01.94-	D 2866 LF20	LK 092	LR 020
19.403 FC, FLC, FLLC, FRC, FLRC, F-NL	11.967	294	01.94-	D 2866 LF20	LK 092	LR 020
19.403 FK, FLK, F-KI, FL-KI	11.967	294	01.94-		LK 092	LR 020
19.403 FS, FLS, FLLS, FRS, FLRS, FLLRS	11.967	294	01.94-		LK 092	LR 020
19.414 FAC	11.967	301	06.98-	D 2866 LF31	LK 092	LR 020
19.414 FAK, FA-KI	11.967	301	06.98-		LK 092	LR 020
19.414 FAS	11.967	301	06.98-	D 2866 LF31	LK 092	LR 020
19.414 FC, FLC, FLLC, FRC, FLRC, FLLRC, FLL, FLLR, F-NL	11.967	301	06.98-	D 2866 LF31	LK 092	LR 020
19.414 FK, FLK, F-KI, FL-KI	11.967	301	06.98-	D 2866 LF31	LK 092	LR 020
19.414 FS, FLS, FLLS, FRS, FLRS, FLLRS	11.967	301	06.98-		LK 092	LR 020
19.423 FAC	11.967	309	01.94-12.95		LK 092	LR 020
19.423 FAK, FA-KI	11.967	309	01.94-12.95	D 2866 LF22	LK 092	LR 020
19.423 FAS	11.967	309	01.94-12.95	D 2866 LF22	LK 092	LR 020
19.423 FC, FLC, FLLC, F-NL	11.967	309	01.94-12.95	D 2866 LF22	LK 092	LR 020
19.423 FK, FLK, F-KI, FL-KI	11.967	309	01.94-12.95	D 2866 LF22	LK 092	LR 020
19.423 FS, FLS, FLLS	11.967	309	01.94-12.95	D 2866 LF22	LK 092	LR 020
19.463 FAC	12.816	338	01.94-	D 2876 LF 02	LK 092	LR 020
19.463 FAK, FA-KI	12.816	338	01.94-		LK 092	LR 020
19.463 FAS	12.816	338	01.94-	D 2876 LF 02	LK 092	LR 020
19.463 FC, FLC, FLLC, FRC, FLRC, F-NL	12.816	338	01.94-	D 2876 LF 02	LK 092	LR 020
19.463 FK, FLK, F-KI, FL-KI	12.816	338	01.94-	D 2876 LF 02	LK 092	LR 020
19.463 FS, FLS, FLLS, FRS, FLRS, FLLRS	12.816	338	01.94-		LK 092	LR 020
19.464 FAC	12.816	338	06.98-	D 2876 LF 06	LK 092	LR 020
19.464 FAK, FA-KI	12.816	338	06.98-	D 2876 LF 06	LK 092	LR 020
19.464 FAS	12.816	338	06.98-	D 2876 LF 06	LK 092	LR 020
19.464 FC, FLC, FLLC, FLL, FRC, FLLR, FLLRC, FLLW, F-NL	12.816	338	06.98-	D 2876 LF 06	LK 092	LR 020
19.464 FK, FLK, F-KI, FL-KI	12.816	338	06.98-		LK 092	LR 020
19.464 FS, FLS, FLLS, FRS, FLRS, FLLRS	12.816	338	06.98-	D 2876 LF 06	LK 092	LR 020
19.603 FLS, 19604 FLS	18.273	441	04.96-	D 2840 LF20	LK 092	LR 020
23.293 FNLLC	9.973	213	01.94-		LK 092	LR 020
23.314 FNLLC	11.967	228	05.01-		LK 092	LR 020
23.343 FNLLC	9.973	250	01.94-		LK 092	LR 020
23.364 FNLLC	11.967	265	05.01-		LK 092	LR 020
23.403 FNLLC	11.967	294	01.94-	D 2866 LF20	LK 092	LR 020
23.414 FNLLC	11.967	301	05.01-		LK 092	LR 020
23.463 FNLLC	12.816	338	01.94-	D 2876 LF 02	LK 092	LR 020
23.464 FNLLC	12.816	338	05.01-		LK 092	LR 020
24.273 FNLLC	9.973	198	01.94-12.95		LK 092	LR 020
24.293 FNLLC	9.973	213	01.94-		LK 092	LR 020
24.314 FNLLRC	11.967	228	05.01-		LK 092	LR 020
24.323 FNLLC	9.973	235	01.94-12.95		LK 092	LR 020
24.343 FNLLC	9.973	250	01.94-	D 2865 LF21	LK 092	LR 020
24.364 FNLLRC	11.967	265	05.01-		LK 092	LR 020
24.373 FNLLC	11.967	272	01.94-12.95		LK 092	LR 020
24.403 FNLLC	11.967	294	01.94-	D 2866 LF20	LK 092	LR 020
24.414 FNLLRC	11.967	301	05.01-		LK 092	LR 020



kW

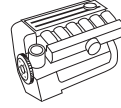

MAN							
F 2000							
24.423 FNLLC	11.967	309	01.94-12.95	D 2866 LF22		LK 092	LR 020
24.463 FNLLC	12.816	338	01.94-	D 2876 LF 02		LK 092	LR 020
24.464 FNLLRC	12.816	338	05.01-			LK 092	LR 020
26.233 FVLCNG	11.967	170	09.96-			LK 092	LR 020
26.233 FVL-KO	11.967	170	03.00-			LK 092	LR 020
26.273 DFC,26.273 DFCL	9.973	198	01.94-12.95			LK 092	LR 020
26.273 DFK,26.273 DFLK	9.973	198	01.94-12.95	D 2865 LF22		LK 092	LR 020
26.273 DFS,26.273 DFSL	9.973	198	01.94-12.95	D 2865 LF22		LK 092	LR 020
26.273 FNLC,26.273 FNLLC,26.273 FVLC	9.973	198	01.94-12.95			LK 092	LR 020
26.273 FNLS,26.273 FVLS	9.973	198	01.94-12.95			LK 092	LR 020
26.293 DFC,26.293 DFCL	9.973	213	01.94-	D 2865 LF24		LK 092	LR 020
26.293 DFK,26.293 DFLK	9.973	213	01.94-	D 2865 LF20		LK 092	LR 020
26.293 DFS,26.293 DFSL	9.973	213	01.94-	D 2865 LF20		LK 092	LR 020
26.293 FNLC,26.293 FNLLC,26.293 FVLC	9.973	213	01.94-	D 2865 LF20		LK 092	LR 020
26.293 FNLS,26.293 FVLS	9.973	213	01.94-			LK 092	LR 020
26.314 DFC, DFCL	11.967	228	05.01-			LK 092	LR 020
26.314 DFK, DFLK	11.967	228	05.01-			LK 092	LR 020
26.314 DFS, DFSL	11.967	228	05.01-			LK 092	LR 020
26.314 DF-TM	11.967	228	05.01-			LK 092	LR 020
26.314 FNLC, FNLLC, FNLLRC, FNLLW, FVLC	11.967	228	05.01-			LK 092	LR 020
26.314 FNLS	11.967	228	05.01-			LK 092	LR 020
26.314 FVL-KO	11.967	228	05.01-			LK 092	LR 020
26.314 FVLS, FVLRS	11.967	228	05.01-			LK 092	LR 020
26.323 DFC,26.323 DFCL	9.973	235	01.94-12.95			LK 092	LR 020
26.323 DFK,26.323 DFLK	9.973	235	01.94-12.95			LK 092	LR 020
26.323 DFS,26.323 DFSL	9.973	235	01.94-12.95			LK 092	LR 020
26.323 FNLC,26.323 FNLLC,26.323 FVLC	9.973	235	01.94-12.95			LK 092	LR 020
26.323 FNLS,26.323 FVLS	9.973	235	01.94-12.95	D 2865 LF23		LK 092	LR 020
26.343 DFC,26.343 DFCL	9.973	250	01.94-			LK 092	LR 020
26.343 DFK,26.343 DFLK	9.973	250	01.94-	D 2865 LF21		LK 092	LR 020
26.343 DFS,26.343 DFSL	9.973	250	01.94-			LK 092	LR 020
26.343 FNLC,26.343 FNLLC,26.343 FVLC	9.973	250	01.94-			LK 092	LR 020
26.343 FNLS,26.343 FVLS	9.973	250	01.94-			LK 092	LR 020
26.364 DFC, DFCL	11.967	265	05.01-			LK 092	LR 020
26.364 DFK, DFLK	11.967	265	05.01-			LK 092	LR 020
26.364 DFS, DFSL	11.967	265	05.01-			LK 092	LR 020
26.364 DF-TM	11.967	265	05.01-			LK 092	LR 020
26.364 FNLC, FNLLC, FNLLRC, FNLLW, FVLC	11.967	265	05.01-			LK 092	LR 020
26.364 FNLS	11.967	265	05.01-			LK 092	LR 020
26.364 FVL-KO	11.967	265	05.01-			LK 092	LR 020
26.364 FVLS, FVLRS	11.967	265	05.01-			LK 092	LR 020
26.373 DFC,26.373 DFCL	11.967	272	01.94-12.95	D 2866 LF21		LK 092	LR 020
26.373 DFK,26.373 DFLK	11.967	272	01.94-12.95	D 2866 LF21		LK 092	LR 020
26.373 DFS,26.373 DFSL	11.967	272	01.94-12.95	D 2866 LF21		LK 092	LR 020
26.373 FNLC,26.373 FNLLC,26.373 FVLC	11.967	272	01.94-12.95	D 2866 LF21		LK 092	LR 020
26.373 FNLS,26.373 FVLS	11.967	272	01.94-12.95	D 2866 LF21		LK 092	LR 020
26.403 DFC,26.403 DFCL	11.967	294	01.94-	D 2866 LF20		LK 092	LR 020
26.403 DFC,26.403 DFCL	11.967	294	01.94-	D 2866 LF20		LK 092	LR 020
26.403 DFK,26.403 DFLK	11.967	294	01.94-	D 2866 LF20		LK 092	LR 020
26.403 DFK,26.403 DFLK	11.967	294	01.94-	D 2866 LF20		LK 092	LR 020
26.403 DFS,26.403 DFSL	11.967	294	01.94-	D 2866 LF20		LK 092	LR 020
26.403 DFS,26.403 DFSL	11.967	294	01.94-	D 2866 LF20		LK 092	LR 020
26.403 FNLC,26.403 FNLLC,26.403 FVLC	11.967	294	01.94-			LK 092	LR 020
26.403 FNLC,26.403 FNLLC,26.403 FVLC	11.967	294	01.94-			LK 092	LR 020
26.403 FNLS,26.403 FVLS	11.967	294	01.94-	D 2866 LF20		LK 092	LR 020
26.414 DFC, DFCL	11.967	301	05.01-			LK 092	LR 020
26.414 DFK, DFLK	11.967	301	05.01-			LK 092	LR 020
26.414 DFS, DFSL	11.967	301	05.01-			LK 092	LR 020
26.414 DF-TM	11.967	301	05.01-			LK 092	LR 020
26.414 FNLC, FNLLC, FNLLRC, FNLLW, FVLC	11.967	301	05.01-			LK 092	LR 020
26.414 FNLS	11.967	301	05.01-			LK 092	LR 020
26.414 FVL-KO	11.967	301	05.01-			LK 092	LR 020



kW

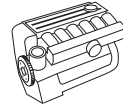

MAN

F 2000

26.414 FVLS, FVLRS	11.967	301	05.01-		LK 092	LR 020
26.423 DFC,26.423 DFCL	11.967	309	01.94-12.95		LK 092	LR 020
26.423 DFK,26.423 DFLK	11.967	309	01.94-12.95		LK 092	LR 020
26.423 DFS,26.423 DFSL	11.967	309	01.94-12.95	D 2866 LF22	LK 092	LR 020
26.423 FNLC,26.423 FNLLC,26.423 FVLC	11.967	309	01.94-12.95		LK 092	LR 020
26.423 FNLS,26.423 FVLS	11.967	309	01.94-12.95		LK 092	LR 020
26.463 DFC, DFCL	12.816	338	01.94-		LK 092	LR 020
26.463 DFK,26.463 DFLK	12.816	338	01.94-		LK 092	LR 020
26.463 DFS,26.463 DFSL	12.816	338	01.94-		LK 092	LR 020
26.463 FNLC, FNLLC, FVLC	12.816	338	01.94-		LK 092	LR 020
26.463 FNLS,26.463 FVLS	12.816	338	01.94-	D 2876 LF 02	LK 092	LR 020
26.464 DFC, DFCL	12.816	338	05.01-		LK 092	LR 020
26.464 DFK, DFLK	12.816	338	05.01-		LK 092	LR 020
26.464 DFS, DFSL	12.816	338	05.01-		LK 092	LR 020
26.464 DF-TM	12.816	338	05.01-		LK 092	LR 020
26.464 FNLC, FNLLC, FNLLW, FVLC	12.816	338	05.01-		LK 092	LR 020
26.464 FNLS	12.816	338	05.01-		LK 092	LR 020
26.464 FVL-KO	12.816	338	05.01-		LK 092	LR 020
26.464 FVLS, FVLRS	12.816	338	05.01-		LK 092	LR 020
26.603 DFC, DFCL	18.273	441	06.96-	D 2840 LF20	LK 092	LR 020
26.603 DFK, DFLK	18.273	441	06.96-		LK 092	LR 020
26.603 DFS, DFSL	18.273	441	06.96-	D 2840 LF20	LK 092	LR 020
26.604 DFSL	18.273	441	04.00-		LK 092	LR 020
27.273 DFAC	9.973	198	01.94-12.95	D 2865 LF22	LK 092	LR 020
27.273 DFAK	9.973	198	01.94-12.95	D 2865 LF22	LK 092	LR 020
27.273 DFAS	9.973	198	01.94-12.95		LK 092	LR 020
27.273 DFC	9.973	198	01.94-12.95		LK 092	LR 020
27.273 DFK	9.973	198	01.94-12.95	D 2865 LF22	LK 092	LR 020
27.273 DFS	9.973	198	01.94-12.95	D 2865 LF22	LK 092	LR 020
27.293 DFAC	9.973	213	01.94-	D 2865 LF24	LK 092	LR 020
27.293 DFAK	9.973	213	01.94-		LK 092	LR 020
27.293 DFAS	9.973	213	01.94-	D 2865 LF20	LK 092	LR 020
27.293 DFC	9.973	213	01.94-		LK 092	LR 020
27.293 DFK	9.973	213	01.94-		LK 092	LR 020
27.293 DFS	9.973	213	01.94-	D 2865 LF24	LK 092	LR 020
27.314 DFAC	11.967	228	05.01-		LK 092	LR 020
27.314 DFAK, DFA-KI	11.967	228	05.01-		LK 092	LR 020
27.314 DFAS	11.967	228	05.01-		LK 092	LR 020
27.314 DFC	11.967	228	05.01-		LK 092	LR 020
27.314 DFK, DF-KI	11.967	228	05.01-		LK 092	LR 020
27.314 DFS	11.967	228	05.01-		LK 092	LR 020
27.314 DF-TM	11.967	228	05.01-		LK 092	LR 020
27.323 DFAC	9.973	235	01.94-12.95		LK 092	LR 020
27.323 DFAK, DFA-KI	9.973	235	01.94-12.95		LK 092	LR 020
27.323 DFAS	9.973	235	01.94-12.95	D 2865 LF23	LK 092	LR 020
27.323 DFC	9.973	235	01.94-12.95	D 2865 LF23	LK 092	LR 020
27.323 DFK, DF-KI	9.973	235	01.94-12.95		LK 092	LR 020
27.323 DFS	9.973	235	01.94-12.95		LK 092	LR 020
27.343 DFAC	9.973	250	01.94-		LK 092	LR 020
27.343 DFAK	9.973	250	01.94-	D 2865 LF21	LK 092	LR 020
27.343 DFAS	9.973	250	01.94-	D 2865 LF21	LK 092	LR 020
27.343 DFC	9.973	250	01.94-	D 2865 LF21	LK 092	LR 020
27.343 DFK	9.973	250	01.94-		LK 092	LR 020
27.343 DFS	9.973	250	01.94-		LK 092	LR 020
27.364 DFAC	11.967	265	05.01-		LK 092	LR 020
27.364 DFAK, DFA-KI	11.967	265	05.01-		LK 092	LR 020
27.364 DFAS	11.967	265	05.01-		LK 092	LR 020
27.364 DFC	11.967	265	05.01-		LK 092	LR 020
27.364 DFK, DF-KI	11.967	265	05.01-		LK 092	LR 020
27.364 DFS	11.967	265	05.01-		LK 092	LR 020
27.364 DF-TM	11.967	265	05.01-		LK 092	LR 020
27.373 DFAC	11.967	272	01.94-12.95	D 2866 LF21	LK 092	LR 020



kW

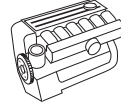

MAN						
F 2000						
27.373 DFAK, DFA-KI	11.967	272	01.94-12.95		LK 092	LR 020
27.373 DFAS	11.967	272	01.94-12.95	D 2866 LF21	LK 092	LR 020
27.373 DFC	11.967	272	01.94-12.95		LK 092	LR 020
27.373 DFK, DF-KI	11.967	272	01.94-12.95	D 2866 LF21	LK 092	LR 020
27.373 DFS	11.967	272	01.94-12.95		LK 092	LR 020
27.373 DF-TM	11.967	272	07.00-		LK 092	LR 020
27.403 DFAC	11.967	294	01.94-		LK 092	LR 020
27.403 DFAK, DFA-KI	11.967	294	01.94-		LK 092	LR 020
27.403 DFAS	11.967	294	01.94-	D 2866 LF20	LK 092	LR 020
27.403 DFC	11.967	294	01.94-		LK 092	LR 020
27.403 DFK, DF-KI	11.967	294	01.94-	D 2866 LF20	LK 092	LR 020
27.403 DFS	11.967	294	01.94-	D 2866 LF20	LK 092	LR 020
27.403 DF-TM	11.967	294	07.00-		LK 092	LR 020
27.414 DFAC	11.967	301	05.01-		LK 092	LR 020
27.414 DFAK, DFA-KI	11.967	301	05.01-		LK 092	LR 020
27.414 DFAS	11.967	301	05.01-		LK 092	LR 020
27.414 DFC	11.967	301	05.01-		LK 092	LR 020
27.414 DFK, DF-KI	11.967	301	05.01-		LK 092	LR 020
27.414 DFS	11.967	301	05.01-		LK 092	LR 020
27.414 DF-TM	11.967	301	05.01-		LK 092	LR 020
27.423 DFAC	11.967	309	01.94-12.95	D 2866 LF22	LK 092	LR 020
27.423 DFAK, DFA-KI	11.967	309	01.94-12.95	D 2866 LF22	LK 092	LR 020
27.423 DFAS	11.967	309	01.94-12.95		LK 092	LR 020
27.423 DFC	11.967	309	01.94-12.95		LK 092	LR 020
27.423 DFK, DF-KI	11.967	309	01.94-12.95	D 2866 LF22	LK 092	LR 020
27.423 DFS	11.967	309	01.94-12.95		LK 092	LR 020
27.423 DF-TM	11.967	309	07.00-		LK 092	LR 020
27.463 DFAC	12.816	338	01.94-	D 2876 LF 02	LK 092	LR 020
27.463 DFAK, DFA-KI	12.816	338	01.94-		LK 092	LR 020
27.463 DFAS	12.816	338	01.94-		LK 092	LR 020
27.463 DFC	12.816	338	01.94-	D 2876 LF 02	LK 092	LR 020
27.463 DFK, DF-KI	12.816	338	01.94-	D 2876 LF 02	LK 092	LR 020
27.463 DFS	12.816	338	01.94-	D 2876 LF 02	LK 092	LR 020
27.463 DF-TM	12.816	338	07.00-		LK 092	LR 020
27.464 DFAC	12.816	338	05.01-		LK 092	LR 020
27.464 DFAK, DFA-KI	12.816	338	05.01-		LK 092	LR 020
27.464 DFAS	12.816	338	05.01-		LK 092	LR 020
27.464 DFC	12.816	338	01.94-		LK 092	LR 020
27.464 DFK, DF-KI	12.816	338	05.01-		LK 092	LR 020
27.464 DFS	12.816	338	01.94-	D 2876 LF 06	LK 092	LR 020
27.464 DF-TM	12.816	338	05.01-		LK 092	LR 020
27.603 DFAS	18.273	441	01.96-	D 2840 LF20	LK 092	LR 020
27.603 DFS	18.273	441	01.96-	D 2840 LF20	LK 092	LR 020
32.293 VFC	9.973	213	08.95-		LK 092	LR 020
32.314 VF, VFC	11.967	228	05.01-		LK 092	LR 020
32.314 VFK, VF-HK	11.967	228	05.01-		LK 092	LR 020
32.314 VF-TM	11.967	228	05.01-		LK 092	LR 020
32.343 VFC	9.973	250	08.95-		LK 092	LR 020
32.343 VFK	9.973	250	08.95-	D 2865 LF21	LK 092	LR 020
32.364 VF, VFC	11.967	265	05.01-		LK 092	LR 020
32.364 VFK, VF-HK	11.967	265	05.01-		LK 092	LR 020
32.364 VF-TM	11.967	265	05.01-		LK 092	LR 020
32.403 VFC	11.967	294	08.95-		LK 092	LR 020
32.403 VFK	11.967	294	08.95-		LK 092	LR 020
32.414 VF, VFC	11.967	301	05.01-		LK 092	LR 020
32.414 VFK, VF-HK	11.967	301	05.01-		LK 092	LR 020
32.414 VF-TM	11.967	301	05.01-		LK 092	LR 020
32.463 VFC	12.816	338	08.95-	D 2876 LF 02	LK 092	LR 020
32.463 VFK	12.816	338	08.95-	D 2876 LF 02	LK 092	LR 020
32.464 VF, VFC	12.816	338	05.01-		LK 092	LR 020
32.464 VFK, VF-HK	12.816	338	05.01-		LK 092	LR 020
32.464 VF-TM	12.816	338	05.01-		LK 092	LR 020



kW

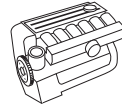

MAN

F 2000

33.323 DFAC	9.973	235	01.94-12.95		LK 092	LR 020
33.323 DFAK	9.973	235	01.94-12.95		LK 092	LR 020
33.323 DFAS	9.973	235	01.94-12.95		LK 092	LR 020
33.323 DFC	9.973	235	01.94-12.95		LK 092	LR 020
33.323 DFK	9.973	235	01.94-12.95	D 2865 LF23	LK 092	LR 020
33.323 DFS	9.973	235	01.94-12.95		LK 092	LR 020
33.343 DFAC	9.973	250	01.94-	D 2865 LF21	LK 092	LR 020
33.343 DFAK	9.973	250	01.94-		LK 092	LR 020
33.343 DFAS	9.973	250	01.94-	D 2865 LF21	LK 092	LR 020
33.343 DFC	9.973	250	01.94-		LK 092	LR 020
33.343 DFK	9.973	250	01.94-	D 2865 LF21	LK 092	LR 020
33.343 DFS	9.973	250	01.94-		LK 092	LR 020
33.364 DFAC	11.967	265	05.01-		LK 092	LR 020
33.364 DFAK, DFA-KI	11.967	265	05.01-		LK 092	LR 020
33.364 DFAS	11.967	265	05.01-		LK 092	LR 020
33.364 DFC	11.967	265	05.01-		LK 092	LR 020
33.364 DFK, DF-KI	11.967	265	05.01-		LK 092	LR 020
33.364 DFS, DFRS	11.967	265	05.01-		LK 092	LR 020
33.373 DFAC	11.967	272	01.94-12.95	D 2866 LF21	LK 092	LR 020
33.373 DFAK, DFA-KI	11.967	272	01.94-12.95		LK 092	LR 020
33.373 DFAS	11.967	272	01.94-12.95		LK 092	LR 020
33.373 DFC	11.967	272	01.94-12.95		LK 092	LR 020
33.373 DFK, DF-KI	11.967	272	01.94-12.95		LK 092	LR 020
33.373 DFS, DFRS	11.967	272	01.94-12.95	D 2866 LF21	LK 092	LR 020
33.403 DFAC	11.967	294	01.94-	D 2866 LF20	LK 092	LR 020
33.403 DFAK, DFA-KI	11.967	294	01.94-		LK 092	LR 020
33.403 DFAS	11.967	294	01.94-	D 2866 LF20	LK 092	LR 020
33.403 DFC	11.967	294	01.94-	D 2866 LF20	LK 092	LR 020
33.403 DFK, DF-KI	11.967	294	01.94-		LK 092	LR 020
33.403 DFS, DFRS	11.967	294	01.94-	D 2866 LF20	LK 092	LR 020
33.414 DFAC	11.967	301	05.01-		LK 092	LR 020
33.414 DFAK, DFA-KI	11.967	301	05.01-		LK 092	LR 020
33.414 DFAS	11.967	301	05.01-		LK 092	LR 020
33.414 DFC	11.967	301	05.01-		LK 092	LR 020
33.414 DFK, DF-KI	11.967	301	05.01-		LK 092	LR 020
33.414 DFS, DFRS	11.967	301	05.01-		LK 092	LR 020
33.423 DFAC	11.967	309	01.94-12.95		LK 092	LR 020
33.423 DFAK, DFA-KI	11.967	309	01.94-12.95	D 2866 LF22	LK 092	LR 020
33.423 DFAS	11.967	309	01.94-12.95	D 2866 LF22	LK 092	LR 020
33.423 DFC	11.967	309	01.94-12.95	D 2866 LF22	LK 092	LR 020
33.423 DFK, DF-KI	11.967	309	01.94-12.95		LK 092	LR 020
33.423 DFS, DFRS	11.967	309	01.94-12.95		LK 092	LR 020
33.463 DFAC	12.816	338	01.94-	D 2876 LF 02	LK 092	LR 020
33.463 DFAK, DFA-KI	12.816	338	01.94-	D 2876 LF 02	LK 092	LR 020
33.463 DFAS	12.816	338	01.94-		LK 092	LR 020
33.463 DFC	12.816	338	01.94-		LK 092	LR 020
33.463 DFK, DF-KI	12.816	338	01.94-		LK 092	LR 020
33.463 DFS, DFRS	11.967	338	01.94-		LK 092	LR 020
33.464 DFAC	12.816	338	05.01-		LK 092	LR 020
33.464 DFAK, DFA-KI	12.816	338	05.01-		LK 092	LR 020
33.464 DFAS	12.816	338	05.01-		LK 092	LR 020
33.464 DFC	12.816	338	05.01-		LK 092	LR 020
33.464 DFK, DF-KI	12.816	338	05.01-		LK 092	LR 020
33.464 DFS, DFRS	12.816	338	05.01-		LK 092	LR 020
33.603 DFAC	18.273	441	06.96-		LK 092	LR 020
33.603 DFAS	18.273	441	06.96-		LK 092	LR 020
33.603 DFC	18.273	441	06.96-		LK 092	LR 020
33.603 DFS	18.273	441	06.96-	D 2840 LF20	LK 092	LR 020
35.314 VF-TM	11.967	228	03.02-		LK 092	LR 020
35.343 VFC	9.973	250	08.95-	D 2865 LF21	LK 092	LR 020
35.343 VFK	9.973	250	08.95-		LK 092	LR 020
35.364 VF, VFC, VFRC	11.967	265	05.01-		LK 092	LR 020



kW

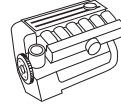

MAN					
F 2000					
35.364 VFK, VF-HK, VF-KI	11.967	265	03.02-		LK 092 LR 020
35.364 VF-TM	11.967	265	03.02-		LK 092 LR 020
35.373 VF, VFC, VFRC	11.967	272	05.01-		LK 092 LR 020
35.373 VFK, VF-HK, VF-KI	11.967	272	03.02-		LK 092 LR 020
35.403 VF, VFC, VFRC	11.967	294	08.95-		LK 092 LR 020
35.403 VFK, VF-HK, VF-KI	11.967	294	08.95-		LK 092 LR 020
35.414 VF, VFC, VFRC	11.967	301	05.01-		LK 092 LR 020
35.414 VFK, VF-HK, VF-KI	11.967	301	03.02-		LK 092 LR 020
35.414 VF-TM	11.967	301	03.02-		LK 092 LR 020
35.423 VF, VFC	11.967	309	05.01-		LK 092 LR 020
35.423 VFK, VF-HK, VF-KI	11.967	309	03.02-		LK 092 LR 020
35.463 VF, VFC, VFRC	12.816	338	08.95-	D 2876 LF 02	LK 092 LR 020
35.463 VFK, VF-HK, VF-KI	12.816	338	08.95-		LK 092 LR 020
35.464 VF, VFC, VFRC	12.816	338	05.01-		LK 092 LR 020
35.464 VFK, VF-HK, VF-KI	12.816	338	03.02-		LK 092 LR 020
35.464 VF-TM	12.816	338	03.02-		LK 092 LR 020
40.273 DFAK	9.973	198	01.94-		LK 092 LR 020
40.273 DFK	9.973	198	01.94-	D 2865 LF22	LK 092 LR 020
40.373 DFAK	11.967	272	05.01-		LK 092 LR 020
40.373 DFK	11.967	272	05.01-		LK 092 LR 020
40.403 DFAK	11.967	294	01.94-	D 2866 LF20	LK 092 LR 020
40.403 DFK	11.967	294	01.94-	D 2866 LF20	LK 092 LR 020
40.414 DFAK	11.967	301	05.01-		LK 092 LR 020
40.414 DFK	11.967	301	05.01-		LK 092 LR 020
40.423 DFAK	11.967	309	05.01-		LK 092 LR 020
40.423 DFK	11.967	309	05.01-		LK 092 LR 020
40.463 DFAK	12.816	338	01.94-		LK 092 LR 020
40.463 DFAS	12.816	338	01.94-	D 2876 LF 02	LK 092 LR 020
40.463 DFK	12.816	338	01.94-	D 2876 LF 02	LK 092 LR 020
41.343 VFC	9.973	250	08.95-	D 2865 LF21	LK 092 LR 020
41.343 VFK	9.973	250	08.95-		LK 092 LR 020
41.364 VF, VFC, VFRC	11.967	265	05.01-		LK 092 LR 020
41.364 VFK, VF-HK, VF-KI	11.967	265	03.02-		LK 092 LR 020
41.373 VF, VFC, VFRC	11.967	272	05.01-		LK 092 LR 020
41.373 VFK, VF-HK, VF-KI	11.967	272	03.02-		LK 092 LR 020
41.403 VF, VFC, VFRC	11.967	294	08.95-		LK 092 LR 020
41.403 VFK, VF-HK, VF-KI	11.967	294	08.95-		LK 092 LR 020
41.414 VF, VFC, VFRC	11.967	301	05.01-		LK 092 LR 020
41.414 VFK, VF-HK, VF-KI	11.967	301	03.02-		LK 092 LR 020
41.423 VF, VFC, VFRC	11.967	309	05.01-		LK 092 LR 020
41.423 VFK, VF-HK, VF-KI	11.967	309	03.02-		LK 092 LR 020
41.463 VF, VFC, VFRC	12.816	338	08.95-		LK 092 LR 020
41.463 VFK, VF-HK, VF-KI	12.816	338	08.95-		LK 092 LR 020
41.464 VF, VFC, VFRC	12.816	338	06.98-	D 2876 LF 06	LK 092 LR 020
41.464 VFK, VF-HK, VF-KI	12.816	338	03.02-		LK 092 LR 020
10.145 LC,10.145 LLC, LRC, LLRC (LE140C)	4.580	103	09.00-	D 0834 LFL02	LR 036
10.145 LK, LRK, L-KI, LR-KI (LE140C)	4.580	103	09.00-	D 0834 LFL02	LR 036
10.145 LLS, LLRS (LE140C)	4.580	103	09.00-	D 0834 LFL02	LR 036
10.150 FOC	4.580	114-118	02.95-01.96	D 0824 LFO	LR 036
10.153 LAEK	4.580	114	10.93-06.96	D 0824 LFL01/ 05	LR 036
10.153 LC,10.153 LLC	4.580	114	10.93-06.96	D 0824 LFL01/ 05	LR 036
10.153 LK	4.580	114	10.93-06.96	D 0824 LFL01/ 05	LR 036
10.153 LLS	4.580	114	10.93-	D 0824 LFL01/ 05	LR 036
10.155 LK, LRK	4.580	114	02.04-	-	LR 036
10.163 LAC, LAEC, LARC, LAERC	4.580	114-118	05.94-	D 0824 LFL02/ 06/ 09	LR 036
10.163 LAK, LAEK, LARK, LAERK	4.580	114-118	01.95-	D 0824 LFL02/ 06/ 09	LR 036
10.163 LC,10.163 LLC	4.580	114	05.94-	D 0824 LFL02/ 06/ 09	LR 036
10.163 LC,10.163 LLC, LRC, LLRC (LE160C)	4.580	114	09.00-	D 0824 LFL09	LR 036
10.163 LK, LRK, L-KI, LR-KI	4.580	114-118	05.94-	D 0824 LFL02/ 06/ 09	LR 036
10.163 LLS, LLRS	4.580	114-118	05.94-	D 0824 LFL02/ 06/ 09	LR 036
10.185 LAC, LAEC, LARC, LAERC, LA-LA, LAE-LF (LE180C)	4.580	132	09.00-	D 0834 LFL03	LR 036



kW

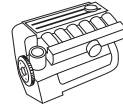

MAN

F 2000

10.185 LAK, LAEK, LARK, LAERK (LE180C)	4.580	132	09.00-	D 0834 LFL03	LR 036
10.185 LC,10.185 LLC, LRC, LLRC (LE180C)	4.580	132	09.00-	D 0834 LFL03	LR 036
10.185 LK, LRK, L-KI, LR-KI (LE180C)	4.580	132	09.00-	D 0834 LFL03	LR 036
10.185 LLS, LLRS (LE180C)	4.580	132	09.00-	D 0834 LFL03	LR 036
10.220 FOC,10.220 FOCL	6.871	162	02.95-	D 0826 LFL03	LR 036
10.223 LAEC	6.871	162	01.95-06.96	D 0826 LFL06	LR 036
10.223 LC,10.223 LLC	6.871	162-169	10.93-06.96	D 0826 LFL02/ 06	LR 036
10.223 LK	6.871	162-169	10.93-06.96	D 0826 LFL02/ 06	LR 036
10.223 LLS	6.871	162-169	10.93-06.96	D 0826 LFL02/ 06	LR 036
10.224 LAC, LAEC, LARC, LAERC	6.871	162	01.95-	D 0826 LFL03/ 10	LR 036
10.224 LAK, LAEK, LARK, LAERK	6.871	162	01.95-	D 0826 LFL03	LR 036
10.224 LC,10.224 LLC, LRC, LLRC	6.871	162	01.95-	D 0826 LFL03/ 10	LR 036
10.224 LK, LRK, L-KI, LR-KI	6.871	162	05.94-	D 0826 LFL03	LR 036
10.224 LLS, LLRS	6.871	162	05.94-	D 0826 LFL03	LR 036
10.225 LAC, LAEC, LARC, LAERC, LA-LF, LAE-LF (LE220C)	6.871	162	09.00-	D 0836 LFL02	LR 036
10.225 LAK, LAEK, LARK, LAERK (LE220C)	6.871	162	09.00-	D 0836 LFL02	LR 036
10.225 LC, 10.225 LLC, LRC, LLRC	6.871	162	09.00-	D 0836 LFL02	LR 036
10.225 LC, 10.225 LLC, LRC, LLRC (LE220C)	6.871	162	09.00-	D 0836 LFL02	LR 036
10.225 LK, LRK, L-KI, LR-KI(LE220C)	6.871	162	09.00-	D 0836 LFL02	LR 036
10.225 LLS, LLRS (LE220C)	6.871	162	09.00-	D 0836 LFL02	LR 036
8.103 LC, 8.103 LLC	4.580	75	10.93-06.96	D 0824 FL 01	LR 036
8.103 LK	4.580	75	10.93-06.96	D 0824 FL 01	LR 036
8.113 LC, 8.113 LLC	4.580	81	08.95-	D 0824 LFL 04	LR 036
8.113 LC,8.113 LLC, LRC, LLRC, (LE110C)	4.580	83	09.00-	D 0824 LFL 08	LR 036
8.113 LK, LRK, L-KI, LR-KI	4.580	81	08.95-	D 0824 LFL 04	LR 036
8.145 LC,8.145 LLC, L-LF (LE140C)	4.580	103	09.00-	D 0834 LFL 02	LR 036
8.145 LLS, LLRS (LE140C)	4.580	103	09.00-	D 0834 LFL 02	LR 036
8.145 LRK, L-KI, LR-KILK (LE140C)	4.580	103	09.00-	D 0834 LFL 02	LR 036
8.145, LA-LF LAE-LF	4.580	103	07.00-	-	LR 036
8.150 FOC,8.150 FOCL	4.580	114-118	03.95-	D 0824 LFO	LR 036
8.153 LAEC	4.580	114	01.95-06.96	D 0824 LFL 01/ D 0824 LFL 05	LR 036
8.153 LAEK	4.580	114	01.95-09.96	D 0824 LFL 01/ D 0824 LFL 05	LR 036
8.153 LC,8.153 LLC	4.580	114	10.93-07.97	D 0824 LFL 01/ D 0824 LFL 05	LR 036
8.153 LK	4.580	114	10.93-07.97	D 0824 LFL 01/ D 0824 LFL 05	LR 036
8.153 LLS	4.580	114	10.93-06.96	D 0824 LFL 01/ D 0824 LFL 05	LR 036
8.155 L, LR, LC, LLC, LRC, LLRC, L-LF	4.580	114	02.04-	D 0824 LFL 07	LR 036
8.155 LK, LRK	4.580	114	02.04-	D 0824 LFL 02	LR 036
8.155 LLS, LLRS	4.580	114	02.04-	D 0824 LFL 06	LR 036
8.163 LAC, LAEC, LARC, LAERC, LA-LF, LAE-LF	4.580	114-118	01.95-	D 0824 LFL 02/ 06/ 09	LR 036
8.163 LAEC	4.580	104	08.95-03.97	D 0824 LFL 07	LR 036
8.163 LAK, LARK, LAEK, LAERK	4.580	104	04.00-	D 0824 LFL 02	LR 036
8.163 LC,8.163 LLC	4.580	114-118	05.94-	D 0824 LFL 02/ 06/ 09	LR 036
8.163 LC,8.163 LLC (LE160C)	4.580	114	09.00-	D 0824 LFL 09	LR 036
8.163 LC,8.163 LLC, LRC, LLRC, L-LF	4.580	104	08.95-	D 0824 LFL 09	LR 036
8.163 LK, LRK, L-KI, LR-KI	4.580	114-118	05.94-	D 0824 LFL 02/ 06/ 09	LR 036
8.163 LLS, LLRS	4.580	114-118	05.94-	D 0824 LFL 02/ 06/ 09	LR 036
8.185 LAC, LAEC, LARC, LAERC, LA-LF, LAE-LF (LE180C)	4.580	132	09.00-	D 0834 LFL03	LR 036
8.185 LAK, LAEK, LARK, LAERK (LE180C)	4.580	132	09.00-	D 0834 LFL03	LR 036
8.185 LC,8.185 LLC, LRC, LLRC, L-LF (LE180C)	4.580	132	09.00-	D 0826 LFL03	LR 036
8.185 LK, LRK, L-KI, LR-KI (LE180C)	4.580	132	09.00-	D 0834 LFL03	LR 036
8.185 LLS, LLRS (LE180C)	4.580	132	09.00-	D 0834 LFL03	LR 036
8.220 FOC,8.220 FOCL	6.871	162	04.95-	D 0826 LFL03	LR 036
8.223 LAEC	6.871	162	01.95-06.96	D 0826 LFL06	LR 036
8.223 LC,8.223 LLC	6.871	162	10.93-06.96	D 0826 LFL02/ 06	LR 036
8.223 LK	6.871	162	10.93-06.96	D 0826 LFL02/ 06	LR 036
8.223 LLS	6.871	162	10.93-06.96	D 0826 LFL02/ 06	LR 036
8.224 LAC, LAEC, LARC, LAERC	6.871	162	01.95-	D 0826 LFL03	LR 036
8.224 LAK, LAEK, LARK, LAERK	6.871	162	01.95-	D 0826 LFL03	LR 036
8.224 LC,8.224 LLC, LRC, LLRC	6.871	162	05.94-	D 0826 LFL03	LR 036
8.224 LK, LRK, L-KI, LR-KI	6.871	162	05.94-	D 0826 LFL03	LR 036



kW

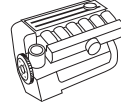

MAN						
L 2000						
8.224 LLS, LLRS	6.871	162	05.94-	D 0826 LFL03		LR 036
8.225 LAC, LAEC, LARC, LAERC (LE220C)		162	09.00-	D 0836 LFL02		LR 036
8.225 LAK, LAEK, LARK, LAERK (LE220C)		162	09.00-	D 0836 LFL02		LR 036
8.225 LC,8.225 LLC, LRC, LLRC (LE220C)	6.871	162	09.00-	D 0826 LFL02/ 10		LR 036
8.225 LK, LRK, L-KI, LR-KI (LE220C)	6.871	162	09.00-	D 0836 LFL02		LR 036
8.225 LLS, LLRS (LE220C)	6.871	162	09.00-	D 0836 LFL02		LR 036
9.145 LC,9.145 LLC, LRC, LLRC (LE140C)	4.580	103	09.00-	D 0834 LFL02		LR 036
9.145 LK, LRK, L-KI, LR-KI (LE140C)	4.580	103	09.00-	D 0834 LFL02		LR 036
9.145 LLS, LLRS (LE140C)	4.580	103	09.00-	D 0834 LFL02		LR 036
9.153 LC,9.153 LLC	4.580	114	10.93-06.96	D 0824 LFL01/ 05		LR 036
9.153 LK	4.580	114	10.93-06.96	D 0824 LFL01/ 05		LR 036
9.153 LLS	4.580	114	10.93-12.95	D 0824 LFL01/ 05		LR 036
9.155 L, LC, LLC, LRC, LLRC	4.580	114	02.04-	-		LR 036
9.155 LK, LRK	4.580	114	02.04-	-		LR 036
9.155 LLS, LLRS	4.580	114	02.04-	-		LR 036
9.163 LC	4.580	104	08.95-03.97	D 0824 LFL07		LR 036
9.163 LC,9.163 LLC, LRC, LLRC	4.580	114-118	05.94-	D 0824 LFL02/ 06/ 09		LR 036
9.163 LK	4.580	104	08.95-03.97	D 0824 LFL07		LR 036
9.163 LK, LRK, L-KI, LR-KI	4.580	114-118	05.94-	D 0824 LFL02/ 06/ 09		LR 036
9.163 LLS, LLRS	4.580	114-118	05.94-	D 0824 LFL02/ 06/ 09		LR 036
9.185 LC,9.185 LLC, LRC, LLRC (LE180C)	4.580	132	09.00-	D 0834 LFL03		LR 036
9.185 LK, LRK, L-KI, LR-KI (LE180C)	4.580	103	09.00-	D 0834 LFL03		LR 036
9.185 LLS, LLRS (LE 180C)	4.580	132	09.00-	D 0834 LFL03		LR 036
9.223 LC,9.223 LLC	6.871	162-169	10.93-06.96	D 0826 LFL02/ 06		LR 036
9.223 LK	6.871	162-169	10.93-06.96	D 0826 LFL02/ 06		LR 036
9.223 LLS	6.871	162-169	10.93-06.96	D 0826 LFL02/ 06		LR 036
9.224 LC,9.224 LLC, LRC, LLRC	6.871	162	05.94-	D 0826 LFL03		LR 036
9.224 LK, LRK, L-KI, LR-KI	6.871	162	05.94-	D 0826 LFL03		LR 036
9.224 LLS, LLRS	6.871	162	05.94-	D 0826 LFL03		LR 036
9.225 LC,9.225 LLC, LRC, LLRC (LE220C)	6.871	162	09.00-	D 0836 LFL02		LR 036
9.225 LK, LRK, L-KI, LR-KI (LE220C)	6.871	162	09.00-	D 0836 LFL02		LR 036
9.225 LLS, LLRS (LE220C)	6.871	162	09.00-	D 0836 LFL02		LR 036
M 2000 L						
12.145 LC, LLC, LRC, LLRC	4.580	107	05.01-		LK 094	LR 017
12.145 LK, LRK	4.580	107	05.01-		LK 094	LR 017
12.163 LC, LLC, LRC, LLRC	4.580	114	08.95-		LK 094	LR 017
12.163 LK, LRK	4.580	114	08.95-	D 0824 LFL 06	LK 094	LR 017
12.185 LC, LLC, LRC, LLRC	9.660	136	05.01-		LK 094	LR 017
12.185 LK, LRK	9.660	136	05.01-		LK 094	LR 017
12.224 LC, LLC, LRC, LLRC	6.871	162	08.95-	D 0826 LFL10	LK 094	LR 017
12.224, 12.225, LK, LRK	6.871	162	08.95-	D 0826 LFL10	LK 094	LR 017
12.225 LC, LLC, LLLC, LRC, LLRC	6.871	162	05.01-		LK 094	LR 017
12.255 LC, LLC, LLLC	6.871	180	08.02-		LK 094	LR 017
12.255 LK	6.871	180	10.03-		LK 094	LR 017
12.285 LC, LLC, LLLC	6.871	206	08.02-		LK 094	LR 017
12.285 LK	6.871	206	10.03-		LK 094	LR 017
14.163 LC, LLC, LRC, LLRC	4.580	114	08.95-	D 0824 LFL 09	LK 094	LR 017
14.163 LK, LRK	4.580	114	08.95-	D 0824 LFL 09	LK 094	LR 017
14.185 LC, LLC, LRC, LLRC	9.660	136	05.01-		LK 094	LR 017
14.185 LK, LRK	9.660	136	05.01-		LK 094	LR 017
14.224 LAC, LARC	6.871	162	08.95-		LK 094	LR 017
14.224 LAK, LARK	6.871	162	08.95-	D 0826 LFL03	LK 094	LR 017
14.224 LC, LLC, LLLC, LRC, LLRC, LLLRC	6.871	162	08.95-		LK 094	LR 017
14.224 LK, LRK	6.871	162	08.95-	D 0826 LFL10	LK 094	LR 017
14.224, 14.225, LA-LF	6.871	162	07.03-		LK 094	LR 017
14.225 LAC, LARC, (LE220B)	6.871	162	09.00-	D 0836 LFL 02	LK 094	LR 017
14.225 LAK, LARK, (LE220B)	6.871	162	09.00-	D 0836 LFL 02	LK 094	LR 017
14.225 LC, LLC, LLLC, LRC, LLRC, LLLRC, (LE220B)	6.871	162	09.00-		LK 094	LR 017
14.225 LK, LRK (LE220B)	6.871	162	09.00-	D 0836 LFL 02	LK 094	LR 017
14.255 LAC, LARC	6.871	180	11.02-		LK 094	LR 017
14.255 LAK, LARK	6.871	180	11.02-		LK 094	LR 017



kW

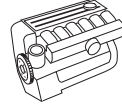

MAN

M 2000 L

14.255 LA-LF	6.871	180	07.03-			LK 094	LR 017
14.255 LC, LLC, LLLC, LRC, LLRC, LLLRC, (LE250B)	6.871	180	09.00-	D 0836 LFL 05		LK 094	LR 017
14.255 LK, LRK	6.871	180	11.02-			LK 094	LR 017
14.263, 14.264 LAC, LARC	6.871	191	08.95-	D 0826 LFL09		LK 094	LR 017
14.263, 14.264 LAK, LARK	6.871	191	08.95-	D 0826 LFL09		LK 094	LR 017
14.263, 14.264 LC, LLC, LLLC, LRC, LLRC, LLLRC	6.871	191	08.95-			LK 094	LR 017
14.263, 14.264 LK, LRK	6.871	191	08.95-			LK 094	LR 017
14.264 LA-LF	6.871	191	07.03-			LK 094	LR 017
14.284 LC, LLC, LLLC, LRC, LLRC, LLLRC	6.871	206	10.98-	D 0836 LF 01		LK 094	LR 017
14.284, 14.285, LAC, LARC	6.871	206	06.98-			LK 094	LR 017
14.284, 14.285, LAK, LARK	6.871	206	06.98-			LK 094	LR 017
14.284, 14.285, LA-LF	6.871	206	06.98-			LK 094	LR 017
14.284, 14.285, LK, LRK	6.871	206	10.98-	D 0836 LF 01		LK 094	LR 017
14.285 LC, LLC, LLLC, LRC, LLRC, LLLRC, (LE280B)	6.871	206	09.00-	D 0836 LFL 03		LK 094	LR 017
15.163 LC, LLC, LRC	4.580	114	08.95-	D 0824 LFL 09		LK 094	LR 017
15.163 LK, LRK	4.580	114	08.95-			LK 094	LR 017
15.185 LC, LRC	9.660	136	05.01-			LK 094	LR 017
15.185 LK, LRK	9.660	136	11.02-			LK 094	LR 017
15.224 LC, LLC, LLLC, LRC, LLRC, LLLRC	6.871	162	08.95-	D 0826 LFL03		LK 094	LR 017
15.224 LK, LRK	6.871	162	08.95-			LK 094	LR 017
15.225 LC, LLC, LLLC, LRC, LLRC, LLLRC, (LE220B)	6.871	162	09.99-			LK 094	LR 017
15.225 LK, LRK, (LE220B)	6.871	162	09.99-	D 0836 LFL 02		LK 094	LR 017
15.255 LC, LLC, LLLC, LRC, LLRC, LLLRC, (LE250B)	6.871	180	09.99-			LK 094	LR 017
15.255 LK, LRK, (LE250B)	6.871	180	09.99-	D 0836 LFL 05		LK 094	LR 017
15.263, 15.264 LC, LLC, LLLC, LRC, LLRC, LLLRC	6.871	191	08.95-			LK 094	LR 017
15.263, 15.264 LK, LRK	6.871	191	08.95-			LK 094	LR 017
15.284 LC, LLC, LLLC, LRC, LLRC, LLLRC	6.871	206	06.98-			LK 094	LR 017
15.284 LK, LRK	6.871	206	06.98-			LK 094	LR 017
15.285 LC, LLC, LLLC, LRC, LLRC, LLLRC, (LE280B)	6.871	206	09.99-	D 0836 LFL 03		LK 094	LR 017
15.285 LK, LRK, (LE280B)	6.871	206	09.99-			LK 094	LR 017
18.224, 18.225, LAC, LARC	6.871	162	08.95-	D 0826 LFL10		LK 094	LR 017
18.224, 18.225, LAK, LARK	6.871	162	08.95-	D 0826 LFL03		LK 094	LR 017
18.224, 18.225, LC, LLC, LLLC, LRC, LLRC, LLLRC	6.871	162	08.95-	D 0826 LFL10		LK 094	LR 017
18.224, 18.225, LK, LK, LRK, LLRK	6.871	162	08.95-			LK 094	LR 017
18.224, 18.225, L-KO, LR-KO	6.871	162	05.01-			LK 094	LR 017
18.255 LAC, LARC	6.871	180	05.01-			LK 094	LR 017
18.255 LAK, LARK	6.871	180	05.01-			LK 094	LR 017
18.255 LC, LLC, LLLC, LRC, LLRC, LLLRC, (LE250B)	6.871	180	09.99-	D 0836 LFL 05		LK 094	LR 017
18.255 LK, LK, LRK, LLRK	6.871	180	11.02-			LK 094	LR 017
18.255 L-KO, LR-KO	6.871	180	05.01-			LK 094	LR 017
18.263, 18.264, LAC, LARC	6.871	191	08.95-			LK 094	LR 017
18.263, 18.264, LAK, LARK	6.871	191	08.95-			LK 094	LR 017
18.263, 18.264, LC, LLC, LLLC, LRC, LLRC, LLLRC	6.871	191	08.95-			LK 094	LR 017
18.263, 18.264, LK, LK, LRK, LLRK	6.871	191	08.95-			LK 094	LR 017
18.263, 18.264, L-KO, LR-KO	6.871	191	05.01-			LK 094	LR 017
18.284 LAC, LARC	6.871	206	06.98-			LK 094	LR 017
18.284 LAK, LARK	6.871	206	06.98-			LK 094	LR 017
18.284 LC, LLC, LLLC, LRC, LLRC, LLLRC	6.871	206	06.98-	D 0836 LF 01		LK 094	LR 017
18.284 LK, LK, LRK, LLRK	6.871	206	06.98-			LK 094	LR 017
18.284 L-KO, LR-KO	6.871	206	06.98-	D 0836 LF 01		LK 094	LR 017
18.285 LAC, (LE280B)	6.871	206	09.99-			LK 094	LR 017
18.285 LAK, LARK, (LE280B)	6.871	206	09.99-			LK 094	LR 017
18.285 LC, LLC, LLLC, LRC, LLRC, LLLRC, (LE280B)	6.871	206	09.99-			LK 094	LR 017
18.285 LK, LK, LRK, LLRK	6.871	206	06.98-			LK 094	LR 017
18.285 L-KO, LR-KO	6.871	206	06.98-	D 0836 LF 01		LK 094	LR 017



kW

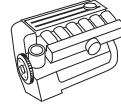

MAN					
M 2000 L					
19.224, 19.225, LLC	6.871	162	05.01-	LK 094	LR 017
19.255 LLC	6.871	180	05.01-	LK 094	LR 017
19.264 LLC	6.871	191	05.01-	LK 094	LR 017
19.284, 19.285, LLC	6.871	206	05.01-	LK 094	LR 017
20.224 LNLC, LNLLC	6.871	162	05.01-	LK 094	LR 017
20.255 LNLC, LNLLC	6.871	180	05.01-	LK 094	LR 017
20.264 LNLC, LNLLC	6.871	191	05.01-	LK 094	LR 017
20.284, 20.285, LNLC, LNLLC	6.871	206	05.01-	LK 094	LR 017
26.224, 26.225, DL-HK, DLR-HK	6.871	180	11.02-	LK 094	LR 017
26.255 DL-HK, DLR-HK	6.871	180	11.02-	LK 094	LR 017
26.284 DL-TM, DLR-TM	6.871	206	11.03-	LK 094	LR 017
26.284, 26.285, DL-HK, DLR-HK	6.871	206	11.02-	LK 094	LR 017
M 2000 M					
12.224 MC, MLC	6.871	162			LR 036
12.224 MLS	6.871	162			LR 036
12.255 MC, MLC	6.871	180			LR 036
12.255 MLS	6.871	180			LR 036
12.264 MC, MLC	6.871	191	08.95-06.96		LR 036
12.264 MLS	6.871	191	08.95-06.96		LR 036
12.284 MC, MLC	6.871				LR 036
12.284 MLS	6.871				LR 036
14.224 MAK	6.871	162	08.95-		LR 036
14.224 MA-KO, MA-LF	6.871	162	08.95-		LR 036
14.224 MC, MLC, MLLC	6.871	162	08.95-		LR 036
14.224 MK	6.871	162	08.95-		LR 036
14.224 MLS, MLRS	6.871	162	08.95-		LR 036
14.225 MC, MLC, MLLC	6.871	162	09.00-		LR 036
14.225 MLS, MLRS	6.871	162	09.00-		LR 036
14.255 MAK	6.871	180	11.02-		LR 036
14.255 MA-KO, MA-LF	6.871	180	11.02-		LR 036
14.255 MC, MLC, MLLC	6.871	180	11.02-		LR 036
14.255 MLS, MLRS	6.871	180	11.02-		LR 036
14.264 MAK	6.871	191			LR 036
14.264 MA-KO, MA-LF	6.871	191			LR 036
14.264 MC, MLC, MLLC	6.871	191			LR 036
14.264 MLS, MLRS	6.871	191			LR 036
14.284 MAK	6.871	206			LR 036
14.284 MA-KO, MA-LF	6.871	206			LR 036
14.284 MC, MLC, MLLC	6.871	206			LR 036
14.284 MLS, MLRS	6.871	206			LR 036
14.285 MLC, MLLC (ME280C)	6.871	206			LR 036
14.285 MLS, MLRS	6.871	206			LR 036
18.224 MAC, MARC	6.871	206	09.99-		LR 036
18.224 MAK, MARK	6.871	206	09.99-		LR 036
18.224 MC, MLC, MLLC, MRC, MLRC, MLLRC	6.871	206	09.99-		LR 036
18.224 MK, 18.224 MLK, MRK, MLRK	6.871	206	09.99-		LR 036
18.224 M-KO, MR-KO	6.871	206	09.99-		LR 036
18.224 MLS, MLRS	6.871	206	09.99-		LR 036
18.225 MAC, MARC	6.871	180	09.99-		LR 036
18.225 MC, MLC, MLLC, MRC, MLRC, MLLRC	6.871	180	09.99-		LR 036
18.255 MAC, MARC	6.871	180	09.99-		LR 036
18.255 MAK, MARK	6.871	180	09.99-		LR 036
18.255 MC, MLC, MLLC, MLRC, MLLRC	6.871	180	09.99-		LR 036
18.255 MK, MLK, MRK, MLRK	6.871	180	09.99-		LR 036
18.255 M-KO, MR-KO	6.871	180	09.99-		LR 036
18.255 MLS, MLRS	6.871	180	09.99-		LR 036
18.264 MAC, MARC	6.871	206	06.98-		LR 036
18.264 MAK, MARK	6.871	206	06.98-		LR 036
18.264 MC, MLC, MLLC, MRC, MLRC, MLLRC	6.871	206	06.98-		LR 036
18.264 MK, 18.264 MLK, MRK, MLRK	6.871	206	06.98-		LR 036
18.264 M-KO, MR-KO	6.871	206	06.98-		LR 036
18.264 MLS, MLRS	6.871	206	06.98-		LR 036



kW

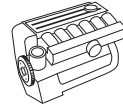

MAN

M 2000 M

18.284 MAC, MARC	6.871	206	06.98-			LR 036
18.284 MAK, MARK	6.871	206	06.98-			LR 036
18.284 MC, MLC, MLLC, MRC, MLRC, LLRC	6.871	206	06.98-			LR 036
18.284 MK, 18.284 MLK, MRK, MLRK	6.871	206	06.98-			LR 036
18.284 M-KO, MR-KO	6.871	206	06.98-			LR 036
18.284 MLS, MLRS	6.871	206	06.98-			LR 036
18.285 MAC, MARC	6.871	206	06.98-			LR 036
18.285 MC, MLC, MLLC	6.871	206	06.98-			LR 036
18.285 MLS, MLRS	6.871	206	06.98-			LR 036
25.224 MNLC, MNLLC, MNLRC, MNLLRC, MVLC	6.871	162	08.95-12.05	D 0826 LF 15/D 0826 LF 18/ D 0826 LFL 10		LR 036
25.225 MNLC, MNLLC, MNLRC, MNLLRC, MVLC	6.871	162	02.03-	D 0836 LF 04/ D 0836 LFL 02		LR 036
25.255 MNLC, MNLLC, MNLRC, MNLLRC, MVLC	6.871	180	10.00-	D 0836 LF 05/ D 0836 LFL 05		LR 036
25.264 MNLC, MNLLC, MNLRC, MNLLRC, MVLC	6.871	191	08.95-12.05	D 0826 LF 17		LR 036
25.284 MNLC, MNLLC, MNLRC, MNLLRC, MVLC	6.871	206	02.00-	D 0836 LF 01		LR 036
25.285 MNLC, MNLLC, MNLRC, MNLLRC, MVLC	6.871	206	02.03-	D 0836 LF 03/ D 0836 LFL 03		LR 036

M 90

12.152 F, 12.152 FL	6.871	110-114	12.88-05.94			LK 031
12.152 FK	6.871	110-114	12.88-05.94	D 0826 F01		LK 031
12.152 FS, 12.152 FLS	6.871	110-114	12.88-05.94	D 0826 F02		LK 031
12.192 F, 12.192 FL	6.871	140	07.90-06.96			LK 031
12.192 FA	6.871	140	10.92-06.96			LK 031
12.192 FAK	6.871	140	10.92-06.96			LK 031
12.192 FK	6.871	140	07.90-06.96	D 0826 LF07		LK 031
12.192 FS, 12.192 FLS	6.871	140	07.90-06.96			LK 031
12.222 F, 12.222 FL	6.871	162	05.94-06.96	D 0826 LF11		LK 031
12.222 FA	6.871	162	05.94-06.96	D 0826 LF11		LK 031
12.222 FAK	6.871	162	05.94-06.96	D 0826 LF11		LK 031
12.222 FK	6.871	162	05.94-06.96			LK 031
12.222 FLS	6.871	162	05.94-06.96	D 0826 LF11		LK 031
12.232 F, 12.232 FL	6.871	169	08.88-06.96	D 0826 LF08		LK 031
12.232 FA	6.871	169	05.90-06.96	D 0826 LF06		LK 031
12.232 FAK	6.871	169	05.90-06.96	D 0826 LF02		LK 031
12.232 FK	6.871	169	08.88-06.96			LK 031
12.232 FS, 12.232 FLS	6.871	169	08.88-06.96	D 0826 LF06		LK 031
12.262 F, 12.262 FL	6.871	191	08.95-06.96	D 0826 LF13		LK 031
12.262 FK	6.871	191	08.95-06.96			LK 031
12.262 FS, 12.262 FLS	6.871	191	08.95-06.96	D 0826 LF13		LK 031
12.272 F, 12.272 FL	9.973	198	09.91-10.92	D 2865 LF02		LK 031
12.272 F, 12.272 FL	6.871	198	10.92-06.96	D 0826 LF04		LK 031
12.272 FA	6.871	198	10.93-04.95			LK 031
12.272 FAK	6.871	198	10.93-04.95			LK 031
12.272 FK	9.973	198	09.91-10.92	D 2865 LF02		LK 031
12.272 FK	6.871	198	10.92-06.96	D 0826 LF04		LK 031
12.272 FS, 12.272 FLS	9.973	198	09.91-10.92			LK 031
12.272 FS, 12.272 FLS	6.871	198	10.92-06.96			LK 031
14.152 F, 14.152 FL	4.580	114	05.94-06.96	D 0824 LF 01		LK 031
14.152 F, 14.152 FL	6.871	110-114	12.88-04.94	D 0826 F02		LK 031
14.152 FK	4.580	114	05.94-06.96	D 0824 LF 01		LK 031
14.152 FK	6.871	110-114	12.88-05.94			LK 031
14.152 FS, 14.152 FLS	4.580	114	05.94-06.96			LK 031
14.152 FS, 14.152 FLS	6.871	110-114	12.88-05.94	D 0826 F02		LK 031
14.162 F, 14.162 FL	4.580	118	08.95-06.96	D 0824 LF 02		LK 031
14.162 FK	4.580	118	08.95-06.96	D 0824 LF 02		LK 031
14.162 FS, 14.162 FLS	4.580	118	08.95-06.96			LK 031
14.192 F, 14.192 FL	6.871	140	07.90-06.96	D 0826 LF05		LK 031
14.192 F, 14.192 FL	6.596	137	08.88-06.90	D 0826 TF		LK 031
14.192 FK	6.871	140	07.90-06.96			LK 031
14.192 FK	6.596	137	08.88-06.90			LK 031
14.192 FS, 14.192 FLS	6.871	140	07.90-06.96			LK 031
14.192 FS, 14.192 FLS	6.596	137	08.88-06.90			LK 031
14.222 F, 14.222 FL	6.871	162	05.94-06.96	D 0826 LF11		LK 031



kW

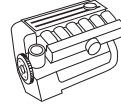

MAN						
M 90						
14.222 FK	6.871	162	05.94-06.96	D 0826 LF11	LK 031	
14.222 FLS	6.871	162	05.94-06.96		LK 031	
14.232 F,14.232 FL	6.870	160	05.90-04.95	D 0826 LF/217/Silent	LK 031	
14.232 F,14.232 FL	6.871	169	08.88-06.96	D 0826 LF06	LK 031	
14.232 FK	6.871	169	08.88-06.96		LK 031	
14.232 FS,14.232 FLS	6.870	160	05.90-04.95		LK 031	
14.232 FS,14.232 FLS	6.871	169	08.88-06.96		LK 031	
14.262 F,14.262 FL	6.871	191	08.95-06.96		LK 031	
14.262 FK	6.871	191	08.95-06.96		LK 031	
14.262 FS,14.262 FLS	6.871	191	08.95-06.96	D 0826 LF13	LK 031	
14.272 F,14.272 FL	9.973	198	09.91-10.92	D 2865 LF02	LK 031	
14.272 F,14.272 FL	6.871	198	10.92-06.96		LK 031	
14.272 FK	6.871	198	10.92-06.96	D 0826 LF04	LK 031	
14.272 FS,14.272 FLS	9.973	198	09.91-10.92		LK 031	
14.272 FS,14.272 FLS	6.871	198	12.92-06.96	D 0826 LF04	LK 031	
TGA						
18.310 FAC, FARC	11.967	228	09.02-	D 2866 LF26		LR 007
18.310 FAK, FAK-L, FALK	11.967	228	09.02-			LR 007
18.310 FAS, FARS	11.967	228	09.02-			LR 007
18.310 FC, FLC, FRC, FLLC, FLLC/N, FLLW, FLLRC, FLLRW	11.967	228	04.00-			LR 007
18.310 FK, FLK, FK-L, FLRK	11.967	228	12.00-	D 2866 LF26		LR 007
18.310 FLS, FLLS, FLLS/N, FLS-TS, FLRS, FLLRS	11.967	228	04.00-			LR 007
18.310, 18.320 FAC, FHLC	10.518	228-235	05.04-	D 2066 LF 35		LR 007
18.310, 18.320 FAK, FAK-L, FALK, FALK-L, FHLK, FHLK/M	10.518	228-235	05.04-	D 2066 LF 04		LR 007
18.310, 18.320 FAS, FALS, FHLS, FHLS/M	10.518	228-235	05.04-	D 2066 LF 04		LR 007
18.310, 18.320 FC, FLC, FLLC, FLLC/N, FLLW, FLLW/N	10.518	228-235	05.04-			LR 007
18.310, 18.320 FK, FK-L, FLK, FLK/M	10.518	228-235	05.04-		LKK 010	LR 007
18.310, 18.320 FLS, FLRS, FLLS, FLLRS	10.518	228-235	05.04-		LKK 010	LR 007
18.350 FLS, FLS/N, FLS/M, FLS-TS, FLLS, FLLS/N, FLLRS	10.518	257	05.04-		LKK 010	LR 007
18.350, 18.360 FAC, FHLC	10.518	257-265	05.04-	D 2066 LF 33		LR 007
18.350, 18.360 FAK, FAK-L, FALK, FALK-L, FHLK, FHLK/M	10.518	257-265	05.04-	D 2066 LF 33		LR 007
18.350, 18.360 FAS, FALS, FHLS, FHLS/M	10.518	257-265	05.04-		LKK 010	LR 007
18.350, 18.360 FC, FLC, FLLC, FLLRC, FLLC/N, FLLW, FLLW/N	10.518	257-265	05.04-	D 2066 LF 03		LR 007
18.350, 18.360 FK, FK-L, FLK, FLK/M,	10.518	257-265	05.04-	D 2066 LF 03		LR 007
18.360 FAC, FARC	11.967	265	09.02-	D 2866 LF27		LR 007
18.360 FAK, FALK, FAK-L, FALK-L	11.967	265	09.02-	D 2866 LF27		LR 007
18.360 FAS, FALS, FARS	11.967	265	09.02-			LR 007
18.360 FC, FLC, FRC, FLLC, FLLC/N, FLLW, FLLRW	11.967	265	04.00-	D 2866 LF37		LR 007
18.360 FK, FLK, FK-L, FLRK	11.967	265	12.00-	D 2866 LF27		LR 007
18.360 FLS, FLLS, FLLS/N, FLS-TS, FLRS, FLLRS	11.967	265	04.00-	D 2866 LF27		LR 007
18.360 FLS, FLLS, FLRS, FLLRS	10.518	265	01.06-	D 2066 LF 07		LKK 010
18.390 FLS, FLS-TS, FLS/M, FLLS, FLLS/N, FLLS/M, FLLRS	10.518	287	05.04-	D 2066 LF 02		LR 007
18.390, 18.400 FAC, FHLC	10.518	287-294	05.04-	D 2066 LF 12		LR 007
18.390, 18.400 FAK, FAK-L, FALK, FALK-L, FHLK, FHLK/M	10.518	287-294	05.04-			LR 007
18.390, 18.400 FAS, FALS, FHLS, FHLS/M	10.518	287-294	05.04-	D 2066 LF 12		LR 007
18.390, 18.400 FC, FLC, FLLC, FLLC/N, FLLW, FLLW/N	10.518	287-294	05.04-			LR 007
18.390, 18.400 FK, FK-L, FLK, FLK/M	10.518	287-294	05.04-		LKK 010	LR 007
18.400 FLS, FLLS, FLRS, FLLRS	10.518	294	10.05-		LKK 010	
18.410 FAC, FARC	11.967	301	09.02-			LR 007
18.410 FAK, FAK-L, FALK	11.967	301	09.02-			LR 007
18.410 FAS, FALS, FARS	11.967	301	09.02-	D 2866 LF28		LR 007
18.410 FC, FRC, FLC, FLRC, FLLC, FLLC/N, FLLW, FLLRC	11.967	301	12.00-			LR 007



kW

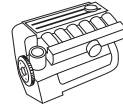

MAN

TGA

18.410 FK, FK-L, FLK, FLRK	11.967	301	04.00-			LR 007
18.410 FLS, FLLS, FLLS/N, FLS-TS, FLRS, FLLRS	11.967	301	04.00-			LR 007
18.430 FLS, FLS/M, FLS-TS, FLLS, FLLS/N, FLLRS, FLRS	10.518	316	05.04-	D 2066 LF 01	LKK 010	LR 007
18.430, 18.440 FAC, FHLC	10.518	316-324	05.04-	D 2066 LF 01	LKK 010	LR 007
18.430, 18.440 FAK, FALK, FALK-L, FHLK, FHLK/M	10.518	316-324	05.04-	D 2066 LF 11	LKK 010	LR 007
18.430, 18.440 FAS, FALS, FHLS, FHLS/M	10.518	316-324	05.04-	D 2066 LF 31	LKK 010	LR 007
18.430, 18.440 FC, FLC, FLLC, FLLW, FLLW/N, FLLRC, FLLRW	10.518	316-324	05.04-		LKK 010	LR 007
18.430, 18.440 FK, FK-L, FLK, FLK/M	10.518	316-324	05.04-	D 2066 LF 01	LKK 010	LR 007
18.440 FLS, FLLS, FLRS, FLLRS	10.518	324	09.05-	D 2066 LF 36	LKK 010	
18.460 FC, FLC, FRC, FLLC, FLLC/N, FLLW, FLLRC, FLLRW	12.816	338	04.00-			LR 007
18.460 FK, FK-L, FLK, FLRK	12.816	338	12.00-			LR 007
18.460 FLS, FLLS, FLLS/N, FLS-TS, FLRS, FLLRS	12.816	338	04.00-			LR 007
18.480 FAC, FARC	12.816	353	09.02-	D 2876 LF 12		LR 007
18.480 FAK, FAK-L, FALK	12.816	353	09.02-			LR 007
18.480 FAS, FALS, FARS	12.816	353	09.02-			LR 007
18.480 FC, FLC, FLLC, FLLW, FLLRW, FLLRC	12.816	353	09.02-			LR 007
18.480 FK, FLK, FK-L	12.816	353	09.02-	D 2876 LF 12		LR 007
18.480 FLS, FLLS, FLLS/N, FLS-TS, FLRS-WW	12.816	353	09.02-			LR 007
18.510 FC, FLC, FRC, FLLC, FLLC/N, FLLW, FLLRC, FLLRW	12.816	375	09.02-	D 2876 LF 05		LR 007
18.510 FLS, FLLS, FLLS/N, FLRS, FLLRS	12.816	375	04.00-	D 2876 LF 05		LR 007
18.530 FC, FLC, FLLC, FLLC/N, FLLW, FLLRC, FLLRW	12.816	390	09.02-			LR 007
18.530 FLS, FLLS, FLLS/N	12.816	390	09.02-	D 2876 LF 13		LR 007
19.350 FS, FRS, FLS, FLRS-WW	10.518	257	05.04-		LKK 010	
19.360 FS, FRS, FLS, FLRS-WW	10.518	265	05.04-	D 2066 LF 07	LKK 010	
19.360 FS/M-WW, FRS/M-WW	11.967	265	05.04-	D 2866 LF37		LR 007
19.390 FS, FRS, FLS, FLRS-WW	10.518	287	05.04-	D 2066 LF 02	LKK 010	
19.400 FS/M-WW, FRS/M-WW, FLS, FLRS	10.518	294	05.04-		LKK 010	
19.410 FS/M-WW, FRS/M-WW	11.967	301	05.04-	D 2866 LF32		LR 007
19.430 FS/M-WW, FLS, FRS, FLRS	10.518	316	05.04-	D 2066 LF 01	LKK 010	
19.460 FS/M-WW, FRS/M-WW	12.816	338	05.04-	D 2876 LF 07		LR 007
19.480 FS/M-WW, FRS/M-WW	12.816	353	05.04-	D 2876 LF 25		LR 007
24.350, 24.360 FNLLC, FNLLW/N, FNLLRW	10.518	257-265	05.04-		LKK 010	LR 007
24.350, 24.360 FPLS, FPLRS	10.518	257-265	02.04-	D 2066 LF 03	LKK 010	
24.390, 24.400 FNLLC/N, FNLLW/N, FNLLRC, FNLLRW	10.518	287-294	05.04-	D 2066 LF 32	LKK 010	
24.390, 24.400 FPLS, FPLRS	10.518	287-294	05.04-		LKK 010	
24.430, 24.440 FNLLC/N, FNLRC, FNLLW	10.518	316-324	05.04-		LKK 010	
24.430, 24.440 FPLS, FPLRS	10.518	316-324	05.04-	D 2066 LF 31	LKK 010	
26.310, 26.320 FDC, FDRC, FDC/M, FDRC/M, FDLC, FNHLC, FVHLC	10.518	228-235	05.04-	D 2066 LF 35	LKK 010	
26.310, 26.320 FDH, FDHC, FDHC/M	10.518	228-235	06.05-	D 2066 LF 35	LKK 010	
26.310, 26.320 FDHK	10.518	228-235	06.05-		LKK 010	
26.310, 26.320 FDHS, FDHS/M	10.518	228-235	06.05-		LKK 010	
26.310, 26.320 FDH-TM	10.518	228-235	06.05-		LKK 010	
26.310, 26.320 FDK, FDLK	10.518	228-235	05.04-	D 2066 LF 14	LKK 010	
26.310, 26.320 FDS, FDS/M, FDLS, FDRS, FDRS/M, FNHLS, FDLRS	10.518	228-235	05.04-		LKK 010	
26.310, 26.320 FD-TM	10.518	228-235	06.05-	D 2066 LF 04	LKK 010	
26.310, 26.320 FNLC, FNLLC, FNLRC, FNLLRC, FNLLW	10.518	228-235	05.04-	D 2066 LF 14	LKK 010	
26.310, 26.320 FNLS, FNLLS, FNLRS, FNLLRS	10.518	228-235	05.04-	D 2066 LF 35	LKK 010	
26.310, 26.320 FVHL-KO	10.518	228-235	06.05-	D 2066 LF 35	LKK 010	
26.310, 26.320 FVLC	10.518	228-235	02.04-	D 2066 LF 04	LKK 010	
26.310, 26.320 FVL-KO	10.518	228-235	02.04-		LKK 010	
26.350 FDHC, FDHC/M	10.518	257	04.05-		LKK 010	
26.350 FDLRC-WW	10.518	257	05.04-	D 2066 LF 03	LKK 010	
26.350 FDLS, FDLRS, FDLRS/M, FDLRS-WW	10.518	257	05.04-		LKK 010	



kW

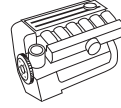

MAN						
TGA						
26.350, 26.360 FDC, FDRC, FDC/M, FDRC/M, FDLC, FDLRC, FNHLC	10.518	257-265	05.04-			LKK 010
26.350, 26.360 FDHK, FDHLK	10.518	257-265	05.04-	D 2066 LF 13		LKK 010
26.350, 26.360 FDHS, FDHS/M, FDHLS	10.518	257-265	05.04-			LKK 010
26.350, 26.360 FDH-TM	10.518	257-265	05.04-	D 2066 LF 33		LKK 010
26.350, 26.360 FDK, FDLK, FDRK	10.518	257-265	05.04-	D 2066 LF 33		LKK 010
26.350, 26.360 FDS, FDS/M, FDLS, FDRS, FNHLS, FPHLS	10.518	257-265	05.04-			LKK 010
26.350, 26.360 FD-TM	10.518	257-265	05.04-	D 2066 LF 33		LKK 010
26.350, 26.360 FNLC, FNLLC, FNLLW, FNLRC, FNLLRC	10.518	257-265	05.04-	D 2066 LF 13		LKK 010
26.350, 26.360 FNLS, FNLLS, FNLRS, FNLLRS, FPLS, FPLRS	10.518	257-265	05.04-			LKK 010
26.350, 26.360 FVHL-KO	10.518	257-265	06.05-	D 2066 LF 13		LKK 010
26.350, 26.360 FVL-KO	10.518	257-265	06.05-			LKK 010
26.360 FDLC-WW, FDLRC	10.518	265	05.04-			LKK 010
26.360 FDLS, FDLRS-WW, FNHLS	10.518	265	05.04-			LKK 010
26.390, 26.400 FDC, FDRC, FDLRC, FDRC/M, FDLC, FNHLC, FVHLC	10.518	287-294	05.04-			LKK 010
26.390, 26.400 FDHC, FDHC/M, FDHLC	10.518	287-294	06.05-			LKK 010
26.390, 26.400 FDHK, FDHLK	10.518	287-294	06.05-			LKK 010
26.390, 26.400 FDHS, FDHS/M, FDHLS	10.518	287-294	06.05-	D 2066 LF 02		LKK 010
26.390, 26.400 FDK, FDLK	10.518	287-294	05.04-	D 2066 LF 02		LKK 010
26.390, 26.400 FDS, FDS/M, FDLS, FDLRS, FNHLS, FPHLS, FVHLS	10.518	287-294	05.04-			LKK 010
26.390, 26.400 FD-TM	10.518	287-294	05.04-			LKK 010
26.390, 26.400 FNLC, FNLLC, FNLLW, FNLRC, FNLLRC	10.518	287-294	05.04-	D 2066 LF 12		LKK 010
26.390, 26.400 FNLS, FNLLS, FNLRS, FNLLRS, FPLS, FPLRS	10.518	287-294	05.04-	D 2066 LF 12		LKK 010
26.390, 26.400 FVHL-KO	10.518	287-294	06.05-			LKK 010
26.390, 26.400 FVL-KO	10.518	287-294	02.04-			LKK 010
26.430 FDLS, FDLS/M, FDLRS-WW	10.518	316-324	02.04-			LKK 010
26.430, 26.440 FDC, FDRC, FDLC, FDLRC, FDLC/M, FNHLC, FVHLC	10.518	316-324	05.04-	D 2066 LF 31		LKK 010
26.430, 26.440 FDHC, FDHC/M, FDHLC	10.518	316-324	06.05-	D 2066 LF 11		LKK 010
26.430, 26.440 FDHK, FDHLK	10.518	316-324	06.05-			LKK 010
26.430, 26.440 FDHS, FDHS/M, FDHLS	10.518	316-324	06.05-	D 2066 LF 11		LKK 010
26.430, 26.440 FDH-TM	10.518	316-324	06.05-			LKK 010
26.430, 26.440 FDS, FDLS, FDRS, FDLRS, FNHLS, FPHLS, FVHLS	10.518	316-324	02.04-			LKK 010
26.430, 26.440 FD-TM	10.518	316-324	05.04-	D 2066 LF 31		LKK 010
26.430, 26.440 FVLH-KO	10.518	316-324	06.05-	D 2066 LF 31		LKK 010
26.430, 26.440, FNLC, FNLLC, FNLLW, FNLRC, FNLLRC, FVLC	10.518	316-324	05.04-	D 2066 LF 11		LKK 010
26.430, 26.440, FNLS, FNLLS, FNLRS, FNLLRS, FPLS, FPLRS	10.518	316-324	05.04-	D 2066 LF 31		LKK 010
28.310, 28.320 FNLC, FNLLC, FNLL-LE, FNLLR-LE	10.518	228-235	07.06-	D 2066 LF 14		LKK 010
28.310, 28.320 FNLC, FNLLC, FNLLRC, FNLLR-LE	10.518	228-235	07.06-			LKK 010
28.350 FNLS, FNLRS-WW	10.518	257	02.04-			LKK 010
28.350, 28.360 FNLC, FNLLC, FNLL-LE	10.518	257-265	07.06-	D 2066 LF 13		LKK 010
28.350, 28.360 FNLC, FNLLC, FNLRC, FNLL-LE	10.518	257-265	06.04-			LKK 010
28.390 FNLS, FNLRS	10.518	287	05.04-	D 2066 LF 12		LKK 010
28.430 FNLS, FNLRS-WW	10.518	316	05.04-	D 2066 LF 01		LKK 010
28.430, 28.440 FNLC, FNLLC, FNLRC-WW	10.518	316-324	06.04-			LKK 010
32.350, 32.360 FFDRC	10.518	257-265	05.04-	D 2066 LF 03		LKK 010
32.350, 32.360 FFD-TM, FFDR-TM	10.518	257-265	02.04-			LKK 010
32.390, 32.400 FFDRC	10.518	287-294	05.04-			LKK 010
32.390, 32.400 FFD-TM, FFDR-TM	10.518	287-294	05.04-	D 2066 LF 32		LKK 010
32.430, 32.440 FFDRC	10.518	316-324	05.04-	D 2066 LF 01		LKK 010
32.430, 32.440 FFD-TM, FFDR-TM	10.518	316-324	05.04-			LKK 010
33.350, 33.360 FDAC, FDHC, FDHC/M	10.518	257-265	06.05-	D 2066 LF 33		LKK 010



kW

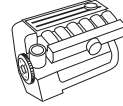

MAN

TGA

33.350, 33.360 FDAK, FDHK	10.518	257-265	06.05-		LKK 010
33.350, 33.360 FDAS, FDHS, FDHS/M	10.518	257-265	06.05-		LKK 010
33.350, 33.360 FDC, FDC/M, FDLK, FDRK	10.518	257-265	05.04-	D 2066 LF 33	LKK 010
33.350, 33.360 FDK, FDLK, FDRK	10.518	257-265	05.04-	D 2066 LF 33	LKK 010
33.350, 33.360 FDS, FDLK, FDS/M, FDRS	10.518	257-265	05.04-	D 2066 LF 03	LKK 010
33.390, 33.400 FDAC, FDHC, FDHC/M	10.518	287-295	06.05-	D 2066 LF 32	LKK 010
33.390, 33.400 FDAK, FDHK	10.518	287-295	06.05-		LKK 010
33.390, 33.400 FDAS, FDHS, FDHS/M	10.518	287-295	06.05-		LKK 010
33.390, 33.400 FDC, FDLK, FDRK, FDC/M	10.518	287-294	05.04-		LKK 010
33.390, 33.400 FDK, FDLK, FDRK	10.518	287-294	05.04-	D 2066 LF 12	LKK 010
33.390, 33.400 FDS, FDLK, FDLRS, FDRS, FDS/M	10.518	287-294	05.04-		LKK 010
33.430, 33.440 FDAC, FDALC, FDHC, FDHC/M	10.518	316-324	06.05-		LKK 010
33.430, 33.440 FDAK, FDALK, FDHK	10.518	316-324	06.05-		LKK 010
33.430, 33.440 FDAS, FDALS, FDHS	10.518	316-324	06.05-		LKK 010
33.430, 33.440 FDC, FDLK, FDRK, FDLRC, FDC/M	10.518	316-324	05.04-		LKK 010
33.430, 33.440 FDK, FDLK, FDRK	10.518	316-324	05.04-	D 2066 LF 11	LKK 010
33.430, 33.440 FDS, FDLK, FDLRS, FDRS, FDS/M	10.518	316-324	05.04-	D 2066 LF 31	LKK 010
35.310, 35.320 FFDC, FFDLC	10.518	228-235	02.04-	D 2066 LF 04	LKK 010
35.310, 35.320 FFDK, FFDLK	10.518	228-235	02.04-		LKK 010
35.310, 35.320 FFD-TM	10.518	228-235	02.04-	D 2066 LF 04	LKK 010
35.350, 35.360 FFDC, FFDRC, FFDLC	10.518	257-265	02.04-	D 2066 LF 13	LKK 010
35.350, 35.360 FFDK, FFDRC, FFDLK	10.518	257-265	02.04-		LKK 010
35.350, 35.360 FFD-TM	10.518	257-265	02.04-		LKK 010
35.390 FFDK	10.518	287	02.04-		LKK 010
35.390, 35.400 FFDC, FFDRC, FFDLC	10.518	287-294	02.04-		LKK 010
35.390, 35.400 FFDK, FFDRC, FFDLK	10.518	287-294	02.04-	D 2066 LF 02	LKK 010
35.390, 35.400 FFD-TM	10.518	287-294	02.04-	D 2066 LF 02	LKK 010
35.430, 35.440 FFDC, FFDRC, FFDLC	10.518	316-324	02.04-		LKK 010
35.430, 35.440 FFDK, FFDRC, FFDLK	10.518	316-324	02.04-	D 2066 LF 31	LKK 010
35.430, 35.440 FFD-TM	10.518	316-324	02.04-		LKK 010
37.310, 37.320 FFDC	10.518	228-235	12.04-	D 2066 LF 35	LKK 010
37.310, 37.320 FFDK	10.518	228-235	12.04-		LKK 010
37.310, 37.320 FFD-TM	10.518	228-235	12.04-		LKK 010
37.350, 37.360 FFDC	10.518	257-265	12.04-	D 2066 LF 33	LKK 010
37.350, 37.360 FFDK	10.518	257-265	12.04-	D 2066 LF 33	LKK 010
37.350, 37.360 FFD-TM	10.518	257-265	12.04-	D 2066 LF 13	LKK 010
37.390, 37.400 FFDC	10.518	287-294	12.04-	D 2066 LF 02	LKK 010
37.390, 37.400 FFDK	10.518	287-294	12.04-	D 2066 LF 12	LKK 010
37.390, 37.400 FFD-TM	10.518	287-294	12.04-		LKK 010
37.430, 37.440 FFDC	10.518	316-324	12.04-		LKK 010
37.430, 37.440 FFDK	10.518	316-324	12.04-	D 2066 LF 11	LKK 010
37.430, 37.440 FFD-TM	10.518	316-324	12.04-		LKK 010
40.390, 40.400 FDAK-WW	10.518	287-294	06.05-	D 2066 LF 02	LKK 010
40.390, 40.400 FDAS-WW	10.518	287-294	06.05-	D 2066 LF 02	LKK 010
40.390, 40.400 FDK-WW, FDRK	10.518	287-294	06.05-		LKK 010
40.390, 40.400 FDS-WW, FDRS	10.518	287-294	06.05-	D 2066 LF 02	LKK 010
40.430 FDK-WW, FDRK	10.518	316	06.05-	D 2066 LF 01	LKK 010
40.430 FDS-WW, FDRS	10.518	316	06.05-	D 2066 LF 01	LKK 010
40.430, 40.440 FDAK-WW	10.518	316-324	06.05-	D 2066 LF 01	LKK 010
40.430, 40.440 FDAS-WW	10.518	316-324	06.05-	D 2066 LF 36	LKK 010
41.350, 41.360 FFDC, FFDK/M, FFDRC	10.518	257-265	12.04-	D 2066 LF 13	LKK 010
41.350, 41.360 FFDK, FFDRC	10.518	257-265	12.04-	D 2066 LF 13	LKK 010
41.350, 41.360 FFD-TM	10.518	257-265	12.04-		LKK 010
41.390 FFDK	10.518	287	12.04-		LKK 010
41.390, 41.400 FFDC, FFDRC, FFDK/M	10.518	287-294	12.04-	D 2066 LF 02	LKK 010
41.390, 41.400 FFDK, FFDRC	10.518	287-294	12.04-		LKK 010
41.390, 41.400 FFD-TM	10.518	287-294	12.04-	D 2066 LF 12	LKK 010
41.430 FFDK	10.518	316	12.04-	D 2066 LF 11	LKK 010
41.430, 41.440 FFDC, FFDRC, FFDK/M	10.518	316-324	12.04-		LKK 010
41.430, 41.440 FFDK, FFDRC	10.518	316-324	12.04-	D 2066 LF 01	LKK 010
41.430, 41.440 FFD-TM	10.518	316-324	12.04-	D 2066 LF 11	LKK 010



kW

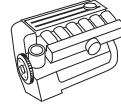

MERCEDES-BENZ

ACTROS

1831 AK	11.946	230	04.97-10.02	OM 541.941	LK 055
1831 K	11.946	230	04.97-10.02		LK 055
1831 S,1831 LS	11.946	230	04.96-10.02		LK 055
1831,1831 L	11.946	230	04.96-10.02	OM 541.920	LK 055
1835 AK	11.946	260	04.97-10.02	OM 541.927	LK 055
1835 K	11.946	260	04.97-10.02	OM 541.922	LK 055
1835 S,1835 LS	11.946	260	04.96-10.02		LK 055
1835,1835 L	11.946	260	04.96-10.02	OM 541.922	LK 055
1840 AK	11.946	290	04.97-10.02		LK 055
1840 K	11.946	290	04.97-10.02	OM 541.923	LK 055
1840 S,1840 LS	11.946	290	04.96-10.02	OM 541.923	LK 055
1840,1840 L	11.946	290	04.96-10.02		LK 055
1843 AK	11.946	315	04.97-10.02	OM 541.921	LK 055
1843 K	11.946	315	04.97-10.02		LK 055
1843 S,1843 LS	11.946	315	04.96-10.02		LK 055
1843,1843 L	11.946	315	04.96-10.02	OM 541.925	LK 055
1848 AK	11.946	350	04.97-10.02		LK 055
1848 K	11.946	350	04.97-10.02	OM 542.921	LK 055
1848 S,1848 LS	11.946	350	04.96-10.02		LK 055
1848,1848 L	11.946	350	04.96-10.02	OM 542.921	LK 055
1853 S,1853 LS	15.928	390	04.96-10.02	OM 542.920	LK 055
1853,1853 L	15.928	390	04.96-10.02		LK 055
1857 L	15.928	420	04.97-10.02		LK 055
1857 LS	15.928	420	04.97-10.02		LK 055
2031	11.946	230	04.97-10.02	OM 541.920	LK 055
2031 A	11.946	230	04.97-10.02	OM 541.926	LK 055
2031 AK	11.946	230	09.96-10.02	OM 541.926	LK 055
2031 AS	11.946	230	04.96-10.02	OM 541.926	LK 055
2031 K	11.946	230	04.97-10.02	OM 541.920	LK 055
2031 S	11.946	230	04.96-10.02		LK 055
2035 A	11.946	260	04.97-10.02	OM 541.927	LK 055
2035 S	11.946	260	04.96-10.02		LK 055
2040	11.946	290	09.96-10.02		LK 055
2040 AK	11.946	290	09.96-10.02		LK 055
2040 AS	11.946	290	04.96-10.02		LK 055
2040 S	11.946	290	04.96-10.02	OM 541.923	LK 055
2043 AS	11.946	315	04.96-10.02	OM 541.925	LK 055
2048 AS	15.928	350	04.96-10.02	OM 542.925	LK 055
2053 S	15.928	390	04.96-10.02	OM 542.920	LK 055
2531 LS	11.946	230	09.96-10.02	OM 541.920	LK 055
2531,2531 L	11.946	230	09.96-10.02		LK 055
2535 L	11.946	260	09.96-10.02	OM 541.942	LK 055
2535 LS	11.946	260	09.96-10.02	OM 541.942	LK 055
2540 LS	11.946	290	09.96-10.02	OM 541.923	LK 055
2540,2540 L	11.946	290	09.96-10.02	OM 541.944	LK 055
2543 LS	11.946	315	09.96-10.02	OM 541.946	LK 055
2543,2543 L	11.946	315	09.96-10.02	OM 541.946	LK 055
2548 LS	15.928	350	09.96-10.02	OM 542.921	LK 055
2548,2548 L	15.928	350	09.96-10.02	OM 542.921	LK 055
2553 LS	15.928	390	09.96-10.02	OM 542.920	LK 055
2553,2553 L	15.928	390	09.96-10.02	OM 542.920	LK 055
2557 L	15.928	420	09.96-10.02		LK 055
2631 B	11.946	230	04.97-10.02		LK 055
2631 K	11.946	230	04.97-10.02	OM 541.920	LK 055
2631,2631 L	11.946	230	04.96-10.02	OM 541.920	LK 055
2635 B	11.946	260	04.97-10.02	OM 541.922	LK 055
2635 K	11.946	260	04.97-10.02		LK 055
2635,2635 L	11.946	260	04.96-10.02		LK 055
2640 B	11.946	290	04.97-10.02		LK 055
2640 K,2640 LK	11.946	290	04.97-10.02		LK 055
2640 S,2640 LS	11.946	290	04.96-10.02		LK 055
2640,2640 L	11.946	290	04.96-10.02		LK 055



kW

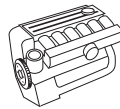

MERCEDES-BENZ

ACTROS

2643 B	11.946	315	04.97-10.02	OM 541.925	LK 055
2643 K,2643 LK	11.946	315	04.97-10.02	OM 541.925	LK 055
2643 S,2643 LS	11.946	315	04.97-10.02		LK 055
2643,2643 L	11.946	315	04.96-10.02	OM 541.925	LK 055
2648 K,2648 LK	15.928	350	04.97-10.02		LK 055
2648 S,2648 LS	15.928	350	09.96-10.02		LK 055
2648,2648 L	15.928	350	04.96-10.02	OM 542.921	LK 055
2653 K,2653 LK	15.928	390	04.97-10.02	OM 542.920	LK 055
2653 S,2653 LS	15.928	390	09.96-10.02		LK 055
2653,2653 L	15.928	390	04.96-10.02	OM 542.920	LK 055
2657 K,2657 LK	15.928	420	04.97-10.02		LK 055
2657 L	15.928	420	04.97-10.02		LK 055
2657 S	15.928	420	04.97-10.02	OM 542.922	LK 055
3231 B	11.946	230	04.97-10.02		LK 055
3231 K	11.946	230	04.97-10.02		LK 055
3235	11.946	260	04.97-10.02	OM 541.942	LK 055
3235 B	11.946	260	04.97-10.02		LK 055
3235 K	11.946	260	04.97-10.02	OM 541.922	LK 055
3240	11.946	290	04.97-10.02	OM 541.923	LK 055
3240 B	11.946	290	04.97-10.02		LK 055
3240 K	11.946	290	04.97-10.02		LK 055
3243	11.946	315	04.97-10.02		LK 055
3243 B	11.946	315	04.97-10.02	OM 541.925	LK 055
3243 K	11.946	315	04.97-10.02	OM 541.925	LK 055
3331	11.946	230	04.97-10.02	OM 541.920	LK 055
3331 A	11.946	230	04.97-10.02	OM 541.926	LK 055
3331 AK	11.946	230	04.97-10.02		LK 055
3331 AS	11.946	230	04.97-10.02		LK 055
3331 B	11.946	230	04.97-10.02		LK 055
3331 K	11.946	230	04.97-10.02		LK 055
3331 S	11.946	230	04.97-10.02		LK 055
3335	11.946	260	04.97-10.02	OM 541.922	LK 055
3335 B	11.946	260	04.97-10.02		LK 055
3335 K	11.946	260	04.97-10.02	OM 541.922	LK 055
3335 S	11.946	260	04.97-10.02		LK 055
3340	11.946	290	04.97-10.02		LK 055
3340 A	11.946	290	04.97-10.02		LK 055
3340 AK	11.946	290	04.97-10.02	OM 541.924	LK 055
3340 AS	11.946	290	04.97-10.02		LK 055
3340 B	11.946	290	04.97-10.02	OM 541.923	LK 055
3340 B	11.946	290	04.97-10.02	OM 541.923	LK 055
3340 K	11.946	290	04.97-10.02		LK 055
3340 S	11.946	290	04.97-10.02	OM 541.923	LK 055
3343	11.946	315	04.97-10.02		LK 055
3343 AK	11.946	315	04.97-10.02		LK 055
3343 AS	11.946	315	04.97-10.02	OM 541.921	LK 055
3343 B	11.946	315	04.97-10.02	OM 541.925	LK 055
3343 K	11.946	315	04.97-10.02		LK 055
3343 S	11.946	315	04.97-10.02		LK 055
3348	15.928	350	04.97-10.02		LK 055
3348 AK	15.928	350	04.97-10.02		LK 055
3348 AS	15.928	350	04.97-10.02		LK 055
3348 K	15.928	350	04.97-10.02		LK 055
3348 S	15.928	350	04.97-10.02		LK 055
3353	15.928	390	04.97-10.02		LK 055
3353 AS	15.928	390	04.97-10.02		LK 055
3353 S	15.928	390	04.97-10.02		LK 055
3357	15.928	420	04.97-10.02	OM 542.922	LK 055
3357 S	15.928	420	04.97-10.02	OM 542.922	LK 055
4140 AK	11.946	290	04.97-10.02	OM 541.924	LK 055
4140 B	11.946	290	04.97-10.02	OM 541.923	LK 055
4140 K	11.946	290	04.97-10.02	OM 541.923	LK 055



kW

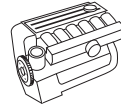

MERCEDES-BENZ

ACTROS

4140 K	11.946	290	04.97-10.02	OM 541.924	LK 055	
4143 AK	11.946	315	04.97-10.02	OM 541.921	LK 055	
4143 K	11.946	315	04.97-10.02		LK 055	
4143 K	11.946	315	04.97-10.02	OM 541.921	LK 055	
4148 AK	15.928	350	04.97-10.02		LK 055	
4148 K	15.928	350	04.97-10.02	OM 542.921	LK 055	
4148 K	15.928	350	04.97-10.02	OM 542.925	LK 055	

ACTROS MP2 / MP3

1832 AK	11.946	235	04.03-	OM 541.940	LK 055	
1832 K	11.946	235	04.03-		LK 055	
1832 LS, LLS	11.946	235	04.03-	OM 541.970	LK 055	
1832, L, LL	11.946	235	04.03-	OM 541.940	LK 055	
1836 AK	11.946	265	04.03-		LK 055	
1836 K	11.946	265	04.03-		LK 055	
1836 LS, LLS	11.946	265	04.03-		LK 055	
1836, L, LL	11.946	265	04.03-	OM 541.942	LK 055	
1841 K	11.946	300	04.03-	OM 541.944	LK 055	
1841 L, LL	11.946	300	04.03-	OM 541.944	LK 055	
1841 LS, LLS	11.946	300	04.03-	OM 541.944	LK 055	
1841, L, LL	11.946	300	04.03-	OM 541.974	LK 055	
1844 AK	11.946	315-320	04.03-	OM 541.946	LK 055	
1844 K	11.946	320	04.03-	OM 541.946	LK 055	
1844 LS, LLS	11.946	320	04.03-	OM 541.946	LK 055	
1844, L, LL	11.946	320	04.03-	OM 541.946	LK 055	
1848 K	11.946	350	04.03-	OM 541.978		LR 010
1848, L, LL	11.946	350	04.03-	OM 541.978		LR 010
1848, LS, LLS	11.946	350	04.03-	OM 541.978		LR 010
1850, 1851 AK	15.928	370-375	04.03-	OM 542.960	LK 055	LR 010
1850, 1851 K	15.928	370-375	04.03-	OM 542.960	LK 055	LR 010
1850, 1851 LS, LLS	15.928	370-375	04.03-	OM 542.940	LK 055	LR 010
1850, 1851, L, LL	15.928	370-375	04.03-	OM 542.940	LK 055	LR 010
1854 LS	15.928	395	04.03-		LK 055	
1854, L	15.928	395-405	04.03-	OM 542.962	LK 055	
2032	11.946	230	04.03-		LK 055	
2032 A, AE	11.946	230	04.03-	OM 541.941	LK 055	
2032 AK	11.946	230	04.03-	OM 541.940	LK 055	
2032 AS	11.946	230	04.03-	OM 541.926	LK 055	
2032 K	11.946	230	04.03-	OM 541.940	LK 055	
2032 S	11.946	230	04.03-	OM 541.920	LK 055	
2036	11.946	260	04.03-	OM 541.942	LK 055	
2036 A, AE	11.946	260	04.03-	OM 541.942	LK 055	
2036 AK	11.946	260	04.03-	OM 541.927	LK 055	
2036 AS	11.946	257-265	04.03-	OM 541.927	LK 055	
2036 S	11.946	257-265	04.03-	OM 541.942	LK 055	
2041	11.946	290-300	04.03-	OM 541.944	LK 055	
2041 AK	11.946	290-300	04.03-		LK 055	
2041 AS	11.946	290-300	04.03-	OM 541.924	LK 055	
2041 K	11.946	290-300	04.03-	OM 541.944	LK 055	
2041 S	11.946	290-300	04.03-	OM 541.923	LK 055	
2041 S	11.946	290-300	04.03-	OM 541.944	LK 055	
2044	11.946	315-320	04.03-	OM 541.946	LK 055	
2044 AK	11.946	315-320	04.03-		LK 055	
2044 AS	11.946	315-320	04.03-		LK 055	
2044 S	11.946	315-320	04.03-	OM 541.925	LK 055	
2044 S	11.946	315-320	04.03-	OM 541.946	LK 055	
2046	11.946	335	04.03-	OM 541.980	LK 086	
2046 S	11.946	335	04.03-	OM 541.980	LK 086	
2050 S	15.928	370	04.03-	OM 542.940/ 941	LK 055	
2050 S	15.928	370	04.03-	OM 542.940	LK 055	
2051 AS	15.928	375	04.03-	OM 542.940	LK 055	
2532 LS	11.946	235	04.03-		LK 055	
2532, L, LL	11.946	228-235	04.03-		LK 055	



kW

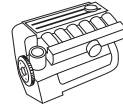

**MERCEDES-BENZ
ACTROS MP2 / MP3**

2536 LS	11.946	257-265	04.03-		LK 055	
2536, L, LL	11.946	257-265	04.03-	OM 541.943	LK 055	
2541 LS	11.946	290	04.03-	OM 541.944	LK 055	
2541, L, LL	11.946	290-300	04.03-	OM 541.944	LK 055	
2544 LS	11.946	315-320	04.03-	OM 541.946	LK 055	
2544, L, LL	11.946	315-320	04.03-	OM 541.946	LK 055	
2546 LS	11.946	335	04.03-	OM 541.980	LK 086	
2548 LS	11.946	350	04.03-	OM 541.978		LR 010
2551 LS	15.928	375	04.03-			LR 010
2632 B	11.946	235	04.03-	OM 541.970	LK 055	
2632 K, LK	11.946	235	04.03-	OM 541.970	LK 055	
2632 LS	11.946	235	04.03-		LK 055	
2632, L, LL	11.946	235	04.03-	OM 541.940	LK 055	
2636 B	11.946	265	04.03-	OM 541.942	LK 055	
2636 K, LK	11.946	265	04.03-		LK 055	
2636 LS	11.946	265	04.03-	OM 541.942	LK 055	
2636, L, LL	11.946	265	04.03-		LK 055	
2641 B	11.946	300	04.03-	OM 541.944	LK 055	
2641 K, LK	11.946	300	04.03-	OM 541.944	LK 055	
2641 S, LS	11.946	300	04.03-		LK 055	
2641, L, LL	11.946	300	04.03-	OM 541.944	LK 055	
2644 B	11.946	320	04.03-	OM 541.946	LK 055	
2644 K, LK	11.946	320	04.03-	OM 541.946	LK 055	
2644 S, LS	11.946	320	04.03-		LK 055	
2644, L, LL	11.946	320	04.03-	OM 541.946	LK 055	
2646 B	11.946	335	04.03-	OM 541.980	LK 086	
2646 K, LK	11.946	335	04.03-	OM 541.980	LK 086	
2646, L, LL	11.946	335	04.03-	OM 541.980	LK 086	
2648 B	11.946	355	04.03-	OM 541.978		LR 010
2648 K, LK	11.946	355	04.03-	OM 541.978		LR 010
2650 K, 2651 K, LK	15.928	370-375	04.03-	OM 542.940	LK 055	LR 010
2650 S, LS	15.928	370	04.03-	OM 542.940	LK 055	
2650, L, 2651, L, LL	15.928	370-375	04.03-	OM 542.940	LK 055	
2654 K, LK, 2655 K, LK	15.928	395-405	04.03-	OM 542.942	LK 055	
2654 S, LS	15.928	395	04.03-	OM 542.942	LK 055	
2654, L, 2655, L, LL	15.928	395-405	04.03-	OM 542.942	LK 055	
3231 K, 3232 K	11.946	228-235	04.03-		LK 055	
3241	11.946	300	04.03-		LK 055	
3331 A, 3332 A	11.946	228-235	04.03-	OM 541.920	LK 055	
3331 A, 3332 A	11.946	228-235	04.03-	OM 541.941	LK 055	
3331 A, 3332 A	11.946	228-235	04.03-	OM 541.940	LK 055	
3331 AK, 3332 AK	11.946	228-235	04.03-	OM 541.920	LK 055	
3331 S, 3332 S	11.946	228-235	04.03-	OM 541.970	LK 055	
3331, 3332	11.946	228-235	04.03-		LK 055	
3332 AK	11.946	235	04.03-		LK 055	
3332 AS	11.946	235	04.03-	OM 541.941	LK 055	
3332 B	11.946	235	04.03-	OM 541.970	LK 086	
3336	11.946	265	04.03-	OM 541.942	LK 055	
3336 A	11.946	265	04.03-	OM 541.942	LK 055	
3336 A	11.946	265	04.03-	OM 541.943	LK 055	
3336 AS	11.946	265	04.03-	OM 541.943	LK 055	
3336 B	11.946	360	04.03-	OM 541.972	LK 086	
3336 K	11.946	257-265	04.03-	OM 541.942	LK 055	
3336 S	11.946	265	04.03-	OM 541.942	LK 055	
3341	11.946	300	04.03-	OM 541.944	LK 055	
3341 AK	11.946	300	04.03-	OM 541.945	LK 055	
3341 AS	11.946	300	04.03-	OM 541.944	LK 055	
3341 AS	11.946	300	04.03-	OM 541.945	LK 055	
3341 B	11.946	300	04.03-	OM 541.974	LK 086	
3341 S	11.946	300	04.03-	OM 541.944	LK 055	
3341 S	11.946	300	04.03-	OM 541.923	LK 055	
3344	11.946	315-320	04.03-	OM 541.947	LK 055	

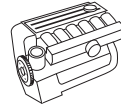

kW

MERCEDES-BENZ
ACTROS MP2 / MP3

3344 A	11.946	315-320	04.03-	OM 541.947	LK 055	
3344 A	11.946	315-320	04.03-	OM 541.946	LK 055	
3344 A	11.946	315-320	04.03-	OM 541.921	LK 055	
3344 B	11.946	320	04.03-	OM 541.976	LK 086	
3344 S	11.946	320	04.03-	OM 541.946	LK 055	
3346 B	11.946	335	04.03-	OM 541.980	LK 086	
3348	15.928	350	04.03-	OM 542.921	LK 055	
3348 S	15.928	350	04.03-		LK 055	
3350, 3351	15.928	370-375	04.03-	OM 542.960	LK 055	
3351 AK	15.928	370-375	04.03-	OM 542.941	LK 055	
3351 S	15.928	375	04.03-	OM 542.940	LK 055	
3354, 3355	15.928	395-405	04.03-	OM 542.942	LK 055	
4140 K	11.946	290-300	04.03-	OM 541.923	LK 055	
4140 K	11.946	290-300	04.03-	OM 541.944	LK 055	
4151 K	15.928	375	05.05-			LR 010

ATEGO

1017 A	4.250	125	01.98-10.04	OM 904.911	LK 065	LR 009
1017 AK	4.250	125	01.98-10.04		LK 065	LR 009
1017 K	4.249	125	01.98-10.04	OM 904.911	LK 065	LR 009
1017 KO, 1018 KO	4.249	125-130	01.98-10.04	OM 904.917	LK 065	LR 009
1017,1017 L	4.250	125	01.98-10.04		LK 065	LR 009
1214, 1214 L	4.249	100	01.98-10.04	OM 904.916	LK 065	LR 009
1215 K	4.250	112	01.98-10.04		LK 065	LR 009
1215,1215 L	4.250	112	01.98-10.04		LK 065	LR 009
1217 K	4.250	125	01.98-10.04		LK 065	LR 009
1217 KO	4.250	125	01.98-10.04		LK 065	LR 009
1217,1217 L	4.250	125	01.98-10.04		LK 065	LR 009
1317 A	4.250	125	01.98-10.04		LK 065	LR 009
1317 AK	4.250	125	01.98-10.04	OM 904.911	LK 065	LR 009
1317 K	4.250	125	01.98-10.04		LK 065	LR 009
1317 KO, 1317 LKO, 1318 KO, 1318 LKO	4.249	125-130	01.98-10.04	OM 900.913	LK 065	LR 009
1317,1317 L	4.250	125	01.98-10.04		LK 065	LR 009
1328 AF	6.370	205	01.98-10.04	OM 906.911		LR 012
1328 F	6.370	205	01.98-10.04			LR 012
1328 LS	6.370	205	01.98-10.04			LR 012
1517 A	4.250	125	01.98-10.04	OM 904.911	LK 065	LR 009
1517 K	4.250	125	01.98-10.04		LK 065	LR 009
1517,1517 L	4.250	125	01.98-10.04		LK 065	LR 009
1528 AF	6.370	205	01.98-10.04	OM 906.911		LR 012
1528 F	6.370	205	01.98-10.04	OM 906.911	LK 065	LR 012
712	4.250	90	01.98-10.04		LK 065	LR 009
714 K	4.249	100	01.98-10.04	OM 904.910	LK 065	LR 009
714, 714L	4.249	100	01.98-10.04	OM 904.916	LK 065	LR 009
715,715 L	4.250	112	01.98-10.04		LK 065	LR 009
717 K	4.249	125	01.98-10.04	OM 904.917	LK 065	LR 009
717, 717L	4.249	125	01.98-10.04	OM 904.911	LK 065	LR 009
812	4.250	90	01.98-10.04		LK 065	LR 009
814 K	4.249	100	01.98-10.04	OM 904.910	LK 065	LR 009
814, 814 L	4.249	100	01.98-10.04	OM 904.910	LK 065	LR 009
815 F	4.250	112	01.98-10.04	OM 904.922	LK 065	LR 009
815 K	4.250	112	01.98-10.04			LR 009
815,815 L	4.250	112	01.98-10.04		LK 065	LR 009
817 K	4.250	125	01.98-10.04		LK 065	LR 009
817,817 L	4.250	125	01.98-10.04		LK 065	LR 009
917 AF	4.250	125	01.98-10.04		LK 065	LR 009
917 K	4.250	125	01.98-10.04		LK 065	LR 009
917 KO	4.249	125	01.98-10.04	OM 904.911	LK 065	LR 009
917,917 L	4.250	125	01.98-10.04		LK 065	LR 009

ATEGO 2

1016 K	4.249	115	10.04-	OM 900.912	LK 065	
1016, 1016 L	4.249	115	10.04-	OM 900.912	LK 065	
1018 A	4.249	130	10.04-	OM 900.913	LK 065	



kW

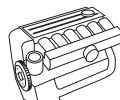

MERCEDES-BENZ

ATEGO 2						
1018 K	4.249	130	10.04-	OM 900.913	LK 065	
1018, 1018 L	4.249	130	10.04-	OM 900.913	LK 065	
1022 K	4.801	160	10.04-	OM 924.920	LK 066	LR 012
1022, 1022 L	4.801	160	10.04-		LK 066	LR 012
1215, 1215 L, 1216, 1216 L	4.249	112-115	10.04-	OM 900.912	LK 065	LR 009
1216 K	4.249	115	10.04-	OM 900.912	LK 065	
1218 K	4.249	130	10.04-	OM 900.913	LK 065	
1218, 1218 L	4.249	130	10.04-		LK 065	
1222 K	4.801	160	10.04-	OM 924.920	LK 066	LR 012
1222, 1222 L	4.801	160	10.04-		LK 066	LR 012
1318 A	4.249	130	10.04-	OM 900.913	LK 065	
1318 AK	4.249	130	10.04-		LK 065	
1318 K	4.249	130	10.04-	OM 900.913	LK 065	
1318, 1318 L	4.249	130	10.04-		LK 065	
1322 K	4.801	160	10.04-		LK 066	LR 012
1322 LS	4.801	160	10.04-	OM 924.920	LK 066	LR 012
1322, 1322 L	4.801	160	10.04-	OM 924.920	LK 066	LR 012
1518 A	4.249	130	10.04-	OM 900.913	LK 065	
1518 K	4.249	130	10.04-		LK 065	
1518, 1518 L	4.249	130	10.04-		LK 065	
1522 K	4.801	160	10.04-			LR 012
1522, 1522 L	4.801	160	10.04-		LK 066	LR 012
712, 713	4.249	90-95	10.04-	OM 904.915	LK 065	LR 009
712, 713	4.249	90-95	10.04-	OM 904.909	LK 065	LR 009
712, 713	4.249	90-95	10.04-	OM 900.911	LK 065	LR 009
715, 715 L, 716, 716 L	4.249	112-115	10.04-	OM 904.922	LK 065	LR 009
715, 715 L, 716, 716 L	4.249	112-115	10.04-	OM 900.912	LK 065	LR 009
812, 813	4.249	90-95	10.04-	OM 900.911	LK 065	LR 009
812, 813	4.249	90-95	10.04-	OM 904.909	LK 065	LR 009
815 K, 816 K	4.249	112-115	10.04-	OM 904.922	LK 065	LR 009
815 K, 816 K	4.249	112-115	10.04-	OM 900.912	LK 065	LR 009
815, 815 L, 816, 816 L	4.249	112-115	10.04-	OM 904.922	LK 065	LR 009
815, 815 L, 816, 816 L	4.249	112-115	10.04-	OM 900.912	LK 065	LR 009
818 K	4.249	130	10.04-	OM 900.913	LK 065	
818, 818 L	4.249	130	10.04-	OM 900.913	LK 065	
822 K	4.801	160	10.04-	OM 924.920	LK 066	LR 012
822, 822 L	4.801	160	10.04-	OM 924.920	LK 066	LR 012
915, 915 L, 916, 916 L	4.249	112-115	10.04-	OM 904.922	LK 065	LR 009
915, 915 L, 916, 916 L	4.249	112-115	10.04-	OM 900.912	LK 065	LR 009
916 K	4.249	115	10.04-	OM 900.912	LK 065	
922 K	4.801	160	10.04-		LK 066	LR 012
922, 922 L	4.801	160	10.04-		LK 066	LR 012
CITARO (O 530)						
Citaro G	6.374	205	01.99-	OM 909.901		LR 024
Citaro G	6.374	205	01.99-	OM 909.921	LK 066	LR 012
Citaro G	6.374	205	01.99-	OM 906.930	LK 066	LR 012
Citaro G	6.374	205	01.99-	OM 906.960	LK 066	LR 012
Citaro L	6.374	205	01.99-	OM 906.930	LK 066	LR 012
Citaro L	6.374	205	01.99-	OM 906.960		LR 024
Citaro L	6.374	205	01.99-	OM 906.960	LK 066	LR 012
Citaro L	6.374	205	01.99-	OM 909.921	LK 066	
Citaro N	6.374	180	04.99-	OM 906.963	LK 066	
Citaro N	6.374	205	01.98-	OM 906.930	LK 066	
Citaro N	6.374	205	01.98-	OM 906.960	LK 066	LR 012
Citaro N	6.374	205	01.98-	OM 909.921	LK 066	LR 024
CONECTO (O 345)						
CONECTO C, H, UE	6.374	205	11.01-	OM 906.960		LR 012
CONECTO C, H, UE	6.374	205	11.01-	OM 906.960		LR 024
CONECTO C, H, UE	6.374	205	11.01-	OM 906.960	LK 066	
LK/LN2						
1117 AK	5.958	125	04.84-12.98	OM 357.906		LR 023
1117 K	4.249	125	03.96-12.98		LK 095	LR 023



kW

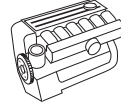

MERCEDES-BENZ

LK/LN2

1117 K	5.958	116-125	04.84-12.98	OM 357.901		LR 023
1117 K	5.958	116-125	04.84-12.98	OM 366.953		LR 023
1117 LO	4.249	125	03.96-12.98	OM 904.907	LK 095	LR 023
1117 O,1117 LO	5.958	116-125	01.84-12.98	OM 357.919		LR 023
1117 S	4.249	125	03.96-12.98		LK 095	LR 023
1117 S,1117 LS	5.958	116-125	01.84-12.98	OM 357.918		LR 023
1117 S,1117 LS	5.958	116-125	01.84-12.98	OM 357.901		LR 023
1117,1117 L	5.958	116-125	01.84-12.98	OM 357.901		LR 023
1117,1117 L	5.958	116-125	01.84-12.98	OM 357.918		LR 023
1117,1117 L	4.249	125	03.96-12.98		LK 095	LR 023
1120 O,1120 LO	5.958	150-155	01.84-12.98	OM 357.929		LR 023
1120 O,1120 LO	5.958	150-155	01.84-12.98	OM 356.993		LR 023
1120,1120 L	5.958	150-155	01.84-12.98	OM 357.927		LR 023
1120,1120 L	5.958	150-155	01.84-12.98	OM 357.932		LR 023
1317 AK	5.958	116-125	08.84-12.98	OM 366.944		LR 023
1317 AK	5.958	116-125	08.84-12.98	OM 357.907		LR 023
1317 AK	5.958	155	12.92-12.98	OM 356.995 Motor Nr. 235 863 →		LR 023
1317 K	4.249	125	03.96-12.98		LK 095	LR 023
1317 KO	5.958	116-125	03.94-12.98	OM 357.962		LR 023
1317 KO	4.249	125	03.96-12.98		LK 095	LR 023
1317 LS	4.249	125	03.96-12.98	OM 904.907		LK 095 LR 023
1317,1317 L	4.249	125	03.96-12.98	OM 904.907		LK 095 LR 023
1320 AK	5.958	155	12.92-12.98	OM 356.995 Motor Nr. 235 863 →		LR 023
1320 S,1320 LS	5.958	150-155	01.84-12.98	OM 357.932		LR 023
1320,1320 L	5.958	150-155	01.84-12.98	OM 357.932		LR 023
1320,1320 L	5.958	150-155	01.84-12.98	OM 366.980		LR 023
1517 K	4.249	125	03.96-12.98		LK 095	LR 023
1517,1517 L	5.958	116-125	01.84-12.98	OM 357.962		LR 023
1517,1517 L	5.958	116-125	01.84-12.98	OM 356.953		LR 023
1517,1517 L	4.249	125	03.96-12.98	OM 904.907		LK 095 LR 023
1520,1520 L	5.958	150-155	01.84-12.98	OM 356.990		LR 023
1520,1520 L	5.958	150-155	01.84-12.98	OM 357.922		LR 023
711	4.249	90	03.96-12.98	OM 904.905		LK 095 LR 023
811	4.249	90	03.96-12.98	OM 904.905		LK 095 LR 023
811 K	4.249	90	03.96-12.98	OM 904.905		LK 095 LR 023
814 F	4.249	100	03.96-12.98			LK 095 LR 023
814 K	4.249	100	03.96-12.98			LK 095 LR 023
814 LO	4.249	100	03.96-12.98	OM 904.906		LK 095 LR 023
814 S	4.249	100	03.96-12.98	OM 904.906		LK 095 LR 023
814,814L	4.249	100	03.96-12.98	OM 904.906		LK 095 LR 023
817 F	5.958	116-125	03.84-12.98	OM 357.908		LR 023
817 F	5.958	116-125	03.84-12.98	OM 366.967		LR 023
817 F	4.249	125	03.96-12.98		LK 095	LR 023
817 K	5.958	116-125	01.86-12.98	OM 357.900		LR 023
817 K	4.249	125	03.96-12.98		LK 095	LR 023
817 LO	4.249	125	03.96-12.98	OM 904.907		LK 095 LR 023
817 O, 817 LO	5.958	116-125	01.84-12.98	OM 366.969		
817 S,817 LS	5.958	116-125	01.84-12.98	OM 366.942		LR 023
817 S,817 LS	4.249	125	03.96-12.98		LK 095	LR 023
817,817 L	5.958	116-125	01.84-12.98	OM 357.900		LR 023
817,817 L	5.958	116-125	01.84-12.98	OM 366.968		LR 023
817,817 L	4.249	125	03.96-12.98	OM 904.907		LK 095 LR 023
917	4.249	125	03.96-12.98	OM 904.907		LK 095 LR 023
917	5.958	125	03.94-12.98			LR 023
917 AF	5.958	116-125	02.87-12.98	OM 366.974		LR 023
917 AF	5.958	116-125	02.87-12.98	OM 357.909		LR 023
917 AK	5.958	125	03.94-12.98	OM 357.906		LR 023
917 K	5.958	125	03.94-12.98	OM 357.900		LR 023
917 K	4.249	125	03.96-12.98	OM 904.907		LK 095 LR 023
917 KO	5.958	125	03.94-12.98	OM 357.901		LR 023
917 KO	4.249	125	03.96-12.98	OM 904.907		LK 095 LR 023



kW



MERCEDES-BENZ

MK					
1226 AF	10.964	250	02.93-09.96		LK 055
1234 AF	10.964	250	01.92-09.96	OM 441.989	LK 055
1420,1420 L	5.958	155	12.87-09.96	OM 356.984 Motor Nr. 235 863 →	LR 023
1420 LS	5.958	155	02.90-09.96	OM 356.984 Motor Nr. 235 863 →	LR 023
1720 S	5.958	155	02.90-08.94		LR 023
1720,1720 L	5.958	150-155	12.87-09.96	OM 356.984 Motor Nr. 235 863 →	LR 023
1820 K	5.958	155	05.92-09.96	OM 357.925	LR 023
1820,1820 L	5.958	155	12.87-09.96	OM 357.925 Motor Nr. 235 863 →	LR 023
1834 S,1834 LS	10.964	250	12.87-09.96	OM 445.920	LK 055
1834,1834 L	10.964	250	12.87-09.96	OM 445.921	LK 055
2420,2420 L	5.958	150-155	12.87-09.96	OM 356.984 Motor Nr. 235 863 →	LR 023
2534 K	10.964	250	01.91-09.96	OM 441.986	LK 055
2534 S,2534 LS	10.964	250	12.87-09.96	OM 445.920	LK 055
2534,2534 L	10.964	250	12.87-09.96	OM 441.987	LK 055
SK					
1735 K	14.618	250-269	07.88-08.94	OM 442.964	LK 055
1831 K	10.964	230-250	07.92-09.96	OM 445.929	LK 055
1834 S,1834 LS	10.964	250	07.87-09.96		LK 055
1834,1834 L	10.964	250	07.87-09.96	OM 441.996	LK 055
1838 AK	14.618	280	01.94-09.96	OM 446.927	LK 055
1838 AK	12.763	280	12.92-09.96	OM 402.996	LK 055
1838 AK	14.618	320	12.92-09.96		LK 055
1838 AK	14.618	370	12.92-09.96		LK 055
1838 K	14.618	280	06.95-09.96	OM 446.924	LK 055
1838 K	12.763	280	12.90-09.96		LK 055
1838 S,1838 LS	12.763	280	07.87-09.96	OM 402.971	LK 055
1838 S,1838 LS	14.618	280	07.87-09.96	OM 446.925	LK 055
1838 S,1838 LS	14.618	320	07.87-09.96	OM 446.943	LK 055
1838,1838 L	12.763	280	07.87-09.96	OM 402.986	LK 055
1838,1838 L	14.618	280	07.87-09.96	OM 446.925	LK 055
1838,1838 L	14.618	320	07.87-09.96	OM 440.978	LK 055
1844 S,1844 LS	14.618	320	07.87-09.96	OM 440.970	LK 055
1844,1844 L	14.618	320	07.87-09.96	OM 446.922	LK 055
1850 LAS	14.618	362-370	07.87-09.96		LK 055
1850 S,1850 LS	14.618	362-370	07.87-09.96	OM 442.989	LK 055
1850,1850 L	14.618	362-370	07.87-09.96	OM 442.985	LK 055
1853 AK	14.618	390	01.96-09.96	OM 446.946	LK 055
1853 S,1853 LS	14.618	390	07.87-09.96	OM 446.920	LK 055
1853,1853 L	14.618	390	07.87-09.96		LK 055
1935 AK	14.620	250-269	05.89-08.94	OM 442.966	LK 055
1935 AS	14.620	250-269	05.89-08.94	OM 442.978	LK 055
1935 K	14.620	250-269	05.89-08.94	OM 442.944	LK 055
2031 A	14.618	280	01.94-09.96		LK 055
2031 A	12.763	280	03.92-09.96	OM 402.996	LK 055
2031 A	12.763	320	03.92-09.96	OM 440.979	LK 055
2038	12.763	280	11.91-09.96	OM 402.971	LK 055
2038	14.618	280	12.92-	OM 446.925	LK 055
2038 AS	14.618	280	01.94-09.96		LK 055
2038 AS	12.763	280	12.92-09.96	OM 402.978	LK 055
2038 AS	14.618	320	12.92-09.96		LK 055
2038 S	12.763	280	11.91-09.96	OM 402.985	LK 055
2044	14.618	320	01.92-09.96	OM 440.970	LK 055
2044 S	14.618	320	01.92-09.96	OM 440.970	LK 055
2050	14.618	362-390	01.91-09.96		LK 055
2050 S	14.618	362-390	01.91-09.96	OM 442.985	LK 055
2435 K	14.618	250-269	07.88-08.94	OM 442.943	LK 055
2435 S	14.618	250-269	07.88-08.94	OM 442.965	LK 055
2538	14.618	280	01.94-09.96	OM 446.924	LK 055
2538	12.763	280	03.91-09.96		LK 055
2538	14.618	370	03.91-09.96		LK 055
2538	14.618	320	03.91-09.96		LK 055
2538	14.618	370	03.91-09.96		LK 055



kW

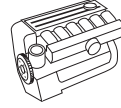

MERCEDES-BENZ

SK						
2538 K, 2538 LK	14.618	280	01.94-09.96	OM 446.924		LK 055
2538 K, 2538 LK	12.763	280	03.91-09.96	OM 402.971		LK 055
2538 K, 2538 LK	14.618	320	03.91-09.96			LK 055
2538 K, 2538 LK	14.618	362-370	03.91-09.96			LK 055
2538 S	14.618	370	03.91-09.96	OM 440.981		LK 055
2538 S,2538 LS	12.763	280	07.87-09.96	OM 402.975		LK 055
2538 S,2538 LS	14.618	280	07.87-09.96	OM 446.925		LK 055
2538 S,2538 LS	14.618	320	07.87-09.96	OM 440.978		LK 055
2538,2538 L	12.763	280	07.87-09.96	OM 402.986		LK 055
2538,2538 L	14.618	280	07.87-09.96	OM 446.924		LK 055
2538,2538 L	14.618	320	07.87-09.96	OM 440.970		LK 055
2544 S, LS	14.618	320	01.92-09.96	OM 440.970		LK 055
2544, 2544 L	14.618	320	01.92-09.96			LK 055
2544,2544 L	14.618	320	07.87-09.96			LK 055
2550	14.618	362-390	01.91-09.96			LK 055
2550 S, 2550 LS	14.618	362-390	01.91-09.96	OM 446.920		LK 055
2550,2550 L	14.618	362-390	07.87-09.96	OM 440.973		LK 055
2553 S, 2553 LS	14.618	390	01.96-09.96	OM 446.920		LK 055
2553,2553 L	14.618	390	07.88-09.96	OM 446.920		LK 055
2629 A	12.763	280	07.88-08.94			LK 055
2629 A	14.618	320	07.88-08.94			LK 055
2629 A	14.618	362-370	07.88-08.94			LK 055
2629 AK	14.618	320	07.88-08.94			LK 055
2629 AK	14.618	362-370	07.88-08.94			LK 055
2629 AS	14.618	362-370	07.88-08.94	OM 442.989		LK 055
2631	10.964	230-250	06.92-09.96	OM 445.930		LK 055
2631 S	10.964	230	06.92-09.96	OM 445.931		LK 055
2634	10.964	250	06.92-09.96	OM 445.920		LK 055
2635	14.618	370	01.91-08.94			LK 055
2635 A	14.618	320	12.91-08.94	OM 440.970		LK 055
2635 AK	14.618	250-269	02.90-08.94	OM 442.966		LK 055
2635 AK	14.618	362-370	02.90-08.94			LK 055
2635 AS	14.618	250-269	07.88-08.94	OM 440.942		LK 055
2635 K	14.618	250-269	07.88-08.94	OM 440.940		LK 055
2635 K	14.618	362-370	07.88-08.94			LK 055
2635 K	14.618	320	07.91-08.94			LK 055
2635 S	14.618	250-269	09.91-09.96	OM 442.966		LK 055
2635 S	14.618	362-370	09.91-09.96			LK 055
2638 A, LA	12.763	280	07.92-09.96	OM 402.975		LK 055
2638 A, LA	14.618	280	09.91-09.96	OM 446.927		LK 055
2638 A, LA	14.618	320	01.94-09.96	OM 440.970		LK 055
2638 AK	14.618	280	01.94-09.96			LK 055
2638 AK	12.763	280	07.92-09.96	OM 402.975		LK 055
2638 AK	14.618	320	07.92-09.96			LK 055
2638 AK	14.618	370	09.91-09.96	OM 442.997		LK 055
2638 AS	14.618	280	01.94-09.96			LK 055
2638 AS	12.763	280	07.92-09.96	OM 402.996		LK 055
2638 AS	14.618	320	07.92-09.96	OM 446.936		LK 055
2638 AS	14.618	370	07.92-09.96			LK 055
2638 K	12.763	280	09.91-09.96	OM 402.972		LK 055
2638 K	14.618	280	09.91-09.96	OM 446.926		LK 055
2638 K	14.618	320	09.91-09.96			LK 055
2638 K	14.618	370	09.91-09.96	OM 440.981		LK 055
2638 S	14.618	320	09.91-09.96			LK 055
2638 S	14.618	370	09.91-09.96	OM 440.981		LK 055
2638, 2638 L	12.763	280	09.91-09.96			LK 055
2638, 2638 L	14.618	280	09.91-09.96	OM 446.924		LK 055
2638, 2638 L	14.618	320	09.91-09.96	OM 440.978		LK 055
2638, 2638 L	14.618	370	09.91-09.96			LK 055
2644 A	14.618	320	01.92-09.96	OM 440.970		LK 055
2644 S	14.618	320	01.92-09.96			LK 055
2644, 2644 L	14.618	320	01.92-09.96	OM 440.970		LK 055



kW

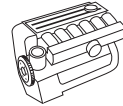

MERCEDES-BENZ

SK

2650 S	14.618	370	07.92-09.96	OM 440.973	LK 055
2650, 2650 L	14.618	362-370	07.92-09.96	OM 442.989	LK 055
3050	14.618	390	01.94-09.96	OM 446.933	LK 055
3053 S	14.618	370	12.93-09.96	OM 440.976	LK 055
3234 B	10.964	250	02.92-09.96	OM 441.992	LK 055
3234 K	10.964	250	02.92-09.96	OM 441.992	LK 055
3238	12.763	280	03.91-09.96	OM 402.985	LK 055
3238	14.618	280	03.91-09.96		LK 055
3238	18.273	261	03.91-09.96		LK 055
3238	12.763	280	10.90-09.96	OM 402.977	LK 055
3238	14.618	362-370	10.90-09.96		LK 055
3238, 3238 L	14.618	280	01.94-09.96		LK 055
3238, 3238 L	14.618	320	10.90-09.96	OM 446.939	LK 055
3253, 3253 L	14.618	390	01.96-09.96		LK 055
3534 K	10.964	250	10.93-09.96	OM 441.988	LK 055
3535 AK	12.763	280	03.91-09.96	OM 402.982	LK 055
3535 K	12.763	280	03.91-09.96	OM 402.983	LK 055
3538	12.763	280	03.91-09.96	OM 402.987	LK 055
3538	14.618	280	03.91-09.96	OM 440.987	LK 055
3538 AK	14.618	280	01.94-09.96	OM 446.926	LK 055
3538 AK	12.763	280	03.91-09.96	OM 402.978	LK 055
3538 AK	14.618	320	03.91-09.96	OM 446.939	LK 055
3538 AK	14.618	370	03.91-09.96	OM 440.982	LK 055
3538 K	14.618	280	01.94-09.96	OM 446.926	LK 055
3538 K	12.763	280	03.91-09.96	OM 402.973	LK 055
3538 K	14.618	320	03.91-09.96	OM 446.939	LK 055
3538 K	14.618	362-370	03.91-09.96	OM 440.983	LK 055
3550	14.618	362-370	05.92-09.96	OM 440.975	LK 055
3550 S, 3553 S	14.618	362-370	05.92-09.96	OM 440.975	LK 055
3553 S	14.618	390	04.92-	OM 446.933	LK 055
3553, 3553 L	14.618	390	01.94-09.96	OM 446.920	LK 055
4050 A	14.618	370	07.87-	OM 440.975	LK 055

T1/TN

408 D	2.299	58-60	11.88-06.95	OM 601.940	LK 059
408 D	2.299	58-60	11.88-06.95	OM 601.940	LK 059
410	2.298	70-77	08.82-06.95	M 102.945	LK 059
410	2.298	70-77	08.82-06.95	M 102.945	LK 059

T2/LN1

508 D	2.299	58	03.89-12.94	OM 601.941	LK 059
508 D	2.299	58	03.89-12.94	OM 601.941	LK 059
510	2.299	70-77	04.86-12.94	M 102.946	LK 059
510	2.299	70-77	04.86-12.94	M 102.946	LK 059
609 D	3.972	77	06.94-12.94	OM 354.902	LK 057
609 D	3.972	77	06.94-12.94		LK 057
611 D	3.972	77	06.94-12.94	OM 354.901	LK 057
611 D	3.972	77	06.94-12.94	OM 354.902	LK 057
611 DK	3.972	77	06.94-12.94		LK 057
711 D	3.972	77-85	04.86-12.94	OM 354.902	LK 056
711 D	3.972	77-85	04.86-12.94	OM 354.902	LK 057
711 D	3.972	77-85	04.86-12.94	OM 354.903	LK 056
711 D	3.972	77-85	04.86-12.94	OM 354.903	LK 057
714 D	3.972	103	06.94-12.94	OM 354.923	LK 057
714 D	3.972	103	06.94-12.94	OM 354.923	LK 057
811 D	3.972	77-85	04.86-12.94	OM 364.958	LK 056
811 D	3.972	77-85	04.86-12.94	OM 364.958	LK 057
811 D	3.972	77-85	04.86-12.94	OM 364.958	LK 057
811 DK	3.972	77-85	04.86-12.94	OM 354.903	LK 056
811 DK	3.972	77-85	04.86-12.94	OM 354.903	LK 057
814 D	3.972	100-103	11.87-12.94	OM 364.981	LK 056
814 D	3.972	100-103	11.87-12.94	OM 364.981	LK 057
814 D	3.972	100-103	11.87-12.94	OM 354.924	LK 056
814 D	3.972	100-103	11.87-12.94	OM 354.924	LK 057

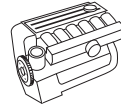

kW

MERCEDES-BENZ
T2/LN1

814 DA	3.972	100-103	11.87-12.94	OM 364.984	LK 056	
814 DA	3.972	100-103	11.87-12.94	OM 364.984	LK 057	
814 DA	3.972	100-103	11.87-12.94	OM 364.987	LK 056	
814 DA	3.972	100-103	11.87-12.94	OM 364.987	LK 057	
O 611 D	3.972	85	07.87-12.92	OM 364.954	LK 056	

TOURINO (O 510)

TOURINO	6.374	205	10.03-	OM 906.961		LR 012
TOURINO	6.374	180	10.03-	OM 906.962	LK 066	

UNIMOG

U 300	4.249	110	03.00-	OM 904.927	LK 065	LR 009
U 300	4.249	110	03.00-	OM 904.927 für OE-Nr. A 906 200 09 22	LK 066	LR 009
U 300	4.249	110	03.00-	OM 904.927	LK 095	LR 009
U 300	4.249	130	03.00-	OM 904.928	LK 095	LR 009
U 300	4.249	130	03.00-	OM 904.928	LK 095	LR 023
U 300	4.249	130	03.00-	OM 904.928	LK 095	LR 024
U 300	4.249	130	03.00-	OM 904.928 für OE-Nr. A 906 200 09 22	LK 066	
U 3000	4.249	112-115	09.02-	OM 900.920	LK 096	
U 3000	4.249	112-115	09.02-	OM 900.920	LKK 020	
U 400	4.249	130	03.00-	OM 904.928	LK 065	LR 009
U 400	4.249	130	03.00-	OM 904.928 für OE-Nr. A 906 200 09 22	LK 066	LR 009
U 400	4.249	130	03.00-	OM 904.928	LK 095	LR 009
U 400	6.374	170	03.00-	OM 906.935	LK 066	LR 012
U 400	6.374	170	03.00-	OM 906.935		LR 024
U 4000	4.249	112-115	09.02-	OM 900.920	LK 096	
U 4000	4.801	160	09.02-	OM 924.923	LK 096	
U 4000	4.249	130	09.02-	OM 904.952	LK 096	
U 4000	4.249	130	09.02-	OM 904.952	LKK 020	
U 500, UGN NA	6.374	170-172	10.00-	OM 906.935 ID 405.200	LK 066	LR 012
U 500, UGN NA	6.374	205-209	10.00-	OM 906.955 ID 405.220	LK 066	LR 024
U 5000	4.801	160	09.02-	OM 924.923	LK 065	
U 5000	4.801	160	09.02-	OM 924.923	LKK 020	
U 5000	6.374	170	11.02-	OM 906.935		LR 024
VARIO						
613 D, 614 D	4.250	95-100	09.96-	OM 904.908 Motor Nr. 29 372 →	LK 049	
613 D, 614 D	4.250	95-100	09.96-	OM 904.908 Motor Nr. 29 372 →	LK 049	
613 D, 614 D	4.250	95-100	09.96-	OM 904.908 Motor Nr. 29 372 →	LK 049	
615 D, 616 D	4.250	112-115	09.98-	OM 904.908 Motor Nr. 29 372 →	LK 049	
615 D, 616 D	4.250	112-115	09.98-	OM 904.923 Motor Nr. 29 372 →	LK 049	
615 D, 616 D	4.250	112-115	09.98-	OM 904.923 Motor Nr. 29 372 →	LK 049	
810 DT	4.250	100	09.96-	OM 904.923 Motor Nr. 29 372 →	LK 049	
810 DT	4.250	112	09.96-	OM 904.923 Motor Nr. 29 372 →	LK 049	
813 D, 814 D	4.250	95-100	09.96-	OM 904.908 Motor Nr. 29 372 →	LK 049	
813 D, 814 D	4.250	95-100	09.96-	OM 904.908 Motor Nr. 29 372 →	LK 049	
813 D, 814 D	4.250	95-100	09.96-	OM 904.908 Motor Nr. 29 372 →	LK 049	
813 DA, 814 DA	4.250	95-100	09.96-	OM 904.908 Motor Nr. 29 372 →	LK 049	
813 DA, 814 DA	4.250	95-100	09.96-	OM 904.908 Motor Nr. 29 372 →	LK 049	
813 DA, 814 DA	4.250	95-100	09.96-	OM 904.908 Motor Nr. 29 372 →	LK 049	
815 D, 816 D	4.250	112-115	09.96-	OM 904.908 Motor Nr. 29 372 →	LK 049	
815 D, 816 D	4.250	112-115	09.96-	OM 904.923 Motor Nr. 29 372 →	LK 049	
815 D, 816 D	4.250	112-115	09.96-	OM 904.923 Motor Nr. 29 372 →	LK 049	
815 DA, 816 DA	4.250	112-115	09.96-	OM 904.923 Motor Nr. 29 372 →	LK 049	
815 DA, 816 DA	4.250	112-115	09.96-	OM 904.923 Motor Nr. 29 372 →	LK 049	
815 DA, 816 DA	4.250	112-115	09.96-	OM 904.923 Motor Nr. 29 372 →	LK 049	
O 814	4.250	100	09.96-	OM 904.908 Motor Nr. 29 372 →	LK 049	
O 815	4.250	112	09.96-	OM 904.923 Motor Nr. 29 372 →	LK 049	



kW

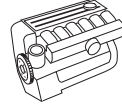

RENAULT

Kerax

460.32	12.800	339	05.06-	Dxi 13	LKK 009	
460.32	12.800	339	05.06-	Dxi 13	LKK 009	
460.32	12.800	339	05.06-	Dxi 13	LKK 009	
500.32	12.800	368	05.06-	Dxi 13	LKK 009	
500.32	12.800	368	05.06-	Dxi 13	LKK 009	

SCANIA

Serie 3

113 M/320	11.020	235-239	01.90-12.96	DSC 11.16	LK 100	
113 M/320	11.020	235-239	01.90-12.96	DSC 11.17	LK 100	
113 M/320	11.020	239	05.88-12.89		LK 100	
113 M/360	11.020	265-267	01.90-12.96	DSC 11.18	LK 100	
113 M/360	11.020	265-267	01.90-12.96	DSC 11.30	LK 100	
113 M/360	11.020	265-267	01.90-12.96	DSC 11.23	LK 100	
113 M/360	11.020	265-267	01.90-12.96	DSC 11.13	LK 100	
113 M/360	11.020	267	05.88-12.89	DSC 11.13	LK 100	
113 M/380	11.020	280	01.91-12.96	DSC 11.22	LK 100	
113 M/400	11.020	295	01.92-12.96	DTC 11.02	LK 100	

Serie 4

114 L/340	10.600	250	-	DC 11.03	LK 101	
114 L/340	10.600	250	-	DC 11.01	LK 101	
114 L/340	10.600	250	03.98-		LK 101	
114 L/340	11.000	250	05.96-		LK 101	
114 L/340	11.000	250	05.96-	DSC 11.79	LK 101	
114 L/380	10.600	279-280	-	DC 11.04	LK 101	
114 L/380	10.600	280	03.98-	DC 11.04	LK 101	
114 L/380	10.600	280	03.98-	DC 11.02	LK 101	

VOLVO

FH 12

FH 12/340	12.100	250	01.95-	D12A340		LR 031
FH 12/340	12.100	250	08.93-	D12C340		LR 031
FH 12/340	12.100	250	08.93-	D12D340		LR 031
FH 12/380	12.100	279	08.93-	D12A380	LK 102	
FH 12/380	12.100	279	08.93-	D12C380	LK 102	
FH 12/380	12.100	279	08.93-	D12D380	LK 102	
FH 12/420	12.100	309	01.95-	D12C420	LK 102	
FH 12/420	12.100	309	08.93-	D12A420	LK 102	
FH 12/420	12.100	309	08.93-	D12D420	LK 102	

FH 16

FH 16/470	16.120	346	08.93-12.99	D16A470	LK 103	LR 032
FH 16/520	16.120	382	08.93-12.02	D16A520	LK 103	LR 032
FH 16/520	16.120	382	08.93-12.02	D16B520	LK 103	LR 032
FH 16/540	16.120	396-397	01.09-		LK 103	LR 032
FH 16/540, FH 16/550	16.120	396-404	01.03-	D16G540	LK 103	LR 032
FH 16/540, FH 16/550	16.120	396-404	01.03-	D16E540	LK 103	LR 032
FH 16/540, FH 16/550	16.120	396-404	01.03-	D16C550	LK 103	LR 032
FH 16/580	16.120	426	09.06-	D16E580	LK 103	LR 032
FH 16/600	16.120	441	09.06-	D16G600	LK 103	LR 032
FH 16/610	16.120	449	01.03-	D16C610	LK 103	LR 032
FH 16/660	16.120	485	09.06-	D16E660	LK 103	LR 032
FH 16/700	16.120	515	01.09-	D16G700	LK 103	LR 032

FM

FM 400	12.800	294	09.05-	D13A400	LKK 009	
FM 400	12.800	294	09.05-	D13B400	LKK 009	
FM 440	12.800	324	09.05-	D13A440	LKK 009	
FM 440	12.800	324	09.05-	D13B440	LKK 009	
FM 480	12.800	353	09.05-	D13A480	LKK 009	
FM 500	12.800	368	09.05-	D13B500	LKK 009	
FM 500	12.800	368	09.05-	D13C500	LKK 009	



LK 001 0 720 002 001

A 140,0 mm
B 39,0 mm

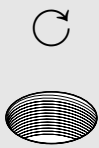

Audi/VW 058 121 350

 LR 002
0 720 001 002

LK 004 0 720 002 004

A 140,0 mm
B 32,0 mm

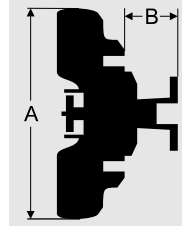

Audi/VW 078 121 350 A

 LR 001
0 720 001 001

LK 002 0 720 002 002

A 147,0 mm
B 36,8 mm

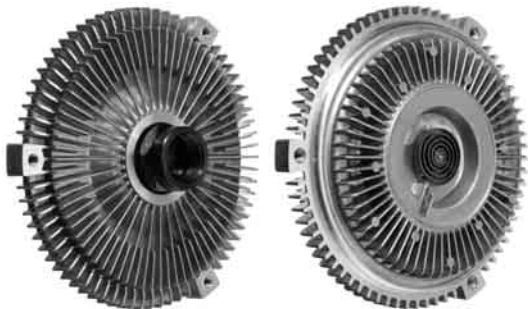
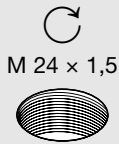

Audi/VW 059 121 350 F,
059 121 350 G, 059 121 350 H

LK 005 0 720 002 005

A 140,0 mm
B 33,0 mm

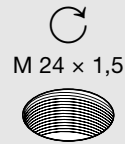

Audi/VW 4A0 121 350 B

LK 003 0 720 002 003

A 147,0 mm
B 36,8 mm

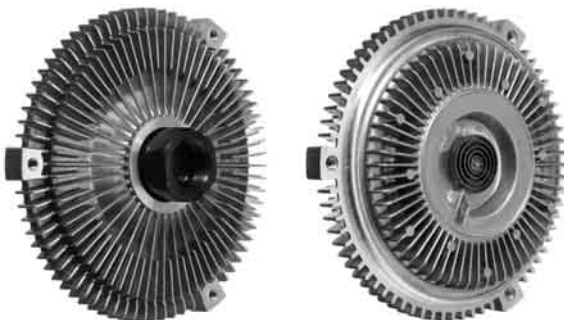

Audi/VW 077 121 350 D

LK 006 0 720 002 006

A 152,0 mm
B 20,0 mm

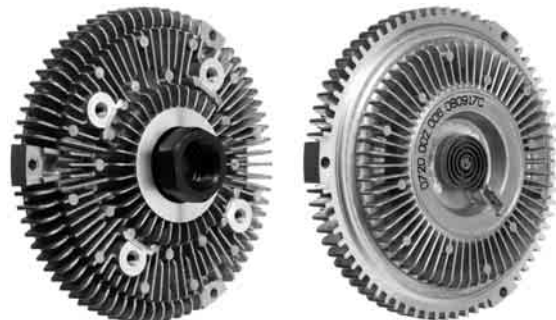

BMW 11 52 2 241 505



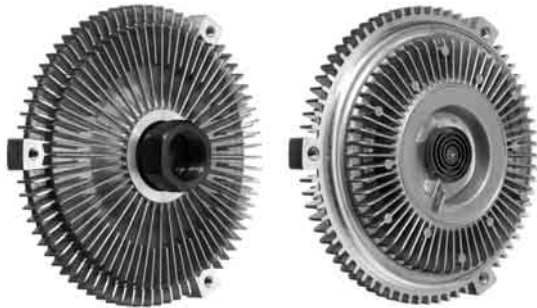

LK 007 0 720 002 007

A	160,0 mm		M24 x 1,5
B	37,0 mm		



BMW 11 52 2 245 498

LK 010 0 720 002 010

A	160,0 mm		M 24 x 1,5
B	37,0 mm		

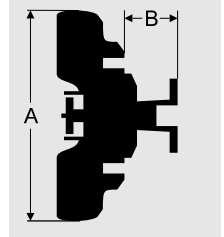

BMW 11 52 7 502 804

 LR 004
0 720 001 004

LK 008 0 720 002 008

A	160,0 mm		M24 x 1,5
B	45,0 mm		



BMW 11 52 2 246 042

LK 011 0 720 002 011



A	160,0 mm		M 24 x 1,5
B	37,0 mm		



BMW 11 52 7 505 302

 LR 003
0 720 001 003



LK 009 0 720 002 009

A	160,0 mm		M 24 x 1,5
B	45,0 mm		



BMW 11 52 2 249 216

LK 012 0 720 002 012

A	140,0 mm		M 24 x 1,5
B	24,0 mm		

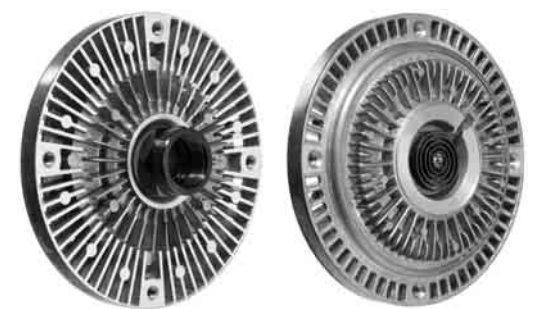

BMW 11 52 1 740 962



LK 013 0 720 002 013

A 140,0 mm
B 34,0 mm



FORD 6080770, 79 GB 8A616 A1C

LK 016 0 720 002 016

A 152,0 mm
B 30,0 mm

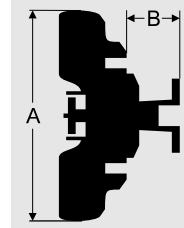

FORD 01105276, 98 VB 8A616 BC

LK 014 0 720 002 014

A 152,0 mm
B 22,0 mm

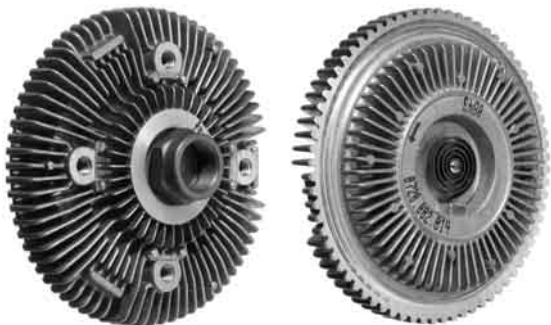

FORD 6707917, 92 VB 8A616 BA

LK 017 0 720 002 017

A 152,0 mm
B 30,0 mm

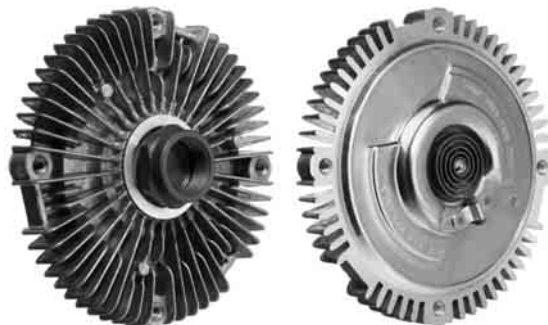

FORD 88 VB 8A616 AA

LK 015 0 720 002 015

A 140,0 mm
B 40,0 mm



FORD 1063042, 98 VB 8A616 CA

LK 018 0 720 002 018

A 186,0 mm
B 31,0 mm

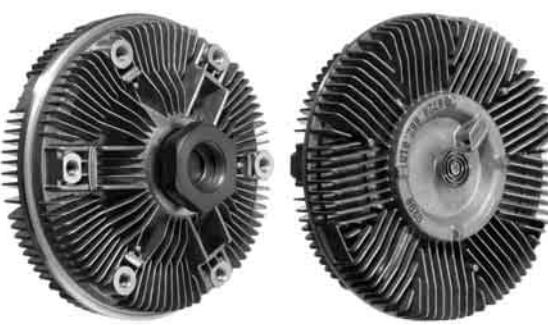

FORD 91 CT 8A616 BA

**LK 019** 0 720 002 019

A 241,0 mm
B 53,0 mm



Iveco 41213991

LK 022 0 720 002 022

A 167,0 mm
B 28,0 mm

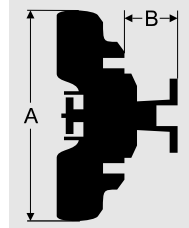

Land Rover ERR 2266

LK 020 0 720 002 020

A 203,0 mm
B 55,0 mm

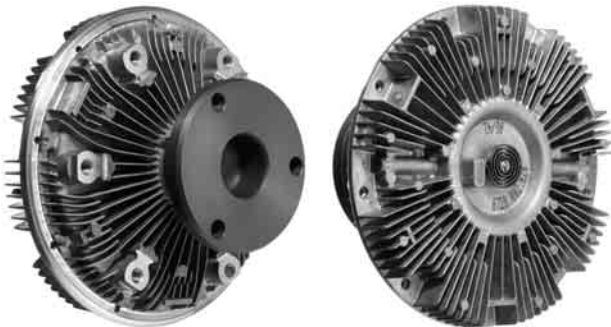

Iveco 504029738

LK 023 0 720 002 023

A 165,0 mm
B 28,0 mm

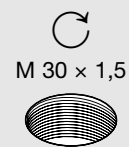

Land Rover ERR 4996

LK 021 0 720 002 021

A 164,0 mm
B 51,0 mm



MAN 51 06630 0037

LK 024 0 720 002 024

A 167,0 mm
B 28,0 mm



Land Rover ETC 1260



LK 026 0 720 002 026

A 152,0 mm
B 22,0 mm

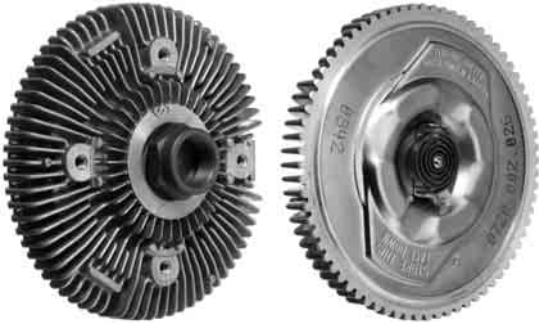

Land Rover ETC 7238

LK 029 0 720 002 029

A 205,0 mm
B 68,0 mm

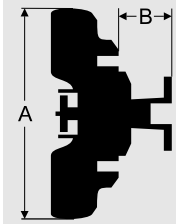

MAN 51 06630 0107, 51 06630 0131

LK 027 0 720 002 027

A 167,0 mm
B 28,0 mm

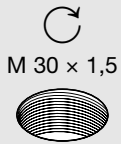

Land Rover ERR 3443

LK 030 0 720 002 030

A 245,0 mm
B 62,0 mm



MAN 51 06630 0096, 51 06630 0129

LK 028 0 720 002 028

A 245,0 mm
B 62,0 mm



MAN 51 06630 0106, 51 06630 0130

LK 031 0 720 002 031

A 186,0 mm
B 51,0 mm



MAN 51 06630 0067



LK 032 0 720 002 032

A	164,0 mm	
B	51,0 mm	



MAN 51 06630 0071

LK 037 0 720 002 037

A	160,0 mm	
B	23,0 mm	

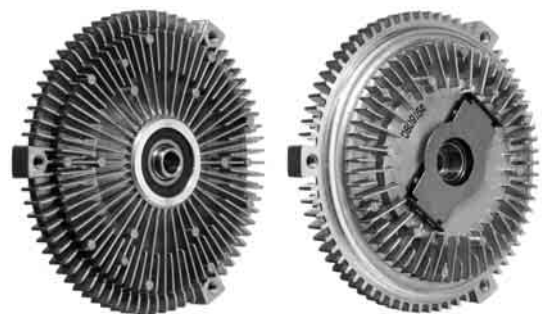
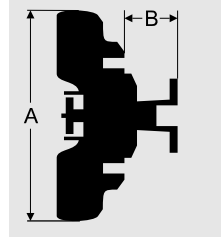

Mercedes Benz A 104 200 01 22

LK 035 0 720 002 035

A	160,0 mm	
B	23,0 mm	

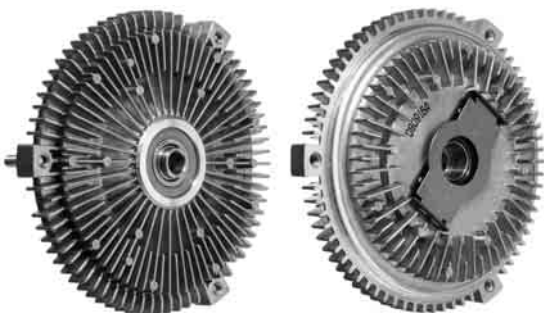

Mercedes Benz A 103 200 05 22

LK 038 0 720 002 038

A	160,0 mm	
B	36,0 mm	M 30 x 1,5



Mercedes Benz A 111 200 04 22

LK 036 0 720 002 036

A	160,0 mm	
B	23,0 mm	



Mercedes Benz A 103 200 09 22

LK 039 0 720 002 039

A	160,0 mm	
B	36,0 mm	M 30 x 1,5

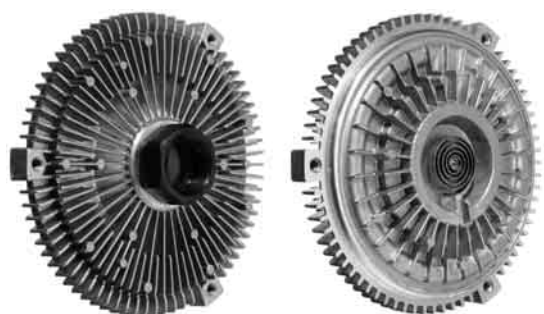

Mercedes Benz A 112 200 02 22



LK 040 0 720 002 040

A 165,0 mm
B 52,0 mm



Mercedes Benz A 116 200 05 22

LK 043 0 720 002 043

A 165,0 mm
B 19,0 mm

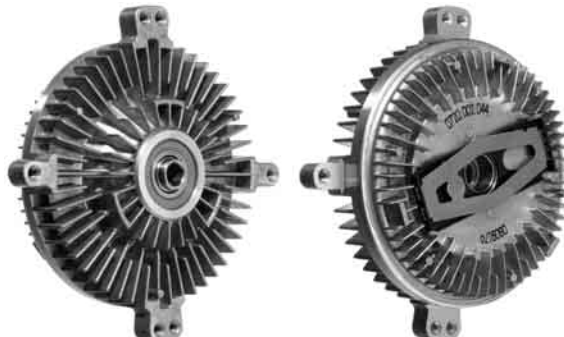
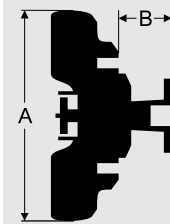

Mercedes Benz A 119 200 01 22

LK 041 0 720 002 041

A 165,0 mm
B 52,0 mm

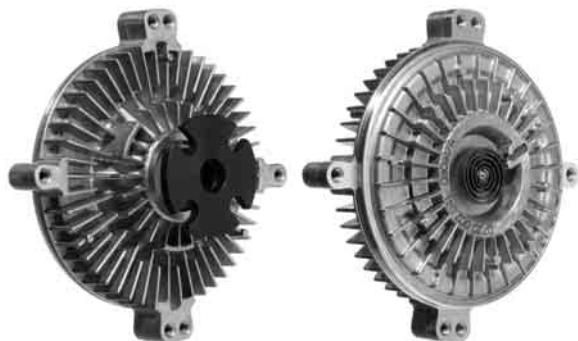

Mercedes Benz A 116 200 11 22

LK 044 0 720 002 044

A 165,0 mm
B 23,0 mm

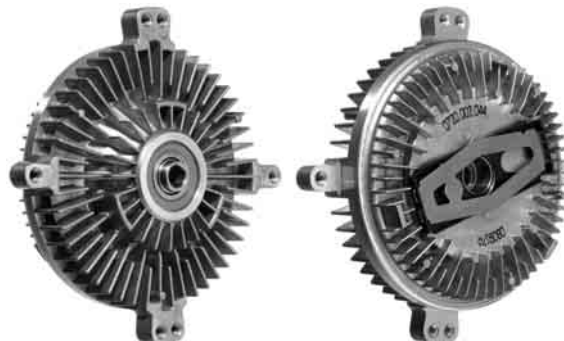

Mercedes Benz A 120 200 01 22

LK 042 0 720 002 042

A 165,0 mm
B 32,0 mm

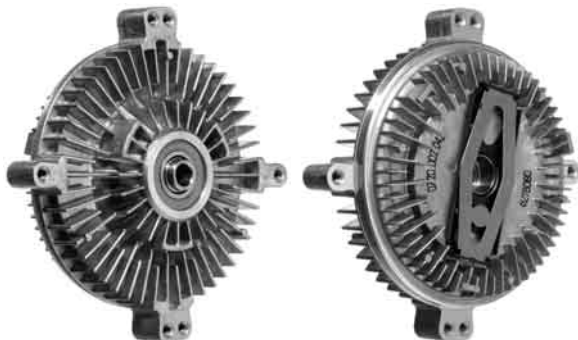

Mercedes Benz A 119 200 00 22

LK 045 0 720 002 045

A 160,0 mm
B 23,0 mm

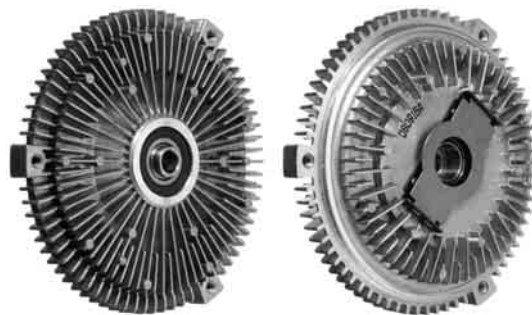

Mercedes Benz A 603 200 00 22



LK 046 0 720 002 046

A	140,0 mm	
B	33,0 mm	M 30 x 1,5



Mercedes Benz A 604 200 00 22

LK 050 0 720 002 050

A	160,0 mm	
B	23,0 mm	

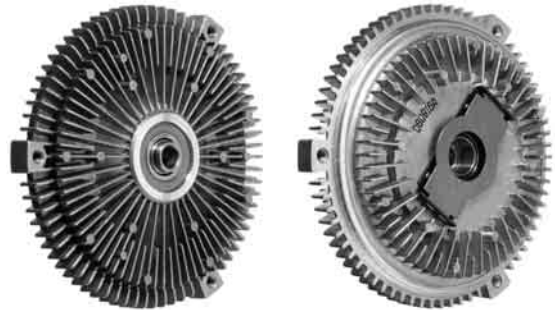
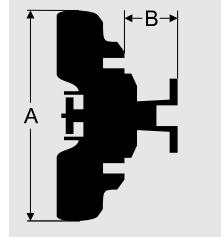

Mercedes Benz A 000 200 37 22

LK 047 0 720 002 047

A	160,0 mm	
B	23,0 mm	

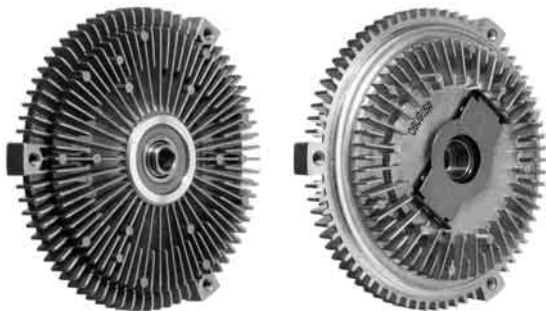

Mercedes Benz A 606 200 01 22

LK 051 0 720 002 051

A	160,0 mm	
B	23,0 mm	

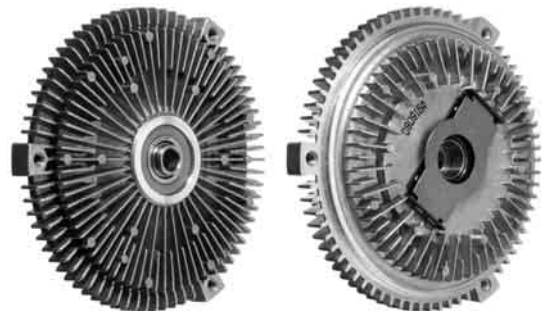

Mercedes Benz A 000 200 51 22

LK 049 0 720 002 049

A	160,0 mm	
B	53,0 mm	



Mercedes Benz A 904 200 11 22

LK 052 0 720 002 052

A	160,0 mm	
B	23,0 mm	

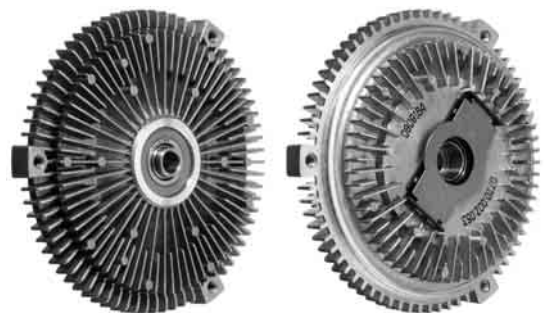

Mercedes Benz A 103 200 02 22



LK 053 0 720 002 053

A 160,0 mm
B 23,0 mm

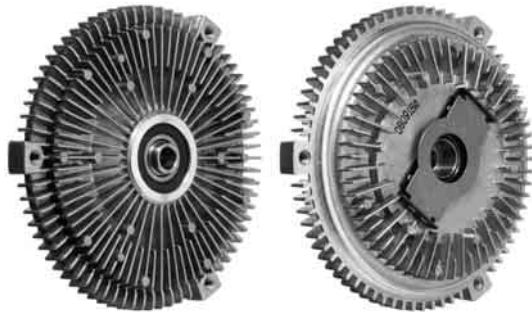
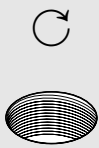

Mercedes Benz A 103 200 04 22

LK 056 0 720 002 056

A 180,0 mm
B 45,0 mm

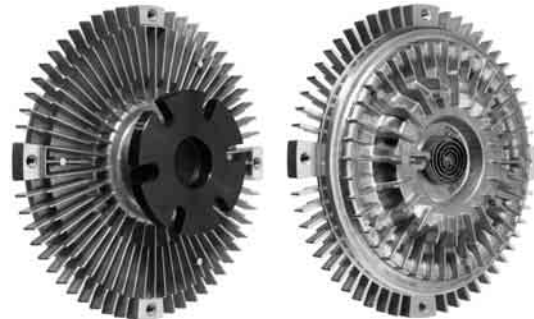
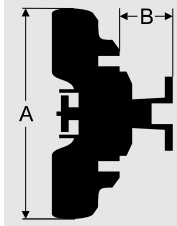

Mercedes Benz A 000 200 30 22

LK 054 0 720 002 054

A 160,0 mm
B 23,0 mm

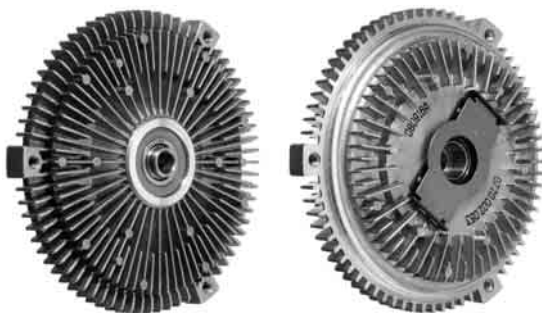
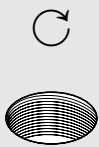

Mercedes Benz A 103 200 06 22

LK 057 0 720 002 057

A 180,0 mm
B 45,0 mm

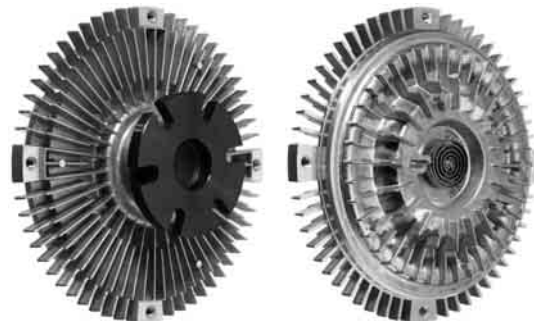
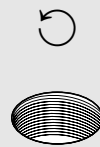

Mercedes Benz A 000 200 40 22

LK 055 0 720 002 055

A 242,0 mm
B 43,0 mm



Mercedes Benz
A 000 200 33 20, A 000 200 35 22,
A 000 200 42 22, A 000 200 43 22,
A 000 200 47 22, A 000 200 70 22,
A 000 200 71 22, A 000 200 81 22

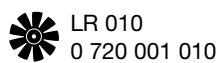

LK 058 0 720 002 058

A 165,0 mm
B 52,0 mm



Mercedes Benz A 116 200 06 22



LK 059 0 720 002 059

A	160,0 mm	
B	23,0 mm	

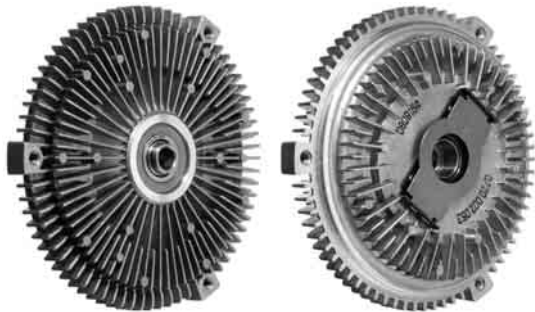

Mercedes Benz A 102 200 02 22

LK 066 0 720 002 066

A	186,0 mm	
B	69,0 mm	

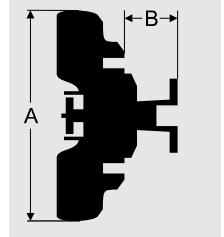

Mercedes Benz A 906 200 09 22

LR 012
0 720 001 012

LK 060 0 720 002 060

A	160,0 mm	
B	36,0 mm	M 30 x 1,5

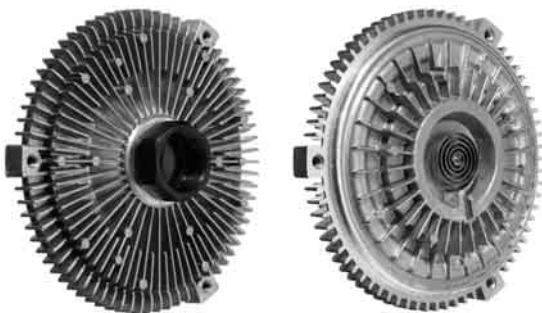

Mercedes Benz A 112 200 01 22

LK 068 0 720 002 068

A	150,0 mm	
B	62,0 mm	



Mitsubishi MD 006330

LK 065 0 720 002 065

A	165,0 mm	
B	69,0 mm	



Mercedes Benz A 904 200 08 22

LR 009
0 720 001 009

LK 070 0 720 002 070

A	150,0 mm	
B	56,0 mm	



Mitsubishi MD 108270



LK 072 0 720 002 072

A 203,0 mm
B 47,0 mm

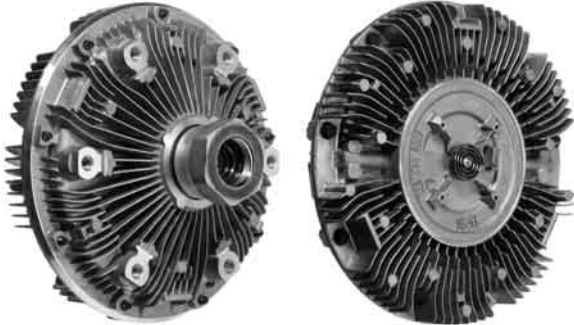

Renault 50 10 514 014

LK 080 0 720 002 080

A 136,0 mm
B 69,0 mm

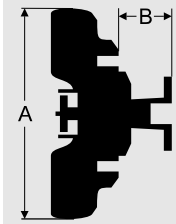

Toyota 16210-54070

LK 078 0 720 002 078

A 136,0 mm
B 49,0 mm



Toyota 16210-38050

LK 081 0 720 002 081

A 158,0 mm
B 66,0 mm



Toyota 16210-54130

LK 079 0 720 002 079

A 136,0 mm
B 49,0 mm



Toyota 16210-38060

LK 082 0 720 002 082

A 158,0 mm
B 85,0 mm



Toyota 16210-54150

**LK 083** 0 720 002 083

A	158,0 mm	
B	58,0 mm	



Volvo 1328835

LK 086 0 720 002 086

A	140 mm	
B		

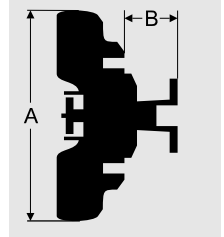
Mercedes Benz A 541 200 09 22,
A 541 200 13 22, A 541 200 16 22**LK 084** 0 720 002 084

A		
B		



Volvo 1266788

LK 088 0 720 002 088

A	164,5 mm	
B	30,7 mm	



Iveco 94338027, 98468660

LK 085 0 720 002 085

A	158,0 mm	
B	58,0 mm	

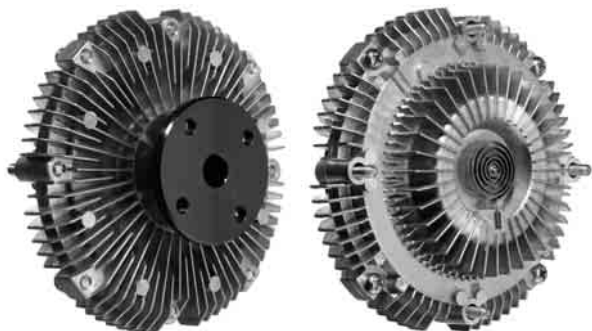

Volvo 1274963

LK 089 0 720 002 089

A	164,5 mm	
B	30,7 mm	M 30 x 2

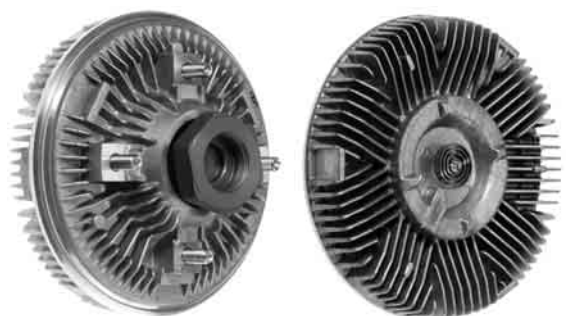

Deutz 0425 3784 EZ



LK 090 0 720 002 090

A 186,4 mm
B 30,7 mm

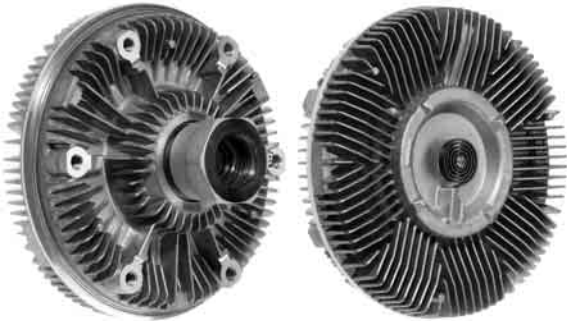

Deutz 0425 3785 EZ

LK 093 0 720 002 093

A 270,0 mm
B 92,5 mm

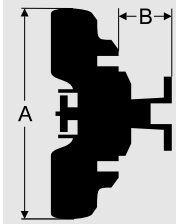

MAN 51 06630 0119

LK 091 0 720 002 091

A 123,8 mm
B 33,5 mm

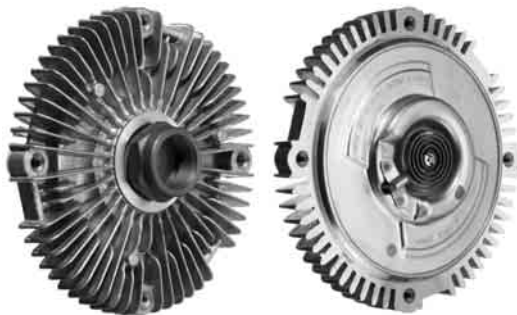
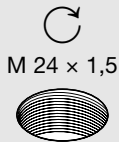

FORD 1 591 125, 79 BB 8A616 A1C

LK 094 0 720 002 094

A 290,0 mm
B 56,9 mm



MAN 51 06630 0068

 LR 017
0 720 001 017

LK 092 0 720 002 092

A 203,2 mm
B 58,0 mm



MAN 51 06630 0060

 LR 020
0 720 001 020

LK 095 0 720 002 095

A 184,5 mm
B 46,0 mm



Mercedes Benz A 904 200 06 22

 LR 023
0 720 001 023



LK 096 0 720 002 096

A	164,5 mm	
B	30,7 mm	M 30 x 2



Mercedes Benz A 437 500 00 22

LK 099 0 720 002 099

A	167,6 mm	
B	27,8 mm	M 30 x 1,5

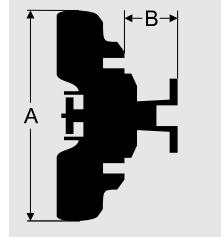
Renault 50 10 514 380

LK 097 0 720 002 097

A	203,2 mm	
B	72,0 mm	

Mercedes Benz A 906 200 06 22

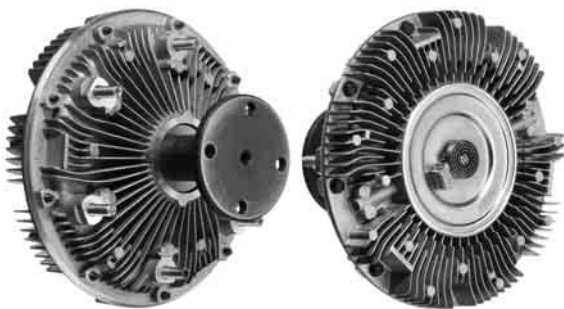
LK 100 0 720 002 100

A	199,0 mm	
B	52,0 mm	



Scania 148 0770

LK 098 0 720 002 098

A	186,4 mm	
B	46,7 mm	M 30 x 2



Renault 50 10 514 015

LK 101 0 720 002 101

A	203,2 mm	
B	93,0 mm	



Scania 134 9551



LK 102 0 720 002 102

A 203,2 mm
B 71,0 mm

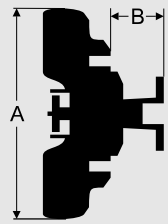

Volvo 1675036

LK 103 0 720 002 103

A 240,0 mm
B 89,0 mm

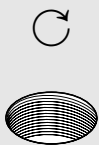

Volvo 8149972

 **LR 032**
 0 720 001 032



LKK 001 0 720 003 001

A	400,0 mm		M 25 x 1,5
B	140,0 mm		
C	76,0 mm		



FORD 04406277, 2C 11 8C617 BA

LKK 005 0 720 003 005

A	600,0 mm		
B	186,0 mm		
C	55,0 mm		



Iveco 504123949

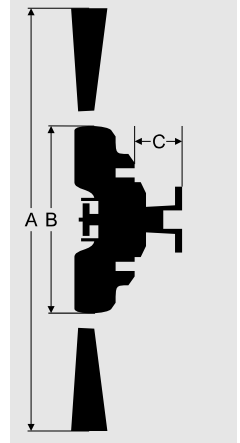

LKK 002 0 720 003 002

A	440,0 mm		M 25 x 1,5
B	164,5 mm		
C			

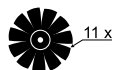

Land Rover PGG 101 290

LKK 006 0 720 003 006

A	754,0 mm		
B	245,0 mm		
C	62,0 mm		



MAN 51 06600 7024, 51 06600 7046

LKK 004 0 720 003 004

A	600,0 mm		
B	164,5 mm		
C			



MAN 51 06601 7011

LKK 007 0 720 003 007

A	754,0 mm		
B	245,0 mm		
C	62,0 mm		



MAN 51 06600 7015, 51 06600 7045



LKK 008 0 720 003 008

A 560,0 mm
B 164,0 mm
C 47,0 mm



Renault 50 10 514 013

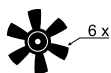

LKK 012 0 720 003 012

A 390,0 mm
B 139,0 mm
C 40,0 mm



FORD 1 436 157, 6C 11 8C617 CA

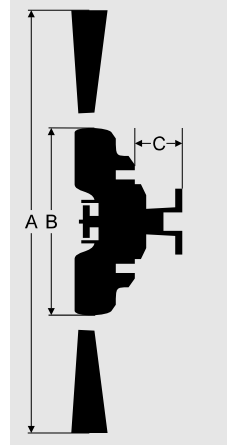

LKK 009 0 720 003 009

A 680,0 mm
B 245,0 mm
C 89,8 mm



Renault 74 21 012 697, Volvo 20576186

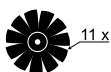

LKK 013 0 720 003 013

A 654,0 mm
B
C

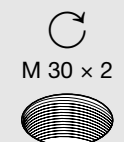

FORD 3C 46 8C617 BA



LKK 010 0 720 003 010

A 680,0 mm
B 245,0 mm
C 89,8 mm



MAN 51 06600 7025



LKK 014 0 720 003 014

A 704,0 mm
B
C

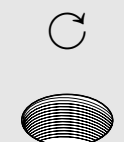

Iveco 41213626





LKK 015 0 720 003 015

A	475,0 mm	
B	172,5 mm	M 30 x 1,5
C		

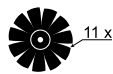

Land Rover PGG 500 340

LKK 019 0 720 003 019

A	654,0 mm	
B	196,7 mm	
C		

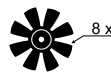

Mercedes Benz A 906 200 08 23

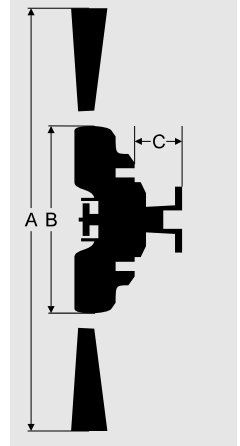

LKK 017 0 720 003 017

A	600,0 mm	
B		
C		



Mercedes Benz A 904 200 05 23

LKK 020 0 720 003 020

A	600,0 mm	
B		
C		M 30 x 2



Mercedes Benz A 904 200 10 23

LKK 018 0 720 003 018

A	600,0 mm	
B		
C		

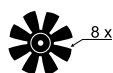

Mercedes Benz A 906 200 09 23

LKK 021 0 720 003 021

A	560,0 mm	
B	154,5 mm	
C		M 30 x 2

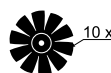

Renault 50 01 864 384



LKK 022 0 720 003 022

A 620,0 mm
B
C



Renault 50 10 514 011 C



LKK 025 0 720 003 025

A 400,0 mm
B
C



Audi/VW 074 121 302 B, 074 121 302 C

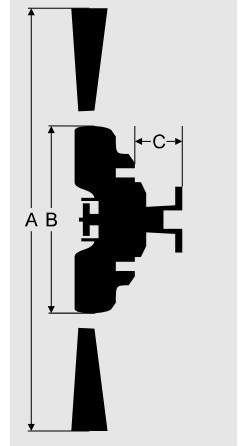
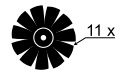

LKK 023 0 720 003 023

A 560,0 mm
B
C

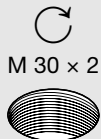

Renault 50 10 514 061



LKK 026 0 720 003 026

A 560,0 mm
B
C

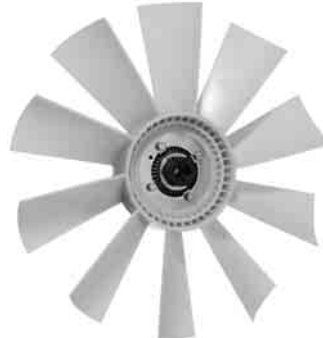
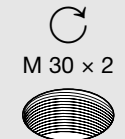

Volvo 8113266

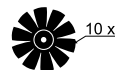

LKK 024 0 720 003 024

A 750,0 mm
B
C



Scania 145 9683



LKK 027 0 720 003 027

A 620,0 mm
B
C

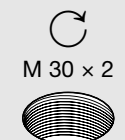

Volvo 85000072





LKK 028 0 720 003 028

A	560,0 mm	
B		M 30 x 2
C		

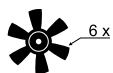

Volvo 20501361

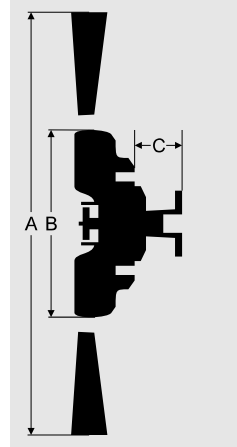



LR 001 0 720 001 001

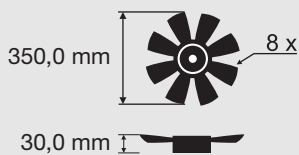

Audi/VW 078 121 301 E

 LK 004
0 720 002 004

LR 004 0 720 001 004

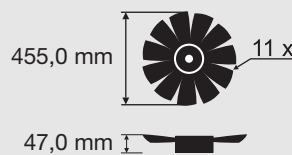

BMW 11 52 1 712 110

 LK 010
0 720 002 010

LR 002 0 720 001 002

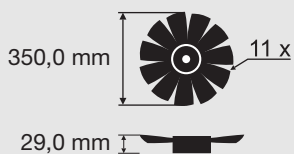

Audi/VW 058 121 301 B

 LK 001
0 720 002 001

LR 005 0 720 001 005

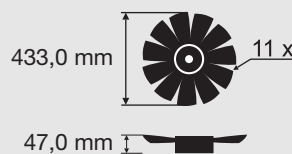

Land Rover ERR 2789

LR 003 0 720 001 003

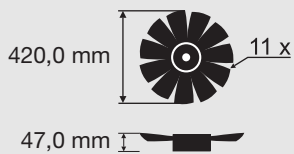

BMW 11 52 1 712 058

 LK 011
0 720 002 011

LR 006 0 720 001 006

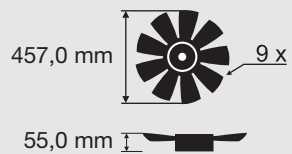

Land Rover ERR 4960



LR 007 0 720 001 007

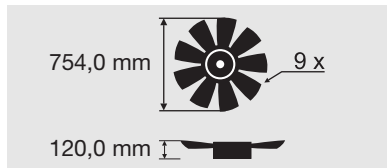

MAN 51 06601 0275

LR 010 0 720 001 010

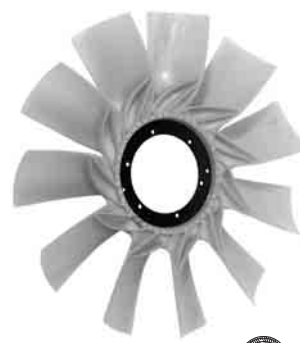
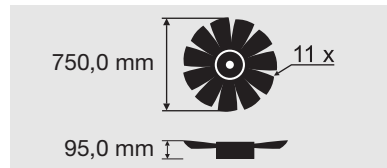

Mercedes Benz A 541 205 00 06

LK 055
0 720 002 055

LR 008 0 720 001 008

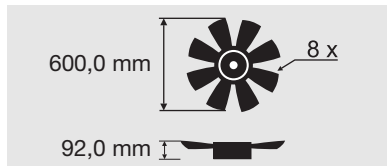

MAN 51 06601 0266

LR 012 0 720 001 012

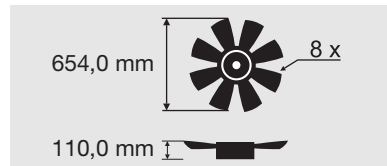

Deutz 312 514,
Mercedes Benz A 906 205 01 06

LK 066
0 720 002 066

LR 009 0 720 001 009

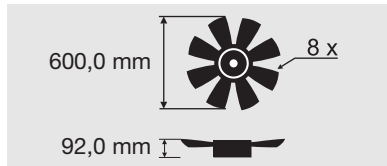

Mercedes Benz A 904 205 04 06

LK 065
0 720 002 065

LR 013 0 720 001 013

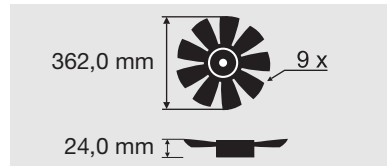

FORD 7 101 785, 95 VB 8600 BA



LR 014 0 720 001 014

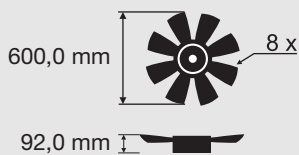

Iveco 5040 29737

LR 017 0 720 001 017

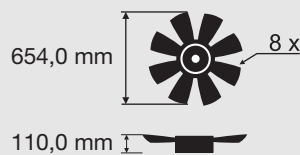

MAN 51 06601 0258

 LK 094
0 720 002 094

LR 015 0 720 001 015

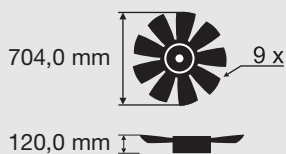

Iveco 5040 26023

LR 018 0 720 001 018

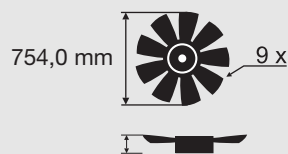

MAN 11 071 90 8, 51 06601 0257 A

LR 016 0 720 001 016

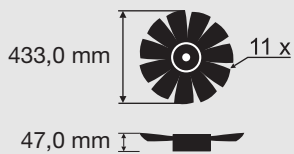

Land Rover ERR 3439

LR 019 0 720 001 019

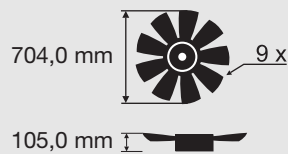

MAN 51 06601 0279



LR 020 0 720 001 020

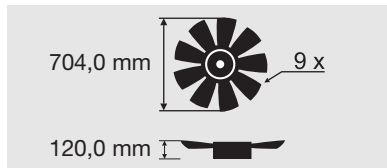

MAN 51 06601 0256

 LK 092
0 720 002 092

LR 024 0 720 001 024

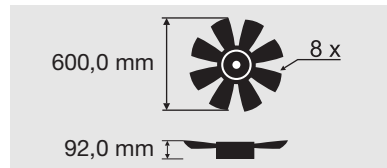

Mercedes Benz A 906 205 08 06

LR 021 0 720 001 021

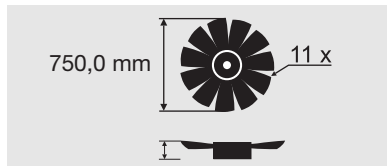

MAN 51 06601 0283

LR 025 0 720 001 025

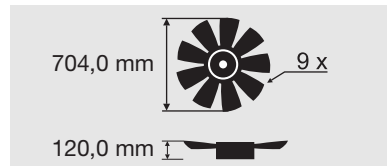

Mercedes Benz A 906 205 06 06

LR 023 0 720 001 023

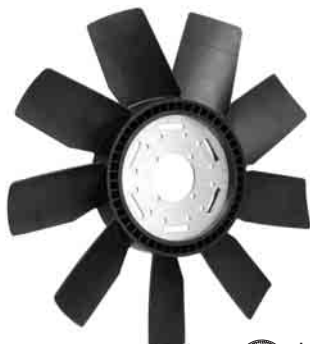
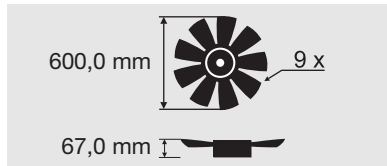

Mercedes Benz A 366 200 46 23

 LK 095
0 720 002 095

LR 026 0 720 001 026

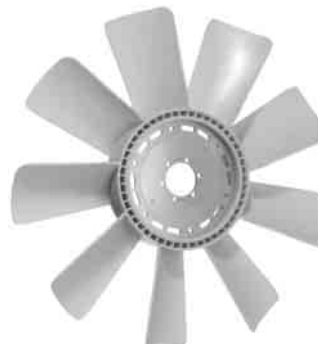
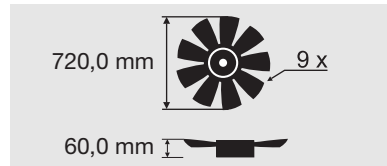

Renault 50 10 064 525



LR 027 0 720 001 027

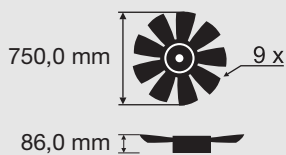

Scania 145 7385

LR 030 0 720 001 030

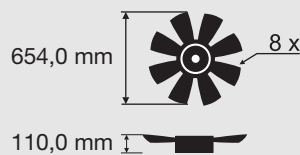

Volvo 1 437 1615

LR 028 0 720 001 028

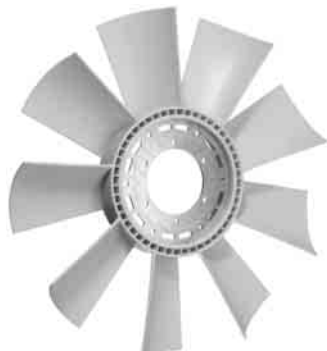
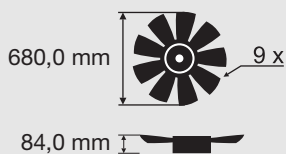

Scania 135 4981

LR 031 0 720 001 031

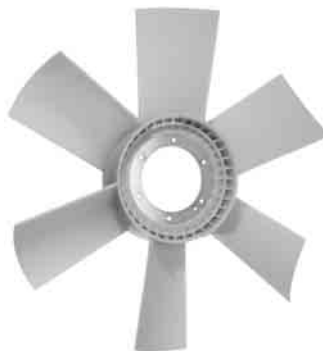
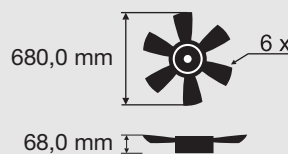

Volvo 1 674 125

LR 029 0 720 001 029

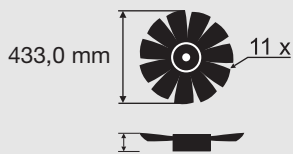

Vauxhall 911 53521

LR 032 0 720 001 032

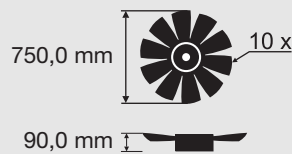

Volvo 8 149 866



LK 103
0 720 002 103



LR 033 0 720 001 033

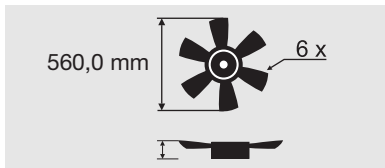

Volvo 9 516 517

LR 034 0 720 001 034

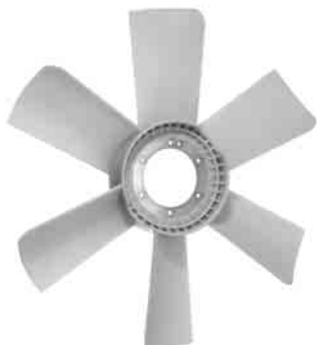
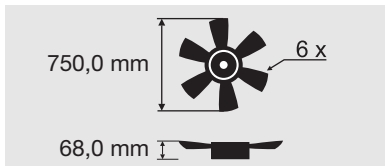

Volvo 1 674 126

LR 035 0 720 001 035

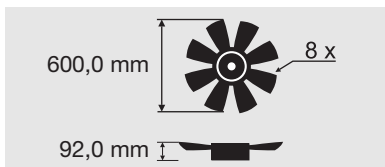

MAN 51 06601 0265



LE 001 0 720 004 001



12 V, 100 W



Audi/VW 165 959 455 L

LE 004 0 720 004 004



12 V



Audi/VW 4A0 959 455 C

LE 002 0 720 004 002



12 V, 400 W



Audi/VW 8E0 959 455 K

LE 005 0 720 004 005



12 V, 200 W

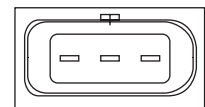

Audi/VW 1C0 959 455 C

LE 003 0 720 004 003



12 V, 250 W

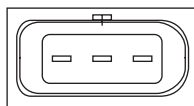

Audi/VW 1J0 959 455 D

LE 006 0 720 004 006





12 V, 300 W



Audi/VW 4A0 959 455 B



LE 007 0 720 004 007

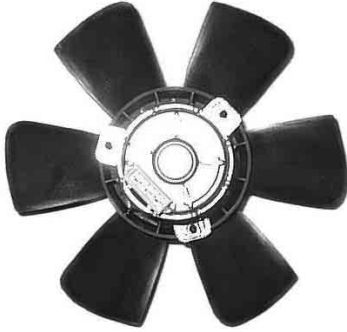

280 mm   2

12 V, 200 W



Audi/VW 165 959 455 T

LE 010 0 720 004 010

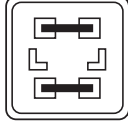

320 mm   1 

12 V, 200 W



Citroën 1253 66

LE 008 0 720 004 008



350 mm   2

12 V, 600 W



Audi/VW 443 959 455 N

LE 011 0 720 004 011

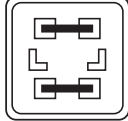

335 mm   1 

12 V, 250 W



Citroën 1250 F1

LE 009 0 720 004 009

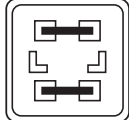

335 mm   1 

12 V, 200 W



Citroën 1250 F0

LE 012 0 720 004 012

300 mm   1 

12 V, 100 W



Ford 1654375



LE 013 0 720 004 013

303 mm



1

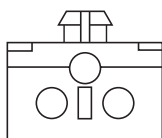

12 V, 180 W

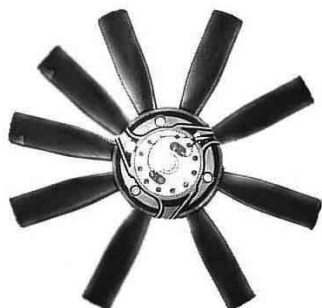

Mercedes Benz 000 500 85 93

LE 016 0 720 004 016

280 mm



1

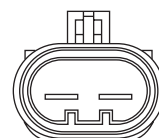

12 V, 140 W



Opel 13 41 244

LE 014 0 720 004 014

303 mm



1

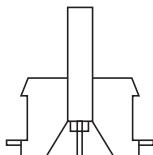

12 V, 144 W



Mercedes Benz 001 500 13 93

LE 017 0 720 004 017

390 mm



1

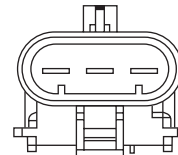

12 V, 300 W



Opel 13 41 331

LE 015 0 720 004 015

390 mm



1

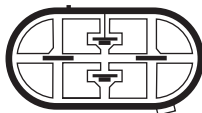

12 V, 220 W



Opel 13 41 354

LE 018 0 720 004 018

390 mm



1

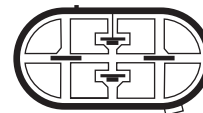

12 V, 240 W



Opel 13 41 388

**LE 019**

0 720 004 019

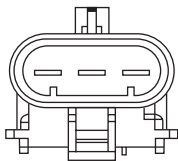
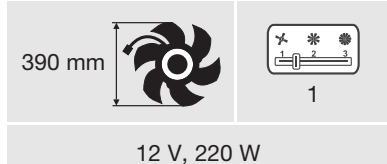

Opel 13 41 337

LE 022

0 720 004 022

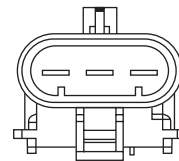
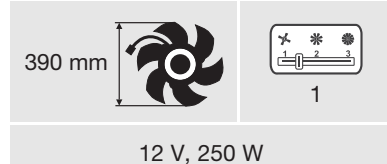

Opel 63 41 171

LE 020

0 720 004 020

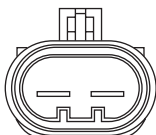
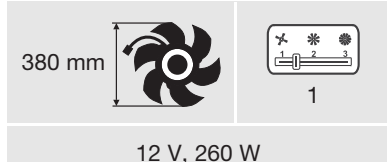

Opel 13 41 362

LE 023

0 720 004 023

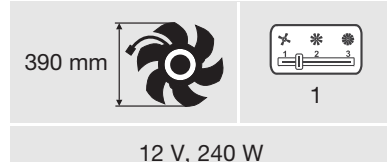

Opel 63 41 168

LE 021

0 720 004 021

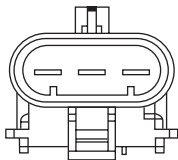
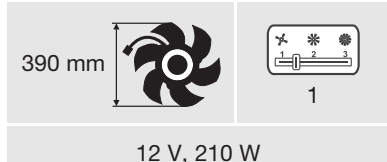

Opel 13 41 334

LE 024

0 720 004 024

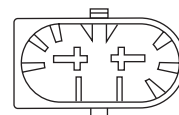
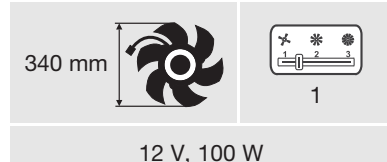
Peugeot
1253 83, 1254 79 –



LE 025 0 720 004 025

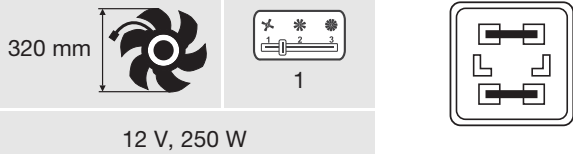

Peugeot 1253 35, 1253 54

LE 028 0 720 004 028

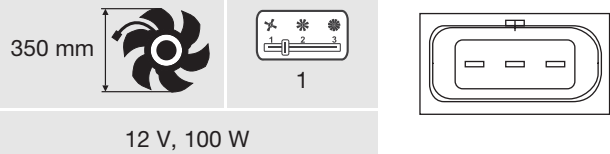

Skoda 1J0 959 455 B, VW 1J0 959 455 B

LE 026 0 720 004 026

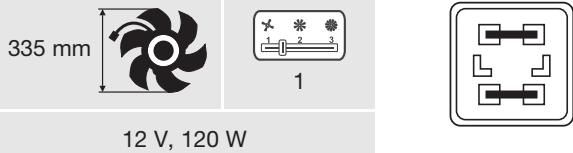

Peugeot 1250 E9, 1254 74

LE 029 0 720 004 029



VW 191 959 455 T

LE 027 0 720 004 027

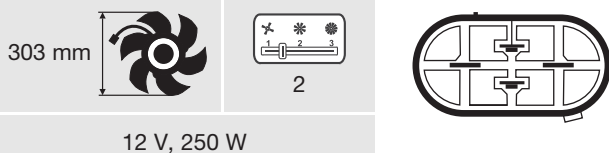

Seat 6K0 959 455 F, VW 6K0 959 455 F

LE 030 0 720 004 030

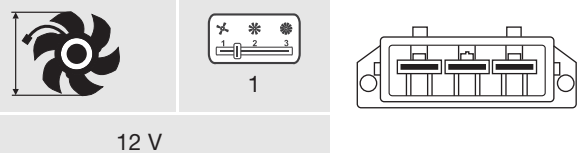

VW 6N0 959 455 A



LE 031 0 720 004 031

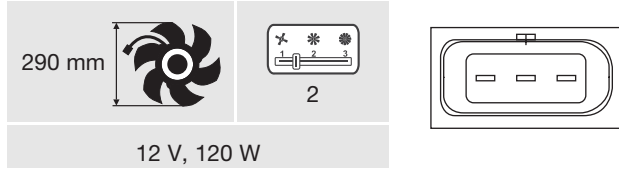

12 V, 120 W



VW 1C0 959 455 C

LE 034 0 720 004 034

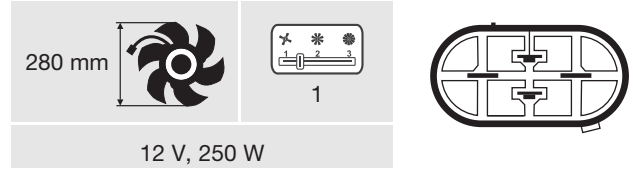

12 V, 250 W



VW 701 959 455 AE, 701 959 455 AM

LE 032 0 720 004 032

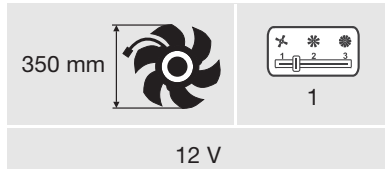

12 V



VW 3A0 959 455 B

LE 035 0 720 004 035

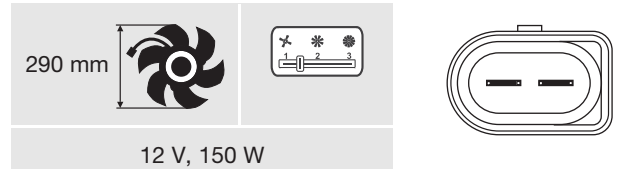

12 V, 150 W

Skoda 1K0 959 455 R, VW 1K0 959 455 R

LE 033 0 720 004 033

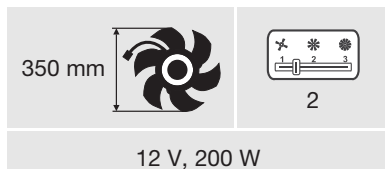

12 V, 200 W



Skoda 6N0 959 455 F, VW 6N0 959 455 F

LE 036 0 720 004 036

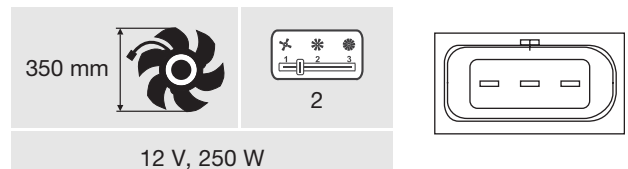

12 V, 250 W



VW 6X0 959 455, 6X0 959 455 C



LE 037 0 720 004 037

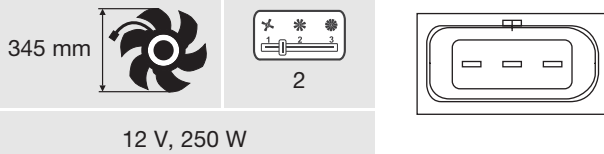

12 V, 250 W



VW 6N0 959 455 A, 6N0 959 455 G

LE 040 0 720 004 040

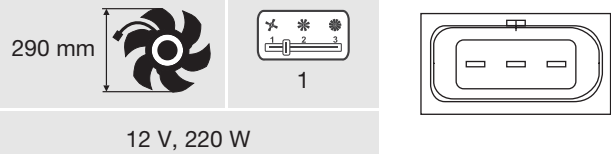

12 V, 220 W



Skoda 1J0 959 455 P, VW 1J0 959 455 P

LE 038 0 720 004 038



12 V



VW 1H0 959 455 B

LE 041 0 720 004 041



12 V, 250 W



VW 321 959 455 AM

LE 039 0 720 004 039

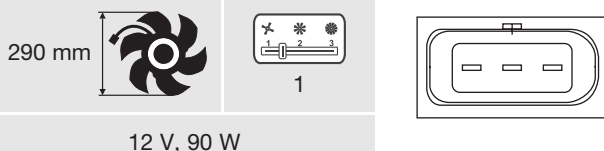

12 V, 90 W



VW 6Q0 959 455 J

LE 042 0 720 004 042



12 V, 180 W

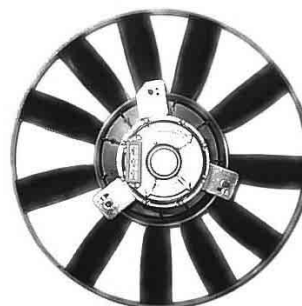

VW 1H0 959 455 J



LE 043

0 720 004 043

303 mm

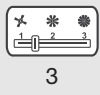

3

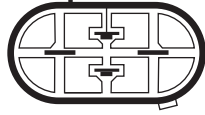

12 V, 250 W



VW 1H0 959 455 T

LE 046

0 720 004 046

360 mm

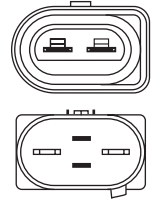
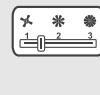

12 V, 200 W



VW 1K0 959 455 EA

LE 044

0 720 004 044

393 mm

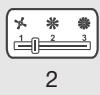

2

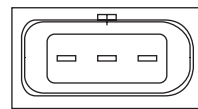

12 V, 300 W



Skoda 6Q0 959 455 AE

LE 047

0 720 004 047

360 mm

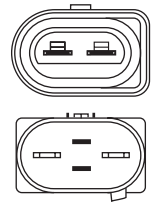
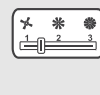

12 V, 300 W



VW 1K0 959 455 DT

LE 045

0 720 004 045

350 mm

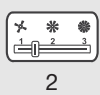

2

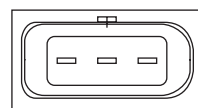

12 V, 250 W

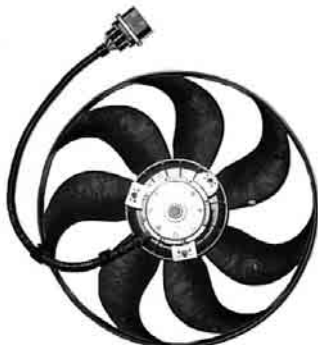

Skoda 6X0 959 455 F, VW 6X0 959 455 F

LE 048

0 720 004 048

300 mm

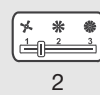

2

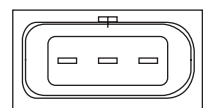

12 V, 220 W



VW 6QD 959 455 C



LE 500 0 720 004 500

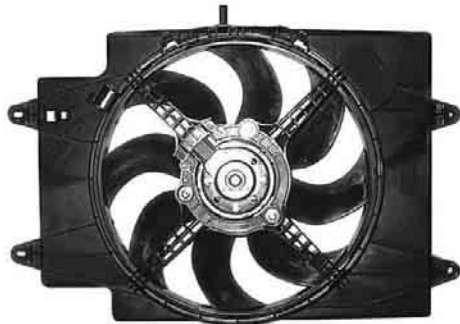
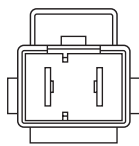
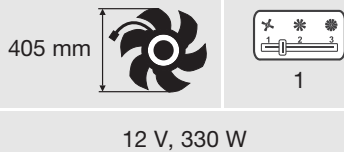

Alfa Romeo 46842844

LE 503 0 720 004 503



Audi/VW 8D0 959 455 R

LE 501 0 720 004 501

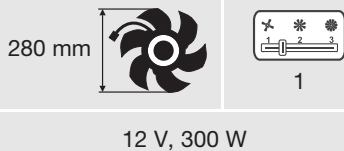

Audi/VW 8D0 959 455 J

LE 504 0 720 004 504

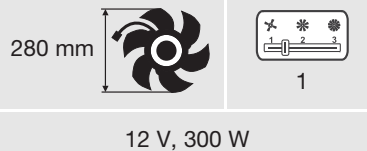

Audi/VW 8D0 959 455 D

LE 502 0 720 004 502

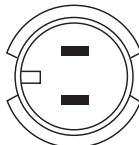
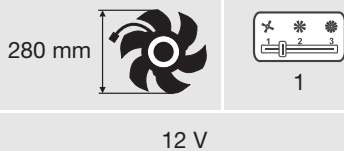

Audi/VW 8D0 959 455 C

LE 505 0 720 004 505



Audi/VW 4Z7 959 455



LE 506 0 720 004 506

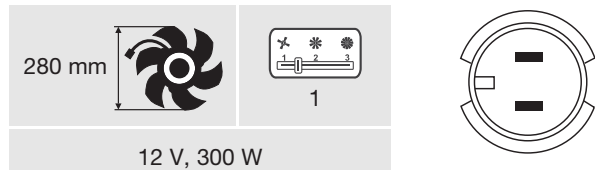

12 V, 300 W



Audi/VW 8D0 959 455 M

LE 509 0 720 004 509

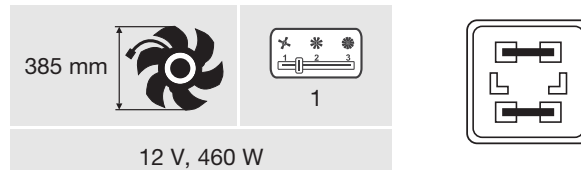

12 V, 460 W



Citroën 1253 C8

LE 507 0 720 004 507

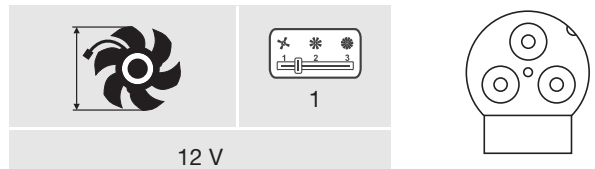

12 V



BMW 64 54 1 392 913

LE 510 0 720 004 510

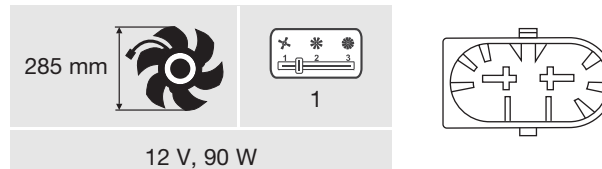

12 V, 90 W

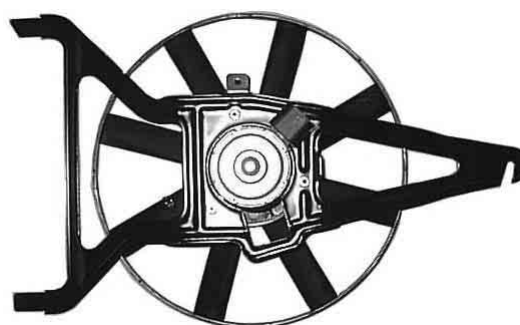

Citroën 12 53 56

LE 508 0 720 004 508

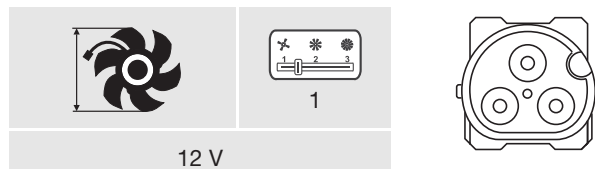

12 V

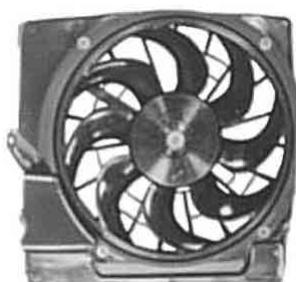

BMW 64 50 8 364 093

LE 511 0 720 004 511

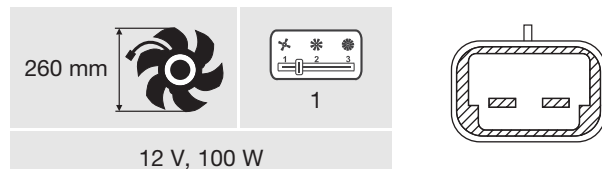

12 V, 100 W

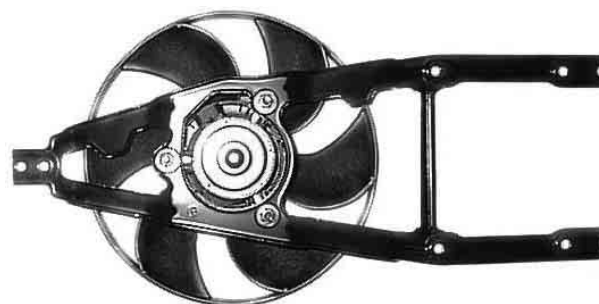

Fiat 46400256



LE 512 0 720 004 512

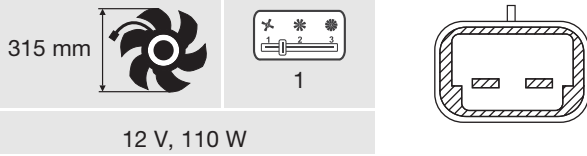

12 V, 110 W

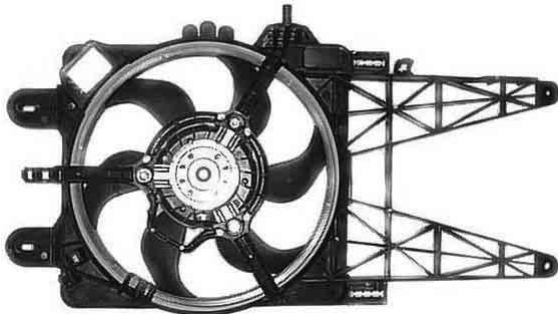

Fiat 46785738

LE 515 0 720 004 515

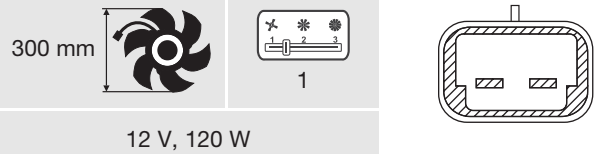

12 V, 120 W

Fiat 7741201

LE 513 0 720 004 513

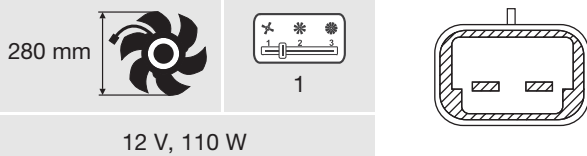

12 V, 110 W



Fiat 46789792

LE 516 0 720 004 516

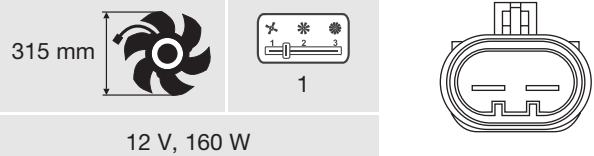

12 V, 160 W

Fiat 46745051, 46841314

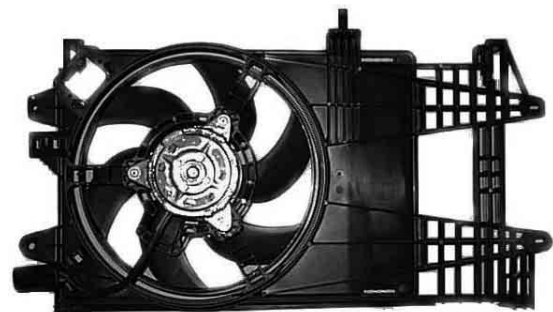

LE 514 0 720 004 514

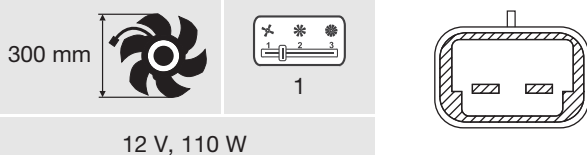

12 V, 110 W

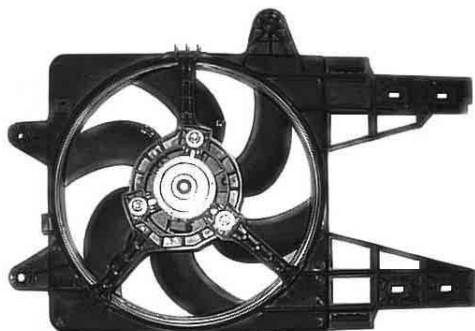

Fiat 7741200

LE 517 0 720 004 517

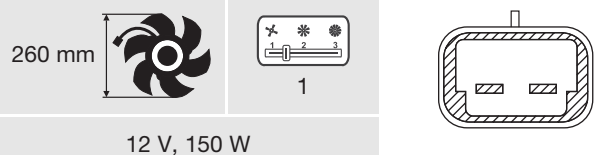

12 V, 150 W

Fiat 46540252

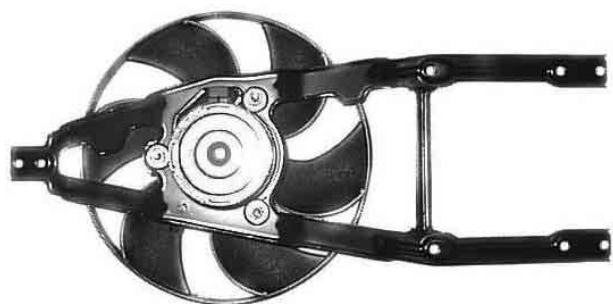



LE 518 0 720 004 518

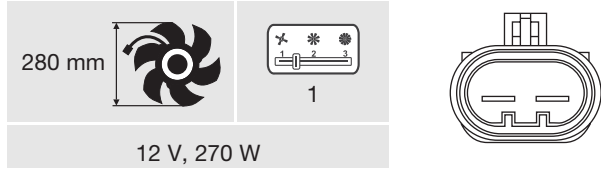

12 V, 270 W

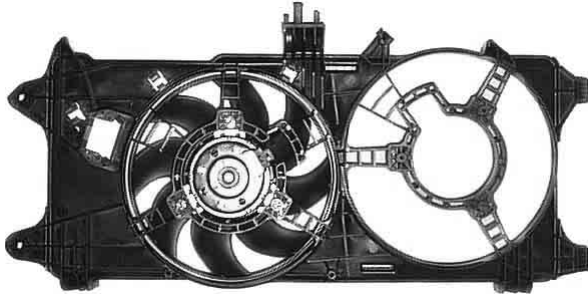

Fiat 51718487

LE 521 0 720 004 521

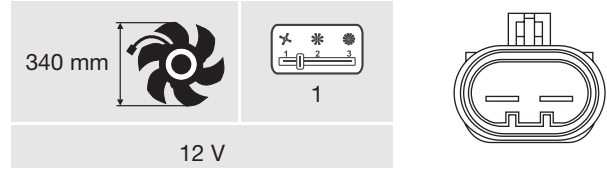

12 V

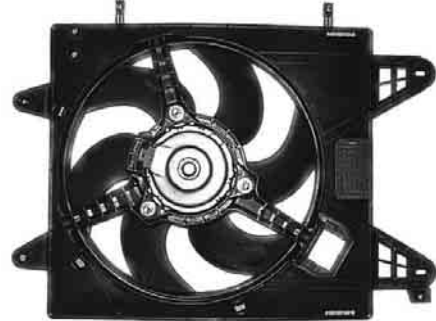

Fiat 46430980, 4653971

LE 519 0 720 004 519

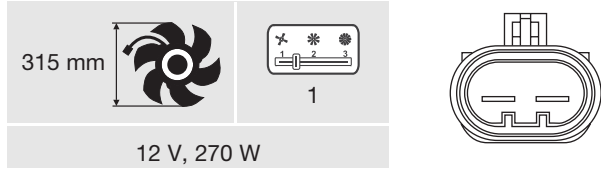

12 V, 270 W



Fiat 46723519

LE 522 0 720 004 522

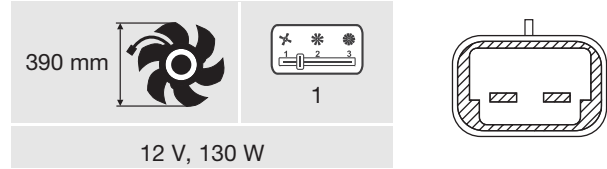

12 V, 130 W



Fiat 55700341

LE 520 0 720 004 520

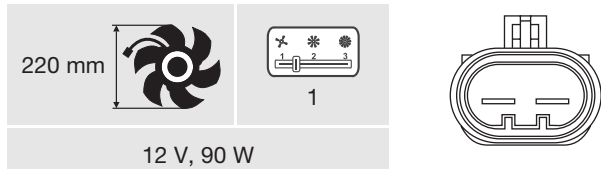

12 V, 90 W

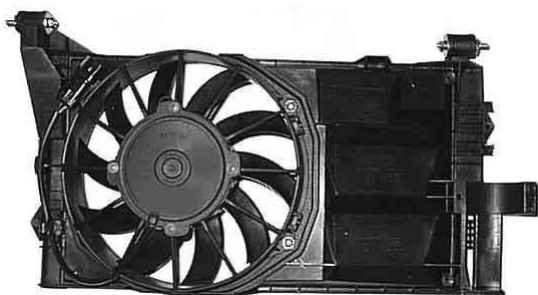

Fiat 46519308

LE 523 0 720 004 523

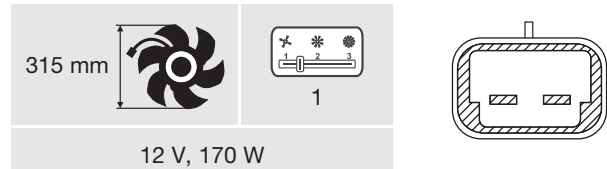

12 V, 170 W



Fiat 46723518



LE 524 0 720 004 524

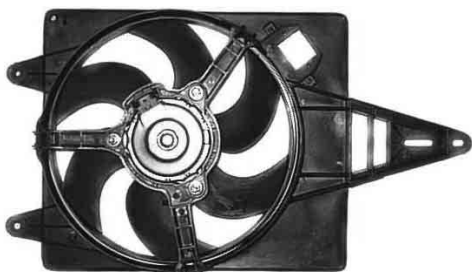
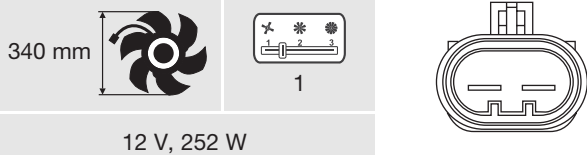

Fiat 7762666

LE 527 0 720 004 527

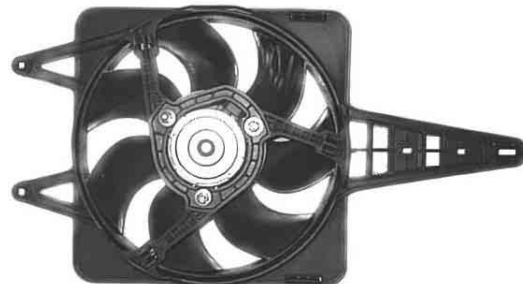
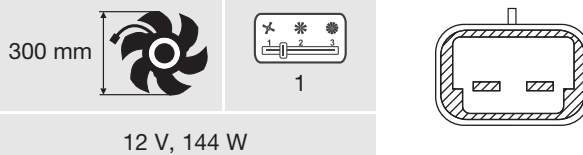

Fiat 7650190

LE 525 0 720 004 525

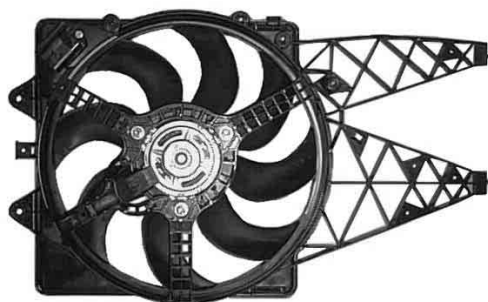
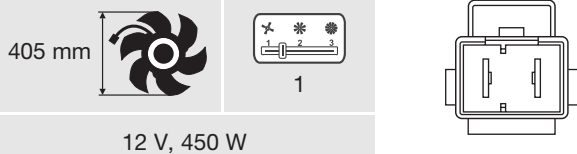

Fiat 55700342

LE 528 0 720 004 528

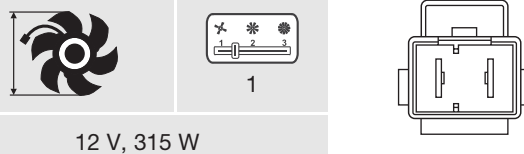

Fiat 46723520, 51729495

LE 526 0 720 004 526

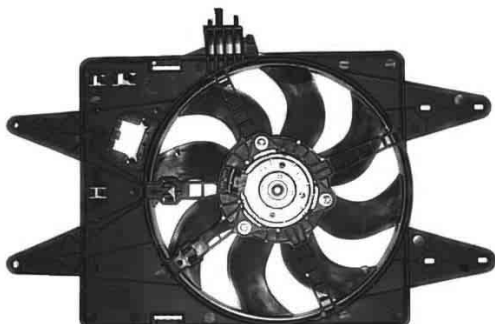
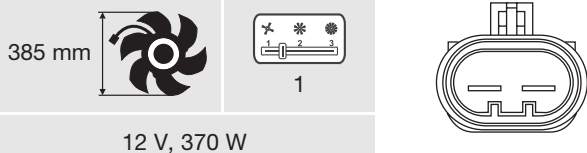

Fiat 51738798

LE 529 0 720 004 529

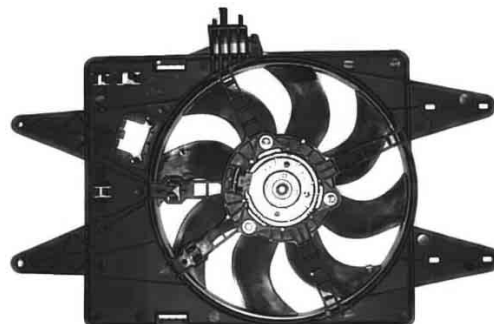
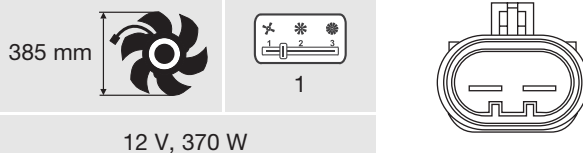

Fiat 46737733



LE 530 0 720 004 530

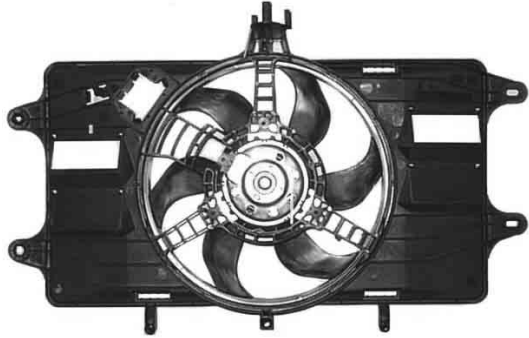
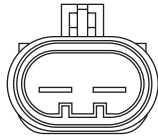
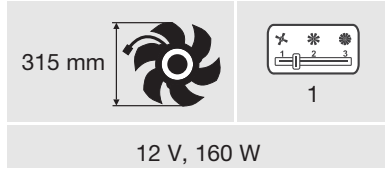

Fiat 46737732

LE 533 0 720 004 533

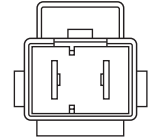
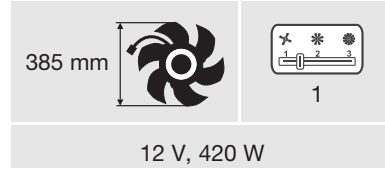

Fiat 46723521

LE 531 0 720 004 531

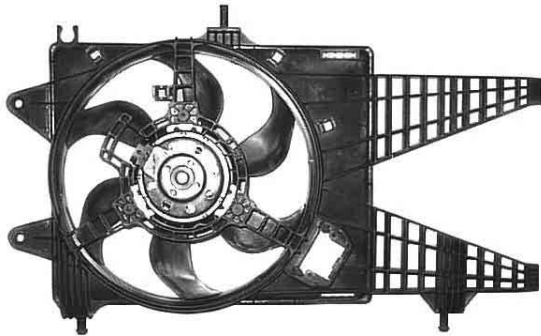
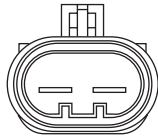
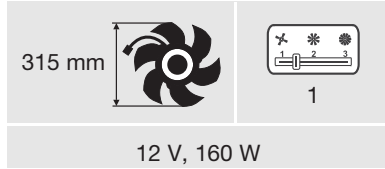

Fiat 51708004

LE 534 0 720 004 534

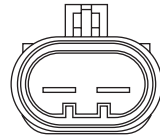
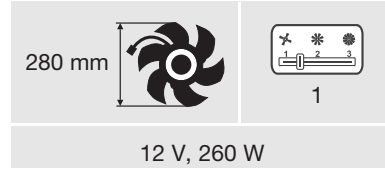

Fiat 46479804

LE 532 0 720 004 532

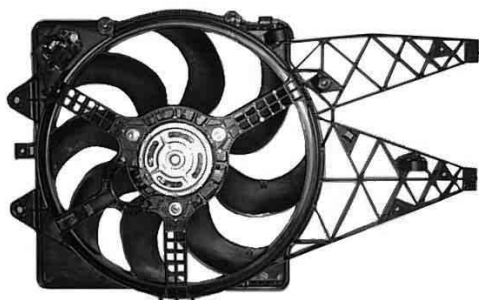
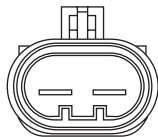

Fiat 55701372

LE 535 0 720 004 535

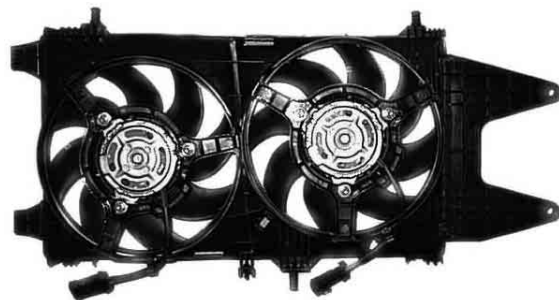
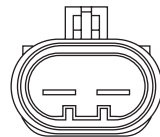
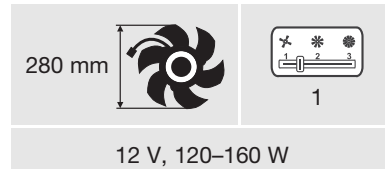

Fiat 46742536



LE 536 0 720 004 536

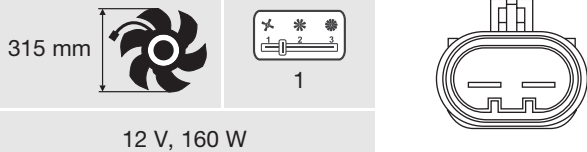

12 V, 160 W

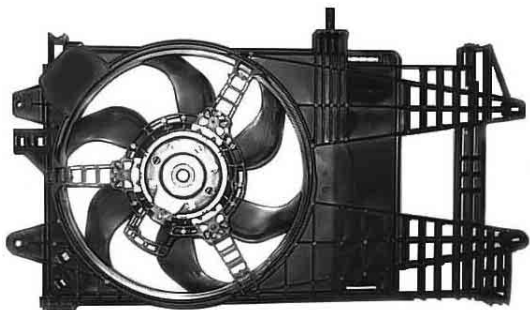

Fiat 51703066

LE 539 0 720 004 539



12 V



Hyundai 253801 7100

LE 537 0 720 004 537

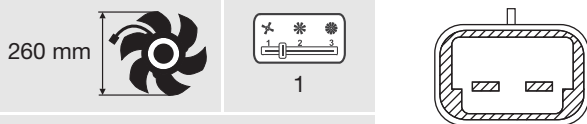

12 V, 150 W

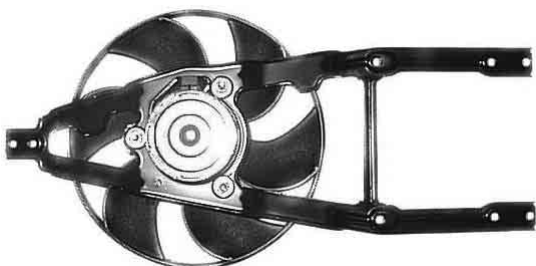

Fiat 46534674

LE 540 0 720 004 540

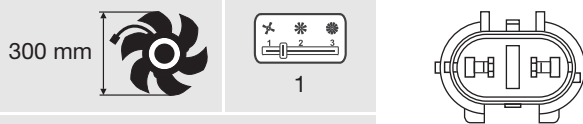

12 V, 120 W



Hyundai 253502 2000 – Zarge,
253862 2020 – Lüfter

LE 538 0 720 004 538



12 V



Hyundai 253801C 100

LE 541 0 720 004 541



12 V



Hyundai 253802 6200



LE 542 0 720 004 542

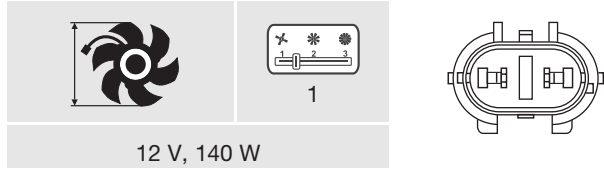

12 V, 140 W



Hyundai 253862 9000

LE 545 0 720 004 545

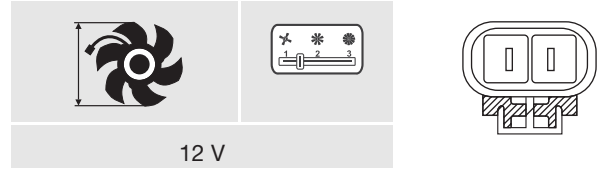

12 V



Hyundai 253802 B000

LE 543 0 720 004 543

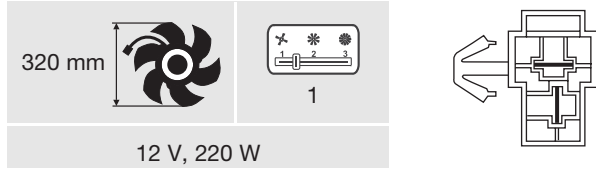

12 V, 220 W

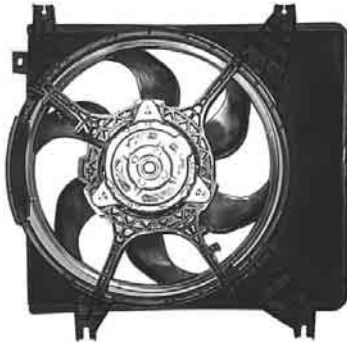

Hyundai 253800 2000

LE 546 0 720 004 546

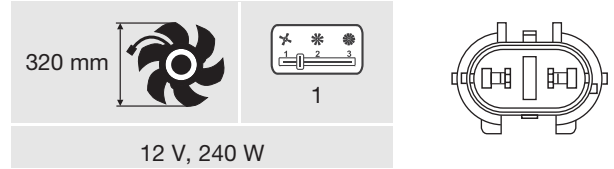

12 V, 240 W

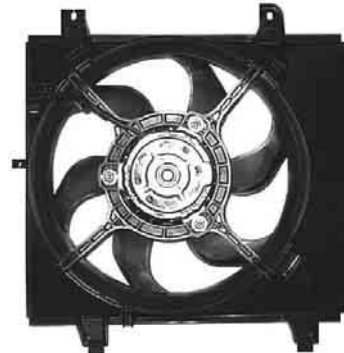

Hyundai 253801 7800

LE 544 0 720 004 544

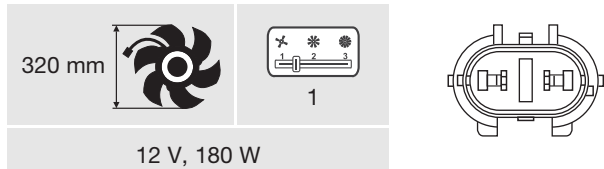

12 V, 180 W

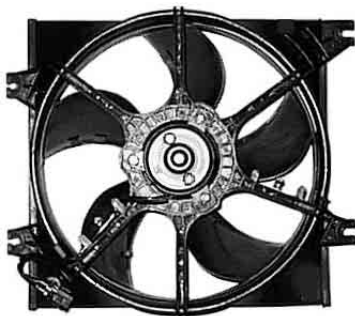

Hyundai 253802 5000

LE 547 0 720 004 547



12 V



Hyundai 253803 D180



LE 548 0 720 004 548



Kia OK 2KB 15025

LE 551 0 720 004 551

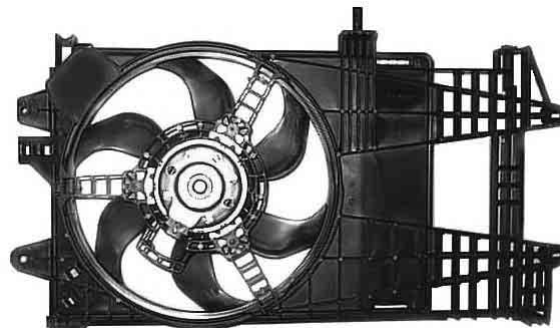
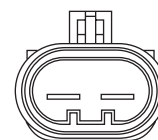
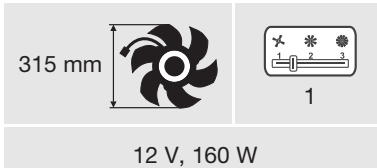

Lancia 51708405

LE 549 0 720 004 549

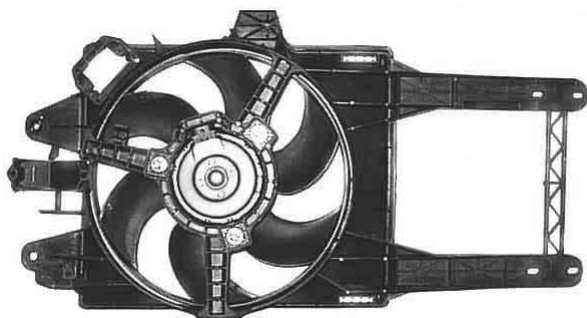
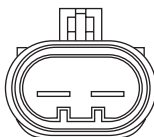
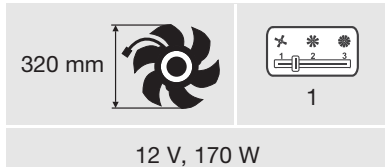

Lancia 46763323

LE 552 0 720 004 552

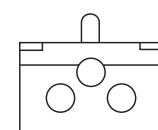

Mercedes Benz A 001 500 38 93

LE 550 0 720 004 550

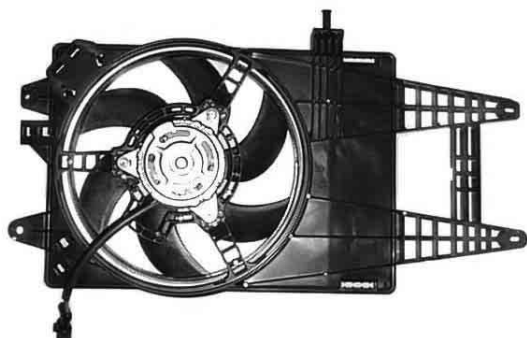
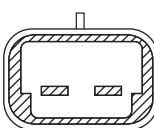
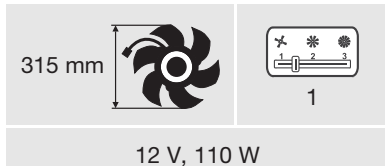

Lancia 51738357

LE 553 0 720 004 553

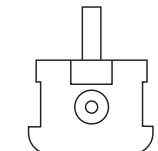
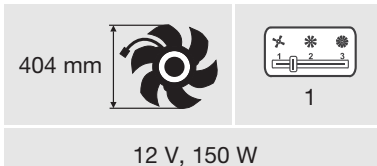

Mercedes Benz A 000 500 70 93



LE 554 0 720 004 554

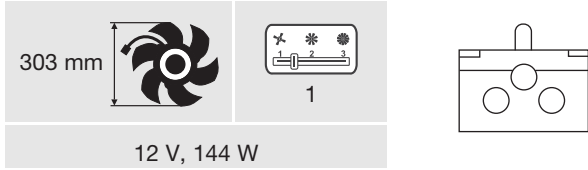

12 V, 144 W



Mercedes Benz A 001 500 12 93

LE 557 0 720 004 557

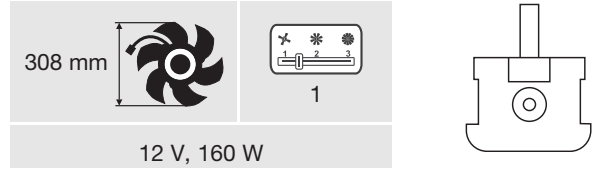

12 V, 160 W



Mercedes Benz A 000 500 60 93

LE 555 0 720 004 555

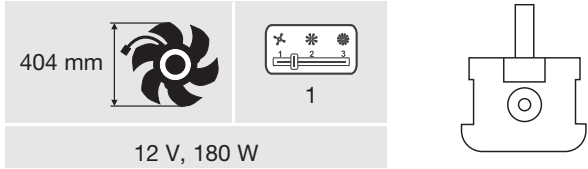

12 V, 180 W



Mercedes Benz A 000 500 50 93,
A 000 500 79 93

LE 558 0 720 004 558

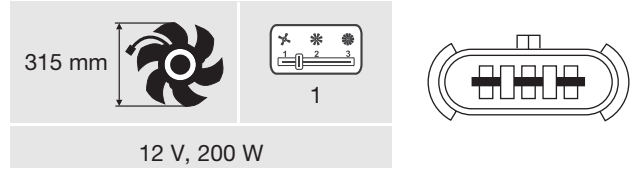

12 V, 200 W

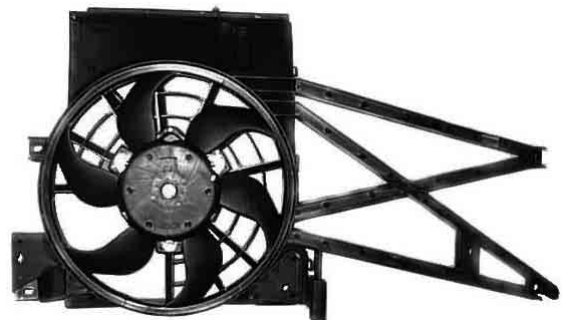

Opel 13 41 262 -

LE 556 0 720 004 556



12 V, 150 W



Mercedes Benz A 000 500 76 93

LE 559 0 720 004 559

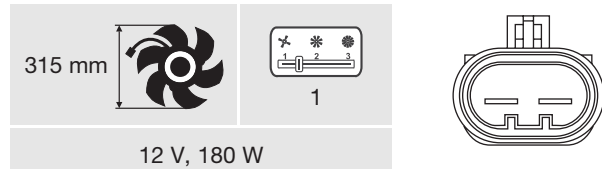

12 V, 180 W



Opel 13 41 332 - 63 41 164 -



LE 560 0 720 004 560

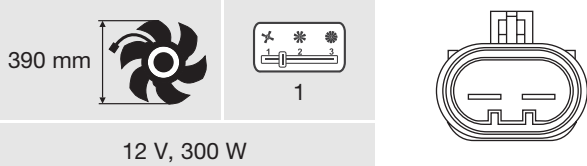

12 V, 300 W

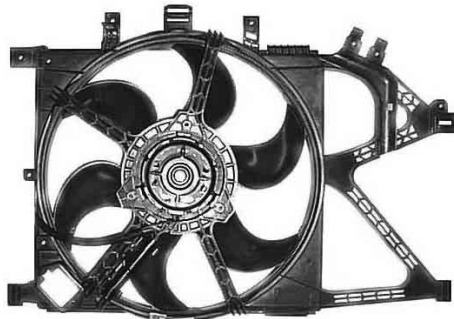

Opel 13 14 442 – , 13 41 331 – 

LE 563 0 720 004 563

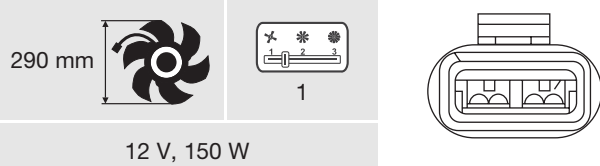

12 V, 150 W



Opel 18 45 043

LE 561 0 720 004 561

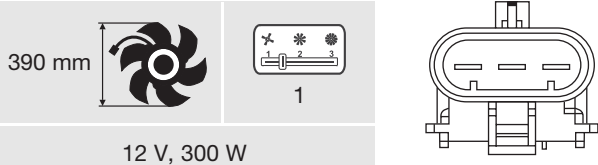

12 V, 300 W

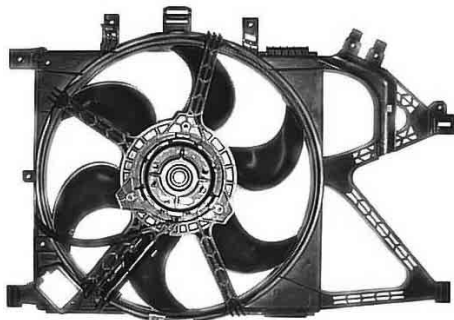

Opel 13 14 443 – , 13 41 331 – 

LE 564 0 720 004 564

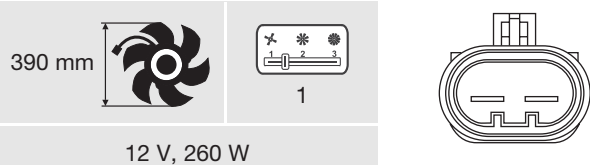

12 V, 260 W



Opel 13 41 390 – 

LE 562 0 720 004 562

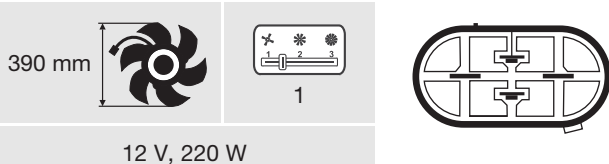

12 V, 220 W

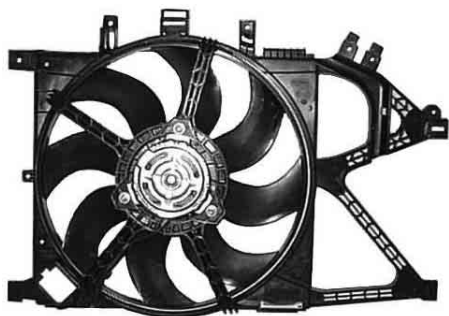

Opel 13 14 445 – , 13 41 354 – 

LE 565 0 720 004 565



12 V



Opel 13 41 390



LE 566 0 720 004 566

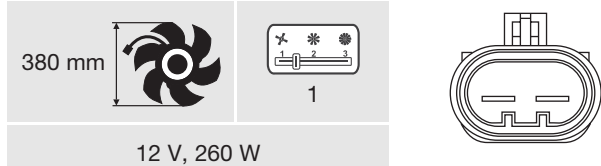

12 V, 260 W

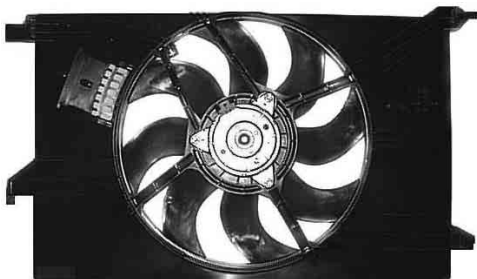

Opel 13 41 362 –

LE 571 0 720 004 571

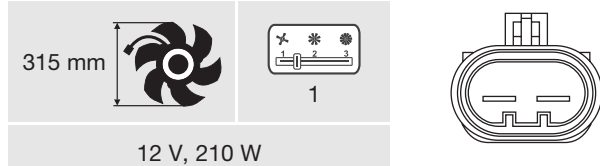

12 V, 210 W

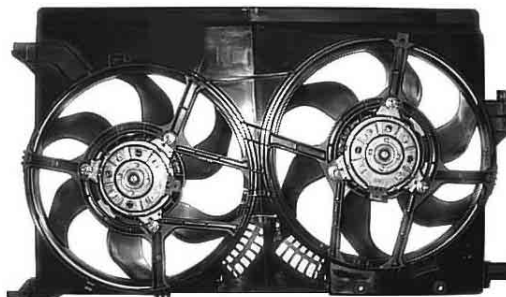

Opel 13 41 369 – , 63 41 154 –

LE 567 0 720 004 567

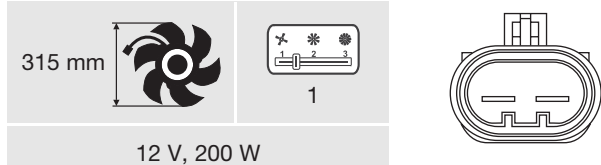

12 V, 200 W

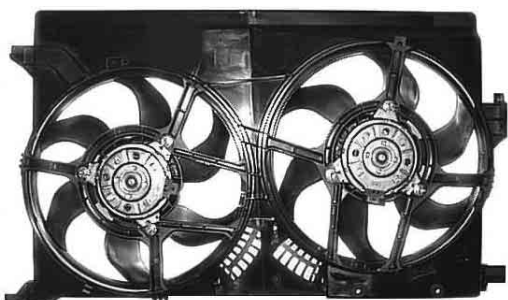

Opel 13 41 365 – , 63 41 154 –

LE 572 0 720 004 572

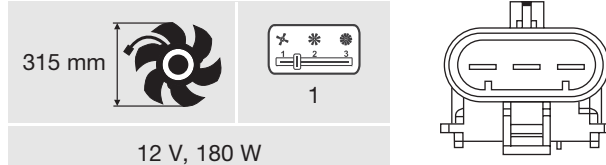

12 V, 180 W

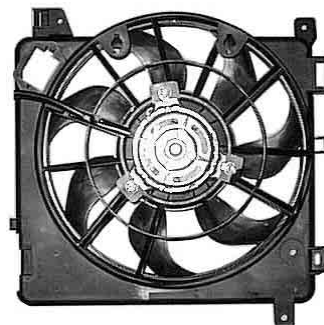

Opel 13 14 212 – , 63 41 172 –

LE 568 0 720 004 568

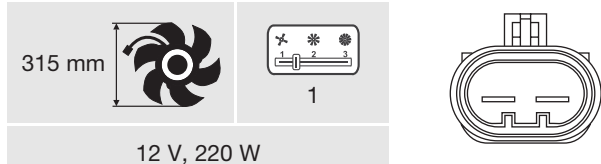

12 V, 220 W

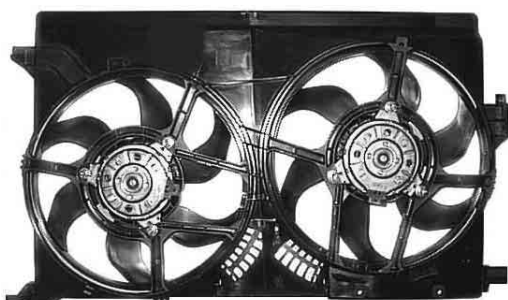

Opel 13 41 368 – , 63 41 154 –

LE 573 0 720 004 573

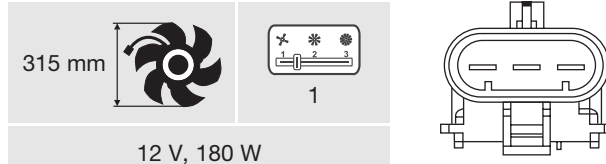

12 V, 180 W

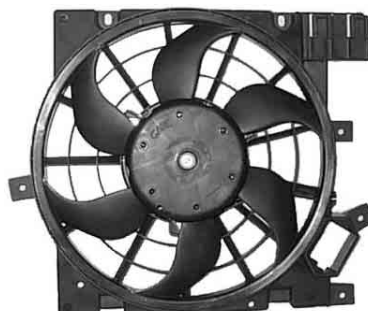

Opel 13 14 559 – , 63 41 172 –



LE 574 0 720 004 574

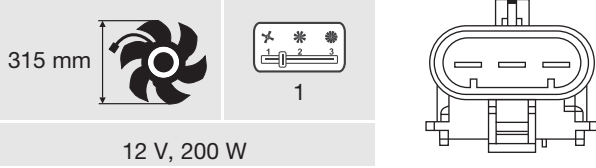

12 V, 200 W

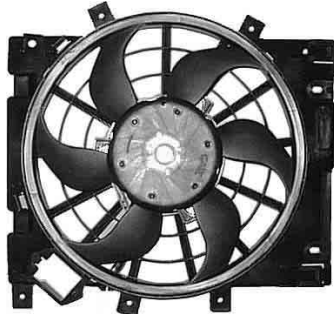

Opel 13 14 555 – , 13 41 378 – 

LE 577 0 720 004 577

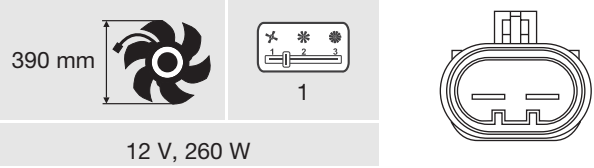

12 V, 260 W



Opel 13 41 395 – , 13 41 397 – 

LE 575 0 720 004 575

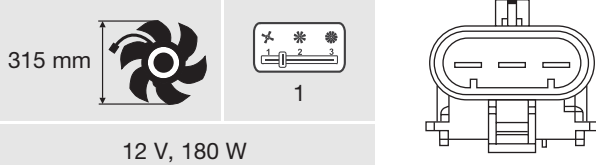

12 V, 180 W



Opel 13 14 554 – , 13 41 377 – 

LE 578 0 720 004 578

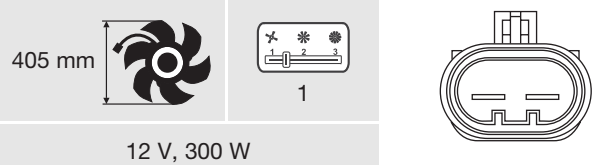

12 V, 300 W



Opel 13 41 398 – , 13 41 421 – 

LE 576 0 720 004 576

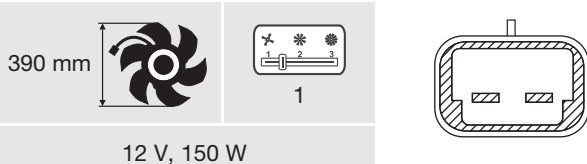

12 V, 150 W



Opel 13 41 392 – , 13 41 393 – 

LE 579 0 720 004 579

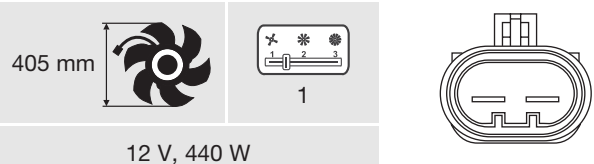

12 V, 440 W



Opel 13 41 399 – , 13 41 421 – 



LE 580 0 720 004 580

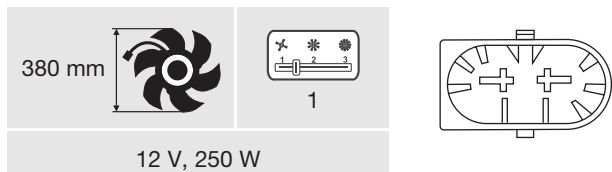

12 V, 250 W



Peugeot 1253 91

LE 583 0 720 004 583

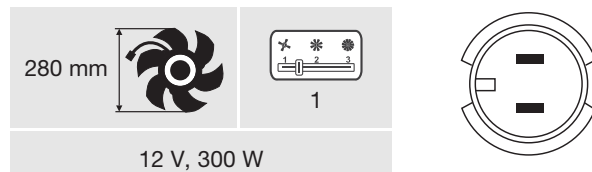

12 V, 300 W



Audi/VW 4B0 959 455

LE 581 0 720 004 581

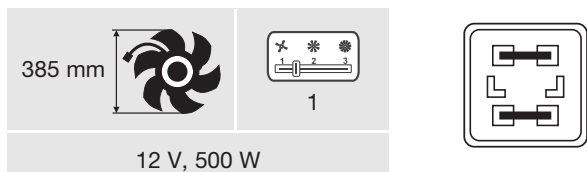

12 V, 500 W



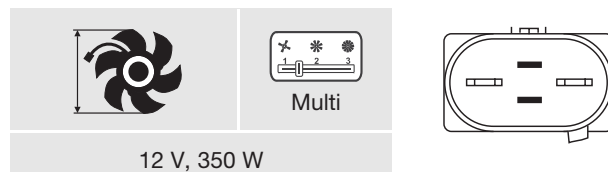

Peugeot 1250 F8

LE 584 0 720 004 584



12 V, 350 W



Seat, Skoda, Audi/VW 1K0 959 455 CQ -  1
1K0 959 455 CT -  2

LE 582 0 720 004 582

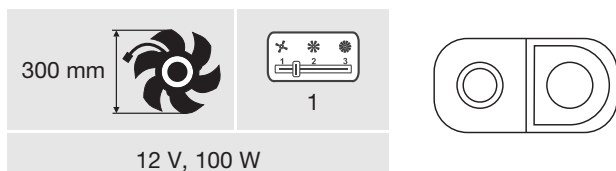

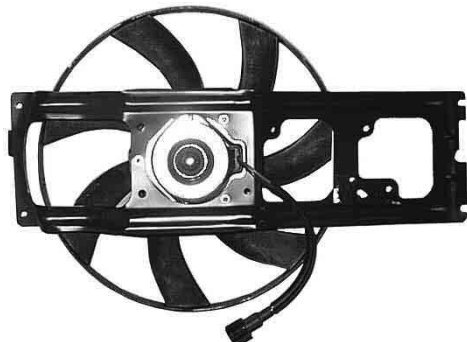

12 V, 100 W

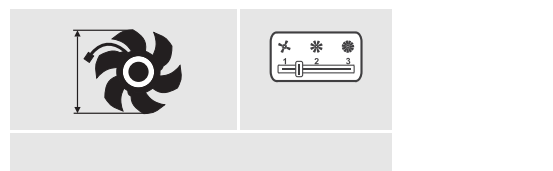

Renault 77 00 828 623

LE 585 0 720 004 585



Seat, Skoda, Audi/VW 6Q0 121 207 L - 
6Q0 959 455 AD - 

**LE 586**



0 720 004 586



Audi/VW 8D0 959 455 B, 8D0 959 455 L

LE 587

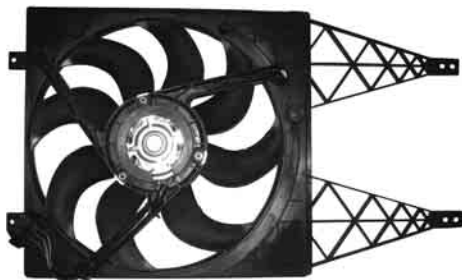
0 720 004 587

Seat, Skoda, Audi/VW 6Q0 121 207 L - 6Q0 959 455 AE - 



LE 558 Z 0 720 005 001

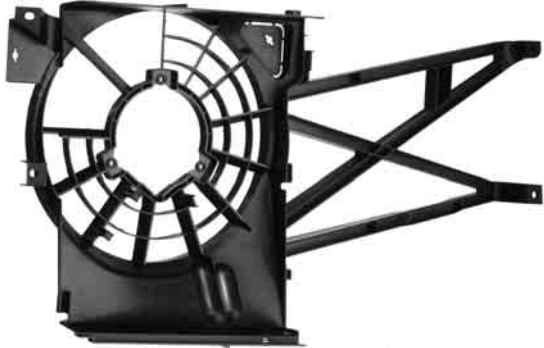

Opel 13 41 155

 **LE 558**
0 720 004 558

LE 566 Z 0 720 005 003

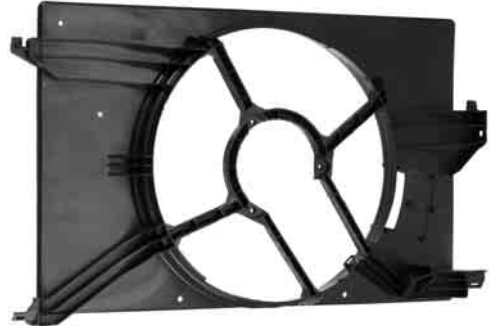

Opel 63 41 185

 **LE 566**
0 720 004 566

LE 564 Z 0 720 005 002

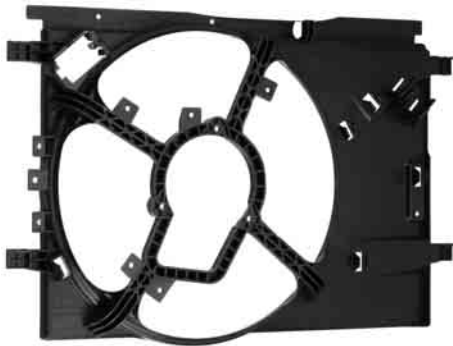

Opel 13 41 394

 **LE 564**
0 720 004 564

LE 584 Z 0 720 005 004

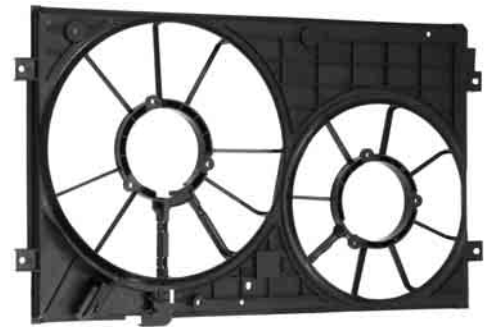

Seat 1K0 121 205,
Skoda 1K0 121 205,
Audi/VW 1K0 121 205

 **LE 584**
0 720 004 584

4SEASONS	BERU
36708	LK 053
36709	LK 041
36921	LK 079

AKS DASIS	BERU
038052N	LK 086
038560N	LK 055
058006N	LR 004
058010N	LK 012
058014N	LR 003
058040N	LK 011
058080N	LK 006
058150N	LK 007
058250N	LK 010
058430N	LK 008
058440N	LK 009
098009N	LK 014
098010N	LK 013
098012N	LK 015
098015N	LK 091
098016N	LK 017
098017N	LK 016
128001N	LK 041
128013N	LK 039
128032N	LK 040
128036N	LK 042
128037N	LK 043
128051N	LK 036
128052N	LK 037
128100N	LK 045
128120N	LK 052
128120N	LK 053
128130N	LK 035
128200N	LK 054
128260N	LK 038
128270N	LK 046
128330N	LK 047
138027N	LR 024
138032N	LR 023
138039N	LKK 017
138046N	LK 095
138046N	LK 099
138680N	LK 050
138970N	LK 049
139730N	LK 051
148030N	LK 068
148050N	LK 070
218000N	LK 079
248001N	LKK 025
258008N	LR 013
268013N	LR 036
268016N	LR 019
268034N	LK 093
268040N	LKK 010
268270N	LK 092
268280N	LK 031
268390N	LR 020
278011N	LK 100
278120N	LK 101
288005N	LK 102
288009N	LR 032
288009N	LK 103
298034N	LKK 024
378014N	LR 016
398066N	LKK 023

AKS DASIS	BERU
408046N	LR 015
408055N	LK 088
486120N	LK 004
488000N	LR 002
488007N	LR 001
488080N	LK 001
488160N	LK 002
488170N	LK 003

ALFA ROMEO	BERU
46842844	LE 500 ⁶⁾

ASHIKA	BERU
3602202	LK 080

AUDI	BERU
165 959 455 L	LE 001
165 959 455 T	LE 007
1C0 959 455 C	LE 005
1J0 959 455 D	LE 003
443 959 455 N	LE 008
4A0 121 350 B	LK 005
4A0 959 455 B	LE 006
4A0 959 455 C	LE 004
4Z7 959 455	LE 505 ⁶⁾
8D0 959 455 C	LE 502 ⁶⁾
8D0 959 455 D	LE 504 ⁶⁾
8D0 959 455 J	LE 501 ⁶⁾
8D0 959 455 M	LE 506 ⁶⁾
8D0 959 455 R	LE 503 ⁶⁾
8E0 959 455 K	LE 002

AURADIA	BERU
LRBW 002	LR 003
LRBW 003	LR 004
VKAI 002	LK 004
VKAI 003	LK 001
VKAI 004	LK 002
VKAI 005	LK 003
VKBW 004	LK 012
VKBW 005	LK 006
VKBW 006	LK 007
VKBW 007	LK 008
VKBW 008	LK 009
VKBW 009	LK 010
VKBW 010	LK 011
VKMS 002	LK 051
VKMS 004	LK 052
VKMS 004	LK 053
VKMS 006	LK 045
VKMS 007	LK 050
VKMS 400	LK 038
VKMS 401	LK 047
VKMS 402	LK 046
VKMS 403	LK 039
VKMS 404	LK 040
VKMS 406	LK 041
VKMS 407	LK 042
VKMS 408	LK 043
VKMS 409	LK 044
VKMS 411	LK 049
VKMS 412	LK 035
VKMS 413	LK 036

AURADIA	BERU
VKMS 418	LK 037
VKMS 419	LK 054
VKMT 003	LK 068
VKMT 005	LK 070
VKTO 002	LK 080

AUTOMEGA	BERU
301210350058	LK 001
301210350078A	LK 004

BEHR/HELLA	BERU
8MV 376 728-401	LK 055
8MV 376 731-491	LK 039
8MV 376 732-001	LK 037
8MV 376 732-021	LK 004
8MV 376 732-031	LK 002
8MV 376 732-041	LK 009
8MV 376 732-051	LK 049
8MV 376 732-061	LK 051
8MV 376 732-071	LK 050
8MV 376 732-101	LK 010
8MV 376 732-111	LK 011
8MV 376 732-141	LK 058
8MV 376 732-171	LK 041
8MV 376 732-211	LK 005
8MV 376 732-221	LK 001
8MV 376 732-231	LK 012
8MV 376 732-251	LK 045
8MV 376 732-261	LK 052
8MV 376 732-301	LK 053
8MV 376 732-321	LK 006
8MV 376 732-331	LK 035
8MV 376 732-351	LK 054
8MV 376 732-401	LK 007
8MV 376 732-441	LK 008
8MV 376 733-011	LK 038
8MV 376 733-031	LK 003
8MV 376 733-041	LK 042
8MV 376 733-051	LK 040
8MV 376 733-061	LK 044

BMW	BERU
1 712 058	LR 003
1 712 110	LR 004
1 740 962	LK 012
11 52 1 712 058	LR 003
11 52 1 712 110	LR 004
11 52 1 740 962	LK 012
11 52 2 241 505	LK 006
11 52 2 245 498	LK 007
11 52 2 246 042	LK 008
11 52 2 249 216	LK 009
11 52 7 502 804	LK 010
11 52 7 505 302	LK 011
2 241 505	LK 006
2 245 498	LK 007
2 246 042	LK 008
2 249 216	LK 009
64 50 8 364 093	LE 508 ⁶⁾
64 54 1 392 913	LE 507 ⁶⁾
7 502 804	LK 010
7 505 302	LK 011



BUGIAD	BERU
BFC 001	LK 001
BFC 004	LK 012
BFC 007	LK 038
BFC 008	LK 046
BFC 014	LK 041
BFC 015	LK 050
BFC 016	LK 037
BFC 016	LK 052
BFC 016	LK 053
BFC 017	LK 002
BFC 025	LK 017
BFC 026	LK 091
BFC 027	LK 007
BFC 029	LK 047
BFC 035	LK 051
BFC 036	LK 015
BFC 037	LK 014
BFC 038	LK 016
BFC 042	LK 044
BFC 043	LK 039
BFC 044	LK 040
BFC 045	LK 042
BFC 047	LK 043
BFC 049	LK 036
BFC 068	LK 004
BFC 069	LKK 025
BFC 070	LK 009
BFC 071	LK 013
BFC 074	LK 011
BFC 075	LK 054
BFC 077	LK 010
BFC 079	LK 035
BFC 081	LK 026
BFC 089	LK 049
BFC 095	LKK 012

CITROËN	BERU
1250 F0	LE 009
1250 F1	LE 011
1253 56	LE 510 ⁶⁾
1253 66	LE 010
1253 C8	LE 509 ⁶⁾

DELPHI	BERU
WP 2121	LK 079

DEUTZ	BERU
0425 3784 EZ	LK 089
0425 3785 EZ	LK 090
312 514	LR 012

DT	BERU
1.11106	LK 100
1.11320	LKK 024
1.11330	LK 101
2.15502	LR 031
2.15506	LR 034
2.15507	LR 032
2.15517	LR 033
2.15530	LK 103
3.15203	LR 020
3.15220	LK 092

DT	BERU
3.15221	LK 094
4.61707	LR 023

FEBI	BERU
15509	LK 045
17798	LK 001
17846	LK 053
17847	LK 054
17848	LK 038
17853	LK 041
17854	LK 044
17855	LK 046
17879	LK 042
17995	LK 052
17996	LK 043
18000	LK 047
18002	LK 039
18678	LK 012
18679	LK 007
18681	LK 010
18683	LK 011
18684	LK 008
18685	LK 009
18857	LK 051
19056	LK 050
19256	LR 003
19257	LR 004
19660	LK 015
19661	LK 014
19661	LK 016
22978	LK 035
23013	LK 055
23141	LR 009
23157	LK 049
23538	LKK 025
24722	LK 002
26205	LK 092
26206	LR 020
26565	LR 002
27521	LR 007
31001	LK 094
31457	LK 099

FIAT	BERU
7650190	LE 527 ⁶⁾
7741200	LE 514 ⁶⁾
7741201	LE 515 ⁶⁾
7762666	LE 524 ⁶⁾
46400256	LE 511 ⁶⁾
46430980	LE 521 ⁶⁾
46479804	LE 534 ⁶⁾
46519308	LE 520 ⁶⁾
46534674	LE 537 ⁶⁾
46539871	LE 521 ⁶⁾
46540252	LE 517 ⁶⁾
46723518	LE 523 ⁶⁾
46723519	LE 519 ⁶⁾
46723520	LE 528 ⁶⁾
46723521	LE 533 ⁶⁾
46737732	LE 530 ⁶⁾
46737733	LE 529 ⁶⁾
46742536	LE 535 ⁶⁾
46745051	LE 516 ⁶⁾
46785738	LE 512 ⁶⁾

FIAT	BERU
46789792	LE 513 ⁶⁾
46841314	LE 516 ⁶⁾
51703066	LE 536 ⁶⁾
51708004	LE 531 ⁶⁾
51718487	LE 518 ⁶⁾
51729495	LE 528 ⁶⁾
51738798	LE 526 ⁶⁾
55700341	LE 522 ⁶⁾
55700342	LE 525 ⁶⁾
55701372	LE 532 ⁶⁾

FORD	BERU
1063042	LK 015
01105276	LK 016
1654375	LE 012
04406277	LKK 001
6080770	LK 013
6707917	LK 014
1 436 157	LKK 012
1 591 125	LK 091
2C 11 8C617 BA	LKK 001
3C 46 8C617 BA	LKK 013
6C 11 8C617 CA	LKK 012
7 101 785	LR 013
79 BB 8A616 A1C	LK 091
79 GB 8A616 A1C	LK 013
88 VB 8A616 AA	LK 017
91 CT 8A616 BA	LK 018
92 VB 8A616 BA	LK 014
95 VB 8600 BA	LR 013
98 VB 8A616 BC	LK 016
98 VB 8A616 CA	LK 015

GERI	BERU
11650	LK 055
951257	LR 004
958068	LR 002
958070	LK 004
958077	LK 011
958078	LK 010
958079	LK 012
958083	LK 002
958085	LK 006
958086	LK 007
958099	LK 047
958101	LK 039
958159	LK 041
958160	LK 052
958162	LK 042
958163	LK 044
958164	LK 036
958165	LK 038
958166	LK 046
958167	LK 043
958171	LK 040
958172	LK 058
958173	LK 053
958174	LK 035
958175	LK 054
958218	LK 002
958219	LK 003
958220	LK 011
958221	LK 050
958230	LK 008

GERI	BERU
958231	LK 009
958233	LK 015
958281	LK 001
958282	LK 012
958284	LK 051
958286	LK 045
958290	LK 037
958297	LK 014
958297	LK 016
958298	LK 016

HELLA	BERU
8EW 009 144-301	LE 008
8EW 009 144-321	LE 004
8EW 009 144-331	LE 006
8EW 009 144-351	LE 502 ⁶⁾
8EW 009 144-351	LE 583 ⁶⁾
8EW 009 144-361	LE 504 ⁶⁾
8EW 009 144-381	LE 001
8EW 009 144-391	LE 007
8EW 009 144-401	LE 041
8EW 009 144-451	LE 036
8EW 009 144-461	LE 029
8EW 009 144-471	LE 038
8EW 009 144-501	LE 042
8EW 009 144-511	LE 032
8EW 009 144-531	LE 033
8EW 009 144-541	LE 027
8EW 009 144-551	LE 043
8EW 009 144-581	LE 028
8EW 009 144-591	LE 003
8EW 009 144-601	LE 005
8EW 009 144-601	LE 031
8EW 009 144-611	LE 030
8EW 009 144-701	LE 557
8EW 009 144-711	LE 555
8EW 009 144-731	LE 553 ⁶⁾
8EW 009 144-741	LE 013
8EW 009 144-751	LE 556 ⁶⁾
8EW 009 157-001	LE 034
8EW 009 157-311	LE 563 ⁶⁾
8EW 009 158 731	LE 552 ⁶⁾
8EW 009 158-201	LE 527 ⁶⁾
8EW 009 158-241	LE 514 ⁶⁾
8EW 009 158-541	LE 582 ⁶⁾
8EW 009 158-701	LE 016
8EW 009 158-711	LE 508 ⁶⁾
8EW 009 158-721	LE 507 ⁶⁾
8EW 009 158-751	LE 554
8EW 009 158-761	LE 014
8EW 351 034-281	LE 564 ⁶⁾
8EW 351 034-291	LE 577 ⁶⁾
8EW 351 034-431	LE 017
8EW 351 034-441	LE 576 ⁶⁾
8EW 351 034-451	LE 544 ⁶⁾
8EW 351 034-461	LE 546 ⁶⁾
8EW 351 034-471	LE 547 ⁶⁾
8EW 351 034-481	LE 539 ⁶⁾
8EW 351 034-651	LE 543 ⁶⁾
8EW 351 034-661	LE 538 ⁶⁾
8EW 351 034-671	LE 540 ⁶⁾
8EW 351 034-681	LE 542 ⁶⁾

HELLA	BERU
8EW 351 034-711	LE 541 ⁶⁾
8EW 351 034-721	LE 545 ⁶⁾
8EW 351 034-751	LE 548 ⁶⁾
8EW 351 039-431	LE 521 ⁶⁾
8EW 351 039-441	LE 535 ⁶⁾
8EW 351 039-461	LE 530 ⁶⁾
8EW 351 039-481	LE 529 ⁶⁾
8EW 351 039-501	LE 549 ⁶⁾
8EW 351 039-521	LE 524 ⁶⁾
8EW 351 039-531	LE 523 ⁶⁾
8EW 351 039-541	LE 519 ⁶⁾
8EW 351 039-551	LE 528 ⁶⁾
8EW 351 039-561	LE 533 ⁶⁾
8EW 351 039-571	LE 518 ⁶⁾
8EW 351 039-581	LE 516 ⁶⁾
8EW 351 039-591	LE 536 ⁶⁾
8EW 351 039-601	LE 534 ⁶⁾
8EW 351 039-611	LE 526 ⁶⁾
8EW 351 039-621	LE 500 ⁶⁾
8EW 351 039-631	LE 520 ⁶⁾
8EW 351 039-641	LE 551 ⁶⁾
8EW 351 039-651	LE 531 ⁶⁾
8EW 351 039-661	LE 550 ⁶⁾
8EW 351 039-671	LE 525 ⁶⁾
8EW 351 039-681	LE 532 ⁶⁾
8EW 351 039-711	LE 018
8EW 351 039-731	LE 015
8EW 351 039-741	LE 019
8EW 351 040-371	LE 039
8EW 351 040-381	LE 585 ⁶⁾
8EW 351 040-391	LE 035
8EW 351 040-401	LE 047
8EW 376 729-641	LE 522 ⁶⁾

HYUNDAI	BERU
2535022000 ⁵⁾	LE 540 ⁶⁾
2538622020 ⁴⁾	LE 540 ⁶⁾
253800 2000	LE 543 ⁶⁾
253801 7100	LE 539 ⁶⁾
253801 7800	LE 546 ⁶⁾
253801C 100	LE 538 ⁶⁾
253802 5000	LE 544 ⁶⁾
253802 6200	LE 541 ⁶⁾
253802 B000	LE 545 ⁶⁾
253803 D180	LE 547 ⁶⁾
253862 9000	LE 542 ⁶⁾

IVECO	BERU
41213626	LKK 014
41213991	LK 019
94338027	LK 088
98468660	LK 088
504029738	LK 020
504123949	LKK 005
5040 26023	LR 015
5040 29737	LR 014

JAPANPARTS	BERU
VC 202	LK 080

JP GROUP	BERU
121088002	LR 002
121088003	LK 001
121114004	LKK 025
121118004	LK 004
121118006	LR 001

JWP	BERU
TW 2195	LK 081
TW 2195	LK 082

KIA	BERU
OK 2KB 15025	LE 548 ⁶⁾

KÜHLER SCHNEIDER	BERU
0380011	LK 041
0380131	LK 039
0380321	LK 040
0380361	LK 042
0380371	LK 043
0380381	LK 044
0380511	LK 036
0380521	LK 037
0381001	LK 045
0381201	LK 053
0381301	LK 035
0382001	LK 054
0382601	LK 038
0382701	LK 046
0383301	LK 047
0485601	LK 055
0485602	LK 055
0486401	LK 055
0486801	LK 050
0489701	LK 049
0497301	LK 051
0580301	LK 068
0580501	LK 070
1480061	LR 004
1480101	LK 012
1480141	LR 003
1480401	LK 011
1480801	LK 006
1481501	LK 007
1482501	LK 010
1484301	LK 008
1484401	LK 009
1880091	LK 014
1880101	LK 013
1880121	LK 015
1880161	LK 017
1880171	LK 016
3280001	LK 079
3280101	LK 080
3782801	LK 031
5061201	LK 004
5080001	LR 002
5080801	LK 001
5081601	LK 002
5081701	LK 003

LANCIA	BERU
46763323	LE 549 ⁶⁾
51708405	LE 551 ⁶⁾
51738357	LE 550 ⁶⁾
51738360	LE 551 ⁶⁾

LANDROVER	BERU
ERR 2266	LK 022
ERR 2789	LR 005
ERR 3439	LR 016
ERR 3443	LK 027
ERR 4960	LR 006
ERR 4996	LK 023
ETC 1260	LK 024
ETC 7238	LK 026
PGG 101 290	LKK 002
PGG 500 340	LKK 015

MAGNETI MARELLI	BERU
069422204010	LE 511 ⁶⁾

MAN	BERU
11 07190 8	LR 018
51 06600 7015	LKK 007
51 06600 7024	LKK 006
51 06600 7025	LKK 010
51 06600 7045	LKK 007
51 06600 7046	LKK 006
51 06601 0256	LR 020
51 06601 0257 A	LR 018
51 06601 0258	LR 017
51 06601 0265	LR 036
51 06601 0266	LR 008
51 06601 0275	LR 007
51 06601 0279	LR 019
51 06601 0283	LR 021
51 06601 7011	LKK 004
51 06630 0037	LK 021
51 06630 0060	LK 092
51 06630 0067	LK 031
51 06630 0068	LK 094
51 06630 0071	LK 032
51 06630 0096	LK 030
51 06630 0106	LK 028
51 06630 0107	LK 029
51 06630 0119	LK 093
51 06630 0129	LK 030
51 06630 0130	LK 028
51 06630 0131	LK 029

MERCEDES BENZ	BERU
000 200 30 22	LK 056
000 200 33 20	LK 055
000 200 35 22	LK 055
000 200 37 22	LK 050
000 200 40 22	LK 057
000 200 42 22	LK 055
000 200 43 22	LK 055
000 200 47 22	LK 055
000 200 51 22	LK 051
000 200 70 22	LK 055

MERCEDES BENZ	BERU
000 200 71 22	LK 055
000 200 81 22	LK 055
000 500 50 93	LE 555
000 500 60 93	LE 557
000 500 70 93	LE 553 ⁶⁾
000 500 76 93	LE 556 ⁶⁾
000 500 79 93	LE 555
000 500 85 93	LE 013
001 500 12 93	LE 554
001 500 13 93	LE 014
001 500 38 93	LE 552 ⁶⁾
102 200 02 22	LK 059
103 200 02 22	LK 052
103 200 04 22	LK 053
103 200 05 22	LK 035
103 200 06 22	LK 054
103 200 09 22	LK 036
104 200 01 22	LK 037
111 200 04 22	LK 038
112 200 01 22	LK 060
112 200 02 22	LK 039
116 200 05 22	LK 040
116 200 06 22	LK 058
116 200 11 22	LK 041
119 200 00 22	LK 042
119 200 01 22	LK 043
120 200 01 22	LK 044
366 200 46 23	LR 023
437 500 00 22	LK 096
541 200 09 22	LK 086
541 200 13 22	LK 086
541 200 16 22	LK 086
541 205 00 06	LR 010
603 200 00 22	LK 045
604 200 00 22	LK 046
606 200 01 22	LK 047
904 200 05 23	A 904 200 05 23
904 200 06 22	A 904 200 06 22
904 200 06 22	A 904 200 08 22
904 200 08 22	A 904 200 10 23
904 200 10 23	A 904 200 11 22
904 200 11 22	A 904 205 04 06
904 205 04 06	A 906 200 06 22
906 200 06 22	A 906 200 08 23
906 200 08 23	A 906 200 09 22
906 200 09 22	A 906 200 09 23
906 200 09 23	A 906 205 01 06
906 205 01 06	A 906 205 06 06
906 205 06 06	A 906 205 08 06
906 205 08 06	
A 000 200 30 22	LK 047
A 000 200 33 20	LK 047
A 000 200 35 22	LK 047
A 000 200 37 22	LK 047
A 000 200 40 22	LK 047
A 000 200 42 22	LK 047
A 000 200 43 22	LK 047
A 000 200 47 22	LK 047
A 000 200 51 22	LK 047
A 000 200 70 22	LK 047
A 000 200 71 22	LK 047
A 000 200 81 22	LK 047
A 000 500 50 93	LE 555
A 000 500 60 93	LE 557
A 000 500 70 93	LE 553 ⁶⁾
A 000 500 76 93	LE 556 ⁶⁾

MERCEDES BENZ	BERU
A 000 500 79 93	LE 555
A 000 500 85 93	LE 013
A 001 500 12 93	LE 554
A 001 500 13 93	LE 014
A 001 500 38 93	LE 552 ⁶⁾
A 102 200 02 22	LK 059
A 103 200 02 22	LK 052
A 103 200 04 22	LK 053
A 103 200 05 22	LK 035
A 103 200 06 22	LK 054
A 103 200 09 22	LK 036
A 104 200 01 22	LK 037
A 111 200 04 22	LK 038
A 112 200 01 22	LK 060
A 112 200 02 22	LK 039
A 116 200 05 22	LK 040
A 116 200 06 22	LK 058
A 116 200 11 22	LK 041
A 119 200 00 22	LK 042
A 119 200 01 22	LK 043
A 120 200 01 22	LK 044
A 366 200 46 23	LR 023
A 437 500 00 22	LK 096
A 541 200 09 22	LK 086
A 541 200 13 22	LK 086
A 541 200 16 22	LK 086
A 541 205 00 06	LR 010
A 603 200 00 22	LK 045
A 604 200 00 22	LK 046
A 606 200 01 22	LK 047
A 904 200 05 23	LKK 017
A 904 200 06 22	LK 095
A 904 200 08 22	LK 065
A 904 200 10 23	LKK 020
A 904 200 11 22	LK 049
A 904 205 04 06	LR 009
A 906 200 06 22	LK 097
A 906 200 08 23	LKK 019
A 906 200 09 22	LK 066
A 906 200 09 23	LKK 018
A 906 205 01 06	LR 012
A 906 205 06 06	LR 025
A 906 205 08 06	LR 024

MEYLE	BERU
014 020 0033	LK 052
014 020 0047	LK 053
014 020 0048	LK 045
014 020 0051	LK 051
014 020 0052	LK 050
014 020 0055	LK 046
014 020 0056	LK 054
014 020 0057	LK 038
014 020 0059	LK 047
014 020 0061	LK 037
014 020 0062	LK 039
014 020 0063	LK 035
014 020 0068	LK 040
014 020 0072	LK 041
014 020 0073	LK 042
014 020 0081	LK 043
014 020 0082	LK 044
014 020 0087	LK 049
100 121 0036	LK 001
100 121 0037	LK 002

MEYLE	BERU
100 121 0038	LK 004
100 121 0040	LK 003
100 121 0071	LR 002
100 121 0089	LR 001
12 14 234 0001	LK 092
12 34 232 0001	LR 020
300 115 0005	LR 004
314 115 2101	LK 012
314 115 2105	LK 010
314 115 2201	LK 007
314 115 2202	LK 006
314 115 2203	LK 008
314 115 2204	LK 009
314 115 2701	LK 011

MITSUBISHI	BERU
MD 006330	LK 068
MD 108270	LK 070

OPEL	BERU
13 14 212 ⁵⁾	LE 572 ⁶⁾
13 14 442	LE 560 ⁶⁾
13 14 442 ⁵⁾	LE 560 ⁶⁾
13 14 443 ⁵⁾	LE 561 ⁶⁾
13 14 445 ⁵⁾	LE 562 ⁶⁾
13 14 553	LE 572 ⁶⁾
13 14 554 ⁵⁾	LE 575 ⁶⁾
13 14 555 ⁵⁾	LE 574 ⁶⁾
13 14 559 ⁵⁾	LE 573 ⁶⁾
13 41 155	LE 558Z
13 41 244	LE 016
13 41 262 ⁴⁾	LE 558 ⁶⁾
13 41 331	LE 017
13 41 331 ⁴⁾	LE 560 ⁶⁾
13 41 331 ⁴⁾	LE 561 ⁶⁾
13 41 332 ⁴⁾	LE 559 ⁶⁾
13 41 334	LE 021
13 41 337	LE 019
13 41 354	LE 015
13 41 354 ⁴⁾	LE 562 ⁶⁾
13 41 362	LE 020
13 41 362 ⁴⁾	LE 566 ⁶⁾
13 41 365 ⁴⁾	LE 567 ⁶⁾
13 41 368 ⁴⁾	LE 568 ⁶⁾
13 41 369 ⁴⁾	LE 571 ⁶⁾
13 41 377 ⁴⁾	LE 575 ⁶⁾
13 41 378 ⁴⁾	LE 574 ⁶⁾
13 41 388	LE 018
13 41 390 ⁴⁾	LE 564 ⁶⁾
13 41 390	LE 565 ⁶⁾
13 41 392 ⁵⁾	LE 576 ⁶⁾
13 41 393 ⁴⁾	LE 576 ⁶⁾
13 41 394	LE 564Z
13 41 395 ⁵⁾	LE 577 ⁶⁾
13 41 397 ⁴⁾	LE 577 ⁶⁾
13 41 398 ⁴⁾	LE 578 ⁶⁾
13 41 399 ⁴⁾	LE 579 ⁶⁾
13 41 421 ⁵⁾	LE 578 ⁶⁾
13 41 421 ⁵⁾	LE 579 ⁶⁾
18 45 043	LE 563 ⁶⁾
63 41 154 ⁵⁾	LE 567 ⁶⁾
63 41 154 ⁵⁾	LE 568 ⁶⁾
63 41 154 ⁵⁾	LE 571 ⁶⁾
63 41 164 ⁵⁾	LE 559 ⁶⁾
63 41 168	LE 023

OPEL	BERU
63 41 171	LE 022
63 41 172 ⁴⁾	LE 572 ⁶⁾
63 41 172 ⁴⁾	LE 573 ⁶⁾
63 41 185	LE 566Z

OPTIMAL	BERU
SPE-111213	LK 045
SPE-112990	LK 053
SPE-115411	LK 012
SPE-118317	LK 046
SPE-118668	LK 047
SPE-120167	LK 007
SPE-120259	LK 011
SPE-120260	LK 008
SPE-120261	LK 009
SPE-120263	LK 010

PAS GMBH	BERU
4451	LK 008
4508	LK 012
4510	LK 006
4513	LK 010
4514	LK 009
7319	LK 052
7320	LK 053
7321	LK 035
7322	LK 054
7324	LK 040
7327	LK 041
7328	LK 045
7358	LK 042
7359	LK 044
7363	LK 036
7364	LK 038
7365	LK 046
7366	LK 043
25500	LK 005
25502	LK 001
34095	LK 031
71038	LK 055
71650	LK 050
71653	LK 051
71654	LK 049

PEUGEOT	BERU
1250 E9	LE 026
1250 F8	LE 581 ⁶⁾
1253 35	LE 025
1253 54	LE 025
1253 83	LE 024
1253 91	LE 580 ⁶⁾
1254 74	LE 026
1254 79	LE 024

RENAULT	BERU
50 01 864 384	LKK 021
50 10 064 525	LR 026
50 10 514 011 C	LKK 022
50 10 514 013	LKK 008
50 10 514 014	LK 072

RENAULT	BERU
50 10 514 015	LK 098
50 10 514 061	LKK 023
50 10 514 380	LK 099
74 21 012 697	LKK 009
77 00 828 623	LE 582 ⁶⁾

SAAB	BERU
13 41 368	LE 568 ⁶⁾

SACHS	BERU
2 100 005 032	LK 041
2 100 006 232	LK 037
2 100 006 232	LK 052
2 100 006 232	LK 053
2 100 010 031	LK 010
2 100 011 031	LK 011
2 100 011 034	LK 007
2 100 012 131	LK 012
2 100 013 031	LK 042
2 100 013 032	LK 043
2 100 014 331	LK 036
2 100 015 031	LK 044
2 100 019 031	LK 038
2 100 020 031	LK 046
2 100 023 001	LK 037
2 100 023 001	LK 052
2 100 023 001	LK 053
2 100 024 032	LK 047
2 100 024 136	LK 051
2 100 025 031	LK 055
2 100 030 032	LK 039
2 100 036 031	LK 040
2 100 044 031	LK 002
2 100 044 032	LK 002
2 100 077 031	LK 001
2 100 078 032	LK 013
2 100 078 033	LK 017
2 100 079 031	LK 004
2 100 079 034	LK 091
2 100 080 031	LK 003
2 100 081 031	LK 054
2 100 082 031	LK 045
2 100 083 031	LK 035
2 100 088 031	LK 050
2 100 500 008	LK 082
2 100 500 012	LK 081
2 100 501 003	LK 078
2 100 501 003	LK 079
2 100 501 005	LK 080

SCANIA	BERU
134 9551	LK 101
135 4981	LR 028
145 7385	LR 027
145 9683	LKK 024
148 0770	LK 100

SCHLIECKMANN	BERU
70 107 500	LK 004
70 107 600	LR 001
70 117 500	LK 010
70 117 610	LR 004
70 119 510	LK 008

SCHLIECKMANN	BERU
70 119 520	LK 007
70 119 710	LK 012
70 123 500	LK 011
70 123 510	LK 009
70 123 600	LR 003
70 14 2520	LK 053
70 14 9520	LK 051
70 140 500	LK 045
70 142 510	LK 038
70 142 520	LK 037
70 142 530	LK 046
70 144 400	LK 038
70 149 500	LK 050
70 15 2500	LK 054
70 445 500	LK 001
70 445 600	LR 002

SEAT	BERU
1K0 121 205	LE 584Z
1K0 959 455 CQ # 1 4)	LE 584 6)
1K0 959 455 CT # 2 4)	LE 584 6)
6K0 959 455 F	LE 027
6Q0 121 207 L 5)	LE 585 6)
6Q0 121 207 L 5)	LE 587 6)
6Q0 959 455 AD 4)	LE 585 6)
6Q0 959 455 AE 4)	LE 587 6)

SKODA	BERU
1J0 959 455 B	LE 028
1J0 959 455 P	LE 040
1K0 121 205	LE 584Z
1K0 959 455 CQ # 1 4)	LE 584 6)
1K0 959 455 CT # 2 4)	LE 584 6)
1K0 959 455 R	LE 035
6N0 959 455 F	LE 033
6Q0 121 207 L 5)	LE 585 6)
6Q0 121 207 L 5)	LE 587 6)
6Q0 959 455 AD 4)	LE 585 6)
6Q0 959 455 AE	LE 044 4)
6Q0 959 455 AE 4)	LE 587 6)
6X0 959 455 F	LE 045

SWAG	BERU
10 21 0004	LK 045
10 91 7846	LK 053
10 91 7847	LK 054
10 91 7848	LK 038
10 91 7853	LK 041
10 91 7854	LK 044
10 91 7855	LK 046
10 91 7879	LK 042
10 91 7996	LK 043
10 91 8000	LK 047
10 91 8002	LK 039
10 91 8857	LK 051
10 91 9056	LK 050
10 92 2978	LK 035
20 91 8678	LK 012
20 91 8679	LK 007
20 91 8681	LK 010
20 91 8683	LK 011
20 91 8684	LK 008
20 91 8685	LK 009

SWAG	BERU
20 91 9256	LR 003
20 91 9257	LR 004
30 21 0001	LK 001
32 92 3538	LKK 025
32 92 4722	LK 002
32 92 6565	LR 002
50 91 9660	LK 015
50 91 9661	LK 014
50 91 9661	LK 016

TOPRAN	BERU
109604	LKK 025
109607	LK 001
109608	LK 004
110294	LR 002
302002	LK 017
302004	LK 014
302005	LK 016
302007	LKK 001
400602	LK 052
400602	LK 053
400603	LK 054
400604	LK 046
400605	LK 038
400607	LK 045
400608	LK 051
401186	LK 039
500403	LK 011
500404	LK 012
500861	LK 006
500862	LK 007
500863	LK 008
500864	LK 009
500865	LK 010
500900	LR 003
500901	LR 004

TOYOTA	BERU
16210-38050	LK 078
16210-38060	LK 079
16210-54070	LK 080
16210-54130	LK 081
16210-54150	LK 082

TRUCKTEC AUTOMOTIVE	BERU
02.19.033	LK 052
02.19.033	LK 053
02.19.101	LK 045
02.19.122	LK 046
02.19.135	LK 038
08.11.001	LR 003
08.11.008	LK 012
08.11.015	LR 004
08.19.002	LK 011
08.19.017	LK 006
08.19.103	LK 010

TYC	BERU
802-0002	LE 503 6)
802-0051	LE 002
805-0001	LE 509 6)
809-0006	LE 516 6)
809-0007	LE 515 6)

TYC	BERU
809-0010	LE 519 6)
809-0012	LE 513 6)
809-0013	LE 514 6)
825-0001	LE 559 6)
825-0007	LE 015
825-0009	LE 558 6)
826-0003	LE 580 6)
837-0001	LE 005
837-0001	LE 031
837-0003	LE 033
837-0006	LE 039
837-0008	LE 007
837-0022	LE 040

VALEO	BERU
698178	LE 515 6)
698483	LE 512 6)

VAUXHALL	BERU
911 53521	LR 029

VDO	BERU
5WK 05370-V	LE 031
5WK05330-V	LE 033
5WK05360-V	LE 003
5WK05370-V	LE 005
A2C59511338	LE 035
A2C59511339	LE 047
V 15-01-1849	LE 587 6)

VERO	BERU
15-04-2103	LK 003
15-04-2102-1	LK 004
15-04-2112-1	LK 002
15-90-1854	LR 002
15-90-1857	LR 001
20-04-1063	LK 010
20-04-10631	LK 010
20-04-10651	LK 012
20-04-10701	LK 011
20-04-10751	LK 006
20-04-10781	LK 007
20-04-1080	LK 008
20-04-1081	LK 009
20-90-1107	LR 003
20-90-1108	LR 004
25-04-1561	LK 015
25-04-1562	LK 016
30-04-16211	LK 052
30-04-16231	LK 042
30-04-16251	LK 036
30-04-16261	LK 038
30-04-16271	LK 046
30-04-1628	LK 043
30-04-1633	LK 040
30-04-16371	LK 053
30-04-16381	LK 035
30-04-16391	LK 054
30-04-1645	LK 051
30-04-1646	LK 050
30-04-16501	LK 045

VEMO	BERU
30-04-16571	LK 047
30-04-16591	LK 039
30-04-1661	LK 055
30-04-1663	LK 037
V 15-01-1822	LE 008
V 15-01-1822	LE 027
V 15-01-1835-1	LE 502 ⁶⁾
V 15-01-1835-1	LE 583 ⁶⁾
V 15-01-1849	LE 044 ⁴⁾
V 15-01-1879	LE 506 ⁶⁾
V 24-01-1212	LE 511 ⁶⁾
V 40-01-1029-1	LE 016
V 40-02-1041	LE 563 ⁶⁾
V 46-01-1312	LE 582 ⁶⁾
V15-04-21011	LK 001
V15-04-2102-1	LK 004
V15-04-2103	LK 003
V15-04-2112-1	LK 002
V15-04-2114	LKK 025
V15-90-1854	LR 002
V15-90-1857	LR 001
V20-04-1063	LK 010
V20-04-10631	LK 010
V20-04-10651	LK 012
V20-04-10701	LK 011
V20-04-10751	LK 006
V20-04-10781	LK 007
V20-04-1080	LK 008
V20-04-1081	LK 009
V20-90-1107	LR 003
V20-90-1108	LR 004
V25-04-1558	LK 017
V25-04-1560	LK 014
V25-04-1561	LK 015
V25-04-1562	LK 016
V30-04-16201	LK 041
V30-04-16211	LK 052
V30-04-16231	LK 042
V30-04-16251	LK 036
V30-04-16261	LK 038
V30-04-16271	LK 046
V30-04-1628	LK 043
V30-04-16281	LK 043
V30-04-1633	LK 040
V30-04-16371	LK 053
V30-04-16381	LK 035
V30-04-16391	LK 054
V30-04-1645	LK 051
V30-04-1646	LK 050
V30-04-16501	LK 045
V30-04-16571	LK 047
V30-04-16591	LK 039
V30-04-1661	LK 055
V30-04-1663	LK 037

VOLVO	BERU
1266788	LK 084
1274963	LK 085
1328835	LK 083
1675036	LK 102
8113266	LKK 026
8149972	LK 103
20501361	LKK 028
20576186	LKK 009
85000072	LKK 027
1 437 1615	LR 030
1 674 125	LR 031
1 674 126	LR 034
8 149 866	LR 032
9 516 517	LR 033

VW AG	BERU
058 121 301 B	LR 002
058 121 350	LK 001
059 121 350 F	LK 002
059 121 350 G	LK 002
059 121 350 H	LK 002
074 121 302 B	LKK 025
074 121 302 C	LKK 025
077 121 350 D	LK 003
078 121 301 E	LR 001
078 121 350 A	LK 004
165 959 455 L	LE 001
165 959 455 T	LE 007
191 959 455 T	LE 029
1C0 959 455 C	LE 005
1C0 959 455 C	LE 031
1H0 959 455 B	LE 038
1H0 959 455 J	LE 042
1H0 959 455 T	LE 043
1J0 959 455 B	LE 028
1J0 959 455 D	LE 003
1J0 959 455 P	LE 040
1K0 121 205	LE 584Z
1K0 959 455 CQ 1 ⁴⁾	LE 584 ⁶⁾
1K0 959 455 CT 2 ⁴⁾	LE 584 ⁶⁾
1K0 959 455 DT	LE 047
1K0 959 455 EA	LE 046
1K0 959 455 R	LE 035
321 959 455 AM	LE 041
3A0 959 455 B	LE 032
443 959 455 N	LE 008
4A0 959 455 B	LE 006
4A0 959 455 C	LE 004
4B0 959 455	LE 583 ⁶⁾
4Z7 959 455	LE 505 ⁶⁾
6K0 959 455 F	LE 027

VW AG	BERU
6N0 959 455 A	LE 030
6N0 959 455 A	LE 037
6N0 959 455 F	LE 033
6N0 959 455 G	LE 037
6Q0 121 207 L ⁵⁾	LE 585 ⁶⁾
6Q0 121 207 L ⁵⁾	LE 587 ⁶⁾
6Q0 959 455 AD ⁴⁾	LE 585 ⁶⁾
6Q0 959 455 AE ⁴⁾	LE 587 ⁶⁾
6Q0 959 455 J	LE 039
6QD 959 455 C	LE 048
6X0 959 455	LE 036
6X0 959 455 C	LE 036
6X0 959 455 F	LE 045
701 959 455 AE	LE 034
701 959 455 AM	LE 034
8D0 959 455 B	LE 586 ⁶⁾
8D0 959 455 C	LE 502 ⁶⁾
8D0 959 455 D	LE 504 ⁶⁾
8D0 959 455 J	LE 501 ⁶⁾
8D0 959 455 L	LE 586 ⁶⁾
8D0 959 455 M	LE 506 ⁶⁾
8D0 959 455 R	LE 503 ⁶⁾
8E0 959 455 K	LE 002

WEZEL	BERU
0325740	LK 004
0325742	LR 001
0639740	LK 010
0639743	LR 004
0640738	LK 012
0640739	LK 008
0640740	LK 007
0646738	LK 011
0646739	LK 009
0646742	LR 003
3020738	LK 035
3020739	LK 045
3024739	LK 038
3024740	LK 037
3024740	LK 053
3025738	LK 043
3025739	LK 047
3025740	LK 046
3028738	LK 054
3029739	LK 042
3030746	LK 038
3075738	LK 050
3075740	LK 051
5836740	LK 001
5836742	LR 002

BorgWarner BERU Systems Produktgewährleistung

Die in diesem Katalog aufgeführten Produkte können in allen Fahrzeugen/Motoren entsprechend unserer Empfehlung verwendet werden. Erkennbarer Irrtum oder offensichtliche Druckfehler unterliegen der Sorgfaltspflicht des Verwenders. Für die Fehlerfreiheit leistet BERU Gewähr entsprechend dem jeweiligen Stand der Technik. Werden BERU Produkte gemäß unseren Empfehlungen verwendet und entstehen hierdurch trotzdem nachweisbare Schäden am Motor, übernehmen wir ganz oder teilweise die entstehenden Kosten für die Behebung des Schadens. Nach Vorlage beanstandeter BERU Produkte, beschädigter Motorenteile und Reparaturbelege trifft BERU die Entscheidung über eine Kostenübernahme. Grundvoraussetzung dafür ist generell die sachgemäße Handhabung der BERU Produkte.

Die Gewährleistungsfrist für mangelhafte Produkte beträgt 24 Monate auf Grundlage unserer allgemeinen Geschäftsbedingungen. Ausgenommen davon ist normaler Verschleiß.

BorgWarner BERU Systems Product Guarantee

The products listed in this catalog can be used in all vehicles/engines in accordance with our recommendation. Recognisable mistakes or obvious printing errors are subject to the diligence of the user. BERU guarantees the faultless performance and specified properties according to the current standards of technology. If BERU products which are used in accordance with our recommendations are proven to have caused damage to an engine, we will cover, in full or in part, the resulting costs of rectifying the damage. Following submission of BERU products claimed to be defective as well as damaged engine parts and repair bills, we reserve the right to examine the claims and to decide based on the outcome of our analysis whether or not reimbursements will be made. Generally prerequisite is the correct use of the BERU products.

The warranty period for material flaws or faulty workmanship is 24 months based on our General Terms and Conditions. Normal wear is excluded.

Garantie produit BorgWarner BERU Systems

Les produits figurant dans ce catalogue peuvent être utilisés dans tous les véhicules/moteurs selon nos recommandations. Les erreurs reconnaissables ou les erreurs d'impression évidentes tombent sous l'obligation d'attention de l'utilisateur. BERU garantit l'absence d'erreurs et les propriétés annoncées sur la base de l'état actuel de la technique. Lorsque les produits BERU sont utilisés conformément à nos recommandations et que, suite à cela, le moteur subit malgré tout des dommages pouvant être prouvés, nous supportons en totalité ou en partie les coûts engendrés pour éliminer ces dommages. Après présentation des produits BERU faisant l'objet d'une réclamation, des pièces de moteur endommagées et des factures de réparation, BERU prend la décision concernant la prise en charge des coûts. La condition préalable fondamentale pour cela est en général l'utilisation conforme des produits BERU.

La période de garantie de nos produits est de 24 mois sur la base de nos conditions générales de vente. L'usure normale en est exclue.

BorgWarner BERU Systems productgarantie

De in deze catalogus vermelde producten kunnen in alle voertuigen/motoren volgens onze aanbeveling worden gebruikt. Duidelijk zichtbare vergissingen of duidelijke drukfouten vallen onder de verantwoordelijkheid van de gebruiker. Voor het correct functioneren staat BERU garant in overeenstemming met de stand van de techniek op dat moment. Als BERU-producten volgens onze aanbevelingen gebruikt worden en er ontstaat desondanks schade aan de motor, dan nemen wij geheel of gedeeltelijk de ontstane kosten voor het verhelpen van de schade op ons. Na het voorleggen van de bekrispelde BERU producten, beschadigde motoronderdelen en reparatiebonnen neemt BERU het besluit over overname van de kosten. Een eerste vereiste daarvoor is in het algemeen het deskundige gebruik van de BERU producten.

De garantietermijn voor defecte producten bedraagt 24 maanden op basis van onze algemene voorwaarden. Uitgezonderd daarvan is normale slijtage.

Garantía de producto BorgWarner BERU Systems

Los productos incluidos en este catálogo pueden utilizarse en todos los vehículos/motores conforme a nuestras recomendaciones. Los errores reconocibles o las faltas de imprenta evidentes están sometidas a la obligación de examen esmerado del usuario. Respecto a la ausencia de fallos ofrece BERU garantía en correspondencia con el respectivo estado de la técnica. Si se emplean los productos BERU conforme a nuestras recomendaciones y surgen sin embargo daños demostrables en el motor, nuestra empresa asume total o parcialmente los costes producidos para la eliminación del daño. Tras la presentación de productos BERU reclamados, piezas del motor dañadas y comprobantes de reparación, BERU toma la decisión sobre una adopción de los costes. Condición básica para ello es por norma general el tratamiento técnicamente correcto de los productos BERU. El plazo de garantía sobre productos defectuosos asciende a 24 meses en base a nuestras condiciones comerciales generales. Se exceptúa de ello el desgaste normal.

Garanzia di prodotto BorgWarner BERU Systems

I prodotti contenuti nel presente catalogo possono essere utilizzati in tutti i veicoli/motori secondo le nostre raccomandazioni. La BERU non risponde per errori di contenuto o di stampa palesi, il cui riconoscimento cade sotto l'obbligo di diligenza dell'utilizzatore. La BERU risponde per l'integrità assicurata nell'ambito dello stato odierno della tecnica. Se è possibile comprovare che il motore ha subito danni nonostante che i prodotti BERU siano stati usati rispettando le nostre raccomandazioni, ci prendiamo carico parzialmente o totalmente delle spese causate per la riparazione del danno. La BERU decide sul risarcimento dei danni

dietro presentazione dei prodotti BERU reclamati, dei componenti del motore danneggiati e delle relative fatture, a condizione che i prodotti BERU siano stati manipolati correttamente. Come dalle nostre condizioni generali di contratto, la garanzia per prodotti difettosi è di 24 mesi, a eccezione dei difetti causati da normale usura.

Гарантия на продукцию BorgWarner BERU Systems

Указанные в данном каталоге изделия могут использоваться во всех транспортных средствах/двигателях согласно нашим рекомендациям. Однако сюда не входит обычный износ, неправильное применение, неправильное обслуживание или установка и т.п. BERU гарантирует, что свечи зажигания, свечи накаливания и принадлежности, указанные в данном каталоге, могут применяться в двигателях в соответствии с нашими рекомендациями. Мы не несем ответственности за явные недоработки и опечатки, их обнаружение входит в обязанности пользователя. Если изделия BERU применяются в соответствии с нашими рекомендациями и несмотря на это происходит повреждение двигателя, которое может быть подтверждено, после представления изделий BERU, по которым заявляется рекламация, а также поврежденных частей двигателя и документов, подтверждающих выполнение ремонта, компания BERU примет решение о том, должна ли она и в каком объеме отвечать за возникшее повреждение, и полностью или частично возмет на себя расходы по устранению повреждения. Однако и здесь принципиальным условием является правильное применение изделий BERU.

Gwarancja na produkty BorgWarner BERU Systems

Wymienione w niniejszym katalogu produkty mogą być stosowane we wszystkich pojazdach/silnikach zgodnie z naszymi zaleceniami. W ramach obowiązku staranności użytkownika leży wykuczenie dostrzegalnych pomylek lub widocznych błędów w druku. Firma BERU udziela gwarancji na bezusterkowość oraz deklarowane właściwości produktów, zgodnie z aktualnym stanem techniki. Jeżeli produkty BERU będą stosowane zgodnie z naszymi zaleceniami i pomimo tego dojdzie do dających się udowodnić uszkodzeń silnika, wówczas przejmujemy w całości lub częściowo koszty związane z usunięciem tych szkód. Firma BERU podejmie decyzję o pokryciu kosztów po przedłożeniu reklamowanych produktów BERU, uszkodzonych części silnika oraz rachunków za przeprowadzone naprawy. Podstawowym tego warunkiem jest prawidłowe posługiwanie się produktami BERU.

Okres gwarancji na wadliwe wyroby wynosi 24 miesiące zgodnie z naszymi ogólnymi warunkami handlowymi. Gwarancja nie obejmuje normalnego zużycia się części na skutek eksploatacji.

Εγγύηση προϊόντων BorgWarner BERU Systems

Τα προϊόντα, τα οποία αναφέρονται στον κατάλογο αυτό, μπορούν να χρησιμοποιηθούν σε όλα τα οχήματα/κινητήρες σύμφωνα με τη σύστασή μας. Η ευδιάκριτη πλάνη ή τα προφανή τυπογραφικά λάθη υπόκεινται στην υποχρέωση καταβολής επιμέλειας του χρήστη. Για τη λειτουργία χωρίς βλάβες η εταιρία BERU παρέχει εγγύηση σύμφωνα με την εκάστοτε εξέλιξη της τεχνολογίας. Σε περίπτωση που προκληθούν αποδεδειγμένες βλάβες στον κινητήρα, παρά το γεγονός ότι η χρήση των προϊόντων BERU έγινε σύμφωνα με τις συστάσεις μας, αναλαμβάνουμε εξ ολοκλήρου ή εν μέρει τα έξοδα για την αποκατάσταση της βλάβης. Κατόπιν επιδείξης των ελαττωματικών προϊόντων BERU, των εξαρτημάτων κινητήρα με εμφανή βλάβη και των αποδεικτικών επισκευής, η εταιρία BERU αποφασίζει για την ανάληψη των εξόδων. Βασική προϋπόθεση για την ανάληψη των εξόδων είναι ο κανονικός χειρισμός των προϊόντων BERU.

Η προθεσμία παροχής εγγύησης για ελαττωματικά προϊόντα ανέρχεται σε 24 μήνες σύμφωνα με τους γενικούς όρους συναλλαγών μας. Από την περίπτωση αυτή αποκλείονται οι φυσιολογικές φθορές.

BorgWarner BERU Systems termékjótállás

Az ebben a katalógusban felsorolt termékek minden általunk javasolt járműben/motorban használhatóak. Felismerető tévedések vagy nyilvánvaló nyomdahiábák esetén a felhasználó kötelezettsége érvényesül. A hibamentességért és a biztosított tulajdonságokért a BERU a technika mindenkori állásának megfelelően jótáll. Ha a BERU termékeit az ajánlásunknak megfelelően alkalmazzák és ezáltal a motoron ennek ellenére bizonyítható meghibásodások lépnek fel, akkor teljes mértékben vagy részben átvesszük a hibák elhárításának a költségeit. Kifogásolt BERU termékek, vagy meghibásodott motorrészek és javítási nyugták felmutatása után a BERU dönt a költségek átvállalásáról. Ennek alapvető feltétele mindig a BERU termékek szakszerű használata.

A hibás termékek miatti jótállási idő 24 hónap cégünk általános üzleti feltételei alapján. Kivételt képez ez alól a természetes elhasználódás.

BorgWarner BERU Systems Ürün Garantisi

Bu katalogda belirtilen ürünler, yaptığımız öneriye göre tüm araçlar/motordlarda kullanılabilir. Belirlenebilen hatalar veya açık baskı hataları, kullanicının özenli davranma yükümlülüğüne tâbidir. BERU, hatasızlık konusunda mevcut teknolojik düzeyi uygun olarak garanti vermektedir. BERU ürünleri önerilerimize göre kullanılırsa ve buna rağmen motorda ispatlanabilen hasarlar oluşursa, hasarın giderilmesi için oluşan masrafları tamamen veya kısmen üstlenmekteyiz. Şikayet konusu BERU ürünlerinin, hasarlı motor parçalarının ve onarım belgelerinin belgelenmesinden sonra, BERU, masrafları üstlenme konusunda kararını verir. Bunun önkösülden, genel olarak BERU ürünlerinin kullanılmasına uygun şekilde kullanılmalıdır. Kusurlu ürünler için garanti süresi, genel çalışma koşullarımız temelinde 24 aydır. Normal aşınma bunun dışındadır.

Printed in Germany - 20.06.11 - Bestell-Nr. 5 720 000 001
BERU® is a Registered Trademark of BorgWarner BERU Systems GmbH
CATBU1101



 **FEDERAL
MOGUL**

Global Aftermarket EMEA bvba
Prins Boudewijnlaan 5
2550 Kontich • Belgium

www.federalmogul.com
www.beru.com

 www.fmecat.eu

Perfection
built in

