

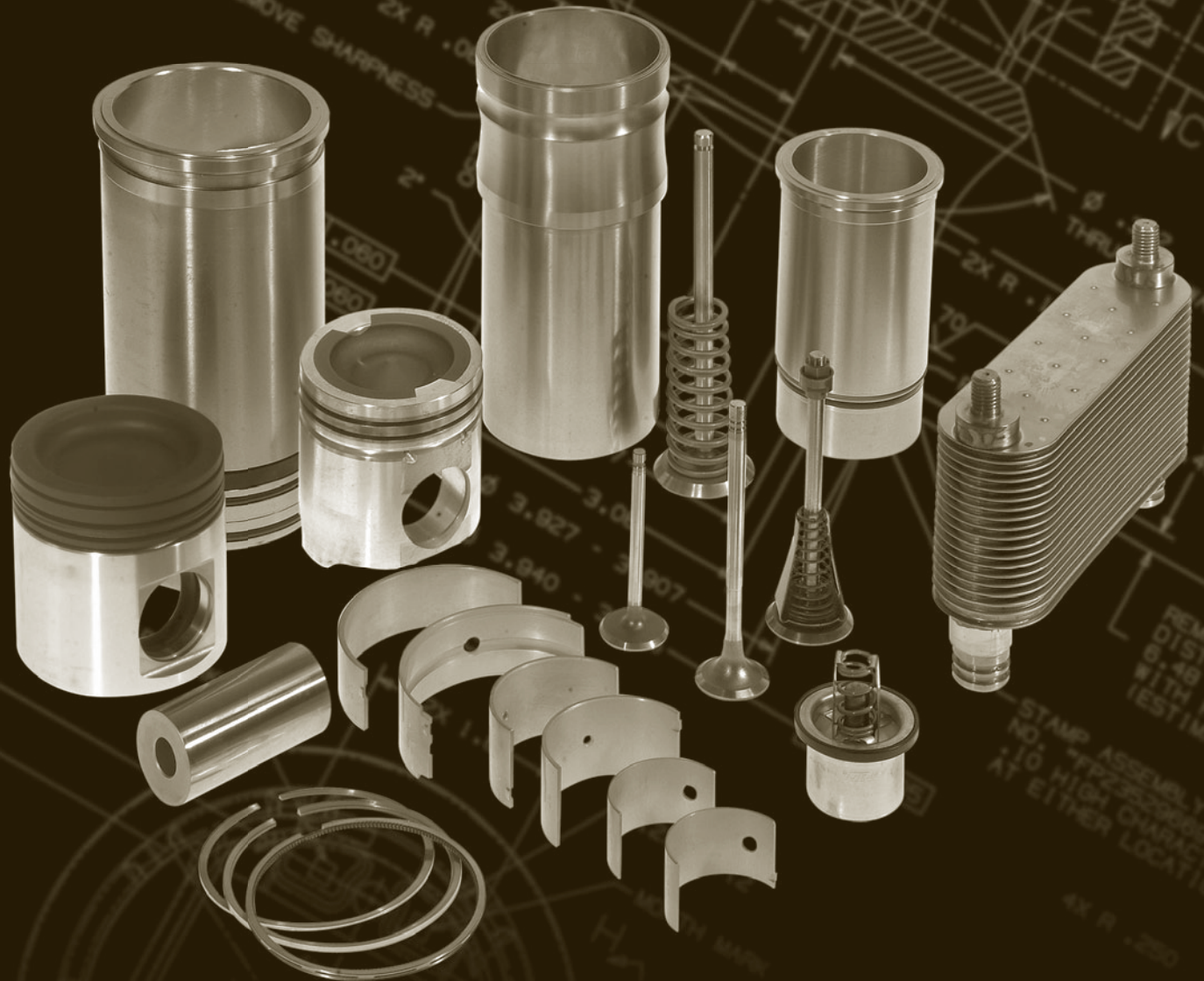

Weatherly Index No. 002

CATALOG NO.  
**CA0080**  
NOVEMBER 2012



**JOHN DEERE®**  
**ENGINES**  
**Replacement Parts Catalog**

*GLOBAL TECHNOLOGY behind every part*



# RELY ON US TO MAXIMIZE PERFORMANCE.



## Choosing the right replacement components for a hard working engine is key to ensuring trouble-free performance

FP Diesel components and kits have been proven for years in medium and heavy-duty service engines across the country. These parts are designed using the latest in computer-aided design (CAD) and computer-aided engineering (CAE) technology, and are thoroughly researched to meet the most demanding specifications.

With FP Diesel you get a better solution: premium technologies engineered to address the unique demands placed on all diesel engines – and maximize productivity. It's a rebuild parts choice you can make with confidence.



In-frame and Overhaul Kits | Camshafts | Oil Coolers  
Engine Bearings | Engine Oil Seals | Expansion Plugs  
Fuel Pumps | Fuel Injector Components | Gaskets  
Lifters | Oil Pumps | Piston Rings | Pistons | Push Rods  
Rocker Arm Parts | Sleeves | Timing Components  
Turbocharger Components | Valvetrain Parts  
Water Pumps & Thermostats

**Rely on us today for the complete range of  
FP Diesel replacement engine components!**



**FP  
DIESEL**®



## Table of Contents

*Global Technology Behind Every Part*

### Using the Catalog

Table of Contents.....	I
How To Use This Catalog .....	II
Abbreviations.....	XVI
Conversion Tables .....	XVIII
Engine Identification.....	III
Engine Kit Bill of Materials.....	372
General Information.....	II
Numerical List.....	382
Off Highway	
Engine Index .....	1-2
Engine Code Index.....	2-9
Model Index.....	9-37
Industrial	
Engine Index .....	255
Engine Code Index.....	255-257
Marine	
Engine Index .....	347
Engine Code Index.....	347-348

### FP Diesel Products & Reference

Engine Bearings .....	XIII
Engine Kits .....	XI
Engine Kits – How To Order .....	XII
Pistons – Heavy Duty .....	XIV
Quick Reference Line Card .....	VII
Sealed Power to FP Diesel Consolidated Engine Kits.....	XIX
Sleeve Assemblies .....	XV
Specialty Gasket Sets .....	XX
Clutch Housing Gaskets .....	XXI
Jake Brake Gasket Sets .....	XXI
O-Ring & Cylinder Liner Sealing Ring Kits .....	XXI
Warranty .....	XXII







## FP Diesel CA0080 John Deere Engine Parts Catalog

*Global Technology Behind Every Part*

The header for each block listed is designed to help you identify the correct engine application. Special information regarding a specific part is located to the right of the part number listing. The ENGINE KIT part number is in the engine listing. The Bill of Materials for the kits are listed in the back of the catalog.

**Engine components are grouped in the following order:**

- 1st** Cylinder Head and Parts
- 2nd** Intake & Exhaust Manifolds
- 3rd** Camshaft Group
- 4th** Fuel System and Parts
- 5th** Cooling System
- 6th** Engine Block and Parts
- 7th** Crankshaft/Oil Pump and Related Parts
- 8th** Cylinder Components (incl. Rod Bearings, Cylinder Sleeves, Pistons, Piston Rings)

**The catalog is sorted as follows::**

- 1st** by ENGINE DISPLACEMENT.
- 2nd** by BORE DIAMETER. Engines with the same displacement are sorted by bore diameter.
- 3rd** By USAGE. The engines are listed by Serial Number in increasing sequence and by Early, Mid, and Late production serial numbers.
- 4th** By INDUCTION SYSTEM. Naturally aspirated engines will be listed before Turbocharged engines.

Many of the headers will include serial number listings to provide added assurance that the correct listing is being used.

### General Information

This catalog is designed to identify the major components, assemblies and kits used in John Deere engines in construction, agricultural, industrial and marine applications.

The catalog is organized by engine model. Each section is subdivided into groups that coincide with the various engine assemblies and components.

FP Diesel uses a part numbering system similar to that used by John Deere OEM numbers. In most instances, the FP Diesel part number add a "FP-" prefix to the existing core number.

**John Deere Part Number R12345**  
**FP Diesel Part Number FP-R12345**

All manufacturers numbers, names, symbols and descriptions are used for reference purposes only. It is not implied that any part listed is the product of any specific manufacturer.

All information contained in this catalog is based on the latest data available at the time of printing. Although care has been taken to ensure the accuracy of the data compiled in this catalog, Federal-Mogul does not assume liability for errors or omissions.

#### **IMPORTANT NOTICE**

This catalog does not replace the John Deere parts catalogs or service materials. If in doubt, reference your John Deere publications.





# Engine Identification

*Global Technology Behind Every Part*

To specify the correct part for your particular engine, you must have all the information from the engine data plate, usually affixed to the side of the engine block. In some cases you will need the casting number on the engine block and the casting number on the connecting rod.

### 300 SERIES: NATURALLY ASPIRATED & TURBOCHARGED

3 Cylinder Models: 3-152, 3-164, 3-179, 3029  
4 Cylinder Models: 4-202, 4-219, 4-239, 4-276, 4039, 4045  
6 Cylinder Models: 6-303, 6-329, 6-359, 6-414, 6059, 6068

### 450 SERIES: NATURALLY ASPIRATED, TURBOCHARGED & AFTERCOOLED

6 Cylinder Models: 6081, 8.1L Powertech

### 500 SERIES: NATURALLY ASPIRATED, TURBOCHARGED & AFTERCOOLED

6 Cylinder Models: 6-531, 6-619

### 350 SERIES: NATURALLY ASPIRATED, TURBOCHARGED & AFTERCOOLED

3 Cylinder Models: 2.9L Powertech  
4 Cylinder Models: 4.5L Powertech  
6 Cylinder Models: 6.8L Powertech

### 550 SERIES: NATURALLY ASPIRATED, TURBOCHARGED & AFTERCOOLED

6 Cylinder Models: 10.5L Powertech

### 400 SERIES: NATURALLY ASPIRATED, TURBOCHARGED & AFTERCOOLED

4 Cylinder Models: 4-270  
6 Cylinder Models: 6-404, 6-466, 6076

### 650 SERIES: NATURALLY ASPIRATED, TURBOCHARGED & AFTERCOOLED

6 Cylinder Models: 12.5L Powertech

John Deere® Engines are identified by the engine Serial Number Plate. The plate will list the Serial Number, Number of Cylinders, Engine Displacement in Liters or in Cubic Inches, the fuel option, Naturally Aspirated, Turbo, or Turbo Aftercooled (Intercooled). The plate can also have the country in which the engine was manufactured.

There will also be a plate that will list the Engine Option Codes. Each code is a four digit number. The first two numbers of the four digit codes identify a specific group of parts or area of the engine. The other two give a specific option of the parts and their application. If an engine is ordered without a particular component, the last two numbers will be "99".

There also may be Serial Number breaks listed in the part listings. The FP Diesel listing will refer to this as Code or Codes if this is required in the selection of components. Examples of John Deere Serial Number and Engine Option Code plates are on the pages following.





# Engine Identification

*Global Technology Behind Every Part*

## ENGINE SERIAL NUMBER PLATE (EXC. POWERTECH & POWER UNITS)

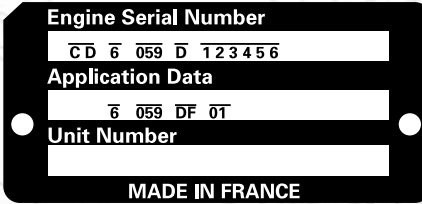
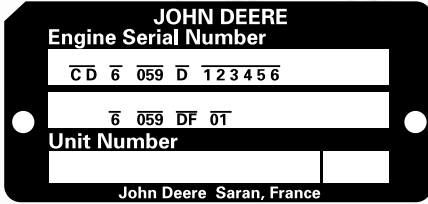

- ① Designates engine manufacturer
- ② Designates number of cylinders
- ③ Designates total displacement (in Liter)
- ④ Designates the type of aspiration
- ⑤ Designates engine serial number
- ⑥ Designates engine user
- ⑦ Designates the version

CD – SARAN  
 6  
 059 (5.9 Liter)(Bore 4.19" x Stroke 4.33")  
 D – Naturally-aspirated Diesel  
 T – Turbocharged Diesel  
 123456 (Six Digits)  
 F (OEM)  
 001 (Three Digits)  
 092 (Repower Engine)

## ENGINE SERIAL NUMBER PLATE – POWERTECH ENGINES

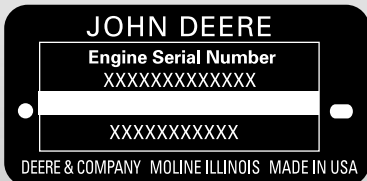

DUBUQUE OPTION

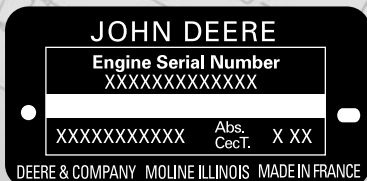

SARAN OPTION

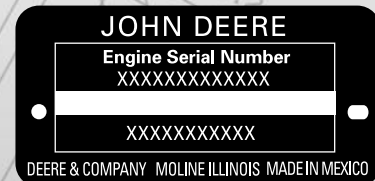

TORREON OPTION

- ① Designates engine manufacturer
- ② Designates number of cylinders and Liters
- ③ Designates fuel type or special conditions
- ④ Designates engine serial number
- ⑤ Designates the engine application and aspiration.

T – John Deere Dubuque works  
 6068 (6.8 Liter)  
 HF – Turbocharged natural gas engine  
 123456  
 6068HFN51 (with Turbocharger)  
 6068HFN50 (with Turbocharger)





# Engine Identification

*Global Technology Behind Every Part*

## ENGINE SERIAL NUMBER PLATE – POWER UNITS

Each power unit has its own individual serial number. The power unit serial number plate is located near the fuel pump on the right hand side of the cylinder block.

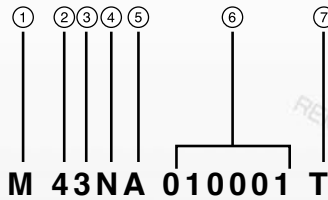

### POWER UNITS UP TO SERIAL NUMBER 185199

- ① This first letter designates the engine  
M – Engine
- ② This number designates the series  
4 – 135 or 152
- ③ This number designates the fuel type of engine  
1 – Gasoline  
3 – Diesel
- ④ This letter designates the using factory  
E – Ottumwa Works  
N – Des Moines Works
- ⑤ This letter designates the engine variation and application  
A – Initial Design  
B – First variation  
C – Second Variation
- ⑥ These six digits designate the portion of the power unit serial number shown in the serial number column.
- ⑦ This letter designates the manufacturer of John Deere Dubuque Works the power unit.

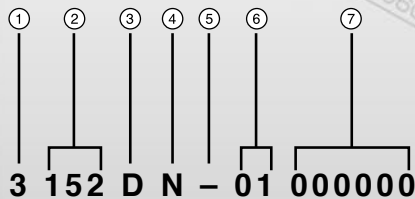

### POWER UNITS FROM SERIAL NUMBER 185200-UP

- ① This number designates the number of cylinders  
3 – Three Cylinder
- ② These numbers designate the cubic inch displacement  
135 – 135 cubic inch (2212 CM3)  
152 – 153 cubic inch (2491 CM3)
- ③ This letter designates the fuel type of engine  
D – Diesel  
G – Gasoline
- ④ This letter designates the using factory  
E – Ottumwa Works  
N – Des Moines Works
- ⑤ The dash is used for separation
- ⑥ These numbers designate the engine version  
01 – Initial Design  
02 – First Variation
- ⑦ These six numbers designate the portion of the power unit serial number shown in the serial number.

### POWER UNITS ENGINE OPTION CODE LABEL

<b>JOHN DEERE</b>							
N° DE COMMANDE : 181680420				N° . LOAD : 859647			
-	18	1102	1202	1301	1404	1501	1664 1703
1903	2004	2101	2204	2403	2803	2902	3010 3101
3502-	3601-	3702-	3901	4005	4199	4399	4499 4599
4603	4708-	475F	4802-	4901-	5001-	5101-	5299 5512
5601	5906-	6206-	6904	9801-	MT05-		
CONTROLE PAR (INSPECTED BY):						***	→

CD37210





**Global Technology Behind Every Part**



# Your complete source for premium replacement parts for John Deere®

## Products Available

FP Diesel offers replacement parts for the following John Deere® engines:

300 SERIES

400 SERIES

500 SERIES

2.9D Powertech

2.9T Powertech

4.5D Powertech

4.5T Powertech

6.8D Powertech

6.8T Powertech

8.1T Powertech

9.0L Powertech

10.5L Powertech

12.5L Powertech

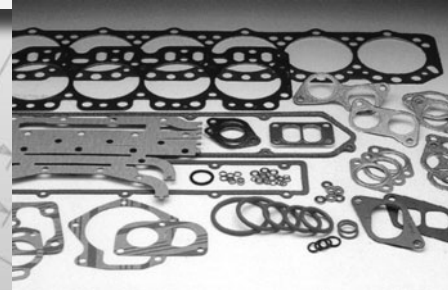

See the matrix on the next page for a complete listing of parts and individual engine models.

When you demand precision-engineered replacement parts for John Deere® and you need them fast, turn to FP Diesel, the global leader in heavy-duty powertrain components.

From in-frame engine kits and cylinder kits to a full line of engine and sealing parts, FP Diesel components offer the best technologies for replacement parts for heavy-duty engine applications.

24-hour online ordering is available through the Federal-Mogul eConnect system. Plus, your FP Diesel parts are backed by a comprehensive warranty program.

Choose FP Diesel for the powertrain technologies that thrive in today's hardest working engines. OE innovation and aftermarket solutions — that's the FP Diesel exclusive advantage.







**Global Technology Behind Every Part**

## Replacement Parts for John Deere® Available from FP Diesel

FP Diesel offers a broad range of in-frame and overhaul kits and related components for 300 Series, 400 Series, 500 Series, 2.9D Powertech, 2.9T Powertech, 4.5D Powertech, 4.5T Powertech, 6.8D Powertech, 6.8T Powertech, 8.1T Powertech, 9.0L Powertech, 10.5L Powertech, and 12.5L Powertech engines.

Engine	300 S*	400 S**	500 S***	2.9D PT	2.9T PT	4.5D PT	4.5T PT	6.8D PT	6.8T PT	8.1T PT	9.0L PT	10.5L PT	12.5L PT
Main & Rod Bearings	•	•	•	•	•	•	•	•	•	•	•	•	•
Camshafts		•											
Camshaft Bushings	•	•	•	•	•	•	•	•	•	•	•	•	•
Crankshafts	•	•											
Crankshaft Seals	•	•	•	•	•	•	•			•	•	•	•
Cylinder Kits	•	•	•	•	•	•	•	•	•	•	•	•	•
Gasket Sets	•	•	•	•	•	•	•	•	•	•	•	•	•
In-Frame Engine Kits	•	•	•	•	•	•	•	•	•		•	•	•
Overhaul Kits	•	•	•										
Liners	•	•	•	•	•	•	•	•	•	•	•	•	•
Pistons	•	•	•	•	•	•	•	•	•	•	•	•	•
Piston Rings	•	•	•	•	•	•	•	•	•	•	•	•	•
Rocker Cover Gaskets	•	•	•	•	•	•	•	•	•	•	•	•	•
Pan Gaskets	•	•	•	•	•	•	•	•	•	•	•	•	•
Head Gaskets	•	•	•	•	•	•	•	•	•	•	•	•	•
Valvetrain	•	•	•	•	•	•	•			•	•	•	•
Oil Coolers		•											
Rod Bushings	•	•	•			•	•	•	•	•	•	•	•
Rod Bolts	•	•	•	•	•	•	•	•	•	•	•	•	•
Thermostats	•	•	•			•	•			•		•	•
Water Pump Overhaul Kits	•	•	•	•	•								

\* 300 Series Engines: 152, 202, 303, 164, 219, 329, 179, 239, 359, 3029, 4039, 6059, 276, 414, 4045, 6068

\*\* 400 Series Engines: 270, 404, 466, 6076

\*\*\* 500 Series Engines: 531D, T, A; 619T, A

## The Complete Power Package

Restoring the power and durability of a large-displacement diesel or natural gas engine requires the best replacement engine technologies and components. Having an extensive commercial-engine OE portfolio is absolutely imperative. Being a global manufacturer means investing in advanced technologies and on a daily basis working to create engine and sealing system solutions that address the dynamic forces found in each generation of engines.

Federal-Mogul is instrumental in the development of every new generation of

diesel engine technology, with a proven commitment to best-in-class product performance and reliability. The company's global research centers are pioneering the use of new materials and designs that will become tomorrow's industry standards. Consistent deployment of leading-edge technologies across this extensive research network ultimately means better designs for replacement applications.



## FP Diesel Philosophy

*Global Technology Behind Every Part*

FP Diesel is the industry's leading brand of premium heavy-duty replacement engine parts and gaskets, providing total engine system solutions for such well-known brands as Case®, Caterpillar®, Cummins®, Detroit Diesel®, IH/Navistar®, John Deere®, Komatsu®, Mack®, Waukesha® and White Superior®.

Federal-Mogul maintains a steadfast commitment to unsurpassed product quality and customer service. We serve construction, marine, agricultural, mining, gas compression, trucking and industrial markets around the globe. As the global leader in heavy-duty powertrain systems, Federal-Mogul is instrumental in the development of every new generation of gasoline and diesel engine technology. When you choose FP Diesel, you get unparalleled global engineering and manufacturing resources built into every product.

Today's medium and heavy duty commercial markets demand performance. Performance means precision-engineered parts that meet your demanding specifications; and are backed by a team of knowledgeable customer service representatives who can provide technical information and assistance; computerized order and inventory tracking for fast and accurate order fill; unprecedented warranty programs and a company-wide commitment to customer satisfaction.



**Construction**



**Agriculture**



**On-Highway**



**Marine**

©2012 Federal-Mogul Corporation. FP Diesel and their respective designs are registered trademarks of Federal-Mogul Corporation. Case® is the registered trademark of Case Corporation, Inc.; Cat® and Caterpillar® are the registered trademarks of the Caterpillar, Inc.; Cummins® is the registered trademark of Cummins Engine Company; Detroit Diesel® is the registered trademark of Detroit Diesel Corporation; IH/Navistar® is the registered trademark of International Truck and Engine Corporation; John Deere® is the registered trademark of Deere & Company; Komatsu® is the registered trademark of Komatsu Limited, Inc.; Mack® is the registered trademark of Mack Trucks, Inc.; Waukesha® is the registered trademark of the Waukesha Engine Division of Dresser Industries, Inc.; White Superior® is the registered trademark of White Superior Corporation, Inc. Jacobs® is a registered trademark of Jacobs Vehicle Systems. All rights reserved.





## Manufacturing

### *Global Technology Behind Every Part*



Precise manufacturing and fabricating techniques, rigorous quality control procedures, utilization of the latest CAD technology and innovative solutions to industry challenges – coupled with Federal-Mogul's global manufacturing capabilities – have established FP Diesel as the industry leader in the medium and heavy duty commercial market.

FP Diesel applies stringent quality control standards with expertly skilled technicians supervising the manufacturing process in all phases to ensure that our parts will perform and last.

FP Diesel is a military approved supplier for the 53 Series Detroit Diesel engine. But the parts we supply for the 53 aren't the only ones that go through government testing. Every FP Diesel part must pass through high-level quality control. Plus, every part is tracked throughout the entire distribution process.

## Customer Service

FP Diesel customer service representatives are among the most experienced and knowledgeable in the industry, with hands-on medium and heavy-duty experience and in-depth knowledge of engine parts and applications. With one call to your



representative you'll have answers to any product, technical, order processing, billing, warranty, pricing, order tracking or availability questions you may have. Customer service that goes the extra mile also means you not only get the parts you need, but expert assistance from a person who knows the market.

Plus, our computerized inventory system allows us to ship orders promptly anywhere in the world, while our easy-to-use cataloging system makes ordering FP Diesel parts fast and simple. For the parts and information you need, count on FP Diesel to go the extra mile.



## Coverage

### Global Technology Behind Every Part

The FP Diesel product offering is a comprehensive line of diesel and natural gas engine replacement parts that provide all the coverage necessary to meet your heavy-duty engine rebuilding needs. FP Diesel also offers a full line of gaskets and elastomeric products. For more specific information, please refer to our full-line catalogs, which are engine and machine specific and follow OEM format. To ensure exact part number replacement, these catalogs reference OEM part numbers and features technical information relating to the specific engine being serviced.



## Products and Catalogs

### Caterpillar

Replacement Caterpillar products cover 3200, 3300, 3400, 3500, D Series and G Series engines. This coverage extends from cylinder heads, fuel injection, cam and crankshafts, cylinder kits, valvetrain and electrical to engine bearings, transmission, hydraulic gasket sets and more. **Refer to FP Diesel catalog No. CA0010 (parts) and CA0020 (gaskets).**

### Cummins

FP Diesel provides replacement parts coverage for V378, V504, V555, Small Vee Engines, V/VT 903, 855 Series, N14, L10, B Series, C Series, V/VT1710, N743 and K/KTA 19-, 38- and 50-liter engines, as well as components for Jacobs® brakes. **Refer to FP Diesel catalog No. CA0030.**

### Detroit Diesel

FP Diesel offers the most complete coverage in the replacement parts industry for Detroit Diesel, with an extensive line of components and kits for the 8.2-liter, 53 Series, 60 Series, 71 Series, 92 Series and 149 Series engines. **Refer to FP Diesel catalog No. CA0040 for 2-cycle engines or FP Diesel catalog No. CA0045 for 4-cycle engines.**

### John Deere

FP Diesel offers a broad range of in-frame and complete overhaul kits and related components for 300 Series, 400 Series, 500 Series and Powertech engines. **Refer to FP Diesel catalog No. CA0085.**

### Komatsu

Extensive coverage for Komatsu S6D155 and SA6D155 engines, as well as a full line of replacement parts for

### Komatsu (continued)

Komatsu machines using Cummins N743, KT/KTA 19-, 38- and 50-liter engines, and the Cummins 855. **Refer to FP Diesel catalog No. CA0085.**

### Mack

FP Diesel has a broad line for Mack, early ENDT 675 and 676 engines, as well as parts for later EM6 with both two- and four-valve head configurations. **Refer to FP Diesel catalog No. CA0060.**

### International/Navistar

International coverage extends from the 6.9 and 7.3 liter, DT-360 and DT-466 through the 9.0 liter engine. **Refer to FP Diesel catalog No. CA0050.** For agricultural applications, FP Diesel also services the DT-414 and DT-436 Case/I.H. engines. **For industrial and agricultural applications, refer to FP Diesel catalog No. CA0188.**

### Case

FP Diesel has a complete range of kits and components for the 188, 207, 301, 366, 451 and 504-Case engines along with the 4-390 & 4T-390, 6-590 & 6T-590, 6T-830 & 6TA-830, LTA 10 and NTA 855 B/C III Cummins engines. **Refer to FP Diesel catalog No. CA0095.**

### Commercial, Ag, Industrial Engines

The FP Diesel CA0188 catalog includes all the engine manufacturers not covered in the FP Diesel name-plate specific catalogs. Replacement engine components for Allis-Chalmers, Bedford, Bendix-Westinghouse, Briggs & Stratton, Buda, Case Tractor, Chevrolet MD Truck, Climax, Continental, Dodge MD Truck, Ford Tractor, GMC MD Truck, Hercules, IHC Tractor, Isuzu Forklift, KHD, Kohler, LeRoi, Massey Ferguson, Mercedes, Mazda Forklift, Minneapolis-Moline, Mitsubishi, Novo, Oliver, Perkins, Superior, Thermo-King, Volvo, Waukesha, White and Wisconsin are included in the **FP Diesel CA0188 catalog.**







## Engine Kits

*Global Technology Behind Every Part*

The FP Diesel Engine Kit program allows you to select a kit tailored to the job at hand. Whether performing a complete overhaul or in-frame repair, FP Diesel engine kits contain all the necessary components to complete the rebuild job. This comprehensive program provides you with the following:

- Concise application information
- One price look-up
- A full complement of oversizes and undersizes
- Master kits that include full gasket sets

### How To Specify FP Diesel Engine Kits

Many FP Diesel engine kits have several variations in components that are available depending on the specific engine. Overhaul Kits are designed to contain all the parts necessary to rebuild a particular engine. To assure that the kit is correct and complete, all that is necessary is for you to supply the engine information located on the Data Plate on the side of the engine block. In some cases the block casting number and the connecting rod number are also required. This information enables your FP Diesel service representative to configure the Engine Kit to your particular requirements insuring that everything is properly accounted for. In cases where there are no variable components, we have pre-configured the kits to include all the necessary parts for that application.

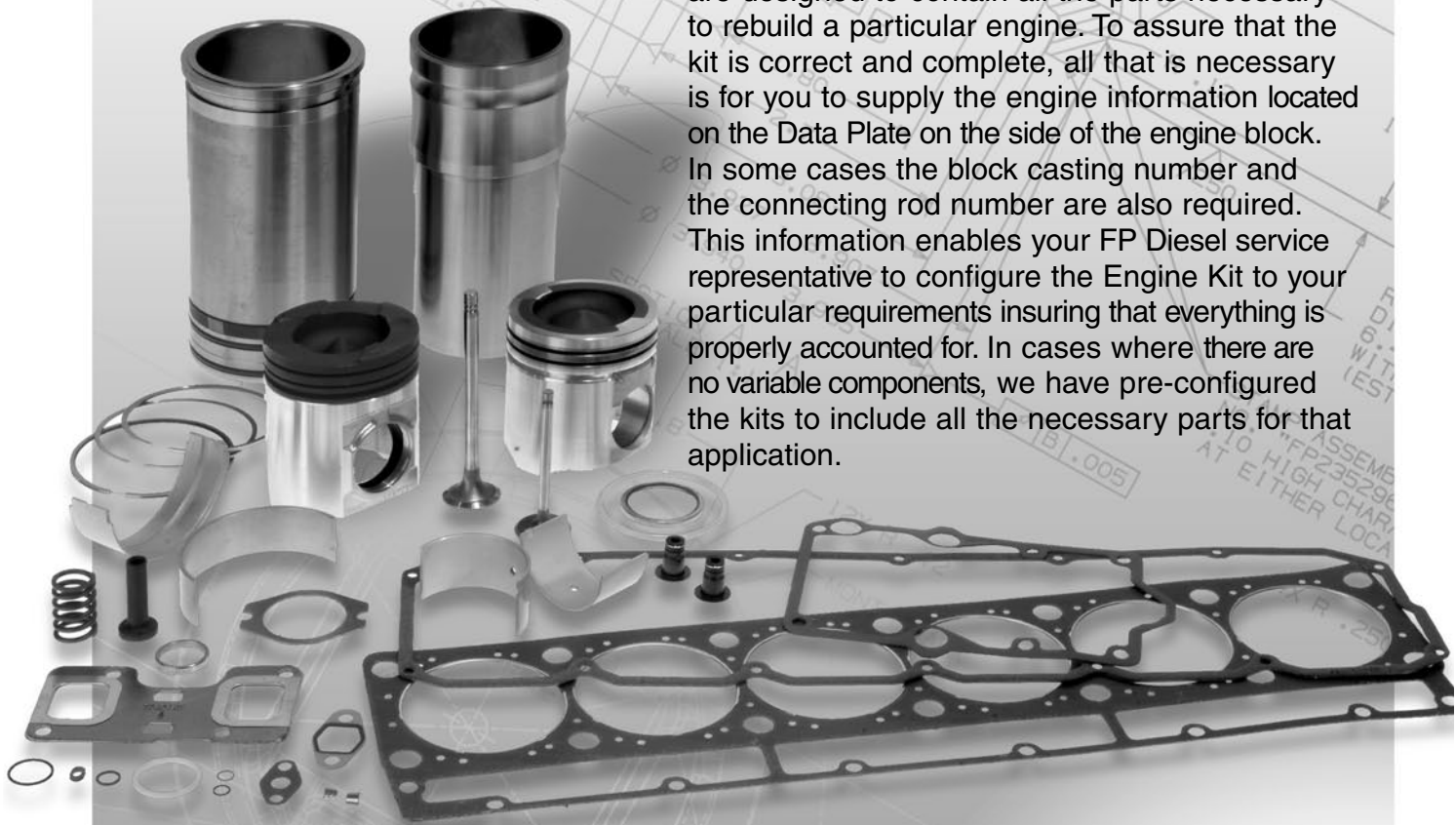



## How To Order Overhaul & In-frame Kits

*Global Technology Behind Every Part*

### **Global Technology Behind Every Part**

The FP Diesel® Engine Kit program allows you to select a kit tailored to the job at hand. Whether performing a complete overhaul or in-frame repair, our engine kits contains all of the necessary components to complete the rebuild.

#### **STEP ONE** Gather the necessary engine information

To make sure you order and receive the exact kit you need, be sure to have these important answers for each major engine nameplate:

#### **STEP TWO** Consult the FP Diesel print or online catalog

Federal-Mogul offers the industry's most convenient and up-to-date product lookup tools through the powerful [www.FMe-cat.com](http://www.FMe-cat.com) website. Simply choose your region and then click on the "Commercial, Ag and Industrial" link. You can use the fast, easy electronic lookup and interchange tools or click "Digital Catalogs" to access "virtual" print catalogs.

#### **STEP THREE** Call us today!

Call 800-237-7425 to place your order. Before you know it, your custom engine overhaul kit will be delivered!

<b>Navistar®</b>
Engine
Serial Number
Piston Number
DT-466 – Valve Cover or Crankcase-Mounted Breather
Crank Size
In-Frame Gasket Set or Complete Gasket Set
<b>Caterpillar®</b>
Engine/Machine
Serial & Arrangement Number
3200 Series – Std. or Oversize Pistons and Ring Sets (2- or 3-Ring)
Crank Size
In-Frame Gasket Set or Complete Gasket Set
<b>Cummins®</b>
Engine
CPL or Piston Number
Big or Small Cam
Liner Size
Crank Size
In-Frame Gasket Set or Complete Gasket Set
Head Set w/Std. Water Grommets or 0.010" Oversize
<b>Detroit Diesel®</b>
Engine
Model & Serial Number
Turbo or Natural
Trunk or Crosshead Piston
Liner Size
Crank Size
Head Set & Pan Gasket or Complete Overhaul Gasket Set
If Complete, Crank Seals Not Included – Need Them
Steel or Aluminum Valve Covers
<b>Mack®</b>
Engine
Model Number
Piston Number
Liner Size
Crank Size
In-Frame Gasket Set or Complete Gasket Set





# Engine Bearings

*Global Technology Behind Every Part*

## Engine Bearing Material Selection

When selecting engine bearings, most rebuilders concentrate on getting the proper clearances and maintaining adequate oil pressure. Durability is expected from any bearing chosen, and the advantages of different bearing materials may not be considered. If engine operating conditions are considered and bearing materials chosen accordingly, the likelihood of engine longevity is greater. No single material can be correct for every application. FP Diesel engine bearings are equal to or better than the

original equipment specifications for material and design. We also provide alternatives to address unique problems and special needs.

In heavy duty applications there are a number of materials that will do an excellent job. Each alloy has advantages in terms of resistance to corrosion, rate of wear and fatigue strength. The latter characteristic is critical in engines that operate under high loads, generate considerable heat and may be subjected to occasional detonation.

### Bi-Metal Aluminum Alloys – Plated and Unplated

Diesel fuels, moisture, and engine “blow-by” introduce many contaminants into the crankcase. Aluminum engine bearing materials provide outstanding resistance to the corrosive effects of these substances, and are the product of choice for most current original equipment vehicle manufacturers. The modern bi-metal aluminum engine bearing contains silicon. As a result of using silicon, the alloy resists seizure and dramatically reduces or

eliminates bearing wear. This contributes to today’s extended engine life. Aluminum is often the best material for a daily driven vehicle. Adding an overplate to an aluminum engine bearing will further enhance embedability and conformability. Continued efforts to remove lead from our environment guarantee that aluminum will become the preferred engine bearing material for most applications.

### Tri-Metal Alloys

Tri-Metal engine bearings, such as our H-14 and H-24 alloys, have excellent fatigue resistance, but are less resistant to corrosion damage than aluminum bearings. These bearing materials are accepted by engine builders worldwide, and are proven to be reliable in a wide range of uses. While OE manufacturers are moving to aluminum for their needs, many rebuilders still specify the tri-metal bearings for older engines.

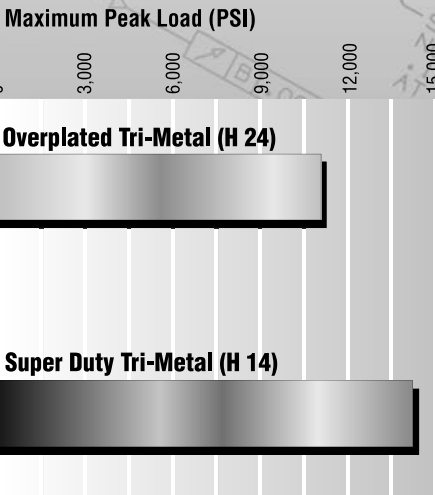



## Heavy Duty Pistons

*Global Technology Behind Every Part*

FP Diesel heavy duty pistons are designed and produced for severe operating conditions. Federal-Mogul is one of the world's leading manufacturers of heavy duty pistons offering one and two-piece designs including aluminum, articulated, cast iron and steel materials. For severe and high load applications, FP Diesel pistons include a metallurgically bonded NI-resist insert in the top and in some cases, the second ring groove. The NI-resist insert minimizes groove wear and reduces pound-out from the compression ring. Anodized heads and graphite-coated skirts offer additional durability in severe applications. Federal-Mogul also utilizes an in-house, patented magnesium-phosphate coating to reduce the piston corrosion caused by high-sulfate diesel fuels and break-in wear on problematic applications.

We design our heavy duty pistons using the latest in computer aided design (CAD) software. Each application is thoroughly researched to ensure the proper dimensional and metallurgical requirements. And since we also design and manufacture cylinder liners and piston rings, our engineers can make sure each piston we develop provides optimum performance as part of the "power-cylinder" system.







## Sleeve Assemblies

*Global Technology Behind Every Part*

Cylinder sleeves are produced by Federal-Mogul in a QS9000 registered facility complete with casting, induction hardening, machining, measurement and design capabilities. We start with raw castings produced on a state-of-the-art molding line specifically designed for the manufacture of static cast cylinder liners. The static castings produced by our foundry have a very consistent microstructure and superior scuffing resistance.

Certain applications are induction hardened or thru-hardened to enhance the wear characteristics and strength of the liner. Hardened liners are typically used in engines highly susceptible to dirt contamination, such as construction or agricultural applications.

Machining is performed on modern CNC equipment to ensure dimensional stability and exacting tolerances. Cylinder liners are typically finish honed to generate a plateau finish. The plateau finish promotes rapid ring seating

during break-in while providing a long-wearing sealing surface.

FP Diesel offers sleeves for wet, dry and repair applications. Sleeve assemblies or kits include the sleeve, piston, piston pin and lock rings, piston rings and sealing rings.





## Abbreviations Used

*Global Technology Behind Every Part*

<b>ABBREVIATION</b>	<b>DESCRIPTION</b>
&	And
2WD	Two Wheel Drive
4WD	Four Wheel Drive
A.I.R.	Air Injector Reactor
A/C	Air Conditioning
A/R	As Required
A/T	Automatic Transmission
ABS	Anti-lock Brake System
AC	Alternating Current
Acc.	Accessory
Adj.	Adjustable
Adv.	Advance
Aft.	After
Alt.	Altitude
Alum.	Aluminum
Amp.	Ampere
AOD	Automatic Overdrive
Appl.	Application
Approx.	Approximately
Asst.	Assist
Assy.	Assembly
ATV	All Terrain Vehicle
Auto.	Automatic
Auto. Trans.	Automatic Transmission
Aux.	Auxiliary
Avail.	Available
Avg.	Average
AWD	All Wheel Drive
Bal.	Balance
Batt.	Battery
Bbl.	Barrel
Bbl. Carb.	Barrel Carburetor
Bef.	Before
Brg.	Bearing
Brkt.	Bracket
C	Celsius
C.I.	Cast Iron
C.R.	Compression Ratio
C/L	Centerline
Calib.	Calibration
Calif.	California
Cam	Camshaft
Can.	Canada
Carb.	Carburetor
Cat.	Catalytic
cc	Cubic Centimeter
CCW	Counter Clockwise
CD	Compression Distance
CFFI	Cross Fire Fuel Injection
CFI	Central Fuel Injection
CFM	Cubic Feet per Minute
CID	Cubic Inch (Displacement)
Cld.	Cooled
Clg.	Cooling
Clr.	Cooler
cm	Centimeter
Cntr. Bore	Counter Bore

<b>ABBREVIATION</b>	<b>DESCRIPTION</b>
Compl.	Complete
Con. Rod	Connecting Rod
Cruise	Cruise Control
Ctr.	Center
CW	Clockwise
Cyl.	Cylinder
Cyl. Hd.	Cylinder Head
DC	Direct Current
Deg.	Degree
DFI	Digital Fuel Injection
DI	Direct Injection
Dia.	Diameter
Dim.	Dimension
Dir. Inj.	Direct Injection
Disc	Discontinued
Dist.	Distributor
DOHC	Dual Overhead Camshaft
Dr.	Door or Drive
E.E.C.	Electronic Engine Control
E.I.S.	Electronic Ignition System
Ea.	Each
Ecc.	Eccentric
ECM	Electronic Computer Module
ECM	Electronic Control Module
ECM	Engine Control Module
Econ.	Economy
ECS	Electronic Controlled Spark
EFI	Electronic Fuel Injection
Elec.	Electric
Emis.	Emission
Eng.	Engine
Equip.	Equipment
Etc.	Et Cetera
Exc.	Except
Exh.	Exhaust
Exp.	Export
Ext.	Exterior
Ext.	External
F	Fahrenheit
Fed.	Federal
FI	Fuel Injection
Flex.	Flexible
Flg.	Flange
Flwr.	Follower
Frg.	Forged or Forging
Frt.	Front
FWD	Front Wheel Drive
Gal.	Gallon
Gas	Gasoline
GPH	Gallons Per Hour
GPM	Gallons Per Minute
Grv(s)	Groove(s)
Gskt.	Gasket
GVW	Gross Vehicle Weight
H/D	Heavy Duty
Hd.	Head
HEI	High Energy Ignition
Hi	High



## Abbreviations Used

*Global Technology Behind Every Part*

### ABBREVIATION ..... DESCRIPTION

Hi Alt.....	High Altitude
Hi-Perf.....	High Performance
Hi-Temp.....	High Temperature
HO.....	High Output
Horiz.....	Horizontal
HP.....	Horsepower
HSC.....	High Swirl Combustion
Hyd.....	Hydraulic
I/C.....	Intercooler
I.D.....	Identification
ID.....	Inside Diameter
IDI.....	Indirect Injection
In. Frm.....	In Frame
in.....	Inch
Incl.....	Includes
Ind.....	Industrial
Inj.....	Injection
Int.....	Intake
Inter.....	Intermediate
L.....	Liter
L.H.....	Left Hand
L/D.....	Light Duty
Lgth.....	Length
LPG.....	Liquid Propane Gas
M/D.....	Medium Duty
M/T.....	Manual Transmission
Man.....	Manual
Man. Trans.....	Manual Transmission
Max.....	Maximum
Mech.....	Mechanical
MFI.....	Multi-Port Fuel Injection
Min.....	Minimum
mm.....	Millimeters
MPH.....	Miles Per Hour
Mtl.....	Material
N/A.....	Not Available
N/R.....	Not Required
Nat.....	Natural
Nat. Asp.....	Naturally Aspirated
Neg.....	Negative
Neut.....	Neutral
No.....	Number
Nom.....	Nominal
Norm.....	Normal
O.A.L.....	Overall Length
O.E.....	Original Equipment
O/D.....	Overdrive
O/S.....	Oversize
Obs.....	Obsolete
OD.....	Outside Diameter
OEM.....	Original Equipment Manufacturer
OHC.....	Overhead Cam
OHV.....	Overhead Valve
Opt.....	Optional
Orig.....	Original
oz.....	Ounce
P. T.O.....	Power Take Off
P/S.....	Power Steering

### ABBREVIATION ..... DESCRIPTION

Pass.....	Passenger
Pc(s).....	Piece(s)
PCV.....	Positive Crankcase Ventilation
Perf.....	Performance
Pkg.....	Package
Pos.....	Positive
Prem.....	Premium
Pri.....	Primary
PSI.....	Pound Per Square Inch
Pwr.....	Power
Qtr.....	Quarter
Qty.....	Quantity
R.B.P.....	Ring Below Pin
R.H.....	Right Hand
Ref.....	Reference
Reg.....	Regular
Reman.....	Remanufactured
Req'd.....	Required
Rev.....	Revision
Rev. Rot.....	Reverse Rotation
Rlr.....	Roller
RMB.....	Rear Main Bearing
Rot.....	Rotation
RPM.....	Revolutions Per Minute
Rr.....	Rear
RWD.....	Rear Wheel Drive
S/C.....	Supercharged
Seal. Rings.....	Sealing Rings
Ser.....	Serial or Series
Ser. No.....	Serial Number
SFI.....	Sequential Fuel Injection
Slv.....	Sleeve
SOHC.....	Single Overhead Cam
Spd.....	Speed
Spec.....	Special
Sta.....	Station
Std.....	Standard
Sys.....	System
T/C.....	Turbocharged
Tach.....	Tachometer
TBI.....	Throttle Body Injection
Temp.....	Temperature
TPI.....	Tuned Port Injection
Trans.....	Transmission
Trk.....	Truck
TTY.....	Torque-to-Yield
TURBO.....	Turbocharged
U/S.....	Under Size
Veh.....	Vehicle
VIN.....	Vehicle Identification Number
Vlv.....	Valve
VSS.....	Valve Stem Seal
w/.....	With
w/o.....	Without
Wagon.....	Station Wagon
Wt.....	Weight



# Conversion Tables

## Decimal Equivalents

### Inches to Millimeters

.001	0.0254mm
.002	0.0508mm
.003	0.0762mm
.004	0.1016mm
.005	0.1270mm
.006	0.1524mm
.007	0.1778mm
.008	0.2032mm
.009	0.2286mm
.010	0.2540mm
.020	0.5080mm
.030	0.7620mm
.040	1.0160mm
.050	1.2700mm
.060	1.5240mm
.070	1.7780mm
.080	2.0320mm
.090	2.2860mm
.100	2.5400mm

### Millimeters to Inches

0.025mm	.000984
0.050mm	.001968
0.075mm	.002952
0.100mm	.003937
0.125mm	.004921
0.150mm	.005905
0.175mm	.006889
0.200mm	.007874
0.225mm	.008858
0.250mm	.009842
0.500mm	.019685
0.750mm	.029527
1.000mm	.039370
1.250mm	.049212
1.500mm	.059055
1.750mm	.068897
2.000mm	.078740
2.250mm	.088582
2.500mm	.098425

### Conversion Formulae

28.349 gm./oz.
453.592 gm./lb.
16.387 cc/in. <sup>3</sup>
61.024 in. <sup>3</sup> /L
3.785 L/U.S. gal.
4.546 L/Imp. gal.
0.264 U.S. gal./L
0.220 Imp. gal./L

8THS.	16THS.	32NDS.	64THS.	DECIMALS	mm
			1/64	.015625	.396875
		1/32		.031250	.793750
			3/64	.046875	1.190625
	1/16			.062500	1.587500
			5/64	.078125	1.984375
		3/32		.093750	2.381250
			7/64	.109375	2.778125
1/8				.125000	3.175000
		5/32		.140625	3.571875
			9/64	.156250	3.968750
	3/16			.171875	4.365625
			11/64	.187500	4.762500
			13/64	.203125	5.159375
		7/32		.218750	5.556250
1/4				.234375	5.953125
			15/64	.250000	6.350000
			17/64	.265625	6.746875
		9/32		.281250	7.143750
			19/64	.296875	7.540625
	5/16			.312500	7.937500
			21/64	.328125	8.334375
		11/32		.343750	8.731250
3/8				.359375	9.128125
			23/64	.375000	9.525000
			25/64	.390625	9.921875
		13/32		.406250	10.318750
			27/64	.421875	10.715625
	7/16			.437500	11.112500
			29/64	.453125	11.509375
		15/32		.468750	11.906250
1/2				.484375	12.303125
			31/64	.500000	12.700000
			33/64	.515625	13.096875
		17/32		.531250	13.493750
			35/64	.546875	13.890625
	9/16			.562500	14.287500
			37/64	.578125	14.684375
		19/32		.593750	15.081250
5/8				.609375	15.478125
			39/64	.625000	15.875000
			41/64	.640625	16.271875
		21/32		.656250	16.668750
			43/64	.671875	17.065625
	11/16			.687500	17.462500
			45/64	.703125	17.859375
		23/32		.718750	18.256250
			47/64	.734375	18.653125
3/4				.750000	19.050000
			49/64	.765625	19.446875
		25/32		.781250	19.843750
			51/64	.796875	20.240625
	13/16			.812500	20.637500
			53/64	.828125	21.034375
		27/32		.843750	21.431250
7/8				.859375	21.828125
			55/64	.875000	22.225000
			57/64	.890625	22.621875
		29/32		.906250	23.018750
			59/64	.921875	23.415625
	15/16			.937500	23.812500
			61/64	.953125	24.209375
		31/32		.968750	24.606250
			63/64	.984375	25.003125
1				1.000000	25.003125







## Sealed Power to FP Diesel Consolidated Engine Kits

*Global Technology Behind Every Part*

FP Diesel has consolidated the Commercial Engine part numbers and many of the Sealed Power Engine Kits. This is a list of the John Deere Sealed Power Tractor kits that have been replaced by FP Diesel Engine Kits. You will find that the FP Diesel Kit will contain the same basic components as the Sealed Power Kit and the FP Diesel Kit will have additional components gaskets, oil seal kit, connecting rod bolts, engine bearings and all cylinder kits pertaining to that particular engine family.

<b>Sealed Power Kit No.</b>		<b>FP Diesel Kit No.</b>	<b>Sealed Power Kit No.</b>		<b>FP Diesel Kit No.</b>
KST-2416 F	Replaced By	FP-404DE-OHK	KST-2520 A	Replaced By	FP-404DL-OHK
KST-2416 G	Replaced By	FP-404DE-OHK	KST-2596 C	Replaced By	FP-404DN-OHK
KST-2502 A	Replaced By	FP-152EORL-OHK	KST-2633 A	Replaced By	FP-276DSP-OHK
KST-2503 A	Replaced By	FP-202EORL-OHK	KST-2634 A	Replaced By	FP-276T-OHK
KST-2503 C	Replaced By	FP-152LOHK	KST-2634 C	Replaced By	FP-414T-OHK
KST-2515 A	Replaced By	FP-202L-OHK	KST-2636 A	Replaced By	FP-414D-OHK
KST-2515 C	Replaced By	FP-164M-OHK	KST-2640 A	Replaced By	FP-466TAE-OHK
KST-2515 D	Replaced By	FP-219M-OHK	KST-2688 A	Replaced By	FP-135GE-OHK
KST-2516 A	Replaced By	FP-329M-OHK	KST-2688 C	Replaced By	FP-180GL-OHK
KST-2516 C	Replaced By	FP-164L-OHK	KST-2689 A	Replaced By	FP-135GE-OHK
KST-2516 D	Replaced By	FP-329L-OHK	KST-2689 C	Replaced By	FP-180GE-OHK
KST-2516 E	Replaced By	FP-219L-OHK	KST-2716 A	Replaced By	FP-619M-OHK

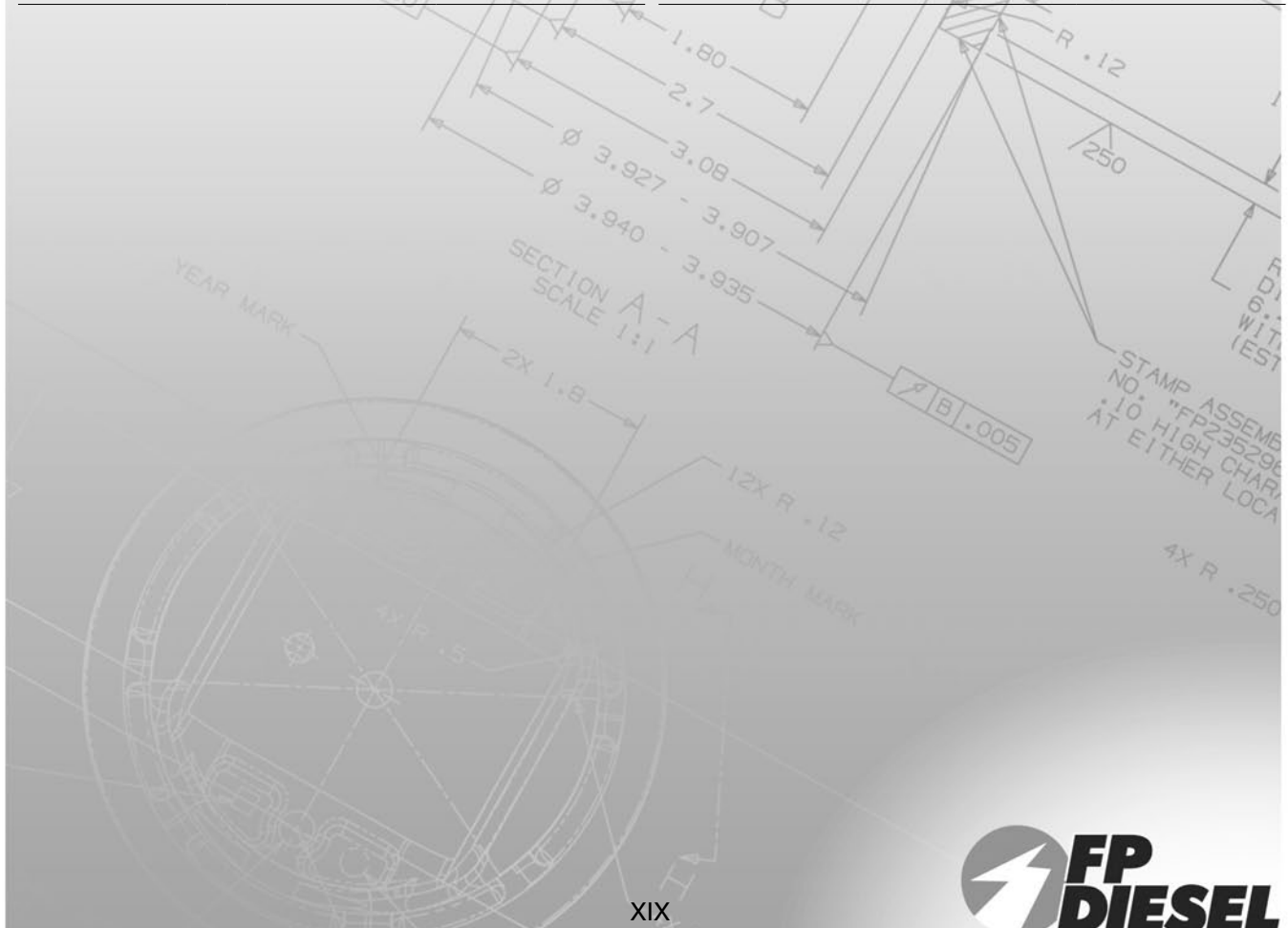



# Specialty Gasket Sets

*Global Technology Behind Every Part*

FP Diesel Specialty Gasket Sets are created with additional gaskets necessary to complete the installation of specific components. These gasket sets are different from the OE configurations to include gaskets or seals that are not usually found combined in OE sets.

SERIES	PART NO.	ENGINE	DESCRIPTION	SERIES	PART NO.	ENGINE	DESCRIPTION
300	FP-RE37715-WS	276D, T & 4045	Gasket Set, Complete Overhaul w/Front and Rear Seals	400	FP-AR53631-WS	404D Mid	Gasket Set, Complete Overhaul w/Front and Rear Seals
300	FP-RE38555-WS	414, 6068	Gasket Set, Complete Overhaul w/Front and Rear Seals	400	FP-AR63269-WS	404T, A Late	Gasket Set, Complete Overhaul w/Front and Rear Seals
300	FP-RE38558-WS	202	Gasket Set, Complete Overhaul w/Front and Rear Seals	400	FP-AR63938-WS	404D Late	Gasket Set, Complete Overhaul w/Front and Rear Seals
300	FP-RE38568-WS	303	Gasket Set, Complete Overhaul w/Front and Rear Seals	400	FP-AR98845-WS	466T, A	Gasket Set, Complete Overhaul w/Front and Rear Seals
300	FP-RE38570-WS	152	Gasket Set, Complete Overhaul w/Front and Rear Seals	400	FP-RE35647-WS	6076 Early	Gasket Set, Complete Overhaul w/Front and Rear Seals
300	FP-RE38857-WS	219, 239, 4039	Gasket Set, Complete Overhaul w/Front and Rear Seals	400	FP-RE64206-WS	6076 Late	Gasket Set, Complete Overhaul w/Front and Rear Seals
300	FP-RE38858-WS	359, 6059	Gasket Set, Complete Overhaul w/Front and Rear Seals	400	FP-404A	404A Early	Gasket Kit, Aftercooler
300	FP-RE38859-WS	329	Gasket Set, Complete Overhaul w/Front and Rear Seals	400	FP-466A	466A, 404A Late	Gasket Kit, Aftercooler
300	FP-RE50978-WS	164, 179, 3029	Gasket Set, Complete Overhaul w/Front and Rear Seals	400	FP-6076A	6076 Early (single pass)	Gasket Kit, Aftercooler
300	FP-4039A	4039, 6059	Gasket Kit, Aftercooler	400	FP-6076ADP	6076 Late (dual pass)	Gasket Kit, Aftercooler
300	PG100FS	100 (L2)	Gasket Set, Full Set	400	FP-58952	404T, A Late, 466D, 466T, A & 6076 Early	Gasket Kit, Oil Cooler Installation
300	PG100HS	100 (L2)	Gasket Set, Head Gasket Set	400	PG270ES	270 Early	Gasket Set, In-frame Overhaul
300	PG113FS	113 (L2)	Gasket Set, Full Set	400	PG270LS	270 Late	Gasket Set, In-frame Overhaul
300	PG115FS	115, 145, 165	Gasket Set, Full Set	400	PG404DES	404D Early	Gasket Set, In-frame Overhaul
300	PG152S	152	Gasket Set, In-frame Overhaul	400	PG404DLS	404D Late	Gasket Set, In-frame Overhaul
300	PG164S	164, 179, 3029	Gasket Set, In-frame Overhaul	400	PG404DMS	404D Mid	Gasket Set, In-frame Overhaul
300	PG175FS	149, 175, 190	Gasket Set, Full Set	400	PG404TAS	404T, A	Gasket Set, In-frame Overhaul
300	PG175HS	149, 175, 190	Gasket Set, Head Gasket Set	400	PG466DS	466D	Gasket Set, In-frame Overhaul
300	PG202S	202	Gasket Set, In-frame Overhaul	400	PG466TAS	466T, A	Gasket Set, In-frame Overhaul
300	PG219S	219, 239, 4039, 276, 4045	Gasket Set, In-frame Overhaul	400	PG6076ES	6076 Early	Gasket Set, In-frame Overhaul
300	PG219CS	135, 152, 164, 179, 180, 202, 219, 276	Gasket Set, Conversion Set	400	PG6076LS	6076 Late	Gasket Set, In-frame Overhaul
300	PG303S	303	Gasket Set, In-frame Overhaul	400	PG400PS	404D Late, 404T, A, 466D, 466T, A	Gasket Set, Oil Pan
300	PG308FS	308, 321	Gasket Set, Full Set	400	PG401PS	6076	Gasket Set, Oil Pan
300	PG308XFS	308, 321	Gasket Set, Full Set	400	PG402PS	270	Gasket Set, Oil Pan
300	PG329S	329	Gasket Set, In-frame Overhaul	400	PG403PS	404D Early	Gasket Set, Oil Pan
300	PG329HS	329, 359	Gasket Set, Head Gasket Set	500	FP-AR53614-WS	531D	Gasket Set, Complete Overhaul w/Front and Rear Seals
300	PG359S	359, 6059, 414, 6068	Gasket Set, In-frame Overhaul	500	FP-RE17046-WS	531A	Gasket Set, Complete Overhaul w/Front and Rear Seals
300	PG300PS	152, 164, 179, 3029	Gasket Set, Oil Pan	500	FP-RE17050-WS	531T	Gasket Set, Complete Overhaul w/Front and Rear Seals
300	PG301PS	202, 219, 239, 4039, 276, 4045	Gasket Set, Oil Pan	500	FP-RE37416-WS	619	Gasket Set, Complete Overhaul w/Front and Rear Seals
300	PG302PS	303, 329	Gasket Set, Oil Pan	500	FP-500A	531A, 619A	Gasket Kit, Aftercooler
300	PG303PS	359, 6059, 414, 6068	Gasket Set, Oil Pan	500	PG531AS	531A	Gasket Set, In-frame Overhaul
400	FP-AR100638-WS	466D	Gasket Set, Complete Overhaul w/Front and Rear Seals	500	PG531DS	531D	Gasket Set, In-frame Overhaul
400	FP-AR53033-WS	270 Early	Gasket Set, Complete Overhaul w/Front and Rear Seals	500	PG531TS	531T	Gasket Set, In-frame Overhaul
400	FP-AR53035-WS	270 Late	Gasket Set, Complete Overhaul w/Front and Rear Seals	500	PG619S	619	Gasket Set, In-frame Overhaul
400	FP-AR53094-WS	404T, A Early	Gasket Set, Complete Overhaul w/Front and Rear Seals	500	PG500PS	531D, T, A	Gasket Set, Oil Pan
400	FP-AR53626-WS	404D Early	Gasket Set, Complete Overhaul w/Front and Rear Seals	500	PG501PS	619	Gasket Set, Oil Pan
				500	FP-RE57187-WS	8.1L Powertech	Gasket Set, Complete Overhaul w/Front and Rear Seals
					PG6081S	8.1L Powertech	Gasket Set, In-frame Overhaul



# Additional Specialty Gaskets & Antifriction Bearings Coverage

*Global Technology Behind Every Part*

The parts listed on this page represent additional coverage not found in the application section of this catalog. These parts are currently available and in stock. The FP Diesel part number utilizes the John Deere OEM number as the part suffix. The Part Type is also listed to help in the identification and part selection of the component.

PART NUMBER	PART TYPE	PART NUMBER	PART TYPE	PART NUMBER	PART TYPE
FP-R100336	Clutch Housing Gasket	FP-JD9350	Ball Bearing	FP-JD7259	Taper Bearing Cup
FP-R33425	Clutch Housing Gasket	FP-JD9390	Ball Bearing	FP-JD7266	Taper Bearing Cup
FP-R43260	Clutch Housing Gasket	FP-JD9439	Ball Bearing	FP-JD7270	Taper Bearing Cup
FP-R43408	Clutch Housing Gasket	FP-JD9440	Ball Bearing	FP-JD7292	Taper Bearing Cup
FP-R50335	Clutch Housing Gasket			FP-JD7297	Taper Bearing Cup
FP-R55390	Clutch Housing Gasket	FP-JD8720	Cylindrical Outer Race	FP-JD7409	Taper Bearing Cup
FP-R57430	Clutch Housing Gasket			FP-JD7418	Taper Bearing Cup
FP-R63722	Clutch Housing Gasket	FP-JD10190	Taper Bearing Cone	FP-JD7424	Taper Bearing Cup
FP-R92411	Clutch Housing Gasket	FP-JD7205	Taper Bearing Cone	FP-JD7425	Taper Bearing Cup
FP-R98011	Clutch Housing Gasket	FP-JD7209	Taper Bearing Cone	FP-JD7438	Taper Bearing Cup
FP-R98915	Clutch Housing Gasket	FP-JD7216	Taper Bearing Cone	FP-JD7439	Taper Bearing Cup
FP-R99286	Clutch Housing Gasket	FP-JD7222	Taper Bearing Cone	FP-JD7441	Taper Bearing Cup
FP-R99288	Clutch Housing Gasket	FP-JD7224	Taper Bearing Cone	FP-JD7445	Taper Bearing Cup
FP-R99291	Clutch Housing Gasket	FP-JD7372	Taper Bearing Cone	FP-JD7448	Taper Bearing Cup
FP-R99292	Clutch Housing Gasket	FP-JD7378	Taper Bearing Cone	FP-JD7449	Taper Bearing Cup
		FP-JD7386	Taper Bearing Cone	FP-JD7466	Taper Bearing Cup
FP-R97456	Water Pump Gasket	FP-JD7395	Taper Bearing Cone	FP-JD8206	Taper Bearing Cup
		FP-JD8100	Taper Bearing Cone	FP-JD8207	Taper Bearing Cup
FP-T132943	Jake Brake Gasket Set	FP-JD8101	Taper Bearing Cone	FP-JD8213	Taper Bearing Cup
FP-T148483	Jake Brake Gasket Set	FP-JD8112	Taper Bearing Cone	FP-JD8214	Taper Bearing Cup
FP-T168463	Jake Brake Gasket Set	FP-JD8128	Taper Bearing Cone	FP-JD8219	Taper Bearing Cup
		FP-JD8130	Taper Bearing Cone	FP-JD8223	Taper Bearing Cup
FP-JD8802	Needle Bearing	FP-JD8131	Taper Bearing Cone	FP-JD8225	Taper Bearing Cup
FP-JD8828	Needle Bearing	FP-JD8134	Taper Bearing Cone	FP-JD8226	Taper Bearing Cup
FP-JD8876	Needle Bearing	FP-JD8135	Taper Bearing Cone	FP-JD8230	Taper Bearing Cup
		FP-JD8158	Taper Bearing Cone	FP-JD8237	Taper Bearing Cup
FP-DC20277	Ball Bearing	FP-JD8174	Taper Bearing Cone	FP-JD8239	Taper Bearing Cup
FP-JD10448	Ball Bearing	FP-JD8177	Taper Bearing Cone	FP-JD8247	Taper Bearing Cup
FP-JD7124	Ball Bearing	FP-JD8186	Taper Bearing Cone	FP-JD8248	Taper Bearing Cup
FP-JD7142	Ball Bearing	FP-JD8187	Taper Bearing Cone	FP-JD8251	Taper Bearing Cup
FP-JD7143	Ball Bearing	FP-JD8188	Taper Bearing Cone	FP-JD8258	Taper Bearing Cup
FP-JD7155	Ball Bearing	FP-JD8190	Taper Bearing Cone	FP-JD8259	Taper Bearing Cup
FP-JD7162	Ball Bearing	FP-JD8194	Taper Bearing Cone	FP-JD8271	Taper Bearing Cup
FP-JD7198	Ball Bearing	FP-JD8902	Taper Bearing Cone	FP-JD8280	Taper Bearing Cup
FP-JD7654	Ball Bearing	FP-JD8903	Taper Bearing Cone	FP-JD8282	Taper Bearing Cup
FP-JD7674	Ball Bearing	FP-JD8905	Taper Bearing Cone	FP-JD8288	Taper Bearing Cup
FP-JD7689	Ball Bearing	FP-JD8913	Taper Bearing Cone	FP-JD8290	Taper Bearing Cup
FP-JD8514	Ball Bearing	FP-JD8922	Taper Bearing Cone	FP-JD8297	Taper Bearing Cup
FP-JD8524	Ball Bearing	FP-JD8929	Taper Bearing Cone	FP-JD9109	Taper Bearing Cup
FP-JD8535	Ball Bearing	FP-JD8941	Taper Bearing Cone	FP-JD9114	Taper Bearing Cup
FP-JD8537	Ball Bearing	FP-JD8954	Taper Bearing Cone	FP-JD9115	Taper Bearing Cup
FP-JD8597	Ball Bearing	FP-JD8955	Taper Bearing Cone	FP-JD9118	Taper Bearing Cup
FP-JD9214	Ball Bearing	FP-JD8956	Taper Bearing Cone	FP-JD9127	Taper Bearing Cup
FP-JD9239	Ball Bearing	FP-JD8961	Taper Bearing Cone	FP-JD9170	Taper Bearing Cup
FP-JD9245	Ball Bearing	FP-JD8962	Taper Bearing Cone	FP-JD8286	Taper Bearing Set
FP-JD9249	Ball Bearing	FP-JD8969	Taper Bearing Cone	FP-60004	Valve Guide
FP-JD9260	Ball Bearing	FP-JD8988	Taper Bearing Cone	FP-R56462	O-Ring
FP-JD9301	Ball Bearing	FP-JD9018	Taper Bearing Cone	FP-A4730R	O-Ring
FP-JD9313	Ball Bearing	FP-JD9041	Taper Bearing Cone	FP-R120972	O-Ring
FP-JD9320	Ball Bearing	FP-JD9049	Taper Bearing Cone	FP-AR55950	Cylinder Liner Sealing Ring Kit
FP-JD9321	Ball Bearing	FP-JD9050	Taper Bearing Cone		
FP-JD9331	Ball Bearing	FP-JD9055	Taper Bearing Cone		
FP-JD9345	Ball Bearing	FP-JD9058	Taper Bearing Cone		
FP-JD9346	Ball Bearing	FP-JD9069	Taper Bearing Cone		





## Warranty

### *Global Technology Behind Every Part*

The products listed in this catalog are warranted to be free from defects in material and workmanship, under normal use and service, for two years from date of installation in an engine, without mileage or hour qualification in accordance with the following limited warranty. This warranty is the sole and exclusive warranty for failure of the above parts. This exclusive remedy shall not be deemed to have failed of its essential purpose so long as Federal-Mogul is willing and able to provide the remedy provided below.

### **WARRANTY LIMITATIONS**

Federal-Mogul agrees to only pay for parts and labor needed to repair engine damages that result from the defined warranty failure. The costs are limited to parts and labor necessary for restoring the engine to its condition immediately prior to the failure. Labor costs are determined by current published rates and standards in the geographic area in which repairs are performed. Overtime or holiday rate charges are not allowed. We will also pay for maintenance products such as oil, antifreeze, belts, hoses and filter elements that are damaged because of a defined warranty failure.

Federal-Mogul is not responsible for engine failure resulting from owner, operator or third party neglect or abuse, improper installation or repair procedures, alteration or misapplication of parts, failure to properly service or maintain the engine and vehicle in accordance with applicable OEM operation and maintenance manuals or use in engine modified for competition purposes or used in competition.

OTHER THAN AS EXPRESSLY PROVIDED HEREBY, FEDERAL-MOGUL SHALL NOT, UNDER ANY CIRCUMSTANCES, BE LIABLE FOR ANY SPECIAL, INDIRECT, INCIDENTAL, OR CONSEQUENTIAL DAMAGES, INCLUDING, BUT NOT LIMITED TO, DAMAGE OR LOSS OF OTHER PROPERTY OR EQUIPMENT, LOSS OF PROFITS OR REVENUE, TRANSPORTATION AND TOWING COSTS, COST OF PURCHASED OR REPLACED GOOD, OR CLAIMS OF CUSTOMERS OF THE PURCHASER, WHICH MAY ARISE OR RESULT FROM THE SALE, INSTALLATION, OR USE OF THESE PARTS. Some jurisdictions do not allow limitations on how long an implied warranty will last or the exclusion or limitation of incidental or consequential damages, so the limitations or exclusions contained herein may or may not apply to you. This warranty gives you specific legal rights. You may also have other rights depending on the state or province in which you reside.

THIS WARRANTY IS IN LIEU OF ALL OTHER WARRANTIES, EXPRESS AND/OR IMPLIED, INCLUDING, WITHOUT LIMITATION, WARRANTIES OF MERCHANTABILITY AND OF FITNESS FOR A PARTICULAR PURPOSE AND THEY ARE EXCLUDED TO THE EXTENT THEY EXCEED THE WARRANTY COVERAGE DESCRIBED BY THIS WARRANTY.

This warranty and remedy apply to new FP Diesel engine parts from Federal-Mogul sold directly to our authorized aftermarket customers as evidenced by completed claim documentation. No agent or sales representative of Federal-Mogul Corporation has the authority to modify this warranty. Other Federal-Mogul parts may carry different warranties.

Federal-Mogul must be notified by the customer: (i) before filing a warranty claim, (ii) within one year of the date that the claim accrues, and (iii) before any work has been performed. All claims must be submitted in writing and Federal-Mogul reserves the right to examine all parts, systems and related information associated with the claim. (Note all shipping charges are the responsibility of the end-user or distributor, Federal-Mogul will not accept collect shipments). See your sales representative for detailed claim submission procedures and forms.

Use parts only for applications and interchanges in this catalog.

Failure to heed this warning could result in reduced life or failure of the part. All parts listed in this catalog are not for use in space program, atomic energy/nuclear reactor equipment, medical or aircraft applications. Federal-Mogul reserves the right to make product improvements/changes, with respect to similar products previously manufactured, without notice and without incurring liability.





## Warranty

### Global Technology Behind Every Part

Les produits indiqués dans ce catalogue sont garantis contre toute défectuosité de matériel et de fabrication, dans des conditions d'utilisation et d'entretien normales, sur une période de deux ans à partir de la date d'installation dans un moteur, sans qualification de kilométrage ou horaire, conformément à la garantie limitée suivante.

Cette garantie est la garantie unique et exclusive pour la défaillance des pièces précitées. Ce recours exclusif ne doit pas être présumé comme ayant échoué à son objectif essentiel, tant que Federal-Mogul approuve et est capable de fournir le recours fourni ci-dessous.

### LIMITATIONS DE GARANTIE

Federal-Mogul accepte uniquement de payer les pièces et la main-d'œuvre nécessaires pour réparer les dommages de moteur qui résultent de la défaillance de la garantie définie. Les coûts sont limités aux pièces et à la main-d'œuvre nécessaires pour la restauration du moteur à l'état auquel il se trouvait juste avant la défaillance.

Les frais de main-d'œuvre sont déterminés par les prix et normes publiés à l'heure actuelle dans la zone géographique dans laquelle les réparations sont effectuées. Les heures supplémentaires ou les frais de jours fériés ne sont pas permis. Nous payons également les produits d'entretien, tels que l'huile, l'antigel, les courroies, les tuyaux et les éléments de filtre qui sont endommagés en raison d'une défaillance de garantie définie.

Federal-Mogul décline toute responsabilité pour une défaillance de moteur découlant d'une négligence ou d'un abus infligés par le propriétaire, l'opérateur ou une tierce partie, de procédures d'installation ou de réparations incorrectes, de l'altération ou d'une application incorrecte de pièces, d'un manque de réparation ou d'entretien adéquat du moteur et du véhicule conformément aux manuels d'utilisation et d'entretien OEM applicables, ou de l'utilisation dans un moteur modifié à des fins de compétition ou utilisé en compétition.

SAUF SUR SPÉCIFICATION EXPRESSE DANS LA PRÉSENTE, FEDERAL-MOGUL NE SERA RESPONSABLE, EN AUCUNE CIRCONSTANCE, POUR DES DOMMAGES SPÉCIAUX, INDIRECTS, ACCESSOIRES OU CONSÉCUTIFS, Y COMPRIS, SANS S'Y LIMITER, DES DOMMAGES OU LA PERTE D'UNE AUTRE PROPRIÉTÉ OU D'UN AUTRE ÉQUIPEMENT, LA PERTE DE PROFITS OU DE REVENUS, LES FRAIS DE TRANSPORT ET DE REMORQUAGE, LES FRAIS DE BIENS ACHETÉS OU REMPLACÉS, OU LES DEMANDES DE CLIENTS DE L'ACHETEUR, QUI PEUVENT SE PRÉSENTER OU RÉSULTER DE LA VENTE, DE L'INSTALLATION OU DE L'UTILISATION DE CES PIÈCES.

Certaines juridictions ne permettent pas les limites sur la durée d'une garantie implicite, ni l'exclusion ou la limitation de dommages accessoires ou consécutifs, et, par conséquent, les limitations ou exclusions ci-incluses peuvent s'appliquer ou non pour votre cas. Cette garantie vous octroie des droits légaux spécifiques.

Vous disposez également d'autres droits en fonction de l'état ou de la province de votre résidence. LA PRÉSENTE GARANTIE REMPLACE TOUTES AUTRES GARANTIES, EXPRESSES ET/OU IMPLICITES, Y COMPRIS, SANS S'Y LIMITER, LES GARANTIES DE QUALITÉ MARCHANDE OU D'ADAPTATION À UN USAGE PARTICULIER, ET ELLES SONT EXCLUES SI ELLES DEVAIENT DÉPASSER LA COUVERTURE DE GARANTIE DÉCRITE PAR LA PRÉSENTE GARANTIE.

Cette garantie et le recours s'appliquent aux nouvelles pièces du moteur diesel FP de Federal-Mogul vendu directement à nos clients de pièces de rechange autorisés, tel qu'attesté par les documents de demande dûment remplis. Aucun agent ou représentant de ventes de Federal-Mogul Corporation ne dispose du droit de modifier la présente garantie. D'autres pièces de Federal-Mogul peuvent être couvertes par des garanties différentes.

### PROCÉDURES DE DEMANDE

Le client doit notifier Federal-Mogul : (i) avant de remplir une demande au titre de la garantie, (ii) en l'espace d'un an à partir de la date à laquelle la demande est exercée, et (iii) avant l'exécution d'un travail quelconque.

Toutes les demandes doivent être soumises par écrit et Federal-Mogul se réserve le droit d'examiner toutes les pièces, tous les systèmes et toutes les informations associées à la demande.

(Veuillez noter que l'utilisateur final ou le distributeur est responsable pour tous les frais d'expédition; Federal-Mogul n'accepte aucun envoi en port-dû). Veuillez consulter votre représentant des ventes pour les formulaires et les procédures de soumission de demande détaillés.

### AVERTISSEMENT

Utilisez uniquement les pièces pour les applications et les échanges de ce catalogue.

Un manque de respect de cet avertissement pourrait résulter en une durée de vie réduite ou une défaillance de la pièce. Aucune des pièces indiquées dans ce catalogue n'est destinée à être utilisée dans un programme d'espace, pour du matériel de réacteur nucléaire/d'énergie atomique, ou des applications médicales ou d'aéronefs.

Federal-Mogul se réserve le droit d'effectuer des améliorations/changements de produits, en ce qui concerne des produits similaires fabriqués auparavant, sans avis et sans assumer de responsabilité.





## Warranty

### **Global Technology Behind Every Part**

Se garantiza que todos los productos presentados en este catálogo no presentaran defecto alguno, ya sea en su material ni en su fabricación, bajo condiciones de uso y servicio normales. La garantía es de dos años de la fecha de la instalación en el motor, sin límites en el kilometraje o en las horas de funcionamiento. Esta es la única y exclusiva garantía si alguna de las partes listadas fuese a fallar. Este recurso exclusivo no se tomará como una falta, siempre y cuando Federal Mogul pueda remediarlo con las provisiones enumeradas mas abajo.

### **LIMITACIONES DE LA GARANTIA**

Federal-Mogul pagará solo por las partes y la mano de obra necesarias para reparar daños al motor que resulten de una falla definida sobre la parte vendida. Los costos quedarán limitados a las partes y la mano de obra necesarias para restaurar el motor a la condición en la cual se encontraba inmediatamente antes de la falla.

Los costos de la mano de obra se determinarán por medio de precios publicados y estándares del área geográfica en la cual las reparaciones se lleven a cabo. No se permitirá agregar costos de tiempo extra ni por trabajo durante días festivos. Pagaremos por productos de mantenimiento tales como aceite, anti-congelantes, correas, mangueras y filtros dañados debido a alguna falla definida del producto vendido.

Federal-Mogul no se hará responsable por una falla de motor causada por el dueño, operador o un tercero, ya sea por su propia negligencia, abuso o instalación inadecuada o procedimientos de reparación inadecuados, por alteración o aplicación incorrecta de las partes, falta de servicio necesario o mantenimiento del motor o de el vehículo de acuerdo a los manuales de operación y mantenimiento de acuerdo fabricante original, o por la modificación de un motor para su uso en competencias o por haber sido usado en competencias.

FEDERAL-MOGUL NO SERÁ RESPONSABLE, BAJO NINGUNA CIRCUNSTANCIA, OTRO QUE NO SEA LO QUE SE HA MENCIONADO EXPLÍCITAMENTE EN ÉSTA GARANTÍA, POR CUALQUIER DAÑO INDIRECTO, ESPECIAL, ACCIDENTAL O CÓMO CONSECUENCIA DE OTROS DAÑOS, INCLUYENDO, PERO SIN QUE QUÉDE LIMITADO A DAÑOS O PÉRDIDAS DE BIENES O DE EQUIPO, PÉRDIDA DE GANANCIAS O INGRESOS, COSTOS DE GRÚA O TRANSPORTACIÓN, DE PARTES REEMPLAZADAS, O RECLAMOS DE CLIENTES DEL COMPRADOR, QUE PUEDAN RESULTAR DE LA VENTA, INSTALACIÓN, O USO DE ÉSTAS PARTES.

Algunas jurisdicciones no permiten limitaciones con respecto a la duración de garantías implícitas, o a la exclusión o limitación de daños accidentales, por lo tanto puede que las limitaciones o exclusiones contenidas en el presente no le apliquen a Ud. Esta garantía le ofrece derechos específicos. Ud. puede gozar de derechos adicionales dependiendo del estado o provincia en la cual viva.

ÉSTA GARANTIA REEMPLAZARA CUALQUIER Y TODA OTRA GARANTÍA, YA SEA EXPLÍCITA U IMPLÍCITA, INCLUYENDO, PERO NO LIMITANDOSE A GARANTÍAS PARA LA MERCANCÍA Y USO DE LA MISMA CON UN PROPÓSITO EN PARTICULAR, Y ESAS MISMAS QUEDARAN EXCLUIDAS SI EXCEDEN LA COBERTURA DESCRITA EN ÉSTA GARANTÍA.

Ésta garantía y recurso aplican a partes nuevas de motores de FP Diésel, vendidas directamente a nuestros clientes autorizados del mercado de reposición, lo cual será corroborado por medio de documentación usada en el reclamo.

Ningún agente o representante de la empresa Federal-Mogul tiene autoridad para modificar ésta garantía.

Otras partes de Federal-Mogul pueden tener garantías diferentes.

### **PROCEDIMIENTO PARA PRESENTAR UN RECLAMO**

Federal-Mogul debe ser notificado por el cliente: (i) antes de presentar un reclamo cubierto en la garantía, (ii) dentro del plazo de un año de ocurrida la falla, y (iii) antes de que se haya hecho algún trabajo.

Todo reclamo debe ser entregado por escrito y Federal-Mogul reserva el derecho a examinar todas las partes, sistemas e información relacionados y asociados al reclamo. (Todo cargo de envío será responsabilidad del usuario final o distribuidor, Federal-Mogul no aceptará envíos a cobrar). Contacte a su representante de ventas para conseguir el formulario de reclamos con el procedimiento detallado.

### **ADVERTENCIA**

Las partes deben ser usadas sólo para las aplicaciones mencionadas en éste catálogo. El no seguir ésta advertencia puede que resulte en que le falle la parte o a que su vida quede reducida. Todas las partes listadas en éste catálogo no están hechas para el uso en programas espaciales, para equipos de energía atómica, o reactores nucleares, o para aplicaciones médicas ni en naves aéreas. Federal-Mogul se reserva el derecho de hacerle mejoras y cambios a los productos, con respecto a productos similares que se hayan fabricado previamente, sin notificación o responsabilidad legal alguna.





## Engine Finding Index

Engine	Line No.	Engine	Line No.
.9L 57 L-HEAD L2 3" Bore (Hercules Eng.)	1	4.5L 275.8 (4522cc) OHV Turbo-Diesel L4 106mm Bore (Litre Engine)	65
1.1L 66 L-HEAD L2 3.25" Bore (Hercules Eng.)	2	4.5L 275.8 (4522cc) OHV Turbo-Diesel L4 106mm Bore (PowerTech 2V)	66
1.6L 100 OHV L2 4" Bore	3	4.5L 276 OHV Diesel L4 4.1875" Bore (Standard)	67
1.7L 106 OHV Diesel L2 3.875" Bore (Detroit Diesel Eng.)	4	4.5L 276 OHV Turbo-Diesel L4 4.1875" Bore (Standard)	68
1.8L 108 L-HEAD V4 3.25" Bore (Wisconsin Eng.)	5	4.6L 282 L-HEAD L6 3.75" Bore (Hercules Eng.)	69
1.9L 113 L-HEAD L4 3" Bore (Hercules Eng.)	6	4.7L 284 OHV Diesel L4 4.25" Bore (4-71) (Detroit Diesel Eng.)	70
1.9L 113 OHV L2 4.25" Bore	7	4.9L 302 OHV L6 4" Bore	71
1.9L 115 OHV L4 3.5" Bore	8	5.0L 303 OHV L6 3.8594" Bore	72
2.2L 133 L-HEAD L4 3.25" Bore (Hercules Eng.)	9	5.0L 303 OHV Diesel L6 3.8594" Bore	73
2.2L 135 OHV L3 3.8594" Bore	10	5.0L 303 OHV LPG L6 3.8594" Bore	74
2.2L 135 OHV Diesel L3 3.8594" Bore	11	5.0L 308 OHV L2 5.5" Bore	75
2.2L 135 OHV NG L3 3.8594" Bore	12	5.3L 321 OHV L2 5.5" Bore	76
2.4L 145 OHV L4 3.625" Bore	13	5.4L 329 OHV L6 4.0156" Bore	77
2.4L 145 OHV L4 3.625" Bore (Late)	14	5.4L 329 OHV Diesel L6 4.0156" Bore	78
2.4L 145 OHV Diesel L4 3.625" Bore	15	5.4L 329 OHV LPG L6 4.0156" Bore	79
2.4L 149 OHV L2 4.25" Bore	16	5.4L 329 OHV Turbo-Diesel L6 4.0156" Bore	80
2.5L 152 OHV L3 3.8594" Bore	17	5.6L 340 OHV L6 4.25" Bore	81
2.5L 152 OHV Diesel L3 3.8594" Bore	18	5.6L 340 OHV LPG L6 4.25" Bore	82
2.5L 154 L-HEAD V4 3.5" Bore (Wisconsin Eng.)	19	5.9L 358.4 (5876cc) OHV Diesel L6 106mm Bore (Litre Engine)	83
2.5L 155 OHV Diesel L4 3.75" Bore	20	5.9L 358.4 (5876cc) OHV Turbo-Diesel L6 106mm Bore (Litre Engine)	84
2.7L 162 L-HEAD L4 3.4375" Bore (Continental Eng.)	21	5.9L 359 OHV Diesel L6 4.1875" Bore	85
2.7L 164 OHV L3 4.0156" Bore	22	5.9L 359 OHV Turbo-Diesel L6 4.1875" Bore	86
2.7L 164 OHV Diesel L3 4.0156" Bore	23	5.9L 362 OHV L6 4.25" Bore	87
2.7L 165 OHV L4 3.875" Bore	24	5.9L 362 OHV LPG L6 4.25" Bore	88
2.7L 165 OHV Diesel L4 3.875" Bore	25	5.9L 362 OHV NG L6 4.25" Bore	89
2.9L 175 OHV L2 4.5" Bore	26	5.9L 362 OHV L2 6" Bore	90
2.9L 179 OHV Diesel L3 4.1875" Bore (Standard)	27	5.9L 362 OHV Diesel L2 6" Bore	91
2.9L 179 OHV Turbo-Diesel L3 4.1875" Bore (Standard)	28	6.2L 378 OHV L2 6.125" Bore	92
2.9L 179.2 (2938cc) OHV Diesel L3 106mm Bore (PowerTech 2V)	29	6.2L 380 OHV L2 5.875" Bore	93
2.9L 179.2 (2938cc) OHV Turbo-Diesel L3 106mm Bore (PowerTech 2V)	30	6.2L 381 OHV Diesel L6 4.125" Bore	94
2.9L 180 OHV L4 3.8594" Bore	31	6.6L 404 OHV Diesel L6 4.25" Bore (Early)	95
2.9L 180 OHV Diesel L4 3.8594" Bore	32	6.6L 404 OHV Diesel L6 4.25" Bore (Late)	96
3.1L 188 L-HEAD L4 3.75" Bore (Hercules Eng.)	33	6.6L 404 OHV Diesel L6 4.25" Bore (5 Main)	97
3.1L 190 OHV L2 4.6875" Bore	34	6.6L 404 OHV Turbo-Diesel L6 4.25" Bore (Aftercooled)	98
3.1L 190 OHV Distillate L2 4.6875" Bore	35	6.6L 404 OHV Turbo-Diesel L6 4.25" Bore (Early)	99
3.3L 201 OHV L4 4" Bore	36	6.8L 413 OHV L2 6.125" Bore	100
3.3L 202 OHV L4 3.8594" Bore	37	6.8L 413.8 (6784cc) OHV Turbo-NG L6 106mm Bore (PowerTech 2V IC)	101
3.3L 202 OHV Diesel L4 3.8594" Bore	38	6.8L 413.8 (6784cc) OHV Turbo-Diesel L6 106mm Bore (PowerTech 2V IC)	102
3.6L 217 OHV L6 3.625" Bore	39	6.8L 413.8 (6784cc) OHV Turbo-Diesel L6 106mm Bore (PowerTech 4V IC)	103
3.6L 219 OHV L4 4.0156" Bore	40	6.8L 413.8 (6784cc) OHV Diesel L6 106mm Bore (PowerTech 2V)	104
3.6L 219 OHV Diesel L4 4.0156" Bore	41	6.8L 413.8 (6784cc) OHV NG L6 106mm Bore (PowerTech 2V)	105
3.6L 219 OHV Turbo-Diesel L4 4.0156" Bore	42	6.8L 413.8 (6784cc) OHV Turbo-Diesel L6 106mm Bore (Litre Engine)	106
3.6L 222 L-HEAD L6 3.375" Bore (Hercules Eng.)	43	6.8L 413.8 (6784cc) OHV Turbo-NG L6 106mm Bore (PowerTech 2V)	107
3.7L 225 OHV L6 3.4063" Bore (Chrysler Eng.)	44	6.8L 413.8 (6784cc) OHV Turbo-Diesel L6 106mm Bore (PowerTech 2V)	108
3.7L 226 OHV L4 4" Bore (Hercules Eng.)	45	6.8L 414 OHV Diesel L6 4.1875" Bore (Standard)	109
3.7L 227 OHV L4 4.25" Bore	46	6.8L 414 OHV Turbo-Diesel L6 4.1875" Bore (Standard)	110
3.7L 227 OHV LPG L4 4.25" Bore	47	6.8L 414 OHV L2 6.125" Bore	111
3.8L 230 L-HEAD L6 3.4375" Bore (Hercules Eng.)	48	7.0L 426 OHV Diesel L6 4.25" Bore (6-71) (Detroit Diesel Eng.)	112
3.8L 232 OHV Diesel L6 3.875" Bore	49	7.6L 466 OHV Diesel L6 4.5625" Bore (Standard)	113
3.9L 239 OHV Diesel L4 4.1875" Bore (Standard)	50	7.6L 466 OHV Turbo-Diesel L6 4.5625" Bore (Standard)	114
3.9L 239 OHV Turbo-Diesel L4 4.1875" Bore (Standard)	51	7.6L 465.9 (7638cc) OHV Diesel L6 115mm Bore (Litre Engine)	115
3.9L 239 (3917cc) OHV Diesel L4 106mm Bore (Litre Engine)	52	7.6L 465.9 (7638cc) OHV Turbo-Diesel L6 115mm Bore (Litre Engine)	116
3.9L 239 (3917cc) OHV Turbo-Diesel L4 106mm Bore (Litre Engine)	53	8.1L 495.9 (8129cc) OHV Turbo-NG L6 116mm Bore (PowerTech 2V IC)	117
3.9L 241 OHV L4 4.25" Bore	54	8.1L 495.9 (8129cc) OHV Turbo-Diesel L6 116mm Bore (PowerTech 2V IC)	118
3.9L 241 OHV LPG L4 4.25" Bore	55		
3.9L 241 OHV NG L4 4.25" Bore	56		
4.1L 248 OHV L6 3.875" Bore	57		
4.1L 248 OHV Diesel L6 3.875" Bore	58		
4.2L 254 OHV Diesel L4 4.125" Bore	59		
4.4L 270 OHV Diesel L4 4.25" Bore	60		
4.5L 275.8 (4522cc) OHV Turbo-Diesel L4 106mm Bore (PowerTech 2V IC)	61		
4.5L 275.8 (4522cc) OHV Turbo-Diesel L4 106mm Bore (PowerTech 4V IC)	62		
4.5L 275.8 (4522cc) OHV Diesel L4 106mm Bore (Litre Engine)	63		
4.5L 275.8 (4522cc) OHV Diesel L4 106mm Bore (PowerTech 2V)	64		

(continued on next page)

## Engine Finding Index

Engine	Line No.	Engine	Line No.
8.1L 495.9 (8129cc) OHV Turbo-Diesel L6 116mm Bore (PowerTech 2V AC).....	119	9.0L 549 (9000cc) OHV Turbo-Diesel L6 118.4mm Bore (PowerTech 4V AC).....	125
8.1L 495.9 (8129cc) OHV Turbo-NG L6 116mm Bore (PowerTech 2V).....	120	9.0L 549 (9000cc) OHV Turbo-Diesel L6 118.4mm Bore (PowerTech 4V).....	126
8.1L 495.9 (8129cc) OHV Turbo-Diesel L6 116mm Bore (PowerTech 2V).....	121	10.1L 619 OHV Turbo-Diesel L6 5.125" Bore.....	127
8.7L 531 OHV Diesel L6 4.75" Bore.....	122	10.5L 639.5 (10483cc) OHV Turbo-Diesel L6 127mm Bore (PowerTech).....	128
8.7L 531 OHV Turbo-Diesel L6 4.75" Bore.....	123	12.5L 764.6 (12534cc) OHV Turbo-Diesel L6 127mm Bore (PowerTech).....	129
9.0L 549 (9000cc) OHV Turbo-Diesel L6 118.4mm Bore (PowerTech 4V IC).....	124	14.0L 855 OHV Turbo-Diesel L6 5.5" Bore (Cummins Eng.).....	130

## Engine Code Index

Engine Code	Engine Description	Line No.	Engine Code	Engine Description	Line No.
A ... Wheel Tractor.....	5.0L 308 OHV L2 5.5" Bore.....	75	VF4 ... Power Unit.....	1.8L 108 L-HEAD V4 3.25" Bore (Wisconsin Eng.).....	5
A ... Wheel Tractor.....	5.3L 321 OHV L2 5.5" Bore.....	76	VF4 ... Windrower.....	1.8L 108 L-HEAD V4 3.25" Bore (Wisconsin Eng.).....	5
AP4 ... Hay Baler.....	2.5L 154 L-HEAD V4 3.5" Bore (Wisconsin Eng.).....	19	VF4D ... Hay Baler.....	1.8L 108 L-HEAD V4 3.25" Bore (Wisconsin Eng.).....	5
AP4 ... Harvester.....	2.5L 154 L-HEAD V4 3.5" Bore (Wisconsin Eng.).....	19	VF4D ... Power Unit.....	1.8L 108 L-HEAD V4 3.25" Bore (Wisconsin Eng.).....	5
B ... Wheel Tractor.....	2.4L 149 OHV L2 4.25" Bore.....	16	VF4D ... Windrower.....	1.8L 108 L-HEAD V4 3.25" Bore (Wisconsin Eng.).....	5
B ... Wheel Tractor.....	2.9L 175 OHV L2 4.5" Bore.....	26	VF41 ... Hay Baler.....	1.8L 108 L-HEAD V4 3.25" Bore (Wisconsin Eng.).....	5
B ... Wheel Tractor.....	3.1L 190 OHV L2 4.6875" Bore.....	34	VF41 ... Power Unit.....	1.8L 108 L-HEAD V4 3.25" Bore (Wisconsin Eng.).....	5
F162 ... Combine.....	2.7L 162 L-HEAD L4 3.4375" Bore (Continental Eng.).....	21	VF41 ... Windrower.....	1.8L 108 L-HEAD V4 3.25" Bore (Wisconsin Eng.).....	5
F162 ... Harvester.....	2.7L 162 L-HEAD L4 3.4375" Bore (Continental Eng.).....	21	VG4D ... Hay Baler.....	2.5L 154 L-HEAD V4 3.5" Bore (Wisconsin Eng.).....	19
H-225 ... Windrower.....	3.7L 225 OHV L6 3.4063" Bore (Chrysler Eng.).....	44	VG4D ... Harvester.....	2.5L 154 L-HEAD V4 3.5" Bore (Wisconsin Eng.).....	19
IXA ... Combine.....	1.9L 113 L-HEAD L4 3" Bore (Hercules Eng.).....	6	VH4 ... Hay Baler.....	1.8L 108 L-HEAD V4 3.25" Bore (Wisconsin Eng.).....	5
IXB ... Combine.....	2.2L 133 L-HEAD L4 3.25" Bore (Hercules Eng.).....	9	VH4 ... Power Unit.....	1.8L 108 L-HEAD V4 3.25" Bore (Wisconsin Eng.).....	5
JD135G ... Power Unit.....	2.2L 135 OHV L3 3.8594" Bore.....	10	VH4 ... Windrower.....	1.8L 108 L-HEAD V4 3.25" Bore (Wisconsin Eng.).....	5
JD152D ... Power Unit.....	2.5L 152 OHV Diesel L3 3.8594" Bore.....	18	VH4D ... Hay Baler.....	1.8L 108 L-HEAD V4 3.25" Bore (Wisconsin Eng.).....	5
JD164D ... Power Unit.....	2.7L 164 OHV Diesel L3 4.0156" Bore.....	23	VH4D ... Power Unit.....	1.8L 108 L-HEAD V4 3.25" Bore (Wisconsin Eng.).....	5
JD180G ... Power Unit.....	2.9L 180 OHV L4 3.8594" Bore.....	31	VH4D ... Windrower.....	1.8L 108 L-HEAD V4 3.25" Bore (Wisconsin Eng.).....	5
JD202D ... Power Unit.....	3.3L 202 OHV Diesel L4 3.8594" Bore.....	38	VH4DM ... Hay Baler.....	1.8L 108 L-HEAD V4 3.25" Bore (Wisconsin Eng.).....	5
JD202G ... Power Unit.....	3.3L 202 OHV L4 3.8594" Bore.....	37	VH4DM ... Power Unit.....	1.8L 108 L-HEAD V4 3.25" Bore (Wisconsin Eng.).....	5
JD303D ... Power Unit.....	5.0L 303 OHV Diesel L6 3.8594" Bore.....	73	VH4DM ... Windrower.....	1.8L 108 L-HEAD V4 3.25" Bore (Wisconsin Eng.).....	5
JD303G ... Power Unit.....	5.0L 303 OHV L6 3.8594" Bore.....	72	VP4 ... Hay Baler.....	2.5L 154 L-HEAD V4 3.5" Bore (Wisconsin Eng.).....	19
JD329D ... Power Unit.....	5.4L 329 OHV Diesel L6 4.0156" Bore.....	78	VP4 ... Harvester.....	2.5L 154 L-HEAD V4 3.5" Bore (Wisconsin Eng.).....	19
JD329G ... Power Unit.....	5.4L 329 OHV L6 4.0156" Bore.....	77	VP4D ... Hay Baler.....	2.5L 154 L-HEAD V4 3.5" Bore (Wisconsin Eng.).....	19
JD404D ... Power Unit.....	6.6L 404 OHV Diesel L6 4.25" Bore (Early).....	95	VP4D ... Harvester.....	2.5L 154 L-HEAD V4 3.5" Bore (Wisconsin Eng.).....	19
JD404D ... Power Unit.....	6.6L 404 OHV Diesel L6 4.25" Bore (Late).....	96	V460D ... Hay Baler.....	2.5L 154 L-HEAD V4 3.5" Bore (Wisconsin Eng.).....	19
JXC ... Combine.....	4.6L 282 L-HEAD L6 3.75" Bore (Hercules Eng.).....	69	V460D ... Harvester.....	2.5L 154 L-HEAD V4 3.5" Bore (Wisconsin Eng.).....	19
JX4-C3 ... Combine.....	3.1L 188 L-HEAD L4 3.75" Bore (Hercules Eng.).....	33	V461D ... Hay Baler.....	2.5L 154 L-HEAD V4 3.5" Bore (Wisconsin Eng.).....	19
M ... Wheel Tractor.....	1.6L 100 OHV L2 4" Bore.....	3	V461D ... Harvester.....	2.5L 154 L-HEAD V4 3.5" Bore (Wisconsin Eng.).....	19
NXA ... Power Unit.....	.9L 57 L-HEAD L2 3" Bore (Hercules Eng.).....	1	115G ... Combine.....	1.9L 115 OHV L4 3.5" Bore.....	8
NXB ... Power Unit.....	1.1L 66 L-HEAD L2 3.25" Bore (Hercules Eng.).....	2	115G ... Power Unit.....	1.9L 115 OHV L4 3.5" Bore.....	8
N14CELECT ... Harvester.....	14.0L 855 OHV Turbo-Diesel L6 5.5" Bore (Cummins Eng.).....	130	115G ... Wheel Tractor.....	1.9L 115 OHV L4 3.5" Bore.....	8
OOC ... Combine.....	3.7L 226 OHV L4 4" Bore (Hercules Eng.).....	45			
QXC ... Combine.....	3.6L 222 L-HEAD L6 3.375" Bore (Hercules Eng.).....	43			
QXD3 ... Combine.....	3.8L 230 L-HEAD L6 3.4375" Bore (Hercules Eng.).....	48			
VF4 ... Hay Baler.....	1.8L 108 L-HEAD V4 3.25" Bore (Wisconsin Eng.).....	5			

(continued on next page)



## Engine Code Index

Engine Code	Engine Description	Line No.	Engine Code	Engine Description	Line No.
115G ... Windrower.....	1.9L 115 OHV L4 3.5" Bore.....	8	3029T ... Track Loader .....	2.9L 179.2 (2938cc) OHV Turbo-Diesel L3 106mm Bore (PowerTech 2V).....	30
115G ... Crawler Tractor.....	1.9L 115 OHV L4 3.5" Bore.....	8	3135D ... Wheel Tractor .....	2.2L 135 OHV Diesel L3 3.8594" Bore.....	11
145D ... Wheel Tractor .....	2.4L 145 OHV Diesel L4 3.625" Bore.....	15	3135G ... Loader.....	2.2L 135 OHV L3 3.8594" Bore.....	10
145D ... Crawler Tractor .....	2.4L 145 OHV Diesel L4 3.625" Bore.....	15	3135G ... Power Unit .....	2.2L 135 OHV L3 3.8594" Bore.....	10
145G ... Power Unit .....	2.4L 145 OHV L4 3.625" Bore.....	13	3135G ... Wheel Tractor .....	2.2L 135 OHV L3 3.8594" Bore.....	10
145G ... Wheel Tractor .....	2.4L 145 OHV L4 3.625" Bore.....	13	3135G ... Windrower.....	2.2L 135 OHV L3 3.8594" Bore.....	10
145G ... Power Unit .....	2.4L 145 OHV L4 3.625" Bore (Late).....	14	3135G ... Crawler Tractor.....	2.2L 135 OHV L3 3.8594" Bore.....	10
145G ... Wheel Tractor .....	2.4L 145 OHV L4 3.625" Bore (Late).....	14	3135G ... Loader Tractor .....	2.2L 135 OHV L3 3.8594" Bore.....	10
155D ... Combine.....	2.5L 155 OHV Diesel L4 3.75" Bore.....	20	3152D ... Forklift.....	2.5L 152 OHV Diesel L3 3.8594" Bore.....	18
155D ... Power Unit .....	2.5L 155 OHV Diesel L4 3.75" Bore.....	20	3152D ... Loader.....	2.5L 152 OHV Diesel L3 3.8594" Bore.....	18
155D ... Wheel Tractor .....	2.5L 155 OHV Diesel L4 3.75" Bore.....	20	3152D ... Power Unit .....	2.5L 152 OHV Diesel L3 3.8594" Bore.....	18
165D ... Combine.....	2.7L 165 OHV Diesel L4 3.875" Bore.....	25	3152D ... Wheel Tractor .....	2.5L 152 OHV Diesel L3 3.8594" Bore.....	18
165D ... Power Unit .....	2.7L 165 OHV Diesel L4 3.875" Bore.....	25	3152D ... Crawler Tractor .....	2.5L 152 OHV Diesel L3 3.8594" Bore.....	18
165D ... Wheel Tractor .....	2.7L 165 OHV Diesel L4 3.875" Bore.....	25	3152D ... Loader Tractor .....	2.5L 152 OHV Diesel L3 3.8594" Bore.....	18
165G ... Combine .....	2.7L 165 OHV L4 3.875" Bore.....	24	3152D ... Dozer .....	2.5L 152 OHV Diesel L3 3.8594" Bore.....	18
165G ... Power Unit .....	2.7L 165 OHV L4 3.875" Bore.....	24	3152D ... Backhoe.....	2.5L 152 OHV Diesel L3 3.8594" Bore.....	18
2-53 ... Wheel Tractor.....	1.7L 106 OHV Diesel L2 3.875" Bore (Detroit Diesel Eng.).....	4	3152G ... Loader.....	2.5L 152 OHV L3 3.8594" Bore.....	17
2-53N ... Wheel Tractor .....	1.7L 106 OHV Diesel L2 3.875" Bore (Detroit Diesel Eng.).....	4	3152G ... Wheel Tractor .....	2.5L 152 OHV L3 3.8594" Bore.....	17
201G ... Loader.....	3.3L 201 OHV L4 4" Bore.....	36	3164D ... Combine.....	2.7L 164 OHV Diesel L3 4.0156" Bore.....	23
201G ... Wheel Tractor .....	3.3L 201 OHV L4 4" Bore.....	36	3164D ... Loader.....	2.7L 164 OHV Diesel L3 4.0156" Bore.....	23
217G ... Combine .....	3.6L 217 OHV L6 3.625" Bore.....	39	3164D ... Power Unit .....	2.7L 164 OHV Diesel L3 4.0156" Bore.....	23
217G ... Harvester .....	3.6L 217 OHV L6 3.625" Bore.....	39	3164D ... Wheel Tractor .....	2.7L 164 OHV Diesel L3 4.0156" Bore.....	23
217G ... Power Unit .....	3.6L 217 OHV L6 3.625" Bore.....	39	3164D ... Crawler Tractor .....	2.7L 164 OHV Diesel L3 4.0156" Bore.....	23
227G ... Wheel Tractor .....	3.7L 227 OHV L4 4.25" Bore.....	46	3164D ... Loader Tractor .....	2.7L 164 OHV Diesel L3 4.0156" Bore.....	23
227G ... Loader Tractor .....	3.7L 227 OHV L4 4.25" Bore.....	46	3164D ... Dozer .....	2.7L 164 OHV Diesel L3 4.0156" Bore.....	23
227LP LPG ... Wheel Tractor.....	3.7L 227 OHV LPG L4 4.25" Bore.....	47	3164D ... Backhoe.....	2.7L 164 OHV Diesel L3 4.0156" Bore.....	23
227LP LPG ... Loader Tractor.....	3.7L 227 OHV LPG L4 4.25" Bore.....	47	3164G ... Loader.....	2.7L 164 OHV L3 4.0156" Bore.....	22
232D ... Power Unit .....	3.8L 232 OHV Diesel L6 3.875" Bore.....	49	3164G ... Wheel Tractor .....	2.7L 164 OHV L3 4.0156" Bore.....	22
248D ... Combine.....	4.1L 248 OHV Diesel L6 3.875" Bore.....	58	3179D ... Wheel Tractor .....	2.9L 179 OHV Diesel L3 4.1875" Bore (Standard).....	27
248D ... Power Unit .....	4.1L 248 OHV Diesel L6 3.875" Bore.....	58	3179D ... Crawler Tractor .....	2.9L 179 OHV Diesel L3 4.1875" Bore (Standard).....	27
248G ... Combine .....	4.1L 248 OHV L6 3.875" Bore.....	57	3179D ... Dozer .....	2.9L 179 OHV Diesel L3 4.1875" Bore (Standard).....	27
248G ... Power Unit .....	4.1L 248 OHV L6 3.875" Bore.....	57	3179T ... Wheel Tractor.....	2.9L 179 OHV Turbo-Diesel L3 4.1875" Bore (Standard).....	28
254D ... Loader.....	4.2L 254 OHV Diesel L4 4.125" Bore.....	59	4-71 ... Wheel Tractor.....	4.7L 284 OHV Diesel L4 4.25" Bore (4-71) (Detroit Diesel Eng.).....	70
254D ... Power Unit .....	4.2L 254 OHV Diesel L4 4.125" Bore.....	59	4-71N ... Wheel Tractor .....	4.7L 284 OHV Diesel L4 4.25" Bore (4-71) (Detroit Diesel Eng.).....	70
254D ... Wheel Tractor .....	4.2L 254 OHV Diesel L4 4.125" Bore.....	59	4039D ... Forklift.....	3.9L 239 (3917cc) OHV Diesel L4 106mm Bore (Litre Engine) .....	52
301G ... Combine .....	4.9L 302 OHV L6 4" Bore.....	71	4039D ... Crawler Tractor .....	3.9L 239 (3917cc) OHV Diesel L4 106mm Bore (Litre Engine) .....	52
301G ... Wheel Tractor .....	4.9L 302 OHV L6 4" Bore.....	71	4039D ... Excavator.....	3.9L 239 (3917cc) OHV Diesel L4 106mm Bore (Litre Engine) .....	52
3029D ... Power Unit .....	2.9L 179.2 (2938cc) OHV Diesel L3 106mm Bore (PowerTech 2V).....	29	4039D ... Backhoe.....	3.9L 239 (3917cc) OHV Diesel L4 106mm Bore (Litre Engine) .....	52
3029D ... Wheel Tractor .....	2.9L 179.2 (2938cc) OHV Diesel L3 106mm Bore (PowerTech 2V).....	29	4039T ... Backhoe.....	3.9L 239 (3917cc) OHV Turbo-Diesel L4 106mm Bore (Litre Engine).....	53
3029D ... Track Loader.....	2.9L 179.2 (2938cc) OHV Diesel L3 106mm Bore (PowerTech 2V).....	29	4039T ... Sprayer.....	3.9L 239 (3917cc) OHV Turbo-Diesel L4 106mm Bore (Litre Engine).....	53
3029T ... Power Unit.....	2.9L 179.2 (2938cc) OHV Turbo-Diesel L3 106mm Bore (PowerTech 2V).....	30			
3029T ... Wheel Tractor.....	2.9L 179.2 (2938cc) OHV Turbo-Diesel L3 106mm Bore (PowerTech 2V).....	30			

(continued on next page)

## Engine Code Index

Engine Code	Engine Description	Line No.	Engine Code	Engine Description	Line No.
4045D ... Loader.....	4.5L 275.8 (4522cc) OHV Diesel L4 106mm Bore (Litre Engine) .....	63	4202D ... Crawler Tractor .....	3.3L 202 OHV Diesel L4 3.8594" Bore .....	38
4045D ... Loader Tractor .....	4.5L 275.8 (4522cc) OHV Diesel L4 106mm Bore (Litre Engine) .....	63	4202D ... Loader Tractor .....	3.3L 202 OHV Diesel L4 3.8594" Bore .....	38
4045D ... Backhoe.....	4.5L 275.8 (4522cc) OHV Diesel L4 106mm Bore (Litre Engine) .....	63	4202D ... Skidder.....	3.3L 202 OHV Diesel L4 3.8594" Bore .....	38
4045H ... Power Unit .....	4.5L 275.8 (4522cc) OHV Turbo-Diesel L4 106mm Bore (PowerTech 2V IC).....	61	4202D ... Dozer .....	3.3L 202 OHV Diesel L4 3.8594" Bore .....	38
4045H ... Wheel Tractor .....	4.5L 275.8 (4522cc) OHV Turbo-Diesel L4 106mm Bore (PowerTech 2V IC).....	61	4202D ... Backhoe .....	3.3L 202 OHV Diesel L4 3.8594" Bore .....	38
4045H ... Crawler Tractor .....	4.5L 275.8 (4522cc) OHV Turbo-Diesel L4 106mm Bore (PowerTech 2V IC).....	61	4202G ... Combine .....	3.3L 202 OHV L4 3.8594" Bore....	37
4045H ... Loader Tractor .....	4.5L 275.8 (4522cc) OHV Turbo-Diesel L4 106mm Bore (PowerTech 2V IC).....	61	4202G ... Power Unit .....	3.3L 202 OHV L4 3.8594" Bore....	37
4045H ... Forestry Tractor .....	4.5L 275.8 (4522cc) OHV Turbo-Diesel L4 106mm Bore (PowerTech 2V IC).....	61	4202G ... Wheel Tractor .....	3.3L 202 OHV L4 3.8594" Bore....	37
4045H ... Excavator.....	4.5L 275.8 (4522cc) OHV Turbo-Diesel L4 106mm Bore (PowerTech 2V IC).....	61	4202G ... Crawler Tractor .....	3.3L 202 OHV L4 3.8594" Bore....	37
4045H ... Integrated Tool Carrier.....	4.5L 275.8 (4522cc) OHV Turbo-Diesel L4 106mm Bore (PowerTech 2V IC).....	61	4202G ... Loader Tractor .....	3.3L 202 OHV L4 3.8594" Bore....	37
4045H ... Telehandler.....	4.5L 275.8 (4522cc) OHV Turbo-Diesel L4 106mm Bore (PowerTech 2V IC).....	61	4219D ... Combine.....	3.6L 219 OHV Diesel L4 4.0156" Bore .....	41
4045H ... Power Unit .....	4.5L 275.8 (4522cc) OHV Turbo-Diesel L4 106mm Bore (PowerTech 4V IC).....	62	4219D ... Cotton Picker .....	3.6L 219 OHV Diesel L4 4.0156" Bore .....	41
4045H ... Wheel Tractor .....	4.5L 275.8 (4522cc) OHV Turbo-Diesel L4 106mm Bore (PowerTech 4V IC).....	62	4219D ... Forklift .....	3.6L 219 OHV Diesel L4 4.0156" Bore .....	41
4045T ... Loader .....	4.5L 275.8 (4522cc) OHV Turbo-Diesel L4 106mm Bore (Litre Engine) .....	65	4219D ... Loader.....	3.6L 219 OHV Diesel L4 4.0156" Bore .....	41
4045T ... Loader Tractor.....	4.5L 275.8 (4522cc) OHV Turbo-Diesel L4 106mm Bore (Litre Engine) .....	65	4219D ... Power Unit .....	3.6L 219 OHV Diesel L4 4.0156" Bore .....	41
4045T ... Excavator .....	4.5L 275.8 (4522cc) OHV Turbo-Diesel L4 106mm Bore (Litre Engine) .....	65	4219D ... Wheel Tractor .....	3.6L 219 OHV Diesel L4 4.0156" Bore .....	41
4045T ... Skidder .....	4.5L 275.8 (4522cc) OHV Turbo-Diesel L4 106mm Bore (Litre Engine) .....	65	4219D ... Windrower.....	3.6L 219 OHV Diesel L4 4.0156" Bore .....	41
4045T ... Backhoe .....	4.5L 275.8 (4522cc) OHV Turbo-Diesel L4 106mm Bore (Litre Engine) .....	65	4219D ... Crawler Tractor .....	3.6L 219 OHV Diesel L4 4.0156" Bore .....	41
4180D ... Crawler Tractor .....	2.9L 180 OHV Diesel L4 3.8594" Bore .....	32	4219D ... Loader Tractor .....	3.6L 219 OHV Diesel L4 4.0156" Bore .....	41
4180G ... Combine .....	2.9L 180 OHV L4 3.8594" Bore....	31	4219D ... Forestry Tractor .....	3.6L 219 OHV Diesel L4 4.0156" Bore .....	41
4180G ... Forklift .....	2.9L 180 OHV L4 3.8594" Bore....	31	4219D ... Skidder.....	3.6L 219 OHV Diesel L4 4.0156" Bore .....	41
4180G ... Power Unit .....	2.9L 180 OHV L4 3.8594" Bore....	31	4219D ... Dozer .....	3.6L 219 OHV Diesel L4 4.0156" Bore .....	41
4180G ... Wheel Tractor .....	2.9L 180 OHV L4 3.8594" Bore....	31	4219D ... Backhoe .....	3.6L 219 OHV Diesel L4 4.0156" Bore .....	41
4180G ... Windrower.....	2.9L 180 OHV L4 3.8594" Bore....	31	4219D ... Sprayer .....	3.6L 219 OHV Diesel L4 4.0156" Bore .....	41
4180G ... Crawler Tractor.....	2.9L 180 OHV L4 3.8594" Bore....	31	4219G ... Combine .....	3.6L 219 OHV L4 4.0156" Bore....	40
4180G ... Loader Tractor .....	2.9L 180 OHV L4 3.8594" Bore....	31	4219G ... Cotton Picker .....	3.6L 219 OHV L4 4.0156" Bore....	40
4180G ... Skidder.....	2.9L 180 OHV L4 3.8594" Bore....	31	4219G ... Power Unit .....	3.6L 219 OHV L4 4.0156" Bore....	40
420 ... Wheel Tractor.....	1.9L 113 OHV L2 4.25" Bore .....	7	4219G ... Wheel Tractor .....	3.6L 219 OHV L4 4.0156" Bore....	40
4202D ... Forklift .....	3.3L 202 OHV Diesel L4 3.8594" Bore .....	38	4219G ... Crawler Tractor .....	3.6L 219 OHV L4 4.0156" Bore....	40
4202D ... Loader.....	3.3L 202 OHV Diesel L4 3.8594" Bore .....	38	4219T ... Wheel Tractor.....	3.6L 219 OHV Turbo-Diesel L4 4.0156" Bore.....	42
4202D ... Power Unit .....	3.3L 202 OHV Diesel L4 3.8594" Bore .....	38	4219T ... Crawler Tractor.....	3.6L 219 OHV Turbo-Diesel L4 4.0156" Bore.....	42
4202D ... Wheel Tractor .....	3.3L 202 OHV Diesel L4 3.8594" Bore .....	38	4219T ... Loader Tractor.....	3.6L 219 OHV Turbo-Diesel L4 4.0156" Bore.....	42
4202D ... Windrower.....	3.3L 202 OHV Diesel L4 3.8594" Bore .....	38	4219T ... Skidder .....	3.6L 219 OHV Turbo-Diesel L4 4.0156" Bore.....	42
			4219T ... Dozer.....	3.6L 219 OHV Turbo-Diesel L4 4.0156" Bore.....	42
			4219T ... Backhoe .....	3.6L 219 OHV Turbo-Diesel L4 4.0156" Bore.....	42
			4239D ... Forklift .....	3.9L 239 OHV Diesel L4 4.1875" Bore (Standard).....	50
			4239D ... Wheel Tractor .....	3.9L 239 OHV Diesel L4 4.1875" Bore (Standard).....	50
			4239D ... Windrower.....	3.9L 239 OHV Diesel L4 4.1875" Bore (Standard).....	50
			4239D ... Crawler Tractor .....	3.9L 239 OHV Diesel L4 4.1875" Bore (Standard).....	50
			4239D ... Loader Tractor .....	3.9L 239 OHV Diesel L4 4.1875" Bore (Standard).....	50
			4239D ... Excavator.....	3.9L 239 OHV Diesel L4 4.1875" Bore (Standard).....	50





## Engine Code Index

Engine Code	Engine Description	Line No.	Engine Code	Engine Description	Line No.
4239D ... Backhoe	3.9L 239 OHV Diesel L4 4.1875" Bore (Standard)	50	440 ... Wheel Tractor	1.9L 113 OHV L2 4.25" Bore	7
4239D ... Sprayer	3.9L 239 OHV Diesel L4 4.1875" Bore (Standard)	50	50 ... Wheel Tractor	3.1L 190 OHV L2 4.6875" Bore	34
4239T ... Wheel Tractor	3.9L 239 OHV Turbo-Diesel L4 4.1875" Bore (Standard)	51	50 Distillate ... Wheel Tractor	3.1L 190 OHV Distillate L2 4.6875" Bore	35
4239T ... Windrower	3.9L 239 OHV Turbo-Diesel L4 4.1875" Bore (Standard)	51	520 ... Wheel Tractor	3.1L 190 OHV L2 4.6875" Bore	34
4239T ... Loader Tractor	3.9L 239 OHV Turbo-Diesel L4 4.1875" Bore (Standard)	51	520 Distillate ... Wheel Tractor	3.1L 190 OHV Distillate L2 4.6875" Bore	35
4239T ... Excavator	3.9L 239 OHV Turbo-Diesel L4 4.1875" Bore (Standard)	51	530 ... Wheel Tractor	3.1L 190 OHV L2 4.6875" Bore	34
4239T ... Backhoe	3.9L 239 OHV Turbo-Diesel L4 4.1875" Bore (Standard)	51	540A ... Skidder	5.4L 329 OHV Turbo-Diesel L6 4.0156" Bore	80
4241G ... Forklift	3.9L 241 OHV L4 4.25" Bore	54	6-71 ... Wheel Tractor	7.0L 426 OHV Diesel L6 4.25" Bore (6-71) (Detroit Diesel Eng.)	112
4241G ... Loader	3.9L 241 OHV L4 4.25" Bore	54	6-71N ... Wheel Tractor	7.0L 426 OHV Diesel L6 4.25" Bore (6-71) (Detroit Diesel Eng.)	112
4241G ... Wheel Tractor	3.9L 241 OHV L4 4.25" Bore	54	60 ... Wheel Tractor	5.3L 321 OHV L2 5.5" Bore	76
4241G ... Loader Tractor	3.9L 241 OHV L4 4.25" Bore	54	6059D ... Grader	5.9L 358.4 (5876cc) OHV Diesel L6 106mm Bore (Litre Engine)	83
4241G ... Dozer	3.9L 241 OHV L4 4.25" Bore	54	6059D ... Loader	5.9L 358.4 (5876cc) OHV Diesel L6 106mm Bore (Litre Engine)	83
4241G ... Backhoe	3.9L 241 OHV L4 4.25" Bore	54	6059T ... Grader	5.9L 358.4 (5876cc) OHV Turbo-Diesel L6 106mm Bore (Litre Engine)	84
4241LP LPG ... Wheel Tractor	3.9L 241 OHV LPG L4 4.25" Bore	55	6059T ... Loader	5.9L 358.4 (5876cc) OHV Turbo-Diesel L6 106mm Bore (Litre Engine)	84
4241LP LPG ... Loader Tractor	3.9L 241 OHV LPG L4 4.25" Bore	55	6059T ... Skidder	5.9L 358.4 (5876cc) OHV Turbo-Diesel L6 106mm Bore (Litre Engine)	84
4241NG Natural Gas ... Wheel Tractor	3.9L 241 OHV NG L4 4.25" Bore	56	6068T ... Cotton Picker	6.8L 413.8 (6784cc) OHV Turbo-Diesel L6 106mm Bore (Litre Engine)	106
4241NG Natural Gas ... Loader Tractor	3.9L 241 OHV NG L4 4.25" Bore	56	6068T ... Loader	6.8L 413.8 (6784cc) OHV Turbo-Diesel L6 106mm Bore (Litre Engine)	106
4270D ... Loader	4.4L 270 OHV Diesel L4 4.25" Bore	60	6068T ... Crawler Tractor	6.8L 413.8 (6784cc) OHV Turbo-Diesel L6 106mm Bore (Litre Engine)	106
4270D ... Wheel Tractor	4.4L 270 OHV Diesel L4 4.25" Bore	60	6068T ... Excavator	6.8L 413.8 (6784cc) OHV Turbo-Diesel L6 106mm Bore (Litre Engine)	106
4270D ... Loader Tractor	4.4L 270 OHV Diesel L4 4.25" Bore	60	6068T ... Skidder	6.8L 413.8 (6784cc) OHV Turbo-Diesel L6 106mm Bore (Litre Engine)	106
4270D ... Backhoe	4.4L 270 OHV Diesel L4 4.25" Bore	60	6068T ... Feller Buncher	6.8L 413.8 (6784cc) OHV Turbo-Diesel L6 106mm Bore (Litre Engine)	106
4276D ... Loader	4.5L 276 OHV Diesel L4 4.1875" Bore (Standard)	67	6076A ... Grader	7.6L 465.9 (7638cc) OHV Turbo-Diesel L6 115mm Bore (Litre Engine)	116
4276D ... Wheel Tractor	4.5L 276 OHV Diesel L4 4.1875" Bore (Standard)	67	6076A ... Loader	7.6L 465.9 (7638cc) OHV Turbo-Diesel L6 115mm Bore (Litre Engine)	116
4276D ... Crawler Tractor	4.5L 276 OHV Diesel L4 4.1875" Bore (Standard)	67	6076A ... Wheel Tractor	7.6L 465.9 (7638cc) OHV Turbo-Diesel L6 115mm Bore (Litre Engine)	116
4276D ... Loader Tractor	4.5L 276 OHV Diesel L4 4.1875" Bore (Standard)	67	6076A ... Excavator	7.6L 465.9 (7638cc) OHV Turbo-Diesel L6 115mm Bore (Litre Engine)	116
4276D ... Excavator	4.5L 276 OHV Diesel L4 4.1875" Bore (Standard)	67	6076A ... Skidder	7.6L 465.9 (7638cc) OHV Turbo-Diesel L6 115mm Bore (Litre Engine)	116
4276D ... Skidder	4.5L 276 OHV Diesel L4 4.1875" Bore (Standard)	67	6076D ... Loader	7.6L 465.9 (7638cc) OHV Diesel L6 115mm Bore (Litre Engine)	115
4276D ... Dozer	4.5L 276 OHV Diesel L4 4.1875" Bore (Standard)	67	6076H ... Grader	7.6L 465.9 (7638cc) OHV Turbo-Diesel L6 115mm Bore (Litre Engine)	116
4276D ... Backhoe	4.5L 276 OHV Diesel L4 4.1875" Bore (Standard)	67	6076H ... Loader	7.6L 465.9 (7638cc) OHV Turbo-Diesel L6 115mm Bore (Litre Engine)	116
4276D ... Feller Buncher	4.5L 276 OHV Diesel L4 4.1875" Bore (Standard)	67			
4276T ... Loader	4.5L 276 OHV Turbo-Diesel L4 4.1875" Bore (Standard)	68			
4276T ... Wheel Tractor	4.5L 276 OHV Turbo-Diesel L4 4.1875" Bore (Standard)	68			
4276T ... Crawler Tractor	4.5L 276 OHV Turbo-Diesel L4 4.1875" Bore (Standard)	68			
4276T ... Loader Tractor	4.5L 276 OHV Turbo-Diesel L4 4.1875" Bore (Standard)	68			
4276T ... Excavator	4.5L 276 OHV Turbo-Diesel L4 4.1875" Bore (Standard)	68			
4276T ... Skidder	4.5L 276 OHV Turbo-Diesel L4 4.1875" Bore (Standard)	68			
4276T ... Dozer	4.5L 276 OHV Turbo-Diesel L4 4.1875" Bore (Standard)	68			
4276T ... Backhoe	4.5L 276 OHV Turbo-Diesel L4 4.1875" Bore (Standard)	68			
430 ... Wheel Tractor	1.9L 113 OHV L2 4.25" Bore	7			

(continued on next page)

## Engine Code Index

Engine Code	Engine Description	Line No.	Engine Code	Engine Description	Line No.
6076H ... Wheel Tractor	7.6L 465.9 (7638cc) OHV Turbo-Diesel L6 115mm Bore (Litre Engine)	116	6081H ... Off-Highway Truck	8.1L 495.9 (8129cc) OHV Turbo-Diesel L6 116mm Bore (PowerTech 2V IC)	118
6076H ... Excavator	7.6L 465.9 (7638cc) OHV Turbo-Diesel L6 115mm Bore (Litre Engine)	116	6081H ... Combine	8.1L 495.9 (8129cc) OHV Turbo-Diesel L6 116mm Bore (PowerTech 2V IC)	118
6076H ... Skidder	7.6L 465.9 (7638cc) OHV Turbo-Diesel L6 115mm Bore (Litre Engine)	116	6081H ... Cotton Picker	8.1L 495.9 (8129cc) OHV Turbo-Diesel L6 116mm Bore (PowerTech 2V IC)	118
6076T ... Grader	7.6L 465.9 (7638cc) OHV Turbo-Diesel L6 115mm Bore (Litre Engine)	116	6081H ... Harvester	8.1L 495.9 (8129cc) OHV Turbo-Diesel L6 116mm Bore (PowerTech 2V IC)	118
6076T ... Loader	7.6L 465.9 (7638cc) OHV Turbo-Diesel L6 115mm Bore (Litre Engine)	116	6081H ... Grader	8.1L 495.9 (8129cc) OHV Turbo-Diesel L6 116mm Bore (PowerTech 2V IC)	118
6076T ... Wheel Tractor	7.6L 465.9 (7638cc) OHV Turbo-Diesel L6 115mm Bore (Litre Engine)	116	6081H ... Power Unit	8.1L 495.9 (8129cc) OHV Turbo-Diesel L6 116mm Bore (PowerTech 2V IC)	118
6076T ... Excavator	7.6L 465.9 (7638cc) OHV Turbo-Diesel L6 115mm Bore (Litre Engine)	116	6081H ... Scraper	8.1L 495.9 (8129cc) OHV Turbo-Diesel L6 116mm Bore (PowerTech 2V IC)	118
6076T ... Skidder	7.6L 465.9 (7638cc) OHV Turbo-Diesel L6 115mm Bore (Litre Engine)	116	6081H ... Wheel Tractor	8.1L 495.9 (8129cc) OHV Turbo-Diesel L6 116mm Bore (PowerTech 2V IC)	118
6081A ... Off-Highway Truck	8.1L 495.9 (8129cc) OHV Turbo-Diesel L6 116mm Bore (PowerTech 2V AC)	119	6081H ... Crawler Tractor	8.1L 495.9 (8129cc) OHV Turbo-Diesel L6 116mm Bore (PowerTech 2V IC)	118
6081A ... Combine	8.1L 495.9 (8129cc) OHV Turbo-Diesel L6 116mm Bore (PowerTech 2V AC)	119	6081H ... Loader Tractor	8.1L 495.9 (8129cc) OHV Turbo-Diesel L6 116mm Bore (PowerTech 2V IC)	118
6081A ... Cotton Picker	8.1L 495.9 (8129cc) OHV Turbo-Diesel L6 116mm Bore (PowerTech 2V AC)	119	6081H ... Forestry Tractor	8.1L 495.9 (8129cc) OHV Turbo-Diesel L6 116mm Bore (PowerTech 2V IC)	118
6081A ... Harvester	8.1L 495.9 (8129cc) OHV Turbo-Diesel L6 116mm Bore (PowerTech 2V AC)	119	6081H ... Excavator	8.1L 495.9 (8129cc) OHV Turbo-Diesel L6 116mm Bore (PowerTech 2V IC)	118
6081A ... Grader	8.1L 495.9 (8129cc) OHV Turbo-Diesel L6 116mm Bore (PowerTech 2V AC)	119	6081H ... Skidder	8.1L 495.9 (8129cc) OHV Turbo-Diesel L6 116mm Bore (PowerTech 2V IC)	118
6081A ... Power Unit	8.1L 495.9 (8129cc) OHV Turbo-Diesel L6 116mm Bore (PowerTech 2V AC)	119	6081H ... Logger	8.1L 495.9 (8129cc) OHV Turbo-Diesel L6 116mm Bore (PowerTech 2V IC)	118
6081A ... Scraper	8.1L 495.9 (8129cc) OHV Turbo-Diesel L6 116mm Bore (PowerTech 2V AC)	119	6081H ... Feller Buncher	8.1L 495.9 (8129cc) OHV Turbo-Diesel L6 116mm Bore (PowerTech 2V IC)	118
6081A ... Wheel Tractor	8.1L 495.9 (8129cc) OHV Turbo-Diesel L6 116mm Bore (PowerTech 2V AC)	119	6081H ... Forage Harvester	8.1L 495.9 (8129cc) OHV Turbo-Diesel L6 116mm Bore (PowerTech 2V IC)	118
6081A ... Crawler Tractor	8.1L 495.9 (8129cc) OHV Turbo-Diesel L6 116mm Bore (PowerTech 2V AC)	119	6081HN ... Power Unit	8.1L 495.9 (8129cc) OHV Turbo-NG L6 116mm Bore (PowerTech 2V IC)	117
6081A ... Loader Tractor	8.1L 495.9 (8129cc) OHV Turbo-Diesel L6 116mm Bore (PowerTech 2V AC)	119	6081HN ... Wheel Tractor	8.1L 495.9 (8129cc) OHV Turbo-NG L6 116mm Bore (PowerTech 2V IC)	117
6081A ... Forestry Tractor	8.1L 495.9 (8129cc) OHV Turbo-Diesel L6 116mm Bore (PowerTech 2V AC)	119	6081T ... Combine	8.1L 495.9 (8129cc) OHV Turbo-Diesel L6 116mm Bore (PowerTech 2V)	121
6081A ... Excavator	8.1L 495.9 (8129cc) OHV Turbo-Diesel L6 116mm Bore (PowerTech 2V AC)	119	6081T ... Cotton Picker	8.1L 495.9 (8129cc) OHV Turbo-Diesel L6 116mm Bore (PowerTech 2V)	121
6081A ... Skidder	8.1L 495.9 (8129cc) OHV Turbo-Diesel L6 116mm Bore (PowerTech 2V AC)	119	6081T ... Harvester	8.1L 495.9 (8129cc) OHV Turbo-Diesel L6 116mm Bore (PowerTech 2V)	121
6081A ... Logger	8.1L 495.9 (8129cc) OHV Turbo-Diesel L6 116mm Bore (PowerTech 2V AC)	119	6081T ... Grader	8.1L 495.9 (8129cc) OHV Turbo-Diesel L6 116mm Bore (PowerTech 2V)	121
6081A ... Feller Buncher	8.1L 495.9 (8129cc) OHV Turbo-Diesel L6 116mm Bore (PowerTech 2V AC)	119	6081T ... Power Unit	8.1L 495.9 (8129cc) OHV Turbo-Diesel L6 116mm Bore (PowerTech 2V)	121
6081A ... Forage Harvester	8.1L 495.9 (8129cc) OHV Turbo-Diesel L6 116mm Bore (PowerTech 2V AC)	119	6081T ... Scraper	8.1L 495.9 (8129cc) OHV Turbo-Diesel L6 116mm Bore (PowerTech 2V)	121

(continued on next page)



## Engine Code Index

Engine Code	Engine Description	Line No.	Engine Code	Engine Description	Line No.
6081T ... Wheel Tractor	8.1L 495.9 (8129cc) OHV Turbo-Diesel L6 116mm Bore (PowerTech 2V)	121	6303D ... Skidder	5.0L 303 OHV Diesel L6 3.8594" Bore	73
6081T ... Crawler Tractor	8.1L 495.9 (8129cc) OHV Turbo-Diesel L6 116mm Bore (PowerTech 2V)	121	6303G ... Combine	5.0L 303 OHV L6 3.8594" Bore	72
6081T ... Loader Tractor	8.1L 495.9 (8129cc) OHV Turbo-Diesel L6 116mm Bore (PowerTech 2V)	121	6303G ... Cotton Picker	5.0L 303 OHV L6 3.8594" Bore	72
6081T ... Forestry Tractor	8.1L 495.9 (8129cc) OHV Turbo-Diesel L6 116mm Bore (PowerTech 2V)	121	6303G ... Power Unit	5.0L 303 OHV L6 3.8594" Bore	72
6081T ... Excavator	8.1L 495.9 (8129cc) OHV Turbo-Diesel L6 116mm Bore (PowerTech 2V)	121	6303G ... Wheel Tractor	5.0L 303 OHV L6 3.8594" Bore	72
6081T ... Skidder	8.1L 495.9 (8129cc) OHV Turbo-Diesel L6 116mm Bore (PowerTech 2V)	121	6303G ... Loader Tractor	5.0L 303 OHV L6 3.8594" Bore	72
6081T ... Sprayer	8.1L 495.9 (8129cc) OHV Turbo-Diesel L6 116mm Bore (PowerTech 2V)	121	6303LP LPG ... Combine	5.0L 303 OHV LPG L6 3.8594" Bore	74
6081T ... Logger	8.1L 495.9 (8129cc) OHV Turbo-Diesel L6 116mm Bore (PowerTech 2V)	121	6303LP LPG ... Cotton Picker	5.0L 303 OHV LPG L6 3.8594" Bore	74
6081T ... Feller Buncher	8.1L 495.9 (8129cc) OHV Turbo-Diesel L6 116mm Bore (PowerTech 2V)	121	6303LP LPG ... Power Unit	5.0L 303 OHV LPG L6 3.8594" Bore	74
6081TN ... Power Unit	8.1L 495.9 (8129cc) OHV Turbo-NG L6 116mm Bore (PowerTech 2V)	120	6303LP LPG ... Wheel Tractor	5.0L 303 OHV LPG L6 3.8594" Bore	74
6081TN ... Wheel Tractor	8.1L 495.9 (8129cc) OHV Turbo-NG L6 116mm Bore (PowerTech 2V)	120	6303LP LPG ... Loader Tractor	5.0L 303 OHV LPG L6 3.8594" Bore	74
6090A ... Harvester	9.0L 549 (9000cc) OHV Turbo-Diesel L6 118.4mm Bore (PowerTech 4V AC)	125	6329D ... Combine	5.4L 329 OHV Diesel L6 4.0156" Bore	78
6090A ... Power Unit	9.0L 549 (9000cc) OHV Turbo-Diesel L6 118.4mm Bore (PowerTech 4V AC)	125	6329D ... Cotton Picker	5.4L 329 OHV Diesel L6 4.0156" Bore	78
6090A ... Wheel Tractor	9.0L 549 (9000cc) OHV Turbo-Diesel L6 118.4mm Bore (PowerTech 4V AC)	125	6329D ... Grader	5.4L 329 OHV Diesel L6 4.0156" Bore	78
6090H ... Harvester	9.0L 549 (9000cc) OHV Turbo-Diesel L6 118.4mm Bore (PowerTech 4V IC)	124	6329D ... Loader	5.4L 329 OHV Diesel L6 4.0156" Bore	78
6090H ... Power Unit	9.0L 549 (9000cc) OHV Turbo-Diesel L6 118.4mm Bore (PowerTech 4V IC)	124	6329D ... Power Unit	5.4L 329 OHV Diesel L6 4.0156" Bore	78
6090H ... Wheel Tractor	9.0L 549 (9000cc) OHV Turbo-Diesel L6 118.4mm Bore (PowerTech 4V IC)	124	6329D ... Wheel Tractor	5.4L 329 OHV Diesel L6 4.0156" Bore	78
6090T ... Harvester	9.0L 549 (9000cc) OHV Turbo-Diesel L6 118.4mm Bore (PowerTech 4V)	126	6329D ... Skidder	5.4L 329 OHV Diesel L6 4.0156" Bore	78
6090T ... Power Unit	9.0L 549 (9000cc) OHV Turbo-Diesel L6 118.4mm Bore (PowerTech 4V)	126	6329G ... Combine	5.4L 329 OHV L6 4.0156" Bore	77
6090T ... Wheel Tractor	9.0L 549 (9000cc) OHV Turbo-Diesel L6 118.4mm Bore (PowerTech 4V)	126	6329G ... Cotton Picker	5.4L 329 OHV L6 4.0156" Bore	77
6303D ... Combine	5.0L 303 OHV Diesel L6 3.8594" Bore	73	6329G ... Power Unit	5.4L 329 OHV L6 4.0156" Bore	77
6303D ... Cotton Picker	5.0L 303 OHV Diesel L6 3.8594" Bore	73	6329LP LPG ... Combine	5.4L 329 OHV LPG L6 4.0156" Bore	79
6303D ... Grader	5.0L 303 OHV Diesel L6 3.8594" Bore	73	6329LP LPG ... Cotton Picker	5.4L 329 OHV LPG L6 4.0156" Bore	79
6303D ... Loader	5.0L 303 OHV Diesel L6 3.8594" Bore	73	6329LP LPG ... Power Unit	5.4L 329 OHV LPG L6 4.0156" Bore	79
6303D ... Power Unit	5.0L 303 OHV Diesel L6 3.8594" Bore	73	6329T ... Grader	5.4L 329 OHV Turbo-Diesel L6 4.0156" Bore	80
6303D ... Loader Tractor	5.0L 303 OHV Diesel L6 3.8594" Bore	73	6329T ... Loader	5.4L 329 OHV Turbo-Diesel L6 4.0156" Bore	80
			6329T ... Wheel Tractor	5.4L 329 OHV Turbo-Diesel L6 4.0156" Bore	80
			6329T ... Backhoe	5.4L 329 OHV Turbo-Diesel L6 4.0156" Bore	80
			6341G ... Combine	5.6L 340 OHV L6 4.25" Bore	81
			6341G ... Power Unit	5.6L 340 OHV L6 4.25" Bore	81
			6341G ... Wheel Tractor	5.6L 340 OHV L6 4.25" Bore	81
			6341G ... Loader Tractor	5.6L 340 OHV L6 4.25" Bore	81
			6341LP LPG ... Wheel Tractor	5.6L 340 OHV LPG L6 4.25" Bore	82
			6341LP LPG ... Loader Tractor	5.6L 340 OHV LPG L6 4.25" Bore	82
			6359D ... Combine	5.9L 359 OHV Diesel L6 4.1875" Bore	85
			6359D ... Cotton Picker	5.9L 359 OHV Diesel L6 4.1875" Bore	85
			6359D ... Grader	5.9L 359 OHV Diesel L6 4.1875" Bore	85
			6359D ... Wheel Tractor	5.9L 359 OHV Diesel L6 4.1875" Bore	85
			6359T ... Combine	5.9L 359 OHV Turbo-Diesel L6 4.1875" Bore	86

(continued on next page)

## Engine Code Index

Engine Code	Engine Description	Line No.	Engine Code	Engine Description	Line No.
6359T ... Cotton Picker.....	5.9L 359 OHV Turbo-Diesel L6 4.1875" Bore.....	86	6404T ... Skidder .....	6.6L 404 OHV Turbo-Diesel L6 4.25" Bore (Aftercooled) .....	98
6359T ... Grader .....	5.9L 359 OHV Turbo-Diesel L6 4.1875" Bore.....	86	6404T ... Compactor.....	6.6L 404 OHV Turbo-Diesel L6 4.25" Bore (Aftercooled) .....	98
6359T ... Loader .....	5.9L 359 OHV Turbo-Diesel L6 4.1875" Bore.....	86	6404T ... Feller Buncher.....	6.6L 404 OHV Turbo-Diesel L6 4.25" Bore (Aftercooled) .....	98
6359T ... Wheel Tractor.....	5.9L 359 OHV Turbo-Diesel L6 4.1875" Bore.....	86	6404T ... Forage Harvester ...	6.6L 404 OHV Turbo-Diesel L6 4.25" Bore (Aftercooled) .....	98
6359T ... Loader Tractor.....	5.9L 359 OHV Turbo-Diesel L6 4.1875" Bore.....	86	6404T ... Wheel Tractor.....	6.6L 404 OHV Turbo-Diesel L6 4.25" Bore (Early) .....	99
6359T ... Skidder .....	5.9L 359 OHV Turbo-Diesel L6 4.1875" Bore.....	86	6414D ... Grader.....	6.8L 414 OHV Diesel L6 4.1875" Bore (Standard) .....	109
6359T ... Backhoe .....	5.9L 359 OHV Turbo-Diesel L6 4.1875" Bore.....	86	6414D ... Loader.....	6.8L 414 OHV Diesel L6 4.1875" Bore (Standard) .....	109
6362G ... Combine .....	5.9L 362 OHV L6 4.25" Bore .....	87	6414D ... Crawler Tractor .....	6.8L 414 OHV Diesel L6 4.1875" Bore (Standard) .....	109
6362G ... Power Unit .....	5.9L 362 OHV L6 4.25" Bore .....	87	6414D ... Loader Tractor .....	6.8L 414 OHV Diesel L6 4.1875" Bore (Standard) .....	109
6362G ... Wheel Tractor .....	5.9L 362 OHV L6 4.25" Bore .....	87	6414D ... Skidder.....	6.8L 414 OHV Diesel L6 4.1875" Bore (Standard) .....	109
6362G ... Loader Tractor .....	5.9L 362 OHV L6 4.25" Bore .....	87	6414T ... Grader .....	6.8L 414 OHV Turbo-Diesel L6 4.1875" Bore (Standard).....	110
6362LP LPG ... Wheel Tractor.....	5.9L 362 OHV LPG L6 4.25" Bore .....	88	6414T ... Loader .....	6.8L 414 OHV Turbo-Diesel L6 4.1875" Bore (Standard).....	110
6362NG Natural Gas ... Wheel Tractor .....	5.9L 362 OHV NG L6 4.25" Bore .	89	6414T ... Crawler Tractor.....	6.8L 414 OHV Turbo-Diesel L6 4.1875" Bore (Standard).....	110
6381D ... Power Unit .....	6.2L 381 OHV Diesel L6 4.125" Bore .....	94	6414T ... Loader Tractor.....	6.8L 414 OHV Turbo-Diesel L6 4.1875" Bore (Standard).....	110
6381D ... Wheel Tractor .....	6.2L 381 OHV Diesel L6 4.125" Bore .....	94	6414T ... Forestry Tractor.....	6.8L 414 OHV Turbo-Diesel L6 4.1875" Bore (Standard).....	110
6404A ... Combine.....	6.6L 404 OHV Turbo-Diesel L6 4.25" Bore (Aftercooled) .....	98	6414T ... Excavator .....	6.8L 414 OHV Turbo-Diesel L6 4.1875" Bore (Standard).....	110
6404A ... Harvester.....	6.6L 404 OHV Turbo-Diesel L6 4.25" Bore (Aftercooled) .....	98	6414T ... Skidder .....	6.8L 414 OHV Turbo-Diesel L6 4.1875" Bore (Standard).....	110
6404A ... Loader.....	6.6L 404 OHV Turbo-Diesel L6 4.25" Bore (Aftercooled) .....	98	6414T ... Dozer.....	6.8L 414 OHV Turbo-Diesel L6 4.1875" Bore (Standard).....	110
6404A ... Wheel Tractor.....	6.6L 404 OHV Turbo-Diesel L6 4.25" Bore (Aftercooled) .....	98	6414T ... Feller Buncher.....	6.8L 414 OHV Turbo-Diesel L6 4.1875" Bore (Standard).....	110
6404A ... Excavator .....	6.6L 404 OHV Turbo-Diesel L6 4.25" Bore (Aftercooled) .....	98	6466A ... Combine.....	7.6L 466 OHV Turbo-Diesel L6 4.5625" Bore (Standard).....	114
6404A ... Skidder.....	6.6L 404 OHV Turbo-Diesel L6 4.25" Bore (Aftercooled) .....	98	6466A ... Cotton Picker.....	7.6L 466 OHV Turbo-Diesel L6 4.5625" Bore (Standard).....	114
6404A ... Compactor.....	6.6L 404 OHV Turbo-Diesel L6 4.25" Bore (Aftercooled) .....	98	6466A ... Corn Picker .....	7.6L 466 OHV Turbo-Diesel L6 4.5625" Bore (Standard).....	114
6404D ... Combine.....	6.6L 404 OHV Diesel L6 4.25" Bore (Early) .....	95	6466A ... Harvester.....	7.6L 466 OHV Turbo-Diesel L6 4.5625" Bore (Standard).....	114
6404D ... Power Unit .....	6.6L 404 OHV Diesel L6 4.25" Bore (Early) .....	95	6466A ... Grader.....	7.6L 466 OHV Turbo-Diesel L6 4.5625" Bore (Standard).....	114
6404D ... Wheel Tractor .....	6.6L 404 OHV Diesel L6 4.25" Bore (Early) .....	95	6466A ... Loader.....	7.6L 466 OHV Turbo-Diesel L6 4.5625" Bore (Standard).....	114
6404D ... Loader Tractor .....	6.6L 404 OHV Diesel L6 4.25" Bore (Early) .....	95	6466A ... Scraper.....	7.6L 466 OHV Turbo-Diesel L6 4.5625" Bore (Standard).....	114
6404D ... Backhoe.....	6.6L 404 OHV Diesel L6 4.25" Bore (Early) .....	95	6466A ... Wheel Tractor.....	7.6L 466 OHV Turbo-Diesel L6 4.5625" Bore (Standard).....	114
6404D ... Combine.....	6.6L 404 OHV Diesel L6 4.25" Bore (Late) .....	96	6466A ... Crawler Tractor .....	7.6L 466 OHV Turbo-Diesel L6 4.5625" Bore (Standard).....	114
6404D ... Harvester .....	6.6L 404 OHV Diesel L6 4.25" Bore (Late) .....	96	6466A ... Forestry Tractor.....	7.6L 466 OHV Turbo-Diesel L6 4.5625" Bore (Standard).....	114
6404D ... Power Unit .....	6.6L 404 OHV Diesel L6 4.25" Bore (Late) .....	96	6466A ... Excavator .....	7.6L 466 OHV Turbo-Diesel L6 4.5625" Bore (Standard).....	114
6404D ... Wheel Tractor .....	6.6L 404 OHV Diesel L6 4.25" Bore (Late) .....	96	6466A ... Skidder.....	7.6L 466 OHV Turbo-Diesel L6 4.5625" Bore (Standard).....	114
6404D ... Loader Tractor .....	6.6L 404 OHV Diesel L6 4.25" Bore (Late) .....	96	6466A ... Compactor.....	7.6L 466 OHV Turbo-Diesel L6 4.5625" Bore (Standard).....	114
6404D ... Wheel Tractor .....	6.6L 404 OHV Diesel L6 4.25" Bore (5 Main) .....	97	6466A ... Dozer.....	7.6L 466 OHV Turbo-Diesel L6 4.5625" Bore (Standard).....	114
6404T ... Combine.....	6.6L 404 OHV Turbo-Diesel L6 4.25" Bore (Aftercooled) .....	98	6466A ... Feller Buncher.....	7.6L 466 OHV Turbo-Diesel L6 4.5625" Bore (Standard).....	114
6404T ... Harvester.....	6.6L 404 OHV Turbo-Diesel L6 4.25" Bore (Aftercooled) .....	98	6466A ... Forage Harvester ...	7.6L 466 OHV Turbo-Diesel L6 4.5625" Bore (Standard).....	114
6404T ... Loader .....	6.6L 404 OHV Turbo-Diesel L6 4.25" Bore (Aftercooled) .....	98	6466D ... Combine.....	7.6L 466 OHV Diesel L6 4.5625" Bore (Standard).....	113
6404T ... Wheel Tractor.....	6.6L 404 OHV Turbo-Diesel L6 4.25" Bore (Aftercooled) .....	98			
6404T ... Excavator .....	6.6L 404 OHV Turbo-Diesel L6 4.25" Bore (Aftercooled) .....	98			



## Engine Code Index

Engine Code	Engine Description	Line No.	Engine Code	Engine Description	Line No.
6466D ... Wheel Tractor	7.6L 466 OHV Diesel L6 4.5625" Bore (Standard)	113	6531T ... Grader	8.7L 531 OHV Turbo-Diesel L6 4.75" Bore	123
6466T ... Combine	7.6L 466 OHV Turbo-Diesel L6 4.5625" Bore (Standard)	114	6531T ... Loader	8.7L 531 OHV Turbo-Diesel L6 4.75" Bore	123
6466T ... Corn Picker	7.6L 466 OHV Turbo-Diesel L6 4.5625" Bore (Standard)	114	6531T ... Wheel Tractor	8.7L 531 OHV Turbo-Diesel L6 4.75" Bore	123
6466T ... Harvester	7.6L 466 OHV Turbo-Diesel L6 4.5625" Bore (Standard)	114	6531T ... Compactor	8.7L 531 OHV Turbo-Diesel L6 4.75" Bore	123
6466T ... Grader	7.6L 466 OHV Turbo-Diesel L6 4.5625" Bore (Standard)	114	6619A ... Combine	10.1L 619 OHV Turbo-Diesel L6 5.125" Bore	127
6466T ... Loader	7.6L 466 OHV Turbo-Diesel L6 4.5625" Bore (Standard)	114	6619A ... Harvester	10.1L 619 OHV Turbo-Diesel L6 5.125" Bore	127
6466T ... Scraper	7.6L 466 OHV Turbo-Diesel L6 4.5625" Bore (Standard)	114	6619A ... Scraper	10.1L 619 OHV Turbo-Diesel L6 5.125" Bore	127
6466T ... Wheel Tractor	7.6L 466 OHV Turbo-Diesel L6 4.5625" Bore (Standard)	114	6619A ... Wheel Tractor	10.1L 619 OHV Turbo-Diesel L6 5.125" Bore	127
6466T ... Crawler Tractor	7.6L 466 OHV Turbo-Diesel L6 4.5625" Bore (Standard)	114	6619A ... Windrower	10.1L 619 OHV Turbo-Diesel L6 5.125" Bore	127
6466T ... Forestry Tractor	7.6L 466 OHV Turbo-Diesel L6 4.5625" Bore (Standard)	114	6619A ... Crawler Tractor	10.1L 619 OHV Turbo-Diesel L6 5.125" Bore	127
6466T ... Excavator	7.6L 466 OHV Turbo-Diesel L6 4.5625" Bore (Standard)	114	6619A ... Excavator	10.1L 619 OHV Turbo-Diesel L6 5.125" Bore	127
6466T ... Skidder	7.6L 466 OHV Turbo-Diesel L6 4.5625" Bore (Standard)	114	6619A ... Dozer	10.1L 619 OHV Turbo-Diesel L6 5.125" Bore	127
6466T ... Compactor	7.6L 466 OHV Turbo-Diesel L6 4.5625" Bore (Standard)	114	6619A ... Forage Harvester	10.1L 619 OHV Turbo-Diesel L6 5.125" Bore	127
6466T ... Dozer	7.6L 466 OHV Turbo-Diesel L6 4.5625" Bore (Standard)	114	6619T ... Combine	10.1L 619 OHV Turbo-Diesel L6 5.125" Bore	127
6466T ... Feller Buncher	7.6L 466 OHV Turbo-Diesel L6 4.5625" Bore (Standard)	114	6619T ... Harvester	10.1L 619 OHV Turbo-Diesel L6 5.125" Bore	127
6531A ... Harvester	8.7L 531 OHV Turbo-Diesel L6 4.75" Bore	123	6619T ... Scraper	10.1L 619 OHV Turbo-Diesel L6 5.125" Bore	127
6531A ... Grader	8.7L 531 OHV Turbo-Diesel L6 4.75" Bore	123	6619T ... Wheel Tractor	10.1L 619 OHV Turbo-Diesel L6 5.125" Bore	127
6531A ... Loader	8.7L 531 OHV Turbo-Diesel L6 4.75" Bore	123	6619T ... Windrower	10.1L 619 OHV Turbo-Diesel L6 5.125" Bore	127
6531A ... Wheel Tractor	8.7L 531 OHV Turbo-Diesel L6 4.75" Bore	123	6619T ... Crawler Tractor	10.1L 619 OHV Turbo-Diesel L6 5.125" Bore	127
6531A ... Compactor	8.7L 531 OHV Turbo-Diesel L6 4.75" Bore	123	6619T ... Excavator	10.1L 619 OHV Turbo-Diesel L6 5.125" Bore	127
6531D ... Scraper	8.7L 531 OHV Diesel L6 4.75" Bore	122	6619T ... Dozer	10.1L 619 OHV Turbo-Diesel L6 5.125" Bore	127
6531D ... Wheel Tractor	8.7L 531 OHV Diesel L6 4.75" Bore	122	70 ... Wheel Tractor	6.2L 380 OHV L2 5.875" Bore	93
6531D ... Loader Tractor	8.7L 531 OHV Diesel L6 4.75" Bore	122	70 ... Wheel Tractor	6.8L 413 OHV L2 6.125" Bore	100
6531D ... Backhoe	8.7L 531 OHV Diesel L6 4.75" Bore	122	720 ... Wheel Tractor	5.9L 362 OHV L2 6" Bore	90
6531T ... Harvester	8.7L 531 OHV Turbo-Diesel L6 4.75" Bore	123	720 ... Wheel Tractor	5.9L 362 OHV Diesel L2 6" Bore	91
			720 ... Wheel Tractor	6.2L 378 OHV L2 6.125" Bore	92
			730 ... Wheel Tractor	5.9L 362 OHV L2 6" Bore	90
			730 ... Wheel Tractor	5.9L 362 OHV Diesel L2 6" Bore	91
			730 ... Wheel Tractor	6.2L 378 OHV L2 6.125" Bore	92

## Model Index

Model	Engine Description	Line No.	Model	Engine Description	Line No.
A ... Wheel Tractor	5.0L 308 OHV L2 5.5" Bore	75	AWH ... Wheel Tractor	5.3L 321 OHV L2 5.5" Bore	76
A ... Wheel Tractor	5.3L 321 OHV L2 5.5" Bore	76	B ... Wheel Tractor	2.4L 149 OHV L2 4.25" Bore	16
AH ... Wheel Tractor	5.0L 308 OHV L2 5.5" Bore	75	B ... Wheel Tractor	2.9L 175 OHV L2 4.5" Bore	26
AH ... Wheel Tractor	5.3L 321 OHV L2 5.5" Bore	76	B ... Wheel Tractor	3.1L 190 OHV L2 4.6875" Bore	34
AI ... Wheel Tractor	5.0L 308 OHV L2 5.5" Bore	75	BI ... Wheel Tractor	2.4L 149 OHV L2 4.25" Bore	16
AI ... Wheel Tractor	5.3L 321 OHV L2 5.5" Bore	76	BI ... Wheel Tractor	2.9L 175 OHV L2 4.5" Bore	26
AN ... Wheel Tractor	5.0L 308 OHV L2 5.5" Bore	75	BI ... Wheel Tractor	3.1L 190 OHV L2 4.6875" Bore	34
AN ... Wheel Tractor	5.3L 321 OHV L2 5.5" Bore	76	BN ... Wheel Tractor	2.4L 149 OHV L2 4.25" Bore	16
ANH ... Wheel Tractor	5.0L 308 OHV L2 5.5" Bore	75	BN ... Wheel Tractor	2.9L 175 OHV L2 4.5" Bore	26
ANH ... Wheel Tractor	5.3L 321 OHV L2 5.5" Bore	76	BN ... Wheel Tractor	3.1L 190 OHV L2 4.6875" Bore	34
AO ... Wheel Tractor	5.0L 308 OHV L2 5.5" Bore	75	BO ... Wheel Tractor	2.4L 149 OHV L2 4.25" Bore	16
AO ... Wheel Tractor	5.3L 321 OHV L2 5.5" Bore	76	BO ... Wheel Tractor	2.9L 175 OHV L2 4.5" Bore	26
AR ... Wheel Tractor	5.0L 308 OHV L2 5.5" Bore	75	BO ... Wheel Tractor	3.1L 190 OHV L2 4.6875" Bore	34
AR ... Wheel Tractor	5.3L 321 OHV L2 5.5" Bore	76	BR ... Wheel Tractor	2.4L 149 OHV L2 4.25" Bore	16
AW ... Wheel Tractor	5.0L 308 OHV L2 5.5" Bore	75	BR ... Wheel Tractor	2.9L 175 OHV L2 4.5" Bore	26
AW ... Wheel Tractor	5.3L 321 OHV L2 5.5" Bore	76	BR ... Wheel Tractor	3.1L 190 OHV L2 4.6875" Bore	34
AWH ... Wheel Tractor	5.0L 308 OHV L2 5.5" Bore	75	BW ... Wheel Tractor	2.4L 149 OHV L2 4.25" Bore	16

(continued on next page)



Model Index					
Model	Engine Description	Line No.	Model	Engine Description	Line No.
BW ... Wheel Tractor	2.9L 175 OHV L2 4.5" Bore	26	JD440 ... Wheel Tractor	2.9L 180 OHV L4 3.8594" Bore	31
BW ... Wheel Tractor	3.1L 190 OHV L2 4.6875" Bore	34	JD440 ... Skidder	2.9L 180 OHV L4 3.8594" Bore	31
D152 ... Forklift	2.5L 152 OHV Diesel L3 3.8594" Bore	18	JD440 ... Wheel Tractor	3.3L 202 OHV L4 3.8594" Bore	37
HA ... Combine	3.6L 217 OHV L6 3.625" Bore	39	JD440 ... Wheel Tractor	3.3L 202 OHV Diesel L4 3.8594" Bore	38
HB ... Combine	3.6L 217 OHV L6 3.625" Bore	39	JD440 ... Skidder	3.3L 202 OHV Diesel L4 3.8594" Bore	38
HD ... Combine	3.6L 217 OHV L6 3.625" Bore	39	JD440 ... Skidder	3.6L 219 OHV Diesel L4 4.0156" Bore	41
JD135G ... Power Unit	2.2L 135 OHV L3 3.8594" Bore	10	JD440 ... Skidder	3.6L 219 OHV Turbo-Diesel L4 4.0156" Bore	42
JD152D ... Power Unit	2.5L 152 OHV Diesel L3 3.8594" Bore	18	JD440C ... Skidder	4.5L 276 OHV Turbo-Diesel L4 4.1875" Bore (Standard)	68
JD164D ... Power Unit	2.7L 164 OHV Diesel L3 4.0156" Bore	23	JD450 ... Wheel Tractor	2.9L 180 OHV L4 3.8594" Bore	31
JD180G ... Power Unit	2.9L 180 OHV L4 3.8594" Bore	31	JD450 ... Crawler Tractor	2.9L 180 OHV L4 3.8594" Bore	31
JD202D ... Power Unit	3.3L 202 OHV Diesel L4 3.8594" Bore	38	JD450 ... Loader Tractor	2.9L 180 OHV L4 3.8594" Bore	31
JD202G ... Power Unit	3.3L 202 OHV L4 3.8594" Bore	37	JD450 ... Crawler Tractor	2.9L 180 OHV Diesel L4 3.8594" Bore	32
JD300 ... Wheel Tractor	2.2L 135 OHV L3 3.8594" Bore	10	JD450 ... Wheel Tractor	3.3L 202 OHV L4 3.8594" Bore	37
JD300 ... Crawler Tractor	2.2L 135 OHV L3 3.8594" Bore	10	JD450 ... Crawler Tractor	3.3L 202 OHV L4 3.8594" Bore	37
JD300 ... Loader Tractor	2.2L 135 OHV L3 3.8594" Bore	10	JD450 ... Wheel Tractor	3.3L 202 OHV Diesel L4 3.8594" Bore	38
JD300 ... Wheel Tractor	2.5L 152 OHV Diesel L3 3.8594" Bore	18	JD450 ... Crawler Tractor	3.3L 202 OHV Diesel L4 3.8594" Bore	38
JD300 ... Crawler Tractor	2.5L 152 OHV Diesel L3 3.8594" Bore	18	JD450 ... Loader Tractor	3.3L 202 OHV Diesel L4 3.8594" Bore	38
JD300 ... Loader Tractor	2.5L 152 OHV Diesel L3 3.8594" Bore	18	JD450B ... Crawler Tractor	3.6L 219 OHV L4 4.0156" Bore	40
JD302 ... Loader	2.7L 164 OHV L3 4.0156" Bore	22	JD450B ... Crawler Tractor	3.6L 219 OHV Diesel L4 4.0156" Bore	41
JD302 ... Wheel Tractor	2.7L 164 OHV L3 4.0156" Bore	22	JD450B ... Crawler Tractor	3.6L 219 OHV Turbo-Diesel L4 4.0156" Bore	42
JD302 ... Loader	2.7L 164 OHV Diesel L3 4.0156" Bore	23	JD450C ... Crawler Tractor	3.6L 219 OHV L4 4.0156" Bore	40
JD302 ... Wheel Tractor	2.7L 164 OHV Diesel L3 4.0156" Bore	23	JD450C ... Crawler Tractor	3.6L 219 OHV Diesel L4 4.0156" Bore	41
JD303D ... Power Unit	5.0L 303 OHV Diesel L6 3.8594" Bore	73	JD450C ... Crawler Tractor	3.6L 219 OHV Turbo-Diesel L4 4.0156" Bore	42
JD303G ... Power Unit	5.0L 303 OHV L6 3.8594" Bore	72	JD480 ... Wheel Tractor	2.9L 180 OHV L4 3.8594" Bore	31
JD303G ... Power Unit	5.0L 303 OHV LPG L6 3.8594" Bore	74	JD480 ... Forklift	3.3L 202 OHV Diesel L4 3.8594" Bore	38
JD329D ... Power Unit	5.4L 329 OHV Diesel L6 4.0156" Bore	78	JD480 ... Wheel Tractor	3.3L 202 OHV Diesel L4 3.8594" Bore	38
JD329G ... Power Unit	5.4L 329 OHV L6 4.0156" Bore	77	JD480B ... Forklift	3.6L 219 OHV Diesel L4 4.0156" Bore	41
JD329G ... Power Unit	5.4L 329 OHV LPG L6 4.0156" Bore	79	JD500 ... Wheel Tractor	3.3L 201 OHV L4 4" Bore	36
JD350 ... Wheel Tractor	2.2L 135 OHV L3 3.8594" Bore	10	JD500 ... Loader Tractor	3.7L 227 OHV L4 4.25" Bore	46
JD350 ... Crawler Tractor	2.2L 135 OHV L3 3.8594" Bore	10	JD500 ... Loader Tractor	3.7L 227 OHV LPG L4 4.25" Bore	47
JD350 ... Wheel Tractor	2.5L 152 OHV Diesel L3 3.8594" Bore	18	JD500 ... Loader Tractor	3.9L 241 OHV L4 4.25" Bore	54
JD350 ... Crawler Tractor	2.5L 152 OHV Diesel L3 3.8594" Bore	18	JD500 ... Loader Tractor	3.9L 241 OHV LPG L4 4.25" Bore	55
JD380 ... Wheel Tractor	2.2L 135 OHV L3 3.8594" Bore	10	JD500 ... Loader Tractor	3.9L 241 OHV NG L4 4.25" Bore	56
JD380 ... Wheel Tractor	2.2L 135 OHV Diesel L3 3.8594" Bore	11	JD500 ... Wheel Tractor	4.2L 254 OHV Diesel L4 4.125" Bore	59
JD380 ... Forklift	2.5L 152 OHV Diesel L3 3.8594" Bore	18	JD500 ... Wheel Tractor	4.4L 270 OHV Diesel L4 4.25" Bore	60
JD400 ... Wheel Tractor	2.9L 180 OHV L4 3.8594" Bore	31	JD500 ... Loader Tractor	4.4L 270 OHV Diesel L4 4.25" Bore	60
JD400 ... Loader Tractor	2.9L 180 OHV L4 3.8594" Bore	31	JD500A ... Loader Tractor	3.9L 241 OHV L4 4.25" Bore	54
JD400 ... Wheel Tractor	3.3L 202 OHV L4 3.8594" Bore	37	JD500A ... Loader Tractor	3.9L 241 OHV LPG L4 4.25" Bore	55
JD400 ... Wheel Tractor	3.3L 202 OHV Diesel L4 3.8594" Bore	38	JD500A ... Loader Tractor	3.9L 241 OHV NG L4 4.25" Bore	56
JD400 ... Loader Tractor	3.3L 202 OHV Diesel L4 3.8594" Bore	38	JD500A ... Loader Tractor	4.4L 270 OHV Diesel L4 4.25" Bore	60
JD401B ... Loader	3.3L 202 OHV Diesel L4 3.8594" Bore	38	JD500A ... Backhoe	4.4L 270 OHV Diesel L4 4.25" Bore	60
JD401C ... Loader	3.3L 202 OHV Diesel L4 3.8594" Bore	38	JD500B ... Loader Tractor	3.7L 227 OHV L4 4.25" Bore	46
JD404D ... Power Unit	6.6L 404 OHV Diesel L6 4.25" Bore (Early)	95	JD500B ... Loader Tractor	3.7L 227 OHV LPG L4 4.25" Bore	47
JD404D ... Power Unit	6.6L 404 OHV Diesel L6 4.25" Bore (Late)	96	JD500B ... Loader Tractor	3.9L 241 OHV L4 4.25" Bore	54
JD407 ... Forklift	2.9L 180 OHV L4 3.8594" Bore	31	JD500B ... Loader Tractor	3.9L 241 OHV LPG L4 4.25" Bore	55
JD410 ... Loader Tractor	3.3L 202 OHV L4 3.8594" Bore	37	JD500B ... Loader Tractor	3.9L 241 OHV NG L4 4.25" Bore	56
JD410 ... Loader	3.3L 202 OHV Diesel L4 3.8594" Bore	38			
JD410 ... Loader Tractor	3.6L 219 OHV Diesel L4 4.0156" Bore	41			

(continued on next page)



# John Deere Off Highway

Model Index					
Model	Engine Description	Line No.	Model	Engine Description	Line No.
JD500B ... Backhoe.....	4.4L 270 OHV Diesel L4 4.25" Bore.....	60	JD640GS ... Skidder.....	6.8L 414 OHV Turbo-Diesel L6 4.1875" Bore (Standard).....	110
JD500C ... Loader Tractor.....	3.9L 241 OHV L4 4.25" Bore.....	54	JD644A ... Wheel Tractor.....	6.6L 404 OHV Diesel L6 4.25" Bore (Early).....	95
JD500C ... Loader Tractor.....	3.9L 241 OHV LPG L4 4.25" Bore.....	55	JD644A ... Wheel Tractor.....	6.6L 404 OHV Diesel L6 4.25" Bore (Late).....	96
JD500C ... Loader Tractor.....	3.9L 241 OHV NG L4 4.25" Bore.....	56	JD644C ... Wheel Tractor.....	7.6L 466 OHV Diesel L6 4.5625" Bore (Standard).....	113
JD500C ... Backhoe.....	4.4L 270 OHV Diesel L4 4.25" Bore.....	60	JD644C ... Wheel Tractor.....	7.6L 466 OHV Turbo-Diesel L6 4.5625" Bore (Standard).....	114
JD510 ... Backhoe.....	4.4L 270 OHV Diesel L4 4.25" Bore.....	60	JD648D ... Skidder.....	6.8L 414 OHV Turbo-Diesel L6 4.1875" Bore (Standard).....	110
JD540 ... Wheel Tractor.....	5.4L 329 OHV Diesel L6 4.0156" Bore.....	78	JD655 ... Loader Tractor.....	6.8L 414 OHV Turbo-Diesel L6 4.1875" Bore (Standard).....	110
JD540B ... Skidder.....	4.5L 276 OHV Turbo-Diesel L4 4.1875" Bore (Standard).....	68	JD655B ... Crawler Tractor.....	6.8L 414 OHV Turbo-Diesel L6 4.1875" Bore (Standard).....	110
JD544 ... Wheel Tractor.....	2.5L 152 OHV L3 3.8594" Bore.....	17	JD670 ... Grader.....	6.8L 414 OHV Diesel L6 4.1875" Bore (Standard).....	109
JD544 ... Wheel Tractor.....	2.7L 164 OHV L3 4.0156" Bore.....	22	JD670 ... Grader.....	6.8L 414 OHV Turbo-Diesel L6 4.1875" Bore (Standard).....	110
JD544 ... Loader Tractor.....	5.0L 303 OHV L6 3.8594" Bore.....	72	JD670A ... Grader.....	6.8L 414 OHV Diesel L6 4.1875" Bore (Standard).....	109
JD544 ... Loader Tractor.....	5.0L 303 OHV Diesel L6 3.8594" Bore.....	73	JD670A ... Grader.....	6.8L 414 OHV Turbo-Diesel L6 4.1875" Bore (Standard).....	110
JD544 ... Loader Tractor.....	5.0L 303 OHV LPG L6 3.8594" Bore.....	74	JD670B ... Grader.....	6.8L 414 OHV Turbo-Diesel L6 4.1875" Bore (Standard).....	110
JD544 ... Loader.....	5.4L 329 OHV Diesel L6 4.0156" Bore.....	78	JD672 ... Grader.....	6.8L 414 OHV Diesel L6 4.1875" Bore (Standard).....	109
JD544 ... Wheel Tractor.....	5.4L 329 OHV Diesel L6 4.0156" Bore.....	78	JD672A ... Grader.....	6.8L 414 OHV Turbo-Diesel L6 4.1875" Bore (Standard).....	110
JD544 ... Loader.....	5.4L 329 OHV Turbo-Diesel L6 4.0156" Bore.....	80	JD672B ... Grader.....	6.8L 414 OHV Turbo-Diesel L6 4.1875" Bore (Standard).....	110
JD544 To Ser. No. 165808 ... Loader.....	5.0L 303 OHV Diesel L6 3.8594" Bore.....	73	JD700A ... Wheel Tractor.....	8.7L 531 OHV Diesel L6 4.75" Bore.....	122
JD544B ... Loader Tractor.....	6.8L 414 OHV Diesel L6 4.1875" Bore (Standard).....	109	JD740A ... Skidder.....	7.6L 466 OHV Turbo-Diesel L6 4.5625" Bore (Standard).....	114
JD544B ... Loader Tractor.....	6.8L 414 OHV Turbo-Diesel L6 4.1875" Bore (Standard).....	110	JD743 ... Wheel Tractor.....	7.6L 466 OHV Diesel L6 4.5625" Bore (Standard).....	113
JD544C ... Loader Tractor.....	6.8L 414 OHV Turbo-Diesel L6 4.1875" Bore (Standard).....	110	JD750 ... Crawler Tractor.....	6.8L 414 OHV Diesel L6 4.1875" Bore (Standard).....	109
JD544D ... Loader Tractor.....	6.8L 414 OHV Turbo-Diesel L6 4.1875" Bore (Standard).....	110	JD750 ... Crawler Tractor.....	6.8L 414 OHV Turbo-Diesel L6 4.1875" Bore (Standard).....	110
JD555 ... Loader Tractor.....	4.5L 276 OHV Turbo-Diesel L4 4.1875" Bore (Standard).....	68	JD750B ... Crawler Tractor.....	6.8L 414 OHV Turbo-Diesel L6 4.1875" Bore (Standard).....	110
JD570 ... Grader.....	5.0L 303 OHV Diesel L6 3.8594" Bore.....	73	JD755 ... Crawler Tractor.....	6.8L 414 OHV Diesel L6 4.1875" Bore (Standard).....	109
JD570 ... Wheel Tractor.....	5.4L 329 OHV Diesel L6 4.0156" Bore.....	78	JD755A ... Loader Tractor.....	6.8L 414 OHV Turbo-Diesel L6 4.1875" Bore (Standard).....	110
JD570A ... Wheel Tractor.....	5.4L 329 OHV Diesel L6 4.0156" Bore.....	78	JD760 ... Scraper.....	8.7L 531 OHV Diesel L6 4.75" Bore.....	122
JD600 ... Wheel Tractor.....	5.6L 340 OHV L6 4.25" Bore.....	81	JD760A ... Scraper.....	8.7L 531 OHV Diesel L6 4.75" Bore.....	122
JD600 ... Loader Tractor.....	5.6L 340 OHV L6 4.25" Bore.....	81	JD760A ... Wheel Tractor.....	8.7L 531 OHV Diesel L6 4.75" Bore.....	122
JD600 ... Loader Tractor.....	5.6L 340 OHV LPG L6 4.25" Bore.....	82	JD762A ... Scraper.....	7.6L 466 OHV Turbo-Diesel L6 4.5625" Bore (Standard).....	114
JD600 ... Wheel Tractor.....	5.9L 362 OHV L6 4.25" Bore.....	87	JD904A ... Wheel Tractor.....	6.6L 404 OHV Diesel L6 4.25" Bore (Early).....	95
JD600 ... Loader Tractor.....	5.9L 362 OHV L6 4.25" Bore.....	87	JD904A ... Wheel Tractor.....	6.6L 404 OHV Diesel L6 4.25" Bore (Late).....	96
JD600 ... Wheel Tractor.....	5.9L 362 OHV LPG L6 4.25" Bore.....	88	M ... Wheel Tractor.....	1.6L 100 OHV L2 4" Bore.....	3
JD600 ... Wheel Tractor.....	5.9L 362 OHV NG L6 4.25" Bore.....	89	MC ... Wheel Tractor.....	1.6L 100 OHV L2 4" Bore.....	3
JD600 ... Wheel Tractor.....	6.2L 381 OHV Diesel L6 4.125" Bore.....	94	MCT ... Wheel Tractor.....	1.6L 100 OHV L2 4" Bore.....	3
JD600 ... Wheel Tractor.....	6.6L 404 OHV Diesel L6 4.25" Bore (Early).....	95	MT ... Wheel Tractor.....	1.6L 100 OHV L2 4" Bore.....	3
JD600 ... Loader Tractor.....	6.6L 404 OHV Diesel L6 4.25" Bore (Early).....	95	NA ... Combine.....	3.6L 217 OHV L6 3.625" Bore.....	39
JD600 ... Wheel Tractor.....	6.6L 404 OHV Diesel L6 4.25" Bore (Late).....	96	No. 17 ... Combine.....	4.6L 282 L-HEAD L6 3.75" Bore (Hercules Eng.).....	69
JD600 ... Loader Tractor.....	6.6L 404 OHV Diesel L6 4.25" Bore (Late).....	96	No. 33 ... Combine.....	2.2L 133 L-HEAD L4 3.25" Bore (Hercules Eng.).....	9
JD640 ... Skidder.....	6.8L 414 OHV Diesel L6 4.1875" Bore (Standard).....	109	No. 35 Hillside ... Combine.....	3.6L 222 L-HEAD L6 3.375" Bore (Hercules Eng.).....	43
JD640 ... Loader Tractor.....	6.8L 414 OHV Turbo-Diesel L6 4.1875" Bore (Standard).....	110	No. 35 Hillside ... Combine.....	3.7L 226 OHV L4 4" Bore (Hercules Eng.).....	45
JD640 ... Skidder.....	6.8L 414 OHV Turbo-Diesel L6 4.1875" Bore (Standard).....	110			
JD640D ... Skidder.....	6.8L 414 OHV Turbo-Diesel L6 4.1875" Bore (Standard).....	110			

(continued on next page)

Model Index					
Model	Engine Description	Line No.	Model	Engine Description	Line No.
No. 36 ... Combine.....	4.6L 282 L-HEAD L6 3.75" Bore (Hercules Eng.).....	69	1010D ... Forestry Tractor .....	4.5L 275.8 (4522cc) OHV Turbo-Diesel L4 106mm Bore (PowerTech 2V IC).....	61
No. 36A ... Combine .....	4.6L 282 L-HEAD L6 3.75" Bore (Hercules Eng.).....	69	1010D ... Forestry Tractor .....	4.5L 275.8 (4522cc) OHV Turbo-Diesel L4 106mm Bore (PowerTech 2V).....	66
No. 36B ... Combine .....	4.6L 282 L-HEAD L6 3.75" Bore (Hercules Eng.).....	69	1020 ... Wheel Tractor.....	2.2L 135 OHV L3 3.8594" Bore.....	10
No. 36H ... Combine.....	4.6L 282 L-HEAD L6 3.75" Bore (Hercules Eng.).....	69	1020 ... Wheel Tractor.....	2.5L 152 OHV Diesel L3 3.8594" Bore.....	18
No. 36P ... Combine .....	4.6L 282 L-HEAD L6 3.75" Bore (Hercules Eng.).....	69	1030 ... Wheel Tractor.....	2.7L 164 OHV Diesel L3 4.0156" Bore.....	23
No. 38 Hillside ... Combine .....	1.9L 113 L-HEAD L4 3" Bore (Hercules Eng.).....	6	1040 ... Wheel Tractor.....	2.9L 179 OHV Diesel L3 4.1875" Bore (Standard).....	27
No. 38 Hillside ... Combine .....	2.2L 133 L-HEAD L4 3.25" Bore (Hercules Eng.).....	9	105 ... Combine .....	4.9L 302 OHV L6 4" Bore.....	71
No. 5A ... Combine .....	3.6L 222 L-HEAD L6 3.375" Bore (Hercules Eng.).....	43	105 ... Combine .....	5.6L 340 OHV L6 4.25" Bore.....	81
No. 5A ... Combine .....	3.7L 226 OHV L4 4" Bore (Hercules Eng.).....	45	105 ... Combine .....	5.9L 362 OHV L6 4.25" Bore.....	87
No. 6 ... Combine.....	1.9L 113 L-HEAD L4 3" Bore (Hercules Eng.).....	6	105 ... Combine .....	6.6L 404 OHV Diesel L6 4.25" Bore (Early).....	95
No. 7 ... Combine.....	1.9L 113 L-HEAD L4 3" Bore (Hercules Eng.).....	6	105 ... Combine .....	6.6L 404 OHV Diesel L6 4.25" Bore (Late).....	96
No. 7 ... Combine.....	2.2L 133 L-HEAD L4 3.25" Bore (Hercules Eng.).....	9	105R ... Combine.....	6.6L 404 OHV Diesel L6 4.25" Bore (Early).....	95
No. 7 Prairie ... Combine .....	2.2L 133 L-HEAD L4 3.25" Bore (Hercules Eng.).....	9	105R ... Combine.....	6.6L 404 OHV Diesel L6 4.25" Bore (Late).....	96
No. 7 Prairie ... Combine .....	1.9L 113 L-HEAD L4 3" Bore (Hercules Eng.).....	6	1070D ... Forestry Tractor .....	6.8L 413.8 (6784cc) OHV Turbo-Diesel L6 106mm Bore (PowerTech 2V IC).....	102
No. 8 ... Combine.....	2.7L 162 L-HEAD L4 3.4375" Bore (Continental Eng.).....	21	1070D ... Harvester .....	6.8L 413.8 (6784cc) OHV Turbo-Diesel L6 106mm Bore (PowerTech 4V IC).....	103
No. 8 ... Harvester .....	2.7L 162 L-HEAD L4 3.4375" Bore (Continental Eng.).....	21	1070D ... Forestry Tractor .....	6.8L 413.8 (6784cc) OHV Turbo-Diesel L6 106mm Bore (PowerTech 2V).....	108
No. 9 Prairie ... Combine .....	3.6L 222 L-HEAD L6 3.375" Bore (Hercules Eng.).....	43	110 ... Excavator.....	4.5L 275.8 (4522cc) OHV Turbo-Diesel L4 106mm Bore (PowerTech 2V IC).....	61
TA ... Combine.....	3.6L 217 OHV L6 3.625" Bore.....	39	110 ... Excavator.....	4.5L 275.8 (4522cc) OHV Turbo-Diesel L4 106mm Bore (PowerTech 2V).....	66
TC44H ... Integrated Tool Carrier.....	4.5L 275.8 (4522cc) OHV Turbo-Diesel L4 106mm Bore (PowerTech 2V IC).....	61	1110D ... Forestry Tractor .....	6.8L 413.8 (6784cc) OHV Turbo-Diesel L6 106mm Bore (PowerTech 2V IC).....	102
TC44H ... Integrated Tool Carrier.....	4.5L 275.8 (4522cc) OHV Turbo-Diesel L4 106mm Bore (PowerTech 2V).....	66	1110D ... Forestry Tractor .....	6.8L 413.8 (6784cc) OHV Turbo-Diesel L6 106mm Bore (PowerTech 2V).....	108
TC54H ... Integrated Tool Carrier.....	6.8L 413.8 (6784cc) OHV Turbo-Diesel L6 106mm Bore (PowerTech 2V IC).....	102	1130 ... Wheel Tractor.....	2.7L 164 OHV Diesel L3 4.0156" Bore.....	23
TC54H ... Integrated Tool Carrier.....	6.8L 413.8 (6784cc) OHV Turbo-Diesel L6 106mm Bore (PowerTech 2V).....	108	114W ... Hay Baler .....	1.8L 108 L-HEAD V4 3.25" Bore (Wisconsin Eng.) .....	5
TC62H ... Integrated Tool Carrier.....	6.8L 413.8 (6784cc) OHV Turbo-Diesel L6 106mm Bore (PowerTech 2V IC).....	102	1140 ... Wheel Tractor.....	2.9L 179 OHV Diesel L3 4.1875" Bore (Standard).....	27
TC62H ... Integrated Tool Carrier.....	6.8L 413.8 (6784cc) OHV Turbo-Diesel L6 106mm Bore (PowerTech 2V).....	108	115 ... Combine .....	2.7L 165 OHV L4 3.875" Bore.....	24
10 ... Hay Baler.....	2.5L 154 L-HEAD V4 3.5" Bore (Wisconsin Eng.) .....	19	115G ... Power Unit .....	1.9L 115 OHV L4 3.5" Bore.....	8
10 Ft. ... Windrower .....	1.8L 108 L-HEAD V4 3.25" Bore (Wisconsin Eng.) .....	5	115G ... Power Unit .....	2.4L 145 OHV L4 3.625" Bore.....	13
1010 ... Wheel Tractor.....	1.9L 115 OHV L4 3.5" Bore.....	8	116W ... Hay Baler .....	1.8L 108 L-HEAD V4 3.25" Bore (Wisconsin Eng.) .....	5
1010 ... Wheel Tractor.....	2.4L 145 OHV Diesel L4 3.625" Bore.....	15	1165 ... Combine .....	6.8L 413.8 (6784cc) OHV Turbo-Diesel L6 106mm Bore (PowerTech 2V IC).....	102
1010 ... Wheel Tractor.....	2.5L 155 OHV Diesel L4 3.75" Bore.....	20	1165 ... Combine .....	6.8L 413.8 (6784cc) OHV Turbo-Diesel L6 106mm Bore (PowerTech 2V).....	108
1010C ... Crawler Tractor .....	1.9L 115 OHV L4 3.5" Bore.....	8	1170 ... Combine .....	6.8L 413.8 (6784cc) OHV Turbo-Diesel L6 106mm Bore (PowerTech 2V IC).....	102
1010C ... Crawler Tractor .....	2.4L 145 OHV Diesel L4 3.625" Bore.....	15	1170 ... Combine .....	6.8L 413.8 (6784cc) OHV Turbo-Diesel L6 106mm Bore (PowerTech 2V).....	108
			1175 ... Combine .....	6.8L 413.8 (6784cc) OHV Turbo-Diesel L6 106mm Bore (PowerTech 2V IC).....	102

(continued on next page)



Model Index					
Model	Engine Description	Line No.	Model	Engine Description	Line No.
1175 ... Combine	6.8L 413.8 (6784cc) OHV Turbo-Diesel L6 106mm Bore (PowerTech 2V)	108	1530 ... Wheel Tractor	2.7L 164 OHV Diesel L3 4.0156" Bore	23
1175H ... Combine	6.8L 413.8 (6784cc) OHV Turbo-Diesel L6 106mm Bore (PowerTech 2V IC)	102	155D ... Power Unit	2.5L 155 OHV Diesel L4 3.75" Bore	20
1175H ... Combine	6.8L 413.8 (6784cc) OHV Turbo-Diesel L6 106mm Bore (PowerTech 2V)	108	155D ... Power Unit	2.7L 165 OHV Diesel L4 3.875" Bore	25
12 ... Harvester	3.6L 217 OHV L6 3.625" Bore	39	1550 ... Combine	6.8L 413.8 (6784cc) OHV Turbo-Diesel L6 106mm Bore (PowerTech 2V IC)	102
12 Ft ... Windrower	1.8L 108 L-HEAD V4 3.25" Bore (Wisconsin Eng.)	5	1550 ... Combine	6.8L 413.8 (6784cc) OHV Turbo-Diesel L6 106mm Bore (PowerTech 2V)	108
120 ... Excavator	4.5L 275.8 (4522cc) OHV Turbo-Diesel L4 106mm Bore (PowerTech 2V IC)	61	16 Ft ... Windrower	1.8L 108 L-HEAD V4 3.25" Bore (Wisconsin Eng.)	5
120 ... Excavator	4.5L 275.8 (4522cc) OHV Turbo-Diesel L4 106mm Bore (PowerTech 2V)	66	160CLC ... Excavator	4.5L 275.8 (4522cc) OHV Turbo-Diesel L4 106mm Bore (PowerTech 2V IC)	61
120C ... Excavator	4.5L 275.8 (4522cc) OHV Turbo-Diesel L4 106mm Bore (PowerTech 2V IC)	61	160CLC ... Excavator	4.5L 275.8 (4522cc) OHV Turbo-Diesel L4 106mm Bore (PowerTech 2V)	66
120C ... Excavator	4.5L 275.8 (4522cc) OHV Turbo-Diesel L4 106mm Bore (PowerTech 2V)	66	160LC ... Excavator	4.5L 275.8 (4522cc) OHV Turbo-Diesel L4 106mm Bore (PowerTech 2V IC)	61
1270D ... Harvester	8.1L 495.9 (8129cc) OHV Turbo-Diesel L6 116mm Bore (PowerTech 2V IC)	118	160LC ... Excavator	4.5L 275.8 (4522cc) OHV Turbo-Diesel L4 106mm Bore (PowerTech 2V)	66
1270D ... Harvester	8.1L 495.9 (8129cc) OHV Turbo-Diesel L6 116mm Bore (PowerTech 2V AC)	119	1630 ... Wheel Tractor	2.9L 179 OHV Diesel L3 4.1875" Bore (Standard)	27
1270D ... Harvester	8.1L 495.9 (8129cc) OHV Turbo-Diesel L6 116mm Bore (PowerTech 2V)	121	164D ... Power Unit	2.7L 164 OHV Diesel L3 4.0156" Bore	23
135G ... Power Unit	2.2L 135 OHV L3 3.8594" Bore	10	1640 ... Wheel Tractor	3.9L 239 OHV Diesel L4 4.1875" Bore (Standard)	50
14 Ft ... Windrower	1.8L 108 L-HEAD V4 3.25" Bore (Wisconsin Eng.)	5	165D ... Power Unit	2.7L 165 OHV Diesel L4 3.875" Bore	25
1410D ... Forestry Tractor	6.8L 413.8 (6784cc) OHV Turbo-Diesel L6 106mm Bore (PowerTech 2V IC)	102	165G ... Power Unit	2.4L 145 OHV L4 3.625" Bore	13
1410D ... Forestry Tractor	6.8L 413.8 (6784cc) OHV Turbo-Diesel L6 106mm Bore (PowerTech 2V)	108	165G ... Power Unit	2.4L 145 OHV L4 3.625" Bore (Late)	14
145G ... Power Unit	2.4L 145 OHV L4 3.625" Bore	13	165G ... Power Unit	2.7L 165 OHV L4 3.875" Bore	24
145G ... Power Unit	2.4L 145 OHV L4 3.625" Bore (Late)	14	1710D ... Forestry Tractor	8.1L 495.9 (8129cc) OHV Turbo-Diesel L6 116mm Bore (PowerTech 2V IC)	118
1450 ... Combine	6.8L 413.8 (6784cc) OHV Turbo-Diesel L6 106mm Bore (PowerTech 2V IC)	102	1710D ... Forestry Tractor	8.1L 495.9 (8129cc) OHV Turbo-Diesel L6 116mm Bore (PowerTech 2V AC)	119
1450 ... Combine	6.8L 413.8 (6784cc) OHV Turbo-Diesel L6 106mm Bore (PowerTech 2V)	108	1710D ... Forestry Tractor	8.1L 495.9 (8129cc) OHV Turbo-Diesel L6 116mm Bore (PowerTech 2V)	121
1470D ... Harvester	8.1L 495.9 (8129cc) OHV Turbo-Diesel L6 116mm Bore (PowerTech 2V IC)	118	180G ... Power Unit	2.9L 180 OHV L4 3.8594" Bore	31
1470D ... Harvester	8.1L 495.9 (8129cc) OHV Turbo-Diesel L6 116mm Bore (PowerTech 2V AC)	119	1830 ... Wheel Tractor	3.6L 219 OHV Diesel L4 4.0156" Bore	41
1470D ... Harvester	8.1L 495.9 (8129cc) OHV Turbo-Diesel L6 116mm Bore (PowerTech 2V)	121	1830 ... Wheel Tractor	3.6L 219 OHV Turbo-Diesel L4 4.0156" Bore	42
1490D ... Forestry Tractor	6.8L 413.8 (6784cc) OHV Turbo-Diesel L6 106mm Bore (PowerTech 2V IC)	102	1840 ... Wheel Tractor	3.9L 239 OHV Diesel L4 4.1875" Bore (Standard)	50
1490D ... Forestry Tractor	6.8L 413.8 (6784cc) OHV Turbo-Diesel L6 106mm Bore (PowerTech 2V)	108	190E ... Excavator	3.9L 239 (3917cc) OHV Diesel L4 106mm Bore (Litre Engine)	52
152D ... Power Unit	2.5L 152 OHV Diesel L3 3.8594" Bore	18	200 ... Windrower	1.8L 108 L-HEAD V4 3.25" Bore (Wisconsin Eng.)	5
1520 ... Wheel Tractor	2.5L 152 OHV L3 3.8594" Bore	17	200CLC ... Excavator	6.8L 413.8 (6784cc) OHV Turbo-Diesel L6 106mm Bore (PowerTech 2V IC)	102
1520 ... Wheel Tractor	2.7L 164 OHV Diesel L3 4.0156" Bore	23	200CLC ... Excavator	6.8L 413.8 (6784cc) OHV Turbo-Diesel L6 106mm Bore (PowerTech 2V)	108
1530 ... Wheel Tractor	2.5L 152 OHV Diesel L3 3.8594" Bore	18	200LC ... Excavator	6.8L 413.8 (6784cc) OHV Turbo-Diesel L6 106mm Bore (PowerTech 2V IC)	102
			200LC ... Excavator	6.8L 413.8 (6784cc) OHV Turbo-Diesel L6 106mm Bore (PowerTech 2V)	108
			2010 ... Wheel Tractor	2.4L 145 OHV L4 3.625" Bore	13
			2010 ... Wheel Tractor	2.4L 145 OHV L4 3.625" Bore (Late)	14

(continued on next page)

Model Index					
Model	Engine Description	Line No.	Model	Engine Description	Line No.
2010 ... Wheel Tractor	2.7L 165 OHV Diesel L4 3.875" Bore	25	2280 ... Wheel Tractor	3.6L 219 OHV Diesel L4 4.0156" Bore	41
202D ... Power Unit	3.3L 202 OHV Diesel L4 3.8594" Bore	38	230CLC ... Excavator	6.8L 413.8 (6784cc) OHV Turbo-Diesel L6 106mm Bore (PowerTech 2V IC)	102
202G ... Power Unit	3.3L 202 OHV L4 3.8594" Bore	37	230CLC ... Excavator	6.8L 413.8 (6784cc) OHV Turbo-Diesel L6 106mm Bore (PowerTech 2V)	108
2020 ... Wheel Tractor	2.9L 180 OHV L4 3.8594" Bore	31	230LC ... Excavator	6.8L 413.8 (6784cc) OHV Turbo-Diesel L6 106mm Bore (PowerTech 2V IC)	102
2020 ... Wheel Tractor	3.3L 202 OHV L4 3.8594" Bore	37	230LC ... Excavator	6.8L 413.8 (6784cc) OHV Turbo-Diesel L6 106mm Bore (PowerTech 2V)	108
2020 ... Wheel Tractor	3.3L 202 OHV Diesel L4 3.8594" Bore	38	230LCR ... Excavator	6.8L 413.8 (6784cc) OHV Turbo-Diesel L6 106mm Bore (PowerTech 2V IC)	102
2020 ... Wheel Tractor	3.6L 219 OHV Diesel L4 4.0156" Bore	41	230LCR ... Excavator	6.8L 413.8 (6784cc) OHV Turbo-Diesel L6 106mm Bore (PowerTech 2V)	108
2030 ... Wheel Tractor	2.9L 180 OHV L4 3.8594" Bore	31	230LCRD ... Excavator	4.5L 275.8 (4522cc) OHV Turbo-Diesel L4 106mm Bore (PowerTech 2V)	66
2030 ... Wheel Tractor	3.6L 219 OHV L4 4.0156" Bore	40	230LCRD ... Excavator	6.8L 413.8 (6784cc) OHV Turbo-Diesel L6 106mm Bore (PowerTech 2V IC)	102
2030 ... Wheel Tractor	3.6L 219 OHV Diesel L4 4.0156" Bore	41	230LCRD ... Excavator	6.8L 413.8 (6784cc) OHV Turbo-Diesel L6 106mm Bore (PowerTech 2V)	108
2040 ... Wheel Tractor	2.7L 164 OHV Diesel L3 4.0156" Bore	23	2320 ... Windrower	3.7L 225 OHV L6 3.4063" Bore (Chrysler Eng.)	44
2040 ... Wheel Tractor	2.9L 179 OHV Diesel L3 4.1875" Bore (Standard)	27	2350 ... Wheel Tractor	3.9L 239 OHV Diesel L4 4.1875" Bore (Standard)	50
2040 ... Wheel Tractor	2.9L 179 OHV Turbo-Diesel L3 4.1875" Bore (Standard)	28	2355 ... Wheel Tractor	3.9L 239 OHV Diesel L4 4.1875" Bore (Standard)	50
2040 ... Wheel Tractor	3.9L 239 OHV Diesel L4 4.1875" Bore (Standard)	50	2355N ... Wheel Tractor	2.9L 179 OHV Turbo-Diesel L3 4.1875" Bore (Standard)	28
2040S ... Wheel Tractor	3.9L 239 OHV Diesel L4 4.1875" Bore (Standard)	50	2360 ... Windrower	3.9L 239 OHV Diesel L4 4.1875" Bore (Standard)	50
2054 ... Forestry Tractor	6.8L 413.8 (6784cc) OHV Turbo-Diesel L6 106mm Bore (PowerTech 2V IC)	102	240 ... Track Loader	2.9L 179.2 (2938cc) OHV Diesel L3 106mm Bore (PowerTech 2V)	29
2054 ... Forestry Tractor	6.8L 413.8 (6784cc) OHV Turbo-Diesel L6 106mm Bore (PowerTech 2V)	108	240-II ... Track Loader	2.9L 179.2 (2938cc) OHV Diesel L3 106mm Bore (PowerTech 2V)	29
210C ... Backhoe	3.6L 219 OHV Diesel L4 4.0156" Bore	41	240DLC ... Excavator	6.8L 413.8 (6784cc) OHV Turbo-Diesel L6 106mm Bore (PowerTech 4V IC)	103
210C ... Backhoe	3.9L 239 (3917cc) OHV Diesel L4 106mm Bore (Litre Engine)	52	2420 ... Windrower	3.6L 219 OHV Diesel L4 4.0156" Bore	41
210LE ... Loader Tractor	4.5L 275.8 (4522cc) OHV Diesel L4 106mm Bore (PowerTech 2V)	64	2420 ... Windrower	3.7L 225 OHV L6 3.4063" Bore (Chrysler Eng.)	44
210LE ... Loader Tractor	4.5L 275.8 (4522cc) OHV Turbo-Diesel L4 106mm Bore (PowerTech 2V)	66	2440 ... Wheel Tractor	3.6L 219 OHV Diesel L4 4.0156" Bore	41
2130 ... Wheel Tractor	3.9L 239 OHV Diesel L4 4.1875" Bore (Standard)	50	250 ... Track Loader	2.9L 179.2 (2938cc) OHV Turbo-Diesel L3 106mm Bore (PowerTech 2V)	30
2130 ... Wheel Tractor	3.9L 239 OHV Turbo-Diesel L4 4.1875" Bore (Standard)	51	250-II ... Track Loader	2.9L 179.2 (2938cc) OHV Turbo-Diesel L3 106mm Bore (PowerTech 2V)	30
214T ... Power Unit	1.8L 108 L-HEAD V4 3.25" Bore (Wisconsin Eng.)	5	250D ... Off-Highway Truck	8.1L 495.9 (8129cc) OHV Turbo-Diesel L6 116mm Bore (PowerTech 2V IC)	118
214W ... Power Unit	1.8L 108 L-HEAD V4 3.25" Bore (Wisconsin Eng.)	5	250D ... Off-Highway Truck	8.1L 495.9 (8129cc) OHV Turbo-Diesel L6 116mm Bore (PowerTech 2V AC)	119
2140 ... Wheel Tractor	3.9L 239 OHV Turbo-Diesel L4 4.1875" Bore (Standard)	51	2510 ... Wheel Tractor	2.9L 180 OHV L4 3.8594" Bore	31
215 ... Windrower	1.9L 115 OHV L4 3.5" Bore	8	2510 ... Wheel Tractor	3.3L 202 OHV Diesel L4 3.8594" Bore	38
2150 ... Wheel Tractor	2.9L 179 OHV Diesel L3 4.1875" Bore (Standard)	27	2510 ... Wheel Tractor	3.6L 219 OHV Diesel L4 4.0156" Bore	41
216T ... Power Unit	1.8L 108 L-HEAD V4 3.25" Bore (Wisconsin Eng.)	5	2520 ... Wheel Tractor	2.9L 180 OHV L4 3.8594" Bore	31
216WS ... Power Unit	1.8L 108 L-HEAD V4 3.25" Bore (Wisconsin Eng.)	5	2520 ... Wheel Tractor	3.3L 202 OHV L4 3.8594" Bore	37
217G ... Power Unit	3.6L 217 OHV L6 3.625" Bore	39	2520 ... Wheel Tractor	3.6L 219 OHV Diesel L4 4.0156" Bore	41
224T ... Power Unit	1.8L 108 L-HEAD V4 3.25" Bore (Wisconsin Eng.)	5			
224WS ... Power Unit	1.8L 108 L-HEAD V4 3.25" Bore (Wisconsin Eng.)	5			
2240 ... Wheel Tractor	2.9L 179 OHV Diesel L3 4.1875" Bore (Standard)	27			
2240 ... Wheel Tractor	2.9L 179 OHV Turbo-Diesel L3 4.1875" Bore (Standard)	28			
2255 ... Wheel Tractor	2.9L 179 OHV Diesel L3 4.1875" Bore (Standard)	27			
2270 ... Windrower	3.6L 219 OHV Diesel L4 4.0156" Bore	41			
2280 ... Wheel Tractor	3.6L 219 OHV Diesel L4 4.0156" Bore	41			





# John Deere Off Highway

Model Index					
Model	Engine Description	Line No.	Model	Engine Description	Line No.
254D ... Power Unit	4.2L 254 OHV Diesel L4 4.125" Bore	59	300D ... Off-Highway Truck	8.1L 495.9 (8129cc) OHV Turbo-Diesel L6 116mm Bore (PowerTech 2V IC)	118
2550 ... Wheel Tractor	3.9L 239 OHV Diesel L4 4.1875" Bore (Standard)	50	300D ... Off-Highway Truck	8.1L 495.9 (8129cc) OHV Turbo-Diesel L6 116mm Bore (PowerTech 2V AC)	119
2554 ... Forestry Tractor	6.8L 413.8 (6784cc) OHV Turbo-Diesel L6 106mm Bore (PowerTech 2V IC)	102	301 ... Wheel Tractor	2.5L 152 OHV Diesel L3 3.8594" Bore	18
2554 ... Forestry Tractor	6.8L 413.8 (6784cc) OHV Turbo-Diesel L6 106mm Bore (PowerTech 2V)	108	301A ... Loader	2.2L 135 OHV L3 3.8594" Bore	10
2555 ... Wheel Tractor	3.9L 239 OHV Diesel L4 4.1875" Bore (Standard)	50	301A ... Loader	2.5L 152 OHV L3 3.8594" Bore	17
2555 ... Wheel Tractor	3.9L 239 OHV Turbo-Diesel L4 4.1875" Bore (Standard)	51	301A ... Loader	2.5L 152 OHV Diesel L3 3.8594" Bore	18
260 ... Track Loader	2.9L 179.2 (2938cc) OHV Turbo-Diesel L3 106mm Bore (PowerTech 2V)	30	301A ... Wheel Tractor	2.5L 152 OHV Diesel L3 3.8594" Bore	18
260-II ... Track Loader	2.9L 179.2 (2938cc) OHV Turbo-Diesel L3 106mm Bore (PowerTech 2V)	30	301A ... Wheel Tractor	2.7L 164 OHV Diesel L3 4.0156" Bore	23
2630 ... Wheel Tractor	4.5L 276 OHV Diesel L4 4.1875" Bore (Standard)	67	301AA ... Wheel Tractor	2.5L 152 OHV Diesel L3 3.8594" Bore	18
2640 ... Wheel Tractor	4.5L 276 OHV Diesel L4 4.1875" Bore (Standard)	67	3010 ... Wheel Tractor	3.3L 201 OHV L4 4" Bore	36
270 ... Track Loader	4.5L 275.8 (4522cc) OHV Diesel L4 106mm Bore (PowerTech 2V)	64	3010 ... Wheel Tractor	4.2L 254 OHV Diesel L4 4.125" Bore	59
270CLC ... Excavator	6.8L 413.8 (6784cc) OHV Turbo-Diesel L6 106mm Bore (PowerTech 2V IC)	102	302 ... Wheel Tractor	2.7L 164 OHV Diesel L3 4.0156" Bore	23
270CLC ... Excavator	6.8L 413.8 (6784cc) OHV Turbo-Diesel L6 106mm Bore (PowerTech 2V)	108	302A ... Wheel Tractor	2.7L 164 OHV Diesel L3 4.0156" Bore	23
270DLC ... Excavator	6.8L 413.8 (6784cc) OHV Turbo-Diesel L6 106mm Bore (PowerTech 4V IC)	103	3020 ... Wheel Tractor	3.3L 201 OHV L4 4" Bore	36
270LC ... Excavator	6.8L 413.8 (6784cc) OHV Turbo-Diesel L6 106mm Bore (PowerTech 2V IC)	102	3020 ... Wheel Tractor	3.7L 227 OHV L4 4.25" Bore	46
270LC ... Excavator	6.8L 413.8 (6784cc) OHV Turbo-Diesel L6 106mm Bore (PowerTech 2V)	108	3020 ... Wheel Tractor	3.7L 227 OHV LPG L4 4.25" Bore	47
2750 ... Wheel Tractor	3.9L 239 OHV Turbo-Diesel L4 4.1875" Bore (Standard)	51	3020 ... Wheel Tractor	3.9L 241 OHV L4 4.25" Bore	54
2755 ... Wheel Tractor	3.9L 239 OHV Turbo-Diesel L4 4.1875" Bore (Standard)	51	3020 ... Wheel Tractor	3.9L 241 OHV LPG L4 4.25" Bore	55
280 ... Track Loader	4.5L 275.8 (4522cc) OHV Diesel L4 106mm Bore (PowerTech 2V)	64	3020 ... Wheel Tractor	3.9L 241 OHV NG L4 4.25" Bore	56
2840 ... Wheel Tractor	5.4L 329 OHV Diesel L6 4.0156" Bore	78	3020 ... Wheel Tractor	4.4L 270 OHV Diesel L4 4.25" Bore	60
2855N ... Wheel Tractor	3.9L 239 OHV Turbo-Diesel L4 4.1875" Bore (Standard)	51	3029DF120 ... Power Unit	2.9L 179.2 (2938cc) OHV Diesel L3 106mm Bore (PowerTech 2V)	29
290D ... Excavator	3.9L 239 OHV Diesel L4 4.1875" Bore (Standard)	50	3029DF128 ... Power Unit	2.9L 179.2 (2938cc) OHV Diesel L3 106mm Bore (PowerTech 2V)	29
2940 ... Wheel Tractor	5.9L 359 OHV Diesel L6 4.1875" Bore	85	3029DF150 ... Power Unit	2.9L 179.2 (2938cc) OHV Diesel L3 106mm Bore (PowerTech 2V)	29
2940 ... Wheel Tractor	5.9L 359 OHV Turbo-Diesel L6 4.1875" Bore	86	3029DF151 ... Power Unit	2.9L 179.2 (2938cc) OHV Diesel L3 106mm Bore (PowerTech 2V)	29
2950 ... Wheel Tractor	5.9L 359 OHV Diesel L6 4.1875" Bore	85	3029DF152 ... Power Unit	2.9L 179.2 (2938cc) OHV Diesel L3 106mm Bore (PowerTech 2V)	29
2955 ... Wheel Tractor	5.9L 359 OHV Diesel L6 4.1875" Bore	85	3029DF160 ... Power Unit	2.9L 179.2 (2938cc) OHV Diesel L3 106mm Bore (PowerTech 2V)	29
300 ... Wheel Tractor	2.5L 152 OHV Diesel L3 3.8594" Bore	18	3029DF180 ... Power Unit	2.9L 179.2 (2938cc) OHV Diesel L3 106mm Bore (PowerTech 2V)	29
300B ... Loader	2.2L 135 OHV L3 3.8594" Bore	10	3029TF120 ... Power Unit	2.9L 179.2 (2938cc) OHV Turbo-Diesel L3 106mm Bore (PowerTech 2V)	30
300B ... Loader	2.5L 152 OHV L3 3.8594" Bore	17	3029TF150 ... Power Unit	2.9L 179.2 (2938cc) OHV Turbo-Diesel L3 106mm Bore (PowerTech 2V)	30
300B ... Loader	2.5L 152 OHV Diesel L3 3.8594" Bore	18	3029TF152 ... Power Unit	2.9L 179.2 (2938cc) OHV Turbo-Diesel L3 106mm Bore (PowerTech 2V)	30
300B ... Wheel Tractor	2.5L 152 OHV Diesel L3 3.8594" Bore	18	3029TF158 ... Power Unit	2.9L 179.2 (2938cc) OHV Turbo-Diesel L3 106mm Bore (PowerTech 2V)	30
300B ... Wheel Tractor	2.7L 164 OHV Diesel L3 4.0156" Bore	23	3029TF160 ... Power Unit	2.9L 179.2 (2938cc) OHV Turbo-Diesel L3 106mm Bore (PowerTech 2V)	30
			3029TF180 ... Power Unit	2.9L 179.2 (2938cc) OHV Turbo-Diesel L3 106mm Bore (PowerTech 2V)	30
			3029TF270 ... Power Unit	2.9L 179.2 (2938cc) OHV Turbo-Diesel L3 106mm Bore (PowerTech 2V)	30
			303D ... Power Unit	5.0L 303 OHV Diesel L6 3.8594" Bore	73
			303G ... Power Unit	5.0L 303 OHV L6 3.8594" Bore	72

(continued on next page)

Model Index					
Model	Engine Description	Line No.	Model	Engine Description	Line No.
303G ... Power Unit	5.0L 303 OHV LPG L6 3.8594" Bore	74	3200 ... Telehandler	4.5L 275.8 (4522cc) OHV Turbo-Diesel L4 106mm Bore (PowerTech 2V)	66
303L ... Power Unit	5.0L 303 OHV L6 3.8594" Bore	72	3215 ... Telehandler	4.5L 275.8 (4522cc) OHV Turbo-Diesel L4 106mm Bore (PowerTech 2V IC)	61
303L ... Power Unit	5.0L 303 OHV LPG L6 3.8594" Bore	74	3215 ... Telehandler	4.5L 275.8 (4522cc) OHV Turbo-Diesel L4 106mm Bore (PowerTech 2V)	66
310 ... Backhoe	2.7L 164 OHV Diesel L3 4.0156" Bore	23	3220 ... Telehandler	4.5L 275.8 (4522cc) OHV Turbo-Diesel L4 106mm Bore (PowerTech 2V IC)	61
310A ... Loader	3.3L 202 OHV Diesel L4 3.8594" Bore	38	3220 ... Telehandler	4.5L 275.8 (4522cc) OHV Turbo-Diesel L4 106mm Bore (PowerTech 2V)	66
310A ... Loader	3.6L 219 OHV Diesel L4 4.0156" Bore	41	3220 ... Telehandler	4.5L 275.8 (4522cc) OHV Turbo-Diesel L4 106mm Bore (PowerTech 2V IC)	61
310A ... Backhoe	3.6L 219 OHV Diesel L4 4.0156" Bore	41	3220 ... Telehandler	4.5L 275.8 (4522cc) OHV Turbo-Diesel L4 106mm Bore (PowerTech 2V)	66
310B ... Backhoe	3.6L 219 OHV Diesel L4 4.0156" Bore	41	324H ... Loader Tractor	4.5L 275.8 (4522cc) OHV Diesel L4 106mm Bore (PowerTech 2V)	64
310C ... Backhoe	3.9L 239 OHV Diesel L4 4.1875" Bore (Standard)	50	329 ... Power Unit	5.4L 329 OHV L6 4.0156" Bore	77
310C ... Backhoe	3.9L 239 OHV Turbo-Diesel L4 4.1875" Bore (Standard)	51	329 ... Power Unit	5.4L 329 OHV LPG L6 4.0156" Bore	79
310D ... Backhoe	3.9L 239 OHV Diesel L4 4.1875" Bore (Standard)	50	329D ... Power Unit	5.4L 329 OHV Diesel L6 4.0156" Bore	78
310D ... Backhoe	3.9L 239 OHV Turbo-Diesel L4 4.1875" Bore (Standard)	51	329G ... Power Unit	5.4L 329 OHV L6 4.0156" Bore	77
310D ... Backhoe	3.9L 239 (3917cc) OHV Turbo-Diesel L4 106mm Bore (Litre Engine)	53	329G ... Power Unit	5.4L 329 OHV LPG L6 4.0156" Bore	79
310E ... Backhoe	4.5L 275.8 (4522cc) OHV Diesel L4 106mm Bore (PowerTech 2V)	64	33 ... Combine	2.2L 133 L-HEAD L4 3.25" Bore (Hercules Eng.)	9
310E ... Backhoe	4.5L 275.8 (4522cc) OHV Turbo-Diesel L4 106mm Bore (PowerTech 2V)	66	330 ... Wheel Tractor	1.6L 100 OHV L2 4" Bore	3
310G ... Backhoe	4.5L 275.8 (4522cc) OHV Diesel L4 106mm Bore (PowerTech 2V)	64	330B ... Forestry Tractor	6.8L 413.8 (6784cc) OHV Turbo-Diesel L6 106mm Bore (PowerTech 2V IC)	102
310G ... Backhoe	4.5L 275.8 (4522cc) OHV Turbo-Diesel L4 106mm Bore (PowerTech 2V)	66	330B ... Forestry Tractor	6.8L 413.8 (6784cc) OHV Turbo-Diesel L6 106mm Bore (PowerTech 2V)	108
310SE ... Backhoe	4.5L 275.8 (4522cc) OHV Turbo-Diesel L4 106mm Bore (PowerTech 2V)	66	330CLC ... Excavator	8.1L 495.9 (8129cc) OHV Turbo-Diesel L6 116mm Bore (PowerTech 2V IC)	118
310SG ... Backhoe	4.5L 275.8 (4522cc) OHV Turbo-Diesel L4 106mm Bore (PowerTech 2V)	66	330CLC ... Excavator	8.1L 495.9 (8129cc) OHV Turbo-Diesel L6 116mm Bore (PowerTech 2V AC)	119
3110 ... Wheel Tractor	2.9L 179.2 (2938cc) OHV Diesel L3 106mm Bore (PowerTech 2V)	29	330CLC ... Excavator	8.1L 495.9 (8129cc) OHV Turbo-Diesel L6 116mm Bore (PowerTech 2V)	121
3130 ... Wheel Tractor	5.4L 329 OHV Diesel L6 4.0156" Bore	78	330LC ... Excavator	8.1L 495.9 (8129cc) OHV Turbo-Diesel L6 116mm Bore (PowerTech 2V IC)	118
3130 ... Wheel Tractor	5.4L 329 OHV Turbo-Diesel L6 4.0156" Bore	80	330LC ... Excavator	8.1L 495.9 (8129cc) OHV Turbo-Diesel L6 116mm Bore (PowerTech 2V AC)	119
3135G ... Power Unit	2.2L 135 OHV L3 3.8594" Bore	10	330LC ... Excavator	8.1L 495.9 (8129cc) OHV Turbo-Diesel L6 116mm Bore (PowerTech 2V)	121
3140 ... Wheel Tractor	5.4L 329 OHV Diesel L6 4.0156" Bore	78	330LCR ... Excavator	8.1L 495.9 (8129cc) OHV Turbo-Diesel L6 116mm Bore (PowerTech 2V IC)	118
3140 ... Wheel Tractor	5.4L 329 OHV Turbo-Diesel L6 4.0156" Bore	80	330LCR ... Excavator	8.1L 495.9 (8129cc) OHV Turbo-Diesel L6 116mm Bore (PowerTech 2V AC)	119
315SE ... Backhoe	4.5L 275.8 (4522cc) OHV Turbo-Diesel L4 106mm Bore (PowerTech 2V)	66	330LCR ... Excavator	8.1L 495.9 (8129cc) OHV Turbo-Diesel L6 116mm Bore (PowerTech 2V)	121
315SG ... Backhoe	4.5L 275.8 (4522cc) OHV Turbo-Diesel L4 106mm Bore (PowerTech 2V)	66	3300 ... Combine	2.7L 164 OHV Diesel L3 4.0156" Bore	23
3150 ... Wheel Tractor	5.9L 359 OHV Diesel L6 4.1875" Bore	85	3300 ... Combine	3.3L 202 OHV L4 3.8594" Bore	37
3152D ... Power Unit	2.5L 152 OHV Diesel L3 3.8594" Bore	18	3300 ... Combine	3.6L 219 OHV L4 4.0156" Bore	40
3155 ... Wheel Tractor	5.9L 359 OHV Diesel L6 4.1875" Bore	85	3300 ... Combine	3.6L 219 OHV Diesel L4 4.0156" Bore	41
3164D ... Power Unit	2.7L 164 OHV Diesel L3 4.0156" Bore	23	3300 ... Combine	5.4L 329 OHV L6 4.0156" Bore	77
320 ... Wheel Tractor	1.6L 100 OHV L2 4" Bore	3	3300 ... Combine	5.4L 329 OHV LPG L6 4.0156" Bore	79
3200 ... Telehandler	4.5L 275.8 (4522cc) OHV Turbo-Diesel L4 106mm Bore (PowerTech 2V IC)	61	335 ... Forestry Tractor	6.8L 413.8 (6784cc) OHV Turbo-Diesel L6 106mm Bore (PowerTech 2V IC)	102

(continued on next page)



# John Deere Off Highway

Model Index					
Model	Engine Description	Line No.	Model	Engine Description	Line No.
335 ... Forestry Tractor	6.8L 413.8 (6784cc) OHV Turbo-Diesel L6 106mm Bore (PowerTech 2V)	108	360DG ... Forestry Tractor	6.8L 413.8 (6784cc) OHV Turbo-Diesel L6 106mm Bore (PowerTech 2V IC)	102
335C ... Forestry Tractor	6.8L 413.8 (6784cc) OHV Turbo-Diesel L6 106mm Bore (PowerTech 2V IC)	102	360DG ... Forestry Tractor	6.8L 413.8 (6784cc) OHV Turbo-Diesel L6 106mm Bore (PowerTech 2V)	108
335C ... Forestry Tractor	6.8L 413.8 (6784cc) OHV Turbo-Diesel L6 106mm Bore (PowerTech 2V)	108	362G ... Power Unit	5.9L 362 OHV L6 4.25" Bore	87
340D ... Wheel Tractor	4.5L 276 OHV Diesel L4 4.1875" Bore (Standard)	67	370 ... Excavator	8.1L 495.9 (8129cc) OHV Turbo-Diesel L6 116mm Bore (PowerTech 2V IC)	118
340D ... Skidder	4.5L 276 OHV Diesel L4 4.1875" Bore (Standard)	67	370 ... Excavator	8.1L 495.9 (8129cc) OHV Turbo-Diesel L6 116mm Bore (PowerTech 2V AC)	119
3400 ... Telehandler	4.5L 275.8 (4522cc) OHV Turbo-Diesel L4 106mm Bore (PowerTech 2V IC)	61	370 ... Excavator	8.1L 495.9 (8129cc) OHV Turbo-Diesel L6 116mm Bore (PowerTech 2V)	121
3400 ... Telehandler	4.5L 275.8 (4522cc) OHV Turbo-Diesel L4 106mm Bore (PowerTech 2V)	66	370C ... Excavator	8.1L 495.9 (8129cc) OHV Turbo-Diesel L6 116mm Bore (PowerTech 2V IC)	118
341G ... Power Unit	5.6L 340 OHV L6 4.25" Bore	81	370C ... Excavator	8.1L 495.9 (8129cc) OHV Turbo-Diesel L6 116mm Bore (PowerTech 2V AC)	119
3415 ... Telehandler	4.5L 275.8 (4522cc) OHV Turbo-Diesel L4 106mm Bore (PowerTech 2V IC)	61	370C ... Excavator	8.1L 495.9 (8129cc) OHV Turbo-Diesel L6 116mm Bore (PowerTech 2V)	121
3415 ... Telehandler	4.5L 275.8 (4522cc) OHV Turbo-Diesel L4 106mm Bore (PowerTech 2V)	66	380 ... Forklift	2.5L 152 OHV Diesel L3 3.8594" Bore	18
3420 ... Telehandler	4.5L 275.8 (4522cc) OHV Turbo-Diesel L4 106mm Bore (PowerTech 2V IC)	61	3800 ... Telehandler	4.5L 275.8 (4522cc) OHV Turbo-Diesel L4 106mm Bore (PowerTech 2V IC)	61
3420 ... Telehandler	4.5L 275.8 (4522cc) OHV Turbo-Diesel L4 106mm Bore (PowerTech 2V)	66	3800 ... Telehandler	4.5L 275.8 (4522cc) OHV Turbo-Diesel L4 106mm Bore (PowerTech 2V)	66
3430 ... Windrower	3.9L 239 OHV Diesel L4 4.1875" Bore (Standard)	50	3830 ... Windrower	3.9L 239 OHV Turbo-Diesel L4 4.1875" Bore (Standard)	51
344E ... Loader	4.5L 276 OHV Diesel L4 4.1875" Bore (Standard)	67	40 ... Wheel Tractor	1.6L 100 OHV L2 4" Bore	3
344E ... Loader	4.5L 275.8 (4522cc) OHV Diesel L4 106mm Bore (Litre Engine)	63	40 ... Combine	1.9L 115 OHV L4 3.5" Bore	8
344G ... Loader	4.5L 275.8 (4522cc) OHV Turbo-Diesel L4 106mm Bore (Litre Engine)	65	40 ... Combine	2.7L 165 OHV Diesel L4 3.875" Bore	25
344H ... Loader Tractor	4.5L 275.8 (4522cc) OHV Diesel L4 106mm Bore (PowerTech 2V)	64	40C ... Wheel Tractor	1.6L 100 OHV L2 4" Bore	3
344H ... Loader Tractor	4.5L 275.8 (4522cc) OHV Turbo-Diesel L4 106mm Bore (PowerTech 2V)	66	40M ... Wheel Tractor	1.6L 100 OHV L2 4" Bore	3
350 ... Crawler Tractor	2.5L 152 OHV Diesel L3 3.8594" Bore (Standard)	18	40T ... Wheel Tractor	1.6L 100 OHV L2 4" Bore	3
350B ... Crawler Tractor	2.5L 152 OHV Diesel L3 3.8594" Bore	18	40U ... Wheel Tractor	1.6L 100 OHV L2 4" Bore	3
350C ... Crawler Tractor	2.5L 152 OHV Diesel L3 3.8594" Bore	18	400 ... Wheel Tractor	3.3L 202 OHV Diesel L4 3.8594" Bore	38
350C ... Crawler Tractor	2.7L 164 OHV Diesel L3 4.0156" Bore	23	400G ... Crawler Tractor	3.9L 239 OHV Diesel L4 4.1875" Bore (Standard)	50
350D ... Crawler Tractor	2.9L 179 OHV Diesel L3 4.1875" Bore (Standard)	27	400G ... Crawler Tractor	3.9L 239 (3917cc) OHV Diesel L4 106mm Bore (Litre Engine)	52
355D ... Crawler Tractor	2.9L 179 OHV Diesel L3 4.1875" Bore (Standard)	27	4000 ... Wheel Tractor	4.9L 302 OHV L6 4" Bore	71
3554 ... Logger	8.1L 495.9 (8129cc) OHV Turbo-Diesel L6 116mm Bore (PowerTech 2V IC)	118	4000 ... Wheel Tractor	5.6L 340 OHV L6 4.25" Bore	81
3554 ... Logger	8.1L 495.9 (8129cc) OHV Turbo-Diesel L6 116mm Bore (PowerTech 2V AC)	119	4000 ... Wheel Tractor	5.6L 340 OHV LPG L6 4.25" Bore	82
3554 ... Logger	8.1L 495.9 (8129cc) OHV Turbo-Diesel L6 116mm Bore (PowerTech 2V)	121	4000 ... Wheel Tractor	5.9L 362 OHV L6 4.25" Bore	87
360DC ... Forestry Tractor	6.8L 413.8 (6784cc) OHV Turbo-Diesel L6 106mm Bore (PowerTech 2V IC)	102	4000 ... Wheel Tractor	5.9L 362 OHV LPG L6 4.25" Bore	88
360DC ... Forestry Tractor	6.8L 413.8 (6784cc) OHV Turbo-Diesel L6 106mm Bore (PowerTech 2V)	108	4000 ... Wheel Tractor	5.9L 362 OHV NG L6 4.25" Bore (Early)	95
			4000 ... Wheel Tractor	6.6L 404 OHV Diesel L6 4.25" Bore (Late)	96
			4000 ... Wheel Tractor	6.6L 404 OHV Diesel L6 4.25" Bore (Standard)	113
			401 ... Wheel Tractor	3.3L 202 OHV Diesel L4 3.8594" Bore	38
			401B ... Wheel Tractor	3.6L 219 OHV Diesel L4 4.0156" Bore	41
			401C ... Wheel Tractor	3.6L 219 OHV Diesel L4 4.0156" Bore	41
			401D ... Wheel Tractor	3.6L 219 OHV Diesel L4 4.0156" Bore	41
			401D ... Backhoe	4.5L 275.8 (4522cc) OHV Diesel L4 106mm Bore (Litre Engine)	63

(continued on next page)

Model Index					
Model	Engine Description	Line No.	Model	Engine Description	Line No.
401D ... Backhoe	4.5L 276 OHV Turbo-Diesel L4 4.1875" Bore (Standard)	68	410 ... Backhoe	3.6L 219 OHV Diesel L4 4.0156" Bore	41
401D ... Backhoe	4.5L 275.8 (4522cc) OHV Turbo-Diesel L4 106mm Bore (Litre Engine)	65	410B ... Wheel Tractor	3.6L 219 OHV Diesel L4 4.0156" Bore	41
4010 ... Wheel Tractor	4.9L 302 OHV L6 4" Bore	71	410B ... Backhoe	3.6L 219 OHV Diesel L4 4.0156" Bore	41
4010 ... Wheel Tractor	5.6L 340 OHV L6 4.25" Bore	81	410B ... Backhoe	3.6L 219 OHV Turbo-Diesel L4 4.0156" Bore	42
4010 ... Wheel Tractor	5.6L 340 OHV LPG L6 4.25" Bore	82	410C ... Backhoe	4.5L 276 OHV Diesel L4 4.1875" Bore (Standard)	67
4010 ... Wheel Tractor	6.2L 381 OHV Diesel L6 4.125" Bore	94	410C ... Backhoe	4.5L 276 OHV Turbo-Diesel L4 4.1875" Bore (Standard)	68
4010 ... Wheel Tractor	6.6L 404 OHV Diesel L6 4.25" Bore (Early)	95	410D ... Backhoe	4.5L 276 OHV Diesel L4 4.1875" Bore (Standard)	67
4020 ... Wheel Tractor	4.9L 302 OHV L6 4" Bore	71	410D ... Backhoe	4.5L 276 OHV Turbo-Diesel L4 4.1875" Bore (Standard)	68
4020 ... Wheel Tractor	5.6L 340 OHV L6 4.25" Bore	81	410D ... Backhoe	4.5L 275.8 (4522cc) OHV Turbo-Diesel L4 106mm Bore (Litre Engine)	65
4020 ... Wheel Tractor	5.6L 340 OHV LPG L6 4.25" Bore	82	410E ... Backhoe	4.5L 275.8 (4522cc) OHV Turbo-Diesel L4 106mm Bore (PowerTech 2V)	66
4020 ... Wheel Tractor	5.9L 362 OHV L6 4.25" Bore	87	410G ... Backhoe	4.5L 275.8 (4522cc) OHV Turbo-Diesel L4 106mm Bore (PowerTech 2V)	66
4020 ... Wheel Tractor	5.9L 362 OHV LPG L6 4.25" Bore	88	4180G ... Power Unit	2.9L 180 OHV L4 3.8594" Bore	31
4020 ... Wheel Tractor	5.9L 362 OHV NG L6 4.25" Bore	89	420 ... Wheel Tractor	1.9L 113 OHV L2 4.25" Bore	7
4020 ... Wheel Tractor	6.6L 404 OHV Diesel L6 4.25" Bore (Early)	95	4202D ... Power Unit	3.3L 202 OHV Diesel L4 3.8594" Bore	38
4020 ... Wheel Tractor	6.6L 404 OHV Diesel L6 4.25" Bore (Late)	96	4202G ... Power Unit	3.3L 202 OHV L4 3.8594" Bore	37
4030 ... Wheel Tractor	5.0L 303 OHV L6 3.8594" Bore	72	4219D ... Power Unit	3.6L 219 OHV Diesel L4 4.0156" Bore	41
4030 ... Wheel Tractor	5.0L 303 OHV LPG L6 3.8594" Bore	74	4219G ... Power Unit	3.6L 219 OHV L4 4.0156" Bore	40
4030 ... Wheel Tractor	5.4L 329 OHV Diesel L6 4.0156" Bore	78	4230 ... Wheel Tractor	4.9L 302 OHV L6 4" Bore	71
404 ... Power Unit	6.6L 404 OHV Diesel L6 4.25" Bore (Early)	95	4230 ... Wheel Tractor	5.0L 303 OHV L6 3.8594" Bore	72
404 ... Power Unit	6.6L 404 OHV Diesel L6 4.25" Bore (Late)	96	4230 ... Wheel Tractor	5.0L 303 OHV LPG L6 3.8594" Bore	74
4040 ... Wheel Tractor	6.6L 404 OHV Diesel L6 4.25" Bore (Early)	95	4230 ... Wheel Tractor	5.4L 329 OHV Diesel L6 4.0156" Bore	78
4040 ... Wheel Tractor	6.6L 404 OHV Diesel L6 4.25" Bore (Late)	96	4230 ... Wheel Tractor	6.6L 404 OHV Diesel L6 4.25" Bore (Early)	95
4040 ... Wheel Tractor	6.6L 404 OHV Turbo-Diesel L6 4.25" Bore (Aftercooled)	98	4230 ... Wheel Tractor	6.6L 404 OHV Diesel L6 4.25" Bore (Late)	96
4040 ... Wheel Tractor	7.6L 466 OHV Diesel L6 4.5625" Bore (Standard)	113	4230 ... Wheel Tractor	7.6L 466 OHV Diesel L6 4.5625" Bore (Standard)	113
4045DF120 ... Power Unit	4.5L 275.8 (4522cc) OHV Diesel L4 106mm Bore (PowerTech 2V)	64	4230 ... Wheel Tractor	7.6L 466 OHV Turbo-Diesel L6 4.5625" Bore (Standard)	114
4045DF150 ... Power Unit	4.5L 275.8 (4522cc) OHV Diesel L4 106mm Bore (PowerTech 2V)	64	4230 ... Wheel Tractor	7.6L 466 OHV Turbo-Diesel L6 4.5625" Bore (Standard)	114
4045DF158 ... Power Unit	4.5L 275.8 (4522cc) OHV Diesel L4 106mm Bore (PowerTech 2V)	64	4250 ... Wheel Tractor	7.6L 466 OHV Turbo-Diesel L6 4.5625" Bore (Standard)	114
4045DF270 ... Power Unit	4.5L 275.8 (4522cc) OHV Diesel L4 106mm Bore (PowerTech 2V)	64	4255 ... Wheel Tractor	7.6L 465.9 (7638cc) OHV Turbo-Diesel L6 115mm Bore (Litre Engine)	116
4045HF ... Power Unit	4.5L 275.8 (4522cc) OHV Turbo-Diesel L4 106mm Bore (PowerTech 2V IC)	61	428 ... Cotton Picker	5.4L 329 OHV L6 4.0156" Bore	77
4045HF475 ... Power Unit	4.5L 275.8 (4522cc) OHV Turbo-Diesel L4 106mm Bore (PowerTech 4V IC)	62	428 ... Cotton Picker	5.4L 329 OHV Diesel L6 4.0156" Bore	78
4045HF485 ... Power Unit	4.5L 275.8 (4522cc) OHV Turbo-Diesel L4 106mm Bore (PowerTech 4V IC)	62	428 ... Cotton Picker	5.4L 329 OHV LPG L6 4.0156" Bore	79
4045TF ... Power Unit	4.5L 275.8 (4522cc) OHV Turbo-Diesel L4 106mm Bore (PowerTech 2V)	66	430 ... Wheel Tractor	1.9L 113 OHV L2 4.25" Bore	7
4045TF150 ... Power Unit	4.5L 275.8 (4522cc) OHV Turbo-Diesel L4 106mm Bore (PowerTech 2V)	66	430B ... Forestry Tractor	6.8L 413.8 (6784cc) OHV Turbo-Diesel L6 106mm Bore (PowerTech 2V IC)	102
4050 ... Wheel Tractor	5.9L 359 OHV Turbo-Diesel L6 4.1875" Bore	86	430B ... Forestry Tractor	6.8L 413.8 (6784cc) OHV Turbo-Diesel L6 106mm Bore (PowerTech 2V)	108
4050 ... Wheel Tractor	7.6L 466 OHV Diesel L6 4.5625" Bore (Standard)	113			
4055 ... Wheel Tractor	7.6L 465.9 (7638cc) OHV Turbo-Diesel L6 115mm Bore (Litre Engine)	116			

(continued on next page)



# John Deere Off Highway

Model Index					
Model	Engine Description	Line No.	Model	Engine Description	Line No.
430B-II ... Forestry Tractor	6.8L 413.8 (6784cc) OHV Turbo-Diesel L6 106mm Bore (PowerTech 2V IC)	102	4400 ... Combine	2.7L 164 OHV Diesel L3 4.0156" Bore	23
430B-II ... Forestry Tractor	6.8L 413.8 (6784cc) OHV Turbo-Diesel L6 106mm Bore (PowerTech 2V)	108	4400 ... Combine	3.6L 219 OHV Diesel L4 4.0156" Bore	41
4320 ... Wheel Tractor	6.6L 404 OHV Diesel L6 4.25" Bore (Early)	95	4400 ... Combine	5.4L 329 OHV L6 4.0156" Bore	77
4320 ... Wheel Tractor	6.6L 404 OHV Diesel L6 4.25" Bore (Late)	96	4400 ... Combine	5.4L 329 OHV Diesel L6 4.0156" Bore	78
4320 ... Wheel Tractor	6.6L 404 OHV Turbo-Diesel L6 4.25" Bore (Aftercooled)	98	4400 ... Combine	5.4L 329 OHV LPG L6 4.0156" Bore	79
4320 ... Wheel Tractor	7.6L 466 OHV Turbo-Diesel L6 4.5625" Bore (Standard)	114	4401D ... Wheel Tractor	1.7L 106 OHV Diesel L2 3.875" Bore (Detroit Diesel Eng.)	4
435 ... Forestry Tractor	6.8L 413.8 (6784cc) OHV Turbo-Diesel L6 106mm Bore (PowerTech 2V IC)	102	4420 ... Combine	2.7L 164 OHV Diesel L3 4.0156" Bore	23
435 ... Forestry Tractor	6.8L 413.8 (6784cc) OHV Turbo-Diesel L6 106mm Bore (PowerTech 2V)	108	4420 ... Combine	3.6L 219 OHV L4 4.0156" Bore	40
435-II ... Forestry Tractor	6.8L 413.8 (6784cc) OHV Turbo-Diesel L6 106mm Bore (PowerTech 2V IC)	102	4420 ... Combine	5.4L 329 OHV Diesel L6 4.0156" Bore	78
435-II ... Forestry Tractor	6.8L 413.8 (6784cc) OHV Turbo-Diesel L6 106mm Bore (PowerTech 2V)	108	4420 ... Wheel Tractor	5.4L 329 OHV Diesel L6 4.0156" Bore	78
435C ... Forestry Tractor	6.8L 413.8 (6784cc) OHV Turbo-Diesel L6 106mm Bore (PowerTech 2V IC)	102	4425 ... Combine	5.9L 359 OHV Diesel L6 4.1875" Bore	85
435C ... Forestry Tractor	6.8L 413.8 (6784cc) OHV Turbo-Diesel L6 106mm Bore (PowerTech 2V)	108	4430 ... Wheel Tractor	6.6L 404 OHV Diesel L6 4.25" Bore (Late)	96
435D ... Wheel Tractor	1.7L 106 OHV Diesel L2 3.875" Bore (Detroit Diesel Eng.)	4	4430 ... Wheel Tractor	6.6L 404 OHV Turbo-Diesel L6 4.25" Bore (Aftercooled)	98
435D ... Wheel Tractor	4.5L 276 OHV Diesel L4 4.1875" Bore (Standard)	67	4430 ... Wheel Tractor	7.6L 466 OHV Turbo-Diesel L6 4.5625" Bore (Standard)	114
437C ... Forestry Tractor	6.8L 413.8 (6784cc) OHV Turbo-Diesel L6 106mm Bore (PowerTech 2V IC)	102	4435 ... Combine	5.9L 359 OHV Diesel L6 4.1875" Bore	85
437C ... Forestry Tractor	6.8L 413.8 (6784cc) OHV Turbo-Diesel L6 106mm Bore (PowerTech 2V)	108	444 ... Loader	5.4L 329 OHV Diesel L6 4.0156" Bore	78
440 ... Wheel Tractor	1.9L 113 OHV L2 4.25" Bore	7	444 ... Loader	5.4L 329 OHV Turbo-Diesel L6 4.0156" Bore	80
440 From Ser. No. 50000 ... Skidder	3.6L 219 OHV Diesel L4 4.0156" Bore	41	444C ... Loader	5.4L 329 OHV Diesel L6 4.0156" Bore	78
440 To Ser. No. 49999 ... Skidder	3.3L 202 OHV Diesel L4 3.8594" Bore	38	444C ... Loader	5.4L 329 OHV Turbo-Diesel L6 4.0156" Bore	80
440A From Ser. No. 50000 ... Skidder	3.6L 219 OHV Diesel L4 4.0156" Bore	41	444CH ... Loader	5.4L 329 OHV Diesel L6 4.0156" Bore	78
440A To Ser. No. 49999 ... Skidder	3.3L 202 OHV Diesel L4 3.8594" Bore	38	444D ... Loader	5.4L 329 OHV Diesel L6 4.0156" Bore	78
440B From Ser. No. 50000 ... Skidder	3.6L 219 OHV Diesel L4 4.0156" Bore	41	444D ... Loader	5.4L 329 OHV Turbo-Diesel L6 4.0156" Bore	80
440B To Ser. No. 49999 ... Skidder	3.3L 202 OHV Diesel L4 3.8594" Bore	38	444E ... Loader	4.5L 276 OHV Turbo-Diesel L4 4.1875" Bore (Standard)	68
440C ... Skidder	4.5L 276 OHV Diesel L4 4.1875" Bore (Standard)	67	444E ... Loader	4.5L 275.8 (4522cc) OHV Turbo-Diesel L4 106mm Bore (Litre Engine)	65
440C ... Skidder	4.5L 276 OHV Turbo-Diesel L4 4.1875" Bore (Standard)	68	444G ... Loader	4.5L 275.8 (4522cc) OHV Turbo-Diesel L4 106mm Bore (Litre Engine)	65
440D ... Wheel Tractor	1.7L 106 OHV Diesel L2 3.875" Bore (Detroit Diesel Eng.)	4	444H ... Loader Tractor	4.5L 275.8 (4522cc) OHV Turbo-Diesel L4 106mm Bore (PowerTech 2V IC)	61
440D ... Wheel Tractor	4.5L 276 OHV Diesel L4 4.1875" Bore (Standard)	67	444H ... Loader Tractor	4.5L 275.8 (4522cc) OHV Turbo-Diesel L4 106mm Bore (PowerTech 2V)	66
440D ... Skidder	4.5L 276 OHV Turbo-Diesel L4 4.1875" Bore (Standard)	68	444HLL ... Forestry Tractor	4.5L 275.8 (4522cc) OHV Turbo-Diesel L4 106mm Bore (PowerTech 2V IC)	61
4400 ... Wheel Tractor	1.7L 106 OHV Diesel L2 3.875" Bore (Detroit Diesel Eng.)	4	444HLL ... Forestry Tractor	4.5L 275.8 (4522cc) OHV Turbo-Diesel L4 106mm Bore (PowerTech 2V)	66
			444J ... Loader Tractor	4.5L 275.8 (4522cc) OHV Turbo-Diesel L4 106mm Bore (PowerTech 2V IC)	61
			444J ... Loader Tractor	4.5L 275.8 (4522cc) OHV Turbo-Diesel L4 106mm Bore (PowerTech 2V)	66
			4440 ... Wheel Tractor	6.6L 404 OHV Diesel L6 4.25" Bore (Early)	95
			4440 ... Wheel Tractor	6.6L 404 OHV Diesel L6 4.25" Bore (Late)	96

(continued on next page)

Model Index					
Model	Engine Description	Line No.	Model	Engine Description	Line No.
4440 ... Wheel Tractor	6.6L 404 OHV Turbo-Diesel L6 4.25" Bore (Aftercooled)	98	450H ... Crawler Tractor	4.5L 275.8 (4522cc) OHV Turbo-Diesel L4 106mm Bore (PowerTech 2V)	66
4440 ... Wheel Tractor	7.6L 466 OHV Diesel L6 4.5625" Bore (Standard)	113	450J ... Crawler Tractor	4.5L 275.8 (4522cc) OHV Diesel L4 106mm Bore (PowerTech 2V)	64
4440 ... Wheel Tractor	7.6L 466 OHV Turbo-Diesel L6 4.5625" Bore (Standard)	114	450J ... Crawler Tractor	4.5L 275.8 (4522cc) OHV Turbo-Diesel L4 106mm Bore (PowerTech 2V)	66
4450 ... Wheel Tractor	7.6L 466 OHV Turbo-Diesel L6 4.5625" Bore (Standard)	114	4520 ... Wheel Tractor	6.6L 404 OHV Diesel L6 4.25" Bore (Early)	95
4455 ... Wheel Tractor	7.6L 465.9 (7638cc) OHV Turbo-Diesel L6 115mm Bore (Litre Engine)	116	4520 ... Wheel Tractor	6.6L 404 OHV Diesel L6 4.25" Bore (Late)	96
448D ... Wheel Tractor	4.5L 276 OHV Diesel L4 4.1875" Bore (Standard)	67	4520 ... Wheel Tractor	6.6L 404 OHV Turbo-Diesel L6 4.25" Bore (Aftercooled)	98
448D ... Skidder	4.5L 276 OHV Turbo-Diesel L4 4.1875" Bore (Standard)	68	4520 ... Wheel Tractor	7.6L 466 OHV Turbo-Diesel L6 4.5625" Bore (Standard)	114
45 ... Wheel Tractor	2.4L 145 OHV L4 3.625" Bore	13	455D ... Crawler Tractor	3.6L 219 OHV Turbo-Diesel L4 4.0156" Bore	42
45 ... Combine	2.5L 155 OHV Diesel L4 3.75" Bore	20	455E ... Wheel Tractor	4.5L 276 OHV Diesel L4 4.1875" Bore (Standard)	67
45 ... Combine	2.7L 165 OHV Diesel L4 3.875" Bore	25	455E ... Crawler Tractor	4.5L 276 OHV Diesel L4 4.1875" Bore (Standard)	67
45 ... Combine	2.9L 180 OHV L4 3.8594" Bore	31	455E ... Crawler Tractor	4.5L 276 OHV Turbo-Diesel L4 4.1875" Bore (Standard)	68
450 ... Crawler Tractor	3.3L 202 OHV Diesel L4 3.8594" Bore	38	455G ... Crawler Tractor	4.5L 276 OHV Diesel L4 4.1875" Bore (Standard)	67
450B ... Crawler Tractor	3.6L 219 OHV Diesel L4 4.0156" Bore	41	455G ... Crawler Tractor	4.5L 275.8 (4522cc) OHV Diesel L4 106mm Bore (Litre Engine)	63
450B ... Crawler Tractor	3.6L 219 OHV Turbo-Diesel L4 4.0156" Bore	42	455G ... Crawler Tractor	4.5L 276 OHV Turbo-Diesel L4 4.1875" Bore (Standard)	68
450BT ... Wheel Tractor	5.4L 329 OHV Diesel L6 4.0156" Bore	78	455G ... Crawler Tractor	4.5L 275.8 (4522cc) OHV Diesel L4 106mm Bore (Litre Engine)	65
450C ... Wheel Tractor	2.9L 180 OHV L4 3.8594" Bore	31	4555 ... Wheel Tractor	7.6L 465.9 (7638cc) OHV Turbo-Diesel L6 115mm Bore (Litre Engine)	116
450C ... Wheel Tractor	3.3L 202 OHV L4 3.8594" Bore	37	4560 ... Wheel Tractor	7.6L 465.9 (7638cc) OHV Turbo-Diesel L6 115mm Bore (Litre Engine)	116
450C ... Wheel Tractor	3.3L 202 OHV Diesel L4 3.8594" Bore	38	460DC ... Forestry Tractor	6.8L 413.8 (6784cc) OHV Turbo-Diesel L6 106mm Bore (PowerTech 2V IC)	102
450C ... Wheel Tractor	3.6L 219 OHV L4 4.0156" Bore	40	460DC ... Logger	6.8L 413.8 (6784cc) OHV Turbo-Diesel L6 106mm Bore (PowerTech 4V IC)	103
450C ... Wheel Tractor	3.6L 219 OHV Diesel L4 4.0156" Bore	41	460DC ... Forestry Tractor	6.8L 413.8 (6784cc) OHV Turbo-Diesel L6 106mm Bore (PowerTech 2V)	108
450C ... Crawler Tractor	3.6L 219 OHV Diesel L4 4.0156" Bore	41	460DG ... Forestry Tractor	6.8L 413.8 (6784cc) OHV Turbo-Diesel L6 106mm Bore (PowerTech 2V IC)	102
450C ... Crawler Tractor	3.6L 219 OHV Turbo-Diesel L4 4.0156" Bore	42	460DG ... Logger	6.8L 413.8 (6784cc) OHV Turbo-Diesel L6 106mm Bore (PowerTech 4V IC)	103
450D ... Wheel Tractor	3.6L 219 OHV Diesel L4 4.0156" Bore	41	460DG ... Forestry Tractor	6.8L 413.8 (6784cc) OHV Turbo-Diesel L6 106mm Bore (PowerTech 2V)	108
450D ... Crawler Tractor	3.6L 219 OHV Turbo-Diesel L4 4.0156" Bore	42	4620 ... Wheel Tractor	6.6L 404 OHV Diesel L6 4.25" Bore (Early)	95
450E ... Wheel Tractor	4.5L 276 OHV Diesel L4 4.1875" Bore (Standard)	67	4620 ... Wheel Tractor	6.6L 404 OHV Diesel L6 4.25" Bore (Late)	96
450E ... Crawler Tractor	4.5L 276 OHV Diesel L4 4.1875" Bore (Standard)	67	4620 ... Wheel Tractor	6.6L 404 OHV Diesel L6 4.25" Bore (5 Main)	97
450E ... Crawler Tractor	4.5L 276 OHV Turbo-Diesel L4 4.1875" Bore (Standard)	68	4620 ... Wheel Tractor	6.6L 404 OHV Turbo-Diesel L6 4.25" Bore (Aftercooled)	98
450ELT ... Crawler Tractor	4.5L 276 OHV Diesel L4 4.1875" Bore (Standard)	67	4620 ... Wheel Tractor	7.6L 466 OHV Turbo-Diesel L6 4.5625" Bore (Standard)	114
450ELT ... Crawler Tractor	4.5L 276 OHV Turbo-Diesel L4 4.1875" Bore (Standard)	68	4630 ... Wheel Tractor	6.6L 404 OHV Turbo-Diesel L6 4.25" Bore (Aftercooled)	98
450G ... Crawler Tractor	4.5L 275.8 (4522cc) OHV Turbo-Diesel L4 106mm Bore (PowerTech 2V IC)	61	4630 ... Wheel Tractor	7.6L 466 OHV Turbo-Diesel L6 4.5625" Bore (Standard)	114
450G ... Crawler Tractor	4.5L 276 OHV Diesel L4 4.1875" Bore (Standard)	67	4640 ... Wheel Tractor	7.6L 466 OHV Turbo-Diesel L6 4.5625" Bore (Standard)	114
450G ... Crawler Tractor	4.5L 275.8 (4522cc) OHV Diesel L4 106mm Bore (Litre Engine)	63			
450G ... Crawler Tractor	4.5L 276 OHV Turbo-Diesel L4 4.1875" Bore (Standard)	68			
450G ... Crawler Tractor	4.5L 275.8 (4522cc) OHV Turbo-Diesel L4 106mm Bore (Litre Engine)	65			
450G ... Crawler Tractor	4.5L 275.8 (4522cc) OHV Turbo-Diesel L4 106mm Bore (PowerTech 2V)	66			
450H ... Crawler Tractor	4.5L 275.8 (4522cc) OHV Diesel L4 106mm Bore (PowerTech 2V)	64			

(continued on next page)





# John Deere Off Highway

Model Index					
Model	Engine Description	Line No.	Model	Engine Description	Line No.
4650 ... Wheel Tractor	7.6L 466 OHV Turbo-Diesel L6 4.5625" Bore (Standard)	114	490E ... Excavator	4.5L 275.8 (4522cc) OHV Turbo-Diesel L4 106mm Bore (Litre Engine)	65
4700 ... Sprayer	6.8L 413.8 (6784cc) OHV Turbo-Diesel L6 106mm Bore (PowerTech 2V IC)	102	493D ... Feller Buncher	4.5L 276 OHV Diesel L4 4.1875" Bore (Standard)	67
4700 ... Sprayer	6.8L 413.8 (6784cc) OHV Turbo-Diesel L6 106mm Bore (PowerTech 2V)	108	495D ... Excavator	4.5L 276 OHV Turbo-Diesel L4 4.1875" Bore (Standard)	68
4710 ... Sprayer	6.8L 413.8 (6784cc) OHV Turbo-Diesel L6 106mm Bore (PowerTech 2V IC)	102	495D ... Excavator	4.5L 275.8 (4522cc) OHV Turbo-Diesel L4 106mm Bore (Litre Engine)	65
4710 ... Sprayer	6.8L 413.8 (6784cc) OHV Turbo-Diesel L6 106mm Bore (PowerTech 2V)	108	4955 ... Wheel Tractor	7.6L 465.9 (7638cc) OHV Turbo-Diesel L6 115mm Bore (Litre Engine)	116
4720 ... Sprayer	6.8L 413.8 (6784cc) OHV Turbo-Diesel L6 106mm Bore (PowerTech 4V IC)	103	499 ... Cotton Picker	3.6L 219 OHV L4 4.0156" Bore	40
4755 ... Wheel Tractor	7.6L 465.9 (7638cc) OHV Turbo-Diesel L6 115mm Bore (Litre Engine)	116	499 ... Cotton Picker	3.6L 219 OHV Diesel L4 4.0156" Bore	41
4760 ... Wheel Tractor	7.6L 465.9 (7638cc) OHV Turbo-Diesel L6 115mm Bore (Litre Engine)	116	499 ... Cotton Picker	5.4L 329 OHV L6 4.0156" Bore	77
480 ... Forklift	3.3L 202 OHV Diesel L4 3.8594" Bore	38	499 ... Combine	5.4L 329 OHV Diesel L6 4.0156" Bore	78
480A ... Forklift	3.3L 202 OHV Diesel L4 3.8594" Bore	38	499 ... Cotton Picker	5.4L 329 OHV LPG L6 4.0156" Bore	79
480B ... Forklift	3.6L 219 OHV Diesel L4 4.0156" Bore	41	4990 ... Windrower	6.8L 413.8 (6784cc) OHV Turbo-Diesel L6 106mm Bore (PowerTech 2V IC)	102
480C ... Forklift	3.6L 219 OHV Diesel L4 4.0156" Bore	41	4990 ... Windrower	6.8L 413.8 (6784cc) OHV Turbo-Diesel L6 106mm Bore (PowerTech 2V)	108
482 ... Cotton Picker	5.4L 329 OHV L6 4.0156" Bore	77	4995 ... Windrower	6.8L 413.8 (6784cc) OHV Turbo-Diesel L6 106mm Bore (PowerTech 2V IC)	102
482 ... Combine	5.4L 329 OHV Diesel L6 4.0156" Bore	78	4995 ... Windrower	6.8L 413.8 (6784cc) OHV Turbo-Diesel L6 106mm Bore (PowerTech 2V)	108
482 ... Cotton Picker	5.4L 329 OHV Diesel L6 4.0156" Bore	78	50 ... Wheel Tractor	3.1L 190 OHV L2 4.6875" Bore	34
482 ... Cotton Picker	5.4L 329 OHV LPG L6 4.0156" Bore	79	50 ... Wheel Tractor	3.1L 190 OHV Distillate L2 4.6875" Bore	35
482C ... Forklift	3.6L 219 OHV Diesel L4 4.0156" Bore	41	500C ... Loader	3.3L 201 OHV L4 4" Bore	36
482C ... Forklift	3.9L 239 (3917cc) OHV Diesel L4 106mm Bore (Litre Engine)	52	500C ... Loader	3.9L 241 OHV L4 4.25" Bore	54
4840 ... Wheel Tractor	7.6L 466 OHV Diesel L6 4.5625" Bore (Standard)	113	500C ... Loader	3.9L 241 OHV LPG L4 4.25" Bore	55
4840 ... Wheel Tractor	7.6L 466 OHV Turbo-Diesel L6 4.5625" Bore (Standard)	114	500C ... Loader	4.2L 254 OHV Diesel L4 4.125" Bore	59
485E ... Forklift	4.5L 275.8 (4522cc) OHV Diesel L4 106mm Bore (PowerTech 2V)	64	500C ... Loader	4.4L 270 OHV Diesel L4 4.25" Bore	60
485E ... Forklift	4.5L 275.8 (4522cc) OHV Turbo-Diesel L4 106mm Bore (PowerTech 2V)	66	5010 ... Wheel Tractor	8.7L 531 OHV Diesel L6 4.75" Bore	122
4850 ... Wheel Tractor	7.6L 466 OHV Turbo-Diesel L6 4.5625" Bore (Standard)	114	5010 ... Wheel Tractor	8.7L 531 OHV Turbo-Diesel L6 4.75" Bore	123
486E ... Forklift	4.5L 275.8 (4522cc) OHV Diesel L4 106mm Bore (PowerTech 2V)	64	5020 ... Wheel Tractor	8.7L 531 OHV Diesel L6 4.75" Bore	122
486E ... Forklift	4.5L 275.8 (4522cc) OHV Turbo-Diesel L4 106mm Bore (PowerTech 2V)	66	5020 ... Wheel Tractor	10.1L 619 OHV Turbo-Diesel L6 5.125" Bore	127
488E ... Forklift	4.5L 275.8 (4522cc) OHV Diesel L4 106mm Bore (PowerTech 2V)	64	510 ... Loader	3.3L 201 OHV L4 4" Bore	36
488E ... Forklift	4.5L 275.8 (4522cc) OHV Turbo-Diesel L4 106mm Bore (PowerTech 2V)	66	510 ... Loader	3.9L 241 OHV L4 4.25" Bore	54
4890 ... Windrower	4.5L 275.8 (4522cc) OHV Turbo-Diesel L4 106mm Bore (PowerTech 2V)	66	510 ... Loader	3.9L 241 OHV LPG L4 4.25" Bore	55
4895 ... Windrower	4.5L 275.8 (4522cc) OHV Turbo-Diesel L4 106mm Bore (PowerTech 2V)	66	510 ... Loader	4.2L 254 OHV Diesel L4 4.125" Bore	59
490 ... Wheel Tractor	3.9L 239 OHV Diesel L4 4.1875" Bore (Standard)	50	510 ... Loader	4.4L 270 OHV Diesel L4 4.25" Bore	60
490 ... Excavator	3.9L 239 OHV Turbo-Diesel L4 4.1875" Bore (Standard)	51	510B ... Wheel Tractor	4.5L 276 OHV Diesel L4 4.1875" Bore (Standard)	67
			510B ... Backhoe	4.5L 276 OHV Diesel L4 4.1875" Bore (Standard)	67
			510B ... Backhoe	4.5L 276 OHV Turbo-Diesel L4 4.1875" Bore (Standard)	68
			510C ... Backhoe	4.5L 276 OHV Turbo-Diesel L4 4.1875" Bore (Standard)	68
			510D ... Backhoe	4.5L 276 OHV Turbo-Diesel L4 4.1875" Bore (Standard)	68
			510D ... Backhoe	4.5L 275.8 (4522cc) OHV Turbo-Diesel L4 106mm Bore (Litre Engine)	65

(continued on next page)



Model Index					
Model	Engine Description	Line No.	Model	Engine Description	Line No.
5105 ... Wheel Tractor	2.9L 179.2 (2938cc) OHV Diesel L3 106mm Bore (PowerTech 2V)	29	535 ... Loader Tractor	8.1L 495.9 (8129cc) OHV Turbo-Diesel L6 116mm Bore (PowerTech 2V AC)	119
520 ... Wheel Tractor	3.1L 190 OHV L2 4.6875" Bore	34	535 ... Loader Tractor	8.1L 495.9 (8129cc) OHV Turbo-Diesel L6 116mm Bore (PowerTech 2V)	121
520 ... Wheel Tractor	3.1L 190 OHV Distillate L2 4.6875" Bore	35	540 To Ser. No. 119500 ... Skidder	5.0L 303 OHV Diesel L6 3.8594" Bore	73
5200 ... Wheel Tractor	2.9L 179.2 (2938cc) OHV Diesel L3 106mm Bore (PowerTech 2V)	29	540A From Ser. No. 119501 ... Skidder	5.4L 329 OHV Diesel L6 4.0156" Bore	78
5200 ... Harvester	6.6L 404 OHV Diesel L6 4.25" Bore (Late)	96	540A From Ser. No. 119501 ... Skidder	5.4L 329 OHV Turbo-Diesel L6 4.0156" Bore	80
5200 ... Harvester	6.6L 404 OHV Turbo-Diesel L6 4.25" Bore (Aftercooled)	98	540B ... Skidder	4.5L 276 OHV Turbo-Diesel L4 4.1875" Bore (Standard)	68
5200 ... Harvester	8.7L 531 OHV Turbo-Diesel L6 4.75" Bore	123	540D ... Skidder	4.5L 276 OHV Turbo-Diesel L4 4.1875" Bore (Standard)	68
5205 ... Wheel Tractor	2.9L 179.2 (2938cc) OHV Diesel L3 106mm Bore (PowerTech 2V)	29	540E ... Skidder	4.5L 275.8 (4522cc) OHV Turbo-Diesel L4 106mm Bore (Litre Engine)	65
5210 ... Wheel Tractor	2.9L 179.2 (2938cc) OHV Diesel L3 106mm Bore (PowerTech 2V)	29	540E ... Skidder	5.9L 358.4 (5876cc) OHV Turbo-Diesel L6 106mm Bore (Litre Engine)	84
5215 ... Wheel Tractor	2.9L 179.2 (2938cc) OHV Turbo-Diesel L3 106mm Bore (PowerTech 2V)	30	540G ... Skidder	5.9L 358.4 (5876cc) OHV Turbo-Diesel L6 106mm Bore (Litre Engine)	84
5215F ... Wheel Tractor	2.9L 179.2 (2938cc) OHV Turbo-Diesel L3 106mm Bore (PowerTech 2V)	30	540G ... Forestry Tractor	6.8L 413.8 (6784cc) OHV Turbo-Diesel L6 106mm Bore (PowerTech 2V IC)	102
5215V ... Wheel Tractor	2.9L 179.2 (2938cc) OHV Turbo-Diesel L3 106mm Bore (PowerTech 2V)	30	540G ... Forestry Tractor	6.8L 413.8 (6784cc) OHV Turbo-Diesel L6 106mm Bore (PowerTech 2V)	108
5220 ... Wheel Tractor	2.9L 179.2 (2938cc) OHV Diesel L3 106mm Bore (PowerTech 2V)	29	540G-II ... Forestry Tractor	6.8L 413.8 (6784cc) OHV Turbo-Diesel L6 106mm Bore (PowerTech 2V IC)	102
530 ... Wheel Tractor	3.1L 190 OHV L2 4.6875" Bore	34	540G-II ... Forestry Tractor	6.8L 413.8 (6784cc) OHV Turbo-Diesel L6 106mm Bore (PowerTech 2V)	108
530 ... Wheel Tractor	3.1L 190 OHV Distillate L2 4.6875" Bore	35	540G-III ... Forestry Tractor	6.8L 413.8 (6784cc) OHV Turbo-Diesel L6 106mm Bore (PowerTech 2V IC)	102
530B ... Loader Tractor	8.1L 495.9 (8129cc) OHV Turbo-Diesel L6 116mm Bore (PowerTech 2V IC)	118	540G-III ... Forestry Tractor	6.8L 413.8 (6784cc) OHV Turbo-Diesel L6 106mm Bore (PowerTech 2V)	108
530B ... Loader Tractor	8.1L 495.9 (8129cc) OHV Turbo-Diesel L6 116mm Bore (PowerTech 2V AC)	119	5400 ... Wheel Tractor	2.9L 179.2 (2938cc) OHV Turbo-Diesel L3 106mm Bore (PowerTech 2V)	30
530B ... Loader Tractor	8.1L 495.9 (8129cc) OHV Turbo-Diesel L6 116mm Bore (PowerTech 2V)	121	5400 ... Harvester	6.6L 404 OHV Diesel L6 4.25" Bore (Late)	96
5300 ... Wheel Tractor	2.9L 179.2 (2938cc) OHV Diesel L3 106mm Bore (PowerTech 2V)	29	5400 ... Harvester	8.7L 531 OHV Turbo-Diesel L6 4.75" Bore	123
5300N ... Wheel Tractor	2.9L 179.2 (2938cc) OHV Diesel L3 106mm Bore (PowerTech 2V)	29	5400N ... Wheel Tractor	2.9L 179.2 (2938cc) OHV Turbo-Diesel L3 106mm Bore (PowerTech 2V)	30
5310 ... Wheel Tractor	2.9L 179.2 (2938cc) OHV Diesel L3 106mm Bore (PowerTech 2V)	29	5410 ... Wheel Tractor	2.9L 179.2 (2938cc) OHV Turbo-Diesel L3 106mm Bore (PowerTech 2V)	30
5310 ... Wheel Tractor	2.9L 179.2 (2938cc) OHV Turbo-Diesel L3 106mm Bore (PowerTech 2V)	30	5410 ... Wheel Tractor	4.5L 275.8 (4522cc) OHV Diesel L4 106mm Bore (PowerTech 2V)	64
5310N ... Wheel Tractor	2.9L 179.2 (2938cc) OHV Diesel L3 106mm Bore (PowerTech 2V)	29	5410N ... Wheel Tractor	2.9L 179.2 (2938cc) OHV Turbo-Diesel L3 106mm Bore (PowerTech 2V)	30
5310N ... Wheel Tractor	2.9L 179.2 (2938cc) OHV Turbo-Diesel L3 106mm Bore (PowerTech 2V)	30	5415 ... Wheel Tractor	4.5L 275.8 (4522cc) OHV Diesel L4 106mm Bore (PowerTech 2V)	64
5315 ... Wheel Tractor	2.9L 179.2 (2938cc) OHV Turbo-Diesel L3 106mm Bore (PowerTech 2V)	30	5415 ... Wheel Tractor	4.5L 275.8 (4522cc) OHV Turbo-Diesel L4 106mm Bore (PowerTech 2V)	66
5315F ... Wheel Tractor	2.9L 179.2 (2938cc) OHV Turbo-Diesel L3 106mm Bore (PowerTech 2V)	30	5415N ... Wheel Tractor	4.5L 275.8 (4522cc) OHV Diesel L4 106mm Bore (PowerTech 2V)	64
5315V ... Wheel Tractor	2.9L 179.2 (2938cc) OHV Turbo-Diesel L3 106mm Bore (PowerTech 2V)	30			
5320 ... Wheel Tractor	2.9L 179.2 (2938cc) OHV Turbo-Diesel L3 106mm Bore (PowerTech 2V)	30			
5320N ... Wheel Tractor	2.9L 179.2 (2938cc) OHV Turbo-Diesel L3 106mm Bore (PowerTech 2V)	30			
535 ... Loader Tractor	8.1L 495.9 (8129cc) OHV Turbo-Diesel L6 116mm Bore (PowerTech 2V IC)	118			

(continued on next page)



# John Deere Off Highway

Model Index					
Model	Engine Description	Line No.	Model	Engine Description	Line No.
5415N ... Wheel Tractor	4.5L 275.8 (4522cc) OHV Turbo-Diesel L4 106mm Bore (PowerTech 2V)	66	548G ... Skidder	5.9L 358.4 (5876cc) OHV Turbo-Diesel L6 106mm Bore (Litre Engine)	84
5420 ... Wheel Tractor	4.5L 275.8 (4522cc) OHV Diesel L4 106mm Bore (PowerTech 2V)	64	548G ... Forestry Tractor	6.8L 413.8 (6784cc) OHV Turbo-Diesel L6 106mm Bore (PowerTech 2V IC)	102
5420 ... Wheel Tractor	4.5L 275.8 (4522cc) OHV Turbo-Diesel L4 106mm Bore (PowerTech 2V)	66	548G ... Forestry Tractor	6.8L 413.8 (6784cc) OHV Turbo-Diesel L6 106mm Bore (PowerTech 2V)	108
5420N ... Wheel Tractor	4.5L 275.8 (4522cc) OHV Diesel L4 106mm Bore (PowerTech 2V)	64	548G-II ... Forestry Tractor	6.8L 413.8 (6784cc) OHV Turbo-Diesel L6 106mm Bore (PowerTech 2V IC)	102
5425 ... Wheel Tractor	4.5L 275.8 (4522cc) OHV Turbo-Diesel L4 106mm Bore (PowerTech 2V)	66	548G-II ... Forestry Tractor	6.8L 413.8 (6784cc) OHV Turbo-Diesel L6 106mm Bore (PowerTech 2V)	108
5425N ... Wheel Tractor	4.5L 275.8 (4522cc) OHV Turbo-Diesel L4 106mm Bore (PowerTech 2V)	66	548G-III ... Forestry Tractor	6.8L 413.8 (6784cc) OHV Turbo-Diesel L6 106mm Bore (PowerTech 2V IC)	102
544 ... Loader	5.0L 303 OHV Diesel L6 3.8594" Bore	73	548G-III ... Forestry Tractor	6.8L 413.8 (6784cc) OHV Turbo-Diesel L6 106mm Bore (PowerTech 2V)	108
544 ... Loader	5.4L 329 OHV Diesel L6 4.0156" Bore	78	55 ... Combine	3.6L 217 OHV L6 3.625" Bore	39
544 ... Loader	5.4L 329 OHV Turbo-Diesel L6 4.0156" Bore	80	55 ... Combine	3.8L 230 L-HEAD L6 3.4375" Bore (Hercules Eng.)	48
544B ... Loader	6.8L 414 OHV Turbo-Diesel L6 4.1875" Bore (Standard)	110	55 ... Combine	5.0L 303 OHV L6 3.8594" Bore	72
544C ... Loader	6.8L 414 OHV Diesel L6 4.1875" Bore (Standard)	109	55 ... Combine	5.0L 303 OHV Diesel L6 3.8594" Bore	73
544C ... Loader	6.8L 414 OHV Turbo-Diesel L6 4.1875" Bore (Standard)	110	55 ... Combine	5.0L 303 OHV LPG L6 3.8594" Bore	74
544D ... Loader	6.8L 414 OHV Turbo-Diesel L6 4.1875" Bore (Standard)	110	55R ... Combine	3.6L 217 OHV L6 3.625" Bore	39
544DH ... Loader	6.8L 414 OHV Turbo-Diesel L6 4.1875" Bore (Standard)	110	55R ... Combine	3.8L 230 L-HEAD L6 3.4375" Bore (Hercules Eng.)	48
544E ... Loader	5.9L 359 OHV Turbo-Diesel L6 4.1875" Bore	86	550 ... Crawler Tractor	4.5L 276 OHV Turbo-Diesel L4 4.1875" Bore (Standard)	68
544G ... Loader	5.9L 358.4 (5876cc) OHV Turbo-Diesel L6 106mm Bore (Litre Engine)	84	550A ... Crawler Tractor	4.5L 276 OHV Turbo-Diesel L4 4.1875" Bore (Standard)	68
544H ... Loader Tractor	6.8L 413.8 (6784cc) OHV Turbo-Diesel L6 106mm Bore (PowerTech 2V IC)	102	550B ... Wheel Tractor	4.5L 276 OHV Diesel L4 4.1875" Bore (Standard)	67
544H ... Loader Tractor	6.8L 413.8 (6784cc) OHV Turbo-Diesel L6 106mm Bore (PowerTech 2V)	108	550B ... Crawler Tractor	4.5L 276 OHV Turbo-Diesel L4 4.1875" Bore (Standard)	68
544HLL ... Forestry Tractor	6.8L 413.8 (6784cc) OHV Turbo-Diesel L6 106mm Bore (PowerTech 2V IC)	102	550G ... Crawler Tractor	4.5L 275.8 (4522cc) OHV Turbo-Diesel L4 106mm Bore (PowerTech 2V IC)	61
544HLL ... Forestry Tractor	6.8L 413.8 (6784cc) OHV Turbo-Diesel L6 106mm Bore (PowerTech 2V)	108	550G ... Crawler Tractor	4.5L 276 OHV Turbo-Diesel L4 4.1875" Bore (Standard)	68
544J ... Loader Tractor	6.8L 413.8 (6784cc) OHV Turbo-Diesel L6 106mm Bore (PowerTech 2V IC)	102	550G ... Crawler Tractor	4.5L 275.8 (4522cc) OHV Turbo-Diesel L4 106mm Bore (Litre Engine)	65
544J ... Loader Tractor	6.8L 413.8 (6784cc) OHV Turbo-Diesel L6 106mm Bore (PowerTech 2V)	108	550G ... Crawler Tractor	4.5L 275.8 (4522cc) OHV Turbo-Diesel L4 106mm Bore (PowerTech 2V)	66
5440 ... Harvester	6.6L 404 OHV Diesel L6 4.25" Bore (Late)	96	550H ... Wheel Tractor	4.5L 276 OHV Diesel L4 4.1875" Bore (Standard)	67
5440 ... Harvester	6.6L 404 OHV Turbo-Diesel L6 4.25" Bore (Aftercooled)	98	550H ... Crawler Tractor	4.5L 275.8 (4522cc) OHV Turbo-Diesel L4 106mm Bore (PowerTech 2V)	66
5440 ... Wheel Tractor	10.1L 619 OHV Turbo-Diesel L6 5.125" Bore	127	550J ... Crawler Tractor	4.5L 275.8 (4522cc) OHV Turbo-Diesel L4 106mm Bore (PowerTech 2V)	66
5460 ... Harvester	6.6L 404 OHV Diesel L6 4.25" Bore (Late)	96	5510 ... Wheel Tractor	4.5L 275.8 (4522cc) OHV Turbo-Diesel L4 106mm Bore (PowerTech 2V)	66
5460 ... Wheel Tractor	10.1L 619 OHV Turbo-Diesel L6 5.125" Bore	127	5510N ... Wheel Tractor	4.5L 275.8 (4522cc) OHV Turbo-Diesel L4 106mm Bore (PowerTech 2V)	66
5460 ... Forage Harvester	10.1L 619 OHV Turbo-Diesel L6 5.125" Bore	127	5515 ... Wheel Tractor	4.5L 275.8 (4522cc) OHV Turbo-Diesel L4 106mm Bore (PowerTech 2V)	66
548D ... Skidder	4.5L 276 OHV Turbo-Diesel L4 4.1875" Bore (Standard)	68	5520 ... Wheel Tractor	4.5L 275.8 (4522cc) OHV Turbo-Diesel L4 106mm Bore (PowerTech 2V)	66
548E ... Skidder	5.9L 358.4 (5876cc) OHV Turbo-Diesel L6 106mm Bore (Litre Engine)	84			

(continued on next page)

Model Index					
Model	Engine Description	Line No.	Model	Engine Description	Line No.
5520N ... Wheel Tractor	4.5L 275.8 (4522cc) OHV Turbo-Diesel L4 106mm Bore (PowerTech 2V)	66	5720 ... Forage Harvester	7.6L 466 OHV Turbo-Diesel L6 4.5625" Bore (Standard)	114
5525 ... Wheel Tractor	4.5L 275.8 (4522cc) OHV Turbo-Diesel L4 106mm Bore (PowerTech 2V)	66	5730 ... Harvester	7.6L 466 OHV Turbo-Diesel L6 4.5625" Bore (Standard)	114
5525N ... Wheel Tractor	4.5L 275.8 (4522cc) OHV Turbo-Diesel L4 106mm Bore (PowerTech 2V)	66	5820 ... Harvester	10.1L 619 OHV Turbo-Diesel L6 5.125" Bore	127
555 ... Crawler Tractor	4.5L 276 OHV Turbo-Diesel L4 4.1875" Bore (Standard)	68	5820 ... Wheel Tractor	10.1L 619 OHV Turbo-Diesel L6 5.125" Bore	127
555A ... Crawler Tractor	4.5L 276 OHV Turbo-Diesel L4 4.1875" Bore (Standard)	68	5820 ... Forage Harvester	10.1L 619 OHV Turbo-Diesel L6 5.125" Bore	127
555B ... Wheel Tractor	4.5L 276 OHV Diesel L4 4.1875" Bore (Standard)	67	5830 ... Forage Harvester	10.1L 619 OHV Turbo-Diesel L6 5.125" Bore	127
555B ... Crawler Tractor	4.5L 276 OHV Turbo-Diesel L4 4.1875" Bore (Standard)	68	590D ... Excavator	4.5L 276 OHV Turbo-Diesel L4 4.1875" Bore (Standard)	68
555G ... Crawler Tractor	4.5L 275.8 (4522cc) OHV Turbo-Diesel L4 106mm Bore (PowerTech 2V IC)	61	590D ... Excavator	4.5L 275.8 (4522cc) OHV Turbo-Diesel L4 106mm Bore (Litre Engine)	65
555G ... Crawler Tractor	4.5L 276 OHV Turbo-Diesel L4 4.1875" Bore (Standard)	68	595 ... Excavator	4.5L 276 OHV Turbo-Diesel L4 4.1875" Bore (Standard)	68
555G ... Crawler Tractor	4.5L 275.8 (4522cc) OHV Turbo-Diesel L4 106mm Bore (Litre Engine)	65	595 ... Excavator	4.5L 275.8 (4522cc) OHV Turbo-Diesel L4 106mm Bore (Litre Engine)	65
555G ... Crawler Tractor	4.5L 275.8 (4522cc) OHV Turbo-Diesel L4 106mm Bore (PowerTech 2V)	66	595D ... Excavator	4.5L 276 OHV Turbo-Diesel L4 4.1875" Bore (Standard)	68
560D ... Skidder	8.1L 495.9 (8129cc) OHV Turbo-Diesel L6 116mm Bore (PowerTech 2V IC)	118	595D ... Excavator	4.5L 275.8 (4522cc) OHV Turbo-Diesel L4 106mm Bore (Litre Engine)	65
560D ... Skidder	8.1L 495.9 (8129cc) OHV Turbo-Diesel L6 116mm Bore (PowerTech 2V AC)	119	60 ... Wheel Tractor	5.3L 321 OHV L2 5.5" Bore	76
560D ... Skidder	8.1L 495.9 (8129cc) OHV Turbo-Diesel L6 116mm Bore (PowerTech 2V)	121	600 ... Wheel Tractor	1.9L 115 OHV L4 3.5" Bore	8
5615 ... Wheel Tractor	4.5L 275.8 (4522cc) OHV Diesel L4 106mm Bore (PowerTech 2V)	64	600 ... Wheel Tractor	2.2L 135 OHV L3 3.8594" Bore	10
5620 ... Wheel Tractor	4.5L 275.8 (4522cc) OHV Diesel L4 106mm Bore (PowerTech 2V)	64	600 ... Wheel Tractor	6.6L 404 OHV Diesel L6 4.25" Bore (Early)	95
5620 ... Wheel Tractor	4.5L 275.8 (4522cc) OHV Turbo-Diesel L4 106mm Bore (PowerTech 2V)	66	600 ... Wheel Tractor	6.6L 404 OHV Diesel L6 4.25" Bore (Late)	96
570 ... Grader	5.0L 303 OHV Diesel L6 3.8594" Bore	73	600 ... Wheel Tractor	6.6L 404 OHV Diesel L6 4.25" Bore (5 Main)	97
570 ... Grader	5.4L 329 OHV Diesel L6 4.0156" Bore	78	600A ... Wheel Tractor	2.2L 135 OHV L3 3.8594" Bore	10
570 ... Grader	5.4L 329 OHV Turbo-Diesel L6 4.0156" Bore	80	6000 ... Sprayer	3.6L 219 OHV Diesel L4 4.0156" Bore	41
570A ... Grader	5.0L 303 OHV Diesel L6 3.8594" Bore	73	6000 ... Sprayer	3.9L 239 OHV Diesel L4 4.1875" Bore (Standard)	50
570A ... Grader	5.4L 329 OHV Diesel L6 4.0156" Bore	78	6030 ... Wheel Tractor	8.7L 531 OHV Diesel L6 4.75" Bore	122
570A ... Grader	5.4L 329 OHV Turbo-Diesel L6 4.0156" Bore	80	6030 ... Wheel Tractor	8.7L 531 OHV Turbo-Diesel L6 4.75" Bore	123
570B ... Grader	5.9L 358.4 (5876cc) OHV Diesel L6 106mm Bore (Litre Engine)	83	6030 ... Wheel Tractor	10.1L 619 OHV Turbo-Diesel L6 5.125" Bore	127
570B ... Grader	5.9L 358.4 (5876cc) OHV Turbo-Diesel L6 106mm Bore (Litre Engine)	84	6068DF150 ... Power Unit	6.8L 413.8 (6784cc) OHV Diesel L6 106mm Bore (PowerTech 2V)	104
570B ... Grader	5.9L 359 OHV Diesel L6 4.1875" Bore	85	6068FN ... Power Unit	6.8L 413.8 (6784cc) OHV NG L6 106mm Bore (PowerTech 2V)	105
570B ... Grader	5.9L 359 OHV Turbo-Diesel L6 4.1875" Bore	86	6068HF ... Power Unit	6.8L 413.8 (6784cc) OHV Turbo-Diesel L6 106mm Bore (PowerTech 2V IC)	102
5715 ... Wheel Tractor	4.5L 275.8 (4522cc) OHV Turbo-Diesel L4 106mm Bore (PowerTech 2V)	66	6068HFN50 ... Power Unit	6.8L 413.8 (6784cc) OHV Turbo-NG L6 106mm Bore (PowerTech 2V IC)	101
5720 ... Combine	7.6L 466 OHV Diesel L6 4.5625" Bore (Standard)	113	6068HFN51 ... Power Unit	6.8L 413.8 (6784cc) OHV Turbo-NG L6 106mm Bore (PowerTech 2V IC)	101
5720 ... Harvester	7.6L 466 OHV Turbo-Diesel L6 4.5625" Bore (Standard)	114	6068HF475 ... Power Unit	6.8L 413.8 (6784cc) OHV Turbo-Diesel L6 106mm Bore (PowerTech 4V IC)	103
			6068HF485 ... Power Unit	6.8L 413.8 (6784cc) OHV Turbo-Diesel L6 106mm Bore (PowerTech 4V IC)	103
			6068HL480 ... Power Unit	6.8L 413.8 (6784cc) OHV Turbo-Diesel L6 106mm Bore (PowerTech 4V IC)	103
			6068TF ... Power Unit	6.8L 413.8 (6784cc) OHV Turbo-Diesel L6 106mm Bore (PowerTech 2V)	108

(continued on next page)



# John Deere Off Highway

Model Index					
Model	Engine Description	Line No.	Model	Engine Description	Line No.
6068TFN ... Power Unit.....	6.8L 413.8 (6784cc) OHV Turbo-NG L6 106mm Bore (PowerTech 2V).....	107	6110L ... Wheel Tractor.....	4.5L 275.8 (4522cc) OHV Turbo-Diesel L4 106mm Bore (PowerTech 2V IC).....	61
6068TF120 ... Power Unit.....	6.8L 413.8 (6784cc) OHV Turbo-Diesel L6 106mm Bore (PowerTech 2V).....	108	6110L ... Wheel Tractor.....	4.5L 275.8 (4522cc) OHV Turbo-Diesel L4 106mm Bore (PowerTech 2V).....	66
6068TF150 ... Power Unit.....	6.8L 413.8 (6784cc) OHV Turbo-Diesel L6 106mm Bore (PowerTech 2V).....	108	6120 ... Wheel Tractor.....	4.5L 275.8 (4522cc) OHV Turbo-Diesel L4 106mm Bore (PowerTech 2V IC).....	61
6068TF151 ... Power Unit.....	6.8L 413.8 (6784cc) OHV Turbo-Diesel L6 106mm Bore (PowerTech 2V).....	108	6120 ... Wheel Tractor.....	4.5L 275.8 (4522cc) OHV Turbo-Diesel L4 106mm Bore (PowerTech 2V).....	66
6068TF158 ... Power Unit.....	6.8L 413.8 (6784cc) OHV Turbo-Diesel L6 106mm Bore (PowerTech 2V).....	108	6120L ... Wheel Tractor.....	4.5L 275.8 (4522cc) OHV Turbo-Diesel L4 106mm Bore (PowerTech 2V IC).....	61
6068TF275 ... Power Unit.....	6.8L 413.8 (6784cc) OHV Turbo-Diesel L6 106mm Bore (PowerTech 2V).....	108	6120L ... Wheel Tractor.....	4.5L 275.8 (4522cc) OHV Turbo-Diesel L4 106mm Bore (PowerTech 2V).....	66
608B ... Feller Buncher.....	8.1L 495.9 (8129cc) OHV Turbo-Diesel L6 116mm Bore (PowerTech 2V IC).....	118	6210 ... Wheel Tractor.....	4.5L 275.8 (4522cc) OHV Turbo-Diesel L4 106mm Bore (PowerTech 2V IC).....	61
608B ... Feller Buncher.....	8.1L 495.9 (8129cc) OHV Turbo-Diesel L6 116mm Bore (PowerTech 2V AC).....	119	6210 ... Wheel Tractor.....	4.5L 275.8 (4522cc) OHV Turbo-Diesel L4 106mm Bore (PowerTech 2V).....	66
608B ... Feller Buncher.....	8.1L 495.9 (8129cc) OHV Turbo-Diesel L6 116mm Bore (PowerTech 2V).....	121	6210L ... Wheel Tractor.....	4.5L 275.8 (4522cc) OHV Turbo-Diesel L4 106mm Bore (PowerTech 2V IC).....	61
608L ... Feller Buncher.....	8.1L 495.9 (8129cc) OHV Turbo-Diesel L6 116mm Bore (PowerTech 2V IC).....	118	6210L ... Wheel Tractor.....	4.5L 275.8 (4522cc) OHV Turbo-Diesel L4 106mm Bore (PowerTech 2V).....	66
608L ... Feller Buncher.....	8.1L 495.9 (8129cc) OHV Turbo-Diesel L6 116mm Bore (PowerTech 2V AC).....	119	6215 ... Wheel Tractor.....	4.5L 275.8 (4522cc) OHV Turbo-Diesel L4 106mm Bore (PowerTech 2V IC).....	61
608L ... Feller Buncher.....	8.1L 495.9 (8129cc) OHV Turbo-Diesel L6 116mm Bore (PowerTech 2V).....	121	6215 ... Wheel Tractor.....	4.5L 275.8 (4522cc) OHV Turbo-Diesel L4 106mm Bore (PowerTech 2V).....	66
608S ... Feller Buncher.....	8.1L 495.9 (8129cc) OHV Turbo-Diesel L6 116mm Bore (PowerTech 2V IC).....	118	6220 ... Wheel Tractor.....	4.5L 275.8 (4522cc) OHV Turbo-Diesel L4 106mm Bore (PowerTech 2V IC).....	61
608S ... Feller Buncher.....	8.1L 495.9 (8129cc) OHV Turbo-Diesel L6 116mm Bore (PowerTech 2V AC).....	119	6220 ... Wheel Tractor.....	4.5L 275.8 (4522cc) OHV Turbo-Diesel L4 106mm Bore (PowerTech 2V).....	66
608S ... Feller Buncher.....	8.1L 495.9 (8129cc) OHV Turbo-Diesel L6 116mm Bore (PowerTech 2V).....	121	6220L ... Wheel Tractor.....	4.5L 275.8 (4522cc) OHV Turbo-Diesel L4 106mm Bore (PowerTech 2V IC).....	61
6081AF ... Power Unit.....	8.1L 495.9 (8129cc) OHV Turbo-Diesel L6 116mm Bore (PowerTech 2V AC).....	119	6220L ... Wheel Tractor.....	4.5L 275.8 (4522cc) OHV Turbo-Diesel L4 106mm Bore (PowerTech 2V).....	66
6081HF ... Power Unit.....	8.1L 495.9 (8129cc) OHV Turbo-Diesel L6 116mm Bore (PowerTech 2V IC).....	118	6230 ... Wheel Tractor.....	4.5L 275.8 (4522cc) OHV Turbo-Diesel L4 106mm Bore (PowerTech 4V IC).....	62
6081HFN ... Power Unit.....	8.1L 495.9 (8129cc) OHV Turbo-NG L6 116mm Bore (PowerTech 2V IC).....	117	624E ... Loader.....	6.8L 414 OHV Turbo-Diesel L6 4.1875" Bore (Standard).....	110
6081HF70 ... Power Unit.....	8.1L 495.9 (8129cc) OHV Turbo-Diesel L6 116mm Bore (PowerTech 2V IC).....	118	624E ... Loader.....	6.8L 413.8 (6784cc) OHV Turbo-Diesel L6 106mm Bore (Litre Engine).....	106
6081TF ... Power Unit.....	8.1L 495.9 (8129cc) OHV Turbo-Diesel L6 116mm Bore (PowerTech 2V).....	121	624G ... Loader.....	6.8L 413.8 (6784cc) OHV Turbo-Diesel L6 106mm Bore (Litre Engine).....	106
6081TFN ... Power Unit.....	8.1L 495.9 (8129cc) OHV Turbo-NG L6 116mm Bore (PowerTech 2V).....	120	624H ... Loader Tractor.....	6.8L 413.8 (6784cc) OHV Turbo-Diesel L6 106mm Bore (PowerTech 2V IC).....	102
610B ... Backhoe.....	4.5L 276 OHV Turbo-Diesel L4 4.1875" Bore (Standard).....	68	624H ... Loader Tractor.....	6.8L 413.8 (6784cc) OHV Turbo-Diesel L6 106mm Bore (PowerTech 2V).....	108
610C ... Backhoe.....	4.5L 276 OHV Turbo-Diesel L4 4.1875" Bore (Standard).....	68	624HLL ... Forestry Tractor ...	6.8L 413.8 (6784cc) OHV Turbo-Diesel L6 106mm Bore (PowerTech 2V IC).....	102
6110 ... Wheel Tractor.....	4.5L 275.8 (4522cc) OHV Turbo-Diesel L4 106mm Bore (PowerTech 2V IC).....	61	624HLL ... Forestry Tractor ...	6.8L 413.8 (6784cc) OHV Turbo-Diesel L6 106mm Bore (PowerTech 2V).....	108
6110 ... Wheel Tractor.....	4.5L 275.8 (4522cc) OHV Turbo-Diesel L4 106mm Bore (PowerTech 2V).....	66			

(continued on next page)

Model Index					
Model	Engine Description	Line No.	Model	Engine Description	Line No.
624J ... Loader Tractor	6.8L 413.8 (6784cc) OHV Turbo-Diesel L6 106mm Bore (PowerTech 4V IC)	103	640G-II ... Forestry Tractor	6.8L 413.8 (6784cc) OHV Turbo-Diesel L6 106mm Bore (PowerTech 2V IC)	102
6250 ... Wheel Tractor	6.8L 413.8 (6784cc) OHV Diesel L6 106mm Bore (PowerTech 2V)	104	640G-II ... Logger	6.8L 413.8 (6784cc) OHV Turbo-Diesel L6 106mm Bore (PowerTech 4V IC)	103
6303D ... Power Unit	5.0L 303 OHV Diesel L6 3.8594" Bore	73	640G-II ... Forestry Tractor	6.8L 413.8 (6784cc) OHV Turbo-Diesel L6 106mm Bore (PowerTech 2V)	108
6303G ... Power Unit	5.0L 303 OHV L6 3.8594" Bore	72	640G-III ... Forestry Tractor	6.8L 413.8 (6784cc) OHV Turbo-Diesel L6 106mm Bore (PowerTech 2V IC)	102
6303G ... Power Unit	5.0L 303 OHV LPG L6 3.8594" Bore	74	640G-III ... Forestry Tractor	6.8L 413.8 (6784cc) OHV Turbo-Diesel L6 106mm Bore (PowerTech 2V)	108
6310 ... Wheel Tractor	4.5L 275.8 (4522cc) OHV Turbo-Diesel L4 106mm Bore (PowerTech 2V IC)	61	6403 ... Wheel Tractor	4.5L 275.8 (4522cc) OHV Turbo-Diesel L4 106mm Bore (PowerTech 2V IC)	61
6310 ... Wheel Tractor	4.5L 275.8 (4522cc) OHV Turbo-Diesel L4 106mm Bore (PowerTech 2V)	66	6403 ... Wheel Tractor	4.5L 275.8 (4522cc) OHV Turbo-Diesel L4 106mm Bore (PowerTech 2V)	66
6310L ... Wheel Tractor	4.5L 275.8 (4522cc) OHV Turbo-Diesel L4 106mm Bore (PowerTech 2V IC)	61	6404D ... Power Unit	6.6L 404 OHV Diesel L6 4.25" Bore (Early)	95
6310L ... Wheel Tractor	4.5L 275.8 (4522cc) OHV Turbo-Diesel L4 106mm Bore (PowerTech 2V)	66	6404D ... Power Unit	6.6L 404 OHV Diesel L6 4.25" Bore (Late)	96
6310S ... Wheel Tractor	4.5L 275.8 (4522cc) OHV Turbo-Diesel L4 106mm Bore (PowerTech 2V IC)	61	6405 ... Wheel Tractor	3.6L 219 OHV Diesel L4 4.0156" Bore	41
6310S ... Wheel Tractor	4.5L 275.8 (4522cc) OHV Turbo-Diesel L4 106mm Bore (PowerTech 2V)	66	6405 ... Wheel Tractor	4.5L 275.8 (4522cc) OHV Turbo-Diesel L4 106mm Bore (PowerTech 2V IC)	61
6320 ... Wheel Tractor	4.5L 275.8 (4522cc) OHV Turbo-Diesel L4 106mm Bore (PowerTech 2V IC)	61	6405 ... Wheel Tractor	4.5L 276 OHV Diesel L4 4.1875" Bore (Standard)	67
6320 ... Wheel Tractor	4.5L 275.8 (4522cc) OHV Turbo-Diesel L4 106mm Bore (PowerTech 4V IC)	62	6405 ... Wheel Tractor	4.5L 276 OHV Turbo-Diesel L4 4.1875" Bore (Standard)	68
6320 ... Wheel Tractor	4.5L 275.8 (4522cc) OHV Turbo-Diesel L4 106mm Bore (PowerTech 2V)	66	6405 ... Wheel Tractor	4.5L 275.8 (4522cc) OHV Turbo-Diesel L4 106mm Bore (PowerTech 2V)	66
6320L ... Wheel Tractor	4.5L 275.8 (4522cc) OHV Turbo-Diesel L4 106mm Bore (PowerTech 2V IC)	61	6410 ... Wheel Tractor	4.5L 275.8 (4522cc) OHV Turbo-Diesel L4 106mm Bore (PowerTech 2V IC)	61
6320L ... Wheel Tractor	4.5L 275.8 (4522cc) OHV Turbo-Diesel L4 106mm Bore (PowerTech 2V)	66	6410 ... Wheel Tractor	4.5L 276 OHV Diesel L4 4.1875" Bore (Standard)	67
6329D ... Power Unit	5.4L 329 OHV Diesel L6 4.0156" Bore	78	6410 ... Wheel Tractor	4.5L 276 OHV Turbo-Diesel L4 4.1875" Bore (Standard)	68
6329G ... Power Unit	5.4L 329 OHV L6 4.0156" Bore	77	6410 ... Wheel Tractor	4.5L 275.8 (4522cc) OHV Turbo-Diesel L4 106mm Bore (PowerTech 2V)	66
6329G ... Power Unit	5.4L 329 OHV LPG L6 4.0156" Bore	79	6410L ... Wheel Tractor	4.5L 275.8 (4522cc) OHV Turbo-Diesel L4 106mm Bore (PowerTech 2V IC)	61
6330 ... Wheel Tractor	4.5L 275.8 (4522cc) OHV Turbo-Diesel L4 106mm Bore (PowerTech 4V IC)	62	6410L ... Wheel Tractor	4.5L 275.8 (4522cc) OHV Turbo-Diesel L4 106mm Bore (PowerTech 2V)	66
6341G ... Power Unit	5.6L 340 OHV L6 4.25" Bore	81	6410S ... Wheel Tractor	4.5L 275.8 (4522cc) OHV Turbo-Diesel L4 106mm Bore (PowerTech 2V IC)	61
6362G ... Power Unit	5.9L 362 OHV L6 4.25" Bore	87	6410S ... Wheel Tractor	4.5L 275.8 (4522cc) OHV Turbo-Diesel L4 106mm Bore (PowerTech 2V)	66
6381D ... Power Unit	6.2L 381 OHV Diesel L6 4.125" Bore	94	6415 ... Wheel Tractor	3.6L 219 OHV Diesel L4 4.0156" Bore	41
640 ... Skidder	6.8L 414 OHV Turbo-Diesel L6 4.1875" Bore (Standard)	110	6415 ... Wheel Tractor	4.5L 275.8 (4522cc) OHV Turbo-Diesel L4 106mm Bore (PowerTech 2V IC)	61
640D ... Skidder	6.8L 414 OHV Turbo-Diesel L6 4.1875" Bore (Standard)	110	6415 ... Wheel Tractor	4.5L 276 OHV Diesel L4 4.1875" Bore (Standard)	67
640E ... Skidder	6.8L 413.8 (6784cc) OHV Turbo-Diesel L6 106mm Bore (Litre Engine)	106	6415 ... Wheel Tractor	4.5L 276 OHV Turbo-Diesel L4 4.1875" Bore (Standard)	68
640G ... Forestry Tractor	6.8L 413.8 (6784cc) OHV Turbo-Diesel L6 106mm Bore (PowerTech 2V IC)	102	6415 ... Wheel Tractor	4.5L 275.8 (4522cc) OHV Turbo-Diesel L4 106mm Bore (PowerTech 2V)	66
640G ... Skidder	6.8L 413.8 (6784cc) OHV Turbo-Diesel L6 106mm Bore (Litre Engine)	106			
640G ... Forestry Tractor	6.8L 413.8 (6784cc) OHV Turbo-Diesel L6 106mm Bore (PowerTech 2V)	108			

(continued on next page)





# John Deere Off Highway

Model Index					
Model	Engine Description	Line No.	Model	Engine Description	Line No.
6420 ... Wheel Tractor	4.5L 275.8 (4522cc) OHV Turbo-Diesel L4 106mm Bore (PowerTech 2V IC)	61	644G ... Loader Tractor	8.1L 495.9 (8129cc) OHV Turbo-Diesel L6 116mm Bore (PowerTech 2V)	121
6420 ... Wheel Tractor	4.5L 275.8 (4522cc) OHV Turbo-Diesel L4 106mm Bore (PowerTech 4V IC)	62	644H ... Loader Tractor	8.1L 495.9 (8129cc) OHV Turbo-Diesel L6 116mm Bore (PowerTech 2V IC)	118
6420 ... Wheel Tractor	4.5L 275.8 (4522cc) OHV Turbo-Diesel L4 106mm Bore (PowerTech 2V)	66	644H ... Loader Tractor	8.1L 495.9 (8129cc) OHV Turbo-Diesel L6 116mm Bore (PowerTech 2V AC)	119
6420L ... Wheel Tractor	4.5L 275.8 (4522cc) OHV Turbo-Diesel L4 106mm Bore (PowerTech 2V IC)	61	644H ... Loader Tractor	8.1L 495.9 (8129cc) OHV Turbo-Diesel L6 116mm Bore (PowerTech 2V)	121
6420L ... Wheel Tractor	4.5L 275.8 (4522cc) OHV Turbo-Diesel L4 106mm Bore (PowerTech 2V)	66	644J ... Loader Tractor	8.1L 495.9 (8129cc) OHV Turbo-Diesel L6 116mm Bore (PowerTech 2V IC)	118
6420S ... Wheel Tractor	4.5L 275.8 (4522cc) OHV Turbo-Diesel L4 106mm Bore (PowerTech 2V IC)	61	644J ... Loader Tractor	8.1L 495.9 (8129cc) OHV Turbo-Diesel L6 116mm Bore (PowerTech 2V AC)	119
6420S ... Wheel Tractor	4.5L 275.8 (4522cc) OHV Turbo-Diesel L4 106mm Bore (PowerTech 4V IC)	62	644J ... Loader Tractor	8.1L 495.9 (8129cc) OHV Turbo-Diesel L6 116mm Bore (PowerTech 2V)	121
6420S ... Wheel Tractor	4.5L 275.8 (4522cc) OHV Turbo-Diesel L4 106mm Bore (PowerTech 2V)	66	646 ... Compactor	6.6L 404 OHV Turbo-Diesel L6 4.25" Bore (Aftercooled)	98
643 ... Feller Buncher	6.8L 414 OHV Turbo-Diesel L6 4.1875" Bore (Standard)	110	646A ... Compactor	6.6L 404 OHV Turbo-Diesel L6 4.25" Bore (Aftercooled)	98
643 ... Feller Buncher	6.8L 413.8 (6784cc) OHV Turbo-Diesel L6 106mm Bore (Litre Engine)	106	646B ... Compactor	8.7L 531 OHV Turbo-Diesel L6 4.75" Bore	123
643D ... Feller Buncher	6.8L 414 OHV Turbo-Diesel L6 4.1875" Bore (Standard)	110	646C ... Compactor	7.6L 466 OHV Turbo-Diesel L6 4.5625" Bore (Standard)	114
643D ... Feller Buncher	6.8L 413.8 (6784cc) OHV Turbo-Diesel L6 106mm Bore (Litre Engine)	106	648D ... Skidder	6.8L 414 OHV Turbo-Diesel L6 4.1875" Bore (Standard)	110
643G ... Forestry Tractor	6.8L 413.8 (6784cc) OHV Turbo-Diesel L6 106mm Bore (PowerTech 2V IC)	102	648E ... Skidder	6.8L 413.8 (6784cc) OHV Turbo-Diesel L6 106mm Bore (Litre Engine)	106
643G ... Forestry Tractor	6.8L 413.8 (6784cc) OHV Turbo-Diesel L6 106mm Bore (PowerTech 2V)	108	648G ... Forestry Tractor	6.8L 413.8 (6784cc) OHV Turbo-Diesel L6 106mm Bore (PowerTech 2V IC)	102
643H ... Forestry Tractor	6.8L 413.8 (6784cc) OHV Turbo-Diesel L6 106mm Bore (PowerTech 2V IC)	102	648G ... Skidder	6.8L 413.8 (6784cc) OHV Turbo-Diesel L6 106mm Bore (Litre Engine)	106
643H ... Forestry Tractor	6.8L 413.8 (6784cc) OHV Turbo-Diesel L6 106mm Bore (PowerTech 2V)	108	648G ... Forestry Tractor	6.8L 413.8 (6784cc) OHV Turbo-Diesel L6 106mm Bore (PowerTech 2V)	108
643J ... Feller Buncher	6.8L 413.8 (6784cc) OHV Turbo-Diesel L6 106mm Bore (PowerTech 4V IC)	103	648G-II ... Forestry Tractor	6.8L 413.8 (6784cc) OHV Turbo-Diesel L6 106mm Bore (PowerTech 2V IC)	102
6430 ... Wheel Tractor	4.5L 275.8 (4522cc) OHV Turbo-Diesel L4 106mm Bore (PowerTech 4V IC)	62	648G-II ... Logger	6.8L 413.8 (6784cc) OHV Turbo-Diesel L6 106mm Bore (PowerTech 4V IC)	103
644 ... Loader	6.6L 404 OHV Turbo-Diesel L6 4.25" Bore (Aftercooled)	98	648G-II ... Forestry Tractor	6.8L 413.8 (6784cc) OHV Turbo-Diesel L6 106mm Bore (PowerTech 2V)	108
644A ... Loader	6.6L 404 OHV Turbo-Diesel L6 4.25" Bore (Aftercooled)	98	648G-III ... Forestry Tractor	6.8L 413.8 (6784cc) OHV Turbo-Diesel L6 106mm Bore (PowerTech 2V IC)	102
644B ... Loader	8.7L 531 OHV Turbo-Diesel L6 4.75" Bore	123	648G-III ... Forestry Tractor	6.8L 413.8 (6784cc) OHV Turbo-Diesel L6 106mm Bore (PowerTech 2V)	108
644C ... Loader	7.6L 466 OHV Turbo-Diesel L6 4.5625" Bore (Standard)	114	65 ... Combine	3.6L 217 OHV L6 3.625" Bore	39
644D ... Loader	7.6L 466 OHV Turbo-Diesel L6 4.5625" Bore (Standard)	114	65 ... Combine	3.8L 230 L-HEAD L6 3.4375" Bore (Hercules Eng.)	48
644E ... Loader	7.6L 465.9 (7638cc) OHV Turbo-Diesel L6 115mm Bore (Litre Engine)	116	650G ... Crawler Tractor	4.5L 275.8 (4522cc) OHV Turbo-Diesel L4 106mm Bore (PowerTech 2V IC)	61
644G ... Loader Tractor	8.1L 495.9 (8129cc) OHV Turbo-Diesel L6 116mm Bore (PowerTech 2V IC)	118	650G ... Crawler Tractor	4.5L 276 OHV Turbo-Diesel L4 4.1875" Bore (Standard)	68
644G ... Loader Tractor	8.1L 495.9 (8129cc) OHV Turbo-Diesel L6 116mm Bore (PowerTech 2V AC)	119	650G ... Crawler Tractor	4.5L 275.8 (4522cc) OHV Turbo-Diesel L4 106mm Bore (Litre Engine)	65
			650G ... Crawler Tractor	4.5L 275.8 (4522cc) OHV Turbo-Diesel L4 106mm Bore (PowerTech 2V)	66

(continued on next page)

Model Index					
Model	Engine Description	Line No.	Model	Engine Description	Line No.
650H ... Crawler Tractor	4.5L 275.8 (4522cc) OHV Turbo-Diesel L4 106mm Bore (PowerTech 2V)	66	660D ... Skidder	8.1L 495.9 (8129cc) OHV Turbo-Diesel L6 116mm Bore (PowerTech 2V AC)	119
650J ... Crawler Tractor	4.5L 275.8 (4522cc) OHV Turbo-Diesel L4 106mm Bore (PowerTech 2V)	66	660D ... Skidder	8.1L 495.9 (8129cc) OHV Turbo-Diesel L6 116mm Bore (PowerTech 2V)	121
6500 ... Sprayer	3.9L 239 (3917cc) OHV Turbo-Diesel L4 106mm Bore (Litre Engine)	53	6600 ... Combine	2.7L 164 OHV Diesel L3 4.0156" Bore	23
6505 ... Crawler Tractor	6.8L 414 OHV Diesel L6 4.1875" Bore (Standard)	109	6600 ... Combine	3.6L 219 OHV L4 4.0156" Bore	40
6505 ... Loader Tractor	6.8L 414 OHV Diesel L6 4.1875" Bore (Standard)	109	6600 ... Combine	5.0L 303 OHV L6 3.8594" Bore	72
6510L ... Wheel Tractor	4.5L 275.8 (4522cc) OHV Turbo-Diesel L4 106mm Bore (PowerTech 2V IC)	61	6600 ... Wheel Tractor	5.0L 303 OHV L6 3.8594" Bore	72
6510L ... Wheel Tractor	4.5L 275.8 (4522cc) OHV Turbo-Diesel L4 106mm Bore (PowerTech 2V)	66	6600 ... Combine	5.0L 303 OHV Diesel L6 3.8594" Bore	73
6510S ... Wheel Tractor	4.5L 275.8 (4522cc) OHV Turbo-Diesel L4 106mm Bore (PowerTech 2V IC)	61	6600 ... Combine	5.0L 303 OHV LPG L6 3.8594" Bore	74
6510S ... Wheel Tractor	4.5L 275.8 (4522cc) OHV Turbo-Diesel L4 106mm Bore (PowerTech 2V)	66	6600 ... Wheel Tractor	5.0L 303 OHV LPG L6 3.8594" Bore	74
6520 ... Wheel Tractor	6.8L 413.8 (6784cc) OHV Turbo-Diesel L6 106mm Bore (PowerTech 4V IC)	103	6600 ... Combine	5.4L 329 OHV L6 4.0156" Bore	77
6520 ... Crawler Tractor	6.8L 414 OHV Diesel L6 4.1875" Bore (Standard)	109	6600 ... Combine	5.4L 329 OHV Diesel L6 4.0156" Bore	78
6520 ... Loader Tractor	6.8L 414 OHV Diesel L6 4.1875" Bore (Standard)	109	6600 ... Combine	5.4L 329 OHV LPG L6 4.0156" Bore	79
6520L ... Wheel Tractor	4.5L 275.8 (4522cc) OHV Turbo-Diesel L4 106mm Bore (PowerTech 2V IC)	61	6600 ... Combine	6.6L 404 OHV Diesel L6 4.25" Bore (Early)	95
6520L ... Wheel Tractor	4.5L 275.8 (4522cc) OHV Turbo-Diesel L4 106mm Bore (PowerTech 2V)	66	6602 ... Combine	5.9L 362 OHV L6 4.25" Bore	87
653E ... Forestry Tractor	6.8L 413.8 (6784cc) OHV Turbo-Diesel L6 106mm Bore (PowerTech 2V IC)	102	6602 ... Wheel Tractor	5.9L 362 OHV L6 4.25" Bore	87
653E ... Forestry Tractor	6.8L 413.8 (6784cc) OHV Turbo-Diesel L6 106mm Bore (PowerTech 2V)	108	6602 ... Wheel Tractor	5.9L 362 OHV LPG L6 4.25" Bore	88
653G ... Forestry Tractor	6.8L 413.8 (6784cc) OHV Turbo-Diesel L6 106mm Bore (PowerTech 2V IC)	102	6602 ... Wheel Tractor	5.9L 362 OHV NG L6 4.25" Bore	89
653G ... Forestry Tractor	6.8L 413.8 (6784cc) OHV Turbo-Diesel L6 106mm Bore (PowerTech 2V)	108	6602 ... Combine	6.6L 404 OHV Diesel L6 4.25" Bore (Late)	96
6530 ... Wheel Tractor	6.8L 413.8 (6784cc) OHV Turbo-Diesel L6 106mm Bore (PowerTech 4V IC)	103	6602 ... Combine	6.6L 404 OHV Turbo-Diesel L6 4.25" Bore (Aftercooled)	98
6540 ... Wheel Tractor	10.1L 619 OHV Turbo-Diesel L6 5.125" Bore	127	6602 ... Combine	7.6L 466 OHV Diesel L6 4.5625" Bore (Standard)	113
6545 ... Wheel Tractor	10.1L 619 OHV Turbo-Diesel L6 5.125" Bore	127	6602 ... Combine	7.6L 466 OHV Turbo-Diesel L6 4.5625" Bore (Standard)	114
655 ... Crawler Tractor	6.8L 414 OHV Turbo-Diesel L6 4.1875" Bore (Standard)	110	6603 ... Wheel Tractor	6.8L 413.8 (6784cc) OHV Turbo-Diesel L6 106mm Bore (PowerTech 2V)	108
655B ... Crawler Tractor	6.8L 414 OHV Turbo-Diesel L6 4.1875" Bore (Standard)	110	6605 ... Wheel Tractor	6.8L 413.8 (6784cc) OHV Turbo-Diesel L6 106mm Bore (PowerTech 2V IC)	102
655B ... Loader Tractor	6.8L 414 OHV Turbo-Diesel L6 4.1875" Bore (Standard)	110	6605 ... Wheel Tractor	6.8L 413.8 (6784cc) OHV Turbo-Diesel L6 106mm Bore (PowerTech 2V)	108
655B ... Crawler Tractor	6.8L 413.8 (6784cc) OHV Turbo-Diesel L6 106mm Bore (Litre Engine)	106	6610 ... Forage Harvester	8.1L 495.9 (8129cc) OHV Turbo-Diesel L6 116mm Bore (PowerTech 2V IC)	118
66-10 Cut ... Combine	2.2L 133 L-HEAD L4 3.25" Bore (Hercules Eng.)	9	6610 ... Forage Harvester	8.1L 495.9 (8129cc) OHV Turbo-Diesel L6 116mm Bore (PowerTech 2V AC)	119
660D ... Skidder	8.1L 495.9 (8129cc) OHV Turbo-Diesel L6 116mm Bore (PowerTech 2V IC)	118	6615 ... Wheel Tractor	6.8L 413.8 (6784cc) OHV Turbo-Diesel L6 106mm Bore (PowerTech 2V IC)	102
			6615 ... Wheel Tractor	6.8L 413.8 (6784cc) OHV Turbo-Diesel L6 106mm Bore (PowerTech 2V)	108
			6620 ... Wheel Tractor	6.8L 413.8 (6784cc) OHV Turbo-Diesel L6 106mm Bore (PowerTech 4V IC)	103
			6620 ... Combine	7.6L 466 OHV Diesel L6 4.5625" Bore (Standard)	113
			6620 ... Combine	7.6L 466 OHV Turbo-Diesel L6 4.5625" Bore (Standard)	114
			6620 ... Harvester	7.6L 466 OHV Turbo-Diesel L6 4.5625" Bore (Standard)	114
			6622 ... Combine	7.6L 466 OHV Diesel L6 4.5625" Bore (Standard)	113
			6622 ... Combine	7.6L 466 OHV Turbo-Diesel L6 4.5625" Bore (Standard)	114
			6622 ... Harvester	7.6L 466 OHV Turbo-Diesel L6 4.5625" Bore (Standard)	114



# John Deere Off Highway

Model Index					
Model	Engine Description	Line No.	Model	Engine Description	Line No.
6630 ... Wheel Tractor	6.8L 413.8 (6784cc) OHV Turbo-Diesel L6 106mm Bore (PowerTech 4V IC)	103	672CH-II ... Grader	6.8L 413.8 (6784cc) OHV Turbo-Diesel L6 106mm Bore (PowerTech 2V)	108
6650 ... Forage Harvester	8.1L 495.9 (8129cc) OHV Turbo-Diesel L6 116mm Bore (PowerTech 2V IC)	118	672D ... Grader	6.8L 413.8 (6784cc) OHV Turbo-Diesel L6 106mm Bore (PowerTech 4V IC)	103
6650 ... Forage Harvester	8.1L 495.9 (8129cc) OHV Turbo-Diesel L6 116mm Bore (PowerTech 2V AC)	119	6820 ... Wheel Tractor	6.8L 413.8 (6784cc) OHV Turbo-Diesel L6 106mm Bore (PowerTech 4V IC)	103
67R ... Combine	3.6L 217 OHV L6 3.625" Bore	39	6830 ... Wheel Tractor	6.8L 413.8 (6784cc) OHV Turbo-Diesel L6 106mm Bore (PowerTech 4V IC)	103
670 ... Grader	6.8L 414 OHV Turbo-Diesel L6 4.1875" Bore (Standard)	110	690 ... Excavator	6.6L 404 OHV Turbo-Diesel L6 4.25" Bore (Aftercooled)	98
670A ... Grader	6.8L 414 OHV Turbo-Diesel L6 4.1875" Bore (Standard)	110	690A ... Excavator	6.6L 404 OHV Turbo-Diesel L6 4.25" Bore (Aftercooled)	98
670B ... Grader	6.8L 414 OHV Turbo-Diesel L6 4.1875" Bore (Standard)	110	690B ... Wheel Tractor	6.6L 404 OHV Diesel L6 4.25" Bore (Early)	95
670C ... Grader	6.8L 413.8 (6784cc) OHV Turbo-Diesel L6 106mm Bore (PowerTech 2V IC)	102	690B ... Wheel Tractor	6.6L 404 OHV Diesel L6 4.25" Bore (Late)	96
670C ... Grader	6.8L 413.8 (6784cc) OHV Turbo-Diesel L6 106mm Bore (PowerTech 2V)	108	690B ... Excavator	6.6L 404 OHV Turbo-Diesel L6 4.25" Bore (Aftercooled)	98
670C-II ... Grader	6.8L 413.8 (6784cc) OHV Turbo-Diesel L6 106mm Bore (PowerTech 2V IC)	102	690C ... Excavator	7.6L 466 OHV Turbo-Diesel L6 4.5625" Bore (Standard)	114
670C-II ... Grader	6.8L 413.8 (6784cc) OHV Turbo-Diesel L6 106mm Bore (PowerTech 2V)	108	690D ... Excavator	6.8L 414 OHV Turbo-Diesel L6 4.1875" Bore (Standard)	110
670CH ... Grader	6.8L 413.8 (6784cc) OHV Turbo-Diesel L6 106mm Bore (PowerTech 2V IC)	102	690D ... Excavator	6.8L 413.8 (6784cc) OHV Turbo-Diesel L6 106mm Bore (Litre Engine)	106
670CH ... Grader	6.8L 413.8 (6784cc) OHV Turbo-Diesel L6 106mm Bore (PowerTech 2V)	108	690E ... Excavator	6.8L 413.8 (6784cc) OHV Turbo-Diesel L6 106mm Bore (Litre Engine)	106
670CH-II ... Grader	6.8L 413.8 (6784cc) OHV Turbo-Diesel L6 106mm Bore (PowerTech 2V IC)	102	690ELC ... Excavator	6.8L 413.8 (6784cc) OHV Turbo-Diesel L6 106mm Bore (PowerTech 2V IC)	102
670CH-II ... Grader	6.8L 413.8 (6784cc) OHV Turbo-Diesel L6 106mm Bore (PowerTech 2V)	108	690ELC ... Excavator	6.8L 413.8 (6784cc) OHV Turbo-Diesel L6 106mm Bore (PowerTech 2V)	108
670CH-II ... Grader	6.8L 413.8 (6784cc) OHV Turbo-Diesel L6 106mm Bore (PowerTech 4V IC)	103	6920 ... Wheel Tractor	6.8L 413.8 (6784cc) OHV Turbo-Diesel L6 106mm Bore (PowerTech 4V IC)	103
670CH-II ... Grader	6.8L 413.8 (6784cc) OHV Turbo-Diesel L6 106mm Bore (PowerTech 2V)	108	6920S ... Wheel Tractor	6.8L 413.8 (6784cc) OHV Turbo-Diesel L6 106mm Bore (PowerTech 4V IC)	103
670D ... Grader	6.8L 413.8 (6784cc) OHV Turbo-Diesel L6 106mm Bore (PowerTech 4V IC)	103	693B ... Feller Buncher	6.6L 404 OHV Turbo-Diesel L6 4.25" Bore (Aftercooled)	98
6700 ... Sprayer	4.5L 275.8 (4522cc) OHV Turbo-Diesel L4 106mm Bore (PowerTech 2V)	66	693C ... Feller Buncher	7.6L 466 OHV Turbo-Diesel L6 4.5625" Bore (Standard)	114
6715 ... Wheel Tractor	6.8L 413.8 (6784cc) OHV Turbo-Diesel L6 106mm Bore (PowerTech 2V IC)	102	693D ... Feller Buncher	6.8L 414 OHV Turbo-Diesel L6 4.1875" Bore (Standard)	110
6715 ... Wheel Tractor	6.8L 413.8 (6784cc) OHV Turbo-Diesel L6 106mm Bore (PowerTech 2V)	108	693D ... Feller Buncher	6.8L 413.8 (6784cc) OHV Turbo-Diesel L6 106mm Bore (Litre Engine)	106
672A ... Grader	6.8L 414 OHV Turbo-Diesel L6 4.1875" Bore (Standard)	110	6930 ... Wheel Tractor	6.8L 413.8 (6784cc) OHV Turbo-Diesel L6 106mm Bore (PowerTech 4V IC)	103
672B ... Grader	6.8L 414 OHV Turbo-Diesel L6 4.1875" Bore (Standard)	110	6950 ... Harvester	14.0L 855 OHV Turbo-Diesel L6 5.5" Bore (Cummins Eng.)	130
672CH ... Grader	6.8L 413.8 (6784cc) OHV Turbo-Diesel L6 106mm Bore (PowerTech 2V IC)	102	6950 ... Forage Harvester	14.0L 855 OHV Turbo-Diesel L6 5.5" Bore (Cummins Eng.)	130
672CH ... Grader	6.8L 413.8 (6784cc) OHV Turbo-Diesel L6 106mm Bore (PowerTech 2V)	108	699 ... Combine	5.0L 303 OHV L6 3.8594" Bore	72
672CH-II ... Grader	6.8L 413.8 (6784cc) OHV Turbo-Diesel L6 106mm Bore (PowerTech 2V IC)	102	699 ... Cotton Picker	5.0L 303 OHV L6 3.8594" Bore	72
672CH-II ... Grader	6.8L 413.8 (6784cc) OHV Turbo-Diesel L6 106mm Bore (PowerTech 2V)	108	699 ... Combine	5.0L 303 OHV Diesel L6 3.8594" Bore	73
672CH-II ... Grader	6.8L 413.8 (6784cc) OHV Turbo-Diesel L6 106mm Bore (PowerTech 2V IC)	102	699 ... Cotton Picker	5.0L 303 OHV Diesel L6 3.8594" Bore	73
672CH-II ... Grader	6.8L 413.8 (6784cc) OHV Turbo-Diesel L6 106mm Bore (PowerTech 4V IC)	103	699 ... Combine	5.0L 303 OHV LPG L6 3.8594" Bore	74
			699 ... Cotton Picker	5.0L 303 OHV LPG L6 3.8594" Bore	74
			699 ... Cotton Picker	5.4L 329 OHV L6 4.0156" Bore	77
			699 ... Combine	5.4L 329 OHV Diesel L6 4.0156" Bore	78

(continued on next page)



Model Index					
Model	Engine Description	Line No.	Model	Engine Description	Line No.
699 ... Cotton Picker	5.4L 329 OHV Diesel L6 4.0156" Bore	78	7220 ... Wheel Tractor	6.8L 413.8 (6784cc) OHV Turbo-Diesel L6 106mm Bore (PowerTech 4V IC)	103
699 ... Cotton Picker	5.4L 329 OHV LPG L6 4.0156" Bore	79	7220 ... Wheel Tractor	6.8L 413.8 (6784cc) OHV Turbo-Diesel L6 106mm Bore (PowerTech 2V)	108
70 ... Excavator	3.9L 239 OHV Diesel L4 4.1875" Bore (Standard)	50	724J ... Loader Tractor	8.1L 495.9 (8129cc) OHV Turbo-Diesel L6 116mm Bore (PowerTech 2V IC)	118
70D ... Excavator	3.9L 239 OHV Diesel L4 4.1875" Bore (Standard)	50	724J ... Loader Tractor	8.1L 495.9 (8129cc) OHV Turbo-Diesel L6 116mm Bore (PowerTech 2V AC)	119
700 ... Wheel Tractor	1.9L 115 OHV L4 3.5" Bore	8	724J ... Loader Tractor	8.1L 495.9 (8129cc) OHV Turbo-Diesel L6 116mm Bore (PowerTech 2V)	121
700 ... Wheel Tractor	2.2L 135 OHV L3 3.8594" Bore	10	7320 ... Wheel Tractor	6.8L 413.8 (6784cc) OHV Turbo-Diesel L6 106mm Bore (PowerTech 2V IC)	102
700H ... Crawler Tractor	6.8L 413.8 (6784cc) OHV Turbo-Diesel L6 106mm Bore (PowerTech 2V)	108	7320 ... Wheel Tractor	6.8L 413.8 (6784cc) OHV Turbo-Diesel L6 106mm Bore (PowerTech 2V IC)	102
700J ... Crawler Tractor	6.8L 413.8 (6784cc) OHV Turbo-Diesel L6 106mm Bore (PowerTech 2V IC)	102	7320 ... Wheel Tractor	6.8L 413.8 (6784cc) OHV Turbo-Diesel L6 106mm Bore (PowerTech 4V IC)	103
700J ... Crawler Tractor	6.8L 413.8 (6784cc) OHV Turbo-Diesel L6 106mm Bore (PowerTech 2V)	108	7320 ... Wheel Tractor	6.8L 413.8 (6784cc) OHV Turbo-Diesel L6 106mm Bore (PowerTech 2V)	108
7020 ... Wheel Tractor	6.6L 404 OHV Diesel L6 4.25" Bore (Early)	95	7320 ... Wheel Tractor	6.8L 413.8 (6784cc) OHV Turbo-Diesel L6 106mm Bore (PowerTech 2V)	108
7020 ... Wheel Tractor	6.6L 404 OHV Diesel L6 4.25" Bore (Late)	96	734 ... Wheel Tractor	2.2L 135 OHV L3 3.8594" Bore	10
7020 ... Wheel Tractor	6.6L 404 OHV Turbo-Diesel L6 4.25" Bore (Aftercooled)	98	740 ... Skidder	6.6L 404 OHV Turbo-Diesel L6 4.25" Bore (Aftercooled)	98
703G ... Feller Buncher	8.1L 495.9 (8129cc) OHV Turbo-Diesel L6 116mm Bore (PowerTech 2V IC)	118	740 ... Forestry Tractor	6.8L 413.8 (6784cc) OHV Turbo-Diesel L6 106mm Bore (PowerTech 2V IC)	102
703G ... Feller Buncher	8.1L 495.9 (8129cc) OHV Turbo-Diesel L6 116mm Bore (PowerTech 2V AC)	119	740 ... Forestry Tractor	6.8L 413.8 (6784cc) OHV Turbo-Diesel L6 106mm Bore (PowerTech 2V)	108
703G ... Feller Buncher	8.1L 495.9 (8129cc) OHV Turbo-Diesel L6 116mm Bore (PowerTech 2V)	121	740A ... Skidder	6.6L 404 OHV Turbo-Diesel L6 4.25" Bore (Aftercooled)	98
710B ... Wheel Tractor	5.4L 329 OHV Diesel L6 4.0156" Bore	78	740E ... Skidder	7.6L 465.9 (7638cc) OHV Turbo-Diesel L6 115mm Bore (Litre Engine)	116
710B ... Backhoe	5.4L 329 OHV Turbo-Diesel L6 4.0156" Bore	80	740G ... Skidder	8.1L 495.9 (8129cc) OHV Turbo-Diesel L6 116mm Bore (PowerTech 2V IC)	118
710B ... Backhoe	5.9L 359 OHV Turbo-Diesel L6 4.1875" Bore	86	740G ... Skidder	8.1L 495.9 (8129cc) OHV Turbo-Diesel L6 116mm Bore (PowerTech 2V AC)	119
710C ... Backhoe	5.9L 359 OHV Turbo-Diesel L6 4.1875" Bore	86	740G ... Skidder	8.1L 495.9 (8129cc) OHV Turbo-Diesel L6 116mm Bore (PowerTech 2V)	121
710D ... Backhoe	6.8L 413.8 (6784cc) OHV Turbo-Diesel L6 106mm Bore (PowerTech 2V IC)	102	740G-II ... Skidder	8.1L 495.9 (8129cc) OHV Turbo-Diesel L6 116mm Bore (PowerTech 2V)	121
710D ... Backhoe	6.8L 413.8 (6784cc) OHV Turbo-Diesel L6 106mm Bore (PowerTech 2V)	108	7405 ... Wheel Tractor	6.8L 413.8 (6784cc) OHV Turbo-Diesel L6 106mm Bore (PowerTech 2V IC)	102
710G ... Backhoe	6.8L 413.8 (6784cc) OHV Turbo-Diesel L6 106mm Bore (PowerTech 2V IC)	102	7405 ... Wheel Tractor	6.8L 413.8 (6784cc) OHV Turbo-Diesel L6 106mm Bore (PowerTech 2V)	108
710G ... Backhoe	6.8L 413.8 (6784cc) OHV Turbo-Diesel L6 106mm Bore (PowerTech 2V)	108	7410 ... Wheel Tractor	6.8L 413.8 (6784cc) OHV Turbo-Diesel L6 106mm Bore (PowerTech 2V IC)	102
72-74 ... Harvester	2.5L 154 L-HEAD V4 3.5" Bore (Wisconsin Eng.)	19	7410 ... Wheel Tractor	6.8L 413.8 (6784cc) OHV Turbo-Diesel L6 106mm Bore (PowerTech 2V)	108
7200 ... Forage Harvester	8.1L 495.9 (8129cc) OHV Turbo-Diesel L6 116mm Bore (PowerTech 2V IC)	118	7420 ... Wheel Tractor	6.8L 413.8 (6784cc) OHV Turbo-Diesel L6 106mm Bore (PowerTech 2V IC)	102
7200 ... Forage Harvester	8.1L 495.9 (8129cc) OHV Turbo-Diesel L6 116mm Bore (PowerTech 2V AC)	119	7420 ... Wheel Tractor	6.8L 413.8 (6784cc) OHV Turbo-Diesel L6 106mm Bore (PowerTech 4V IC)	103
7210 ... Wheel Tractor	6.8L 413.8 (6784cc) OHV Turbo-Diesel L6 106mm Bore (PowerTech 2V IC)	102	7420 ... Wheel Tractor	6.8L 413.8 (6784cc) OHV Turbo-Diesel L6 106mm Bore (PowerTech 2V)	108
7210 ... Wheel Tractor	6.8L 413.8 (6784cc) OHV Turbo-Diesel L6 106mm Bore (PowerTech 2V)	108	7420 ... Wheel Tractor	6.8L 413.8 (6784cc) OHV Turbo-Diesel L6 106mm Bore (PowerTech 2V)	108
7220 ... Wheel Tractor	6.8L 413.8 (6784cc) OHV Turbo-Diesel L6 106mm Bore (PowerTech 2V IC)	102	743 ... Feller Buncher	7.6L 466 OHV Turbo-Diesel L6 4.5625" Bore (Standard)	114

(continued on next page)



# John Deere Off Highway

Model Index					
Model	Engine Description	Line No.	Model	Engine Description	Line No.
743A ... Feller Buncher.....	7.6L 466 OHV Turbo-Diesel L6 4.5625" Bore (Standard).....	114	7500 ... Wheel Tractor.....	6.8L 413.8 (6784cc) OHV Turbo-Diesel L6 106mm Bore (PowerTech 2V IC).....	102
7440 ... Cotton Picker.....	5.9L 359 OHV Diesel L6 4.1875" Bore.....	85	7500 ... Wheel Tractor.....	6.8L 413.8 (6784cc) OHV Turbo-Diesel L6 106mm Bore (PowerTech 2V).....	108
7445 ... Cotton Picker.....	5.9L 359 OHV Turbo-Diesel L6 4.1875" Bore.....	86	7510 ... Wheel Tractor.....	6.8L 413.8 (6784cc) OHV Turbo-Diesel L6 106mm Bore (PowerTech 2V IC).....	102
7455 ... Cotton Picker.....	6.8L 413.8 (6784cc) OHV Turbo-Diesel L6 106mm Bore (PowerTech 2V).....	108	7510 ... Wheel Tractor.....	6.8L 413.8 (6784cc) OHV Turbo-Diesel L6 106mm Bore (PowerTech 2V).....	108
7460 ... Cotton Picker.....	6.8L 413.8 (6784cc) OHV Turbo-Diesel L6 106mm Bore (PowerTech 2V).....	108	7520 ... Wheel Tractor.....	6.8L 413.8 (6784cc) OHV Turbo-Diesel L6 106mm Bore (PowerTech 2V IC).....	102
748E ... Skidder.....	7.6L 465.9 (7638cc) OHV Turbo-Diesel L6 115mm Bore (Litre Engine).....	116	7520 ... Wheel Tractor.....	6.8L 413.8 (6784cc) OHV Turbo-Diesel L6 106mm Bore (PowerTech 4V IC).....	103
748G ... Skidder.....	8.1L 495.9 (8129cc) OHV Turbo-Diesel L6 116mm Bore (PowerTech 2V AC).....	119	7520 ... Wheel Tractor.....	8.7L 531 OHV Diesel L6 4.75" Bore.....	122
748G ... Skidder.....	8.1L 495.9 (8129cc) OHV Turbo-Diesel L6 116mm Bore (PowerTech 2V).....	121	7520 ... Wheel Tractor.....	8.7L 531 OHV Turbo-Diesel L6 4.75" Bore.....	123
748G-II ... Skidder.....	8.1L 495.9 (8129cc) OHV Turbo-Diesel L6 116mm Bore (PowerTech 2V IC).....	118	753G ... Feller Buncher.....	8.1L 495.9 (8129cc) OHV Turbo-Diesel L6 116mm Bore (PowerTech 2V IC).....	118
748G-II ... Skidder.....	8.1L 495.9 (8129cc) OHV Turbo-Diesel L6 116mm Bore (PowerTech 2V AC).....	119	753G ... Feller Buncher.....	8.1L 495.9 (8129cc) OHV Turbo-Diesel L6 116mm Bore (PowerTech 2V AC).....	119
748G-II ... Skidder.....	8.1L 495.9 (8129cc) OHV Turbo-Diesel L6 116mm Bore (PowerTech 2V).....	121	753G ... Feller Buncher.....	8.1L 495.9 (8129cc) OHV Turbo-Diesel L6 116mm Bore (PowerTech 2V).....	121
748G-III ... Skidder.....	8.1L 495.9 (8129cc) OHV Turbo-Diesel L6 116mm Bore (PowerTech 2V IC).....	118	753GL ... Feller Buncher.....	8.1L 495.9 (8129cc) OHV Turbo-Diesel L6 116mm Bore (PowerTech 2V AC).....	119
748G-III ... Skidder.....	8.1L 495.9 (8129cc) OHV Turbo-Diesel L6 116mm Bore (PowerTech 2V AC).....	119	753GL ... Feller Buncher.....	8.1L 495.9 (8129cc) OHV Turbo-Diesel L6 116mm Bore (PowerTech 2V).....	121
750 ... Crawler Tractor.....	6.8L 414 OHV Diesel L6 4.1875" Bore (Standard).....	109	755 ... Crawler Tractor.....	6.8L 414 OHV Turbo-Diesel L6 4.1875" Bore (Standard).....	110
750 ... Crawler Tractor.....	6.8L 414 OHV Turbo-Diesel L6 4.1875" Bore (Standard).....	110	755A ... Crawler Tractor.....	6.8L 414 OHV Turbo-Diesel L6 4.1875" Bore (Standard).....	110
750B ... Crawler Tractor.....	6.8L 414 OHV Turbo-Diesel L6 4.1875" Bore (Standard).....	110	755B ... Crawler Tractor.....	6.8L 414 OHV Diesel L6 4.1875" Bore (Standard).....	109
750B ... Crawler Tractor.....	6.8L 413.8 (6784cc) OHV Turbo-Diesel L6 106mm Bore (Litre Engine).....	106	755B ... Crawler Tractor.....	6.8L 414 OHV Turbo-Diesel L6 4.1875" Bore (Standard).....	110
750BLT ... Crawler Tractor.....	6.8L 414 OHV Turbo-Diesel L6 4.1875" Bore (Standard).....	110	755B ... Crawler Tractor.....	6.8L 413.8 (6784cc) OHV Turbo-Diesel L6 106mm Bore (Litre Engine).....	106
750BLT ... Crawler Tractor.....	6.8L 413.8 (6784cc) OHV Turbo-Diesel L6 106mm Bore (Litre Engine).....	106	759G ... Feller Buncher.....	8.1L 495.9 (8129cc) OHV Turbo-Diesel L6 116mm Bore (PowerTech 2V IC).....	118
750C ... Crawler Tractor.....	6.8L 413.8 (6784cc) OHV Turbo-Diesel L6 106mm Bore (PowerTech 2V IC).....	102	759G ... Feller Buncher.....	8.1L 495.9 (8129cc) OHV Turbo-Diesel L6 116mm Bore (PowerTech 2V AC).....	119
750C ... Crawler Tractor.....	6.8L 413.8 (6784cc) OHV Turbo-Diesel L6 106mm Bore (PowerTech 2V).....	108	759G ... Feller Buncher.....	8.1L 495.9 (8129cc) OHV Turbo-Diesel L6 116mm Bore (PowerTech 2V).....	121
750C-II ... Crawler Tractor.....	6.8L 413.8 (6784cc) OHV Turbo-Diesel L6 106mm Bore (PowerTech 2V IC).....	102	7610 ... Wheel Tractor.....	6.8L 413.8 (6784cc) OHV Turbo-Diesel L6 106mm Bore (PowerTech 2V IC).....	102
750C-II ... Crawler Tractor.....	6.8L 413.8 (6784cc) OHV Turbo-Diesel L6 106mm Bore (PowerTech 2V).....	108	7610 ... Wheel Tractor.....	6.8L 413.8 (6784cc) OHV Turbo-Diesel L6 106mm Bore (PowerTech 2V).....	108
750J ... Crawler Tractor.....	6.8L 413.8 (6784cc) OHV Turbo-Diesel L6 106mm Bore (PowerTech 2V IC).....	102	762 ... Scraper.....	10.1L 619 OHV Turbo-Diesel L6 5.125" Bore.....	127
750J ... Crawler Tractor.....	6.8L 413.8 (6784cc) OHV Turbo-Diesel L6 106mm Bore (PowerTech 2V).....	108	762A ... Scraper.....	7.6L 466 OHV Turbo-Diesel L6 4.5625" Bore (Standard).....	114

(continued on next page)

Model Index					
Model	Engine Description	Line No.	Model	Engine Description	Line No.
762B ... Scraper.....	7.6L 466 OHV Turbo-Diesel L6 4.5625" Bore (Standard).....	114	770D ... Grader.....	8.1L 495.9 (8129cc) OHV Turbo-Diesel L6 116mm Bore (PowerTech 2V AC).....	119
762B-II ... Scraper .....	8.1L 495.9 (8129cc) OHV Turbo-Diesel L6 116mm Bore (PowerTech 2V IC) .....	118	770D ... Grader.....	8.1L 495.9 (8129cc) OHV Turbo-Diesel L6 116mm Bore (PowerTech 2V).....	121
762B-II ... Scraper .....	8.1L 495.9 (8129cc) OHV Turbo-Diesel L6 116mm Bore (PowerTech 2V AC).....	119	7700 ... Combine .....	5.9L 362 OHV L6 4.25" Bore.....	87
762B-II ... Scraper .....	8.1L 495.9 (8129cc) OHV Turbo-Diesel L6 116mm Bore (PowerTech 2V).....	121	7700 ... Wheel Tractor.....	5.9L 362 OHV L6 4.25" Bore.....	87
7630 ... Wheel Tractor.....	6.8L 413.8 (6784cc) OHV Turbo-Diesel L6 106mm Bore (PowerTech 4V IC).....	103	7700 ... Wheel Tractor.....	5.9L 362 OHV LPG L6 4.25" Bore.....	88
770 ... Grader .....	8.7L 531 OHV Turbo-Diesel L6 4.75" Bore.....	123	7700 ... Wheel Tractor.....	5.9L 362 OHV NG L6 4.25" Bore	89
770A ... Grader.....	7.6L 466 OHV Turbo-Diesel L6 4.5625" Bore (Standard).....	114	7700 ... Combine .....	6.6L 404 OHV Diesel L6 4.25" Bore (Early).....	95
770A ... Grader.....	8.7L 531 OHV Turbo-Diesel L6 4.75" Bore.....	123	7700 ... Wheel Tractor.....	6.6L 404 OHV Diesel L6 4.25" Bore (Early).....	95
770AH ... Grader .....	7.6L 466 OHV Turbo-Diesel L6 4.5625" Bore (Standard).....	114	7700 ... Combine .....	6.6L 404 OHV Diesel L6 4.25" Bore (Late).....	96
770B ... Grader.....	7.6L 466 OHV Turbo-Diesel L6 4.5625" Bore (Standard).....	114	7700 ... Wheel Tractor.....	6.6L 404 OHV Diesel L6 4.25" Bore (Late).....	96
770BH ... Grader .....	7.6L 466 OHV Turbo-Diesel L6 4.5625" Bore (Standard).....	114	7700 ... Combine .....	6.6L 404 OHV Turbo-Diesel L6 4.25" Bore (Aftercooled).....	98
770C ... Grader.....	8.1L 495.9 (8129cc) OHV Turbo-Diesel L6 116mm Bore (PowerTech 2V IC).....	118	7710 ... Wheel Tractor.....	8.1L 495.9 (8129cc) OHV Turbo-Diesel L6 116mm Bore (PowerTech 2V IC).....	118
770C ... Grader.....	8.1L 495.9 (8129cc) OHV Turbo-Diesel L6 116mm Bore (PowerTech 2V AC).....	119	7710 ... Wheel Tractor.....	8.1L 495.9 (8129cc) OHV Turbo-Diesel L6 116mm Bore (PowerTech 2V AC).....	119
770C ... Grader.....	8.1L 495.9 (8129cc) OHV Turbo-Diesel L6 116mm Bore (PowerTech 2V).....	121	7710 ... Wheel Tractor.....	8.1L 495.9 (8129cc) OHV Turbo-Diesel L6 116mm Bore (PowerTech 2V).....	121
770C-II ... Grader.....	8.1L 495.9 (8129cc) OHV Turbo-Diesel L6 116mm Bore (PowerTech 2V AC).....	118	772A ... Grader.....	7.6L 466 OHV Turbo-Diesel L6 4.5625" Bore (Standard).....	114
770C-II ... Grader.....	8.1L 495.9 (8129cc) OHV Turbo-Diesel L6 116mm Bore (PowerTech 2V AC).....	119	772A ... Grader.....	8.7L 531 OHV Turbo-Diesel L6 4.75" Bore.....	123
770C-II ... Grader.....	8.1L 495.9 (8129cc) OHV Turbo-Diesel L6 116mm Bore (PowerTech 2V).....	121	772AH ... Grader .....	7.6L 466 OHV Turbo-Diesel L6 4.5625" Bore (Standard).....	114
770CH ... Grader .....	8.1L 495.9 (8129cc) OHV Turbo-Diesel L6 116mm Bore (PowerTech 2V AC).....	119	772B ... Grader.....	7.6L 466 OHV Turbo-Diesel L6 4.5625" Bore (Standard).....	114
770CH ... Grader .....	8.1L 495.9 (8129cc) OHV Turbo-Diesel L6 116mm Bore (PowerTech 2V).....	121	772BH ... Grader .....	7.6L 466 OHV Turbo-Diesel L6 4.5625" Bore (Standard).....	114
770CH ... Grader .....	8.1L 495.9 (8129cc) OHV Turbo-Diesel L6 116mm Bore (PowerTech 2V AC).....	119	772CH ... Grader .....	8.1L 495.9 (8129cc) OHV Turbo-Diesel L6 116mm Bore (PowerTech 2V IC).....	118
770CH ... Grader .....	8.1L 495.9 (8129cc) OHV Turbo-Diesel L6 116mm Bore (PowerTech 2V).....	121	772CH ... Grader .....	8.1L 495.9 (8129cc) OHV Turbo-Diesel L6 116mm Bore (PowerTech 2V AC).....	119
770CH-II ... Grader.....	8.1L 495.9 (8129cc) OHV Turbo-Diesel L6 116mm Bore (PowerTech 2V AC).....	118	772CH ... Grader .....	8.1L 495.9 (8129cc) OHV Turbo-Diesel L6 116mm Bore (PowerTech 2V).....	121
770CH-II ... Grader.....	8.1L 495.9 (8129cc) OHV Turbo-Diesel L6 116mm Bore (PowerTech 2V AC).....	119	772CH-II ... Grader.....	8.1L 495.9 (8129cc) OHV Turbo-Diesel L6 116mm Bore (PowerTech 2V AC).....	119
770CH-II ... Grader.....	8.1L 495.9 (8129cc) OHV Turbo-Diesel L6 116mm Bore (PowerTech 2V).....	121	772CH-II ... Grader.....	8.1L 495.9 (8129cc) OHV Turbo-Diesel L6 116mm Bore (PowerTech 2V).....	121
770CH-II ... Grader.....	8.1L 495.9 (8129cc) OHV Turbo-Diesel L6 116mm Bore (PowerTech 2V AC).....	119	772D ... Grader.....	8.1L 495.9 (8129cc) OHV Turbo-Diesel L6 116mm Bore (PowerTech 2V IC).....	118
770D ... Forestry Tractor .....	4.5L 275.8 (4522cc) OHV Turbo-Diesel L4 106mm Bore (PowerTech 2V IC).....	61	772D ... Grader.....	8.1L 495.9 (8129cc) OHV Turbo-Diesel L6 116mm Bore (PowerTech 2V AC).....	119
770D ... Forestry Tractor .....	4.5L 275.8 (4522cc) OHV Turbo-Diesel L4 106mm Bore (PowerTech 2V).....	66	772D ... Grader.....	8.1L 495.9 (8129cc) OHV Turbo-Diesel L6 116mm Bore (PowerTech 2V).....	121
770D ... Grader.....	8.1L 495.9 (8129cc) OHV Turbo-Diesel L6 116mm Bore (PowerTech 2V IC).....	118	7720 ... Wheel Tractor .....	6.8L 413.8 (6784cc) OHV Turbo-Diesel L6 106mm Bore (PowerTech 4V IC).....	103
			7720 ... Combine .....	7.6L 466 OHV Diesel L6 4.5625" Bore (Standard).....	113

(continued on next page)





# John Deere Off Highway

Model Index					
Model	Engine Description	Line No.	Model	Engine Description	Line No.
7720 ... Combine	7.6L 466 OHV Turbo-Diesel L6 4.5625" Bore (Standard)	114	8020 ... Wheel Tractor	7.0L 426 OHV Diesel L6 4.25" Bore (6-71) (Detroit Diesel Eng.)	112
7720 ... Wheel Tractor	7.6L 466 OHV Turbo-Diesel L6 4.5625" Bore (Standard)	114	810D ... Forestry Tractor	4.5L 275.8 (4522cc) OHV Turbo-Diesel L4 106mm Bore (PowerTech 2V IC)	61
7730 ... Wheel Tractor	6.8L 413.8 (6784cc) OHV Turbo-Diesel L6 106mm Bore (PowerTech 4V IC)	103	810D ... Forestry Tractor	4.5L 275.8 (4522cc) OHV Turbo-Diesel L4 106mm Bore (PowerTech 2V)	66
7810 ... Wheel Tractor	8.1L 495.9 (8129cc) OHV Turbo-Diesel L6 116mm Bore (PowerTech 2V IC)	118	8100 ... Wheel Tractor	8.1L 495.9 (8129cc) OHV Turbo-Diesel L6 116mm Bore (PowerTech 2V IC)	118
7810 ... Wheel Tractor	8.1L 495.9 (8129cc) OHV Turbo-Diesel L6 116mm Bore (PowerTech 2V AC)	119	8100 ... Wheel Tractor	8.1L 495.9 (8129cc) OHV Turbo-Diesel L6 116mm Bore (PowerTech 2V AC)	119
7810 ... Wheel Tractor	8.1L 495.9 (8129cc) OHV Turbo-Diesel L6 116mm Bore (PowerTech 2V)	121	8100 ... Wheel Tractor	8.1L 495.9 (8129cc) OHV Turbo-Diesel L6 116mm Bore (PowerTech 2V)	121
7815 ... Wheel Tractor	6.8L 413.8 (6784cc) OHV Turbo-Diesel L6 106mm Bore (PowerTech 2V IC)	102	8100T ... Wheel Tractor	8.1L 495.9 (8129cc) OHV Turbo-Diesel L6 116mm Bore (PowerTech 2V IC)	118
7815 ... Wheel Tractor	6.8L 413.8 (6784cc) OHV Turbo-Diesel L6 106mm Bore (PowerTech 2V)	108	8100T ... Wheel Tractor	8.1L 495.9 (8129cc) OHV Turbo-Diesel L6 116mm Bore (PowerTech 2V AC)	119
7820 ... Wheel Tractor	6.8L 413.8 (6784cc) OHV Turbo-Diesel L6 106mm Bore (PowerTech 4V IC)	103	8100T ... Wheel Tractor	8.1L 495.9 (8129cc) OHV Turbo-Diesel L6 116mm Bore (PowerTech 2V)	121
7820 ... Wheel Tractor	8.1L 495.9 (8129cc) OHV Turbo-Diesel L6 116mm Bore (PowerTech 2V IC)	118	8110 ... Wheel Tractor	8.1L 495.9 (8129cc) OHV Turbo-Diesel L6 116mm Bore (PowerTech 2V IC)	118
7820 ... Wheel Tractor	8.1L 495.9 (8129cc) OHV Turbo-Diesel L6 116mm Bore (PowerTech 2V AC)	119	8110 ... Wheel Tractor	8.1L 495.9 (8129cc) OHV Turbo-Diesel L6 116mm Bore (PowerTech 2V AC)	119
7820 ... Wheel Tractor	8.1L 495.9 (8129cc) OHV Turbo-Diesel L6 116mm Bore (PowerTech 2V)	121	8110 ... Wheel Tractor	8.1L 495.9 (8129cc) OHV Turbo-Diesel L6 116mm Bore (PowerTech 2V)	121
7830 ... Wheel Tractor	6.8L 413.8 (6784cc) OHV Turbo-Diesel L6 106mm Bore (PowerTech 4V IC)	103	8110T ... Wheel Tractor	8.1L 495.9 (8129cc) OHV Turbo-Diesel L6 116mm Bore (PowerTech 2V IC)	118
790 ... Wheel Tractor	7.6L 466 OHV Turbo-Diesel L6 4.5625" Bore (Standard)	114	8110T ... Wheel Tractor	8.1L 495.9 (8129cc) OHV Turbo-Diesel L6 116mm Bore (PowerTech 2V AC)	119
790 ... Excavator	7.6L 466 OHV Turbo-Diesel L6 4.5625" Bore (Standard)	114	8110T ... Wheel Tractor	8.1L 495.9 (8129cc) OHV Turbo-Diesel L6 116mm Bore (PowerTech 2V)	121
790D ... Excavator	7.6L 466 OHV Turbo-Diesel L6 4.5625" Bore (Standard)	114	8120 ... Wheel Tractor	8.1L 495.9 (8129cc) OHV Turbo-Diesel L6 116mm Bore (PowerTech 2V IC)	118
790E ... Excavator	6.8L 413.8 (6784cc) OHV Turbo-Diesel L6 106mm Bore (Litre Engine)	106	8120 ... Wheel Tractor	8.1L 495.9 (8129cc) OHV Turbo-Diesel L6 116mm Bore (PowerTech 2V AC)	119
792 ... Wheel Tractor	7.6L 466 OHV Turbo-Diesel L6 4.5625" Bore (Standard)	114	8120 ... Wheel Tractor	8.1L 495.9 (8129cc) OHV Turbo-Diesel L6 116mm Bore (PowerTech 2V)	121
792 ... Excavator	7.6L 466 OHV Turbo-Diesel L6 4.5625" Bore (Standard)	114	8120T ... Wheel Tractor	8.1L 495.9 (8129cc) OHV Turbo-Diesel L6 116mm Bore (PowerTech 2V IC)	118
7920 ... Wheel Tractor	8.1L 495.9 (8129cc) OHV Turbo-Diesel L6 116mm Bore (PowerTech 2V IC)	118	8120T ... Wheel Tractor	8.1L 495.9 (8129cc) OHV Turbo-Diesel L6 116mm Bore (PowerTech 2V AC)	119
7920 ... Wheel Tractor	8.1L 495.9 (8129cc) OHV Turbo-Diesel L6 116mm Bore (PowerTech 2V)	121	8120T ... Wheel Tractor	8.1L 495.9 (8129cc) OHV Turbo-Diesel L6 116mm Bore (PowerTech 2V)	121
7920 ... Wheel Tractor	8.1L 495.9 (8129cc) OHV Turbo-Diesel L6 116mm Bore (PowerTech 2V AC)	119	8120T ... Wheel Tractor	8.1L 495.9 (8129cc) OHV Turbo-Diesel L6 116mm Bore (PowerTech 2V IC)	118
7920 ... Wheel Tractor	8.1L 495.9 (8129cc) OHV Turbo-Diesel L6 116mm Bore (PowerTech 2V)	121	8120T ... Wheel Tractor	8.1L 495.9 (8129cc) OHV Turbo-Diesel L6 116mm Bore (PowerTech 2V AC)	119
793D ... Feller Buncher	7.6L 466 OHV Turbo-Diesel L6 4.5625" Bore (Standard)	114	820 ... Wheel Tractor	2.5L 152 OHV Diesel L3 3.8594" Bore	18
7930 ... Wheel Tractor	6.8L 413.8 (6784cc) OHV Turbo-Diesel L6 106mm Bore (PowerTech 4V IC)	103	8200 ... Wheel Tractor	8.1L 495.9 (8129cc) OHV Turbo-Diesel L6 116mm Bore (PowerTech 2V IC)	118
800 ... Windrower	3.7L 225 OHV L6 3.4063" Bore (Chrysler Eng.)	44	8200 ... Wheel Tractor	8.1L 495.9 (8129cc) OHV Turbo-Diesel L6 116mm Bore (PowerTech 2V AC)	119
8010 ... Wheel Tractor	4.7L 284 OHV Diesel L4 4.25" Bore (4-71) (Detroit Diesel Eng.)	70	8200 ... Wheel Tractor	8.1L 495.9 (8129cc) OHV Turbo-Diesel L6 116mm Bore (PowerTech 2V)	121
8010 ... Wheel Tractor	7.0L 426 OHV Diesel L6 4.25" Bore (6-71) (Detroit Diesel Eng.)	112			
8020 ... Wheel Tractor	4.7L 284 OHV Diesel L4 4.25" Bore (4-71) (Detroit Diesel Eng.)	70			

(continued on next page)

Model Index					
Model	Engine Description	Line No.	Model	Engine Description	Line No.
8200T ... Wheel Tractor	8.1L 495.9 (8129cc) OHV Turbo-Diesel L6 116mm Bore (PowerTech 2V IC)	118	8310 ... Wheel Tractor	8.1L 495.9 (8129cc) OHV Turbo-Diesel L6 116mm Bore (PowerTech 2V)	121
8200T ... Wheel Tractor	8.1L 495.9 (8129cc) OHV Turbo-Diesel L6 116mm Bore (PowerTech 2V AC)	119	8310T ... Wheel Tractor	8.1L 495.9 (8129cc) OHV Turbo-Diesel L6 116mm Bore (PowerTech 2V IC)	118
8200T ... Wheel Tractor	8.1L 495.9 (8129cc) OHV Turbo-Diesel L6 116mm Bore (PowerTech 2V)	121	8310T ... Wheel Tractor	8.1L 495.9 (8129cc) OHV Turbo-Diesel L6 116mm Bore (PowerTech 2V AC)	119
8210 ... Wheel Tractor	8.1L 495.9 (8129cc) OHV Turbo-Diesel L6 116mm Bore (PowerTech 2V IC)	118	8310T ... Wheel Tractor	8.1L 495.9 (8129cc) OHV Turbo-Diesel L6 116mm Bore (PowerTech 2V)	121
8210 ... Wheel Tractor	8.1L 495.9 (8129cc) OHV Turbo-Diesel L6 116mm Bore (PowerTech 2V AC)	119	8320 ... Wheel Tractor	8.1L 495.9 (8129cc) OHV Turbo-Diesel L6 116mm Bore (PowerTech 2V IC)	118
8210 ... Wheel Tractor	8.1L 495.9 (8129cc) OHV Turbo-Diesel L6 116mm Bore (PowerTech 2V)	121	8320 ... Wheel Tractor	8.1L 495.9 (8129cc) OHV Turbo-Diesel L6 116mm Bore (PowerTech 2V AC)	119
8210T ... Wheel Tractor	8.1L 495.9 (8129cc) OHV Turbo-Diesel L6 116mm Bore (PowerTech 2V IC)	118	8320 ... Wheel Tractor	8.1L 495.9 (8129cc) OHV Turbo-Diesel L6 116mm Bore (PowerTech 2V)	121
8210T ... Wheel Tractor	8.1L 495.9 (8129cc) OHV Turbo-Diesel L6 116mm Bore (PowerTech 2V AC)	119	8320T ... Wheel Tractor	8.1L 495.9 (8129cc) OHV Turbo-Diesel L6 116mm Bore (PowerTech 2V IC)	118
8210T ... Wheel Tractor	8.1L 495.9 (8129cc) OHV Turbo-Diesel L6 116mm Bore (PowerTech 2V)	121	8320T ... Wheel Tractor	8.1L 495.9 (8129cc) OHV Turbo-Diesel L6 116mm Bore (PowerTech 2V AC)	119
8220 ... Wheel Tractor	8.1L 495.9 (8129cc) OHV Turbo-Diesel L6 116mm Bore (PowerTech 2V IC)	118	8320T ... Wheel Tractor	8.1L 495.9 (8129cc) OHV Turbo-Diesel L6 116mm Bore (PowerTech 2V)	121
8220 ... Wheel Tractor	8.1L 495.9 (8129cc) OHV Turbo-Diesel L6 116mm Bore (PowerTech 2V AC)	119	840 ... Forestry Tractor	6.8L 413.8 (6784cc) OHV Turbo-Diesel L6 106mm Bore (PowerTech 2V IC)	102
8220 ... Wheel Tractor	8.1L 495.9 (8129cc) OHV Turbo-Diesel L6 116mm Bore (PowerTech 2V)	121	840 ... Forestry Tractor	6.8L 413.8 (6784cc) OHV Turbo-Diesel L6 106mm Bore (PowerTech 2V)	108
8220T ... Wheel Tractor	8.1L 495.9 (8129cc) OHV Turbo-Diesel L6 116mm Bore (PowerTech 2V IC)	118	8400 ... Wheel Tractor	8.1L 495.9 (8129cc) OHV Turbo-Diesel L6 116mm Bore (PowerTech 2V AC)	119
8220T ... Wheel Tractor	8.1L 495.9 (8129cc) OHV Turbo-Diesel L6 116mm Bore (PowerTech 2V AC)	119	8400 ... Wheel Tractor	8.1L 495.9 (8129cc) OHV Turbo-Diesel L6 116mm Bore (PowerTech 2V)	121
8220T ... Wheel Tractor	8.1L 495.9 (8129cc) OHV Turbo-Diesel L6 116mm Bore (PowerTech 2V)	121	8400T ... Wheel Tractor	8.1L 495.9 (8129cc) OHV Turbo-Diesel L6 116mm Bore (PowerTech 2V IC)	118
830 ... Wheel Tractor	2.5L 152 OHV Diesel L3 3.8594" Bore	18	8400T ... Wheel Tractor	8.1L 495.9 (8129cc) OHV Turbo-Diesel L6 116mm Bore (PowerTech 2V AC)	119
830 ... Windrower	3.7L 225 OHV L6 3.4063" Bore (Chrysler Eng.)	44	8400T ... Wheel Tractor	8.1L 495.9 (8129cc) OHV Turbo-Diesel L6 116mm Bore (PowerTech 2V)	121
8300 ... Wheel Tractor	8.1L 495.9 (8129cc) OHV Turbo-Diesel L6 116mm Bore (PowerTech 2V IC)	118	8410 ... Wheel Tractor	8.1L 495.9 (8129cc) OHV Turbo-Diesel L6 116mm Bore (PowerTech 2V IC)	118
8300 ... Wheel Tractor	8.1L 495.9 (8129cc) OHV Turbo-Diesel L6 116mm Bore (PowerTech 2V AC)	119	8410 ... Wheel Tractor	8.1L 495.9 (8129cc) OHV Turbo-Diesel L6 116mm Bore (PowerTech 2V AC)	119
8300 ... Wheel Tractor	8.1L 495.9 (8129cc) OHV Turbo-Diesel L6 116mm Bore (PowerTech 2V)	121	8410T ... Wheel Tractor	8.1L 495.9 (8129cc) OHV Turbo-Diesel L6 116mm Bore (PowerTech 2V IC)	118
8300T ... Wheel Tractor	8.1L 495.9 (8129cc) OHV Turbo-Diesel L6 116mm Bore (PowerTech 2V IC)	118	8410T ... Wheel Tractor	8.1L 495.9 (8129cc) OHV Turbo-Diesel L6 116mm Bore (PowerTech 2V AC)	119
8300T ... Wheel Tractor	8.1L 495.9 (8129cc) OHV Turbo-Diesel L6 116mm Bore (PowerTech 2V AC)	119	8420 ... Wheel Tractor	8.1L 495.9 (8129cc) OHV Turbo-Diesel L6 116mm Bore (PowerTech 2V IC)	118
8300T ... Wheel Tractor	8.1L 495.9 (8129cc) OHV Turbo-Diesel L6 116mm Bore (PowerTech 2V)	121	8420 ... Wheel Tractor	8.1L 495.9 (8129cc) OHV Turbo-Diesel L6 116mm Bore (PowerTech 2V AC)	119
8310 ... Wheel Tractor	8.1L 495.9 (8129cc) OHV Turbo-Diesel L6 116mm Bore (PowerTech 2V IC)	118			
8310 ... Wheel Tractor	8.1L 495.9 (8129cc) OHV Turbo-Diesel L6 116mm Bore (PowerTech 2V AC)	119			



# John Deere Off Highway

Model Index					
Model	Engine Description	Line No.	Model	Engine Description	Line No.
8420T ... Wheel Tractor.....	8.1L 495.9 (8129cc) OHV Turbo-Diesel L6 116mm Bore (PowerTech 2V IC).....	118	850C-II ... Crawler Tractor.....	8.1L 495.9 (8129cc) OHV Turbo-Diesel L6 116mm Bore (PowerTech 2V).....	121
8420T ... Wheel Tractor.....	8.1L 495.9 (8129cc) OHV Turbo-Diesel L6 116mm Bore (PowerTech 2V AC).....	119	850J ... Crawler Tractor.....	8.1L 495.9 (8129cc) OHV Turbo-Diesel L6 116mm Bore (PowerTech 2V IC).....	118
843G ... Forestry Tractor.....	6.8L 413.8 (6784cc) OHV Turbo-Diesel L6 106mm Bore (PowerTech 2V IC).....	102	850J ... Crawler Tractor.....	8.1L 495.9 (8129cc) OHV Turbo-Diesel L6 116mm Bore (PowerTech 2V AC).....	119
843G ... Forestry Tractor.....	6.8L 413.8 (6784cc) OHV Turbo-Diesel L6 106mm Bore (PowerTech 2V).....	108	850J ... Crawler Tractor.....	8.1L 495.9 (8129cc) OHV Turbo-Diesel L6 116mm Bore (PowerTech 2V).....	121
843H ... Forestry Tractor.....	6.8L 413.8 (6784cc) OHV Turbo-Diesel L6 106mm Bore (PowerTech 2V IC).....	102	853G ... Feller Buncher.....	8.1L 495.9 (8129cc) OHV Turbo-Diesel L6 116mm Bore (PowerTech 2V IC).....	118
843H ... Forestry Tractor.....	6.8L 413.8 (6784cc) OHV Turbo-Diesel L6 106mm Bore (PowerTech 2V).....	108	853G ... Feller Buncher.....	8.1L 495.9 (8129cc) OHV Turbo-Diesel L6 116mm Bore (PowerTech 2V AC).....	119
843J ... Feller Buncher.....	6.8L 413.8 (6784cc) OHV Turbo-Diesel L6 106mm Bore (PowerTech 4V IC).....	103	853G ... Feller Buncher.....	8.1L 495.9 (8129cc) OHV Turbo-Diesel L6 116mm Bore (PowerTech 2V).....	121
8430 ... Wheel Tractor.....	7.6L 466 OHV Diesel L6 4.5625" Bore (Standard).....	113	853J ... Feller Buncher.....	8.1L 495.9 (8129cc) OHV Turbo-Diesel L6 116mm Bore (PowerTech 2V IC).....	118
8430 ... Wheel Tractor.....	7.6L 466 OHV Turbo-Diesel L6 4.5625" Bore (Standard).....	114	853J ... Feller Buncher.....	8.1L 495.9 (8129cc) OHV Turbo-Diesel L6 116mm Bore (PowerTech 2V AC).....	119
8440 ... Wheel Tractor.....	7.6L 466 OHV Diesel L6 4.5625" Bore (Standard).....	113	860B ... Scraper.....	10.1L 619 OHV Turbo-Diesel L6 5.125" Bore.....	127
8440 ... Wheel Tractor.....	7.6L 466 OHV Turbo-Diesel L6 4.5625" Bore (Standard).....	114	862 To Eng. Ser. No. 499999 ... Scraper.....	10.1L 619 OHV Turbo-Diesel L6 5.125" Bore.....	127
8450 ... Wheel Tractor.....	7.6L 466 OHV Diesel L6 4.5625" Bore (Standard).....	113	862B ... Scraper.....	10.1L 619 OHV Turbo-Diesel L6 5.125" Bore.....	127
8450 ... Wheel Tractor.....	7.6L 466 OHV Turbo-Diesel L6 4.5625" Bore (Standard).....	114	8630 ... Wheel Tractor.....	10.1L 619 OHV Turbo-Diesel L6 5.125" Bore.....	127
848G ... Skidder.....	8.1L 495.9 (8129cc) OHV Turbo-Diesel L6 116mm Bore (PowerTech 2V IC).....	118	8650 ... Wheel Tractor.....	10.1L 619 OHV Turbo-Diesel L6 5.125" Bore.....	127
848G ... Skidder.....	8.1L 495.9 (8129cc) OHV Turbo-Diesel L6 116mm Bore (PowerTech 2V AC).....	119	870D ... Grader.....	8.1L 495.9 (8129cc) OHV Turbo-Diesel L6 116mm Bore (PowerTech 2V IC).....	118
848G ... Skidder.....	8.1L 495.9 (8129cc) OHV Turbo-Diesel L6 116mm Bore (PowerTech 2V).....	121	870D ... Grader.....	8.1L 495.9 (8129cc) OHV Turbo-Diesel L6 116mm Bore (PowerTech 2V AC).....	119
850 ... Feller Buncher.....	8.1L 495.9 (8129cc) OHV Turbo-Diesel L6 116mm Bore (PowerTech 2V IC).....	118	870D ... Grader.....	8.1L 495.9 (8129cc) OHV Turbo-Diesel L6 116mm Bore (PowerTech 2V).....	121
850 ... Feller Buncher.....	8.1L 495.9 (8129cc) OHV Turbo-Diesel L6 116mm Bore (PowerTech 2V AC).....	119	872D ... Grader.....	8.1L 495.9 (8129cc) OHV Turbo-Diesel L6 116mm Bore (PowerTech 2V IC).....	118
850 ... Feller Buncher.....	8.1L 495.9 (8129cc) OHV Turbo-Diesel L6 116mm Bore (PowerTech 2V).....	121	872D ... Grader.....	8.1L 495.9 (8129cc) OHV Turbo-Diesel L6 116mm Bore (PowerTech 2V AC).....	119
850 ... Wheel Tractor.....	10.1L 619 OHV Turbo-Diesel L6 5.125" Bore.....	127	872D ... Grader.....	8.1L 495.9 (8129cc) OHV Turbo-Diesel L6 116mm Bore (PowerTech 2V).....	121
850 ... Crawler Tractor.....	10.1L 619 OHV Turbo-Diesel L6 5.125" Bore.....	127	880 ... Windrower.....	2.9L 180 OHV L4 3.8594" Bore.....	31
850B ... Crawler Tractor.....	7.6L 466 OHV Turbo-Diesel L6 4.5625" Bore (Standard).....	114	880 ... Windrower.....	3.3L 202 OHV Diesel L4 3.8594" Bore.....	38
850C ... Crawler Tractor.....	8.1L 495.9 (8129cc) OHV Turbo-Diesel L6 116mm Bore (PowerTech 2V IC).....	118	8820 ... Combine.....	7.6L 466 OHV Diesel L6 4.5625" Bore (Standard).....	113
850C ... Crawler Tractor.....	8.1L 495.9 (8129cc) OHV Turbo-Diesel L6 116mm Bore (PowerTech 2V AC).....	119	8820 ... Combine.....	7.6L 466 OHV Turbo-Diesel L6 4.5625" Bore (Standard).....	114
850C ... Crawler Tractor.....	8.1L 495.9 (8129cc) OHV Turbo-Diesel L6 116mm Bore (PowerTech 2V).....	121	8820 ... Harvester.....	7.6L 466 OHV Turbo-Diesel L6 4.5625" Bore (Standard).....	114
850C-II ... Crawler Tractor.....	8.1L 495.9 (8129cc) OHV Turbo-Diesel L6 116mm Bore (PowerTech 2V IC).....	118	8875 ... Track Loader.....	2.9L 179.2 (2938cc) OHV Turbo-Diesel L3 106mm Bore (PowerTech 2V).....	30
850C-II ... Crawler Tractor.....	8.1L 495.9 (8129cc) OHV Turbo-Diesel L6 116mm Bore (PowerTech 2V AC).....	119	890 ... Excavator.....	10.1L 619 OHV Turbo-Diesel L6 5.125" Bore.....	127
			890A ... Wheel Tractor.....	7.6L 466 OHV Diesel L6 4.5625" Bore (Standard).....	113

(continued on next page)

Model Index					
Model	Engine Description	Line No.	Model	Engine Description	Line No.
890A ... Wheel Tractor	7.6L 466 OHV Turbo-Diesel L6 4.5625" Bore (Standard)	114	95H ... Combine	5.0L 303 OHV Diesel L6 3.8594" Bore	73
890A ... Excavator	10.1L 619 OHV Turbo-Diesel L6 5.125" Bore	127	95H ... Power Unit	5.0L 303 OHV Diesel L6 3.8594" Bore	73
892D LC ... Excavator	7.6L 466 OHV Turbo-Diesel L6 4.5625" Bore (Standard)	114	95H ... Combine	5.0L 303 OHV LPG L6 3.8594" Bore	74
90 ... Combine	3.6L 217 OHV L6 3.625" Bore	39	95H ... Power Unit	5.0L 303 OHV LPG L6 3.8594" Bore	74
900 ... Feller Buncher	8.1L 495.9 (8129cc) OHV Turbo-Diesel L6 116mm Bore (PowerTech 2V IC)	118	95LL ... Combine	5.0L 303 OHV L6 3.8594" Bore	72
900 ... Feller Buncher	8.1L 495.9 (8129cc) OHV Turbo-Diesel L6 116mm Bore (PowerTech 2V AC)	119	95LL ... Power Unit	5.0L 303 OHV L6 3.8594" Bore	72
900 ... Feller Buncher	8.1L 495.9 (8129cc) OHV Turbo-Diesel L6 116mm Bore (PowerTech 2V)	121	95LL ... Combine	5.0L 303 OHV Diesel L6 3.8594" Bore	73
903G ... Feller Buncher	8.1L 495.9 (8129cc) OHV Turbo-Diesel L6 116mm Bore (PowerTech 2V IC)	118	95LL ... Power Unit	5.0L 303 OHV Diesel L6 3.8594" Bore	73
903G ... Feller Buncher	8.1L 495.9 (8129cc) OHV Turbo-Diesel L6 116mm Bore (PowerTech 2V AC)	119	95LL ... Combine	5.0L 303 OHV LPG L6 3.8594" Bore	74
903G ... Feller Buncher	8.1L 495.9 (8129cc) OHV Turbo-Diesel L6 116mm Bore (PowerTech 2V)	121	95LL ... Power Unit	5.0L 303 OHV LPG L6 3.8594" Bore	74
903J ... Feller Buncher	8.1L 495.9 (8129cc) OHV Turbo-Diesel L6 116mm Bore (PowerTech 2V IC)	118	95R ... Combine	3.6L 217 OHV L6 3.625" Bore	39
903J ... Feller Buncher	8.1L 495.9 (8129cc) OHV Turbo-Diesel L6 116mm Bore (PowerTech 2V AC)	119	950 ... Feller Buncher	8.1L 495.9 (8129cc) OHV Turbo-Diesel L6 116mm Bore (PowerTech 2V IC)	118
9100 ... Wheel Tractor	8.1L 495.9 (8129cc) OHV Turbo-Diesel L6 116mm Bore (PowerTech 2V IC)	118	950 ... Feller Buncher	8.1L 495.9 (8129cc) OHV Turbo-Diesel L6 116mm Bore (PowerTech 2V AC)	119
9100 ... Wheel Tractor	8.1L 495.9 (8129cc) OHV Turbo-Diesel L6 116mm Bore (PowerTech 2V AC)	119	950 ... Feller Buncher	8.1L 495.9 (8129cc) OHV Turbo-Diesel L6 116mm Bore (PowerTech 2V)	121
9100 ... Wheel Tractor	8.1L 495.9 (8129cc) OHV Turbo-Diesel L6 116mm Bore (PowerTech 2V)	121	9510 ... Combine	8.1L 495.9 (8129cc) OHV Turbo-Diesel L6 116mm Bore (PowerTech 2V IC)	118
9120 ... Wheel Tractor	8.1L 495.9 (8129cc) OHV Turbo-Diesel L6 116mm Bore (PowerTech 2V IC)	118	9510 ... Combine	8.1L 495.9 (8129cc) OHV Turbo-Diesel L6 116mm Bore (PowerTech 2V AC)	119
9120 ... Wheel Tractor	8.1L 495.9 (8129cc) OHV Turbo-Diesel L6 116mm Bore (PowerTech 2V AC)	119	9510 ... Combine	8.1L 495.9 (8129cc) OHV Turbo-Diesel L6 116mm Bore (PowerTech 2V)	121
9400 ... Combine	6.8L 413.8 (6784cc) OHV Turbo-Diesel L6 106mm Bore (PowerTech 2V IC)	102	953G ... Feller Buncher	8.1L 495.9 (8129cc) OHV Turbo-Diesel L6 116mm Bore (PowerTech 2V IC)	118
9400 ... Combine	6.8L 413.8 (6784cc) OHV Turbo-Diesel L6 106mm Bore (PowerTech 2V)	108	953G ... Feller Buncher	8.1L 495.9 (8129cc) OHV Turbo-Diesel L6 116mm Bore (PowerTech 2V AC)	119
9410 ... Combine	6.8L 413.8 (6784cc) OHV Turbo-Diesel L6 106mm Bore (PowerTech 2V IC)	102	953G ... Feller Buncher	8.1L 495.9 (8129cc) OHV Turbo-Diesel L6 116mm Bore (PowerTech 2V)	121
9410 ... Combine	6.8L 413.8 (6784cc) OHV Turbo-Diesel L6 106mm Bore (PowerTech 2V)	108	953J ... Feller Buncher	8.1L 495.9 (8129cc) OHV Turbo-Diesel L6 116mm Bore (PowerTech 2V IC)	118
9450 ... Combine	6.8L 413.8 (6784cc) OHV Turbo-Diesel L6 106mm Bore (PowerTech 2V IC)	102	953J ... Feller Buncher	8.1L 495.9 (8129cc) OHV Turbo-Diesel L6 116mm Bore (PowerTech 2V AC)	119
9450 ... Combine	6.8L 413.8 (6784cc) OHV Turbo-Diesel L6 106mm Bore (PowerTech 2V)	108	9540WTS ... Combine	6.8L 413.8 (6784cc) OHV Turbo-Diesel L6 106mm Bore (PowerTech 2V IC)	102
95 ... Combine	3.6L 217 OHV L6 3.625" Bore	39	9540WTS ... Combine	6.8L 413.8 (6784cc) OHV Turbo-Diesel L6 106mm Bore (PowerTech 2V)	108
95 ... Combine	5.0L 303 OHV L6 3.8594" Bore	72	9550 ... Combine	6.8L 413.8 (6784cc) OHV Turbo-Diesel L6 106mm Bore (PowerTech 4V IC)	103
95 ... Combine	5.0L 303 OHV Diesel L6 3.8594" Bore	73	9550 ... Combine	8.1L 495.9 (8129cc) OHV Turbo-Diesel L6 116mm Bore (PowerTech 2V IC)	118
95 ... Combine	5.0L 303 OHV LPG L6 3.8594" Bore	74	9550 ... Combine	8.1L 495.9 (8129cc) OHV Turbo-Diesel L6 116mm Bore (PowerTech 2V AC)	119
95H ... Combine	3.6L 217 OHV L6 3.625" Bore	39	9550 ... Combine	8.1L 495.9 (8129cc) OHV Turbo-Diesel L6 116mm Bore (PowerTech 2V)	121
95H ... Combine	5.0L 303 OHV L6 3.8594" Bore	72	9550H ... Combine	8.1L 495.9 (8129cc) OHV Turbo-Diesel L6 116mm Bore (PowerTech 2V IC)	118
95H ... Power Unit	5.0L 303 OHV L6 3.8594" Bore	72			



Model Index					
Model	Engine Description	Line No.	Model	Engine Description	Line No.
9550SH ... Combine	6.8L 413.8 (6784cc) OHV Turbo-Diesel L6 106mm Bore (PowerTech 4V IC)	103	9680 ... Combine	8.1L 495.9 (8129cc) OHV Turbo-Diesel L6 116mm Bore (PowerTech 2V IC)	118
9550SH ... Combine	8.1L 495.9 (8129cc) OHV Turbo-Diesel L6 116mm Bore (PowerTech 2V AC)	119	9750CTS-II ... Combine	8.1L 495.9 (8129cc) OHV Turbo-Diesel L6 116mm Bore (PowerTech 2V IC)	118
9550SH ... Combine	8.1L 495.9 (8129cc) OHV Turbo-Diesel L6 116mm Bore (PowerTech 2V)	121	9750CTS-II ... Combine	8.1L 495.9 (8129cc) OHV Turbo-Diesel L6 116mm Bore (PowerTech 2V AC)	119
9560 ... Combine	6.8L 413.8 (6784cc) OHV Turbo-Diesel L6 106mm Bore (PowerTech 4V IC)	103	9750STS ... Combine	8.1L 495.9 (8129cc) OHV Turbo-Diesel L6 116mm Bore (PowerTech 2V IC)	118
9560SH ... Combine	6.8L 413.8 (6784cc) OHV Turbo-Diesel L6 106mm Bore (PowerTech 4V IC)	103	9750STS ... Combine	8.1L 495.9 (8129cc) OHV Turbo-Diesel L6 116mm Bore (PowerTech 2V AC)	119
9560STS ... Combine	6.8L 413.8 (6784cc) OHV Turbo-Diesel L6 106mm Bore (PowerTech 4V IC)	103	9760STS ... Combine	8.1L 495.9 (8129cc) OHV Turbo-Diesel L6 116mm Bore (PowerTech 2V IC)	118
9560STS ... Combine	8.1L 495.9 (8129cc) OHV Turbo-Diesel L6 116mm Bore (PowerTech 2V IC)	118	9760STS ... Combine	8.1L 495.9 (8129cc) OHV Turbo-Diesel L6 116mm Bore (PowerTech 2V AC)	119
9560STS ... Combine	8.1L 495.9 (8129cc) OHV Turbo-Diesel L6 116mm Bore (PowerTech 2V AC)	119	9900 ... Cotton Picker	5.0L 303 OHV L6 3.8594" Bore	72
9560WTS ... Combine	6.8L 413.8 (6784cc) OHV Turbo-Diesel L6 106mm Bore (PowerTech 4V IC)	103	9900 ... Cotton Picker	5.0L 303 OHV LPG L6 3.8594" Bore	74
9610 ... Combine	8.1L 495.9 (8129cc) OHV Turbo-Diesel L6 116mm Bore (PowerTech 2V IC)	118	9900 ... Cotton Picker	5.4L 329 OHV Diesel L6 4.0156" Bore	78
9610 ... Combine	8.1L 495.9 (8129cc) OHV Turbo-Diesel L6 116mm Bore (PowerTech 2V AC)	119	9910 ... Cotton Picker	5.0L 303 OHV L6 3.8594" Bore	72
9640 ... Combine	8.1L 495.9 (8129cc) OHV Turbo-Diesel L6 116mm Bore (PowerTech 2V IC)	118	9910 ... Cotton Picker	5.0L 303 OHV LPG L6 3.8594" Bore	74
9650 ... Combine	8.1L 495.9 (8129cc) OHV Turbo-Diesel L6 116mm Bore (PowerTech 2V IC)	118	9910 ... Cotton Picker	5.9L 359 OHV Diesel L6 4.1875" Bore	85
9650 ... Combine	8.1L 495.9 (8129cc) OHV Turbo-Diesel L6 116mm Bore (PowerTech 2V AC)	119	992D LC ... Excavator	10.1L 619 OHV Turbo-Diesel L6 5.125" Bore	127
9650CTS ... Combine	8.1L 495.9 (8129cc) OHV Turbo-Diesel L6 116mm Bore (PowerTech 2V IC)	118	9920 ... Cotton Picker	5.9L 359 OHV Diesel L6 4.1875" Bore	85
9650CTS ... Combine	8.1L 495.9 (8129cc) OHV Turbo-Diesel L6 116mm Bore (PowerTech 2V AC)	119	9930 ... Cotton Picker	5.9L 359 OHV Turbo-Diesel L6 4.1875" Bore	86
9650STS ... Combine	8.1L 495.9 (8129cc) OHV Turbo-Diesel L6 116mm Bore (PowerTech 2V IC)	118	9935 ... Cotton Picker	6.8L 413.8 (6784cc) OHV Turbo-Diesel L6 106mm Bore (PowerTech 2V)	108
9650STS ... Combine	8.1L 495.9 (8129cc) OHV Turbo-Diesel L6 116mm Bore (PowerTech 2V AC)	119	9940 ... Cotton Picker	7.6L 466 OHV Turbo-Diesel L6 4.5625" Bore (Standard)	114
9660 ... Combine	8.1L 495.9 (8129cc) OHV Turbo-Diesel L6 116mm Bore (PowerTech 2V IC)	118	9950 ... Cotton Picker	7.6L 466 OHV Turbo-Diesel L6 4.5625" Bore (Standard)	114
9660 ... Combine	8.1L 495.9 (8129cc) OHV Turbo-Diesel L6 116mm Bore (PowerTech 2V AC)	119	9970 ... Cotton Picker	6.8L 413.8 (6784cc) OHV Turbo-Diesel L6 106mm Bore (PowerTech 4V IC)	103
9660CTS ... Combine	8.1L 495.9 (8129cc) OHV Turbo-Diesel L6 116mm Bore (PowerTech 2V IC)	118	9970 ... Cotton Picker	8.1L 495.9 (8129cc) OHV Turbo-Diesel L6 116mm Bore (PowerTech 2V IC)	118
9660CTS ... Combine	8.1L 495.9 (8129cc) OHV Turbo-Diesel L6 116mm Bore (PowerTech 2V AC)	119	9970 ... Cotton Picker	8.1L 495.9 (8129cc) OHV Turbo-Diesel L6 116mm Bore (PowerTech 2V AC)	119
9660STS ... Combine	8.1L 495.9 (8129cc) OHV Turbo-Diesel L6 116mm Bore (PowerTech 2V IC)	118	9970 ... Cotton Picker	8.1L 495.9 (8129cc) OHV Turbo-Diesel L6 116mm Bore (PowerTech 2V)	121
9660STS ... Combine	8.1L 495.9 (8129cc) OHV Turbo-Diesel L6 116mm Bore (PowerTech 2V AC)	119	9976 ... Cotton Picker	8.1L 495.9 (8129cc) OHV Turbo-Diesel L6 116mm Bore (PowerTech 2V IC)	118
			9976 ... Cotton Picker	8.1L 495.9 (8129cc) OHV Turbo-Diesel L6 116mm Bore (PowerTech 2V AC)	119
			9986 ... Cotton Picker	8.1L 495.9 (8129cc) OHV Turbo-Diesel L6 116mm Bore (PowerTech 2V IC)	118
			9986 ... Cotton Picker	8.1L 495.9 (8129cc) OHV Turbo-Diesel L6 116mm Bore (PowerTech 2V AC)	119

# John Deere Off Highway



<b>1 Power Unit NXA Eng.</b> .9L 57 L-HEAD L2, 3" Bore (Hercules Eng.)				
<b>CYL. HEAD &amp; PARTS</b>				
<b>QTY</b>	<b>VALVE</b>	<b>PART NO.</b>	<b>SIZE</b>	<b>DESCRIPTION</b>
2	Intake	FP-V429		1.4840" Head Dia., .3100" Stem Dia., 3.9260" O.A.L.
2	Exhaust	FP-V428		1.3583" Head Dia., .3100" Stem Dia., 3.9213" O.A.L.
<b>QTY</b>	<b>VALVE GUIDE</b>	<b>PART NO.</b>	<b>SIZE</b>	<b>DESCRIPTION</b>
4	Guide	FP-VG930		.485" OD; 3/8" Counterbore; .3120" ID, 2.0940" O.A.L.
4	Guide	FP-VG456		.532" OD; .3120" ID, 2.0940" O.A.L.
<b>QTY</b>	<b>VALVE SPRING</b>	<b>PART NO.</b>	<b>SIZE</b>	<b>DESCRIPTION</b>
4	Spring	FP-VS622		1.7650" Free Height
<b>CYLINDER COMPONENTS</b>				
<b>QTY</b>	<b>CONNECTING RODS &amp; BRGS.</b>	<b>PART NO.</b>	<b>SIZE</b>	<b>DESCRIPTION</b>
2	Rod Pair	FP-1450SB	STD	
2	Rod Pair	FP-1450SB10	10	
2	Rod Pair	FP-1450SB20	20	
2	Rod Pair	FP-1450SB30	30	
<b>2 Power Unit NXB Eng.</b> 1.1L 66 L-HEAD L2, 3.25" Bore (Hercules Eng.)				
<b>CYL. HEAD &amp; PARTS</b>				
<b>QTY</b>	<b>VALVE</b>	<b>PART NO.</b>	<b>SIZE</b>	<b>DESCRIPTION</b>
2	Intake	FP-V429		1.4840" Head Dia., .3100" Stem Dia., 3.9260" O.A.L.
2	Exhaust	FP-V428		1.3583" Head Dia., .3100" Stem Dia., 3.9213" O.A.L.
<b>QTY</b>	<b>VALVE GUIDE</b>	<b>PART NO.</b>	<b>SIZE</b>	<b>DESCRIPTION</b>
4	Guide	FP-VG930		.485" OD; 3/8" Counterbore; .3120" ID, 2.0940" O.A.L.
4	Guide	FP-VG456		.532" OD; .3120" ID, 2.0940" O.A.L.
<b>QTY</b>	<b>VALVE SPRING</b>	<b>PART NO.</b>	<b>SIZE</b>	<b>DESCRIPTION</b>
4	Spring	FP-VS622		1.7650" Free Height
<b>CYLINDER COMPONENTS</b>				
<b>QTY</b>	<b>CONNECTING RODS &amp; BRGS.</b>	<b>PART NO.</b>	<b>SIZE</b>	<b>DESCRIPTION</b>
2	Rod Pair	FP-1450SB	STD	
2	Rod Pair	FP-1450SB10	10	
2	Rod Pair	FP-1450SB20	20	
2	Rod Pair	FP-1450SB30	30	
<b>3 Wheel Tractor M Eng.</b> 1.6L 100 OHV L2, 4" Bore				
<b>CYL. HEAD &amp; PARTS</b>				
<b>QTY</b>	<b>GASKETS</b>	<b>PART NO.</b>	<b>SIZE</b>	<b>DESCRIPTION</b>
1	Head Set	FP-PG100HS		
<b>QTY</b>	<b>VALVE</b>	<b>PART NO.</b>	<b>SIZE</b>	<b>DESCRIPTION</b>
8	Keeper	FP-B367R		2 groove
8	Keeper	VK-66R		2 groove; Hardened
<b>QTY</b>	<b>VALVE SEAT</b>	<b>PART NO.</b>	<b>SIZE</b>	<b>DESCRIPTION</b>
2	Int.	FP-24518125		1.8175" OD, 1.5000" ID, .2480" Depth
<b>QTY</b>	<b>VALVE GUIDE</b>	<b>PART NO.</b>	<b>SIZE</b>	<b>DESCRIPTION</b>
4	Guide	FP-VG570		.3750" ID, 3.3400" O.A.L.
<b>ENGINE BLOCK &amp; PARTS</b>				
<b>QTY</b>	<b>GASKET SETS</b>	<b>PART NO.</b>	<b>SIZE</b>	<b>DESCRIPTION</b>
1	Complete Overhaul Gasket Set	FP-PG100FS		
<b>QTY</b>	<b>CAM BEARINGS</b>	<b>PART NO.</b>	<b>SIZE</b>	<b>DESCRIPTION</b>
1	Cam Set	FP-1475M	STD	Late Engs.
<b>CRANKSHAFT/OIL PUMP</b>				
<b>QTY</b>	<b>MAIN BEARINGS</b>	<b>PART NO.</b>	<b>SIZE</b>	<b>DESCRIPTION</b>
1	Main Set	FP-4003M	STD	
1	Main Set	FP-4003M10	10	
1	Main Set	FP-4003M20	20	
1	Main Set	FP-4003M30	30	

(continued on next page)





Wheel Tractor M Eng. **3**  
1.6L 100 OHV L2, 4" Bore (cont.)

## CYLINDER COMPONENTS

QTY	LINERS	PART NO.	SIZE	DESCRIPTION
1	Repair Sleeve	SL-22Y Std Only		1/8" wall, must be cut to correct length; O.A.L. 10.250"
1	Repair Sleeve	SL-22M Std Only		3/32" wall, must be cut to correct length; O.A.L. 10.250"
QTY	PISTONS	PART NO.	SIZE	DESCRIPTION
2	Piston Kit w/Pin & Retainers	FP-A1276P	STD	Models M, 320
2	Piston Kit w/Pin & Retainers	FP-A1276P45	45	Models M, 320
2	Piston Kit w/Pin & Retainers	FP-A1276P90	90	Models M, 320
2	Piston Kit w/Pin & Retainers	FP-A1276P125	125	Models M, 320
2	Pin Bushing	FP-2204Y		Late Engs.
QTY	CONNECTING RODS & BRGS.	PART NO.	SIZE	DESCRIPTION
2	Rod Pair	FP-2205CP	STD	Early Engs.
2	Rod Pair	FP-2205CP10	10	Early Engs.
2	Rod Pair	FP-2205CP20	20	Early Engs.
2	Rod Pair	FP-2205CP30	30	Early Engs.
2	Rod Pair	FP-2210SB	STD	Late Engs.
2	Rod Pair	FP-2210SB10	10	Late Engs.
2	Rod Pair	FP-2210SB20	20	Late Engs.
2	Rod Pair	FP-2210SB30	30	Late Engs.
2	Rod Pair	FP-2210SB40	40	Late Engs.
QTY	PISTON RINGS	PART NO.	SIZE	DESCRIPTION
1	Premium Set	FP-5362KX	STD	Model 40; 3-3/32, 1-1/4
1	Premium Set	FP-5362KX40	40	Model 40; 3-3/32, 1-1/4
1	Standard Set	FP-5079X	STD	Models M, MT; 2-5/32, 1-1/8, 1-1/4

Wheel Tractor 2-53 (2-Valve Cyl. Head), 2-53N (4-Valve Cyl. Head) Engs. **4**  
1.7L 106 OHV Diesel L2, 3.875" Bore (Detroit Diesel Eng.)

## CYL. HEAD & PARTS

QTY	GASKETS	PART NO.	SIZE	DESCRIPTION
2	Head Gasket	FP-5121254		
1	Head Set	FP-5199809		
QTY	VALVE	PART NO.	SIZE	DESCRIPTION
4	Exhaust	FP-5116137		2-53 Engs.
8	Exhaust	FP-5145172		2-53N Engs.
8	Exhaust	FP-5109925		2-53N Engs.; Optional-H/D
4	Exhaust Valve Kit	FP-5195948		2-53 Engs.; 30 Deg.
8	Keeper	FP-5111337		2-53 Engs.; 1 groove; Square cut key groove
8	Keeper	VK-144		2-53 Engs.; 1 groove; Square cut key groove
8	Keeper	VK-144R		2-53 Engs.; 1 groove; Square cut key groove; Hardened
16	Keeper	FP-5116341		2-53N Engs.
QTY	VALVE SEAT	PART NO.	SIZE	DESCRIPTION
4	Exh.	FP-5116196	STD	2-53 Engs.
8	Exh.	FP-8921501	STD	2-53N Engs.; 30 Deg. seat; 1.1610" OD, .0910" ID, .2220" Depth
QTY	VALVE GUIDE	PART NO.	SIZE	DESCRIPTION
4	Guide	FP-5129919		2-53 Engs.; Cut for seal; 2 3/8" length; .3130" ID, 2.3800" O.A.L.
8	Guide	FP-5131961		2-53N Engs.; Use w/seal; .2510" ID, 2.3600" O.A.L.
QTY	VALVE SPRING	PART NO.	SIZE	DESCRIPTION
4	Spring	FP-5116140		2-53 Engs.
8	Spring	FP-5144019		2-53N Engs.; Hi-lift camshaft stamped V, V7; .135" Wire Dia.
8	Spring	FP-5147424		2-53N Engs.; Lo-lift camshaft stamped V7L; .148" Wire Dia.
QTY	PUSH RODS	PART NO.	SIZE	DESCRIPTION
6	Push Rod	FP-5128640		
6	Push Rod Seat	FP-5123250		Lower
6	Push Rod Seat	FP-5108919		Upper; Cup type
6	Push Rod Seat	FP-5150302		Upper; Flange type
6	Push Rod Spring	FP-5108918		w/2 orange stripes; .192" Wire diameter
6	Push Rod Spring	FP-5186858		Valve & injector; .177" Wire diameter
6	Push Rod Retainer	FP-5150303		
6	Lock Nut	FP-5151601		Push rod; 5/16" - 24
QTY	VALVE SEAL	PART NO.	SIZE	DESCRIPTION
4	Valve Stem Seal	FP-8921209		2-53 Engs.; Use w/FP-5129919 guide
QTY	ROCKER PARTS	PART NO.	SIZE	DESCRIPTION
2	Arm Assy.	FP-8923554		Injector
2	Rocker Shaft	FP-5116072		
4	Arm Support	FP-5116128		

(continued on next page)

<b>4 Wheel Tractor 2-53 (2-Valve Cyl. Head), 2-53N (4-Valve Cyl. Head) Engs.</b>				
<b>(cont.) 1.7L 106 OHV Diesel L2, 3.875" Bore (Detroit Diesel Eng.)</b>				
<b>CYL. HEAD &amp; PARTS (cont.)</b>				
<b>QTY</b>	<b>ROCKER PARTS (cont.)</b>	<b>PART NO.</b>	<b>SIZE</b>	<b>DESCRIPTION</b>
2	Rocker Bushing	FP-8924355		Large
2	Rocker Bushing	FP-8924354		Injector; Small
6	Follower Assy.	FP-8924439		2-53 Engs.
6	Cam Follower Roller Set	FP-8923814		2-53 Engs.; Incl. pin & roller
6	Rocker Arm Clevis Pin	FP-5150314		
<b>CAMSHAFT GROUP</b>				
<b>QTY</b>	<b>CAMSHAFT/LIFTER</b>	<b>PART NO.</b>	<b>SIZE</b>	<b>DESCRIPTION</b>
2	Camshaft Thrust Washer	FP-5116198		
4	Bolt	FP-443603		Cam guide; .250" x 20 x .750"
4	Lock Washer	FP-103319		Cam guide; .250"
2	Oil Seal	FP-23516871		
<b>FUEL SYSTEM &amp; PARTS</b>				
<b>QTY</b>	<b>FUEL INJECTION</b>	<b>PART NO.</b>	<b>SIZE</b>	<b>DESCRIPTION</b>
2	Fuel Injector Seal Ring	FP-5104701		Viton®
18	Injector Hole Tube Kit	FP-8925981		Viton®
<b>GOVERNOR</b>				
<b>QTY</b>	<b>GOVERNOR</b>	<b>PART NO.</b>	<b>SIZE</b>	<b>DESCRIPTION</b>
1	Governor to Cyl. Block Gasket	FP-5116336		Front; End plate
<b>ENGINE BLOCK &amp; PARTS</b>				
<b>QTY</b>	<b>GASKETS</b>	<b>PART NO.</b>	<b>SIZE</b>	<b>DESCRIPTION</b>
1	Cylinder Cover Gasket	FP-5116354		Front; End plate
<b>QTY</b>	<b>GASKET SETS</b>	<b>PART NO.</b>	<b>SIZE</b>	<b>DESCRIPTION</b>
1	Complete Overhaul Gasket Set	FP-23517625		Crankshaft seals not incl.
1	Complete Overhaul Gasket Set	FP-23517625WS		Incl. front & rear seals; Incl. Front & Rear Seals
<b>QTY</b>	<b>CAM BEARINGS</b>	<b>PART NO.</b>	<b>SIZE</b>	<b>DESCRIPTION</b>
1	Cam Set	FP-5198431	STD	
1	Cam Set	FP-5198468	10	
1	Cam Set	FP-5198469	20	
<b>CRANKSHAFT/OIL PUMP</b>				
<b>QTY</b>	<b>SEALS - FRONT CRANK</b>	<b>PART NO.</b>	<b>SIZE</b>	<b>DESCRIPTION</b>
1	Wear Sleeve	FP-5198502		Use w/FP-5198503
1	Oil Seal	FP-5116224		Single lip
1	Oil Seal	FP-5198503		Single lip O/S ID
<b>QTY</b>	<b>SEALS - REAR CRANK</b>	<b>PART NO.</b>	<b>SIZE</b>	<b>DESCRIPTION</b>
1	Oil Seal	FP-5128917		Double lip; Wet only; Double Lip
1	Oil Seal	FP-5116229		Single lip
1	Oil Seal	FP-5196852		Single lip O/S ID
1	Wear Sleeve	FP-23516636		Use w/O/S seal only
<b>QTY</b>	<b>MAIN BEARINGS</b>	<b>PART NO.</b>	<b>SIZE</b>	<b>DESCRIPTION</b>
3	Plain Main Brg.	FP-8924357	STD	
3	Plain Main Brg.	FP-8924358	2	
3	Plain Main Brg.	FP-8924359	10	
3	Plain Main Brg.	FP-8924360	20	
3	Plain Main Brg.	FP-8924361	30	
1	Thrust Washer Set	FP-5116197S	STD	Position Rear
4	Thrust Washer	FP-5116197	STD	Position Rear
4	Thrust Washer	FP-5196755	5	Position Rear
4	Thrust Washer	FP-5196756	10	Position Rear
<b>CYLINDER COMPONENTS</b>				
<b>QTY</b>	<b>LINERS</b>	<b>PART NO.</b>	<b>SIZE</b>	<b>DESCRIPTION</b>
2	Liner w/o Sealing Ring	FP-5132803	STD	.840" Port Height
2	Liner w/o Sealing Ring	FP-5101016	10	.840" Port Height
2	Liner w/o Sealing Ring	FP-5149944	20	.840" Port Height
2	Liner w/Sealing Rings	FP-5132803WS	STD	Incl. (2) FP-5121256 sealing rings; Firewall type w/.840" Port length
2	Cylinder Kit Complete	FP-5198903	STD	2-53 Engs.; Trunk type; Trunk style piston; 17:1 C.R.
2	Cylinder Kit Complete	FP-519890310	10	2-53 Engs.; Trunk type; Trunk style piston; 17:1 C.R.
2	Cylinder Kit Complete	FP-519890320	20	2-53 Engs.; Trunk type; Trunk style piston; 17:1 C.R.
2	Cylinder Kit Complete	FP-5198899	STD	2-53N Engs.; Trunk style piston; 21:1 C.R.
2	Cylinder Kit Complete	FP-519889910	10	2-53N Engs.; Trunk style piston; 21:1 C.R.
2	Cylinder Kit Complete	FP-5198904	STD	2-53N Engs.; Trunk type; Trunk style piston; 21:1 C.R.
2	Cylinder Kit Complete	FP-519890410	10	2-53N Engs.; Trunk type; Trunk style piston; 21:1 C.R.

(continued on next page)



# John Deere Off Highway

**Wheel Tractor 2-53 (2-Valve Cyl. Head), 2-53N (4-Valve Cyl. Head) Engs. 4**  
1.7L 106 OHV Diesel L2, 3.875" Bore (Detroit Diesel Eng.) (cont.)

### CYLINDER COMPONENTS (cont.)

QTY	LINERS (cont.)	PART NO.	SIZE	DESCRIPTION
2	Cylinder Kit Complete	FP-519890420	20	2-53N Engs.; Trunk type; Trunk style piston; 21:1 C.R.
4	Sealing Ring, Liner	FP-5121256		.010 O/S
QTY	PISTONS	PART NO.	SIZE	DESCRIPTION
2	Piston With Retainers	FP-5195931		2-53 Engs.; Trunk style piston
2	Piston With Retainers	FP-5198877		2-53N Engs.; Trunk style piston
2	Pin	FP-5116189		2-53N Engs.
4	Piston Pin Retainer	FP-5180250		
4	Pin Bushing	FP-5116181		2 req'd. per rod
QTY	CONNECTING RODS & BRGS.	PART NO.	SIZE	DESCRIPTION
2	Rod Pair	FP-5149452	STD	
2	Rod Pair	FP-5149454	10	
2	Rod Pair	FP-5149455	20	
2	Rod Pair	FP-5149456	30	
2	Rod Pair	FP-514945240	40	
QTY	PISTON RINGS	PART NO.	SIZE	DESCRIPTION
2	Ring Set Single Cylinder	FP-5198822	STD	1-.082, 3-3/32, 2-3/16 (1 cyl. set)
KITS				
QTY	OVERHAUL KIT	PART NO.	SIZE	DESCRIPTION
1	In-Frame Overhaul Kit	FP-253		2-53 Engs.; w/Trunk style piston
1	Complete Overhaul Kit	FP-253OH		2-53 Engs.; w/Trunk style piston

**Hay Baler VF4, VF4D, VF41, VH4, VH4D, VH4DM Engs. Power Unit VF4, VF4D, VF41, VH4, 5**  
**VH4D, VH4DM Engs. Windrower VF4, VF4D, VF41, VH4, VH4D, VH4DM Engs.**  
1.8L 108 L-HEAD V4, 3.25" Bore (Wisconsin Eng.)

### CYL. HEAD & PARTS

QTY	VALVE	PART NO.	SIZE	DESCRIPTION
8	Intake	FP-V816		Exh. & Int.; 1.3130" Head Dia., .3085" Stem Dia., 4.7660" O.A.L.
4	Exhaust	FP-V1326X		Optional-H/D; 1.2500" Head Dia., .3085" Stem Dia., 4.7710" O.A.L.
16	Keeper	FP-VK144		1 groove; Square cut key groove
16	Keeper	VK-144R		1 groove; Square cut key groove; Hardened
16	Keeper, Bulk	FP-VK144B		1 groove; Square cut key groove; Carton of 1000
QTY	VALVE SEAT	PART NO.	SIZE	DESCRIPTION
8	Exh. & Int.	FP-24513755		1.3795" OD, 1.1250" ID, .2636" Depth
QTY	VALVE GUIDE	PART NO.	SIZE	DESCRIPTION
8	Guide	FP-VG635		.3155" ID, 2.5000" O.A.L.
8	Guide	FP-VG681		VF Series Engs.; .439" x 1.812"; .3133" ID, 1.8100" O.A.L.
QTY	VALVE SPRING	PART NO.	SIZE	DESCRIPTION
8	Spring	FP-VS793		Use w/RC-45 rotocap; VF Series Engs.; 1.9700" Free Height
8	Spring	FP-VS468		2.3120" Free Height

### CAMSHAFT GROUP

QTY	TIMING	PART NO.	SIZE	DESCRIPTION
1	Cam Gear	FP-2214108		VF4 & VH4D Engs.; 48 Teeth

### CYLINDER COMPONENTS

QTY	LINERS	PART NO.	SIZE	DESCRIPTION
4	Repair Sleeve	FP-SL11M		3/32" wall, must be cut to correct length
QTY	PISTONS	PART NO.	SIZE	DESCRIPTION
4	Cast Piston	FP-628CP	STD	Cast; Use w/FP5051X or FP5051KX series ring set; 3-3/32", 1-3/16" Ring Groove, 1.500" CD, .7503" Pin Dia., Recessed Head .010" deep; Piston length 2.870"; Repl. 3 ring piston in sets only
4	Cast Piston	FP-628CP20	20	Cast; 2-3/32", 1-3/16" Ring Groove, 1.500" CD, .7503" Pin Dia., Recessed Head .010" deep; Piston length 2.870"; Repl. 3 ring piston in sets only
4	Cast Piston	FP-628CP30	30	Cast; 2-3/32", 1-3/16" Ring Groove, 1.500" CD, .7503" Pin Dia., Recessed Head .010" deep; Piston length 2.870"; Repl. 3 ring piston in sets only
4	Cast Piston	FP-628CP40	40	Cast; 2-3/32", 1-3/16" Ring Groove, 1.500" CD, .7503" Pin Dia., Recessed Head .010" deep; Piston length 2.870"; Repl. 3 ring piston in sets only

(continued on next page)

**5 Hay Baler VF4, VF4D, VF41, VH4, VH4D, VH4DM Engs. Power Unit VF4, VF4D, VF41, VH4, (cont.) VH4D, VH4DM Engs. Windrower VF4, VF4D, VF41, VH4, VH4D, VH4DM Engs.**  
1.8L 108 L-HEAD V4, 3.25" Bore (Wisconsin Eng.)

**CYLINDER COMPONENTS (cont.)**

QTY	PISTONS (cont.)	PART NO.	SIZE	DESCRIPTION
4	Cast Piston	FP-628CP60	60	Cast; 2-3/32", 1-3/16" Ring Groove, 1.500" CD, .7503" Pin Dia., Recessed Head .010" deep; Piston length 2.870"; Repl. 3 ring piston in sets only
4	Cast Piston - Individual	FP-W628CP	STD	Cast; Use w/FP5051X or FP5051KX series ring set; 3-3/32", 1-3/16" Ring Groove, 1.500" CD, .7500" Pin Dia., Recessed Head .010" deep; Piston length 2.870"; Repl. 3 ring piston in sets only
4	Cast Piston - Individual	FP-W628CP20	20	Cast; 2-3/32", 1-3/16" Ring Groove, 1.500" CD, .7500" Pin Dia., Recessed Head .010" deep; Piston length 2.870"; Repl. 3 ring piston in sets only
4	Cast Piston - Individual	FP-W628CP30	30	Cast; 2-3/32", 1-3/16" Ring Groove, 1.500" CD, .7500" Pin Dia., Recessed Head .010" deep; Piston length 2.870"; Repl. 3 ring piston in sets only
4	Cast Piston - Individual	FP-W628CP40	40	Cast; 2-3/32", 1-3/16" Ring Groove, 1.500" CD, .7500" Pin Dia., Recessed Head .010" deep; Piston length 2.870"; Repl. 3 ring piston in sets only
4	Cast Piston - Individual	FP-W628CP60	60	Cast; 2-3/32", 1-3/16" Ring Groove, 1.500" CD, .7500" Pin Dia., Recessed Head .010" deep; Piston length 2.870"; Repl. 3 ring piston in sets only
4	Pin Bushing	FP-1394		1.000" max. length
4	Pin Bushing	1394 +		1.000" max. length; When depleted use FP-1394
QTY	CONNECTING RODS & BRGS.	PART NO.	SIZE	DESCRIPTION
4	Rod Pair	FP-3520CP		VF4, VF4D Engs.
4	Rod Pair	FP-3520CP10		VF4, VF4D Engs.
4	Rod Pair	FP-3520CP20		VF4, VF4D Engs.
4	Rod Pair	FP-3645CP		VH4, VH4D, VH4DM Engs.
4	Rod Pair	FP-3645CP10		VH4, VH4D, VH4DM Engs.
4	Rod Pair	FP-3645CP20		VH4, VH4D, VH4DM Engs.
QTY	PISTON RINGS	PART NO.	SIZE	DESCRIPTION
1	Premium Set	FP-5051KX	STD	3-3/32, 1-3/16
1	Premium Set	FP-5051KX20	20	3-3/32, 1-3/16
1	Premium Set	FP-5051KX40	40	3-3/32, 1-3/16
1	Premium Set	FP-5051KX60	60	3-3/32, 1-3/16
1	Standard Set	FP-10366X	STD	VF4D Engs.; 3-5/64, 1-3/16
1	Standard Set	FP-5051X	STD	3-3/32, 1-3/16
1	Standard Set	FP-5051X20	20	3-3/32, 1-3/16
1	Standard Set	FP-5051X30	30	3-3/32, 1-3/16
1	Standard Set	FP-5051X40	40	3-3/32, 1-3/16
1	Standard Set	FP-5051X60	60	3-3/32, 1-3/16
4	Premium Single Cylinder Set	W-5051KX20	20-30-60	3-3/32, 1-3/16
4	Premium Single Cylinder Set	W-5051KX30	20-30-60	3-3/32, 1-3/16
4	Premium Single Cylinder Set	W-5051KX60	20-30-60	3-3/32, 1-3/16
4	Standard Single Cylinder Set	W-5051X	Std-30	3-3/32, 1-3/16
4	Standard Single Cylinder Set	W-5051X30	Std-30	3-3/32, 1-3/16

**6 Combine IXA Eng.**  
1.9L 113 L-HEAD L4, 3" Bore (Hercules Eng.)

**CYL. HEAD & PARTS**

QTY	VALVE	PART NO.	SIZE	DESCRIPTION
4	Intake	FP-V429		1.4840" Head Dia., .3100" Stem Dia., 3.9260" O.A.L.
4	Exhaust	FP-V428		1.3583" Head Dia., .3100" Stem Dia., 3.9213" O.A.L.
QTY	VALVE GUIDE	PART NO.	SIZE	DESCRIPTION
8	Guide	FP-VG930		.485" OD; 3/8" Counterbore; .3120" ID, 2.0940" O.A.L.
8	Guide	FP-VG456		.532" OD; .3120" ID, 2.0940" O.A.L.
QTY	VALVE SPRING	PART NO.	SIZE	DESCRIPTION
8	Spring	FP-VS622		1.7650" Free Height

**CYLINDER COMPONENTS**

QTY	CONNECTING RODS & BRGS.	PART NO.	SIZE	DESCRIPTION
4	Rod Pair	FP-1450SB	STD	
4	Rod Pair	FP-1450SB10	10	

(continued on next page)



# John Deere Off Highway

*Combine IXA Eng. 6*  
1.9L 113 L-HEAD L4, 3" Bore (Hercules Eng.) (cont.)

<b>CYLINDER COMPONENTS (cont.)</b>				
QTY	CONNECTING RODS & BRGS. (cont.)	PART NO.	SIZE	DESCRIPTION
4	Rod Pair	FP-1450SB20	20	
4	Rod Pair	FP-1450SB30	30	
QTY	PISTON RINGS	PART NO.	SIZE	DESCRIPTION
1	Standard Set	FP-617X	STD	2-1/8, 1-3/16

*Wheel Tractor 420, 430, 440 Engs. 7*  
1.9L 113 OHV L2, 4.25" Bore

<b>CYL. HEAD &amp; PARTS</b>				
QTY	VALVE	PART NO.	SIZE	DESCRIPTION
8	Keeper	FP-B367R		2 groove
8	Keeper	VK-66R		2 groove; Hardened

<b>ENGINE BLOCK &amp; PARTS</b>				
QTY	GASKET SETS	PART NO.	SIZE	DESCRIPTION
1	Complete Overhaul Gasket Set	FP-PG113FS		
QTY	CAM BEARINGS	PART NO.	SIZE	DESCRIPTION
1	Cam Set	FP-1475M	STD	Late Engs.

<b>CRANKSHAFT/OIL PUMP</b>				
QTY	MAIN BEARINGS	PART NO.	SIZE	DESCRIPTION
1	Main Set	FP-4003M	STD	
1	Main Set	FP-4003M10	10	
1	Main Set	FP-4003M20	20	
1	Main Set	FP-4003M30	30	

<b>CYLINDER COMPONENTS</b>				
QTY	PISTONS	PART NO.	SIZE	DESCRIPTION
2	Pin Bushing	FP-2204Y		Late Engs.
QTY	CONNECTING RODS & BRGS.	PART NO.	SIZE	DESCRIPTION
2	Rod Pair	FP-2205CP	STD	Early Engs.
2	Rod Pair	FP-2205CP10	10	Early Engs.
2	Rod Pair	FP-2205CP20	20	Early Engs.
2	Rod Pair	FP-2205CP30	30	Early Engs.
2	Rod Pair	FP-2210SB	STD	Late Engs.
2	Rod Pair	FP-2210SB10	10	Late Engs.
2	Rod Pair	FP-2210SB20	20	Late Engs.
2	Rod Pair	FP-2210SB30	30	Late Engs.
2	Rod Pair	FP-2210SB40	40	Late Engs.
QTY	PISTON RINGS	PART NO.	SIZE	DESCRIPTION
2	Ring Set Single Cylinder	FP-W5589KX	STD	
1	Premium Set	FP-5589KX	STD	3-3/32, 1-1/4 (2 cyl. set)

*Combine 115G Eng. Power Unit 115G Eng. Wheel Tractor 115G Eng. Windrower 115G Eng. 8*  
*Crawler Tractor 115G Eng.*  
1.9L 115 OHV L4, 3.5" Bore

<b>CYL. HEAD &amp; PARTS</b>				
QTY	VALVE	PART NO.	SIZE	DESCRIPTION
4	Intake	FP-V1629		1.6880" Head Dia., .3415" Stem Dia., 4.7750" O.A.L.
4	Exhaust	FP-V3922		1.3750" Head Dia., .3415" Stem Dia., 4.7780" O.A.L.
16	Keeper	VK-63		2 groove; Round key groove
QTY	VALVE GUIDE	PART NO.	SIZE	DESCRIPTION
8	Guide	FP-VG576		.3440" ID, 2.3750" O.A.L.
QTY	VALVE SPRING	PART NO.	SIZE	DESCRIPTION
8	Spring	FP-VS1430		2.1250" Free Height
QTY	VALVE SEAL	PART NO.	SIZE	DESCRIPTION
8	Valve Stem Seal	ST-2001		Positive type; Installation requires valve guide machining; Rubber/PTFE
8	Valve Stem Seal Bulk	ST-2001BC		Positive type; Installation requires valve guide machining; Carton of 100; Rubber/PTFE

(continued on next page)

# John Deere Off Highway



**8** Combine 115G Eng. Power Unit 115G Eng. Wheel Tractor 115G Eng. Windrower 115G Eng.  
 (cont.) Crawler Tractor 115G Eng.  
 1.9L 115 OHV L4, 3.5" Bore

### ENGINE BLOCK & PARTS

QTY	GASKET SETS	PART NO.	SIZE	DESCRIPTION
1	Complete Overhaul Gasket Set	FP-PG115FS		
QTY	CAM BEARINGS	PART NO.	SIZE	DESCRIPTION
1	Cam Set	FP-1251M	STD	

### CRANKSHAFT/OIL PUMP

QTY	SEALS - REAR CRANK	PART NO.	SIZE	DESCRIPTION
1	Crankshaft Rear Seal	FP-RE24959		
QTY	MAIN BEARINGS	PART NO.	SIZE	DESCRIPTION
1	Main Set	FP-4344M	STD	From Ser. No. 15,083
1	Main Set	FP-4344M10	10	From Ser. No. 15,083
1	Main Set	FP-4344M20	20	From Ser. No. 15,083
1	Main Set	FP-4144M	STD	To Ser. No. 15,082
1	Main Set	FP-4144M10	10	To Ser. No. 15,082
1	Main Set	FP-4144M20	20	To Ser. No. 15,082

### CYLINDER COMPONENTS

QTY	PISTONS	PART NO.	SIZE	DESCRIPTION
4	Pin Bushing	FP-2599Y20		To Ser. No. 15,082
QTY	CONNECTING RODS & BRGS.	PART NO.	SIZE	DESCRIPTION
4	Rod Pair	FP-2595A	STD	A-Series aluminum bearings
4	Rod Pair	FP-2595A10	10	A-Series aluminum bearings
4	Rod Pair	FP-2595A20	20	A-Series aluminum bearings
4	Rod Pair	FP-2595A30	30	A-Series aluminum bearings
QTY	PISTON RINGS	PART NO.	SIZE	DESCRIPTION
2	Premium Set	FP-5835KX	STD	3-3/32, 1-3/16 (2 cyl. set)
4	Premium Single Cylinder Set	W-5835KX Std Only		3-3/32, 1-3/16 (1 cyl. set)

**9** Combine IXB Eng.  
 2.2L 133 L-HEAD L4, 3.25" Bore (Hercules Eng.)

### CYL. HEAD & PARTS

QTY	VALVE	PART NO.	SIZE	DESCRIPTION
4	Intake	FP-V429		1.4840" Head Dia., .3100" Stem Dia., 3.9260" O.A.L.
4	Exhaust	FP-V428		1.3583" Head Dia., .3100" Stem Dia., 3.9213" O.A.L.
QTY	VALVE GUIDE	PART NO.	SIZE	DESCRIPTION
8	Guide	FP-VG930		.485" OD; 3/8" Counterbore; .3120" ID, 2.0940" O.A.L.
8	Guide	FP-VG456		.532" OD; .3120" ID, 2.0940" O.A.L.
QTY	VALVE SPRING	PART NO.	SIZE	DESCRIPTION
8	Spring	FP-VS622		1.7650" Free Height

### CYLINDER COMPONENTS

QTY	CONNECTING RODS & BRGS.	PART NO.	SIZE	DESCRIPTION
4	Rod Pair	FP-1450SB	STD	W/1.7470-1.7480" standard shaft size
4	Rod Pair	FP-1450SB10	10	W/1.7470-1.7480" standard shaft size
4	Rod Pair	FP-1450SB20	20	W/1.7470-1.7480" standard shaft size
4	Rod Pair	FP-1450SB30	30	W/1.7470-1.7480" standard shaft size
4	Rod Pair	FP-2425CP	STD	W/1.8090-1.8100" standard shaft size
4	Rod Pair	FP-2425CP10	10	W/1.8090-1.8100" standard shaft size
4	Rod Pair	FP-2425CP20	20	W/1.8090-1.8100" standard shaft size
4	Rod Pair	FP-2425CP30	30	W/1.8090-1.8100" standard shaft size
QTY	PISTON RINGS	PART NO.	SIZE	DESCRIPTION
1	Standard Set	FP-617X	STD	2-1/8, 1-3/16

**10** Loader 3135G Eng. Power Unit JD135G, 3135G Engs. Wheel Tractor 3135G Eng.  
 Windrower 3135G Eng. Crawler Tractor 3135G Eng. Loader Tractor 3135G Eng.  
 2.2L 135 OHV L3, 3.8594" Bore

### CYL. HEAD & PARTS

QTY	GASKETS	PART NO.	SIZE	DESCRIPTION
1	Head Gasket	FP-R98460		
QTY	VALVE	PART NO.	SIZE	DESCRIPTION
12	Keeper	FP-41339		1 groove; Square cut key groove

(continued on next page)



# John Deere Off Highway

**Loader 3135G Eng. Power Unit JD135G, 3135G Engs. Wheel Tractor 3135G Eng. 10**  
**Windrower 3135G Eng. Crawler Tractor 3135G Eng. Loader Tractor 3135G Eng. (cont.)**  
 2.2L 135 OHV L3, 3.8594" Bore

<b>CYL. HEAD &amp; PARTS (cont.)</b>				
<b>QTY</b>	<b>VALVE (cont.)</b>	<b>PART NO.</b>	<b>SIZE</b>	<b>DESCRIPTION</b>
12	Keeper	FP-T20077		1 groove; Square cut key groove; Hardened
12	Keeper, Bulk	VK-138B		1 groove; Square cut key groove; Carton of 1000
<b>QTY</b>	<b>VALVE SPRING</b>	<b>PART NO.</b>	<b>SIZE</b>	<b>DESCRIPTION</b>
6	Spring	FP-R26125		2.1200" Free Height
<b>QTY</b>	<b>VALVE SEAL</b>	<b>PART NO.</b>	<b>SIZE</b>	<b>DESCRIPTION</b>
6	Valve Stem Seal	FP-R87627		Exh. & Int.; O-Ring type
<b>ELECTRICAL</b>				
<b>QTY</b>	<b>ALTERNATOR</b>	<b>PART NO.</b>	<b>SIZE</b>	<b>DESCRIPTION</b>
1	Ball Brg.	FP-JD9449		Front; Motorola No. A12NJD453; To Ser. No. 99,896
1	Ball Brg.	FP-JD9449		Front; Motorola No. A12NJD604; From Ser. No. 99,897
<b>CAMSHAFT GROUP</b>				
<b>QTY</b>	<b>CAMSHAFT/LIFTER</b>	<b>PART NO.</b>	<b>SIZE</b>	<b>DESCRIPTION</b>
6	Lifter	FP-T20073		
<b>COOLING SYSTEM</b>				
<b>QTY</b>	<b>WATER PUMP</b>	<b>PART NO.</b>	<b>SIZE</b>	<b>DESCRIPTION</b>
1	Water Pump Impeller	FP-R94419		Models 600, 700, 734; From Ser. No. 130,498
1	Water Pump Repair/Rebuild Kit	FP-939840979		w/Pump housing marked R56787, R62902
1	Shaft & Bearing Assembly	FP-JD9257		w/Pump housing marked T23631
<b>QTY</b>	<b>THERMOSTAT</b>	<b>PART NO.</b>	<b>SIZE</b>	<b>DESCRIPTION</b>
1	Thermostat	FP-RE33705		180 Deg.
1	Thermostat Cover Gasket	FP-T20215		
<b>ENGINE BLOCK &amp; PARTS</b>				
<b>QTY</b>	<b>GASKETS</b>	<b>PART NO.</b>	<b>SIZE</b>	<b>DESCRIPTION</b>
1	Flywheel Housing Gasket	FP-R97351		
1	Block to End Plate Front Gskt	FP-R131794		
<b>QTY</b>	<b>GASKET SETS</b>	<b>PART NO.</b>	<b>SIZE</b>	<b>DESCRIPTION</b>
1	Gasket Conversion Set	FP-PG219CS		Rubber one-piece rear main brg. seal incl.; Wear sleeve incl.
1	Kit Gasket Set	FP-2601385		Compl.; Rear main brg. seal incl.; Wear sleeve incl.
1	Kit Gasket Set	260-1385		Compl.; Rear main brg. seal incl.; Wear sleeve incl.
<b>CRANKSHAFT/OIL PUMP</b>				
<b>QTY</b>	<b>CRANKSHAFT</b>	<b>PART NO.</b>	<b>SIZE</b>	<b>DESCRIPTION</b>
1	Oil Seal Kit	FP-SK67942		Incl. front & rear seals
<b>QTY</b>	<b>SEALS - FRONT CRANK</b>	<b>PART NO.</b>	<b>SIZE</b>	<b>DESCRIPTION</b>
1	Crankshaft Front Seal	FP-AR67942		
<b>QTY</b>	<b>SEALS - REAR CRANK</b>	<b>PART NO.</b>	<b>SIZE</b>	<b>DESCRIPTION</b>
1	Crankshaft Rear Seal	FP-RE24959		
<b>QTY</b>	<b>MAIN BEARINGS</b>	<b>PART NO.</b>	<b>SIZE</b>	<b>DESCRIPTION</b>
1	Main Set	FP-MBK3002	STD	
1	Main Set	FP-MBK300210	10	
1	Main Set	FP-MBK300220	20	
1	Main Set	FP-MBK300230	30	
<b>QTY</b>	<b>OIL PUMP</b>	<b>PART NO.</b>	<b>SIZE</b>	<b>DESCRIPTION</b>
1	O-Ring	FP-R61871		Oil pump inlet; From Ser. No. 240,554
1	O-Ring	FP-R74354		Oil pump outlet tube; w/Pump housing marked R54615, T20078; From Ser. No. 240,554
<b>CYLINDER COMPONENTS</b>				
<b>QTY</b>	<b>LINERS</b>	<b>PART NO.</b>	<b>SIZE</b>	<b>DESCRIPTION</b>
3	Sleeve Assy.	FP-SL2688		Model 1020 From Ser. No. 162,079; Model JD135G; Late Models JD300, JD350; Three O-rings used; No grooves on sleeve; Contains piston to replace O.E. No. T23504T
3	Sleeve Assy.	FP-SL2689		Model 1020 To Ser. No. 162,078; Early Models JD300, JD350; Three O-rings used; Two grooves on sleeve; Contains piston to replace O.E. No. T23504T
<b>QTY</b>	<b>PISTONS</b>	<b>PART NO.</b>	<b>SIZE</b>	<b>DESCRIPTION</b>
3	Pin Bushing	FP-2599Y20		
<b>QTY</b>	<b>CONNECTING RODS &amp; BRGS.</b>	<b>PART NO.</b>	<b>SIZE</b>	<b>DESCRIPTION</b>
3	Rod Pair	FP-2595A	STD	A-Series aluminum bearings

(continued on next page)



**10** Loader 3135G Eng. Power Unit JD135G, 3135G Engs. Wheel Tractor 3135G Eng.  
(cont.) Windrower 3135G Eng. Crawler Tractor 3135G Eng. Loader Tractor 3135G Eng.  
2.2L 135 OHV L3, 3.8594" Bore

### CYLINDER COMPONENTS (cont.)

CONNECTING RODS & BRGS. (cont.)				
QTY		PART NO.	SIZE	DESCRIPTION
3	Rod Pair	FP-2595A10	10	A-Series aluminum bearings
3	Rod Pair	FP-2595A20	20	A-Series aluminum bearings
3	Rod Pair	FP-2595A30	30	A-Series aluminum bearings
PISTON RINGS				
QTY		PART NO.	SIZE	DESCRIPTION
3	Ring Set Single Cylinder	FP-AR70633	STD	2-3/32, 1-.196 (1 cyl. set)
KITS				
QTY	OVERHAUL KIT	PART NO.	SIZE	DESCRIPTION
1	Complete Overhaul Kit	FP-135GLOHK		Model 1020 From Ser. No. 162,079; Model JD135G, Late Models JD300, JD350
1	Complete Overhaul Kit	FP-135GEOHK		Model 1020 To Ser. No. 162,078; Early Models JD300, JD350

**11** Wheel Tractor 3135D Eng.  
2.2L 135 OHV Diesel L3, 3.8594" Bore

### INT & EXH MANIFOLDS

QTY	INT. & EXH. MANIFOLDS	PART NO.	SIZE	DESCRIPTION
1	Air Intake Gasket	FP-R81275		

### ENGINE BLOCK & PARTS

QTY	GASKET SETS	PART NO.	SIZE	DESCRIPTION
1	Gasket Conversion Set	FP-PG219CS		Rubber one-piece rear main brg. seal incl.; Wear sleeve incl.

### CRANKSHAFT/OIL PUMP

QTY	CRANKSHAFT	PART NO.	SIZE	DESCRIPTION
1	Oil Seal Kit	FP-SK67942		Incl. front & rear seals
SEALS - FRONT CRANK				
QTY		PART NO.	SIZE	DESCRIPTION
1	Crankshaft Front Seal	FP-AR67942		
SEALS - REAR CRANK				
QTY		PART NO.	SIZE	DESCRIPTION
1	Crankshaft Rear Seal	FP-RE24959		From Ser. No. 3,649
MAIN BEARINGS				
QTY		PART NO.	SIZE	DESCRIPTION
1	Main Set	FP-MBK3004	STD	w/Flanged thrust brg.
1	Main Set	FP-MBK300410	10	w/Flanged thrust brg.
1	Main Set	FP-MBK300420	20	w/Flanged thrust brg.
1	Main Set	FP-MBK300430	30	w/Flanged thrust brg.
OIL PUMP				
QTY		PART NO.	SIZE	DESCRIPTION
1	Pump Repair Kit	FP-RE55343		w/Pump housing marked R54615

### CYLINDER COMPONENTS

QTY	PISTONS	PART NO.	SIZE	DESCRIPTION
3	Pin Bushing	FP-T23471		1.1896" ID, 1.313" OD, 1.570" O.A.L.
CONNECTING RODS & BRGS.				
QTY		PART NO.	SIZE	DESCRIPTION
3	Rod Pair	FP-RE27348	STD	
3	Rod Pair	FP-RE27349	10	
3	Rod Pair	FP-RE27358	20	
3	Rod Pair	FP-RE27364	30	

**12** Power Unit 3135NG Eng. (Natural Gas). Wheel Tractor 3135NG Eng. (Natural Gas).  
2.2L 135 OHV NG L3, 3.8594" Bore

### CYL. HEAD & PARTS

QTY	GASKETS	PART NO.	SIZE	DESCRIPTION
1	Head Gasket	FP-R98460		
VALVE				
QTY		PART NO.	SIZE	DESCRIPTION
12	Keeper	FP-41339		1 groove; Square cut key groove
12	Keeper	FP-T20077		1 groove; Square cut key groove; Hardened
12	Keeper, Bulk	VK-138B		1 groove; Square cut key groove; Carton of 1000
VALVE SPRING				
QTY		PART NO.	SIZE	DESCRIPTION
6	Spring	FP-R26125		2.1200" Free Height
VALVE SEAL				
QTY		PART NO.	SIZE	DESCRIPTION
6	Valve Stem Seal	FP-R87627		Exh. & Int.; O-Ring type

(continued on next page)



# John Deere Off Highway

Power Unit 3135NG Eng. (Natural Gas). Wheel Tractor 3135NG Eng. (Natural Gas). **12**  
2.2L 135 OHV NG L3, 3.8594" Bore (cont.)

<b>ELECTRICAL</b>				
QTY	ALTERNATOR	PART NO.	SIZE	DESCRIPTION
1	Ball Brg.	FP-JD9449		Front; Motorola No. A12NJD453; To Ser. No. 99,896
1	Ball Brg.	FP-JD9449		Front; Motorola No. A12NJD604; From Ser. No. 99,897
<b>CAMSHAFT GROUP</b>				
QTY	CAMSHAFT/LIFTER	PART NO.	SIZE	DESCRIPTION
6	Lifter	FP-T20073		
<b>COOLING SYSTEM</b>				
QTY	WATER PUMP	PART NO.	SIZE	DESCRIPTION
1	Water Pump Impeller	FP-R94419		Models 600, 700, 734; From Ser. No. 130,498
1	Water Pump Repair/Rebuild Kit	FP-939840979		w/Pump housing marked R56787, R62902
1	Shaft & Bearing Assembly	FP-JD9257		w/Pump housing marked T23631
QTY	THERMOSTAT	PART NO.	SIZE	DESCRIPTION
1	Thermostat	FP-RE33705		180 Deg.
1	Thermostat Cover Gasket	FP-T20215		
<b>ENGINE BLOCK &amp; PARTS</b>				
QTY	GASKETS	PART NO.	SIZE	DESCRIPTION
1	Flywheel Housing Gasket	FP-R97351		
1	Block to End Plate Front Gskt	FP-R131794		
QTY	GASKET SETS	PART NO.	SIZE	DESCRIPTION
1	Gasket Conversion Set	FP-PG219CS		Rubber one-piece rear main brg. seal incl.; Wear sleeve incl.
1	Kit Gasket Set	FP-2601385		Compl.; Rear main brg. seal incl.; Wear sleeve incl.
1	Kit Gasket Set	260-1385		Compl.; Rear main brg. seal incl.; Wear sleeve incl.
<b>CRANKSHAFT/OIL PUMP</b>				
QTY	CRANKSHAFT	PART NO.	SIZE	DESCRIPTION
1	Oil Seal Kit	FP-SK67942		Incl. front & rear seals
QTY	SEALS - FRONT CRANK	PART NO.	SIZE	DESCRIPTION
1	Crankshaft Front Seal	FP-AR67942		
QTY	SEALS - REAR CRANK	PART NO.	SIZE	DESCRIPTION
1	Crankshaft Rear Seal	FP-RE24959		
QTY	MAIN BEARINGS	PART NO.	SIZE	DESCRIPTION
1	Main Set	FP-MBK3002	STD	
1	Main Set	FP-MBK300210	10	
1	Main Set	FP-MBK300220	20	
1	Main Set	FP-MBK300230	30	
QTY	OIL PUMP	PART NO.	SIZE	DESCRIPTION
1	O-Ring	FP-R61871		Oil pump inlet; From Ser. No. 240,554
1	O-Ring	FP-R74354		Oil pump outlet tube; w/Pump housing marked R54615, T20078; From Ser. No. 240,554
<b>CYLINDER COMPONENTS</b>				
QTY	LINERS	PART NO.	SIZE	DESCRIPTION
3	Sleeve Assy.	FP-SL2688		Model 1020 From Ser. No. 162,079; Model JD135G; Late Models JD300, JD350; Three O-rings used; No grooves on sleeve; Contains piston to replace O.E. No. T23504T
3	Sleeve Assy.	FP-SL2689		Model 1020 To Ser. No. 162,078; Early Models JD300, JD350; Three O-rings used; Two grooves on sleeve; Contains piston to replace O.E. No. T23504T
QTY	PISTONS	PART NO.	SIZE	DESCRIPTION
3	Pin Bushing	FP-2599Y20		
QTY	CONNECTING RODS & BRGS.	PART NO.	SIZE	DESCRIPTION
3	Rod Pair	FP-2595A	STD	A-Series aluminum bearings
3	Rod Pair	FP-2595A10	10	A-Series aluminum bearings
3	Rod Pair	FP-2595A20	20	A-Series aluminum bearings
3	Rod Pair	FP-2595A30	30	A-Series aluminum bearings
QTY	PISTON RINGS	PART NO.	SIZE	DESCRIPTION
3	Ring Set Single Cylinder	FP-AR70633	STD	2-3/32, 1-.196 (1 cyl. set)

<b>13 Power Unit 145G Eng. Wheel Tractor 145G Eng.</b> 2.4L 145 OHV L4, 3.625" Bore				
<b>CYL. HEAD &amp; PARTS</b>				
<b>QTY</b>	<b>VALVE</b>	<b>PART NO.</b>	<b>SIZE</b>	<b>DESCRIPTION</b>
4	Intake	FP-V1629		Wheel Tractor Model 2010; Power Unit From Ser. No. 30,000; 1.6880" Head Dia., .3415" Stem Dia., 4.7750" O.A.L.
4	Exhaust	FP-V3922		Wheel Tractor Model 2010; Power Unit From Ser. No. 30,000; 1.3750" Head Dia., .3415" Stem Dia., 4.7780" O.A.L.
16	Keeper	VK-63		2 groove; Round key groove
<b>QTY</b>	<b>VALVE GUIDE</b>	<b>PART NO.</b>	<b>SIZE</b>	<b>DESCRIPTION</b>
8	Guide	FP-VG576		.3440" ID, 2.3750" O.A.L.
<b>QTY</b>	<b>VALVE SPRING</b>	<b>PART NO.</b>	<b>SIZE</b>	<b>DESCRIPTION</b>
8	Spring	FP-VS1430		2.1250" Free Height
<b>QTY</b>	<b>VALVE SEAL</b>	<b>PART NO.</b>	<b>SIZE</b>	<b>DESCRIPTION</b>
8	Valve Stem Seal	ST-2001		Positive type; Installation requires valve guide machining; Rubber/PTFE
8	Valve Stem Seal Bulk	ST-2001BC		Positive type; Installation requires valve guide machining; Carton of 100; Rubber/PTFE
<b>ENGINE BLOCK &amp; PARTS</b>				
<b>QTY</b>	<b>GASKET SETS</b>	<b>PART NO.</b>	<b>SIZE</b>	<b>DESCRIPTION</b>
1	Complete Overhaul Gasket Set	FP-PG115FS		From Ser. No. 30001
<b>QTY</b>	<b>CAM BEARINGS</b>	<b>PART NO.</b>	<b>SIZE</b>	<b>DESCRIPTION</b>
1	Cam Set	FP-1251M	STD	
<b>CRANKSHAFT/OIL PUMP</b>				
<b>QTY</b>	<b>SEALS - REAR CRANK</b>	<b>PART NO.</b>	<b>SIZE</b>	<b>DESCRIPTION</b>
1	Crankshaft Rear Seal	FP-RE24959		
<b>QTY</b>	<b>MAIN BEARINGS</b>	<b>PART NO.</b>	<b>SIZE</b>	<b>DESCRIPTION</b>
1	Main Set	FP-4344M	STD	From Ser. No. 35,834
1	Main Set	FP-4344M10	10	From Ser. No. 35,834
1	Main Set	FP-4344M20	20	From Ser. No. 35,834
1	Main Set	FP-4144M	STD	To Ser. No. 35,833
1	Main Set	FP-4144M10	10	To Ser. No. 35,833
1	Main Set	FP-4144M20	20	To Ser. No. 35,833
<b>CYLINDER COMPONENTS</b>				
<b>QTY</b>	<b>PISTONS</b>	<b>PART NO.</b>	<b>SIZE</b>	<b>DESCRIPTION</b>
4	Pin Bushing	FP-2599Y20		
<b>QTY</b>	<b>CONNECTING RODS &amp; BRGS.</b>	<b>PART NO.</b>	<b>SIZE</b>	<b>DESCRIPTION</b>
4	Rod Pair	FP-2595A	STD	A-Series aluminum bearings
4	Rod Pair	FP-2595A10	10	A-Series aluminum bearings
4	Rod Pair	FP-2595A20	20	A-Series aluminum bearings
4	Rod Pair	FP-2595A30	30	A-Series aluminum bearings
<b>QTY</b>	<b>PISTON RINGS</b>	<b>PART NO.</b>	<b>SIZE</b>	<b>DESCRIPTION</b>
1	Premium Set	FP-5923KX	STD	2-3/32, 1-3/16
1	Premium Set	FP-5504KX	STD	3-3/32, 1-3/16
1	Standard Set	FP-5504X	STD	3-3/32, 1-3/16
4	Premium Single Cylinder Set	W-5923KX Std Only		2-3/32, 1-3/16
4	Premium Single Cylinder Set	W-5504KX Std Only		3-3/32, 1-3/16
<b>14 Power Unit 145G Eng. Wheel Tractor 145G Eng.</b> 2.4L 145 OHV L4 (Late), 3.625" Bore				
<b>CYL. HEAD &amp; PARTS</b>				
<b>QTY</b>	<b>VALVE</b>	<b>PART NO.</b>	<b>SIZE</b>	<b>DESCRIPTION</b>
4	Intake	FP-V1629		Wheel Tractor Model 2010; Power Unit From Ser. No. 30,000; 1.6880" Head Dia., .3415" Stem Dia., 4.7750" O.A.L.
4	Exhaust	FP-V3922		Wheel Tractor Model 2010; Power Unit From Ser. No. 30,000; 1.3750" Head Dia., .3415" Stem Dia., 4.7780" O.A.L.
16	Keeper	VK-63		2 groove; Round key groove
<b>QTY</b>	<b>VALVE GUIDE</b>	<b>PART NO.</b>	<b>SIZE</b>	<b>DESCRIPTION</b>
8	Guide	FP-VG576		.3440" ID, 2.3750" O.A.L.
<b>QTY</b>	<b>VALVE SPRING</b>	<b>PART NO.</b>	<b>SIZE</b>	<b>DESCRIPTION</b>
8	Spring	FP-VS1430		2.1250" Free Height
<b>QTY</b>	<b>VALVE SEAL</b>	<b>PART NO.</b>	<b>SIZE</b>	<b>DESCRIPTION</b>
8	Valve Stem Seal	ST-2001		Positive type; Installation requires valve guide machining; Rubber/PTFE

(continued on next page)



# John Deere Off Highway

Power Unit 145G Eng. Wheel Tractor 145G Eng. **14**  
2.4L 145 OHV L4 (Late), 3.625" Bore (cont.)

CYL. HEAD & PARTS (cont.)				
QTY	VALVE SEAL (cont.)	PART NO.	SIZE	DESCRIPTION
8	Valve Stem Seal Bulk	ST-2001BC		Positive type; Installation requires valve guide machining; Carton of 100; Rubber/PTFE
ENGINE BLOCK & PARTS				
QTY	GASKET SETS	PART NO.	SIZE	DESCRIPTION
1	Complete Overhaul Gasket Set	FP-PG115FS		From Ser. No. 30001
QTY	CAM BEARINGS	PART NO.	SIZE	DESCRIPTION
1	Cam Set	FP-1251M	STD	
CRANKSHAFT/OIL PUMP				
QTY	SEALS - REAR CRANK	PART NO.	SIZE	DESCRIPTION
1	Crankshaft Rear Seal	FP-RE24959		
QTY	MAIN BEARINGS	PART NO.	SIZE	DESCRIPTION
1	Main Set	FP-4344M	STD	
1	Main Set	FP-4344M10	10	
1	Main Set	FP-4344M20	20	
CYLINDER COMPONENTS				
QTY	CONNECTING RODS & BRGS.	PART NO.	SIZE	DESCRIPTION
4	Rod Pair	FP-2595A	STD	A-Series aluminum bearings
4	Rod Pair	FP-2595A10	10	A-Series aluminum bearings
4	Rod Pair	FP-2595A20	20	A-Series aluminum bearings
4	Rod Pair	FP-2595A30	30	A-Series aluminum bearings
QTY	PISTON RINGS	PART NO.	SIZE	DESCRIPTION
1	Premium Set	FP-5923KX	STD	2-3/32, 1-3/16
1	Premium Set	FP-5504KX	STD	3-3/32, 1-3/16
1	Standard Set	FP-5504X	STD	3-3/32, 1-3/16
4	Premium Single Cylinder Set	W-5923KX Std Only		2-3/32, 1-3/16
4	Premium Single Cylinder Set	W-5504KX Std Only		3-3/32, 1-3/16
Wheel Tractor 145D Eng. Crawler Tractor 145D Eng. <b>15</b> 2.4L 145 OHV Diesel L4, 3.625" Bore				
CYL. HEAD & PARTS				
QTY	VALVE	PART NO.	SIZE	DESCRIPTION
16	Keeper	VK-63		2 groove; Round key groove
QTY	VALVE SPRING	PART NO.	SIZE	DESCRIPTION
8	Spring	FP-VS1430		2.1250" Free Height
QTY	VALVE SEAL	PART NO.	SIZE	DESCRIPTION
4	Valve Stem Seal	ST-2001		Int.; Positive type; Installation requires valve guide machining; Rubber/PTFE
4	Valve Stem Seal Bulk	ST-2001BC		Int.; Positive type; Installation requires valve guide machining; Carton of 100; Rubber/PTFE
ENGINE BLOCK & PARTS				
QTY	CAM BEARINGS	PART NO.	SIZE	DESCRIPTION
1	Cam Set	FP-1251M	STD	
CRANKSHAFT/OIL PUMP				
QTY	SEALS - REAR CRANK	PART NO.	SIZE	DESCRIPTION
1	Crankshaft Rear Seal	FP-RE24959		
QTY	MAIN BEARINGS	PART NO.	SIZE	DESCRIPTION
1	Main Set	FP-4145M	STD	Early Eng.s.; w/full groove brgs.
1	Main Set	FP-4145M10	10	Early Eng.s.; w/full groove brgs.
1	Main Set	FP-4145M20	20	Early Eng.s.; w/full groove brgs.
1	Main Set	FP-4145M30	30	Early Eng.s.; w/full groove brgs.
1	Main Set	FP-4345M	STD	Late Eng.s.; w/half groove brgs.
1	Main Set	FP-4345M10	10	Late Eng.s.; w/half groove brgs.
1	Main Set	FP-4345M20	20	Late Eng.s.; w/half groove brgs.
CYLINDER COMPONENTS				
QTY	PISTONS	PART NO.	SIZE	DESCRIPTION
4	Pin Bushing	FP-2599Y20		

(continued on next page)

# John Deere Off Highway



<b>15 Wheel Tractor 145D Eng. Crawler Tractor 145D Eng.</b> (cont.) 2.4L 145 OHV Diesel L4, 3.625" Bore				
<b>CYLINDER COMPONENTS (cont.)</b>				
<b>CONNECTING RODS &amp; BRGS.</b>				
<b>QTY</b>		<b>PART NO.</b>	<b>SIZE</b>	<b>DESCRIPTION</b>
4	Rod Pair	FP-2595A	STD	A-Series aluminum bearings
4	Rod Pair	FP-2595A10	10	A-Series aluminum bearings
4	Rod Pair	FP-2595A20	20	A-Series aluminum bearings
4	Rod Pair	FP-2595A30	30	A-Series aluminum bearings
<b>PISTON RINGS</b>				
<b>QTY</b>		<b>PART NO.</b>	<b>SIZE</b>	<b>DESCRIPTION</b>
1	Premium Set	FP-5923KX	STD	2-3/32, 1-3/16
1	Premium Set	FP-5504KX	STD	3-3/32, 1-3/16
1	Standard Set	FP-5504X	STD	3-3/32, 1-3/16
4	Premium Single Cylinder Set	W-5923KX Std Only		2-3/32, 1-3/16
4	Premium Single Cylinder Set	W-5504KX Std Only		3-3/32, 1-3/16
<b>16 Wheel Tractor B Eng.</b> 2.4L 149 OHV L2, 4.25" Bore				
<b>CYL. HEAD &amp; PARTS</b>				
<b>GASKETS</b>				
<b>QTY</b>		<b>PART NO.</b>	<b>SIZE</b>	<b>DESCRIPTION</b>
1	Head Set	FP-PG175HS		Models B, BN, BW; From Ser. No. 96000
<b>ENGINE BLOCK &amp; PARTS</b>				
<b>GASKET SETS</b>				
<b>QTY</b>		<b>PART NO.</b>	<b>SIZE</b>	<b>DESCRIPTION</b>
1	Complete Overhaul Gasket Set	FP-PG175FS		Models B, BN, BW; From Ser. No. 96000
<b>CYLINDER COMPONENTS</b>				
<b>CONNECTING RODS &amp; BRGS.</b>				
<b>QTY</b>		<b>PART NO.</b>	<b>SIZE</b>	<b>DESCRIPTION</b>
2	Rod Pair	FP-2180CP	STD	w/Insert type brgs.
2	Rod Pair	FP-2180CP10	10	w/Insert type brgs.
2	Rod Pair	FP-2180CP20	20	w/Insert type brgs.
<b>PISTON RINGS</b>				
<b>QTY</b>		<b>PART NO.</b>	<b>SIZE</b>	<b>DESCRIPTION</b>
1	Standard Set	FP-T244	STD	3-3/16, 1-3/16
<b>17 Loader 3152G Eng. Wheel Tractor 3152G Eng.</b> 2.5L 152 OHV L3, 3.8594" Bore				
<b>ELECTRICAL</b>				
<b>ALTERNATOR</b>				
<b>QTY</b>		<b>PART NO.</b>	<b>SIZE</b>	<b>DESCRIPTION</b>
1	Ball Brg.	FP-JD9449		Front; Motorola No. A12NJD453; To Ser. No. 99,896
1	Ball Brg.	FP-JD9449		Front; Motorola No. A12NJD604; From Ser. No. 99,897
<b>ENGINE BLOCK &amp; PARTS</b>				
<b>GASKET SETS</b>				
<b>QTY</b>		<b>PART NO.</b>	<b>SIZE</b>	<b>DESCRIPTION</b>
1	Gasket Conversion Set	FP-PG219CS		Rubber one-piece rear main brg. seal incl.; Wear sleeve incl.
<b>CRANKSHAFT/OIL PUMP</b>				
<b>SEALS - FRONT CRANK</b>				
<b>QTY</b>		<b>PART NO.</b>	<b>SIZE</b>	<b>DESCRIPTION</b>
1	Crankshaft Front Seal	FP-AR67942		
<b>SEALS - REAR CRANK</b>				
<b>QTY</b>		<b>PART NO.</b>	<b>SIZE</b>	<b>DESCRIPTION</b>
1	Crankshaft Rear Seal	FP-RE24959		
<b>MAIN BEARINGS</b>				
<b>QTY</b>		<b>PART NO.</b>	<b>SIZE</b>	<b>DESCRIPTION</b>
1	Main Set	FP-MBK3003	STD	w/Flanged thrust brg.
1	Main Set	FP-MBK300310	10	w/Flanged thrust brg.
1	Main Set	FP-MBK300320	20	w/Flanged thrust brg.
1	Main Set	FP-MBK300330	30	w/Flanged thrust brg.
<b>OIL PUMP</b>				
<b>QTY</b>		<b>PART NO.</b>	<b>SIZE</b>	<b>DESCRIPTION</b>
1	O-Ring	FP-R61871		Oil pump inlet; From Ser. No. 240,554
1	O-Ring	FP-R74354		Oil pump outlet tube; w/Pump housing marked R54615, T20078; From Ser. No. 240,554
<b>CYLINDER COMPONENTS</b>				
<b>PISTONS</b>				
<b>QTY</b>		<b>PART NO.</b>	<b>SIZE</b>	<b>DESCRIPTION</b>
3	Pin Bushing	FP-T23471		1.1896" ID, 1.313" OD, 1.570" O.A.L.



# John Deere Off Highway

Forklift 3152D Eng. Loader 3152D Eng. Power Unit JD152D, 3152D Engs. Wheel Tractor 3152D Eng. Crawler Tractor 3152D Eng. Loader Tractor 3152D Eng. Dozer 3152D Eng. Backhoe 3152D Eng.  
2.5L 152 OHV Diesel L3, 3.8594" Bore

CYL. HEAD & PARTS				
QTY	GASKETS	PART NO.	SIZE	DESCRIPTION
1	Valve Cover Gasket	FP-R75729		Sheet metal cover
1	Head Gasket	FP-R98460		
1	Head Set	FP-RE38848		
QTY	VALVE	PART NO.	SIZE	DESCRIPTION
3	Intake	FP-R79623	STD	2 groove; Chrome plated stem; 1.7720" Head Dia., .3720" Stem Dia., 5.1560" O.A.L.
3	Intake	FP-R79628	3	2 groove; Chrome plated stem; 1.7720" Head Dia., .3750" Stem Dia., 5.1560" O.A.L.
3	Intake	FP-R79629	15	2 groove; Chrome plated stem; 1.7720" Head Dia., .3870" Stem Dia., 5.1560" O.A.L.
3	Intake	FP-R79630	30	2 groove; Chrome plated stem; 1.7720" Head Dia., .4020" Stem Dia., 5.1560" O.A.L.
3	Exhaust	FP-R79624	STD	1 groove; Chrome plated stem; 1.5750" Head Dia., .3720" Stem Dia., 5.1560" O.A.L.
3	Exhaust	FP-R79625	3	1 groove; Chrome plated stem; 1.5750" Head Dia., .3750" Stem Dia., 5.1560" O.A.L.
3	Exhaust	FP-R79626	15	1 groove; Chrome plated stem; 1.5750" Head Dia., .3870" Stem Dia., 5.1560" O.A.L.
3	Exhaust	FP-R79627	30	1 groove; Chrome plated stem; 1.5750" Head Dia., .4020" Stem Dia., 5.1560" O.A.L.
12	Keeper	FP-41339		1 groove; Square cut key groove
12	Keeper	FP-T20077		1 groove; Square cut key groove; Hardened
12	Keeper, Bulk	VK-138B		1 groove; Square cut key groove; Carton of 1000
QTY	VALVE SEAT	PART NO.	SIZE	DESCRIPTION
3	Exh.	FP-R51734	STD	
3	Int.	FP-R73064	STD	
QTY	VALVE SPRING	PART NO.	SIZE	DESCRIPTION
6	Spring	FP-R26125		2.1200" Free Height
QTY	VALVE MISC.	PART NO.	SIZE	DESCRIPTION
3	Rotocap	FP-RE11410		
1	Bushing	FP-T26321		Lower
1	Bushing	FP-T20034		Upper
QTY	VALVE SEAL	PART NO.	SIZE	DESCRIPTION
6	Valve Stem Seal	FP-R87627		O-Ring type
INT & EXH MANIFOLDS				
QTY	INT. & EXH. MANIFOLDS	PART NO.	SIZE	DESCRIPTION
3	Exhaust Manifold Gasket	FP-R90658		
1	Air Intake Gasket	FP-R81275		
CAMSHAFT GROUP				
QTY	TIMING COVER	PART NO.	SIZE	DESCRIPTION
1	Timing Gear Cover Gasket	FP-T20273		Access cover
QTY	CAMSHAFT/LIFTER	PART NO.	SIZE	DESCRIPTION
6	Lifter	FP-T20073		
FUEL SYSTEM & PARTS				
QTY	FUEL INJECTION	PART NO.	SIZE	DESCRIPTION
3	Fuel Injector Nozzle	FP-AR89564		
12	Washer	FP-T20055		
8	Clamp	FP-R34766		To Ser. No. 105,438
3	Washer Type Seal	FP-R48000		Lower; w/Nozzle marked 18742, 19762, 20631, 22042
3	Washer Type Seal	FP-R60746		Upper; w/Nozzle marked 20631, 22042; To Ser. No. 467,466
QTY	FUEL FILTERS & PUMP	PART NO.	SIZE	DESCRIPTION
1	Mechanical Fuel Pump	FP-RE42211		Transfer pump
1	Fuel Transfer Pump Gasket	FP-R97350		
COOLING SYSTEM				
QTY	WATER PUMP	PART NO.	SIZE	DESCRIPTION
1	Water Pump Impeller	FP-R94419		From Ser. No. 131,212
1	Water Pump Repair/Rebuild Kit	FP-925740979		w/Pump housing marked R56787, R62902
1	Water Pump Mounting Gasket	FP-T20243		
1	Shaft & Bearing Assembly	FP-JD9257		

(continued on next page)

**18** *Forklift 3152D Eng. Loader 3152D Eng. Power Unit JD152D, 3152D Engs. Wheel Tractor (cont.) 3152D Eng. Crawler Tractor 3152D Eng. Loader Tractor 3152D Eng. Dozer 3152D Eng. Backhoe 3152D Eng.*  
2.5L 152 OHV Diesel L3, 3.8594" Bore

### COOLING SYSTEM (cont.)

QTY	THERMOSTAT	PART NO.	SIZE	DESCRIPTION
1	Thermostat	FP-RE33705		180 Deg.
1	Thermostat Gasket	FP-T20219		Thermostat housing marked R60256
1	Thermostat Cover Gasket	FP-T20215		

### ENGINE BLOCK & PARTS

QTY	GASKETS	PART NO.	SIZE	DESCRIPTION
1	Flywheel Housing Gasket	FP-R97351		
1	Oil Pan Gasket	FP-R97341		Exc. Alum. oil pan
1	Block to End Plate Front Gskt	FP-R131794		

QTY	GASKET SETS	PART NO.	SIZE	DESCRIPTION
1	Gasket Conversion Set	FP-PG219CS		Rubber one-piece rear main brg. seal incl.; Wear sleeve incl.
1	In-Frame Gasket Set	FP-PG152S		
1	Complete Overhaul Gasket Set	FP-RE38570		Crankshaft seals not incl.
1	Complete Overhaul Gasket Set	FP-RE38570WS		Incl. crankshaft oil seals
1	Kit Gasket Set	260-1387		Compl.; Rear main brg. seal incl.; Wear sleeve incl.

### CRANKSHAFT/OIL PUMP

QTY	CRANKSHAFT	PART NO.	SIZE	DESCRIPTION
1	Crankshaft	FP-AT18031		
1	Oil Seal Kit	FP-SK67942		Incl. front & rear seals

QTY	SEALS - FRONT CRANK	PART NO.	SIZE	DESCRIPTION
1	Crankshaft Front Seal	FP-AR67942		

QTY	SEALS - REAR CRANK	PART NO.	SIZE	DESCRIPTION
1	Crankshaft Rear Seal	FP-RE24959		From Ser. No. 3,649

QTY	MAIN BEARINGS	PART NO.	SIZE	DESCRIPTION
1	Main Set	FP-MBK3003	STD	w/Flanged thrust brg.
1	Main Set	FP-MBK300310	10	w/Flanged thrust brg.
1	Main Set	FP-MBK300320	20	w/Flanged thrust brg.
1	Main Set	FP-MBK300330	30	w/Flanged thrust brg.
3	Plain Main Brg.	FP-RE27352	STD	w/Flangeless thrust brg.
3	Plain Main Brg.	FP-RE27353	10	w/Flangeless thrust brg.
3	Plain Main Brg.	FP-RE27360	20	w/Flangeless thrust brg.
3	Plain Main Brg.	FP-RE27368	30	w/Flangeless thrust brg.
1	Flanged Main Brg.	FP-RE521350	STD	
1	Flanged Main Brg.	FP-RE526754	10	
1	Flanged Main Brg.	FP-RE527235	20	
1	Flanged Main Brg.	FP-RE527236	30	
4	Thrust Washer	FP-R78598	STD	

### CYLINDER COMPONENTS

QTY	LINERS	PART NO.	SIZE	DESCRIPTION
3	Liner w/o Sealing Ring	FP-T32340	STD	O-Rings in block
3	Liner w/o Sealing Ring	FP-R48635	STD	To Ser. No. 154,765; O-Rings on liner
3	Liner w/Sealing Rings	FP-AR51902	STD	
3	Liner w/Sealing Rings	FP-T32340WS	STD	From Ser. No. 154,766
3	Cylinder Kit Complete	FP-AR71591		w/Con. Rod marked T20007, R81410; From Ser. No. 154,766; Contains FP-T32340-WS liner; O-rings in block
3	Cylinder Kit Complete	FP-CK34818635	STD	w/Con. Rod marked T20007, R81410; To Ser. No. 154,765; Contains FP-AR51902 liner; O-rings on liner
3	Cyl. Liner Sealing Ring Kit	FP-AR71617		
3	Sealing Ring, Liner	FP-R48767		Rectangle; Top
3	Sealing Ring, Liner	FP-R48637		To Ser. No. 154,765; Rectangle; Top & Bottom
3	Sealing Ring, Liner	FP-R48638		To Ser. No. 154,765; Round
3	Sealing Ring	FP-SLR2497		Round; Bottom; In block

QTY	PISTONS	PART NO.	SIZE	DESCRIPTION
3	Piston Body w/o Pin	FP-T23481		
3	Piston Kit w/Pin & Retainers	FP-T23481WP		
3	Pin	FP-T23482		
6	Piston Pin Retainer	FP-R51112		
3	Pin Bushing	FP-T23471		w/Con. Rod marked R81410, T20007; 1.1896" ID, 1.313" OD, 1.570" O.A.L.

QTY	CONNECTING RODS & BRGS.	PART NO.	SIZE	DESCRIPTION
6	Con. Rod Bolt	FP-R80033		w/Con. Rod marked R80032, R80034, R81410, R105011, R113612; Torque-To-Yield bolt; Replacement recommended

(continued on next page)





# John Deere Off Highway

Forklift 3152D Eng. Loader 3152D Eng. Power Unit JD152D, 3152D Engs. Wheel Tractor 18  
 3152D Eng. Crawler Tractor 3152D Eng. Loader Tractor 3152D Eng. Dozer 3152D Eng. (cont.)  
 Backhoe 3152D Eng.  
 2.5L 152 OHV Diesel L3, 3.8594" Bore

## CYLINDER COMPONENTS (cont.)

QTY	CONNECTING RODS & BRGS. (cont.)	PART NO.	SIZE	DESCRIPTION
6	Con. Rod Bolt	FP-R74194		w/Con. Rod marked T20007, R51727, R58979; Torque-To-Yield bolt; Replacement recommended
3	Rod Pair	FP-RE27348	STD	
3	Rod Pair	FP-RE27349	10	
3	Rod Pair	FP-RE27358	20	
3	Rod Pair	FP-RE27364	30	

QTY	PISTON RINGS	PART NO.	SIZE	DESCRIPTION
3	Ring Set Single Cylinder	FP-AR70633	STD	2-3/32, 1-.196 (1 cyl. set)

## KITS

QTY	OVERHAUL KIT	PART NO.	SIZE	DESCRIPTION
1	In-Frame Overhaul Kit	FP-152EORLIFK		w/Block marked T24963, T26935; w/Con. Rod marked T20007; To Ser. No. 154,765; O-rings on liner; Incl. Torque-To-Yield con. rod bolts
1	In-Frame Overhaul Kit	FP-152LIFK		w/Block marked T32339, R53240, R55100, R72967; w/Con. Rod marked T20007; From Ser. No. 154,766; O-rings in block; Incl. Torque-To-Yield con. rod bolts
1	Complete Overhaul Kit	FP-152LOHK		w/Block marked R53240, R55100, R72967, T32339; w/Con. Rod marked T20007; From Ser. No. 154,766; O-rings in block; Incl. front & rear seals; Incl. Torque-To-Yield con. rod bolts
1	Complete Overhaul Kit	FP-152EORLOHK		w/Block marked T24963, T26935; w/Con. Rod marked T20007; To Ser. No. 154,765; O-rings on liner; Incl. front & rear seals; Incl. Torque-To-Yield con. rod bolts

Hay Baler AP4, V460D, V461D, VG4D, VP4, VP4D Engs. Harvester AP4, V460D, V461D, VG4D, VP4, VP4D Engs. 19  
 2.5L 154 L-HEAD V4, 3.5" Bore (Wisconsin Eng.)

## CYL. HEAD & PARTS

QTY	VALVE	PART NO.	SIZE	DESCRIPTION
4	Intake	FP-V818		VG4D & VP4D Engs.; 1.5630" Head Dia., .3089" Stem Dia., 6.3346" O.A.L.
4	Exhaust	FP-V1676X		VG4D & VP4D Engs.; 1.5570" Head Dia., .3085" Stem Dia., 6.3330" O.A.L.
16	Keeper	VK-144		Exc. V460D, V461D Engs.; 1 groove; Square cut key groove
16	Keeper	VK-144R		Exc. V460D, V461D Engs.; 1 groove; Square cut key groove; Hardened
16	Keeper	VK-115		V460D, V461D Engs.; 1 groove; Square cut key groove; Carton pack 32
16	Keeper	VK-115R		V460D, V461D Engs.; 1 groove; Square cut key groove; Hardened
16	Keeper, Bulk	VK-115B		V460D, V461D Engs.; 1 groove; Square cut key groove; Carton of 1000

QTY	VALVE GUIDE	PART NO.	SIZE	DESCRIPTION
8	Guide	VG-855		VG4D & VP4D Engs.; .3130" ID, 2.5000" O.A.L.

QTY	VALVE SPRING	PART NO.	SIZE	DESCRIPTION
8	Spring	FP-VS468		AP4 Engs.; 2.3120" Free Height

## CRANKSHAFT/OIL PUMP

QTY	MAIN BEARINGS	PART NO.	SIZE	DESCRIPTION
1	Plain Main Brg.	FP-3224CP	STD	Position Center; V460D & V461D Engs
1	Plain Main Brg.	FP-3224CP10	10	Position Center; V460D & V461D Engs
2	Cone Taper Brg.	FP-JD8130		Position Ends; V460D & V461D Engs.
2	Cup Taper Brg.	FP-JD7466		Position Ends; V460D & V461D Engs.
2	Cup Taper Brg.	453A		Position 1-2; VG4D, VP4 Engs.

## CYLINDER COMPONENTS

QTY	LINERS	PART NO.	SIZE	DESCRIPTION
1	Repair Sleeve	SL-15M	Std Only	3/32" wall, Must be cut to correct length

QTY	PISTONS	PART NO.	SIZE	DESCRIPTION
4	Pin Bushing	1394 +		VG4D & VP4 Engs.; 1.000" max. length; When depleted use FP-1394
4	Pin Bushing	FP-1394		1.000" max. length

(continued on next page)

**19** Hay Baler AP4, V460D, V461D, VG4D, VP4, VP4D Engs. Harvester AP4, V460D, V461D, (cont.) VG4D, VP4, VP4D Engs.  
2.5L 154 L-HEAD V4, 3.5" Bore (Wisconsin Eng.)

### CYLINDER COMPONENTS (cont.)

QTY	CONNECTING RODS & BRGS.	PART NO.	SIZE	DESCRIPTION
4	Rod Pair	FP-3605SB	STD	VG4D, VP4 Engs.
4	Rod Pair	FP-3605SB10	10	VG4D, VP4 Engs.
4	Rod Pair	FP-3605SB20	20	VG4D, VP4 Engs.
4	Rod Pair	FP-3220CP	STD	V460D, V461D Engs.; w/2.1232-2.1240" std. shaft size
4	Rod Pair	FP-3220CP10	10	V460D, V461D Engs.; w/2.1232-2.1240" std. shaft size
4	Rod Pair	FP-3220CP20	20	V460D, V461D Engs.; w/2.1232-2.1240" std. shaft size
4	Rod Pair	FP-3220CP30	30	V460D, V461D Engs.; w/2.1232-2.1240" std. shaft size
QTY	PISTON RINGS	PART NO.	SIZE	DESCRIPTION
4	Premium Set	FP-5091KX	STD	AP4, AP41, VG4D, VP4, VP4D Engs.; 3-1/8, 1-3/16 (1 cyl. set)
4	Premium Set	FP-5091KX30	30	AP4, AP41, VG4D, VP4, VP4D Engs.; 3-1/8, 1-3/16 (1 cyl. set)
1	Premium Set	FP-934KX	STD	AP4, VG4D, VP4, VP4D Engs.; 3-1/8, 1-3/16
1	Premium Set	FP-934KX20	20	AP4, VG4D, VP4, VP4D Engs.; 3-1/8, 1-3/16
1	Premium Set	FP-934KX30	30	AP4, VG4D, VP4, VP4D Engs.; 3-1/8, 1-3/16
1	Premium Set	FP-934KX60	60	AP4, VG4D, VP4, VP4D Engs.; 3-1/8, 1-3/16
4	Premium Single Cylinder Set	W-934KX Std Only		AP4, VG4D, VP4, VP4D Engs.; 3-1/8, 1-3/16
4	Standard Single Cylinder Set	W-934X Std Only		AP4, VG4D, VP4, VP4D Engs.; 3-1/8, 1-3/16

**20** Combine 155D Eng. Power Unit 155D Eng. Wheel Tractor 155D Eng.  
2.5L 155 OHV Diesel L4, 3.75" Bore

### ENGINE BLOCK & PARTS

QTY	CAM BEARINGS	PART NO.	SIZE	DESCRIPTION
1	Cam Set	FP-1251M	STD	
QTY	MAIN BEARINGS	PART NO.	SIZE	DESCRIPTION
1	Main Set	FP-4145M	STD	
1	Main Set	FP-4145M10	10	
1	Main Set	FP-4145M20	20	
1	Main Set	FP-4145M30	30	

### CYLINDER COMPONENTS

QTY	PISTONS	PART NO.	SIZE	DESCRIPTION
4	Pin Bushing	FP-2599Y20		
QTY	CONNECTING RODS & BRGS.	PART NO.	SIZE	DESCRIPTION
4	Rod Pair	FP-2595A	STD	A-Series aluminum bearings
4	Rod Pair	FP-2595A10	10	A-Series aluminum bearings
4	Rod Pair	FP-2595A20	20	A-Series aluminum bearings
4	Rod Pair	FP-2595A30	30	A-Series aluminum bearings

**21** Combine F162 Eng. Harvester F162 Eng.  
2.7L 162 L-HEAD L4, 3.4375" Bore (Continental Eng.)

### CYL. HEAD & PARTS

QTY	VALVE	PART NO.	SIZE	DESCRIPTION
4	Intake	FP-V1748	STD	Single groove stem; 1.5160" Head Dia., .3410" Stem Dia., 5.1570" O.A.L.
4	Exhaust	FP-V800	STD	Drilled stem; 1.2030" Head Dia., .3381" Stem Dia., 5.1520" O.A.L.
4	Exhaust	FP-V954	STD	Drilled stem; 1.3280" Head Dia., .3386" Stem Dia., 5.1950" O.A.L.
4	Exhaust	FP-V1684	STD	Single groove stem; 1.2030" Head Dia., .3392" Stem Dia., 5.1890" O.A.L.
16	Keeper	FP-VK142		For drilled stem
16	Keeper	FP-VK144		1 groove; Square cut key groove
16	Keeper	VK-144R		1 groove; Square cut key groove; Hardened
16	Keeper, Bulk	FP-VK144B		1 groove; Square cut key groove; Carton of 1000
QTY	VALVE SEAT	PART NO.	SIZE	DESCRIPTION
4	Exh.	245-1437-3N Std Only		Premium Material; 1.4425" OD, 1.1880" ID, .2160" Depth
4	Exh.	FP-24513753	STD	1.3795" OD, 1.0625" ID, .1855" Depth
4	Exh.	245-1437-3 Std Only		1.4425" OD, 1.1880" ID, .2160" Depth
4	Int.	245-1625-1N Std Only		Premium Material; 1.6300" OD, 1.3750" ID, .2160" Depth
4	Int.	FP-2451348E1N	STD	1.3480" OD, 1.0870" ID, .2005" Depth
4	Int.	245-1625-1 Std Only		1.6300" OD, 1.3750" ID, .2160" Depth

(continued on next page)



# John Deere Off Highway

**Combine F162 Eng. Harvester F162 Eng. 21**  
2.7L 162 L-HEAD L4, 3.4375" Bore (Continental Eng.) (cont.)

<b>CYL. HEAD &amp; PARTS (cont.)</b>				
QTY	VALVE GUIDE	PART NO.	SIZE	DESCRIPTION
8	Guide	FP-VG418		Exc. Rototype; .3425" ID, 2.3100" O.A.L.
QTY	VALVE SPRING	PART NO.	SIZE	DESCRIPTION
8	Spring	FP-VS356		2.0000" Free Height
<b>CAMSHAFT GROUP</b>				
QTY	TIMING	PART NO.	SIZE	DESCRIPTION
1	Cam Gear	FP-2212601		Governor type; 48 Teeth
1	Cam Gear	FP-2212600		Replacement O.E. No. F400H310; 48 Teeth
<b>ENGINE BLOCK &amp; PARTS</b>				
QTY	GASKET SETS	PART NO.	SIZE	DESCRIPTION
1	Kit Gasket Set	260-1355		Compl.; Timing cover gskt. & seal not incl.
QTY	CAM BEARINGS	PART NO.	SIZE	DESCRIPTION
1	Cam Set	FP-1158M	STD	
<b>CRANKSHAFT/OIL PUMP</b>				
QTY	CRANKSHAFT	PART NO.	SIZE	DESCRIPTION
1	Crank Gear	FP-2212603A		Replacement O.E. No. F400H326; 24 Teeth
QTY	MAIN BEARINGS	PART NO.	SIZE	DESCRIPTION
1	Main Set	FP-4004M	STD	W/Single flanged front brg.
1	Main Set	FP-4004M10	10	W/Single flanged front brg.
1	Main Set	FP-4004M20	20	W/Single flanged front brg.
1	Main Set	FP-4005M	STD	W/Straight shell front brg.
1	Main Set	FP-4005M10	10	W/Straight shell front brg.
1	Main Set	FP-4005M20	20	W/Straight shell front brg.
1	Main Set	FP-6632M	STD	W/Straight shell front brg. & thrust washer
1	Main Set	FP-6632M10	10	W/Straight shell front brg. & thrust washer
1	Main Set	FP-6632M20	20	W/Straight shell front brg. & thrust washer
1	Main Set	FP-6632M30	30	W/Straight shell front brg. & thrust washer
1	Thrust Washer Set	FP-9811BFA	STD	Position 1; Use w/straight shell main brg. set
1	Thrust Washer	FP-9811BF	STD	Position 1; Use w/Flanged main brg.; .0960" Max. Thickness
QTY	OIL PUMP	PART NO.	SIZE	DESCRIPTION
1	Oil Pump	FP-2244132		Cast Iron drive gear; Use w/Cast Iron cams; 7 1/8" from flange to end of shaft; Incl. screen
1	Oil Pump	FP-2244137		Steel drive gear w/groove at pin; Use w/Steel cams; 7-1/8" from flange to end of shaft; Incl. pin
<b>CYLINDER COMPONENTS</b>				
QTY	LINERS	PART NO.	SIZE	DESCRIPTION
1	Repair Sleeve	SL-14M	Std Only	3/32" wall, must be cut to correct length
QTY	PISTONS	PART NO.	SIZE	DESCRIPTION
4	Cast Piston	FP-1102P	STD	Cast; 1-5/64", 2-3/32", 1-1/4" Ring Groove, 2.000" CD, .8592" Pin Dia., Flat Head
4	Cast Piston	FP-1102P20	20	Cast; 1-5/64", 2-3/32", 1-1/4" Ring Groove, 2.000" CD, .8592" Pin Dia., Flat Head
4	Cast Piston	FP-1102P30	30	Cast; 1-5/64", 2-3/32", 1-1/4" Ring Groove, 2.000" CD, .8592" Pin Dia., Flat Head
4	Cast Piston	FP-1102P40	40	Cast; 1-5/64", 2-3/32", 1-1/4" Ring Groove, 2.000" CD, .8592" Pin Dia., Flat Head
4	Cast Piston	FP-1102P60	60	Cast; 1-5/64", 2-3/32", 1-1/4" Ring Groove, 2.000" CD, .8592" Pin Dia., Flat Head
4	Cast Piston - Individual	FP-W1102P	STD	Cast; 1-5/64", 2-3/32", 1-1/4" Ring Groove, 2.000" CD, .8592" Pin Dia., Flat Head
4	Cast Piston - Individual	FP-W1102P20	20	Cast; 1-5/64", 2-3/32", 1-1/4" Ring Groove, 2.000" CD, .8592" Pin Dia., Flat Head
4	Cast Piston - Individual	FP-W1102P30	30	Cast; 1-5/64", 2-3/32", 1-1/4" Ring Groove, 2.000" CD, .8592" Pin Dia., Flat Head
4	Cast Piston - Individual	FP-W1102P40	40	Cast; 1-5/64", 2-3/32", 1-1/4" Ring Groove, 2.000" CD, .8592" Pin Dia., Flat Head
4	Cast Piston - Individual	FP-W1102P60	60	Cast; 1-5/64", 2-3/32", 1-1/4" Ring Groove, 2.000" CD, .8592" Pin Dia., Flat Head
4	Pin Bushing	8649XAS		Forging No. F400D-502; Full round, thin wall .0055" O/S OD bushing
4	Pin Bushing	8649XA		Forging No. F400D-502; Full round, thin wall bushing w/.9150" OD
4	Pin Bushing	8649V		Forging No. F400D-502; Split type, thin wall bushing w/.9135" OD
4	Pin Bushing	8649V20		Forging No. F400D-502; Split type, thin wall bushing w/.9135" OD & .020" extra bore stock

(continued on next page)

# John Deere Off Highway



## 21 Combine F162 Eng. Harvester F162 Eng. (cont.) 2.7L 162 L-HEAD L4, 3.4375" Bore (Continental Eng.)

### CYLINDER COMPONENTS (cont.)

QTY	PISTONS (cont.)	PART NO.	SIZE	DESCRIPTION
4	Pin Bushing	FP-9324X		Full round, heavy wall bushing w/1.0625" OD; Forging No. F400D-500
QTY	CONNECTING RODS & BRGS.	PART NO.	SIZE	DESCRIPTION
2	Rod Pair	FP-9320CPA	STD	Position 1-3
2	Rod Pair	FP-9320CPA2	2	Position 1-3
2	Rod Pair	FP-9320CPA10	10	Position 1-3
2	Rod Pair	FP-9320CPA20	20	Position 1-3
2	Rod Pair	FP-9320CPA30	30	Position 1-3
2	Rod Pair	FP-9320CPA40	40	Position 1-3
2	Rod Pair	FP-9320CP	STD	Position 2-4
2	Rod Pair	FP-9320CP10	10	Position 2-4
2	Rod Pair	FP-9320CP20	20	Position 2-4
2	Rod Pair	FP-9320CP30	30	Position 2-4
2	Rod Pair	FP-9320CP40	40	Position 2-4
QTY	PISTON RINGS	PART NO.	SIZE	DESCRIPTION
1	Premium Set	FP-E323KC	STD	Check piston grooving before supplying ring set; 1-5/64, 2-3/32, 1-1/4
1	Premium Set	FP-E323KC20	20	Check piston grooving before supplying ring set; 1-5/64, 2-3/32, 1-1/4
1	Premium Set	FP-E323KC30	30	Check piston grooving before supplying ring set; 1-5/64, 2-3/32, 1-1/4
1	Premium Set	FP-E323KC40	40	Check piston grooving before supplying ring set; 1-5/64, 2-3/32, 1-1/4
1	Premium Set	FP-E323KC60	60	Check piston grooving before supplying ring set; 1-5/64, 2-3/32, 1-1/4
1	Premium Set	FP-926KX	STD	Check piston grooving before supplying ring set; 3-1/8, 1-1/4
1	Premium Set	FP-5039KX	STD	Check piston grooving before supplying ring set; 3-1/8, 1-3/16
1	Premium Set	FP-5607KX	STD	Check piston grooving before supplying ring set; 3-3/32, 1-1/4
1	Standard Set	FP-E323X	STD	Check piston grooving before supplying ring set; 1-5/64, 2-3/32, 1-1/4
1	Standard Set	FP-E323X20	20	Check piston grooving before supplying ring set; 1-5/64, 2-3/32, 1-1/4
1	Standard Set	FP-E323X30	30	Check piston grooving before supplying ring set; 1-5/64, 2-3/32, 1-1/4
1	Standard Set	FP-E323X40	40	Check piston grooving before supplying ring set; 1-5/64, 2-3/32, 1-1/4
1	Standard Set	FP-E323X60	60	Check piston grooving before supplying ring set; 1-5/64, 2-3/32, 1-1/4
1	Standard Set	FP-926X	STD	Check piston grooving before supplying ring set; 3-1/8, 1-1/4
4	Premium Single Cylinder Set	WE-323KC Std-20-30-40-60		Check piston grooving before supplying ring set; 1-5/64, 2-3/32, 1-1/4
4	Premium Single Cylinder Set	W-5039KX Std Only		Check piston grooving before supplying ring set; 3-1/8, 1-3/16
4	Standard Single Cylinder Set	WE-323X Std-20-30-40-60		Check piston grooving before supplying ring set; 1-5/64, 2-3/32, 1-1/4

## 22 Loader 3164G Eng. Wheel Tractor 3164G Eng. 2.7L 164 OHV L3, 4.0156" Bore

### CYL. HEAD & PARTS

QTY	GASKETS	PART NO.	SIZE	DESCRIPTION
1	Valve Cover Gasket	FP-T20111		

QTY	VALVE MISC.	PART NO.	SIZE	DESCRIPTION
1	Oil Filler Cap Gasket	FP-T20328		

### COOLING SYSTEM

QTY	WATER PUMP	PART NO.	SIZE	DESCRIPTION
1	Water Intake Gasket	FP-T23132		
1	Water Pump Mounting Gasket	FP-T20243		

QTY	THERMOSTAT	PART NO.	SIZE	DESCRIPTION
1	Thermostat Cover Gasket	FP-T20215		

QTY	MISCELLANEOUS	PART NO.	SIZE	DESCRIPTION
3	Water Manifold Gasket	FP-T23002		

### ENGINE BLOCK & PARTS

QTY	GASKETS	PART NO.	SIZE	DESCRIPTION
1	Block to End Plate Front Gskt	FP-R131794		

(continued on next page)



# John Deere Off Highway

Loader 3164G Eng. Wheel Tractor 3164G Eng. **22**  
2.7L 164 OHV L3, 4.0156" Bore (cont.)

ENGINE BLOCK & PARTS (cont.)				
QTY	GASKET SETS	PART NO.	SIZE	DESCRIPTION
1	Gasket Conversion Set	FP-PG219CS		Rubber one-piece rear main brg. seal incl.; Wear sleeve incl.
CRANKSHAFT/OIL PUMP				
QTY	CRANKSHAFT	PART NO.	SIZE	DESCRIPTION
1	Oil Seal Kit	FP-SK67942		Incl. front & rear seals
QTY	SEALS - FRONT CRANK	PART NO.	SIZE	DESCRIPTION
1	Crankshaft Front Seal	FP-AR67942		
QTY	SEALS - REAR CRANK	PART NO.	SIZE	DESCRIPTION
1	Crankshaft Rear Seal	FP-RE24959		
QTY	MAIN BEARINGS	PART NO.	SIZE	DESCRIPTION
1	Main Set	FP-MBK3003	STD	w/Flanged thrust brg.
1	Main Set	FP-MBK300310	10	w/Flanged thrust brg.
1	Main Set	FP-MBK300320	20	w/Flanged thrust brg.
1	Main Set	FP-MBK300330	30	w/Flanged thrust brg.
CYLINDER COMPONENTS				
QTY	LINERS	PART NO.	SIZE	DESCRIPTION
3	Sealing Ring	FP-SLR2515		Top sleeve seal; Rectangle
QTY	PISTONS	PART NO.	SIZE	DESCRIPTION
3	Pin Bushing	FP-T23471		1.1896" ID, 1.313" OD, 1.570" O.A.L.
QTY	CONNECTING RODS & BRGS.	PART NO.	SIZE	DESCRIPTION
3	Rod Pair	FP-RE27348	STD	
3	Rod Pair	FP-RE27349	10	
3	Rod Pair	FP-RE27358	20	
3	Rod Pair	FP-RE27364	30	

Combine 3164D Eng. Loader 3164D Eng. Power Unit JD164D, 3164D Engs. Wheel Tractor **23**  
3164D Eng. Crawler Tractor 3164D Eng. Loader Tractor 3164D Engs. Dozer 3164D Eng.  
Backhoe 3164D Eng.  
2.7L 164 OHV Diesel L3, 4.0156" Bore

CYL. HEAD & PARTS				
QTY	GASKETS	PART NO.	SIZE	DESCRIPTION
1	Valve Cover Gasket	FP-R75729		Sheet metal cover
1	Valve Cover Gasket	FP-T20111		To Ser. No. 608,618
1	Head Gasket	FP-R97356		From Ser. No. 100,001; Manufactured after 1983
1	Head Gasket	FP-R97356		From Ser. No. 290,001 to Ser. No. 621,172; Manufactured 1974-83
1	Head Set	FP-RE38850		From Ser. No. 290,001 to Ser. No. 621,172; Manufactured 1974-83
QTY	VALVE	PART NO.	SIZE	DESCRIPTION
3	Intake	FP-R79623	STD	2 groove; Chrome plated stem; 1.7720" Head Dia., .3720" Stem Dia., 5.1560" O.A.L.
3	Intake	FP-R79628	3	2 groove; Chrome plated stem; 1.7720" Head Dia., .3750" Stem Dia., 5.1560" O.A.L.
3	Intake	FP-R79629	15	2 groove; Chrome plated stem; 1.7720" Head Dia., .3870" Stem Dia., 5.1560" O.A.L.
3	Intake	FP-R79630	30	2 groove; Chrome plated stem; 1.7720" Head Dia., .4020" Stem Dia., 5.1560" O.A.L.
3	Exhaust	FP-R79624	STD	1 groove; Chrome plated stem; 1.5750" Head Dia., .3720" Stem Dia., 5.1560" O.A.L.
3	Exhaust	FP-R79625	3	1 groove; Chrome plated stem; 1.5750" Head Dia., .3750" Stem Dia., 5.1560" O.A.L.
3	Exhaust	FP-R79626	15	1 groove; Chrome plated stem; 1.5750" Head Dia., .3870" Stem Dia., 5.1560" O.A.L.
3	Exhaust	FP-R79627	30	1 groove; Chrome plated stem; 1.5750" Head Dia., .4020" Stem Dia., 5.1560" O.A.L.
3	Exhaust	FP-R90692	STD	1 groove; Chrome plated stem; 1.6730" Head Dia., .3095" Stem Dia., 5.2550" O.A.L.
12	Keeper	FP-41339		1 groove; Square cut key groove
12	Keeper	FP-T20077		1 groove; Square cut key groove; Hardened
12	Keeper, Bulk	VK-138B		1 groove; Square cut key groove; Carton of 1000
QTY	VALVE SEAT	PART NO.	SIZE	DESCRIPTION
3	Exh.	FP-R51734	STD	
3	Int.	FP-R73064	STD	

(continued on next page)

**23** Combine 3164D Eng. Loader 3164D Eng. Power Unit JD164D, 3164D Engs. Wheel Tractor  
 (cont.) 3164D Eng. Crawler Tractor 3164D Eng. Loader Tractor 3164D Engs. Dozer 3164D Eng.  
 Backhoe 3164D Eng.  
 2.7L 164 OHV Diesel L3, 4.0156" Bore

### CYL. HEAD & PARTS (cont.)

QTY	VALVE SPRING	PART NO.	SIZE	DESCRIPTION
6	Spring	FP-R26125		2.1200" Free Height
QTY	VALVE MISC.	PART NO.	SIZE	DESCRIPTION
6	Rotocap	FP-RE11410		Exh. & Int.
1	Bushing	FP-T26321		Lower
1	Bushing	FP-T20034		Upper
1	Oil Filler Cap Gasket	FP-T20328		Rocker arm cover code 1101
QTY	VALVE SEAL	PART NO.	SIZE	DESCRIPTION
6	Valve Stem Seal	FP-R87627		Exh. & Int.; O-Ring type
QTY	ROCKER PARTS	PART NO.	SIZE	DESCRIPTION
1	O-Ring	FP-R56463		Rocker cover breather tube; Breather tube codes 2901, 2902, 2903

### ELECTRICAL

QTY	ALTERNATOR	PART NO.	SIZE	DESCRIPTION
1	Ball Brg.	FP-JD9449		Front; Motorola No. A12NJD453; 35 amp alternator
1	Ball Brg.	FP-JD9449		Front; Motorola No. A12NJD604; Code 3102; 55 amp alternator
1	Ball Brg.	FP-JD9449		Front; Motorola No. 8TA2009ES; Code 3104; 30 amp alternator
2	Ball Brg.	FP-JD9449		Front & Rear; Motorola Nos. 8EM2009A, 8EM2009NB; 65 amp alternator

### INT & EXH MANIFOLDS

QTY	INT. & EXH. MANIFOLDS	PART NO.	SIZE	DESCRIPTION
3	Exhaust Manifold Gasket	FP-R90658		
1	Air Intake Gasket	FP-R81275		

### CAMSHAFT GROUP

QTY	TIMING COVER	PART NO.	SIZE	DESCRIPTION
1	Timing Gear Cover Gasket	FP-T20273		Access cover
QTY	CAMSHAFT/LIFTER	PART NO.	SIZE	DESCRIPTION
6	Lifter	FP-T20073		

### FUEL SYSTEM & PARTS

QTY	FUEL INJECTION	PART NO.	SIZE	DESCRIPTION
1	Injector Pump Gasket	FP-R125066		Gear cover
3	Fuel Injector Nozzle	FP-AR89564		
3	Fuel Injector Seal	FP-R79605		Fuel line connection; Nozzle codes 1602, 1603; 9.270MM X 13.600MM X 5.080MM
9	Washer	FP-T20055		Pump codes 1602, 1603; To Ser. No. 127,775
6	Washer Type Seal	FP-R51936		Leak-off & return line seals; w/Nozzle codes 1602, 1603
3	Washer Type Seal	FP-R48000		Lower; w/Nozzle marked 18742, 19762, 20500, 20631, 22042
3	Washer Type Seal	FP-R60746		Upper; w/Nozzle marked 20631, 22042
QTY	FUEL FILTERS & PUMP	PART NO.	SIZE	DESCRIPTION
1	Mechanical Fuel Pump	FP-RE42211		Transfer pump
1	Fuel Transfer Pump Gasket	FP-R97350		

### COOLING SYSTEM

QTY	WATER PUMP	PART NO.	SIZE	DESCRIPTION
1	Water Pump Impeller	FP-R47191		w/Pump housing marked R66420, R68733
1	Water Pump Impeller	FP-R94419		Pump codes 2001, 2002, 2004, 2005
1	Water Pump Repair/Rebuild Kit	FP-944840979		w/Pump housing marked R52009
1	Water Pump Repair/Rebuild Kit	FP-925740979		w/Pump housing marked R56787, R62902
1	Water Pump Repair/Rebuild Kit	FP-RE62661		w/Pump housing marked R66420, R68733
1	Water Pump Housing Gasket	FP-R97455		w/Pump housing marked R48997, R51039, R54051
1	Water Pump Housing Gasket	FP-R55405		w/Pump housing marked R55164
1	Oil Seal Kit	FP-AR101549		Water Pump; w/Pump housing marked R48997, R51039, R54051, R55164, R55758, T29521
1	Water Intake Gasket	FP-T23132		
1	Water Pump Mounting Gasket	FP-T20243		w/Pump housing marked R48997, R51039, R54051, R55164, T29521
1	Shaft & Bearing Assembly	FP-JD9448		w/Cast pulley; w/Pump housing marked R55164; To Ser. No. 368,052
1	Shaft & Bearing Assembly	FP-JD9257		w/Pump housing marked R48997, R51039, R54051, R55164, R55758, T29521
QTY	THERMOSTAT	PART NO.	SIZE	DESCRIPTION
1	Thermostat	FP-RE33705		Thermostat code 2204; 180 Deg.

(continued on next page)



# John Deere Off Highway

**Combine 3164D Eng. Loader 3164D Eng. Power Unit JD164D, 3164D Engs. Wheel Tractor 23  
3164D Eng. Crawler Tractor 3164D Eng. Loader Tractor 3164D Eng. Dozer 3164D Eng. (cont.)  
Backhoe 3164D Eng.  
2.7L 164 OHV Diesel L3, 4.0156" Bore**

<b>COOLING SYSTEM (cont.)</b>				
<b>QTY</b>	<b>THERMOSTAT (cont.)</b>	<b>PART NO.</b>	<b>SIZE</b>	<b>DESCRIPTION</b>
1	Thermostat Gasket	FP-T20219		Thermostat cover codes 2101, 2102; w/housing marked T20218
1	Thermostat Cover Gasket	FP-T20215		Thermostat cover codes 2101, 2102
<b>ENGINE BLOCK &amp; PARTS</b>				
<b>QTY</b>	<b>GASKETS</b>	<b>PART NO.</b>	<b>SIZE</b>	<b>DESCRIPTION</b>
1	Flywheel Housing Gasket	FP-R97351		From Ser. No. 100,001; Manufactured after 1983
1	Flywheel Housing Gasket	FP-R97351		From Ser. No. 290,000 to Ser. No. 621,172; Manufactured from 1974-83
1	Oil Pan Gasket	FP-R97341		Exc. Alum. oil pan
1	Oil Pan Gasket Set	FP-PG300PS		From Ser. No. 100,001; Manufactured after 1983; Exc. Alum. oil pan; Incl. O-rings
1	Oil Pan Gasket Set	FP-PG300PS		From Ser. No. 290,000 to Ser. No. 621,172; Manufactured 1974-83; Exc. sheet metal oil pan; Incl. O-rings
1	Block to End Plate Front Gskt	FP-R131794		
<b>QTY</b>	<b>GASKET SETS</b>	<b>PART NO.</b>	<b>SIZE</b>	<b>DESCRIPTION</b>
1	Gasket Conversion Set	FP-PG219CS		Rubber one-piece rear main brg. seal incl.; Wear sleeve incl.
1	In-Frame Gasket Set	FP-PG164S		
1	Complete Overhaul Gasket Set	FP-RE50978		Crankshaft seals not incl.
1	Complete Overhaul Gasket Set	FP-RE50978WS		Incl. crankshaft seals
<b>QTY</b>	<b>OIL COOLERS &amp; FILTERS</b>	<b>PART NO.</b>	<b>SIZE</b>	<b>DESCRIPTION</b>
1	Washer	FP-R105714		Oil cooler; Modine Oil Cooler codes 5901, 5902
1	Rect. or Square Seal	FP-R70956		Cooler housing w/relief valve; Oil cooler codes 5901, 5902, 5903, 5904; 2.700" X 3.000" X .180"
<b>CRANKSHAFT/OIL PUMP</b>				
<b>QTY</b>	<b>CRANKSHAFT</b>	<b>PART NO.</b>	<b>SIZE</b>	<b>DESCRIPTION</b>
1	Crankshaft	FP-AT18031		
<b>QTY</b>	<b>SEALS - FRONT CRANK</b>	<b>PART NO.</b>	<b>SIZE</b>	<b>DESCRIPTION</b>
1	Crankshaft Front Seal	FP-AR67942		
<b>QTY</b>	<b>SEALS - REAR CRANK</b>	<b>PART NO.</b>	<b>SIZE</b>	<b>DESCRIPTION</b>
1	Oil Seal Kit	FP-SK67942		Incl. front & rear seals; Crankshaft code 1301
1	Crankshaft Rear Seal	FP-RE24959		w/Flywheel housing codes 1402, 1404
<b>QTY</b>	<b>MAIN BEARINGS</b>	<b>PART NO.</b>	<b>SIZE</b>	<b>DESCRIPTION</b>
1	Main Set	FP-MBK3003	STD	w/Flanged thrust brg.
1	Main Set	FP-MBK300310	10	w/Flanged thrust brg.
1	Main Set	FP-MBK300320	20	w/Flanged thrust brg.
1	Main Set	FP-MBK300330	30	w/Flanged thrust brg.
3	Plain Main Brg.	FP-RE27352	STD	w/Flangeless thrust brg.
3	Plain Main Brg.	FP-RE27353	10	w/Flangeless thrust brg.
3	Plain Main Brg.	FP-RE27360	20	w/Flangeless thrust brg.
3	Plain Main Brg.	FP-RE27368	30	w/Flangeless thrust brg.
1	Flanged Main Brg.	FP-RE521350	STD	
1	Flanged Main Brg.	FP-RE526754	10	
1	Flanged Main Brg.	FP-RE527235	20	
1	Flanged Main Brg.	FP-RE527236	30	
4	Thrust Washer	FP-R78598	STD	
<b>QTY</b>	<b>OIL PUMP</b>	<b>PART NO.</b>	<b>SIZE</b>	<b>DESCRIPTION</b>
1	Pump Repair Kit	FP-RE55343		w/Pump housing marked R54615
1	O-Ring	FP-R61871		Oil pump inlet; w/Pump housing marked R54615
1	O-Ring	FP-R74354		Oil pump outlet tube; w/Pump housing marked R54615
1	Oil Filler Inlet Gasket	FP-R97352		Oil filler neck codes 1201, 1202, 1203
<b>CYLINDER COMPONENTS</b>				
<b>QTY</b>	<b>LINERS</b>	<b>PART NO.</b>	<b>SIZE</b>	<b>DESCRIPTION</b>
3	Liner w/o Sealing Ring	FP-R116463	STD	w/o Piston spray cooling; O-rings in block
3	Liner w/o Sealing Ring	FP-T32343	STD	From Ser. No. 178,601
3	Liner w/o Sealing Ring	FP-R48636	STD	To Ser. No. 178,600
3	Liner w/Sealing Rings	FP-T32343WS	STD	From Ser. No. 178,601
3	Liner w/Sealing Rings	FP-AR51903	STD	To Ser. No. 178,600; Incl. 2-FPR4863R (Rect., upper step & lower groove on sleeve) & 1-FPT32341 (Top groove on sleeve) sealing rings.
3	Cylinder Kit Complete	FP-AR78041	STD	w/Con. Rod marked R51727; From Ser. No. 179,602; O-Rings in block; Pin dia, 1.38"
3	Cylinder Kit Complete	FP-AR71593	STD	w/Con. Rod marked T20007, R81410; To Ser. No. 179,601; O-rings in block; Pin dia. 1.19"

(continued on next page)



**23** Combine 3164D Eng. Loader 3164D Eng. Power Unit JD164D, 3164D Engs. Wheel Tractor  
 (cont.) 3164D Eng. Crawler Tractor 3164D Eng. Loader Tractor 3164D Engs. Dozer 3164D Eng.  
 Backhoe 3164D Eng.  
 2.7L 164 OHV Diesel L3, 4.0156" Bore

### CYLINDER COMPONENTS (cont.)

QTY	LINERS (cont.)	PART NO.	SIZE	DESCRIPTION
3	Cylinder Kit Complete	FP-CK83108636	STD	w/Con. Rod marked T20007, R81410; To Ser. No. 179,601; O-rings on liner
3	Cyl. Liner Sealing Ring Kit	FP-AR71618		From Ser. No. 178,601
6	Sealing Ring, Liner	FP-R48637		To Ser. No. 178,600; Rectangle; Top & Bottom
3	Sealing Ring, Liner	FP-T32341		To Ser. No. 178,600; Round
3	Sealing Ring	FP-SLR2388		From Ser. No. 178,601; Round
3	Sealing Ring	FP-SLR2515		Top sleeve seal; Rectangle
QTY	PISTONS	PART NO.	SIZE	DESCRIPTION
3	Piston Body w/o Pin	FP-AR77762	STD	From Ser. No. 179,602
3	Piston Body w/o Pin	FP-AR78310	STD	To Ser. No. 179,601
3	Piston Kit w/Pin & Retainers	FP-AR77762WP	STD	From Ser. No. 179,602
3	Piston Kit w/Pin & Retainers	FP-AR78310WP	STD	To Ser. No. 179,601
3	Pin	FP-R125754		From Ser. No. 179,602; 1.38" pin dia.
3	Pin	FP-T26149		To Ser. No. 179,601
6	Piston Pin Retainer	FP-M41029		From Ser. No. 179,602; For 1.38" pin dia.
6	Piston Pin Retainer	FP-R51112		To Ser. No. 179,601
3	Pin Bushing	FP-R55647		w/Con. Rod marked R51727, R80034; 1.3765" ID, 1.500" OD, 1.570" O.A.L.
3	Pin Bushing	FP-T23471		w/Con. Rod marked R81410, T20007; 1.1896" ID, 1.313" OD, 1.570" O.A.L.
QTY	CONNECTING RODS & BRGS.	PART NO.	SIZE	DESCRIPTION
6	Con. Rod Bolt	FP-R80033		w/Con. Rod marked R80032, R80034, R81410, R105011, R113612; Torque-To-Yield bolt; Replacement recommended
6	Con. Rod Bolt	FP-R74194		w/Con. Rod marked T20007, R51727, R58979; Torque-To-Yield bolt; Replacement recommended
3	Rod Pair	FP-RE27348	STD	
3	Rod Pair	FP-RE27349	10	
3	Rod Pair	FP-RE27358	20	
3	Rod Pair	FP-RE27364	30	
QTY	PISTON RINGS	PART NO.	SIZE	DESCRIPTION
3	Ring Set Single Cylinder	FP-AR55759	STD	1-1/8, 1-3/32, 1-.1965 (1 cyl. set)
KITS				
QTY	OVERHAUL KIT	PART NO.	SIZE	DESCRIPTION
1	In-Frame Overhaul Kit	FP-164LIFK		w/Con. Rod marked R51727; From Ser. No. 179,602; Incl. Torque-To-Yield con. rod bolts
1	In-Frame Overhaul Kit	FP-164EORLIFK		w/Con. Rod marked T20007; O-rings on liner; To Ser. No. 179,601; Incl. Torque-To-Yield con. rod bolts
1	In-Frame Overhaul Kit	FP-164MIFK		w/Con. Rod marked T20007; Pin dia. 1.19"; To Ser. No. 179,601; O-rings in block; Incl. Torque-To-Yield con. rod bolts
1	Complete Overhaul Kit	FP-164LOHK		w/Con. Rod marked R51727; Pin dia. 1.38"; From Ser. No. 179,602; Incl. front & rear seals; Crankshaft code 1301; Incl. Torque-To-Yield con. rod bolts
1	Complete Overhaul Kit	FP-164EORLOHK		w/Con. Rod marked T20007; O-rings on liner; To Ser. No. 179,601; Incl. front & rear seals; Crankshaft code 1301; Incl. Torque-To-Yield con. rod bolts
1	Complete Overhaul Kit	FP-164MOHK		w/Con. Rod marked T20007; Pin dia. 1.19"; To Ser. No. 179,601; O-rings in block; Incl. front & rear seals; Crankshaft code 1301; Incl. Torque-To-Yield con. rod bolts
<b>24</b> Combine 165G Eng. Power Unit 165G Eng. 2.7L 165 OHV L4, 3.875" Bore				
ENGINE BLOCK & PARTS				
QTY	GASKET SETS	PART NO.	SIZE	DESCRIPTION
1	Complete Overhaul Gasket Set	FP-PG115FS		
QTY	CAM BEARINGS	PART NO.	SIZE	DESCRIPTION
1	Cam Set	FP-1251M	STD	
CRANKSHAFT/OIL PUMP				
QTY	SEALS - REAR CRANK	PART NO.	SIZE	DESCRIPTION
1	Crankshaft Rear Seal	FP-RE24959		
QTY	MAIN BEARINGS	PART NO.	SIZE	DESCRIPTION
1	Main Set	FP-4344M	STD	

(continued on next page)



# John Deere Off Highway

**Combine 165G Eng. Power Unit 165G Eng. 24**  
2.7L 165 OHV L4, 3.875" Bore (cont.)

## CRANKSHAFT/OIL PUMP (cont.)

QTY	MAIN BEARINGS (cont.)	PART NO.	SIZE	DESCRIPTION
1	Main Set	FP-4344M10	10	
1	Main Set	FP-4344M20	20	

## CYLINDER COMPONENTS

QTY	CONNECTING RODS & BRGS.	PART NO.	SIZE	DESCRIPTION
4	Rod Pair	FP-2595A	STD	A-Series aluminum bearings
4	Rod Pair	FP-2595A10	10	A-Series aluminum bearings
4	Rod Pair	FP-2595A20	20	A-Series aluminum bearings
4	Rod Pair	FP-2595A30	30	A-Series aluminum bearings

**Combine 165D Eng. Power Unit 165D Eng. Wheel Tractor 165D Eng. 25**  
2.7L 165 OHV Diesel L4, 3.875" Bore

## CYL. HEAD & PARTS

QTY	VALVE	PART NO.	SIZE	DESCRIPTION
16	Keeper	VK-63		2 groove; Round key groove
QTY	VALVE SPRING	PART NO.	SIZE	DESCRIPTION
8	Spring	FP-VS1430		2.1250" Free Height
QTY	VALVE SEAL	PART NO.	SIZE	DESCRIPTION
4	Valve Stem Seal	ST-2001		Int.; Positive type; Installation requires valve guide machining; Rubber/PTFE
4	Valve Stem Seal Bulk	ST-2001BC		Int.; Positive type; Installation requires valve guide machining; Carton of 100; Rubber/PTFE

## ENGINE BLOCK & PARTS

QTY	CAM BEARINGS	PART NO.	SIZE	DESCRIPTION
1	Cam Set	FP-1251M	STD	

## CRANKSHAFT/OIL PUMP

QTY	SEALS - REAR CRANK	PART NO.	SIZE	DESCRIPTION
1	Crankshaft Rear Seal	FP-RE24959		
QTY	MAIN BEARINGS	PART NO.	SIZE	DESCRIPTION
1	Main Set	FP-4145M	STD	Early Eng.s.; w/full groove brgs.
1	Main Set	FP-4145M10	10	Early Eng.s.; w/full groove brgs.
1	Main Set	FP-4145M20	20	Early Eng.s.; w/full groove brgs.
1	Main Set	FP-4145M30	30	Early Eng.s.; w/full groove brgs.
1	Main Set	FP-4345M	STD	Late Eng.s.; w/half groove brgs.
1	Main Set	FP-4345M10	10	Late Eng.s.; w/half groove brgs.
1	Main Set	FP-4345M20	20	Late Eng.s.; w/half groove brgs.

## CYLINDER COMPONENTS

QTY	PISTONS	PART NO.	SIZE	DESCRIPTION
4	Pin Bushing	FP-2599Y20		Early Eng.s.
QTY	CONNECTING RODS & BRGS.	PART NO.	SIZE	DESCRIPTION
4	Rod Pair	FP-2595A	STD	A-Series aluminum bearings
4	Rod Pair	FP-2595A10	10	A-Series aluminum bearings
4	Rod Pair	FP-2595A20	20	A-Series aluminum bearings
4	Rod Pair	FP-2595A30	30	A-Series aluminum bearings
QTY	PISTON RINGS	PART NO.	SIZE	DESCRIPTION
2	Premium Set	FP-9259KX	STD	Model 2010; 3-Ring piston; 2-3/32, 1-3/16 (2 cyl. set)
2	Premium Set	FP-5832KX	STD	Model 2010; 4-Ring piston; 3-3/32, 1-3/16 (2 cyl. set)
4	Premium Single Cylinder Set	W-9259KX Std Only		Model 2010; 3-Ring piston; 2-3/32, 1-3/16 (1 cyl. set)

**Wheel Tractor B Eng. 26**  
2.9L 175 OHV L2, 4.5" Bore

## CYL. HEAD & PARTS

QTY	GASKETS	PART NO.	SIZE	DESCRIPTION
1	Head Set	FP-PG175HS		Models B, BN, BW; From Ser. No. 96000

## ENGINE BLOCK & PARTS

QTY	GASKET SETS	PART NO.	SIZE	DESCRIPTION
1	Complete Overhaul Gasket Set	FP-PG175FS		Models B, BN, BW; From Ser. No. 96000

(continued on next page)

# John Deere Off Highway



**26** Wheel Tractor B Eng.  
(cont.) 2.9L 175 OHV L2, 4.5" Bore

## CYLINDER COMPONENTS

QTY	CONNECTING RODS & BRGS.	PART NO.	SIZE	DESCRIPTION
2	Rod Pair	FP-2180CP	STD	w/Insert type brgs.
2	Rod Pair	FP-2180CP10	10	w/Insert type brgs.
2	Rod Pair	FP-2180CP20	20	w/Insert type brgs.

**27** Wheel Tractor 3179D Eng. Crawler Tractor 3179D Eng. Dozer 3179D Eng.  
2.9L 179 OHV Diesel L3 (Standard), 4.1875" Bore

## CYL. HEAD & PARTS

QTY	GASKETS	PART NO.	SIZE	DESCRIPTION
1	Valve Cover Gasket	FP-R75729		Sheet metal cover; Rocker arm cover codes 1102, 1103; From Ser. No. 576,074
1	Head Gasket	FP-R97356		RePower Eng.s.; Cyl. head codes 5101, 5102
1	Head Set	FP-RE38850		

QTY	VALVE	PART NO.	SIZE	DESCRIPTION
3	Intake	FP-R79623	STD	2 groove; Chrome plated stem; 1.7720" Head Dia., .3720" Stem Dia., 5.1560" O.A.L.
3	Intake	FP-R79628	3	2 groove; Chrome plated stem; 1.7720" Head Dia., .3750" Stem Dia., 5.1560" O.A.L.
3	Intake	FP-R79629	15	2 groove; Chrome plated stem; 1.7720" Head Dia., .3870" Stem Dia., 5.1560" O.A.L.
3	Intake	FP-R79630	30	2 groove; Chrome plated stem; 1.7720" Head Dia., .4020" Stem Dia., 5.1560" O.A.L.
3	Exhaust	FP-R79624	STD	1 groove; Chrome plated stem; 1.5750" Head Dia., .3720" Stem Dia., 5.1560" O.A.L.
3	Exhaust	FP-R79625	3	1 groove; Chrome plated stem; 1.5750" Head Dia., .3750" Stem Dia., 5.1560" O.A.L.
3	Exhaust	FP-R79626	15	1 groove; Chrome plated stem; 1.5750" Head Dia., .3870" Stem Dia., 5.1560" O.A.L.
3	Exhaust	FP-R79627	30	1 groove; Chrome plated stem; 1.5750" Head Dia., .4020" Stem Dia., 5.1560" O.A.L.
12	Keeper	FP-41339		1 groove; Square cut key groove
12	Keeper	FP-T20077		1 groove; Square cut key groove; Hardened
12	Keeper, Bulk	VK-138B		1 groove; Square cut key groove; Carton of 1000

QTY	VALVE SEAT	PART NO.	SIZE	DESCRIPTION
3	Exh.	FP-R51734	STD	
3	Int.	FP-R73064	STD	

QTY	VALVE SPRING	PART NO.	SIZE	DESCRIPTION
6	Spring	FP-R26125		2.1200" Free Height

QTY	VALVE MISC.	PART NO.	SIZE	DESCRIPTION
6	Rotocap	FP-RE11410		Exh. & Int.
1	Bushing	FP-T26321		Lower
1	Bushing	FP-T20034		Upper
1	Oil Filler Cap Gasket	FP-R80135		Oil filler neck codes 1201, 1204; Use w/O.E. filler neck No. R80137; L.H. Auxiliary drive
1	Oil Filler Cap Gasket	FP-T20328		Rocker arm cover code 1103; Oil filler neck codes 1201, 1202, 1203, 1204, 1206; Use w/O.E. filler neck No. T23614

QTY	VALVE SEAL	PART NO.	SIZE	DESCRIPTION
6	Valve Stem Seal	FP-R87627		Exh. & Int.; O-Ring type

QTY	ROCKER PARTS	PART NO.	SIZE	DESCRIPTION
1	O-Ring	FP-R56463		Rocker cover breather tube; Breather tube codes 2902, 2911, 2999

## ELECTRICAL

QTY	ALTERNATOR	PART NO.	SIZE	DESCRIPTION
1	Ball Brg.	FP-JD9449		Front; Motorola components; Codes 3101, 3102, 3104, 3118; 12 Volt, 30 amp alternator
2	Ball Brg.	FP-JD9449		Front & Rear; Codes 3104, 3118; 24 Volt, 45 amp alternator; 12 Volt, 65 amp alternator

## INT & EXH MANIFOLDS

QTY	INT. & EXH. MANIFOLDS	PART NO.	SIZE	DESCRIPTION
3	Exhaust Manifold Gasket	FP-R90658		
1	Air Intake Gasket	FP-R81275		

## CAMSHAFT GROUP

QTY	TIMING COVER	PART NO.	SIZE	DESCRIPTION
1	Timing Gear Cover Gasket	FP-T20273		Access cover

(continued on next page)



Wheel Tractor 3179D Eng. Crawler Tractor 3179D Eng. Dozer 3179D Eng. **27**  
2.9L 179 OHV Diesel L3 (Standard), 4.1875" Bore (cont.)

<b>CAMSHAFT GROUP (cont.)</b>				
QTY	TIMING COVER (cont.)	PART NO.	SIZE	DESCRIPTION
1	Timing Gear Cover Gasket	FP-R97454		Front cover
QTY	CAMSHAFT/LIFTER	PART NO.	SIZE	DESCRIPTION
6	Lifter	FP-T20073		
<b>FUEL SYSTEM &amp; PARTS</b>				
QTY	FUEL INJECTION	PART NO.	SIZE	DESCRIPTION
3	Fuel Injector Nozzle	FP-AR89564		
3	Fuel Injector Seal	FP-R79605		Fuel line connection; Nozzle marked 27333; 9.270MM X 13.600MM X 5.080MM
3	Fuel Injector Nut	FP-R79604		w/Injector marked 27333
2	Clamp	FP-R34766		Pump code 3707
6	Washer Type Seal	FP-R51936		Leak-off & return line seals; w/Nozzle marked 27333
QTY	FUEL FILTERS & PUMP	PART NO.	SIZE	DESCRIPTION
1	Fuel Transfer Pump Gasket	FP-R97350		
<b>COOLING SYSTEM</b>				
QTY	WATER PUMP	PART NO.	SIZE	DESCRIPTION
1	Water Pump Repair/Rebuild Kit	FP-944840979		w/Pump housing marked R52009
1	Water Pump Housing Gasket	FP-R55405		w/Pump housing marked R55130, R55164; From Ser. No. 498,346; w/Pump housing marked R100812, R127918
1	Water Pump Housing Gasket	FP-R55406		w/Pump housing marked R55130, R55164; To Ser. No. 498,346
1	Water Pump Housing Gasket	FP-R97455		w/Pump housing marked R73604, R91724, R91810
1	Water Pump Mounting Gasket	FP-T20243		w/Pump housing marked R55130, R73604, R91810, R100812, R122337, R127918
1	Shaft & Bearing Assembly	FP-JD9448		w/Cast pulley; w/Pump housing marked R55164
QTY	THERMOSTAT	PART NO.	SIZE	DESCRIPTION
1	Thermostat	FP-AR61538		Thermostat code 2208; 181 Deg.
1	Thermostat Gasket	FP-T20219		Thermostat housing codes 3901 marked R60256, T20218; Thermostat housing codes 3909, 3910; Thermostat cover codes 2101, 2104, 3914 marked R91165
1	Thermostat Cover Gasket	FP-T20215		Thermostat cover codes 2101, 2102; Thermostat housing codes 2101, 2204, 3914; w/housing marked R91165
<b>ENGINE BLOCK &amp; PARTS</b>				
QTY	GASKETS	PART NO.	SIZE	DESCRIPTION
1	Flywheel Housing Gasket	FP-R97351		R.H.; Use w/Flywheel housing SAE 4; w/2 hole mounting
1	Oil Pan Gasket	FP-R97341		Exc. Alum. oil pan
1	Block to End Plate Front Gskt	FP-R131794		Front plate codes 3601, 3602, 3695
QTY	GASKET SETS	PART NO.	SIZE	DESCRIPTION
1	Gasket Conversion Set	FP-PG219CS		Rubber one-piece rear main brg. seal incl.; Wear sleeve incl.
1	In-Frame Gasket Set	FP-PG164S		
1	Complete Overhaul Gasket Set	FP-RE50978		Crankshaft seals not incl.
1	Complete Overhaul Gasket Set	FP-RE50978WS		Incl. crankshaft seals
QTY	CAM BEARINGS	PART NO.	SIZE	DESCRIPTION
1	Cam Brg.	FP-R119874		
QTY	OIL COOLERS & FILTERS	PART NO.	SIZE	DESCRIPTION
1	Washer	FP-R105714		Oil cooler; Modine Oil Cooler codes 5904, 5906
1	Rect. or Square Seal	FP-R70956		Cooler housing w/relief valve; w/Behr cooler codes 5904, 5906; 2.700" X 3.000" X .180"
<b>CRANKSHAFT/OIL PUMP</b>				
QTY	CRANKSHAFT	PART NO.	SIZE	DESCRIPTION
1	Crankshaft	FP-AT18031		
1	Oil Seal Kit	FP-SK67942		RePower Engs.; Crankshaft codes 4701, 4703, 4704, 4705; Incl. front & rear seals
QTY	SEALS - FRONT CRANK	PART NO.	SIZE	DESCRIPTION
1	Crankshaft Front Seal	FP-AR67942		
1	O-Ring	FP-H35244		Crankshaft pulley; Pulley codes 1313, 1314, 1329; Crankshaft, Bearing codes 4701, 4702, 4704, 4705, 4710
QTY	SEALS - REAR CRANK	PART NO.	SIZE	DESCRIPTION
1	Crankshaft Rear Seal	FP-RE24959		RePower Engs.; Crankshaft codes 4701, 4702, 4710
QTY	MAIN BEARINGS	PART NO.	SIZE	DESCRIPTION
1	Main Set	FP-MBK3003	STD	w/Flanged thrust brg.
1	Main Set	FP-MBK300310	10	w/Flanged thrust brg.
1	Main Set	FP-MBK300320	20	w/Flanged thrust brg.
1	Main Set	FP-MBK300330	30	w/Flanged thrust brg.

(continued on next page)

## 27 Wheel Tractor 3179D Eng. Crawler Tractor 3179D Eng. Dozer 3179D Eng. (cont.) 2.9L 179 OHV Diesel L3 (Standard), 4.1875" Bore

CRANKSHAFT/OIL PUMP (cont.)				
QTY	DESCRIPTION	PART NO.	SIZE	DESCRIPTION
<b>MAIN BEARINGS</b> (cont.)				
3	Plain Main Brg.	FP-RE27352	STD	w/Flangeless thrust brg.
3	Plain Main Brg.	FP-RE27353	10	w/Flangeless thrust brg.
3	Plain Main Brg.	FP-RE27360	20	w/Flangeless thrust brg.
3	Plain Main Brg.	FP-RE27368	30	w/Flangeless thrust brg.
1	Flanged Main Brg.	FP-RE521350	STD	
1	Flanged Main Brg.	FP-RE526754	10	
1	Flanged Main Brg.	FP-RE527235	20	
1	Flanged Main Brg.	FP-RE527236	30	
3	Thrust Washer	FP-R78598	STD	Use w/Flangeless thrust brg.
<b>OIL PUMP</b>				
1	O-Ring	FP-R74354		Oil pump outlet tube; Pump code 5001; w/Pump housing marked R54615
1	Oil Filler Inlet Gasket	FP-R97352		Oil filler neck codes 1201, 1202, 1203, 1206, 1299
CYLINDER COMPONENTS				
QTY	DESCRIPTION	PART NO.	SIZE	DESCRIPTION
<b>LINERS</b>				
3	Liner w/o Sealing Ring	FP-R116281		
3	Liner w/Sealing Rings	FP-RE500023		
3	Cylinder Kit Complete	FP-RE30250	STD	w/Con. Rod marked R51727, R80034
3	Cyl. Liner Sealing Ring Kit	FP-AR65507		
3	Sealing Ring, Liner	FP-R48767		Rectangle; Top
3	Sealing Ring	FP-SLR2520		Round; Bottom
<b>PISTONS</b>				
3	Piston Body w/o Pin	FP-RE19282		
3	Piston Kit w/Pin & Retainers	FP-RE19282WP		
3	Pin	FP-R125754		1.38" pin dia.
6	Piston Pin Retainer	FP-M41029		For 1.38" pin dia.
3	Pin Bushing	FP-R55647		w/Con. Rod marked R51727, R80034; 1.3765" ID, 1.500" OD, 1.570" O.A.L.
<b>CONNECTING RODS &amp; BRGS.</b>				
QTY	DESCRIPTION	PART NO.	SIZE	DESCRIPTION
6	Con. Rod Bolt	FP-R80033		w/Con. Rod marked R51727, R80032, R80034, R81410, R105011, R113612; Torque-To-Yield bolt; Replacement recommended
6	Con. Rod Bolt	FP-R74194		w/Con. Rod marked T20007, R51727, R58979; Torque-To-Yield bolt; Replacement recommended
3	Rod Pair	FP-RE27348	STD	
3	Rod Pair	FP-RE27349	10	
3	Rod Pair	FP-RE27358	20	
3	Rod Pair	FP-RE27364	30	
<b>PISTON RINGS</b>				
QTY	DESCRIPTION	PART NO.	SIZE	DESCRIPTION
3	Ring Set Single Cylinder	FP-RE507852	STD	1-1/8, 1-3/32, 1-.136 (1 cyl. set)
3	Ring Set Single Cylinder	FP-RE66820	STD	1-1/8, 1-3/32, 1-.136 (1 cyl. set)
KITS				
QTY	DESCRIPTION	PART NO.	SIZE	DESCRIPTION
1	In-Frame Overhaul Kit	FP-179DIFK		w/Con. Rod marked R51727, R80034; Crankshaft codes 4701, 4703, 4704, 4705; Incl. Torque-To-Yield con. rod bolts
1	Complete Overhaul Kit	FP-179DOHK		w/Con. Rod marked R51727, R80034; RePower Eng.s.; Crankshaft codes 4701, 4703, 4704, 4705; Incl. front & rear seals; Incl. Torque-To-Yield con. rod bolts

## 28 Wheel Tractor 3179T Eng. 2.9L 179 OHV Turbo-Diesel L3 (Standard), 4.1875" Bore

CYL. HEAD & PARTS				
QTY	DESCRIPTION	PART NO.	SIZE	DESCRIPTION
<b>GASKETS</b>				
1	Valve Cover Gasket	FP-R75729		Sheet metal cover; Rocker arm cover codes 1102, 1103; From Ser. No. 576,074
1	Head Gasket	FP-R97356		RePower Eng.s.; Cyl. head codes 5101, 5102
1	Head Set	FP-RE38850		RePower Eng.s.; Cyl. head codes 5101, 5102
<b>VALVE</b>				
QTY	DESCRIPTION	PART NO.	SIZE	DESCRIPTION
3	Intake	FP-R83071	STD	Stellite; 2 groove; Chrome plated stem; 1.8210" Head Dia., .3720" Stem Dia., 5.1660" O.A.L.
3	Intake	FP-R89223	3	Stellite; 2 groove; Chrome plated stem; 1.8210" Head Dia., .3750" Stem Dia., 5.1660" O.A.L.
3	Intake	FP-R89224	15	Stellite; 2 groove; Chrome plated stem; 1.8210" Head Dia., .3870" Stem Dia., 5.1660" O.A.L.

(continued on next page)



# John Deere Off Highway

*Wheel Tractor 3179T Eng. 28*  
2.9L 179 OHV Turbo-Diesel L3 (Standard), 4.1875" Bore (cont.)

<b>CYL. HEAD &amp; PARTS (cont.)</b>				
<b>QTY</b>	<b>VALVE (cont.)</b>	<b>PART NO.</b>	<b>SIZE</b>	<b>DESCRIPTION</b>
3	Intake	FP-R79623	STD	2 groove; Chrome plated stem; 1.7720" Head Dia., .3720" Stem Dia., 5.1560" O.A.L.
3	Intake	FP-R79628	3	2 groove; Chrome plated stem; 1.7720" Head Dia., .3750" Stem Dia., 5.1560" O.A.L.
3	Intake	FP-R79629	15	2 groove; Chrome plated stem; 1.7720" Head Dia., .3870" Stem Dia., 5.1560" O.A.L.
3	Intake	FP-R79630	30	2 groove; Chrome plated stem; 1.7720" Head Dia., .4020" Stem Dia., 5.1560" O.A.L.
3	Exhaust	FP-R79624	STD	1 groove; Chrome plated stem; 1.5750" Head Dia., .3720" Stem Dia., 5.1560" O.A.L.
3	Exhaust	FP-R79625	3	1 groove; Chrome plated stem; 1.5750" Head Dia., .3750" Stem Dia., 5.1560" O.A.L.
3	Exhaust	FP-R79626	15	1 groove; Chrome plated stem; 1.5750" Head Dia., .3870" Stem Dia., 5.1560" O.A.L.
3	Exhaust	FP-R79627	30	1 groove; Chrome plated stem; 1.5750" Head Dia., .4020" Stem Dia., 5.1560" O.A.L.
12	Keeper	FP-41339		1 groove; Square cut key groove
12	Keeper	FP-T20077		1 groove; Square cut key groove; Hardened
12	Keeper, Bulk	VK-138B		1 groove; Square cut key groove; Carton of 1000
<b>QTY</b>	<b>VALVE SEAT</b>	<b>PART NO.</b>	<b>SIZE</b>	<b>DESCRIPTION</b>
3	Exh.	FP-R51734	STD	
3	Int.	FP-R73064	STD	
<b>QTY</b>	<b>VALVE SPRING</b>	<b>PART NO.</b>	<b>SIZE</b>	<b>DESCRIPTION</b>
6	Spring	FP-R26125		2.1200" Free Height
<b>QTY</b>	<b>VALVE MISC.</b>	<b>PART NO.</b>	<b>SIZE</b>	<b>DESCRIPTION</b>
6	Rotocap	FP-RE11410		Exh. & Int.
1	Bushing	FP-T26321		Lower
1	Bushing	FP-T20034		Upper
1	Oil Filler Cap Gasket	FP-T20328		Rocker arm cover code 1103; Oil filler neck codes 1201, 1202, 1203, 1204, 1206
<b>QTY</b>	<b>VALVE SEAL</b>	<b>PART NO.</b>	<b>SIZE</b>	<b>DESCRIPTION</b>
6	Valve Stem Seal	FP-R87627		Exh. & Int.; O-Ring type
<b>QTY</b>	<b>ROCKER PARTS</b>	<b>PART NO.</b>	<b>SIZE</b>	<b>DESCRIPTION</b>
1	O-Ring	FP-R56463		Rocker cover breather tube; Breather tube codes 2902, 2911, 2999
<b>ELECTRICAL</b>				
<b>QTY</b>	<b>ALTERNATOR</b>	<b>PART NO.</b>	<b>SIZE</b>	<b>DESCRIPTION</b>
1	Ball Brg.	FP-JD9449		Front; Motorola components; Codes 3104, 3118; 12 Volt, 30 amp alternator
2	Ball Brg.	FP-JD9449		Front & Rear; 24 Volt, 45 amp alternator; 12 Volt, 65 amp alternator
<b>INT &amp; EXH MANIFOLDS</b>				
<b>QTY</b>	<b>INT. &amp; EXH. MANIFOLDS</b>	<b>PART NO.</b>	<b>SIZE</b>	<b>DESCRIPTION</b>
3	Exhaust Manifold Gasket	FP-R90658		
<b>CAMSHAFT GROUP</b>				
<b>QTY</b>	<b>TIMING COVER</b>	<b>PART NO.</b>	<b>SIZE</b>	<b>DESCRIPTION</b>
1	Timing Gear Cover Gasket	FP-R97454		Front cover
<b>QTY</b>	<b>CAMSHAFT/LIFTER</b>	<b>PART NO.</b>	<b>SIZE</b>	<b>DESCRIPTION</b>
6	Lifter	FP-T20073		
<b>FUEL SYSTEM &amp; PARTS</b>				
<b>QTY</b>	<b>FUEL INJECTION</b>	<b>PART NO.</b>	<b>SIZE</b>	<b>DESCRIPTION</b>
3	Fuel Injector Seal	FP-R79605		Fuel line connection; Nozzle codes 1602, 1603; Nozzle marked 26992; 9.270MM X 13.600MM X 5.080MM
3	Fuel Injector Nut	FP-R79604		w/Injector marked 26992
2	Clamp	FP-R34766		Pump code 3707
6	Washer Type Seal	FP-R51936		Leak-off & return line seals; w/Nozzle codes 1602, 1632; w/Nozzle marked 26992
<b>QTY</b>	<b>FUEL FILTERS &amp; PUMP</b>	<b>PART NO.</b>	<b>SIZE</b>	<b>DESCRIPTION</b>
1	Fuel Transfer Pump Gasket	FP-R97350		
<b>COOLING SYSTEM</b>				
<b>QTY</b>	<b>WATER PUMP</b>	<b>PART NO.</b>	<b>SIZE</b>	<b>DESCRIPTION</b>
1	Water Pump Housing Gasket	FP-R55405		w/Pump housing marked R55130, R55164, R100812, R127912

(continued on next page)

# John Deere Off Highway



**28 Wheel Tractor 3179T Eng.**  
(cont.) 2.9L 179 OHV Turbo-Diesel L3 (Standard), 4.1875" Bore

COOLING SYSTEM (cont.)				
QTY	WATER PUMP (cont.)	PART NO.	SIZE	DESCRIPTION
1	Water Pump Housing Gasket	FP-R97455		w/Pump housing marked R73604, R91724
1	Water Pump Mounting Gasket	FP-T20243		w/Pump housing marked R55130, R73604, R91724, R91810, R100812, R122337, R127918
1	Shaft & Bearing Assembly	FP-JD9448		w/Cast pulley; w/Pump housing marked R55164
QTY	THERMOSTAT	PART NO.	SIZE	DESCRIPTION
1	Thermostat	FP-AR61538		Thermostat code 2208; 181 Deg.
1	Thermostat Gasket	FP-T20219		Thermostat housing codes 3901 marked R60256, T20218; Thermostat housing codes 3909, 3910; Thermostat cover codes 2101, 2104, 3914 marked R91165
1	Thermostat Cover Gasket	FP-T20215		Thermostat cover codes 2101, 2102; Thermostat housing codes 2101, 2204, 3914; w/housing marked R91165
ENGINE BLOCK & PARTS				
QTY	GASKETS	PART NO.	SIZE	DESCRIPTION
1	Flywheel Housing Gasket	FP-R97351		R.H.; Use w/Flywheel housing SAE 4; w/2 hole mounting
1	Oil Pan Gasket	FP-R97341		Exc. Alum. oil pan
1	Block to End Plate Front Gskt	FP-R131794		Front plate codes 3601, 3602, 3695
QTY	GASKET SETS	PART NO.	SIZE	DESCRIPTION
1	Gasket Conversion Set	FP-PG219CS		Rubber one-piece rear main brg. seal incl.; Wear sleeve incl.
1	In-Frame Gasket Set	FP-PG164S		
1	Complete Overhaul Gasket Set	FP-RE50978		Crankshaft seals not incl.
1	Complete Overhaul Gasket Set	FP-RE50978WS		Incl. crankshaft seals
QTY	CAM BEARINGS	PART NO.	SIZE	DESCRIPTION
1	Cam Brg.	FP-R119874		
QTY	OIL COOLERS & FILTERS	PART NO.	SIZE	DESCRIPTION
1	Washer	FP-R105714		Oil cooler; Modine Oil Cooler codes 5904, 5906
1	Rect. or Square Seal	FP-R70956		Cooler housing w/relief valve; w/Behr cooler codes 5904, 5906; 2.700" X 3.000" X .180"
CRANKSHAFT/OIL PUMP				
QTY	CRANKSHAFT	PART NO.	SIZE	DESCRIPTION
1	Crankshaft	FP-AT18031		
1	Oil Seal Kit	FP-SK67942		RePower Engs.; Crankshaft codes 4701, 4702, 4703, 4705, 4710; Incl. front & rear seals
QTY	SEALS - FRONT CRANK	PART NO.	SIZE	DESCRIPTION
1	Crankshaft Front Seal	FP-AR67942		
1	O-Ring	FP-H35244		Crankshaft pulley; Pulley codes 1313, 1314, 1329; Crankshaft, Bearing codes 4701, 4702, 4704, 4705, 4710
QTY	SEALS - REAR CRANK	PART NO.	SIZE	DESCRIPTION
1	Crankshaft Rear Seal	FP-RE24959		RePower Engs.; Crankshaft codes 4701, 4702, 4710
QTY	MAIN BEARINGS	PART NO.	SIZE	DESCRIPTION
1	Main Set	FP-MBK3003	STD	w/Flanged thrust brg.
1	Main Set	FP-MBK300310	10	w/Flanged thrust brg.
1	Main Set	FP-MBK300320	20	w/Flanged thrust brg.
1	Main Set	FP-MBK300330	30	w/Flanged thrust brg.
3	Plain Main Brg.	FP-RE27352	STD	w/Flangeless thrust brg.
3	Plain Main Brg.	FP-RE27353	10	w/Flangeless thrust brg.
3	Plain Main Brg.	FP-RE27360	20	w/Flangeless thrust brg.
3	Plain Main Brg.	FP-RE27368	30	w/Flangeless thrust brg.
1	Flanged Main Brg.	FP-RE521350	STD	
1	Flanged Main Brg.	FP-RE526754	10	
1	Flanged Main Brg.	FP-RE527235	20	
1	Flanged Main Brg.	FP-RE527236	30	
3	Thrust Washer	FP-R78598	STD	Use w/Flangeless thrust brg.
QTY	OIL PUMP	PART NO.	SIZE	DESCRIPTION
1	O-Ring	FP-R74354		Oil pump outlet tube; Pump codes 5001, 5002; w/Pump housing marked R54615
1	Oil Filler Inlet Gasket	FP-R97352		Oil filler neck codes 1201, 1202, 1203, 1206, 1299
CYLINDER COMPONENTS				
QTY	LINERS	PART NO.	SIZE	DESCRIPTION
3	Liner w/o Sealing Ring	FP-R116281		
3	Liner w/Sealing Rings	FP-RE500023		
3	Cylinder Kit Complete	FP-RE33115		w/Con. Rod marked R58979, R80032, R113612
3	Cyl. Liner Sealing Ring Kit	FP-AR65507		
3	Sealing Ring, Liner	FP-R48767		Rectangle; Top

(continued on next page)





# John Deere Off Highway

*Wheel Tractor 3179T Eng. 28*  
2.9L 179 OHV Turbo-Diesel L3 (Standard), 4.1875" Bore (cont.)

<b>CYLINDER COMPONENTS (cont.)</b>				
<b>QTY</b>	<b>LINERS (cont.)</b>	<b>PART NO.</b>	<b>SIZE</b>	<b>DESCRIPTION</b>
3	Sealing Ring	FP-SLR2520		Round; Bottom
<b>QTY</b>	<b>PISTONS</b>	<b>PART NO.</b>	<b>SIZE</b>	<b>DESCRIPTION</b>
3	Piston Body w/o Pin	FP-RE48368		
3	Piston Kit w/Pin & Retainers	FP-RE48368WP		
3	Pin	FP-R124230		1.62" pin dia.
6	Piston Pin Retainer	FP-R54114		For 1.62" pin dia.
3	Pin Bushing	FP-R57451		w/Con. Rod marked R56187, R58979, R80032, R113612; Pin dia. 1.62"; 1.621" ID, 1.813" OD, 1.370" O.A.L.
<b>QTY</b>	<b>CONNECTING RODS &amp; BRGS.</b>	<b>PART NO.</b>	<b>SIZE</b>	<b>DESCRIPTION</b>
6	Con. Rod Bolt	FP-R80033		w/Con. Rod marked R80032, R80034, R81410, R105011, R113612; Torque-To-Yield bolt; Replacement recommended
6	Con. Rod Bolt	FP-R74194		w/Con. Rod marked T20007, R51727, R58979; Torque-To-Yield bolt; Replacement recommended
3	Rod Pair	FP-RE27348	STD	
3	Rod Pair	FP-RE27349	10	
3	Rod Pair	FP-RE27358	20	
3	Rod Pair	FP-RE27364	30	
<b>QTY</b>	<b>PISTON RINGS</b>	<b>PART NO.</b>	<b>SIZE</b>	<b>DESCRIPTION</b>
3	Ring Set Single Cylinder	FP-RE507852	STD	1-1/8, 1-3/32, 1-.136 (1 cyl. set)
3	Ring Set Single Cylinder	FP-RE66820	STD	1-1/8, 1-3/32, 1-.136 (1 cyl. set)
<b>KITS</b>				
<b>QTY</b>	<b>OVERHAUL KIT</b>	<b>PART NO.</b>	<b>SIZE</b>	<b>DESCRIPTION</b>
1	In-Frame Overhaul Kit	FP-179TIFK		w/Con. Rod marked R58979, R80032, R80034, R81410, R10511, R113612; Incl. Torque-To-Yield con. rod bolts
1	Complete Overhaul Kit	FP-179TOHK		w/Con. Rod marked R58979, R80032, R80034, R81410, R10511, R113612; Pin dia. 1.62"; RePower Eng.s.; Crankshaft codes 4701, 4702, 4703, 4705; Incl. front & rear seals; Incl. Torque-To-Yield con. rod bolts

*Power Unit 3029D PowerTech Eng. Wheel Tractor 3029D PowerTech Eng. Track Loader 29*  
**3029D PowerTech Eng.**  
2.9L 179.2 (2938cc) OHV Diesel L3 (PowerTech 2V), 106mm Bore

<b>CYL. HEAD &amp; PARTS</b>				
<b>QTY</b>	<b>GASKETS</b>	<b>PART NO.</b>	<b>SIZE</b>	<b>DESCRIPTION</b>
1	Head Gasket	FP-R97356		Cyl. head codes 5104, 5105, 5106
1	Head Set	FP-RE38850		
<b>QTY</b>	<b>VALVE</b>	<b>PART NO.</b>	<b>SIZE</b>	<b>DESCRIPTION</b>
3	Intake	FP-R98062	STD	1 groove; Chrome plated stem; 1.8350" Head Dia., .3100" Stem Dia., 5.2780" O.A.L.
3	Intake	FP-R97490	15	1 groove; Chrome plated stem; 1.8350" Head Dia., .3250" Stem Dia., 5.2780" O.A.L.
3	Exhaust	FP-R90692	STD	1 groove; Chrome plated stem; 1.6730" Head Dia., .3095" Stem Dia., 5.2550" O.A.L.
3	Exhaust	FP-R97492	15	1 groove; Chrome plated stem; 1.6730" Head Dia., .3245" Stem Dia., 5.2550" O.A.L.
12	Keeper	FP-R91889		Exh. & Int.
<b>QTY</b>	<b>VALVE SPRING</b>	<b>PART NO.</b>	<b>SIZE</b>	<b>DESCRIPTION</b>
6	Spring	FP-R26125		Exh. & Int.; 2.1200" Free Height
<b>QTY</b>	<b>VALVE MISC.</b>	<b>PART NO.</b>	<b>SIZE</b>	<b>DESCRIPTION</b>
6	Rotocap	FP-RE60005		Exh. & Int.
1	Oil Filler Cap Gasket	FP-T20328		Oil filler neck codes 1201, 1202, 1203, 1206
<b>QTY</b>	<b>VALVE SEAL</b>	<b>PART NO.</b>	<b>SIZE</b>	<b>DESCRIPTION</b>
6	Valve Stem Seal	FP-RE31617		Exh. & Int.; Positive type
<b>INT &amp; EXH MANIFOLDS</b>				
<b>QTY</b>	<b>INT. &amp; EXH. MANIFOLDS</b>	<b>PART NO.</b>	<b>SIZE</b>	<b>DESCRIPTION</b>
3	Exhaust Manifold Gasket	FP-R90658		
1	Air Intake Gasket	FP-R81275		
<b>CAMSHAFT GROUP</b>				
<b>QTY</b>	<b>TIMING COVER</b>	<b>PART NO.</b>	<b>SIZE</b>	<b>DESCRIPTION</b>
1	Timing Gear Cover Gasket	FP-R97454		Front cover
1	Timing Gear Cover Gasket	FP-R108654		Use w/R.H. side gear dr. timing gear cover

(continued on next page)

**29** Power Unit 3029D PowerTech Eng. Wheel Tractor 3029D PowerTech Eng. Track Loader  
 (cont.) **3029D PowerTech Eng.**  
 2.9L 179.2 (2938cc) OHV Diesel L3 (PowerTech 2V), 106mm Bore

CAMSHAFT GROUP (cont.)				
QTY	CAMSHAFT/LIFTER	PART NO.	SIZE	DESCRIPTION
6	Lifter	FP-T20073		
FUEL SYSTEM & PARTS				
QTY	FUEL INJECTION	PART NO.	SIZE	DESCRIPTION
3	Fuel Injector Nozzle	FP-RE36935		w/Injector marked 28480
3	Fuel Injector Nut	FP-R79604		w/Injector marked 28480
3	FI Installation Kit	FP-RE65201		
6	Washer Type Seal	FP-R51936		Leak-off & return line seals; w/Nozzle marked 28480
3	Washer Type Seal	FP-R48000		Lower; w/Nozzle marked 28480, 28484
3	Washer Type Seal	FP-R60746		Upper; w/Nozzle marked 28480
COOLING SYSTEM				
QTY	WATER PUMP	PART NO.	SIZE	DESCRIPTION
1	Water Pump Repair/Rebuild Kit	FP-RE62658		Pump codes 2010, 2020, 2022, 2023; w/Pump housing marked R73604
1	Water Pump Housing Gasket	FP-R97455		w/Pump housing marked R73604
1	Water Pump Mounting Gasket	FP-T20243		w/H/D Pump housing marked R100812, R127918
1	Water Pump Mounting Gasket	FP-T20243		w/Pump housing marked R48997, R55164, R73604, R110541
QTY	THERMOSTAT	PART NO.	SIZE	DESCRIPTION
1	Thermostat Cover Gasket	FP-T20215		Thermostat cover codes 2101, 2102
1	Therm. Hsg. - Water Mfld. Gsk	FP-R54641		Thermostat housing to cyl. head; To Ser. No. 205,211
ENGINE BLOCK & PARTS				
QTY	GASKETS	PART NO.	SIZE	DESCRIPTION
1	Oil Pan Gasket	FP-R97341		Exc. Alum. oil pan
1	Oil Pan Gasket Set	FP-PG300PS		Exc. Alum. oil pan; Incl. O-rings
1	Block to End Plate Front Gskt	FP-R131794		Front plate code 3604; R.H. side gear drive
QTY	GASKET SETS	PART NO.	SIZE	DESCRIPTION
1	In-Frame Gasket Set	FP-PG164S		
1	Complete Overhaul Gasket Set	FP-RE50978		Crankshaft seals not incl.
1	Complete Overhaul Gasket Set	FP-RE50978WS		Incl. crankshaft seals
QTY	CAM BEARINGS	PART NO.	SIZE	DESCRIPTION
1	Cam Brg.	FP-R119874		
QTY	OIL COOLERS & FILTERS	PART NO.	SIZE	DESCRIPTION
1	Oil Cooler	FP-RE61767		Cooler codes 5904, 5906, 5908, 5914, 5920
1	Rect. or Square Seal	FP-R70956		Cooler housing w/relief valve; Oil cooler codes 5904, 5906, 5908, 5914, 5916; To Ser. No. 185,223; 2.700" X 3.000" X .180"
CRANKSHAFT/OIL PUMP				
QTY	CRANKSHAFT	PART NO.	SIZE	DESCRIPTION
1	Oil Seal Kit	FP-SK67942		Incl. front & rear seals; Crankshaft codes 4702, 4704, 4705, 4710; From Ser. No. 100,000
QTY	SEALS - FRONT CRANK	PART NO.	SIZE	DESCRIPTION
1	Crankshaft Front Seal	FP-AR67942		
1	O-Ring	FP-H35244		Crankshaft pulley; Pulley codes 1313, 1314, 1329
QTY	SEALS - REAR CRANK	PART NO.	SIZE	DESCRIPTION
1	Crankshaft Rear Seal	FP-RE24959		RePower Engs.; Crankshaft codes 4701, 4702, 4710
QTY	MAIN BEARINGS	PART NO.	SIZE	DESCRIPTION
3	Plain Main Brg.	FP-RE27352	STD	w/Flangeless thrust brg.
3	Plain Main Brg.	FP-RE27353	10	w/Flangeless thrust brg.
3	Plain Main Brg.	FP-RE27360	20	w/Flangeless thrust brg.
3	Plain Main Brg.	FP-RE27368	30	w/Flangeless thrust brg.
1	Flanged Main Brg.	FP-RE521350	STD	
1	Flanged Main Brg.	FP-RE526754	10	
1	Flanged Main Brg.	FP-RE527235	20	
1	Flanged Main Brg.	FP-RE527236	30	
4	Thrust Washer	FP-R78598	STD	Use w/Flangeless thrust brg.
QTY	OIL PUMP	PART NO.	SIZE	DESCRIPTION
1	Pump Repair Kit	FP-RE55343		w/Pump housing marked R54615
1	O-Ring	FP-R61871		Oil pump inlet; Pump codes 5001, 5002, 5005, 5007, 5012, 5016
1	O-Ring	FP-R74354		Oil pump outlet tube; Pump codes 5001, 5002, 5005, 5007, 5008, 5009, 5010, 5011, 5012, 5013, 5014, 5015, 5016; w/Pump housing marked R54615
1	Oil Filler Inlet Gasket	FP-R97352		Oil filler neck codes 1201, 1203, 1299

(continued on next page)



**Power Unit 3029D PowerTech Eng. Wheel Tractor 3029D PowerTech Eng. Track Loader 29**  
**3029D PowerTech Eng. (cont.)**  
 2.9L 179.2 (2938cc) OHV Diesel L3 (PowerTech 2V), 106mm Bore

CYLINDER COMPONENTS				
QTY	LINERS	PART NO.	SIZE	DESCRIPTION
3	Liner w/o Sealing Ring	FP-R116281		
3	Liner w/Sealing Rings	FP-RE500023		
3	Cylinder Kit Complete	FP-RE66968 *	STD	From Ser. No. 252768; Piston numbers RE61467, RE500210
3	Cylinder Kit Complete	FP-RE48721 *	STD	To Ser. No. 252767
3	Cyl. Liner Sealing Ring Kit	FP-AR65507		
QTY	PISTONS	PART NO.	SIZE	DESCRIPTION
3	Piston Kit w/Pin & Retainers	FP-RE61467WP *	STD	From Ser. No. 252768
QTY	CONNECTING RODS & BRGS.	PART NO.	SIZE	DESCRIPTION
6	Con. Rod Bolt	FP-R80033		w/Con. Rod marked R121092; Torque-To-Yield bolt; Replacement recommended
3	Rod Pair	FP-RE27348	STD	w/Con. Rod marked R121092
3	Rod Pair	FP-RE27349	10	w/Con. Rod marked R121092
3	Rod Pair	FP-RE27358	20	w/Con. Rod marked R121092
3	Rod Pair	FP-RE27364	30	w/Con. Rod marked R121092
QTY	PISTON RINGS	PART NO.	SIZE	DESCRIPTION
3	Ring Set Single Cylinder	FP-RE66271	STD	From Ser. No. 252,768; Piston codes RE61467, RE61270
3	Ring Set Single Cylinder	FP-RE507852	STD	To Ser. No. 252,767; Piston codes RE45323, RE40557; 1-1/8, 1-3/32, 1-.136 (1 cyl. set)
3	Ring Set Single Cylinder	FP-RE66820	STD	To Ser. No. 252,767; Piston codes RE45323, RE40557; 1-1/8, 1-3/32, 1-.136 (1 cyl. set)

**Power Unit 3029T PowerTech Eng. Wheel Tractor 3029T PowerTech Eng. Track Loader 30**  
**3029T PowerTech Eng.**  
 2.9L 179.2 (2938cc) OHV Turbo-Diesel L3 (PowerTech 2V), 106mm Bore

CYL. HEAD & PARTS				
QTY	GASKETS	PART NO.	SIZE	DESCRIPTION
1	Head Gasket	FP-R97356		Cyl. head codes 5104, 5105, 5106
1	Head Set	FP-RE38850		
QTY	VALVE	PART NO.	SIZE	DESCRIPTION
3	Intake	FP-R98062	STD	1 groove; Chrome plated stem; 1.8350" Head Dia., .3100" Stem Dia., 5.2780" O.A.L.
3	Intake	FP-R97490	15	1 groove; Chrome plated stem; 1.8350" Head Dia., .3250" Stem Dia., 5.2780" O.A.L.
3	Exhaust	FP-R90692	STD	1 groove; Chrome plated stem; 1.6730" Head Dia., .3095" Stem Dia., 5.2550" O.A.L.
3	Exhaust	FP-R97492	15	1 groove; Chrome plated stem; 1.6730" Head Dia., .3245" Stem Dia., 5.2550" O.A.L.
12	Keeper	FP-R91889		Exh. & Int.
QTY	VALVE SPRING	PART NO.	SIZE	DESCRIPTION
6	Spring	FP-R26125		Exh. & Int.; 2.1200" Free Height
QTY	VALVE MISC.	PART NO.	SIZE	DESCRIPTION
6	Rotocap	FP-RE60005		Exh. & Int.
1	Oil Filler Cap Gasket	FP-T20328		Oil filler neck codes 1201, 1202, 1203, 1206
QTY	VALVE SEAL	PART NO.	SIZE	DESCRIPTION
6	Valve Stem Seal	FP-RE31617		Exh. & Int.; Positive type

INT & EXH MANIFOLDS				
QTY	INT. & EXH. MANIFOLDS	PART NO.	SIZE	DESCRIPTION
3	Exhaust Manifold Gasket	FP-R90658		
1	Air Intake Gasket	FP-R81275		

CAMSHAFT GROUP				
QTY	TIMING COVER	PART NO.	SIZE	DESCRIPTION
1	Timing Gear Cover Gasket	FP-R97454		Front cover
1	Timing Gear Cover Gasket	FP-R108654		Use w/R.H. side gear dr. timing gear cover
QTY	CAMSHAFT/LIFTER	PART NO.	SIZE	DESCRIPTION
6	Lifter	FP-T20073		

FUEL SYSTEM & PARTS				
QTY	FUEL INJECTION	PART NO.	SIZE	DESCRIPTION
3	Fuel Injector Nozzle	FP-RE36935		w/Injector marked 28484
3	Fuel Injector Nozzle	FP-RE48786		w/Injector marked 29279
3	Fuel Injector Nut	FP-R79604		w/Injector marked 28484, 29279

(continued on next page)

\* New Item — Check For Availability

<b>30 Power Unit 3029T PowerTech Eng. Wheel Tractor 3029T PowerTech Eng. Track Loader</b> (cont.) <b>3029T PowerTech Eng.</b> 2.9L 179.2 (2938cc) OHV Turbo-Diesel L3 (PowerTech 2V), 106mm Bore				
<b>FUEL SYSTEM &amp; PARTS (cont.)</b>				
<b>QTY</b>	<b>FUEL INJECTION (cont.)</b>	<b>PART NO.</b>	<b>SIZE</b>	<b>DESCRIPTION</b>
3	FI Installation Kit	FP-RE65201		
6	Washer Type Seal	FP-R51936		Leak-off & return line seals; w/Nozzle marked 28480, 28484, 29279
3	Washer Type Seal	FP-R48000		Lower; w/Nozzle marked 28480, 28484
3	Washer Type Seal	FP-R60746		Upper; w/Nozzle marked 28480
<b>COOLING SYSTEM</b>				
<b>QTY</b>	<b>WATER PUMP</b>	<b>PART NO.</b>	<b>SIZE</b>	<b>DESCRIPTION</b>
1	Water Pump Repair/Rebuild Kit	FP-RE62658		Pump codes 2010, 2020, 2022, 2023; w/Pump housing marked R73604
1	Water Pump Housing Gasket	FP-R97455		w/Pump housing marked R73604
1	Water Pump Mounting Gasket	FP-T20243		w/H/D Pump housing marked R100812, R127918
1	Water Pump Mounting Gasket	FP-T20243		w/Pump housing marked R48997, R55164, R73604, R110541
<b>QTY</b>	<b>THERMOSTAT</b>	<b>PART NO.</b>	<b>SIZE</b>	<b>DESCRIPTION</b>
1	Thermostat Cover Gasket	FP-T20215		Thermostat cover codes 2101, 2102
1	Therm. Hsg. - Water Mfld. Gsk	FP-R54641		Thermostat housing to cyl. head; To Ser. No. 205,211
<b>ENGINE BLOCK &amp; PARTS</b>				
<b>QTY</b>	<b>GASKETS</b>	<b>PART NO.</b>	<b>SIZE</b>	<b>DESCRIPTION</b>
1	Oil Pan Gasket	FP-R97341		Exc. Alum. oil pan
1	Oil Pan Gasket Set	FP-PG300PS		Exc. Alum. oil pan; Incl. O-rings
1	Block to End Plate Front Gskt	FP-R131794		Front plate code 3604; R.H. side gear drive
<b>QTY</b>	<b>GASKET SETS</b>	<b>PART NO.</b>	<b>SIZE</b>	<b>DESCRIPTION</b>
1	In-Frame Gasket Set	FP-PG164S		
1	Complete Overhaul Gasket Set	FP-RE50978		Crankshaft seals not incl.
1	Complete Overhaul Gasket Set	FP-RE50978WS		Incl. crankshaft seals
<b>QTY</b>	<b>CAM BEARINGS</b>	<b>PART NO.</b>	<b>SIZE</b>	<b>DESCRIPTION</b>
1	Cam Brg.	FP-R119874		
<b>QTY</b>	<b>OIL COOLERS &amp; FILTERS</b>	<b>PART NO.</b>	<b>SIZE</b>	<b>DESCRIPTION</b>
1	Oil Cooler	FP-RE61767		Cooler codes 5904, 5906, 5908, 5914, 5920
1	Rect. or Square Seal	FP-R70956		Cooler housing w/relief valve; Oil cooler codes 5904, 5906, 5908, 5914, 5916; To Ser. No. 185,223; 2.700" X 3.000" X .180"
<b>CRANKSHAFT/OIL PUMP</b>				
<b>QTY</b>	<b>CRANKSHAFT</b>	<b>PART NO.</b>	<b>SIZE</b>	<b>DESCRIPTION</b>
1	Oil Seal Kit	FP-SK67942		Incl. front & rear seals; Crankshaft codes 4702, 4704, 4705, 4710; From Ser. No. 100,000
<b>QTY</b>	<b>SEALS - FRONT CRANK</b>	<b>PART NO.</b>	<b>SIZE</b>	<b>DESCRIPTION</b>
1	Crankshaft Front Seal	FP-AR67942		
1	O-Ring	FP-H35244		Crankshaft pulley; Pulley codes 1313, 1314, 1329
<b>QTY</b>	<b>SEALS - REAR CRANK</b>	<b>PART NO.</b>	<b>SIZE</b>	<b>DESCRIPTION</b>
1	Crankshaft Rear Seal	FP-RE24959		RePower Eng.s.; Crankshaft codes 4701, 4702, 4710
<b>QTY</b>	<b>MAIN BEARINGS</b>	<b>PART NO.</b>	<b>SIZE</b>	<b>DESCRIPTION</b>
3	Plain Main Brg.	FP-RE27352	STD	w/Flangeless thrust brg.
3	Plain Main Brg.	FP-RE27353	10	w/Flangeless thrust brg.
3	Plain Main Brg.	FP-RE27360	20	w/Flangeless thrust brg.
3	Plain Main Brg.	FP-RE27368	30	w/Flangeless thrust brg.
1	Flanged Main Brg.	FP-RE521350	STD	
1	Flanged Main Brg.	FP-RE526754	10	
1	Flanged Main Brg.	FP-RE527235	20	
1	Flanged Main Brg.	FP-RE527236	30	
4	Thrust Washer	FP-R78598	STD	Use w/Flangeless thrust brg.
<b>QTY</b>	<b>OIL PUMP</b>	<b>PART NO.</b>	<b>SIZE</b>	<b>DESCRIPTION</b>
1	Pump Repair Kit	FP-RE55343		w/Pump housing marked R54615
1	O-Ring	FP-R61871		Oil pump inlet; Pump codes 5001, 5002, 5005, 5007, 5012, 5016
1	O-Ring	FP-R74354		Oil pump outlet tube; Pump codes 5001, 5002, 5005, 5007, 5008, 5009, 5010, 5011, 5012, 5013, 5014, 5015, 5016; w/Pump housing marked R54615
1	Oil Filler Inlet Gasket	FP-R97352		Oil filler neck codes 1201, 1203, 1299
<b>CYLINDER COMPONENTS</b>				
<b>QTY</b>	<b>LINERS</b>	<b>PART NO.</b>	<b>SIZE</b>	<b>DESCRIPTION</b>
3	Liner w/o Sealing Ring	FP-R116281		
3	Liner w/Sealing Rings	FP-RE500023		
3	Cylinder Kit Complete	FP-RE67426 *	STD	From Ser. No. 258847

(continued on next page)



**Power Unit 3029T PowerTech Eng. Wheel Tractor 3029T PowerTech Eng. Track Loader 3029T PowerTech Eng. (cont.)**  
 2.9L 179.2 (2938cc) OHV Turbo-Diesel L3 (PowerTech 2V), 106mm Bore

<b>CYLINDER COMPONENTS (cont.)</b>				
<b>QTY</b>	<b>LINERS (cont.)</b>	<b>PART NO.</b>	<b>SIZE</b>	<b>DESCRIPTION</b>
3	Cylinder Kit Complete	FP-RE48724 *	STD	To Ser. No. 258846
3	Cyl. Liner Sealing Ring Kit	FP-AR65507		
<b>QTY</b>	<b>PISTONS</b>	<b>PART NO.</b>	<b>SIZE</b>	<b>DESCRIPTION</b>
6	Piston Pin Retainer	FP-R54114		For 1.62" pin dia.
<b>QTY</b>	<b>CONNECTING RODS &amp; BRGS.</b>	<b>PART NO.</b>	<b>SIZE</b>	<b>DESCRIPTION</b>
6	Con. Rod Bolt	FP-R80033		w/Con. Rod marked R105011; Torque-To-Yield bolt; Replacement recommended
3	Rod Pair	FP-RE27348	STD	w/Con. Rod marked R105011
3	Rod Pair	FP-RE27349	10	w/Con. Rod marked R105011
3	Rod Pair	FP-RE27358	20	w/Con. Rod marked R105011
3	Rod Pair	FP-RE27364	30	w/Con. Rod marked R105011
<b>QTY</b>	<b>PISTON RINGS</b>	<b>PART NO.</b>	<b>SIZE</b>	<b>DESCRIPTION</b>
3	Ring Set Single Cylinder	FP-RE66271	STD	From Ser. No. 258,847; Piston codes RE61467, RE61270
3	Ring Set Single Cylinder	FP-RE507852	STD	To Ser. No. 258,846; Piston codes RE45323, RE40557; Piston & Liner code 4808; 1-1/8, 1-3/32, 1-.136 (1 cyl. set)
3	Ring Set Single Cylinder	FP-RE66820	STD	To Ser. No. 258,846; Piston codes RE45323, RE40557; Piston & Liner code 4808; 1-1/8, 1-3/32, 1-.136 (1 cyl. set)

**Combine 4180G Eng. Forklift 4180G Eng. Power Unit JD180G, 4180G Engs. Wheel Tractor 4180G Eng. Windrower 4180G Eng. Crawler Tractor 4180G Eng. Loader Tractor 4180G Eng. Skidder 4180G Eng.**  
 2.9L 180 OHV L4, 3.8594" Bore

<b>CYL. HEAD &amp; PARTS</b>				
<b>QTY</b>	<b>GASKETS</b>	<b>PART NO.</b>	<b>SIZE</b>	<b>DESCRIPTION</b>
1	Head Gasket	FP-R98461		
<b>QTY</b>	<b>VALVE</b>	<b>PART NO.</b>	<b>SIZE</b>	<b>DESCRIPTION</b>
16	Keeper	FP-41339		1 groove; Square cut key groove
16	Keeper	FP-T20077		1 groove; Square cut key groove; Hardened
16	Keeper, Bulk	VK-138B		1 groove; Square cut key groove; Carton of 1000
<b>QTY</b>	<b>VALVE SPRING</b>	<b>PART NO.</b>	<b>SIZE</b>	<b>DESCRIPTION</b>
8	Spring	FP-R26125		2.1200" Free Height
<b>QTY</b>	<b>VALVE MISC.</b>	<b>PART NO.</b>	<b>SIZE</b>	<b>DESCRIPTION</b>
1	Oil Filler Cap Gasket	FP-T20328		
<b>QTY</b>	<b>VALVE SEAL</b>	<b>PART NO.</b>	<b>SIZE</b>	<b>DESCRIPTION</b>
4	Valve Stem Seal	FP-R87627		Exh.; O-Ring type
<b>QTY</b>	<b>ROCKER PARTS</b>	<b>PART NO.</b>	<b>SIZE</b>	<b>DESCRIPTION</b>
1	O-Ring	FP-R56463		Rocker cover breather tube
<b>ELECTRICAL</b>				
<b>QTY</b>	<b>ALTERNATOR</b>	<b>PART NO.</b>	<b>SIZE</b>	<b>DESCRIPTION</b>
1	Ball Brg.	FP-JD9449		Front; Motorola No. A12NJD453; To Ser. No. 98,605
1	Ball Brg.	FP-JD9449		Front; Motorola No. A12NJD604; From Ser. No. 98,606
1	Ball Brg.	FP-JD9449		Front; Motorola Nos. TA12NJD400, 8TA2009ES
2	Ball Brg.	FP-JD9449		Front & Rear; 65 amp alternator
<b>CAMSHAFT GROUP</b>				
<b>QTY</b>	<b>CAMSHAFT/LIFTER</b>	<b>PART NO.</b>	<b>SIZE</b>	<b>DESCRIPTION</b>
8	Lifter	FP-T20073		
<b>COOLING SYSTEM</b>				
<b>QTY</b>	<b>WATER PUMP</b>	<b>PART NO.</b>	<b>SIZE</b>	<b>DESCRIPTION</b>
1	Water Pump Impeller	FP-R40979		w/Pump housing marked R56787, R62902
1	Water Pump Impeller	FP-R94419		From Ser. No. 131,252
1	Water Pump Repair/Rebuild Kit	FP-925740979		w/Pump housing marked R56787, R62902
1	Shaft & Bearing Assembly	FP-JD9257		
<b>QTY</b>	<b>THERMOSTAT</b>	<b>PART NO.</b>	<b>SIZE</b>	<b>DESCRIPTION</b>
1	Thermostat	FP-RE33705		180 Deg.
1	Thermostat Cover Gasket	FP-T20215		
<b>QTY</b>	<b>MISCELLANEOUS</b>	<b>PART NO.</b>	<b>SIZE</b>	<b>DESCRIPTION</b>
3	Water Manifold Gasket	FP-T23002		

(continued on next page)

**31** Combine 4180G Eng. Forklift 4180G Eng. Power Unit JD180G, 4180G Engs. Wheel Tractor (cont.) 4180G Eng. Windrower 4180G Eng. Crawler Tractor 4180G Eng. Loader Tractor 4180G Eng. Skidder 4180G Eng.  
2.9L 180 OHV L4, 3.8594" Bore

ENGINE BLOCK & PARTS				
QTY	GASKETS	PART NO.	SIZE	DESCRIPTION
1	Flywheel Housing Gasket	FP-R97351		
1	Oil Pan Gasket	FP-R119360		w/Block marked R72973; w/Cast iron oil pan
1	Block to End Plate Front Gskt	FP-R131794		
QTY	GASKET SETS	PART NO.	SIZE	DESCRIPTION
1	Gasket Conversion Set	FP-PG219CS		Rubber one-piece rear main brg. seal incl.; 5.756" seal OD; Wear sleeve incl.
1	Kit Gasket Set	FP-2601386		Compl.; Rear main brg. seal incl.; Wear sleeve incl.
1	Kit Gasket Set	260-1386		Compl.; Rear main brg. seal incl.; Wear sleeve incl.
QTY	ENGINE BEARING MISC.	PART NO.	SIZE	DESCRIPTION
1	Bal. Shaft Set	FP-R57160S		
CRANKSHAFT/OIL PUMP				
QTY	CRANKSHAFT	PART NO.	SIZE	DESCRIPTION
1	Oil Seal Kit	FP-SK67942		Incl. front & rear seals
QTY	SEALS - FRONT CRANK	PART NO.	SIZE	DESCRIPTION
1	Crankshaft Front Seal	FP-AR67942		
QTY	SEALS - REAR CRANK	PART NO.	SIZE	DESCRIPTION
1	Crankshaft Rear Seal	FP-RE24959		
QTY	MAIN BEARINGS	PART NO.	SIZE	DESCRIPTION
1	Main Set	FP-MBK3002	STD	
1	Main Set	FP-MBK300210	10	
1	Main Set	FP-MBK300220	20	
1	Main Set	FP-MBK300230	30	
QTY	OIL PUMP	PART NO.	SIZE	DESCRIPTION
1	O-Ring	FP-R61871		Oil pump inlet; From Ser. No. 240,554
1	O-Ring	FP-R74354		Oil pump outlet tube; w/Pump housing marked R54615, T20078
CYLINDER COMPONENTS				
QTY	LINERS	PART NO.	SIZE	DESCRIPTION
4	Sleeve Assy.	FP-SL2689		Early Model JD400; Early Model JD450; Early Model JD480; Model JD440 To Ser. No. 49,999; Three O-rings used; Two grooves on sleeve; Contains piston to replace O.E. No. T23504T
4	Sleeve Assy.	FP-SL2688		Model 2020 From Ser. No. 159,927; Model 2510 w/Block marked T32349; Model JD180G; Late Models JD400, JD450, JD480; Three O-rings used; No grooves on sleeve; Contains piston to replace O.E. No. T23504T
4	Sleeve Assy.	FP-SL2689		Model 2020 To Ser. No. 159,926; Three O-rings used; Two grooves on sleeve; Contains piston to replace O.E. No. T23504T
4	Sleeve Assy.	FP-SL2689		Model 2510 w/Block marked T23405, T24960, T26932; Three O-rings used; Two grooves on sleeve; Contains piston to replace O.E. No. T23504T
QTY	PISTONS	PART NO.	SIZE	DESCRIPTION
4	Pin Bushing	FP-2599Y20		
QTY	CONNECTING RODS & BRGS.	PART NO.	SIZE	DESCRIPTION
4	Rod Pair	FP-2595A	STD	A-Series aluminum bearings
4	Rod Pair	FP-2595A10	10	A-Series aluminum bearings
4	Rod Pair	FP-2595A20	20	A-Series aluminum bearings
4	Rod Pair	FP-2595A30	30	A-Series aluminum bearings
QTY	PISTON RINGS	PART NO.	SIZE	DESCRIPTION
4	Ring Set Single Cylinder	FP-AR70633	STD	2-3/32, 1-.196 (1 cyl. set)
KITS				
QTY	OVERHAUL KIT	PART NO.	SIZE	DESCRIPTION
1	Complete Overhaul Kit	FP-180GEOHK		Model JD440 To Ser. No. 49,999
1	Complete Overhaul Kit	FP-180GLOHK		Model 2020 From Ser. No. 159,927; Model 2510 w/Block marked T32349; Model JD180G; Late Model JD400, JD450, JD480
1	Complete Overhaul Kit	FP-180GEOHK		Model 2020 To Ser. No. 159,926
1	Complete Overhaul Kit	FP-180GEOHK		Model 2510 w/Block marked T23405, T24960, T26932; Early Model JD400; Early Model JD450; Early Model JD480



# John Deere Off Highway

<i>Crawler Tractor 4180D Eng. 32</i> 2.9L 180 OHV Diesel L4, 3.8594" Bore				
<b>CYL. HEAD &amp; PARTS</b>				
QTY	GASKETS	PART NO.	SIZE	DESCRIPTION
1	Valve Cover Gasket	FP-T20075		
<b>INT &amp; EXH MANIFOLDS</b>				
QTY	INT. & EXH. MANIFOLDS	PART NO.	SIZE	DESCRIPTION
1	Air Intake Gasket	FP-R81275		
<b>FUEL SYSTEM &amp; PARTS</b>				
QTY	FUEL INJECTION	PART NO.	SIZE	DESCRIPTION
3	Washer Type Seal	FP-R48000		Lower; w/Nozzle marked 22202
<b>COOLING SYSTEM</b>				
QTY	WATER PUMP	PART NO.	SIZE	DESCRIPTION
1	Water Pump Impeller	FP-R47191		w/Pump housing marked R66420, R68733
1	Water Pump Repair/Rebuild Kit	FP-RE62661		w/Pump housing marked R66420, R68733
1	Water Intake Gasket	FP-T23132		
<b>ENGINE BLOCK &amp; PARTS</b>				
QTY	GASKET SETS	PART NO.	SIZE	DESCRIPTION
1	Gasket Conversion Set	FP-PG219CS		Rubber one-piece rear main brg. seal incl.; 5.756" seal OD; Wear sleeve incl.
<i>Combine JX4C3 Eng. 33</i> 3.1L 188 L-HEAD L4, 3.75" Bore (Hercules Eng.)				
<b>CYL. HEAD &amp; PARTS</b>				
QTY	VALVE GUIDE	PART NO.	SIZE	DESCRIPTION
8	Guide	FP-VG414		.3745" ID, 2.3600" O.A.L.
<b>ENGINE BLOCK &amp; PARTS</b>				
QTY	CAM BEARINGS	PART NO.	SIZE	DESCRIPTION
1	Cam Set	FP-1090M		
<b>CYLINDER COMPONENTS</b>				
QTY	PISTONS	PART NO.	SIZE	DESCRIPTION
4	Pin Bushing	FP-1424X		Drilled rod type bushing
QTY	CONNECTING RODS & BRGS.	PART NO.	SIZE	DESCRIPTION
4	Rod Pair	FP-1420CP	STD	w/1.9870-1.9880" std. shaft size
4	Rod Pair	FP-1420CP10	10	w/1.9870-1.9880" std. shaft size
4	Rod Pair	FP-1420CP40	40	w/1.9870-1.9880" std. shaft size
<i>Wheel Tractor B, 50, 520, 530 Eng. 34</i> 3.1L 190 OHV L2, 4.6875" Bore				
<b>CYL. HEAD &amp; PARTS</b>				
QTY	GASKETS	PART NO.	SIZE	DESCRIPTION
1	Head Set	FP-PG175HS		Model 50; From Ser. No. 5000001 to 5015950
1	Head Set	FP-PG175HS		Models B, BN, BW; From Ser. No. 96000
QTY	VALVE	PART NO.	SIZE	DESCRIPTION
8	Keeper	FP-B367R		2 groove
8	Keeper	VK-66R		2 groove; Hardened
<b>ENGINE BLOCK &amp; PARTS</b>				
QTY	GASKET SETS	PART NO.	SIZE	DESCRIPTION
1	Complete Overhaul Gasket Set	FP-PG175FS		Model 50; From Ser. No. 5000001 to 5015950
1	Complete Overhaul Gasket Set	FP-PG175FS		Models B, BN, BW; From Ser. No. 96000
<b>CYLINDER COMPONENTS</b>				
QTY	PISTONS	PART NO.	SIZE	DESCRIPTION
2	Piston Kit w/Pin & Retainers	FP-A1239P	STD	Models B, BN, BW; From Ser. No. 201,000
2	Piston Kit w/Pin & Retainers	FP-A1239P45	45	Models B, BN, BW; From Ser. No. 201,000
2	Piston Kit w/Pin & Retainers	FP-A1239P90	90	Models B, BN, BW; From Ser. No. 201,000
2	Piston Kit w/Pin & Retainers	FP-A1239P125	125	Models B, BN, BW; From Ser. No. 201,000
2	Piston Kit w/Pin & Retainers	FP-A1239P	STD	50 Series Eng.
2	Piston Kit w/Pin & Retainers	FP-A1239P45	45	50 Series Eng.
2	Piston Kit w/Pin & Retainers	FP-A1239P90	90	50 Series Eng.
2	Piston Kit w/Pin & Retainers	FP-A1239P125	125	50 Series Eng.
2	Piston Kit w/Pin & Retainers	FP-A1278P	STD	520, 530 Series Eng.

(continued on next page)

## 34 Wheel Tractor B, 50, 520, 530 Engs. (cont.) 3.1L 190 OHV L2, 4.6875" Bore

### CYLINDER COMPONENTS (cont.)

QTY	PISTONS (cont.)	PART NO.	SIZE	DESCRIPTION
2	Piston Kit w/Pin & Retainers	FP-A1278P45	45	520, 530 Series Engs.
2	Piston Kit w/Pin & Retainers	FP-A1278P90	90	520, 530 Series Engs.
2	Piston Kit w/Pin & Retainers	FP-A1278P125	125	520, 530 Series Engs.
2	Pin Bushing	FP-9759		w/1.750" ID, 1.895" OD, 2.500" O.A.L.
2	Pin Bushing	9759 +		w/1.750" ID, 1.895" OD, 2.500" O.A.L.; When depleted use FP-9759
QTY	CONNECTING RODS & BRGS.	PART NO.	SIZE	DESCRIPTION
2	Rod Pair	FP-2180CP	STD	w/Insert type brgs.
2	Rod Pair	FP-2180CP10	10	w/Insert type brgs.
2	Rod Pair	FP-2180CP20	20	w/Insert type brgs.
2	Rod Pair	FP-2755CP	STD	520, 530 Series Engs.

## 35 Wheel Tractor 50, 520 Engs. (Distillate) 3.1L 190 OHV Distillate L2, 4.6875" Bore

### CYL. HEAD & PARTS

QTY	GASKETS	PART NO.	SIZE	DESCRIPTION
1	Head Set	FP-PG175HS		Model 50; From Ser. No. 5000001 to 5015950
1	Head Set	FP-PG175HS		Models B, BN, BW; From Ser. No. 96000
QTY	VALVE	PART NO.	SIZE	DESCRIPTION
8	Keeper	FP-B367R		2 groove
8	Keeper	VK-66R		2 groove; Hardened

### ENGINE BLOCK & PARTS

QTY	GASKET SETS	PART NO.	SIZE	DESCRIPTION
1	Complete Overhaul Gasket Set	FP-PG175FS		Model 50; From Ser. No. 5000001 to 5015950
1	Complete Overhaul Gasket Set	FP-PG175FS		Models B, BN, BW; From Ser. No. 96000

### CYLINDER COMPONENTS

QTY	PISTONS	PART NO.	SIZE	DESCRIPTION
2	Piston Kit w/Pin & Retainers	FP-A1239P	STD	Models B, BN, BW; From Ser. No. 201,000
2	Piston Kit w/Pin & Retainers	FP-A1239P45	45	Models B, BN, BW; From Ser. No. 201,000
2	Piston Kit w/Pin & Retainers	FP-A1239P90	90	Models B, BN, BW; From Ser. No. 201,000
2	Piston Kit w/Pin & Retainers	FP-A1239P125	125	Models B, BN, BW; From Ser. No. 201,000
2	Piston Kit w/Pin & Retainers	FP-A1239P	STD	50 Series Engs.
2	Piston Kit w/Pin & Retainers	FP-A1239P45	45	50 Series Engs.
2	Piston Kit w/Pin & Retainers	FP-A1239P90	90	50 Series Engs.
2	Piston Kit w/Pin & Retainers	FP-A1239P125	125	50 Series Engs.
2	Piston Kit w/Pin & Retainers	FP-A1278P	STD	520, 530 Series Engs.
2	Piston Kit w/Pin & Retainers	FP-A1278P45	45	520, 530 Series Engs.
2	Piston Kit w/Pin & Retainers	FP-A1278P90	90	520, 530 Series Engs.
2	Piston Kit w/Pin & Retainers	FP-A1278P125	125	520, 530 Series Engs.
2	Pin Bushing	FP-9759		w/1.750" ID, 1.895" OD, 2.500" O.A.L.
2	Pin Bushing	9759 +		w/1.750" ID, 1.895" OD, 2.500" O.A.L.; When depleted use FP-9759
QTY	CONNECTING RODS & BRGS.	PART NO.	SIZE	DESCRIPTION
2	Rod Pair	FP-2180CP	STD	w/Insert type brgs.
2	Rod Pair	FP-2180CP10	10	w/Insert type brgs.
2	Rod Pair	FP-2180CP20	20	w/Insert type brgs.
2	Rod Pair	FP-2755CP	STD	520, 530 Series Engs.

## 36 Loader 201G Eng. Wheel Tractor 201G Eng. 3.3L 201 OHV L4, 4" Bore

### CYL. HEAD & PARTS

QTY	VALVE	PART NO.	SIZE	DESCRIPTION
4	Intake	FP-V1635		1.6880" Head Dia., .3720" Stem Dia., 5.7000" O.A.L.
4	Exhaust	FP-V1634		1.5000" Head Dia., .3720" Stem Dia., 5.7310" O.A.L.
16	Keeper	FP-B367R		2 groove
16	Keeper	VK-66R		2 groove; Hardened
QTY	VALVE SEAT	PART NO.	SIZE	DESCRIPTION
4	Int.	FP-R78702	STD	1.7550" OD, 1.5000" ID, .2160" Depth
QTY	VALVE GUIDE	PART NO.	SIZE	DESCRIPTION
8	Guide	FP-VG606		.3750" ID, 2.9400" O.A.L.

(continued on next page)





# John Deere Off Highway

Loader 201G Eng. Wheel Tractor 201G Eng. **36**  
3.3L 201 OHV L4, 4" Bore (cont.)

ENGINE BLOCK & PARTS				
QTY	CAM BEARINGS	PART NO.	SIZE	DESCRIPTION
1	Cam Set	FP-3R46903	STD	
3	Cam Brg.	FP-R46903	STD	
CRANKSHAFT/OIL PUMP				
QTY	SEALS - FRONT CRANK	PART NO.	SIZE	DESCRIPTION
1	Oil Seal Kit	FP-AR49025		
QTY	SEALS - REAR CRANK	PART NO.	SIZE	DESCRIPTION
1	Oil Seal	FP-RE22764		PTFE
QTY	MAIN BEARINGS	PART NO.	SIZE	DESCRIPTION
1	Main Set	FP-MBK3001	STD	w/Flange brg.; w/Block marked R26150, R26160
1	Main Set	FP-MBK300110	10	w/Flange brg.; w/Block marked R26150, R26160
1	Main Set	FP-MBK300120	20	w/Flange brg.; w/Block marked R26150, R26160
1	Main Set	FP-MBK300130	30	w/Flange brg.; w/Block marked R26150, R26160
1	Main Set	FP-MBK300	STD	w/Thrust washer; Use in blocks marked R40910, R40920, R46350, R46340, R49540
1	Main Set	FP-MBK30010	10	w/Thrust washer; Use in blocks marked R40910, R40920, R46350, R46340, R49540
1	Main Set	FP-MBK30020	20	w/Thrust washer; Use in blocks marked R40910, R40920, R46350, R46340, R49540
1	Main Set	FP-MBK30030	30	w/Thrust washer; Use in blocks marked R40910, R40920, R46350, R46340, R49540
CYLINDER COMPONENTS				
QTY	LINERS	PART NO.	SIZE	DESCRIPTION
4	Sleeve Assy.	FP-SL2084		Contains piston to replace O.E. No. R26089R; O-rings in block
QTY	PISTONS	PART NO.	SIZE	DESCRIPTION
4	Pin Bushing	FP-3129YA20		1.252" ID, 1.3785" OD, 1.510" O.A.L.
QTY	CONNECTING RODS & BRGS.	PART NO.	SIZE	DESCRIPTION
4	Rod Pair	FP-AR45723	STD	
4	Rod Pair	FP-AR46396	10	
4	Rod Pair	FP-AR46397	20	
4	Rod Pair	FP-AR46398	30	
QTY	PISTON RINGS	PART NO.	SIZE	DESCRIPTION
2	Premium Set	FP-5834KX	STD	3-3/32, 2-1/4 (2 cyl. set)
4	Premium Single Cylinder Set	W-5834KX Std Only		3-3/32, 2-1/4 (1 cyl. set)
KITS				
QTY	OVERHAUL KIT	PART NO.	SIZE	DESCRIPTION
1	Tractor Overhaul Kit	FP-KST2084A		w/Block marked R26150, R26160; Model 3010; w/Flange brg.
<p>Combine 4202G Eng. Power Unit JD202G, 4202G Engs. Wheel Tractor 4202G Eng. Crawler <b>37</b> Tractor 4202G Eng. Loader Tractor 4202G Eng. 3.3L 202 OHV L4, 3.8594" Bore</p>				
CYL. HEAD & PARTS				
QTY	VALVE	PART NO.	SIZE	DESCRIPTION
16	Keeper	FP-41339		1 groove; Square cut key groove
16	Keeper	FP-T20077		1 groove; Square cut key groove; Hardened
16	Keeper, Bulk	VK-138B		1 groove; Square cut key groove; Carton of 1000
QTY	VALVE SPRING	PART NO.	SIZE	DESCRIPTION
8	Spring	FP-R26125		2.1200" Free Height
QTY	VALVE SEAL	PART NO.	SIZE	DESCRIPTION
4	Valve Stem Seal	FP-R87627		Exh.; O-Ring type
QTY	ROCKER PARTS	PART NO.	SIZE	DESCRIPTION
1	O-Ring	FP-R56463		Rocker cover breather tube
CAMSHAFT GROUP				
QTY	CAMSHAFT/LIFTER	PART NO.	SIZE	DESCRIPTION
8	Lifter	FP-T20073		
COOLING SYSTEM				
QTY	WATER PUMP	PART NO.	SIZE	DESCRIPTION
1	Water Pump Repair/Rebuild Kit	FP-925740979		w/Pump housing marked R56787, R62902
1	Water Pump Housing Gasket	FP-R97455		w/Pump housing marked R48992

(continued on next page)

**37** Combine 4202G Eng. Power Unit JD202G, 4202G Engs. Wheel Tractor 4202G Eng. Crawler (cont.) Tractor 4202G Eng. Loader Tractor 4202G Eng. 3.3L 202 OHV L4, 3.8594" Bore

### COOLING SYSTEM (cont.)

QTY	WATER PUMP (cont.)	PART NO.	SIZE	DESCRIPTION
1	Shaft & Bearing Assembly	FP-JD9257		w/Pump housing marked R48992, R55758
QTY	THERMOSTAT	PART NO.	SIZE	DESCRIPTION
1	Thermostat Cover Gasket	FP-T20215		

### ENGINE BLOCK & PARTS

QTY	GASKETS	PART NO.	SIZE	DESCRIPTION
1	Oil Pan Gasket	FP-R119360		w/Block marked R72973; w/Cast iron oil pan
QTY	GASKET SETS	PART NO.	SIZE	DESCRIPTION
1	Gasket Conversion Set	FP-PG219CS		Rubber one-piece rear main brg. seal incl.; 5.756" seal OD; Wear sleeve incl.
1	Kit Gasket Set	FP-2601386		Compl.; Rear main brg. seal incl.; Wear sleeve incl.
1	Kit Gasket Set	260-1386		Compl.; Rear main brg. seal incl.; Wear sleeve incl.
QTY	ENGINE BEARING MISC.	PART NO.	SIZE	DESCRIPTION
1	Bal. Shaft Set	FP-R57160S		

### CRANKSHAFT/OIL PUMP

QTY	CRANKSHAFT	PART NO.	SIZE	DESCRIPTION
1	Oil Seal Kit	FP-SK67942		Incl. front & rear seals
QTY	SEALS - FRONT CRANK	PART NO.	SIZE	DESCRIPTION
1	Crankshaft Front Seal	FP-AR67942		
QTY	SEALS - REAR CRANK	PART NO.	SIZE	DESCRIPTION
1	Crankshaft Rear Seal	FP-RE24959		
QTY	MAIN BEARINGS	PART NO.	SIZE	DESCRIPTION
1	Main Set	FP-MBK3002	STD	
1	Main Set	FP-MBK300210	10	
1	Main Set	FP-MBK300220	20	
1	Main Set	FP-MBK300230	30	
QTY	OIL PUMP	PART NO.	SIZE	DESCRIPTION
1	O-Ring	FP-R61871		Oil pump inlet; From Ser. No. 240,554

### CYLINDER COMPONENTS

QTY	LINERS	PART NO.	SIZE	DESCRIPTION
4	Liner w/Sealing Rings	FP-T32340WS	STD	Model 2520 From Ser. No. 157,354
4	Liner w/Sealing Rings	FP-AR51902	STD	Model 2520 To Ser. No.157,353
4	Liner w/Sealing Rings	FP-T32340WS	STD	Model 3300 To Ser. No. 218,730
4	Liner w/Sealing Rings	FP-T32340WS	STD	Models JD202G, JD410 To Ser. No. 192,001
QTY	CONNECTING RODS & BRGS.	PART NO.	SIZE	DESCRIPTION
4	Rod Pair	FP-2595A	STD	A-Series aluminum bearings
4	Rod Pair	FP-2595A10	10	A-Series aluminum bearings
4	Rod Pair	FP-2595A20	20	A-Series aluminum bearings
4	Rod Pair	FP-2595A30	30	A-Series aluminum bearings
QTY	PISTON RINGS	PART NO.	SIZE	DESCRIPTION
4	Ring Set Single Cylinder	FP-AR70633	STD	2-3/32, 1-.196 (1 cyl. set)

**38** Forklift 4202D Eng. Loader 4202D Eng. Power Unit JD202D, 4202D Engs. Wheel Tractor 4202D Eng. Windrower 4202D Eng. Crawler Tractor 4202D Eng. Loader Tractor 4202D Eng. Skidder 4202D Eng. Dozer 4202D Eng. Backhoe 4202D Eng. 3.3L 202 OHV Diesel L4, 3.8594" Bore

### CYL. HEAD & PARTS

QTY	GASKETS	PART NO.	SIZE	DESCRIPTION
1	Head Gasket	FP-R98461		
1	Head Set	FP-RE38847		
QTY	VALVE	PART NO.	SIZE	DESCRIPTION
4	Intake	FP-R79623	STD	2 groove; Chrome plated stem; 1.7720" Head Dia., .3720" Stem Dia., 5.1560" O.A.L.
4	Intake	FP-R79628	3	2 groove; Chrome plated stem; 1.7720" Head Dia., .3750" Stem Dia., 5.1560" O.A.L.
4	Intake	FP-R79629	15	2 groove; Chrome plated stem; 1.7720" Head Dia., .3870" Stem Dia., 5.1560" O.A.L.
4	Intake	FP-R79630	30	2 groove; Chrome plated stem; 1.7720" Head Dia., .4020" Stem Dia., 5.1560" O.A.L.

(continued on next page)



# John Deere Off Highway

Forklift 4202D Eng. Loader 4202D Eng. Power Unit JD202D, 4202D Engs. Wheel Tractor 38  
 4202D Eng. Windrower 4202D Eng. Crawler Tractor 4202D Eng. Loader Tractor 4202D Eng. (cont.)  
 Skidder 4202D Eng. Dozer 4202D Eng. Backhoe 4202D Eng.  
 3.3L 202 OHV Diesel L4, 3.8594" Bore

## CYL. HEAD & PARTS (cont.)

QTY	VALVE (cont.)	PART NO.	SIZE	DESCRIPTION
4	Exhaust	FP-R79624	STD	1 groove; Chrome plated stem; 1.5750" Head Dia., .3720" Stem Dia., 5.1560" O.A.L.
4	Exhaust	FP-R79625	3	1 groove; Chrome plated stem; 1.5750" Head Dia., .3750" Stem Dia., 5.1560" O.A.L.
4	Exhaust	FP-R79626	15	1 groove; Chrome plated stem; 1.5750" Head Dia., .3870" Stem Dia., 5.1560" O.A.L.
4	Exhaust	FP-R79627	30	1 groove; Chrome plated stem; 1.5750" Head Dia., .4020" Stem Dia., 5.1560" O.A.L.
16	Keeper	FP-41339		1 groove; Square cut key groove
16	Keeper	FP-T20077		1 groove; Square cut key groove; Hardened
16	Keeper, Bulk	VK-138B		1 groove; Square cut key groove; Carton of 1000
QTY	VALVE SEAT	PART NO.	SIZE	DESCRIPTION
4	Exh.	FP-R51734	STD	
4	Int.	FP-R73064	STD	
QTY	VALVE SPRING	PART NO.	SIZE	DESCRIPTION
8	Spring	FP-R26125		2.1200" Free Height
QTY	VALVE MISC.	PART NO.	SIZE	DESCRIPTION
4	Rotocap	FP-RE11410		Exh. & Int.
1	Bushing	FP-T26321		Lower
1	Bushing	FP-T20034		Upper
QTY	VALVE SEAL	PART NO.	SIZE	DESCRIPTION
8	Valve Stem Seal	FP-R87627		O-Ring type
QTY	ROCKER PARTS	PART NO.	SIZE	DESCRIPTION
1	O-Ring	FP-R56463		Rocker cover breather tube
ELECTRICAL				
QTY	ALTERNATOR	PART NO.	SIZE	DESCRIPTION
1	Ball Brg.	FP-JD9449		Front; Motorola No. A12NJD453; To Ser. No. 98,605
1	Ball Brg.	FP-JD9449		Front; Motorola No. A12NJD604; From Ser. No. 98,606
2	Ball Brg.	FP-JD9449		Front & Rear; 65 amp alternator
INT & EXH MANIFOLDS				
QTY	INT. & EXH. MANIFOLDS	PART NO.	SIZE	DESCRIPTION
4	Exhaust Manifold Gasket	FP-R90658		
1	Air Intake Gasket	FP-R81275		
CAMSHAFT GROUP				
QTY	TIMING COVER	PART NO.	SIZE	DESCRIPTION
1	Timing Gear Cover Gasket	FP-T20273		Access cover
1	Timing Gear Cover Gasket	FP-R97454		Front cover
QTY	CAMSHAFT/LIFTER	PART NO.	SIZE	DESCRIPTION
8	Lifter	FP-T20073		
FUEL SYSTEM & PARTS				
QTY	FUEL INJECTION	PART NO.	SIZE	DESCRIPTION
4	Fuel Injector Nozzle	FP-AR89564		
1	Clamp	FP-R34766		To Ser. No. 106,891
4	Washer Type Seal	FP-R48000		Lower; w/Nozzle marked 16422, 17574, 17579, 18457, 19762, 22002
4	Washer Type Seal	FP-R60746		Upper; w/Nozzle marked 19762, 22202
QTY	FUEL FILTERS & PUMP	PART NO.	SIZE	DESCRIPTION
1	Mechanical Fuel Pump	FP-RE42211		Transfer pump
1	Fuel Transfer Pump Gasket	FP-R97350		
COOLING SYSTEM				
QTY	WATER PUMP	PART NO.	SIZE	DESCRIPTION
1	Water Pump Repair/Rebuild Kit	FP-925740979		w/Pump housing marked R56787, R62902
1	Water Pump Repair/Rebuild Kit	FP-RE62661		w/Pump housing marked R66420, R68733
1	Water Pump Housing Gasket	FP-R97455		w/Pump housing marked R48992, R51039
QTY	THERMOSTAT	PART NO.	SIZE	DESCRIPTION
1	Thermostat	FP-RE33705		180 Deg.
1	Thermostat Gasket	FP-T20219		Thermostat housing marked R60256

(continued on next page)

**38** *Forklift 4202D Eng. Loader 4202D Eng. Power Unit JD202D, 4202D Engs. Wheel Tractor (cont.) 4202D Eng. Windrower 4202D Eng. Crawler Tractor 4202D Eng. Loader Tractor 4202D Eng. Skidder 4202D Eng. Dozer 4202D Eng. Backhoe 4202D Eng. 3.3L 202 OHV Diesel L4, 3.8594" Bore*

ENGINE BLOCK & PARTS				
QTY	GASKETS	PART NO.	SIZE	DESCRIPTION
1	Flywheel Housing Gasket	FP-R97351		
1	Oil Pan Gasket	FP-R119360		w/Block marked R72973; w/Cast iron oil pan
1	Oil Pan Gasket	FP-R97342		w/Stamped Steel Pan
1	Block to End Plate Front Gskt	FP-R131794		
QTY	GASKET SETS	PART NO.	SIZE	DESCRIPTION
1	Gasket Conversion Set	FP-PG219CS		Rubber one-piece rear main brg. seal incl.; 5.756" seal OD; Wear sleeve incl.
1	In-Frame Gasket Set	FP-PG202S		
1	Complete Overhaul Gasket Set	FP-RE38558		Crankshaft seals not incl.
1	Complete Overhaul Gasket Set	FP-RE38558WS		Incl. crankshaft seals
QTY	ENGINE BEARING MISC.	PART NO.	SIZE	DESCRIPTION
1	Bal. Shaft Set	FP-R57160S		
6	Balance Shaft Bearing	FP-R57160		
CRANKSHAFT/OIL PUMP				
QTY	CRANKSHAFT	PART NO.	SIZE	DESCRIPTION
1	Crankshaft	FP-AT18030		
1	Oil Seal Kit	FP-SK67942		Incl. front & rear seals
QTY	SEALS - FRONT CRANK	PART NO.	SIZE	DESCRIPTION
1	Crankshaft Front Seal	FP-AR67942		
QTY	SEALS - REAR CRANK	PART NO.	SIZE	DESCRIPTION
1	Oil Seal Kit	FP-SK67942		Incl. front & rear seals
1	Crankshaft Rear Seal	FP-RE24959		
QTY	MAIN BEARINGS	PART NO.	SIZE	DESCRIPTION
1	Main Set	FP-MBK3004	STD	w/Flanged thrust brg.
1	Main Set	FP-MBK300410	10	w/Flanged thrust brg.
1	Main Set	FP-MBK300420	20	w/Flanged thrust brg.
1	Main Set	FP-MBK300430	30	w/Flanged thrust brg.
4	Plain Main Brg.	FP-RE27352	STD	w/Flangeless thrust brg.
4	Plain Main Brg.	FP-RE27353	10	w/Flangeless thrust brg.
4	Plain Main Brg.	FP-RE27360	20	w/Flangeless thrust brg.
4	Plain Main Brg.	FP-RE27368	30	w/Flangeless thrust brg.
1	Flanged Main Brg.	FP-RE521350	STD	
1	Flanged Main Brg.	FP-RE526754	10	
1	Flanged Main Brg.	FP-RE527235	20	
1	Flanged Main Brg.	FP-RE527236	30	
4	Thrust Washer	FP-R78598	STD	
QTY	OIL PUMP	PART NO.	SIZE	DESCRIPTION
1	O-Ring	FP-R74354		Oil pump outlet tube; w/Pump housing marked R54615, T20078
CYLINDER COMPONENTS				
QTY	LINERS	PART NO.	SIZE	DESCRIPTION
4	Liner w/o Sealing Ring	FP-T32340	STD	From Ser. No. 158,258; O-Rings in block
4	Liner w/o Sealing Ring	FP-R48635	STD	To Ser. No. 158,257; O-Rings on liner
4	Liner w/Sealing Rings	FP-T32340WS	STD	From Ser. No. 158,258
4	Liner w/Sealing Rings	FP-AR51902	STD	To Ser. No. 158,257
4	Cylinder Kit Complete	FP-AR71591		w/Con. Rod marked T20007, R81410; From Ser. No. 158,258; Contains FP-T32340-WS liner; O-rings in block
4	Cylinder Kit Complete	FP-CK34818635	STD	w/Con. Rod marked T20007, R81410; To Ser. No. 158,257; Contains FP-AR51902 liner; O-rings on liner
4	Cyl. Liner Sealing Ring Kit	FP-AR71617		From Ser. No. 158,258
4	Sealing Ring, Liner	FP-R48767		From Ser. No. 158,258; Rectangle; Top
4	Sealing Ring, Liner	FP-R48637		To Ser. No. 158,257; Rectangle; Top & Bottom
4	Sealing Ring, Liner	FP-R48638		To Ser. No. 158,257; Round
4	Sealing Ring	FP-SLR2497		From Ser. No. 158,258; Round; Bottom; In block
QTY	PISTONS	PART NO.	SIZE	DESCRIPTION
4	Piston Body w/o Pin	FP-T23481		
4	Piston Kit w/Pin & Retainers	FP-T23481WP		
4	Pin	FP-T23482		
8	Piston Pin Retainer	FP-R51112		
4	Pin Bushing	FP-T23471		w/Con. Rod marked R81410, T20007; 1.1896" ID, 1.313" OD, 1.570" O.A.L.

(continued on next page)



# John Deere Off Highway

Forklift 4202D Eng. Loader 4202D Eng. Power Unit JD202D, 4202D Engs. Wheel Tractor 38  
 4202D Eng. Windrower 4202D Eng. Crawler Tractor 4202D Eng. Loader Tractor 4202D Eng. (cont.)  
 Skidder 4202D Eng. Dozer 4202D Eng. Backhoe 4202D Eng.  
 3.3L 202 OHV Diesel L4, 3.8594" Bore

## CYLINDER COMPONENTS (cont.)

QTY	CONNECTING RODS & BRGS.	PART NO.	SIZE	DESCRIPTION
8	Con. Rod Bolt	FP-R80033		w/Con. Rod marked R80032, R80034, R81410, R105011, R113612; Torque-To-Yield bolt; Replacement recommended
8	Con. Rod Bolt	FP-R74194		w/Con. Rod marked T20007, R51727, R58979; Torque-To-Yield bolt; Replacement recommended
4	Rod Pair	FP-RE27348	STD	
4	Rod Pair	FP-RE27349	10	
4	Rod Pair	FP-RE27358	20	
4	Rod Pair	FP-RE27364	30	

QTY	PISTON RINGS	PART NO.	SIZE	DESCRIPTION
4	Ring Set Single Cylinder	FP-AR70633	STD	2-3/32, 1-.196 (1 cyl. set)

## KITS

QTY	OVERHAUL KIT	PART NO.	SIZE	DESCRIPTION
1	In-Frame Overhaul Kit	FP-202EORLIFK		w/Block marked T23406, T24961; w/Con. Rod marked T20007; To Ser. No. 158,257; O-rings on liner; Incl. Torque-To-Yield con. rod bolts
1	In-Frame Overhaul Kit	FP-202LIFK		w/Block marked T32342, R53230, R53250, R55034, R72973; w/Con. Rod marked T20007; From Ser. No. 158,258; O-rings in block; Incl. Torque-To-Yield con. rod bolts
1	Complete Overhaul Kit	FP-202LOHK		w/Block marked R53230, R53250, R55034, R72973, T32342; w/Con. Rod marked T20007; From Ser. No. 158,258; O-rings in block; Incl. front & rear seals; Incl. Torque-To-Yield con. rod bolts
1	Complete Overhaul Kit	FP-202EORLOHK		w/Block marked T23406, T24961; w/Con. Rod marked T20007; To Ser. No. 158,257; O-rings on liner; Incl. front & rear seals; Incl. Torque-To-Yield con. rod bolts

Combine 217G Eng. Harvester 217G Eng. Power Unit 217G Eng. 39  
 3.6L 217 OHV L6, 3.625" Bore

## CYL. HEAD & PARTS

QTY	VALVE	PART NO.	SIZE	DESCRIPTION
6	Intake	FP-V1629		From Ser. No. 40,000; 1.6880" Head Dia., .3415" Stem Dia., 4.7750" O.A.L.
6	Exhaust	FP-V3922		From Ser. No. 40,000; 1.3750" Head Dia., .3415" Stem Dia., 4.7780" O.A.L.
24	Keeper	VK-63		2 groove; Round key groove

QTY	VALVE GUIDE	PART NO.	SIZE	DESCRIPTION
12	Guide	FP-VG576		.3440" ID, 2.3750" O.A.L.

QTY	VALVE SPRING	PART NO.	SIZE	DESCRIPTION
12	Spring	FP-VS1430		2.1250" Free Height

QTY	VALVE SEAL	PART NO.	SIZE	DESCRIPTION
12	Valve Stem Seal	ST-2001		Positive type; Installation requires valve guide machining; Rubber/PTFE
12	Valve Stem Seal Bulk	ST-2001BC		Positive type; Installation requires valve guide machining; Carton of 100; Rubber/PTFE

## CRANKSHAFT/OIL PUMP

QTY	SEALS - FRONT CRANK	PART NO.	SIZE	DESCRIPTION
1	Crankshaft Front Seal	FP-AR67942		

QTY	SEALS - REAR CRANK	PART NO.	SIZE	DESCRIPTION
1	Crankshaft Rear Seal	FP-RE24959		

## CYLINDER COMPONENTS

QTY	PISTONS	PART NO.	SIZE	DESCRIPTION
6	Pin Bushing	FP-2599Y20		

QTY	CONNECTING RODS & BRGS.	PART NO.	SIZE	DESCRIPTION
6	Rod Pair	FP-2595A	STD	A-Series aluminum bearings
6	Rod Pair	FP-2595A10	10	A-Series aluminum bearings
6	Rod Pair	FP-2595A20	20	A-Series aluminum bearings
6	Rod Pair	FP-2595A30	30	A-Series aluminum bearings

(continued on next page)

# John Deere Off Highway



<b>39</b> Combine 217G Eng. Harvester 217G Eng. Power Unit 217G Eng. (cont.) 3.6L 217 OHV L6, 3.625" Bore				
<b>CYLINDER COMPONENTS (cont.)</b>				
<b>QTY</b>	<b>PISTON RINGS</b>	<b>PART NO.</b>	<b>SIZE</b>	<b>DESCRIPTION</b>
1	Premium Set	FP-5444KX		3-3/32, 1-3/16
<b>40</b> Combine 4219G Eng. Cotton Picker 4219G Eng. Power Unit 4219G Eng. Wheel Tractor 4219G Eng. Crawler Tractor 4219G Eng. 3.6L 219 OHV L4, 4.0156" Bore				
<b>CYL. HEAD &amp; PARTS</b>				
<b>QTY</b>	<b>GASKETS</b>	<b>PART NO.</b>	<b>SIZE</b>	<b>DESCRIPTION</b>
1	Valve Cover Gasket	FP-T20075		
<b>QTY</b>	<b>VALVE MISC.</b>	<b>PART NO.</b>	<b>SIZE</b>	<b>DESCRIPTION</b>
1	Oil Filler Cap Gasket	FP-T20328		
<b>QTY</b>	<b>VALVE SEAL</b>	<b>PART NO.</b>	<b>SIZE</b>	<b>DESCRIPTION</b>
4	Valve Stem Seal	FP-R87627		Int.; O-Ring type
<b>QTY</b>	<b>ROCKER PARTS</b>	<b>PART NO.</b>	<b>SIZE</b>	<b>DESCRIPTION</b>
1	O-Ring	FP-R56463		Rocker cover breather tube
<b>ELECTRICAL</b>				
<b>QTY</b>	<b>ALTERNATOR</b>	<b>PART NO.</b>	<b>SIZE</b>	<b>DESCRIPTION</b>
1	Ball Brg.	FP-JD9449		Front; 55 amp alternator; 72 amp alternator
<b>CAMSHAFT GROUP</b>				
<b>QTY</b>	<b>TIMING COVER</b>	<b>PART NO.</b>	<b>SIZE</b>	<b>DESCRIPTION</b>
1	Timing Gear Cover Gasket	FP-T20273		Access cover
<b>COOLING SYSTEM</b>				
<b>QTY</b>	<b>WATER PUMP</b>	<b>PART NO.</b>	<b>SIZE</b>	<b>DESCRIPTION</b>
1	Water Pump Impeller	FP-R94419		w/Pump housing marked R48992
1	Water Pump Impeller	FP-R40979		w/Pump housing marked R49365
1	Water Pump Housing Gasket	FP-T25485		w/Pump housing marked R49365
1	Water Pump Mounting Gasket	FP-T20243		w/Pump housing marked R48992, R49365
<b>QTY</b>	<b>THERMOSTAT</b>	<b>PART NO.</b>	<b>SIZE</b>	<b>DESCRIPTION</b>
1	Thermostat Cover Gasket	FP-T20215		
<b>QTY</b>	<b>MISCELLANEOUS</b>	<b>PART NO.</b>	<b>SIZE</b>	<b>DESCRIPTION</b>
3	Water Manifold Gasket	FP-T23002		
<b>ENGINE BLOCK &amp; PARTS</b>				
<b>QTY</b>	<b>GASKETS</b>	<b>PART NO.</b>	<b>SIZE</b>	<b>DESCRIPTION</b>
1	Flywheel Housing Gasket	FP-R97351		
1	Oil Pan Gasket	FP-R119360		From Ser. No. 100,001 to Ser. No. 185,199; Manufactured 1964-70; w/Cast iron oil pan
1	Oil Pan Gasket	FP-R119360		From Ser. No. 100,001; Manufactured after 1983; w/Cast iron oil pan
1	Oil Pan Gasket	FP-R119360		From Ser. No. 185,200 to Ser. No. 621,172; Manufactured 1970-83; w/Cast iron oil pan
1	Block to End Plate Front Gskt	FP-R131794		
<b>QTY</b>	<b>GASKET SETS</b>	<b>PART NO.</b>	<b>SIZE</b>	<b>DESCRIPTION</b>
1	Gasket Conversion Set	FP-PG219CS		Wear sleeve incl.
<b>QTY</b>	<b>ENGINE BEARING MISC.</b>	<b>PART NO.</b>	<b>SIZE</b>	<b>DESCRIPTION</b>
1	Bal. Shaft Set	FP-R57160S		
<b>QTY</b>	<b>OIL COOLERS &amp; FILTERS</b>	<b>PART NO.</b>	<b>SIZE</b>	<b>DESCRIPTION</b>
1	Washer	FP-R105714		Oil cooler; From Ser. No. 3,001 to Ser. No. 150,000
1	Rect. or Square Seal	FP-R70956		Cooler housing w/relief valve; From Ser. No. 3,100 to Ser. No. 150,000; 2.700" X 3.000" X .180"
<b>CRANKSHAFT/OIL PUMP</b>				
<b>QTY</b>	<b>SEALS - FRONT CRANK</b>	<b>PART NO.</b>	<b>SIZE</b>	<b>DESCRIPTION</b>
1	Crankshaft Front Seal	FP-AR67942		
<b>QTY</b>	<b>SEALS - REAR CRANK</b>	<b>PART NO.</b>	<b>SIZE</b>	<b>DESCRIPTION</b>
1	Crankshaft Rear Seal	FP-RE24959		
<b>QTY</b>	<b>MAIN BEARINGS</b>	<b>PART NO.</b>	<b>SIZE</b>	<b>DESCRIPTION</b>
1	Main Set	FP-MBK3002		STD
1	Main Set	FP-MBK300210		10
1	Main Set	FP-MBK300220		20
1	Main Set	FP-MBK300230		30

(continued on next page)



# John Deere Off Highway

**Combine 4219G Eng. Cotton Picker 4219G Eng. Power Unit 4219G Eng. Wheel Tractor 40  
4219G Eng. Crawler Tractor 4219G Eng. (cont.)  
3.6L 219 OHV L4, 4.0156" Bore**

**CRANKSHAFT/OIL PUMP (cont.)**

QTY	OIL PUMP	PART NO.	SIZE	DESCRIPTION
1	O-Ring	FP-R61871		Oil pump inlet; From Ser. No. 240,554

**CYLINDER COMPONENTS**

QTY	LINERS	PART NO.	SIZE	DESCRIPTION
4	Sealing Ring	FP-SLR2515		Top sleeve seal; Rectangle

QTY	CONNECTING RODS & BRGS.	PART NO.	SIZE	DESCRIPTION
4	Rod Pair	FP-2595A	STD	A-Series aluminum bearings
4	Rod Pair	FP-2595A10	10	A-Series aluminum bearings
4	Rod Pair	FP-2595A20	20	A-Series aluminum bearings
4	Rod Pair	FP-2595A30	30	A-Series aluminum bearings

**Combine 4219D Eng. Cotton Picker 4219D Eng. Forklift 4219D Eng. Loader 4219D Eng. 41  
Power Unit 4219D Eng. Wheel Tractor 4219D Eng. Windrower 4219D Eng. Crawler Tractor  
4219D Eng. Loader Tractor 4219D Eng. Forestry Tractor 4219D Eng. Skidder 4219D Eng.  
Dozer 4219D Eng. Backhoe 4219D Eng. Sprayer 4219D Eng.  
3.6L 219 OHV Diesel L4, 4.0156" Bore**

**CYL. HEAD & PARTS**

QTY	GASKETS	PART NO.	SIZE	DESCRIPTION
1	Valve Cover Gasket	FP-R73521		Rocker arm cover codes 1101, 1102; To Ser. No. 598,042
1	Valve Cover Gasket	FP-T20075		To Ser. No. 598,042
1	Head Gasket	FP-R125863		From Ser. No. 100,001; Manufactured after 1983
1	Head Gasket	FP-R125863		From Ser. No. 290,000 to Ser. No. 621,172; Manufactured 1974-83
1	Head Set	FP-RE38851		Rocker arm cover codes 1101, 1102; To Ser. No. 598,042

QTY	VALVE	PART NO.	SIZE	DESCRIPTION
4	Intake	FP-R83071	STD	Stellite; 2 groove; Chrome plated stem; 1.8210" Head Dia., .3720" Stem Dia., 5.1660" O.A.L.
4	Intake	FP-R89223	3	Stellite; 2 groove; Chrome plated stem; 1.8210" Head Dia., .3750" Stem Dia., 5.1660" O.A.L.
4	Intake	FP-R89224	15	Stellite; 2 groove; Chrome plated stem; 1.8210" Head Dia., .3870" Stem Dia., 5.1660" O.A.L.
4	Intake	FP-R79623	STD	2 groove; Chrome plated stem; 1.7720" Head Dia., .3720" Stem Dia., 5.1560" O.A.L.
4	Intake	FP-R79628	3	2 groove; Chrome plated stem; 1.7720" Head Dia., .3750" Stem Dia., 5.1560" O.A.L.
4	Intake	FP-R79629	15	2 groove; Chrome plated stem; 1.7720" Head Dia., .3870" Stem Dia., 5.1560" O.A.L.
4	Intake	FP-R79630	30	2 groove; Chrome plated stem; 1.7720" Head Dia., .4020" Stem Dia., 5.1560" O.A.L.
4	Exhaust	FP-R79624	STD	1 groove; Chrome plated stem; 1.5750" Head Dia., .3720" Stem Dia., 5.1560" O.A.L.
4	Exhaust	FP-R79625	3	1 groove; Chrome plated stem; 1.5750" Head Dia., .3750" Stem Dia., 5.1560" O.A.L.
4	Exhaust	FP-R79626	15	1 groove; Chrome plated stem; 1.5750" Head Dia., .3870" Stem Dia., 5.1560" O.A.L.
4	Exhaust	FP-R79627	30	1 groove; Chrome plated stem; 1.5750" Head Dia., .4020" Stem Dia., 5.1560" O.A.L.
4	Exhaust	FP-R90692	STD	1 groove; Chrome plated stem; 1.6730" Head Dia., .3095" Stem Dia., 5.2550" O.A.L.
8	Valve Stem Cap	FP-T20129		Exh. & Int.
16	Keeper	FP-41339		1 groove; Square cut key groove
16	Keeper	FP-T20077		1 groove; Square cut key groove; Hardened
16	Keeper, Bulk	VK-138B		1 groove; Square cut key groove; Carton of 1000

QTY	VALVE SEAT	PART NO.	SIZE	DESCRIPTION
4	Exh.	FP-R51734	STD	
4	Int.	FP-R73064	STD	

QTY	VALVE SPRING	PART NO.	SIZE	DESCRIPTION
8	Spring	FP-R26125		2.1200" Free Height

QTY	VALVE MISC.	PART NO.	SIZE	DESCRIPTION
8	Rotocap	FP-RE11410		Exh. & Int.
1	Bushing	FP-T26321		Lower
1	Bushing	FP-T20034		Upper

(continued on next page)

**41** Combine 4219D Eng. Cotton Picker 4219D Eng. Forklift 4219D Eng. Loader 4219D Eng. Power Unit 4219D Eng. Wheel Tractor 4219D Eng. Windrower 4219D Eng. Crawler Tractor 4219D Eng. Loader Tractor 4219D Eng. Forestry Tractor 4219D Eng. Skidder 4219D Eng. Dozer 4219D Eng. Backhoe 4219D Eng. Sprayer 4219D Eng.  
3.6L 219 OHV Diesel L4, 4.0156" Bore

## CYL. HEAD & PARTS (cont.)

QTY	VALVE MISC. (cont.)	PART NO.	SIZE	DESCRIPTION
1	Oil Filler Cap Gasket	FP-T20328		Rocker arm cover code 1101; Oil filler neck codes 1201, 1202, 1203, 1206
8	Valve Stem Seal	FP-R87627		Exh. & Int.; O-Ring type
1	O-Ring	FP-R56463		Rocker cover breather tube; Breather tube codes 2901, 2902, 2903

## ELECTRICAL

QTY	ELECTRICAL	PART NO.	SIZE	DESCRIPTION
1	Starter to Block Gasket	FP-R53108		3-Hole mount; Starting motor code 3001
1	Ball Brg.	FP-JD9449		Front; Motorola No. A12NJD453; Code 3101; 35 amp alternator
1	Ball Brg.	FP-JD9449		Front; Motorola No. A12NJD604; Code 3102; 55 amp alternator
1	Ball Brg.	FP-JD9449		Front; Motorola No. 8TA2009ES; Code 3104; 30 amp alternator
1	Ball Brg.	FP-JD9449		Front; 55 amp alternator; 72 amp alternator

## INT & EXH MANIFOLDS

QTY	INT. & EXH. MANIFOLDS	PART NO.	SIZE	DESCRIPTION
4	Exhaust Manifold Gasket	FP-R90658		Exh. manifold codes 2801, 2802, 2803, 2807
1	Air Intake Gasket	FP-R81275		Air inlet codes 1701, 1702, 1703, 1704, 1709

## CAMSHAFT GROUP

QTY	TIMING COVER	PART NO.	SIZE	DESCRIPTION
1	Timing Gear Cover Gasket	FP-T20273		Access cover
1	Timing Gear Cover Gasket	FP-R97454		Front cover
8	Lifter	FP-T20073		

## FUEL SYSTEM & PARTS

QTY	FUEL INJECTION	PART NO.	SIZE	DESCRIPTION
1	Injector Pump Gasket	FP-R125066		Gear cover
4	Fuel Injector Nozzle	FP-AR89564		Nozzle assy. codes 1602, 1603; Marked R005A; Master No. 22202
4	Fuel Injector Seal	FP-R79605		Fuel line connection; Nozzle codes 1602, 1603; 9.270MM X 13.600MM X 5.080MM
12	Washer	FP-T20055		Pump codes 1602, 1603
4	Fuel Injector Nut	FP-R79604		w/Injector marked 19762, 20500, 20631, 22042, 22202
8	Washer Type Seal	FP-R51936		Leak-off & return line seals; Nozzle codes 1602, 1603; From Ser. No. 126,967
4	Washer Type Seal	FP-R48000		Lower; w/Nozzle marked 19762, 20500, 20631, 22042, 22202; w/Nozzle codes 1602, 1603
4	Washer Type Seal	FP-R48000		Lower; w/Nozzle marked 20631, 22042, 22202
4	Washer Type Seal	FP-R60746		Upper; Nozzle codes 1602, 1603; w/Nozzle marked 20631, 22042, 22202
1	Mechanical Fuel Pump	FP-RE42211		Transfer pump
1	Fuel Transfer Pump Gasket	FP-R97350		

## COOLING SYSTEM

QTY	WATER PUMP	PART NO.	SIZE	DESCRIPTION
1	Water Pump Impeller	FP-R40979		w/Pump housing marked R49365
1	Water Pump Impeller	FP-R47191		w/Pump housing marked R66420, R68733
1	Water Pump Impeller	FP-R94419		Pump code 2001; w/Pump housing marked R48997
1	Water Pump Impeller	FP-R94419		Pump code 2002; w/Pump housing marked R55164, T29521
1	Water Pump Impeller	FP-R94419		Pump code 2004; w/Pump housing marked R54051, R55758
1	Water Pump Impeller	FP-R94419		Pump code 2005; w/Pump housing marked R55164
1	Water Pump Repair/Rebuild Kit	FP-939840979		w/Pump housing marked R29701, R48994
1	Water Pump Repair/Rebuild Kit	FP-944840979		w/Pump housing marked R52009
1	Water Pump Repair/Rebuild Kit	FP-925740979		w/Pump housing marked R56787, R62902
1	Water Pump Repair/Rebuild Kit	FP-RE62661		w/Pump housing marked R66420, R68733
1	Water Pump Housing Gasket	FP-R97455		w/Pump housing marked R48997, R51039, R54051
1	Water Pump Housing Gasket	FP-R55405		w/Pump housing marked R55164

(continued on next page)





# John Deere Off Highway

**Combine 4219D Eng. Cotton Picker 4219D Eng. Forklift 4219D Eng. Loader 4219D Eng. 41  
Power Unit 4219D Eng. Wheel Tractor 4219D Eng. Windrower 4219D Eng. Crawler Tractor (cont.)  
4219D Eng. Loader Tractor 4219D Eng. Forestry Tractor 4219D Eng. Skidder 4219D Eng.  
Dozer 4219D Eng. Backhoe 4219D Eng. Sprayer 4219D Eng.  
3.6L 219 OHV Diesel L4, 4.0156" Bore**

<b>COOLING SYSTEM (cont.)</b>				
<b>QTY</b>	<b>WATER PUMP (cont.)</b>	<b>PART NO.</b>	<b>SIZE</b>	<b>DESCRIPTION</b>
1	Oil Seal Kit	FP-AR101549		Water Pump; w/Pump housing marked R48997, R51039, R54051, R55164, R55758, T29521
1	Shaft & Bearing Assembly	FP-JD9448		w/Cast pulley; w/Pump housing marked R55164
<b>QTY</b>	<b>THERMOSTAT</b>	<b>PART NO.</b>	<b>SIZE</b>	<b>DESCRIPTION</b>
1	Thermostat	FP-RE33705		Thermostat code 2204; 180 Deg.
1	Thermostat Gasket	FP-T20219		Thermostat housing marked T20218
1	Thermostat Cover Gasket	FP-T20215		
<b>ENGINE BLOCK &amp; PARTS</b>				
<b>QTY</b>	<b>GASKETS</b>	<b>PART NO.</b>	<b>SIZE</b>	<b>DESCRIPTION</b>
1	Flywheel Housing Gasket	FP-R97351		Flywheel housing codes 1403, 1404, 1405, 1410
1	Oil Pan Gasket	FP-R119360		w/Sheet metal pan; Oil pan codes 1901, 1902, 1903; w/Cast iron oil pan
1	Oil Pan Gasket	FP-R97342		Use w/Cast iron oil pan; w/Stamped Steel Pan
1	Block to End Plate Front Gskt	FP-R131794		From Ser. No. 100,001; Manufactured after 1983
1	Block to End Plate Front Gskt	FP-R131794		From Ser. No. 290,000 to Ser. No. 621,172; Manufactured 1974-83
<b>QTY</b>	<b>GASKET SETS</b>	<b>PART NO.</b>	<b>SIZE</b>	<b>DESCRIPTION</b>
1	Gasket Conversion Set	FP-PG219CS		Wear sleeve incl.
1	In-Frame Gasket Set	FP-PG219S		
1	Complete Overhaul Gasket Set	FP-RE38857		Crankshaft seals not incl.
1	Complete Overhaul Gasket Set	FP-RE38857WS		Incl. crankshaft seals; Rear main brg. seal incl.; Wear sleeve not incl.
1	Kit Gasket Set	260-1392		Head gskt. accommodates FP-T32343-WS larger bore dia. sleeve; Compl.; Rear main brg. seal incl.; Wear sleeve incl.
<b>QTY</b>	<b>ENGINE BEARING MISC.</b>	<b>PART NO.</b>	<b>SIZE</b>	<b>DESCRIPTION</b>
1	Bal. Shaft Set	FP-R57160S		
6	Balance Shaft Bearing	FP-R57160		
<b>QTY</b>	<b>OIL COOLERS &amp; FILTERS</b>	<b>PART NO.</b>	<b>SIZE</b>	<b>DESCRIPTION</b>
1	Washer	FP-R105714		Oil cooler; From Ser. No. 1,701 to Ser. No. 3,000
1	Washer	FP-R105714		Oil cooler; From Ser. No. 3,301 to Ser. No. 6,500
1	Rect. or Square Seal	FP-R70956		Cooler housing w/relief valve; Oil cooler codes 5901, 5902, 5903, 5904; 2.700" X 3.000" X .180"
<b>CRANKSHAFT/OIL PUMP</b>				
<b>QTY</b>	<b>CRANKSHAFT</b>	<b>PART NO.</b>	<b>SIZE</b>	<b>DESCRIPTION</b>
1	Crankshaft	FP-AT18030		
1	Oil Seal Kit	FP-SK67942		Incl. front & rear seals; Crankshaft marked R100791
<b>QTY</b>	<b>SEALS - FRONT CRANK</b>	<b>PART NO.</b>	<b>SIZE</b>	<b>DESCRIPTION</b>
1	Crankshaft Front Seal	FP-AR67942		
<b>QTY</b>	<b>SEALS - REAR CRANK</b>	<b>PART NO.</b>	<b>SIZE</b>	<b>DESCRIPTION</b>
1	Crankshaft Rear Seal	FP-RE24959		w/Flywheel housing codes 1402, 1403, 1404, 1405
<b>QTY</b>	<b>MAIN BEARINGS</b>	<b>PART NO.</b>	<b>SIZE</b>	<b>DESCRIPTION</b>
1	Main Set	FP-MBK3004	STD	w/Flanged thrust brg.
1	Main Set	FP-MBK300410	10	w/Flanged thrust brg.
1	Main Set	FP-MBK300420	20	w/Flanged thrust brg.
1	Main Set	FP-MBK300430	30	w/Flanged thrust brg.
4	Plain Main Brg.	FP-RE27352	STD	w/Flangeless thrust brg.
4	Plain Main Brg.	FP-RE27353	10	w/Flangeless thrust brg.
4	Plain Main Brg.	FP-RE27360	20	w/Flangeless thrust brg.
4	Plain Main Brg.	FP-RE27368	30	w/Flangeless thrust brg.
1	Flanged Main Brg.	FP-RE521350	STD	
1	Flanged Main Brg.	FP-RE526754	10	
1	Flanged Main Brg.	FP-RE527235	20	
1	Flanged Main Brg.	FP-RE527236	30	
4	Thrust Washer	FP-R78598	STD	
<b>QTY</b>	<b>OIL PUMP</b>	<b>PART NO.</b>	<b>SIZE</b>	<b>DESCRIPTION</b>
1	Pump Repair Kit	FP-RE55343		w/Pump housing marked R54615
1	O-Ring	FP-R61871		Oil pump inlet; From Ser. No. 240,554; w/Pump housing marked R54615
1	O-Ring	FP-R74354		Oil pump outlet tube; w/Pump housing marked R54615
1	Oil Filler Inlet Gasket	FP-R97352		Oil filler neck codes 1200, 1201

(continued on next page)

**41** Combine 4219D Eng. Cotton Picker 4219D Eng. Forklift 4219D Eng. Loader 4219D Eng. Power Unit 4219D Eng. Wheel Tractor 4219D Eng. Windrower 4219D Eng. Crawler Tractor 4219D Eng. Loader Tractor 4219D Eng. Forestry Tractor 4219D Eng. Skidder 4219D Eng. Dozer 4219D Eng. Backhoe 4219D Eng. Sprayer 4219D Eng.  
3.6L 219 OHV Diesel L4, 4.0156" Bore

## CYLINDER COMPONENTS

QTY	LINEARS	PART NO.	SIZE	DESCRIPTION
4	Liner w/o Sealing Ring	FP-R116463	STD	w/o Piston spray cooling; O-rings in block
4	Liner w/o Sealing Ring	FP-T32343	STD	From Ser. No. 275,484
4	Liner w/o Sealing Ring	FP-R48636	STD	To Ser. No. 275,483
4	Liner w/o Sealing Ring	FP-T32343	STD	To Ser. No. 275,483
4	Liner w/Sealing Rings	FP-T32343WS	STD	
4	Liner w/Sealing Rings	FP-AR51903	STD	To Ser. No. 275,483; Incl. 2-FPR4863R (Rect., upper step & lower groove on sleeve) & 1-FPT32341 (Top groove on sleeve) sealing rings.
4	Cylinder Kit Complete	FP-AR78041	STD	w/Con. Rod marked R51727; From Ser. No. 275,484; O-Rings in block; Pin dia. 1.38"
4	Cylinder Kit Complete	FP-AR71593	STD	w/Con. Rod marked T20007, R81410; To Ser. No. 275,483; O-rings in block; Pin dia. 1.19"
4	Cylinder Kit Complete	FP-CK83108636	STD	w/Con. Rod marked T20007, R81410; To Ser. No. 275,483; O-rings on liner
4	Cyl. Liner Sealing Ring Kit	FP-AR71618		From Ser. No. 275,484
4	Cyl. Liner Sealing Ring Kit	FP-AR71618		To Ser. No. 275,483
4	Sealing Ring, Liner	FP-R48637		To Ser. No. 275,483; Rectangle; Top & Bottom
4	Sealing Ring, Liner	FP-T32341		To Ser. No. 275,483; Round
4	Sealing Ring	FP-SLR2388		Round
4	Sealing Ring	FP-SLR2515		Top sleeve seal; Rectangle
QTY	PISTONS	PART NO.	SIZE	DESCRIPTION
4	Piston Body w/o Pin	FP-AR77762	STD	From Ser. No. 275,484
4	Piston Body w/o Pin	FP-AR78310	STD	To Ser. No. 275,483
4	Piston Kit w/Pin & Retainers	FP-AR77762WP	STD	From Ser. No. 275,484
4	Piston Kit w/Pin & Retainers	FP-AR78310WP	STD	To Ser. No. 275,483
4	Pin	FP-R125754		From Ser. No. 275,484; 1.38" pin dia.
4	Pin	FP-T26149		To Ser. No. 275,483
4	Piston Pin Retainer	FP-M41029		From Ser. No. 275,484; For 1.38" pin dia.
8	Piston Pin Retainer	FP-R51112		To Ser. No. 275,483
4	Pin Bushing	FP-R55647		w/Con. Rod marked R51727, R80034; 1.3765" ID, 1.500" OD, 1.570" O.A.L.
4	Pin Bushing	FP-T23471		w/Con. Rod marked R81410, T20007; 1.1896" ID, 1.313" OD, 1.570" O.A.L.
QTY	CONNECTING RODS & BRGS.	PART NO.	SIZE	DESCRIPTION
8	Con. Rod Bolt	FP-R80033		w/Con. Rod marked R80032, R80034, R81410, R105011, R113612; Torque-To-Yield bolt; Replacement recommended
8	Con. Rod Bolt	FP-R74194		w/Con. Rod marked T20007, R51727, R58979; Torque-To-Yield bolt; Replacement recommended
4	Rod Pair	FP-RE27348	STD	
4	Rod Pair	FP-RE27349	10	
4	Rod Pair	FP-RE27358	20	
4	Rod Pair	FP-RE27364	30	
QTY	PISTON RINGS	PART NO.	SIZE	DESCRIPTION
4	Ring Set Single Cylinder	FP-AR55759	STD	1-1/8, 1-3/32, 1-.1965 (1 cyl. set)
1	Premium Set	FP-AR55759S	STD	1-1/8, 1-3/32, 1-.1965
CLUTCH				
QTY	CLUTCH	PART NO.	SIZE	DESCRIPTION
1	Ball Brg.	FP-JD8537		PTO Clutch drive; Shaft codes 5801, 5803
KITS				
QTY	OVERHAUL KIT	PART NO.	SIZE	DESCRIPTION
1	In-Frame Overhaul Kit	FP-219EORLIFK		w/Block marked T26933; w/Con. Rod marked T20007; O-rings on liner; To Ser. No. 275,483; Incl. Torque-To-Yield con. rod bolts
1	In-Frame Overhaul Kit	FP-219LIFK		w/Con. Rod marked R51727; Pin dia. 1.38"; From Ser. No. 275,484; Incl. Torque-To-Yield con. rod bolts
1	In-Frame Overhaul Kit	FP-219MIFK		w/Con. Rod marked T20007; Pin dia. 1.19"; To Ser. No. 275,483; O-rings in block; Incl. Torque-To-Yield con. rod bolts
1	Complete Overhaul Kit	FP-219EORLOHK		w/Block marked T26933; w/Con. Rod marked T20007; To Ser. No. 275,483; O-rings on liner; Incl. front & rear seals; Crankshaft marked R100791; Incl. Torque-To-Yield con. rod bolts

(continued on next page)



# John Deere Off Highway

Combine 4219D Eng. Cotton Picker 4219D Eng. Forklift 4219D Eng. Loader 4219D Eng. 41  
 Power Unit 4219D Eng. Wheel Tractor 4219D Eng. Windrower 4219D Eng. Crawler Tractor (cont.)  
 4219D Eng. Loader Tractor 4219D Eng. Forestry Tractor 4219D Eng. Skidder 4219D Eng.  
 Dozer 4219D Eng. Backhoe 4219D Eng. Sprayer 4219D Eng.  
 3.6L 219 OHV Diesel L4, 4.0156" Bore

## KITS (cont.)

QTY	OVERHAUL KIT (cont.)	PART NO.	SIZE	DESCRIPTION
1	Complete Overhaul Kit	FP-219LOHK		w/Con. Rod marked R51727; Pin dia. 1.38"; From Ser. No. 275,484; Incl. front & rear seals; Crankshaft marked R100791; Incl. Torque-To-Yield con. rod bolts
1	Complete Overhaul Kit	FP-219MOHK		w/Con. Rod marked T20007; Pin dia. 1.19"; To Ser. No. 275,483; O-rings in block; Incl. front & rear seals; Crankshaft marked R100791; Incl. Torque-To-Yield con. rod bolts

Wheel Tractor 4219T Eng. Crawler Tractor 4219T Eng. Loader Tractor 4219T Eng. Skidder 42  
 4219T Eng. Dozer 4219T Eng. Backhoe 4219T Eng.  
 3.6L 219 OHV Turbo-Diesel L4, 4.0156" Bore

## CYL. HEAD & PARTS

QTY	GASKETS	PART NO.	SIZE	DESCRIPTION
1	Head Set	FP-RE38851		
QTY	VALVE	PART NO.	SIZE	DESCRIPTION
4	Intake	FP-R83071	STD	Stellite; 2 groove; Chrome plated stem; 1.8210" Head Dia., .3720" Stem Dia., 5.1660" O.A.L.
4	Intake	FP-R89223	3	Stellite; 2 groove; Chrome plated stem; 1.8210" Head Dia., .3750" Stem Dia., 5.1660" O.A.L.
4	Intake	FP-R89224	15	Stellite; 2 groove; Chrome plated stem; 1.8210" Head Dia., .3870" Stem Dia., 5.1660" O.A.L.
4	Intake	FP-R98062	STD	1 groove; Chrome plated stem; 1.8350" Head Dia., .3100" Stem Dia., 5.2780" O.A.L.
4	Intake	FP-R79623	STD	2 groove; Chrome plated stem; 1.7720" Head Dia., .3720" Stem Dia., 5.1560" O.A.L.
4	Intake	FP-R79628	3	2 groove; Chrome plated stem; 1.7720" Head Dia., .3750" Stem Dia., 5.1560" O.A.L.
4	Intake	FP-R79629	15	2 groove; Chrome plated stem; 1.7720" Head Dia., .3870" Stem Dia., 5.1560" O.A.L.
4	Intake	FP-R79630	30	2 groove; Chrome plated stem; 1.7720" Head Dia., .4020" Stem Dia., 5.1560" O.A.L.
4	Exhaust	FP-R79624	STD	1 groove; Chrome plated stem; 1.5750" Head Dia., .3720" Stem Dia., 5.1560" O.A.L.
4	Exhaust	FP-R79625	3	1 groove; Chrome plated stem; 1.5750" Head Dia., .3750" Stem Dia., 5.1560" O.A.L.
4	Exhaust	FP-R79626	15	1 groove; Chrome plated stem; 1.5750" Head Dia., .3870" Stem Dia., 5.1560" O.A.L.
4	Exhaust	FP-R79627	30	1 groove; Chrome plated stem; 1.5750" Head Dia., .4020" Stem Dia., 5.1560" O.A.L.
4	Exhaust	FP-R90692	STD	1 groove; Chrome plated stem; 1.6730" Head Dia., .3095" Stem Dia., 5.2550" O.A.L.
8	Valve Stem Cap	FP-T20129		Exh. & Int.
16	Keeper	FP-41339		1 groove; Square cut key groove
16	Keeper	FP-T20077		1 groove; Square cut key groove; Hardened
16	Keeper, Bulk	VK-138B		1 groove; Square cut key groove; Carton of 1000
QTY	VALVE SEAT	PART NO.	SIZE	DESCRIPTION
4	Exh.	FP-R51734	STD	
4	Int.	FP-R73064	STD	
QTY	VALVE SPRING	PART NO.	SIZE	DESCRIPTION
8	Spring	FP-R26125		2.1200" Free Height
QTY	VALVE MISC.	PART NO.	SIZE	DESCRIPTION
8	Rotocap	FP-RE11410		Exh. & Int.
1	Bushing	FP-T26321		Lower
1	Bushing	FP-T20034		Upper
QTY	VALVE SEAL	PART NO.	SIZE	DESCRIPTION
8	Valve Stem Seal	FP-R87627		O-Ring type
<b>CAMSHAFT GROUP</b>				
QTY	CAMSHAFT/LIFTER	PART NO.	SIZE	DESCRIPTION
8	Lifter	FP-T20073		
<b>FUEL SYSTEM &amp; PARTS</b>				
QTY	FUEL FILTERS & PUMP	PART NO.	SIZE	DESCRIPTION
1	Mechanical Fuel Pump	FP-RE42211		Transfer pump

(continued on next page)

**42** Wheel Tractor 4219T Eng. Crawler Tractor 4219T Eng. Loader Tractor 4219T Eng. Skidder  
 (cont.) 4219T Eng. Dozer 4219T Eng. Backhoe 4219T Eng.  
 3.6L 219 OHV Turbo-Diesel L4, 4.0156" Bore

COOLING SYSTEM				
QTY	THERMOSTAT	PART NO.	SIZE	DESCRIPTION
1	Thermostat Gasket	FP-T20219		Thermostat housing marked T20218
1	Thermostat Cover Gasket	FP-T20215		
ENGINE BLOCK & PARTS				
QTY	GASKETS	PART NO.	SIZE	DESCRIPTION
1	Oil Pan Gasket	FP-R97342		w/Stamped Steel Pan
QTY	GASKET SETS	PART NO.	SIZE	DESCRIPTION
1	Gasket Conversion Set	FP-PG219CS		Wear sleeve incl.
1	In-Frame Gasket Set	FP-PG219S		
1	Complete Overhaul Gasket Set	FP-RE38857		Crankshaft seals not incl.
1	Complete Overhaul Gasket Set	FP-RE38857WS		Incl. crankshaft seals; Rear main brg. seal incl.; Wear sleeve not incl.
1	Kit Gasket Set	260-1392		Head gskt. accommodates FP-T32343-WS larger bore dia. sleeve; Compl.; Rear main brg. seal incl.; Wear sleeve incl.
QTY	ENGINE BEARING MISC.	PART NO.	SIZE	DESCRIPTION
1	Bal. Shaft Set	FP-R57160S		
6	Balance Shaft Bearing	FP-R57160		
CRANKSHAFT/OIL PUMP				
QTY	CRANKSHAFT	PART NO.	SIZE	DESCRIPTION
1	Crankshaft	FP-AT18030		Incl. front & rear seals; Crankshaft marked R100791
1	Oil Seal Kit	FP-SK67942		
QTY	SEALS - FRONT CRANK	PART NO.	SIZE	DESCRIPTION
1	Crankshaft Front Seal	FP-AR67942		
QTY	SEALS - REAR CRANK	PART NO.	SIZE	DESCRIPTION
1	Oil Seal Kit	FP-SK67942		Incl. front & rear seals; Crankshaft marked R100791
1	Crankshaft Rear Seal	FP-RE24959		
QTY	MAIN BEARINGS	PART NO.	SIZE	DESCRIPTION
1	Main Set	FP-MBK3004	STD	w/Flanged thrust brg.
1	Main Set	FP-MBK300410	10	w/Flanged thrust brg.
1	Main Set	FP-MBK300420	20	w/Flanged thrust brg.
1	Main Set	FP-MBK300430	30	w/Flanged thrust brg.
4	Plain Main Brg.	FP-RE27352	STD	w/Flangeless thrust brg.
4	Plain Main Brg.	FP-RE27353	10	w/Flangeless thrust brg.
4	Plain Main Brg.	FP-RE27360	20	w/Flangeless thrust brg.
4	Plain Main Brg.	FP-RE27368	30	w/Flangeless thrust brg.
1	Flanged Main Brg.	FP-RE521350	STD	
1	Flanged Main Brg.	FP-RE526754	10	
1	Flanged Main Brg.	FP-RE527235	20	
1	Flanged Main Brg.	FP-RE527236	30	
4	Thrust Washer	FP-R78598	STD	
CYLINDER COMPONENTS				
QTY	LINERS	PART NO.	SIZE	DESCRIPTION
4	Liner w/o Sealing Ring	FP-R116463	STD	w/o Piston spray cooling; O-rings in block
4	Liner w/o Sealing Ring	FP-T32343	STD	From Ser. No. 275,484
4	Liner w/Sealing Rings	FP-T32343WS	STD	
4	Cylinder Kit Complete	FP-AR78041	STD	w/Con. Rod marked R51727; From Ser. No. 275,484; O-Rings in block; Pin dia, 1.38"
4	Cyl. Liner Sealing Ring Kit	FP-AR71618		
4	Sealing Ring, Liner	FP-R48637		To Ser. No. 275,483; Rectangle; Top & Bottom
4	Sealing Ring, Liner	FP-T32341		To Ser. No. 275,483; Round
4	Sealing Ring	FP-SLR2388		Round
QTY	PISTONS	PART NO.	SIZE	DESCRIPTION
4	Piston Body w/o Pin	FP-AR77762	STD	From Ser. No. 275,484
4	Piston Kit w/Pin & Retainers	FP-AR77762WP	STD	From Ser. No. 275,484
4	Pin	FP-R125754		From Ser. No. 275,484; 1.38" pin dia.
4	Pin	FP-T26149		To Ser. No. 275,483
8	Piston Pin Retainer	FP-M41029		From Ser. No. 275,484; For 1.38" pin dia.
8	Piston Pin Retainer	FP-R51112		To Ser. No. 275,483
4	Pin Bushing	FP-R55647		w/Con. Rod marked R51727, R80034; 1.3765" ID, 1.500" OD, 1.570" O.A.L.
4	Pin Bushing	FP-T23471		w/Con. Rod marked R81410, T20007; 1.1896" ID, 1.313" OD, 1.570" O.A.L.

(continued on next page)



# John Deere Off Highway

Wheel Tractor 4219T Eng. Crawler Tractor 4219T Eng. Loader Tractor 4219T Eng. Skidder 4219T Eng. Dozer 4219T Eng. Backhoe 4219T Eng. (cont.)  
3.6L 219 OHV Turbo-Diesel L4, 4.0156" Bore

## CYLINDER COMPONENTS (cont.)

QTY	CONNECTING RODS & BRGS.	PART NO.	SIZE	DESCRIPTION
8	Con. Rod Bolt	FP-R80033		w/Con. Rod marked R80032, R80034, R81410, R105011, R113612; Torque-To-Yield bolt; Replacement recommended
8	Con. Rod Bolt	FP-R74194		w/Con. Rod marked T20007, R51727, R58979; Torque-To-Yield bolt; Replacement recommended
4	Rod Pair	FP-RE27348	STD	
4	Rod Pair	FP-RE27349	10	
4	Rod Pair	FP-RE27358	20	
4	Rod Pair	FP-RE27364	30	
QTY	PISTON RINGS	PART NO.	SIZE	DESCRIPTION
4	Ring Set Single Cylinder	FP-AR55759	STD	1-1/8, 1-3/32, 1-.1965 (1 cyl. set)
1	Premium Set	FP-AR55759S	STD	1-1/8, 1-3/32, 1-.1965
KITS				
QTY	OVERHAUL KIT	PART NO.	SIZE	DESCRIPTION
1	In-Frame Overhaul Kit	FP-219LIFK		w/Con. Rod marked R51727; Pin dia. 1.38"; From Ser. No. 275,484; Incl. Torque-To-Yield con. rod bolts
1	Complete Overhaul Kit	FP-219LOHK		w/Con. Rod marked R51727; Pin dia. 1.38"; From Ser. No. 275,484; Incl. front & rear seals; Crankshaft marked R100791; Incl. Torque-To-Yield con. rod bolts

Combine QXC Eng. 43  
3.6L 222 L-HEAD L6, 3.375" Bore (Hercules Eng.)

## CYL. HEAD & PARTS

QTY	VALVE	PART NO.	SIZE	DESCRIPTION
6	Intake	FP-V956		1.6410" Head Dia., .3100" Stem Dia., 4.2940" O.A.L.
6	Exhaust	FP-V748		1.4380" Head Dia., .3100" Stem Dia., 4.3320" O.A.L.
24	Keeper	FP-VK123		
QTY	VALVE GUIDE	PART NO.	SIZE	DESCRIPTION
12	Guide	FP-VG456		.532" OD; .3120" ID, 2.0940" O.A.L.
QTY	VALVE SPRING	PART NO.	SIZE	DESCRIPTION
12	Spring	FP-VS286		2.0620" Free Height

## ENGINE BLOCK & PARTS

QTY	CAM BEARINGS	PART NO.	SIZE	DESCRIPTION
1	Cam Set	FP-1142M		

## CRANKSHAFT/OIL PUMP

QTY	MAIN BEARINGS	PART NO.	SIZE	DESCRIPTION
1	Plain Main Brg.	FP-2241CP10	10	Position 1
1	Plain Main Brg.	FP-2241CP20	20	Position 1
1	Plain Main Brg.	FP-2241CP30	30	Position 1
4	Plain Main Brg.	FP-2243CP10	10	Position 2-3-5-6
4	Plain Main Brg.	FP-2243CP20	20	Position 2-3-5-6
4	Plain Main Brg.	FP-2243CP30	30	Position 2-3-5-6
1	Plain Main Brg.	FP-2244CP10	10	Position 4
1	Plain Main Brg.	FP-2244CP20	20	Position 4
1	Plain Main Brg.	FP-2244CP30	30	Position 4
1	Plain Main Brg.	FP-9624CPA10	10	Position 7
1	Plain Main Brg.	FP-9624CPA20	20	Position 7
1	Plain Main Brg.	FP-9624CPA30	30	Position 7

## CYLINDER COMPONENTS

QTY	PISTONS	PART NO.	SIZE	DESCRIPTION
6	Pin Bushing	FP-9624X		Full round bushing
QTY	CONNECTING RODS & BRGS.	PART NO.	SIZE	DESCRIPTION
6	Rod Pair	FP-9620CPA	STD	
6	Rod Pair	FP-9620CPA10	10	
6	Rod Pair	FP-9620CPA20	20	
6	Rod Pair	FP-9620CPA30	30	

# John Deere Off Highway



44 Windrower H-225 Eng. 3.7L 225 OHV L6, 3.4063" Bore (Chrysler Eng.)				
<b>CYL. HEAD &amp; PARTS</b>				
<b>QTY</b>	<b>VALVE</b>	<b>PART NO.</b>	<b>SIZE</b>	<b>DESCRIPTION</b>
6	Intake	V-1434 Std Only		2 groove; 1.6200" Head Dia., .3725" Stem Dia., 4.7740" O.A.L.
24	Keeper	FP-B367R		2 groove
24	Keeper	VK-66R		2 groove; Hardened
24	Keeper	VK-174		4 groove
24	Keeper	VK-174R		4 groove; Hardened
<b>QTY</b>	<b>VALVE GUIDE</b>	<b>PART NO.</b>	<b>SIZE</b>	<b>DESCRIPTION</b>
6	Guide	VG-5073		Int.; .3745" ID, 2.3750" O.A.L.
<b>QTY</b>	<b>VALVE SPRING</b>	<b>PART NO.</b>	<b>SIZE</b>	<b>DESCRIPTION</b>
12	Spring	VS-510		Exh. & Int.; 2.0000" Free Height
12	Spring Insert	259-103C		.015"; ID 1.030"; Carton of 100
<b>QTY</b>	<b>PUSH RODS</b>	<b>PART NO.</b>	<b>SIZE</b>	<b>DESCRIPTION</b>
12	Push Rod	RP-3036		9.9540" O.A.L.
<b>QTY</b>	<b>VALVE SEAL</b>	<b>PART NO.</b>	<b>SIZE</b>	<b>DESCRIPTION</b>
6	Valve Stem Seal	MV-1918		Exh.; Umbrella type; Viton®
6	Valve Stem Seal	MV-1771C		Int.; Replacement Eng. No. H2254071330; Umbrella type; Polyacrylate
6	Valve Stem Seal Bulk	MV-1771		Int.; Replacement Eng. No. H2254071330; Umbrella type; Carton of 100; Polyacrylate
<b>CAMSHAFT GROUP</b>				
<b>QTY</b>	<b>TIMING</b>	<b>PART NO.</b>	<b>SIZE</b>	<b>DESCRIPTION</b>
1	Timing Chain	222-495		Silent type; 50 Links
1	Crank Sprocket	223-291		Use w/silent type chain; 19 Teeth
<b>QTY</b>	<b>CAMSHAFT/LIFTER</b>	<b>PART NO.</b>	<b>SIZE</b>	<b>DESCRIPTION</b>
1	Camshaft	CS-380		
12	Lifter	AT-2084 Std Only		Dumbbell shaped mech.
12	Lifter, Bulk	AT-2084B Std Only		Dumbbell shaped mech.; Carton of 117
1	Prelube	55-400		4 oz. bottle; 1.5 oz. packet No. 55-403 also avail.
<b>QTY</b>	<b>CAMSHAFT KIT</b>	<b>PART NO.</b>	<b>SIZE</b>	<b>DESCRIPTION</b>
1	Cam/Lifter Kit	KC-380		Dumbbell shaped mech.; Incl. (12) AT-2084, (1) CS-380, (1) 55-403B
<b>ENGINE BLOCK &amp; PARTS</b>				
<b>QTY</b>	<b>GASKET SETS</b>	<b>PART NO.</b>	<b>SIZE</b>	<b>DESCRIPTION</b>
1	Kit Gasket Set	260-1004		Premium valve stem seals incl.
<b>QTY</b>	<b>CAM BEARINGS</b>	<b>PART NO.</b>	<b>SIZE</b>	<b>DESCRIPTION</b>
1	Cam Set	1454M Std Only		
1	Cam Set	1473M Std Only		
<b>CRANKSHAFT/OIL PUMP</b>				
<b>QTY</b>	<b>MAIN BEARINGS</b>	<b>PART NO.</b>	<b>SIZE</b>	<b>DESCRIPTION</b>
1	Main Set	4092M Std-10-20-30		
1	Main Set	5070M Std-10-20-30-40		
<b>QTY</b>	<b>OIL PUMP</b>	<b>PART NO.</b>	<b>SIZE</b>	<b>DESCRIPTION</b>
1	Oil Pump	224-4165C		w/.826" rotor thickness; 5 bolt pump; Will replace early 6 bolt pump
<b>CYLINDER COMPONENTS</b>				
<b>QTY</b>	<b>PISTONS</b>	<b>PART NO.</b>	<b>SIZE</b>	<b>DESCRIPTION</b>
6	Cast Piston	244NP Std-20-30-40-60		Cast; 2-5/64", 1-3/16" Ring Groove, 1.740" CD, .9011" Pin Dia., Flat Head - 8.2:1 C.R.
6	Cast Piston - Individual	W244NP Std-20-30-40-60		Cast; 2-5/64", 1-3/16" Ring Groove, 1.740" CD, .9011" Pin Dia., Flat Head - 8.2:1 C.R.
6	Pin Bushing	2134Y		
<b>QTY</b>	<b>CONNECTING RODS &amp; BRGS.</b>	<b>PART NO.</b>	<b>SIZE</b>	<b>DESCRIPTION</b>
1	Rod Set	6-3695RA Std-10-20-30-40		A-Series aluminum bearings
1	Rod Set	6-2375CP Std-10-20-30-40		6-2375CA 60 avail. as unplated & resizeable
6	Rod Pair	2375CP Std-10-20-30-40		
6	Rod Pair	3695RA Std-1-10-20-30-40		A-Series aluminum bearings

(continued on next page)



# John Deere Off Highway

**Windrower H-225 Eng. 44**  
3.7L 225 OHV L6, 3.4063" Bore (Chrysler Eng.) (cont.)

## CYLINDER COMPONENTS (cont.)

QTY	PISTON RINGS	PART NO.	SIZE	DESCRIPTION
1	Premium Set	<b>E-196K</b> Std-20-30-40-60		2-5/64, 1-3/16
1	Standard Set	<b>E-196X</b> Std-20-30-40-60		2-5/64, 1-3/16
6	Premium Single Cylinder Set	<b>WE-196K</b> Std-20-30-40-60		2-5/64, 1-3/16
6	Standard Single Cylinder Set	<b>WE-196X</b> Std-20-30-40-60		2-5/64, 1-3/16

**Combine OOC Eng. 45**  
3.7L 226 OHV L4, 4" Bore (Hercules Eng.)

## ENGINE BLOCK & PARTS

QTY	CAM BEARINGS	PART NO.	SIZE	DESCRIPTION
1	Cam Set	<b>FP-1090M</b>		

## CYLINDER COMPONENTS

QTY	PISTONS	PART NO.	SIZE	DESCRIPTION
4	Pin Bushing	<b>FP-1424X</b>		Drilled rod type bushing

QTY	CONNECTING RODS & BRGS.	PART NO.	SIZE	DESCRIPTION
4	Rod Pair	<b>FP-1420CP</b>	STD	w/1.9870-1.9880" std. shaft size
4	Rod Pair	<b>FP-1420CP10</b>	10	w/1.9870-1.9880" std. shaft size
4	Rod Pair	<b>FP-1420CP20</b>	20	w/1.9870-1.9880" std. shaft size
4	Rod Pair	<b>FP-1420CP40</b>	40	w/1.9870-1.9880" std. shaft size
4	Rod Pair	<b>FP-3220CP</b>	STD	w/2.1232-2.1240" std. shaft size
4	Rod Pair	<b>FP-3220CP10</b>	10	w/2.1232-2.1240" std. shaft size
4	Rod Pair	<b>FP-3220CP20</b>	20	w/2.1232-2.1240" std. shaft size
4	Rod Pair	<b>FP-3220CP30</b>	30	w/2.1232-2.1240" std. shaft size
4	Rod Pair	<b>3160CP</b> Std-10		w/2.3730-2.3740" std. shaft size

QTY	PISTON RINGS	PART NO.	SIZE	DESCRIPTION
1	Premium Set	<b>FP-920KX</b>		3-1/8, 1-3/16
1	Standard Set	<b>FP-920X</b>		3-1/8, 1-3/16
4	Premium Single Cylinder Set	<b>W-920KX</b> Std Only		3-1/8, 1-3/16
4	Standard Single Cylinder Set	<b>W-920X</b> Std Only		3-1/8, 1-3/16

**Wheel Tractor 227G Eng. Loader Tractor 227G Eng. 46**  
3.7L 227 OHV L4, 4.25" Bore

## CYL. HEAD & PARTS

QTY	VALVE	PART NO.	SIZE	DESCRIPTION
4	Intake	<b>FP-V1635</b>		1.6880" Head Dia., .3720" Stem Dia., 5.7000" O.A.L.
4	Exhaust	<b>FP-V1634</b>		1.5000" Head Dia., .3720" Stem Dia., 5.7310" O.A.L.
16	Keeper	<b>FP-B367R</b>		2 groove
16	Keeper	<b>VK-66R</b>		2 groove; Hardened
QTY	VALVE SEAT	PART NO.	SIZE	DESCRIPTION
4	Int.	<b>FP-R78702</b>	STD	1.7550" OD, 1.5000" ID, .2160" Depth
QTY	VALVE GUIDE	PART NO.	SIZE	DESCRIPTION
8	Guide	<b>FP-VG606</b>		.3750" ID, 2.9400" O.A.L.
QTY	VALVE SEAL	PART NO.	SIZE	DESCRIPTION
8	Valve Stem Seal	<b>ST-2004</b>		Positive type; Installation requires valve guide machining; Rubber/PTFE
8	Valve Stem Seal Bulk	<b>ST-2004BC</b>		Positive type; Installation requires valve guide machining; Carton of 100; Rubber/PTFE

## ENGINE BLOCK & PARTS

QTY	CAM BEARINGS	PART NO.	SIZE	DESCRIPTION
1	Cam Set	<b>FP-3R46903</b>	STD	
3	Cam Brg.	<b>FP-R46903</b>	STD	

## CRANKSHAFT/OIL PUMP

QTY	MAIN BEARINGS	PART NO.	SIZE	DESCRIPTION
1	Main Set	<b>FP-MBK3001</b>	STD	
1	Main Set	<b>FP-MBK300110</b>	10	
1	Main Set	<b>FP-MBK300120</b>	20	
1	Main Set	<b>FP-MBK300130</b>	30	

(continued on next page)

# John Deere Off Highway



## 46 Wheel Tractor 227G Eng. Loader Tractor 227G Eng.

(cont.) 3.7L 227 OHV L4, 4.25" Bore

### CYLINDER COMPONENTS

QTY	LINERS	PART NO.	SIZE	DESCRIPTION
4	Sleeve Assy.	FP-SL2279		
4	Sealing Ring, Liner	FP-112847		
QTY	PISTONS	PART NO.	SIZE	DESCRIPTION
4	Cast Piston	FP-2279P	STD	Cast; 3-3/32", 1-1/4" Ring Groove, 2.6525" CD, 1.2500" Pin Dia., Recessed Head Wedge Shape .470" deep x 3.500" wide - 7.5:1 C.R.; Repl. O.E. Nos. R33372, R34617
4	Pin Bushing	FP-3129YA20		1.252" ID, 1.3785" OD, 1.510" O.A.L.
QTY	CONNECTING RODS & BRGS.	PART NO.	SIZE	DESCRIPTION
4	Rod Pair	FP-AR45723	STD	
4	Rod Pair	FP-AR46396	10	
4	Rod Pair	FP-AR46397	20	
4	Rod Pair	FP-AR46398	30	
QTY	PISTON RINGS	PART NO.	SIZE	DESCRIPTION
4	Ring Set Single Cylinder	FP-W5589KX	STD	Check piston grooving before supplying ring set
2	Premium Set	FP-5589KX	STD	Check piston grooving before supplying ring set; 3-3/32, 1-1/4 (2 cyl. set)

### KITS

QTY	OVERHAUL KIT	PART NO.	SIZE	DESCRIPTION
1	Tractor Overhaul Kit	FP-KST2279A		

## 47 Wheel Tractor 227LP Eng. (LPG). Loader Tractor 227LP Eng. (LPG).

3.7L 227 OHV LPG L4, 4.25" Bore

### CYL. HEAD & PARTS

QTY	VALVE	PART NO.	SIZE	DESCRIPTION
4	Intake	FP-V1635		1.6880" Head Dia., .3720" Stem Dia., 5.7000" O.A.L.
4	Exhaust	FP-V1634		1.5000" Head Dia., .3720" Stem Dia., 5.7310" O.A.L.
16	Keeper	FP-B367R		2 groove
16	Keeper	VK-66R		2 groove; Hardened
QTY	VALVE SEAT	PART NO.	SIZE	DESCRIPTION
4	Int.	FP-R78702	STD	1.7550" OD, 1.5000" ID, .2160" Depth
QTY	VALVE GUIDE	PART NO.	SIZE	DESCRIPTION
8	Guide	FP-VG606		.3750" ID, 2.9400" O.A.L.
QTY	VALVE SEAL	PART NO.	SIZE	DESCRIPTION
8	Valve Stem Seal	ST-2004		Positive type; Installation requires valve guide machining; Rubber/PTFE
8	Valve Stem Seal Bulk	ST-2004BC		Positive type; Installation requires valve guide machining; Carton of 100; Rubber/PTFE

### ENGINE BLOCK & PARTS

QTY	CAM BEARINGS	PART NO.	SIZE	DESCRIPTION
1	Cam Set	FP-3R46903	STD	
3	Cam Brg.	FP-R46903	STD	

### CRANKSHAFT/OIL PUMP

QTY	MAIN BEARINGS	PART NO.	SIZE	DESCRIPTION
1	Main Set	FP-MBK3001	STD	
1	Main Set	FP-MBK300110	10	
1	Main Set	FP-MBK300120	20	
1	Main Set	FP-MBK300130	30	

### CYLINDER COMPONENTS

QTY	LINERS	PART NO.	SIZE	DESCRIPTION
4	Sleeve Assy.	FP-SL2454		
4	Sealing Ring, Liner	FP-112847		
QTY	PISTONS	PART NO.	SIZE	DESCRIPTION
4	Cast Piston	FP-2454P	STD	Cast; 3-3/32", 1-1/4" Ring Groove, 2.655" CD, 1.2500" Pin Dia., Flat Head; Repl. O.E. Nos. R33374, R40778
4	Pin Bushing	FP-3129YA20		1.252" ID, 1.3785" OD, 1.510" O.A.L.
QTY	CONNECTING RODS & BRGS.	PART NO.	SIZE	DESCRIPTION
4	Rod Pair	FP-AR45723	STD	
4	Rod Pair	FP-AR46396	10	
4	Rod Pair	FP-AR46397	20	

(continued on next page)





# John Deere Off Highway

*Wheel Tractor 227LP Eng. (LPG). Loader Tractor 227LP Eng. (LPG). 47*  
3.7L 227 OHV LPG L4, 4.25" Bore (cont.)

### CYLINDER COMPONENTS (cont.)

QTY	CONNECTING RODS & BRGS. (cont.)	PART NO.	SIZE	DESCRIPTION
4	Rod Pair	FP-AR46398	30	
QTY	PISTON RINGS	PART NO.	SIZE	DESCRIPTION
4	Ring Set Single Cylinder	FP-W5589KX	STD	
2	Premium Set	FP-5589KX	STD	3-3/32, 1-1/4 (2 cyl. set)
KITS				
QTY	OVERHAUL KIT	PART NO.	SIZE	DESCRIPTION
1	Tractor Overhaul Kit	FP-KST2454A		

*Combine QXD3 Eng. 48*  
3.8L 230 L-HEAD L6, 3.4375" Bore (Hercules Eng.)

### CYL. HEAD & PARTS

QTY	VALVE	PART NO.	SIZE	DESCRIPTION
6	Intake	FP-V956		1.6410" Head Dia., .3100" Stem Dia., 4.2940" O.A.L.
6	Exhaust	FP-V748		1.4380" Head Dia., .3100" Stem Dia., 4.3320" O.A.L.
24	Keeper	FP-VK123		
QTY	VALVE GUIDE	PART NO.	SIZE	DESCRIPTION
12	Guide	FP-VG456		.532" OD; .3120" ID, 2.0940" O.A.L.
QTY	VALVE SPRING	PART NO.	SIZE	DESCRIPTION
12	Spring	FP-VS286		2.0620" Free Height

### ENGINE BLOCK & PARTS

QTY	CAM BEARINGS	PART NO.	SIZE	DESCRIPTION
1	Cam Set	FP-1142M		

### CRANKSHAFT/OIL PUMP

QTY	MAIN BEARINGS	PART NO.	SIZE	DESCRIPTION
1	Plain Main Brg.	FP-2241CP10	10	Position 1
1	Plain Main Brg.	FP-2241CP20	20	Position 1
1	Plain Main Brg.	FP-2241CP30	30	Position 1
4	Plain Main Brg.	FP-2243CP10	10	Position 2-3-5-6
4	Plain Main Brg.	FP-2243CP20	20	Position 2-3-5-6
4	Plain Main Brg.	FP-2243CP30	30	Position 2-3-5-6
1	Plain Main Brg.	FP-2244CP10	10	Position 4
1	Plain Main Brg.	FP-2244CP20	20	Position 4
1	Plain Main Brg.	FP-2244CP30	30	Position 4
1	Plain Main Brg.	FP-9624CPA10	10	Position 7
1	Plain Main Brg.	FP-9624CPA20	20	Position 7
1	Plain Main Brg.	FP-9624CPA30	30	Position 7

### CYLINDER COMPONENTS

QTY	PISTONS	PART NO.	SIZE	DESCRIPTION
6	Pin Bushing	FP-9624X		Full round bushing
QTY	CONNECTING RODS & BRGS.	PART NO.	SIZE	DESCRIPTION
6	Rod Pair	FP-9620CPA	STD	
6	Rod Pair	FP-9620CPA10	10	
6	Rod Pair	FP-9620CPA20	20	
6	Rod Pair	FP-9620CPA30	30	
QTY	PISTON RINGS	PART NO.	SIZE	DESCRIPTION
1	Premium Set	FP-644KX		Check piston grooving before supplying ring set; 3-1/8, 1-3/16
6	Premium Single Cylinder Set	W-644KX Std Only		Check piston grooving before supplying ring set; 3-1/8, 1-3/16

*Power Unit 232D Eng. 49*  
3.8L 232 OHV Diesel L6, 3.875" Bore

### CRANKSHAFT/OIL PUMP

QTY	SEALS - REAR CRANK	PART NO.	SIZE	DESCRIPTION
1	Crankshaft Rear Seal	FP-RE24959		

### CYLINDER COMPONENTS

QTY	PISTONS	PART NO.	SIZE	DESCRIPTION
6	Pin Bushing	FP-2599Y20		

(continued on next page)

**49 Power Unit 232D Eng.**  
(cont.) 3.8L 232 OHV Diesel L6, 3.875" Bore

**CYLINDER COMPONENTS (cont.)**

QTY	CONNECTING RODS & BRGS.	PART NO.	SIZE	DESCRIPTION
6	Rod Pair	FP-2595A	STD	A-Series aluminum bearings
6	Rod Pair	FP-2595A10	10	A-Series aluminum bearings
6	Rod Pair	FP-2595A20	20	A-Series aluminum bearings
6	Rod Pair	FP-2595A30	30	A-Series aluminum bearings

**50 Forklift 4239D Eng. Wheel Tractor 4239D Eng. Windrower 4239D Eng. Crawler Tractor 4239D Eng. Loader Tractor 4239D Eng. Excavator 4239D Eng. Backhoe 4239D Eng. Sprayer 4239D Eng.**  
3.9L 239 OHV Diesel L4 (Standard), 4.1875" Bore

**CYL. HEAD & PARTS**

QTY	GASKETS	PART NO.	SIZE	DESCRIPTION
1	Valve Cover Gasket	FP-R73521		w/Stamped Steel Cover; Rocker arm cover codes 1101, 1102, 1106; From Ser. No. 539,557
1	Head Gasket	FP-R125863		From Ser. No. 300,000
1	Head Set	FP-RE38851		From Ser. No. 300,000

QTY	VALVE	PART NO.	SIZE	DESCRIPTION
4	Intake	FP-R79623	STD	2 groove; Chrome plated stem; 1.7720" Head Dia., .3720" Stem Dia., 5.1560" O.A.L.
4	Intake	FP-R79628	3	2 groove; Chrome plated stem; 1.7720" Head Dia., .3750" Stem Dia., 5.1560" O.A.L.
4	Intake	FP-R79629	15	2 groove; Chrome plated stem; 1.7720" Head Dia., .3870" Stem Dia., 5.1560" O.A.L.
4	Intake	FP-R79630	30	2 groove; Chrome plated stem; 1.7720" Head Dia., .4020" Stem Dia., 5.1560" O.A.L.
4	Exhaust	FP-R79624	STD	1 groove; Chrome plated stem; 1.5750" Head Dia., .3720" Stem Dia., 5.1560" O.A.L.
4	Exhaust	FP-R79625	3	1 groove; Chrome plated stem; 1.5750" Head Dia., .3750" Stem Dia., 5.1560" O.A.L.
4	Exhaust	FP-R79626	15	1 groove; Chrome plated stem; 1.5750" Head Dia., .3870" Stem Dia., 5.1560" O.A.L.
4	Exhaust	FP-R79627	30	1 groove; Chrome plated stem; 1.5750" Head Dia., .4020" Stem Dia., 5.1560" O.A.L.
4	Exhaust	FP-R90692	STD	1 groove; Chrome plated stem; 1.6730" Head Dia., .3095" Stem Dia., 5.2550" O.A.L.
16	Keeper	FP-T20077		Valve, seat, spring & retainer code 5101; 1 groove; Square cut key groove; Hardened
16	Keeper	FP-41339		1 groove; Square cut key groove
16	Keeper, Bulk	VK-138B		1 groove; Square cut key groove; Carton of 1000

QTY	VALVE SEAT	PART NO.	SIZE	DESCRIPTION
4	Exh.	FP-R51734	STD	
4	Int.	FP-R73064	STD	

QTY	VALVE SPRING	PART NO.	SIZE	DESCRIPTION
8	Spring	FP-R26125		2.1200" Free Height

QTY	VALVE MISC.	PART NO.	SIZE	DESCRIPTION
8	Rotocap	FP-RE11410		Exh. & Int.; Valve, seat, spring & retainer code 5101
1	Bushing	FP-T26321		Lower
1	Bushing	FP-T20034		Upper
1	Oil Filler Cap Gasket	FP-R80135		Oil filler neck code 1201, 1202, 1203; L.H. Auxiliary drive

QTY	VALVE SEAL	PART NO.	SIZE	DESCRIPTION
8	Valve Stem Seal	FP-R87627		Exh. & Int.; O-Ring type

QTY	ROCKER PARTS	PART NO.	SIZE	DESCRIPTION
1	O-Ring	FP-R56463		Rocker cover breather tube; Breather tube code 2901 R.H.; Codes 2902, 2903 L.H.; Codes 2905, 2909, 2911, 2915, 2999

**ELECTRICAL**

QTY	ELECTRICAL	PART NO.	SIZE	DESCRIPTION
1	Starter to Block Gasket	FP-R53108		3-Hole mount; Starting motor codes 3001, 3013, 3017, 3018

QTY	ALTERNATOR	PART NO.	SIZE	DESCRIPTION
1	Ball Brg.	FP-JD9449		Front; Motorola No. A12NJD604; Code 3102; 12 Volt, 35 amp alternator
1	Ball Brg.	FP-JD9449		Front; Motorola No. 70D44110C01; Code 3102; 12 Volt, 55 amp alternator
1	Ball Brg.	FP-JD9449		Front; Motorola No. 70D44120C01; Code 3101; 12 Volt, 35 amp alternator

(continued on next page)



# John Deere Off Highway

Forklift 4239D Eng. Wheel Tractor 4239D Eng. Windrower 4239D Eng. Crawler Tractor 50  
 4239D Eng. Loader Tractor 4239D Eng. Excavator 4239D Eng. Backhoe 4239D Eng. (cont.)  
 Sprayer 4239D Eng.  
 3.9L 239 OHV Diesel L4 (Standard), 4.1875" Bore

ELECTRICAL (cont.)				
QTY	ALTERNATOR (cont.)	PART NO.	SIZE	DESCRIPTION
1	Ball Brg.	FP-JD9449		Front; Motorola No. 8TA2009S; Code 3104; 12 Volt, 30 amp alternator
2	Ball Brg.	FP-JD9449		Front & Rear; Motorola No. 70D42076T02; Codes 3101, 3104, 3108, 3109, 3116, 3129, 3130; 12 Volt, 65 amp alternator
INT & EXH MANIFOLDS				
QTY	INT. & EXH. MANIFOLDS	PART NO.	SIZE	DESCRIPTION
4	Exhaust Manifold Gasket	FP-R90658		
1	Air Intake Gasket	FP-R81275		
CAMSHAFT GROUP				
QTY	TIMING COVER	PART NO.	SIZE	DESCRIPTION
1	Timing Gear Cover Gasket	FP-T20273		Access cover
1	Timing Gear Cover Gasket	FP-R97454		Front cover
QTY	CAMSHAFT/LIFTER	PART NO.	SIZE	DESCRIPTION
8	Lifter	FP-T20073		
FUEL SYSTEM & PARTS				
QTY	FUEL INJECTION	PART NO.	SIZE	DESCRIPTION
1	Injector Pump Gasket	FP-R125066		Gear cover
4	Fuel Injector Nozzle	FP-AR89564		Injector nozzle code 1602, 1603
4	Fuel Injector Seal	FP-R79605		Fuel line connection; Nozzle codes 1602, 1603, 1617, 1623, 1641, 1645, 1646; Nozzle marked 27333; 9.270MM X 13.600MM X 5.080MM
8	Washer	FP-T20055		Pump code 1602
4	Fuel Injector Nut	FP-R79604		w/Injector marked 22043, 22203, 27333; From Ser. No. 410,664
2	Clamp	FP-R34766		Pump code 3701
8	Washer Type Seal	FP-R51936		Leak-off & return line seals; Nozzle codes 1602, 1603, 1617, 1619, 1623, 1624, 1641, 1645, 1646; w/Nozzle marked 22043, 27333
4	Washer Type Seal	FP-R48000		Lower; w/Nozzle codes 1602, 1603, 1617, 1623, 1641, 1645, 1646
4	Washer Type Seal	FP-R60746		Upper; Nozzle codes 1602, 1603, 1617, 1623, 1641, 1645, 1646
QTY	FUEL FILTERS & PUMP	PART NO.	SIZE	DESCRIPTION
1	Mechanical Fuel Pump	FP-RE42211		Transfer pump
1	Injector Pump Mount Gasket	FP-R97354		w/Roto-Diesel fuel pump
1	Fuel Transfer Pump Gasket	FP-R97350		
COOLING SYSTEM				
QTY	WATER PUMP	PART NO.	SIZE	DESCRIPTION
1	Water Pump Impeller	FP-R47191		w/Pump housing marked R66420, R68733
1	Water Pump Impeller	FP-R94419		Pump codes 2004, 2021; w/Pump housing marked R73604, R100871, R111028
1	Water Pump Impeller	FP-R94419		Pump codes 2005, 2022; w/Pump housing marked R55164
1	Water Pump Repair/Rebuild Kit	FP-944840979		w/Pump housing marked R52009
1	Water Pump Repair/Rebuild Kit	FP-925740979		w/Pump housing marked R56787, R62902
1	Water Pump Repair/Rebuild Kit	FP-RE62661		w/Pump housing marked R66420, R68733
1	Water Pump Housing Gasket	FP-R55406		w/Pump housing marked R55130
1	Water Pump Housing Gasket	FP-R56809		w/Pump housing marked R55164; Pump code 2004
1	Water Pump Housing Gasket	FP-R55405		w/Pump housing marked R55164; Pump code 2005
1	Water Pump Housing Gasket	FP-R97455		w/Pump housing marked R55758, R73604, R100871, R111028
1	Oil Seal Kit	FP-AR101549		Water Pump; w/Pump housing marked R100871, R111028, R55164, R55758, R73604
1	Water Pump Mounting Gasket	FP-T20243		w/Pump housing marked R55130, R55164, R55758, R73604, R100871, R111028
1	Shaft & Bearing Assembly	FP-JD9448		w/Cast pulley; w/Pump housing marked R55164
1	Shaft & Bearing Assembly	FP-JD9257		w/Pump housing marked R55164, R55758, R73604, R100871, R111028
QTY	THERMOSTAT	PART NO.	SIZE	DESCRIPTION
1	Thermostat	FP-RE33705		Thermostat code 2204; Housing code marked R60256; 180 Deg.
1	Thermostat Gasket	FP-T20219		Single thermostat cover codes 2101, 2102, 2204, 3901
1	Thermostat Cover Gasket	FP-T20215		Single thermostat cover codes 2101, 2102, 2204, 3901
2	O-Ring	FP-R56461		Thermostat housing tube seals

(continued on next page)

**50** *Forklift 4239D Eng. Wheel Tractor 4239D Eng. Windrower 4239D Eng. Crawler Tractor*  
 (cont.) *4239D Eng. Loader Tractor 4239D Eng. Excavator 4239D Eng. Backhoe 4239D Eng.*  
*Sprayer 4239D Eng.*  
 3.9L 239 OHV Diesel L4 (Standard), 4.1875" Bore

ENGINE BLOCK & PARTS				
QTY	GASKETS	PART NO.	SIZE	DESCRIPTION
1	Flywheel Housing Gasket	FP-R97351		Flywheel housing codes 1404, 1405, 1410, 1418, 1421, 1423, 1425
1	Oil Pan Gasket	FP-R119360		w/Sheet metal pan; Oil pan codes 1901, 1902, 1903; w/Cast iron oil pan
1	Oil Pan Gasket	FP-R97342		w/Stamped Steel Pan
1	Block to End Plate Front Gskt	FP-R131794		Front plate codes 3601, 3602
QTY	GASKET SETS	PART NO.	SIZE	DESCRIPTION
1	Gasket Conversion Set	FP-PG219CS		Wear sleeve incl.
1	In-Frame Gasket Set	FP-PG219S		
1	Complete Overhaul Gasket Set	FP-RE38857		Crankshaft seals not incl.
1	Complete Overhaul Gasket Set	FP-RE38857WS		Incl. crankshaft seals; Rear main brg. seal incl.; Wear sleeve not incl.
1	Kit Gasket Set	260-1392		Compl.; Rear main brg. seal incl.; Wear sleeve incl.
QTY	CAM BEARINGS	PART NO.	SIZE	DESCRIPTION
6	Cam Brg.	FP-R91708		Cyl. block codes 4601, 4602; 2.0MM O/S OD; Balance shaft bushing
QTY	ENGINE BEARING MISC.	PART NO.	SIZE	DESCRIPTION
1	Bal. Shaft Set	FP-R57160S		
6	Balance Shaft Bearing	FP-R57160		
QTY	OIL COOLERS & FILTERS	PART NO.	SIZE	DESCRIPTION
1	Washer	FP-R105714		Oil cooler; Modine Oil Cooler codes 5904, 5906, 5907; To Ser. No. 794,193
1	Rect. or Square Seal	FP-R70956		Cooler housing; Cooler code 5906; Water pump codes 2004, 2021; From Ser. No. 498,386 to Ser. No. 794,193; 2.700" X 3.000" X .180"
1	Rect. or Square Seal	FP-R70956		Cooler housing; Cooler codes 5904, 5906; Water pump codes 2004, 2021; From Ser. No. 794,194; 2.700" X 3.000" X .180"
1	Rect. or Square Seal	FP-R70956		Cooler housing; Cooler codes 5905, 5906; Water pump codes 2004, 2005; To Ser. No. 498,385; 2.700" X 3.000" X .180"
CRANKSHAFT/OIL PUMP				
QTY	CRANKSHAFT	PART NO.	SIZE	DESCRIPTION
1	Crankshaft	FP-RE20585		From Ser. No. 769,620
1	Crankshaft	FP-AT18030		To Ser. No. 769,619
1	Oil Seal Kit	FP-SK67942		Incl. front & rear seals; Crankshaft codes 4701, 4702; Crankshaft marked R81959; From Ser. No. 769,620
1	Oil Seal Kit	FP-SK67942		Incl. front & rear seals; Crankshaft codes 4701, 4702; Crankshaft marked T23517; To Ser. No. 769,619
QTY	SEALS - FRONT CRANK	PART NO.	SIZE	DESCRIPTION
1	Crankshaft Front Seal	FP-AR67942		
1	O-Ring	FP-H35244		Crankshaft pulley; Crankshaft, Bearing codes 4701, 4702
QTY	SEALS - REAR CRANK	PART NO.	SIZE	DESCRIPTION
1	Crankshaft Rear Seal	FP-RE24959		Crankshaft, Bearing codes 4701, 4702; Flywheel housing codes 1403, 1404, 1405, 1410, 1421, 1425, 1432
QTY	MAIN BEARINGS	PART NO.	SIZE	DESCRIPTION
1	Main Set	FP-MBK3004	STD	w/Flanged thrust brg.
1	Main Set	FP-MBK300410	10	w/Flanged thrust brg.
1	Main Set	FP-MBK300420	20	w/Flanged thrust brg.
1	Main Set	FP-MBK300430	30	w/Flanged thrust brg.
4	Plain Main Brg.	FP-RE27352	STD	w/Flangeless thrust brg.
4	Plain Main Brg.	FP-RE27353	10	w/Flangeless thrust brg.
4	Plain Main Brg.	FP-RE27360	20	w/Flangeless thrust brg.
4	Plain Main Brg.	FP-RE27368	30	w/Flangeless thrust brg.
1	Flanged Main Brg.	FP-RE521350	STD	
1	Flanged Main Brg.	FP-RE526754	10	
1	Flanged Main Brg.	FP-RE527235	20	
1	Flanged Main Brg.	FP-RE527236	30	
4	Thrust Washer	FP-R78598	STD	
QTY	OIL PUMP	PART NO.	SIZE	DESCRIPTION
1	Pump Repair Kit	FP-RE55343		Pump code 5001; w/Pump housing marked R54615
1	O-Ring	FP-R61871		Oil pump inlet; Pump codes 5001, 5002
1	O-Ring	FP-R74354		Oil pump outlet tube; Pump codes 5001, 5002; w/Pump housing marked R54615
1	Oil Filler Inlet Gasket	FP-R97352		Oil filler neck codes 1201, 1203, 1299

(continued on next page)



# John Deere Off Highway

Forklift 4239D Eng. Wheel Tractor 4239D Eng. Windrower 4239D Eng. Crawler Tractor 50  
 4239D Eng. Loader Tractor 4239D Eng. Excavator 4239D Eng. Backhoe 4239D Eng. (cont.)  
 Sprayer 4239D Eng.  
 3.9L 239 OHV Diesel L4 (Standard), 4.1875" Bore

## CRANKSHAFT/OIL PUMP (cont.)

QTY	OIL PUMP (cont.)	PART NO.	SIZE	DESCRIPTION
1	Oil Filler Inlet Gasket	FP-R97352		Oil filler neck codes 1202, 1206; To Ser. No. 703,963

## CYLINDER COMPONENTS

QTY	LINERS	PART NO.	SIZE	DESCRIPTION
4	Liner w/o Sealing Ring	FP-R116281		
4	Liner w/Sealing Rings	FP-RE500023		
4	Cylinder Kit Complete	FP-RE30250	STD	w/Con. Rod marked R51727, R80034
4	Cyl. Liner Sealing Ring Kit	FP-AR65507		
4	Sealing Ring, Liner	FP-R48767		Rectangle; Top
4	Sealing Ring	FP-SLR2520		Round; Bottom

QTY	PISTONS	PART NO.	SIZE	DESCRIPTION
4	Piston Body w/o Pin	FP-RE19282		
4	Piston Kit w/Pin & Retainers	FP-RE19282WP		
4	Pin	FP-R125754		1.38" pin dia.
8	Piston Pin Retainer	FP-M41029		For 1.38" pin dia.
4	Pin Bushing	FP-R55647		w/Con. Rod marked R51727, R80032, R80034, R80032; 1.3765" ID, 1.500" OD, 1.570" O.A.L.

QTY	CONNECTING RODS & BRGS.	PART NO.	SIZE	DESCRIPTION
8	Con. Rod Bolt	FP-R80033		w/Con. Rod marked R80032, R80034, R81410, R105011, R113612; Torque-To-Yield bolt; Replacement recommended
8	Con. Rod Bolt	FP-R74194		w/Con. Rod marked T20007, R51727, R58979; Torque-To-Yield bolt; Replacement recommended
4	Rod Pair	FP-RE27348	STD	
4	Rod Pair	FP-RE27349	10	
4	Rod Pair	FP-RE27358	20	
4	Rod Pair	FP-RE27364	30	

QTY	PISTON RINGS	PART NO.	SIZE	DESCRIPTION
4	Ring Set Single Cylinder	FP-RE507852	STD	1-1/8, 1-3/32, 1-.136 (1 cyl. set)
4	Ring Set Single Cylinder	FP-RE66820	STD	1-1/8, 1-3/32, 1-.136 (1 cyl. set)

## KITS

QTY	OVERHAUL KIT	PART NO.	SIZE	DESCRIPTION
1	In-Frame Overhaul Kit	FP-239DIFK		w/Con. Rod marked R51727, R80032, R80034
1	Complete Overhaul Kit	FP-239DOHK		w/Con. Rod marked R51727, R80032, R80034; Incl. front & rear seals; Crankshaft codes 4701, 4702; Crankshaft marked R81959 from Ser. No. 769,620; Incl. Torque-To-Yield con. rod bolts
1	Complete Overhaul Kit	FP-239DOHK		w/Con. Rod marked R51727, R80032, R80034; Incl. front & rear seals; Crankshaft codes 4701, 4702; Crankshaft marked T23517 to Ser. No. 769,619; Incl. Torque-To-Yield con. rod bolts

Wheel Tractor 4239T Eng. Windrower 4239T Eng. Loader Tractor 4239T Eng. Excavator 51  
 4239T Eng. Backhoe 4239T Eng.  
 3.9L 239 OHV Turbo-Diesel L4 (Standard), 4.1875" Bore

## CYL. HEAD & PARTS

QTY	GASKETS	PART NO.	SIZE	DESCRIPTION
1	Valve Cover Gasket	FP-R73521		w/Stamped Steel Cover; Rocker arm cover codes 1101, 1102, 1106
1	Head Gasket	FP-R125863		
1	Head Set	FP-RE38851		

QTY	VALVE	PART NO.	SIZE	DESCRIPTION
4	Intake	FP-R83071	STD	Stellite; 2 groove; Chrome plated stem; 1.8210" Head Dia., .3720" Stem Dia., 5.1660" O.A.L.
4	Intake	FP-R89223	3	Stellite; 2 groove; Chrome plated stem; 1.8210" Head Dia., .3750" Stem Dia., 5.1660" O.A.L.
4	Intake	FP-R89224	15	Stellite; 2 groove; Chrome plated stem; 1.8210" Head Dia., .3870" Stem Dia., 5.1660" O.A.L.
4	Intake	FP-R79623	STD	2 groove; Chrome plated stem; 1.7720" Head Dia., .3720" Stem Dia., 5.1560" O.A.L.
4	Intake	FP-R79628	3	2 groove; Chrome plated stem; 1.7720" Head Dia., .3750" Stem Dia., 5.1560" O.A.L.
4	Intake	FP-R79629	15	2 groove; Chrome plated stem; 1.7720" Head Dia., .3870" Stem Dia., 5.1560" O.A.L.

(continued on next page)

**51** Wheel Tractor 4239T Eng. Windrower 4239T Eng. Loader Tractor 4239T Eng. Excavator  
 (cont.) 4239T Eng. Backhoe 4239T Eng.  
 3.9L 239 OHV Turbo-Diesel L4 (Standard), 4.1875" Bore

CYL. HEAD & PARTS (cont.)				
QTY	VALVE (cont.)	PART NO.	SIZE	DESCRIPTION
4	Intake	FP-R79630	30	2 groove; Chrome plated stem; 1.7720" Head Dia., .4020" Stem Dia., 5.1560" O.A.L.
4	Exhaust	FP-R79624	STD	1 groove; Chrome plated stem; 1.5750" Head Dia., .3720" Stem Dia., 5.1560" O.A.L.
4	Exhaust	FP-R79625	3	1 groove; Chrome plated stem; 1.5750" Head Dia., .3750" Stem Dia., 5.1560" O.A.L.
4	Exhaust	FP-R79626	15	1 groove; Chrome plated stem; 1.5750" Head Dia., .3870" Stem Dia., 5.1560" O.A.L.
4	Exhaust	FP-R79627	30	1 groove; Chrome plated stem; 1.5750" Head Dia., .4020" Stem Dia., 5.1560" O.A.L.
16	Keeper	FP-T20077		Valve, seat, spring & retainer code 5102; 1 groove; Square cut key groove; Hardened
16	Keeper	FP-41339		1 groove; Square cut key groove
16	Keeper, Bulk	VK-138B		1 groove; Square cut key groove; Carton of 1000
QTY	VALVE SEAT	PART NO.	SIZE	DESCRIPTION
4	Exh.	FP-R51734	STD	
4	Int.	FP-R73064	STD	
QTY	VALVE SPRING	PART NO.	SIZE	DESCRIPTION
8	Spring	FP-R26125		2.1200" Free Height
QTY	VALVE MISC.	PART NO.	SIZE	DESCRIPTION
8	Rotocap	FP-RE11410		Exh. & Int.; Valve, seat, spring & retainer code 5102
1	Bushing	FP-T26321		Lower
1	Bushing	FP-T20034		Upper
1	Oil Filler Cap Gasket	FP-T20328		Rocker arm cover code 1201, 1202, 1203
QTY	VALVE SEAL	PART NO.	SIZE	DESCRIPTION
8	Valve Stem Seal	FP-R87627		Exh. & Int.; O-Ring type
QTY	ROCKER PARTS	PART NO.	SIZE	DESCRIPTION
1	O-Ring	FP-R56463		Aftercooled; Rocker cover breather tube; Breather tube code 2901 R.H.; Code 2902 flexible; Code 2903 L.H.; Fitting seal
1	O-Ring	FP-R56463		Rocker cover breather tube; Breather tube code 2901 flexible; Fitting seal
ELECTRICAL				
QTY	ELECTRICAL	PART NO.	SIZE	DESCRIPTION
1	Starter to Block Gasket	FP-R53108		3-Hole mount; Starting motor codes 3001, 3013, 3017, 3018
QTY	ALTERNATOR	PART NO.	SIZE	DESCRIPTION
1	Ball Brg.	FP-JD9449		Front; Motorola No. A12NJD453; Code 3102; 12 Volt, 35 amp alternator
1	Ball Brg.	FP-JD9449		Front; Motorola No. 70D44110C01; 12 Volt, 55 amp alternator
1	Ball Brg.	FP-JD9449		Front; Motorola No. 70D44120C01; Code 3101; 12 Volt, 35 amp alternator
1	Ball Brg.	FP-JD9449		Front; Motorola No. 8TA2009S; Code 3104; 12 Volt, 55 amp alternator
2	Ball Brg.	FP-JD9449		Front & Rear; Motorola No. 70D42076T02; Code 3104; 12 Volt, 65 amp alternator
2	Ball Brg.	FP-JD9449		Front & Rear; Motorola No. 70D42076T02; Codes 3101, 3108, 3109, 3116, 3129, 3130; 65 amp alternator
INT & EXH MANIFOLDS				
QTY	INT. & EXH. MANIFOLDS	PART NO.	SIZE	DESCRIPTION
4	Exhaust Manifold Gasket	FP-R90658		
1	Air Intake Gasket	FP-R81275		
CAMSHAFT GROUP				
QTY	TIMING COVER	PART NO.	SIZE	DESCRIPTION
1	Timing Gear Cover Gasket	FP-T20273		Access cover
1	Timing Gear Cover Gasket	FP-R97454		Front cover
QTY	CAMSHAFT/LIFTER	PART NO.	SIZE	DESCRIPTION
8	Lifter	FP-T20073		
FUEL SYSTEM & PARTS				
QTY	FUEL INJECTION	PART NO.	SIZE	DESCRIPTION
1	Injector Pump Gasket	FP-R125066		Gear cover
4	Fuel Injector Seal	FP-R79605		Fuel line connection; Nozzle codes 1602, 1603, 1606, 1623, 1635, 1636, 1641, 1643, 1650, 1651; From Ser. No. 410,664; 9.270MM X 13.600MM X 5.080MM

(continued on next page)



# John Deere Off Highway

Wheel Tractor 4239T Eng. Windrower 4239T Eng. Loader Tractor 4239T Eng. Excavator 51  
 4239T Eng. Backhoe 4239T Eng. (cont.)  
 3.9L 239 OHV Turbo-Diesel L4 (Standard), 4.1875" Bore

## FUEL SYSTEM & PARTS (cont.)

QTY	FUEL INJECTION (cont.)	PART NO.	SIZE	DESCRIPTION
4	Fuel Injector Seal	FP-R92352		Upper packing; w/Injector nozzle codes 1601, 1603
4	Fuel Injector Nut	FP-R79604		w/Injector marked 22265, 26992, 26993, 27337; From Ser. No. 410,664
2	Clamp	FP-R34766		Pump code 3701
8	Washer Type Seal	FP-R51936		Leak-off & return line seals; Nozzle codes 1602, 1603, 1606, 1619, 1623, 1624, 1635, 1636, 1641, 1643, 1650, 1651; w/Nozzle marked 26992, 27337
4	Washer Type Seal	FP-R48000		Lower; w/Nozzle codes 1602, 1603, 1606, 1623, 1635, 1636, 1641, 1643, 1650, 1651
4	Washer Type Seal	FP-R60746		Upper; Nozzle codes 1602, 1603, 1606, 1623, 1635, 1636, 1641, 1643, 1650, 1651

QTY	FUEL FILTERS & PUMP	PART NO.	SIZE	DESCRIPTION
1	Mechanical Fuel Pump	FP-RE42211		Transfer pump
1	Injector Pump Mount Gasket	FP-R97354		w/Roto-Diesel fuel pump
1	Fuel Transfer Pump Gasket	FP-R97350		

QTY	TURBOCHARGER	PART NO.	SIZE	DESCRIPTION
1	Turbocharger Oil Drain Gasket	FP-R105346		
1	Turbocharger Mounting Gasket	FP-R89879		Exc. Low profile turbocharger
1	Turbocharger Oil Supply Gskt.	FP-R97348		Turbo code 6501

## COOLING SYSTEM

QTY	WATER PUMP	PART NO.	SIZE	DESCRIPTION
1	Water Pump Impeller	FP-R47191		w/Pump housing marked R66420, R68733
1	Water Pump Impeller	FP-R56812		w/Pump housing marked R70612, R90783, R90785
1	Water Pump Impeller	FP-R94419		Pump codes 2005, 2022; w/Pump housing marked R55164
1	Water Pump Impeller	FP-R94419		Pump codes 2021, 2026; w/Pump housing marked R73604, R100871, R111028
1	Water Pump Repair/Rebuild Kit	FP-864340979		w/Pump housing marked R51661, R73606, R73724, R79171
1	Water Pump Repair/Rebuild Kit	FP-944840979		w/Pump housing marked R52009
1	Water Pump Repair/Rebuild Kit	FP-925740979		w/Pump housing marked R56787, R62902
1	Water Pump Repair/Rebuild Kit	FP-RE62661		w/Pump housing marked R66420, R68733
1	Water Pump Housing Gasket	FP-R55406		w/Pump housing marked R55130
1	Water Pump Housing Gasket	FP-R55405		w/Pump housing marked R55164
1	Water Pump Housing Gasket	FP-R56809		w/Pump housing marked R70612, R90783, R90785
1	Water Pump Housing Gasket	FP-R97455		w/Pump housing marked R73604, R100871, R111028
1	Water Pump Housing Gasket	FP-R56809		w/Pump housing marked R85023, R99251
1	Oil Seal Kit	FP-AR101549		Water Pump; w/Pump housing marked R55164, R90783
1	Water Pump Mounting Gasket	FP-T20243		w/Pump housing marked R55130, R55164, R56070, R56813, R70612, R73604, R85023, R90783, R90785, R99251, R100871, R111028
1	Shaft & Bearing Assembly	FP-JD9257		w/Pump housing marked R55164, R55758, R73604, R100871, R111028
1	Shaft & Bearing Assembly	FP-JD8643		w/Pump housing marked R70612, R90783, R90785

QTY	THERMOSTAT	PART NO.	SIZE	DESCRIPTION
2	Thermostat	FP-AR48675		Thermostat code 2204; Thermostat cover code 2102 Vertical, 2108 Horizontal; Housing code 3901; 180 Deg.
1	Thermostat	FP-RE33705		Thermostat code 2208; Housing marked R60256; 180 Deg.
1	Thermostat Gasket	FP-T20219		Single thermostat cover codes 2101, 2109, 2208, 3906
1	Thermostat Cover Gasket	FP-T20215		Single thermostat cover codes 2101, 2109, 2208, 3906; w/housing marked R60256, T20218
1	Therm. Hsg. - Water Mfld. Gsk	FP-R54641		Thermostat housing to cyl. head
2	O-Ring	FP-R56461		Thermostat housing tube seals; Housing code 3901

QTY	MISCELLANEOUS	PART NO.	SIZE	DESCRIPTION
2	Water Line Gasket	FP-R97346		

## ENGINE BLOCK & PARTS

QTY	GASKETS	PART NO.	SIZE	DESCRIPTION
1	Flywheel Housing Gasket	FP-R97351		Flywheel housing codes 1404, 1405, 1410, 1418, 1421, 1423, 1425
1	Oil Pan Gasket	FP-R97342		w/Stamped Steel Pan
1	Block to End Plate Front Gskt	FP-R131794		Front plate codes 3601, 3602

QTY	GASKET SETS	PART NO.	SIZE	DESCRIPTION
1	Gasket Conversion Set	FP-PG219CS		Wear sleeve incl.
1	In-Frame Gasket Set	FP-PG219S		
1	Complete Overhaul Gasket Set	FP-RE38857		Crankshaft seals not incl.
1	Complete Overhaul Gasket Set	FP-RE38857WS		Incl. crankshaft seals; Rear main brg. seal incl.; Wear sleeve not incl.

(continued on next page)

**51** Wheel Tractor 4239T Eng. Windrower 4239T Eng. Loader Tractor 4239T Eng. Excavator  
 (cont.) 4239T Eng. Backhoe 4239T Eng.  
 3.9L 239 OHV Turbo-Diesel L4 (Standard), 4.1875" Bore

ENGINE BLOCK & PARTS (cont.)				
QTY	GASKET SETS (cont.)	PART NO.	SIZE	DESCRIPTION
1	Kit Gasket Set	260-1392		Compl.; Rear main brg. seal incl.; Wear sleeve incl.
QTY	CAM BEARINGS	PART NO.	SIZE	DESCRIPTION
6	Cam Brg.	FP-R91708		Cyl. block codes 4601, 4602; 2.0MM O/S OD; Balance shaft bushing
QTY	ENGINE BEARING MISC.	PART NO.	SIZE	DESCRIPTION
1	Bal. Shaft Set	FP-R57160S		
6	Balance Shaft Bearing	FP-R57160		
QTY	OIL COOLERS & FILTERS	PART NO.	SIZE	DESCRIPTION
1	Aftercooler Gasket Set	FP-4039A		
1	Oil Cooler	FP-RE61767		RePower Engs. DD14964, DD14965; w/Cooler codes 5904, 5906, 5908, 5914, 5916, 5995; w/6 plates; From Ser. No. 185,224
1	Washer	FP-R105714		Oil cooler; w/10 plate cooler; To Ser. No. 795,106
1	Washer	FP-R105714		Oil cooler; Oil Cooler codes 5904, 5905, 5906, 5907; To Ser. No. 794,193
1	Rect. or Square Seal	FP-R70956		Cooler housing; Cooler code 5906; Water pump code 2026; From Ser. No. 794,194; 2.700" X 3.000" X .180"
1	Rect. or Square Seal	FP-R70956		Cooler housing; Cooler code 5907; Water pump codes 2004, 2023; 2.700" X 3.000" X .180"
1	Rect. or Square Seal	FP-R70956		Cooler housing; Cooler codes 5904, 5905, 5906; Water pump codes 2004, 2005; To Ser. No. 498,385; 2.700" X 3.000" X .180"
1	Rect. or Square Seal	FP-R70956		Cooler housing; Cooler codes 5904, 5906; Water pump codes 2023, 2026; From Ser. No. 498,386 Ser. No. to 794,193; 2.700" X 3.000" X .180"
CRANKSHAFT/OIL PUMP				
QTY	CRANKSHAFT	PART NO.	SIZE	DESCRIPTION
1	Crankshaft	FP-RE20585		From Ser. No. 769,620
1	Crankshaft	FP-AT18030		To Ser. No. 769,619
1	Oil Seal Kit	FP-SK67942		Incl. front & rear seals; Crankshaft codes 4701, 4702; Crankshaft marked R81959; From Ser. No. 769,620
1	Oil Seal Kit	FP-SK67942		Incl. front & rear seals; Crankshaft codes 4701, 4702; Crankshaft marked T23517; To Ser. No. 769,619
QTY	SEALS - FRONT CRANK	PART NO.	SIZE	DESCRIPTION
1	Crankshaft Front Seal	FP-AR67942		
1	O-Ring	FP-H35244		Crankshaft pulley; Pulley codes 1301, 1307, 1315; Crankshaft, Bearing codes 4701, 4702
QTY	SEALS - REAR CRANK	PART NO.	SIZE	DESCRIPTION
1	Oil Seal	39952		
1	Crankshaft Rear Seal	FP-RE24959		Crankshaft, Bearing codes 4701, 4702; Flywheel housing codes 1403, 1404, 1405, 1410, 1421, 1425, 1432
QTY	MAIN BEARINGS	PART NO.	SIZE	DESCRIPTION
1	Main Set	FP-MBK3004	STD	w/Flanged thrust brg.
1	Main Set	FP-MBK300410	10	w/Flanged thrust brg.
1	Main Set	FP-MBK300420	20	w/Flanged thrust brg.
1	Main Set	FP-MBK300430	30	w/Flanged thrust brg.
4	Plain Main Brg.	FP-RE27352	STD	w/Flangeless thrust brg.
4	Plain Main Brg.	FP-RE27353	10	w/Flangeless thrust brg.
4	Plain Main Brg.	FP-RE27360	20	w/Flangeless thrust brg.
4	Plain Main Brg.	FP-RE27368	30	w/Flangeless thrust brg.
1	Flanged Main Brg.	FP-RE521350	STD	
1	Flanged Main Brg.	FP-RE526754	10	
1	Flanged Main Brg.	FP-RE527235	20	
1	Flanged Main Brg.	FP-RE527236	30	
4	Thrust Washer	FP-R78598	STD	
QTY	OIL PUMP	PART NO.	SIZE	DESCRIPTION
1	O-Ring	FP-R61871		Oil pump inlet; Pump codes 5001, 5007; w/Pump housing marked R54615, R54629
1	O-Ring	FP-R74354		Oil pump outlet tube; Pump codes 5001, 5007; w/Pump housing marked R54615
1	Oil Filler Inlet Gasket	FP-R97352		Oil filler neck codes 1201, 1203, 1299
1	Oil Filler Inlet Gasket	FP-R97352		Oil filler neck codes 1202, 1206; To Ser. No. 703,963
1	Oil Pump Seal Ring	FP-R79563		Oil pump outlet adapter; Pump code 5001

(continued on next page)





# John Deere Off Highway

Wheel Tractor 4239T Eng. Windrower 4239T Eng. Loader Tractor 4239T Eng. Excavator **51**  
**4239T Eng. Backhoe 4239T Eng. (cont.)**  
 3.9L 239 OHV Turbo-Diesel L4 (Standard), 4.1875" Bore

## CYLINDER COMPONENTS

QTY	LINERS	PART NO.	SIZE	DESCRIPTION
4	Liner w/o Sealing Ring	FP-R116281		
4	Liner w/Sealing Rings	FP-RE500023		
4	Cylinder Kit Complete	FP-RE33115		w/Con. Rod marked R58979, R80032, R113612
4	Cyl. Liner Sealing Ring Kit	FP-AR65507		
4	Sealing Ring, Liner	FP-R48767		Rectangle; Top
4	Sealing Ring, Liner	FP-R26121		Round; Middle
4	Sealing Ring	FP-SLR2520		Round; Bottom
QTY	PISTONS	PART NO.	SIZE	DESCRIPTION
4	Piston Body w/o Pin	FP-RE48368		
4	Piston Kit w/Pin & Retainers	FP-RE48368WP		
4	Pin	FP-R124230		1.62" pin dia.
8	Piston Pin Retainer	FP-R54114		For 1.62" pin dia.
4	Pin Bushing	FP-R57451		w/Con. Rod marked R56187, R58979, R80032, R113612; Pin dia. 1.62"; 1.621" ID, 1.813" OD, 1.370" O.A.L.
QTY	CONNECTING RODS & BRGS.	PART NO.	SIZE	DESCRIPTION
8	Con. Rod Bolt	FP-R80033		w/Con. Rod marked R80032, R113612; Torque-To-Yield bolt; Replacement recommended
8	Con. Rod Bolt	FP-R74194		w/Con. Rod marked T20007, R51727, R58979; Torque-To-Yield bolt; Replacement recommended
4	Rod Pair	FP-RE27348	STD	
4	Rod Pair	FP-RE27349	10	
4	Rod Pair	FP-RE27358	20	
4	Rod Pair	FP-RE27364	30	
QTY	PISTON RINGS	PART NO.	SIZE	DESCRIPTION
4	Ring Set Single Cylinder	FP-RE507852	STD	1-1/8, 1-3/32, 1-.136 (1 cyl. set)
4	Ring Set Single Cylinder	FP-RE66820	STD	1-1/8, 1-3/32, 1-.136 (1 cyl. set)
KITS				
QTY	OVERHAUL KIT	PART NO.	SIZE	DESCRIPTION
1	In-Frame Overhaul Kit	FP-239TIFK		w/Con. Rod marked R58979, R80032, R113612; Incl. Torque-To-Yield con. rod bolts
1	Complete Overhaul Kit	FP-239TOHK		w/Con. Rod marked R58979, R80032, R113612; Pin dia. 1.62"; Crankshaft codes 4701, 4702; Crankshaft marked R81959 from Ser. No. 769,620; Incl. front & rear seals; Incl. Torque-To-Yield con. rod bolts
1	Complete Overhaul Kit	FP-239TOHK		w/Con. Rod marked R58979, R80032, R113612; Pin dia. 1.62"; Crankshaft codes 4701, 4702; Crankshaft marked T23517 to Ser. No. 769,619; Incl. front & rear seals; Incl. Torque-To-Yield con. rod bolts

Forklift 4039D Eng. Crawler Tractor 4039D Eng. Excavator 4039D Eng. Backhoe 4039D Eng. **52**  
 3.9L 239 (3917cc) OHV Diesel L4 (Litre Engine), 106mm Bore

## CYL. HEAD & PARTS

QTY	GASKETS	PART NO.	SIZE	DESCRIPTION
1	Valve Cover Gasket	FP-R73521		w/Stamped Steel Cover; Rocker arm cover codes 1101, 1102, 1106
1	Head Gasket	FP-R125863		From Ser. No. 300,000
1	Head Set	FP-RE38851		From Ser. No. 300,000
QTY	VALVE	PART NO.	SIZE	DESCRIPTION
4	Intake	FP-R98062	STD	1 groove; Chrome plated stem; 1.8350" Head Dia., .3100" Stem Dia., 5.2780" O.A.L.
4	Intake	FP-R97490	15	1 groove; Chrome plated stem; 1.8350" Head Dia., .3250" Stem Dia., 5.2780" O.A.L.
4	Exhaust	FP-R90692	STD	1 groove; Chrome plated stem; 1.6730" Head Dia., .3095" Stem Dia., 5.2550" O.A.L.
4	Exhaust	FP-R97492	15	1 groove; Chrome plated stem; 1.6730" Head Dia., .3245" Stem Dia., 5.2550" O.A.L.
16	Keeper	FP-R91889		Exh. & Int.
QTY	VALVE SEAT	PART NO.	SIZE	DESCRIPTION
4	Exh.	FP-R85687	STD	
4	Int.	FP-R98335		.020" Dia. O/S face width; 1.8575" OD, 1.5500" ID, .2580" Depth
4	Int.	FP-R98063	STD	1.8575" OD, 1.5500" ID, .2580" Depth
QTY	VALVE SPRING	PART NO.	SIZE	DESCRIPTION
8	Spring	FP-R26125		Exh. & Int.; 2.1200" Free Height

(continued on next page)

**52 Forklift 4039D Eng. Crawler Tractor 4039D Eng. Excavator 4039D Eng. Backhoe 4039D Eng.**  
 (cont.) 3.9L 239 (3917cc) OHV Diesel L4 (Litre Engine), 106mm Bore

<b>CYL. HEAD &amp; PARTS (cont.)</b>				
QTY	VALVE MISC.	PART NO.	SIZE	DESCRIPTION
8	Rotocap	FP-RE60005		Exh. & Int.
1	Oil Filler Cap Gasket	FP-T20328		Oil filler neck codes 1101, 1104, 1201, 1202, 1203, 1206
1	Oil Filler Cap Gasket	FP-R80135		Oil filler neck codes 1204, 1205, 1207; L.H. Auxiliary drive
QTY	VALVE SEAL	PART NO.	SIZE	DESCRIPTION
8	Valve Stem Seal	FP-RE31617		Exh. & Int.; From Ser. No. 300,000; Positive type
8	Valve Stem Seal	FP-R87627		Exh. & Int.; O-Ring type
<b>ELECTRICAL</b>				
QTY	ELECTRICAL	PART NO.	SIZE	DESCRIPTION
1	Starter to Block Gasket	FP-R53108		3-Hole mount; Starting motor codes 3001, 3002, 3007, 3015, 3017, 3019
QTY	ALTERNATOR	PART NO.	SIZE	DESCRIPTION
1	Ball Brg.	FP-JD9449		Front; Delco-Remy components; Codes 3114, 3115, 3116; 78 amp alternator
2	Ball Brg.	FP-JD9449		Front & Rear; Motorola components; Codes 3101, 3116, 3129; 12 Volt, 65 amp alternator
2	Ball Brg.	FP-JD9449		Front & Rear; Motorola components; Codes 3117, 3118, 3119, 3120; 24 Volt, 45 amp alternator
2	Ball Brg.	FP-JD9449		Front & Rear; Motorola No. 70D42076T02; Codes 3108, 3109, 3130; 65 amp alternator
<b>INT &amp; EXH MANIFOLDS</b>				
QTY	INT. & EXH. MANIFOLDS	PART NO.	SIZE	DESCRIPTION
4	Exhaust Manifold Gasket	FP-R90658		Exh. manifold codes 2801, 2802, 2803, 2822
1	Air Intake Gasket	FP-R81275		Int. manifold codes 1701, 1703, 1707, 1709
<b>CAMSHAFT GROUP</b>				
QTY	TIMING COVER	PART NO.	SIZE	DESCRIPTION
1	Timing Gear Cover Gasket	FP-R97454		Front cover
QTY	CAMSHAFT/LIFTER	PART NO.	SIZE	DESCRIPTION
8	Lifter	FP-T20073		
<b>FUEL SYSTEM &amp; PARTS</b>				
QTY	FUEL INJECTION	PART NO.	SIZE	DESCRIPTION
1	Injector Pump Gasket	FP-R125066		Gear cover
4	Fuel Injector Nozzle	FP-RE36935		w/Injector marked 28480
4	Fuel Injector Seal	FP-R79605		Fuel line connection; Nozzle codes 1602, 1603, 1604, 1613, 1615, 1619, 1620, 1624; Nozzle marked 28480; 9.270MM X 13.600MM X 5.080MM
4	Fuel Injector Seal	FP-R79605		Fuel line connection; RePower Engs.; Nozzle code 1695; 9.270MM X 13.600MM X 5.080MM
4	Fuel Injector Nut	FP-R79604		w/Injector marked 28480
2	Clamp	FP-R34766		Pump codes 3701, 3702, 3707, 3712
8	Washer Type Seal	FP-R51936		Leak-off & return line seals; Nozzle codes 1601, 1602, 1603, 1604, 1609, 1613, 1615, 1619, 1620, 1621, 1624, 1646
8	Washer Type Seal	FP-R51936		RePower Engs.; Leak-off & return line seals; Nozzle code 1695
4	Washer Type Seal	FP-R48000		Lower; w/Oversize injector bore; w/Nozzle codes 1602, 1603, 1613, 1615, 1619, 1620, 1623, 1624
4	Washer Type Seal	FP-R60746		Upper; Nozzle codes 1602, 1603, 1604, 1613, 1615, 1619, 1620, 1624
QTY	FUEL FILTERS & PUMP	PART NO.	SIZE	DESCRIPTION
1	Mechanical Fuel Pump	FP-RE42211		Transfer pump
1	Injector Pump Mount Gasket	FP-R97354		w/Roto-Diesel fuel pump
1	O-Ring	FP-R26286		Fuel inj. pump codes 1602, 1603, 1609, 1614, 1618, 1623, 1624, 1643, 1646, 1664; Fuel inlet fitting seal
1	Fuel Transfer Pump Gasket	FP-R97350		Pump code 3799; Cover gskt.
<b>COOLING SYSTEM</b>				
QTY	WATER PUMP	PART NO.	SIZE	DESCRIPTION
1	Water Pump Impeller	FP-R47191		w/Pump housing marked R66420, R68733
1	Water Pump Impeller	FP-R56812		w/Pump housing marked R90783
1	Water Pump Impeller	FP-R94419		Pump code 2004; w/Pump housing marked R100871, R111028
1	Water Pump Impeller	FP-R94419		Pump code 2021; w/Pump housing marked R73604, R100871, R111028
1	Water Pump Impeller	FP-R94419		Pump code 2022; w/Pump housing marked R55164
1	Water Pump Repair/Rebuild Kit	FP-864340979		w/Pump housing marked R51661, R73606, R73724, R79171
1	Water Pump Repair/Rebuild Kit	FP-944840979		w/Pump housing marked R52009
1	Water Pump Repair/Rebuild Kit	FP-RE62658		w/Pump housing marked R55164, R73604

(continued on next page)



# John Deere Off Highway

Forklift 4039D Eng. Crawler Tractor 4039D Eng. Excavator 4039D Eng. Backhoe 4039D Eng. **52**  
3.9L 239 (3917cc) OHV Diesel L4 (Litre Engine), 106mm Bore (cont.)

## COOLING SYSTEM (cont.)

QTY	WATER PUMP (cont.)	PART NO.	SIZE	DESCRIPTION
1	Water Pump Repair/Rebuild Kit	FP-925740979		w/Pump housing marked R56787, R62902
1	Water Pump Repair/Rebuild Kit	FP-RE62661		w/Pump housing marked R66420, R68733
1	Water Pump Housing Gasket	FP-R55405		w/Pump housing marked R55164
1	Water Pump Housing Gasket	FP-R97455		w/Pump housing marked R73604, R100871, R111028
1	Water Pump Housing Gasket	FP-R56809		w/Pump housing marked R90783
1	Oil Seal Kit	FP-AR101549		Water Pump; w/Pump housing marked R55164, R90783
1	Water Pump Mounting Gasket	FP-T20243		w/H/D Pump housing marked R100812, R127918
1	Water Pump Mounting Gasket	FP-T20243		w/Pump housing marked R55164, R67188, R73604, R90783, R90784, R100871, R104648, R111028
1	O-Ring	FP-U13639		Coolant heater codes 2601, 2602; Adapter seal; 1.475" X .118"
1	Shaft & Bearing Assembly	FP-JD9448		w/Cast pulley; w/Pump housing marked R55164
1	Shaft & Bearing Assembly	FP-JD9257		w/Pump housing marked R55164, R73604, R100871, R111028, R111084, R59049
1	Shaft & Bearing Assembly	FP-JD8643		w/Pump housing marked R90783
QTY	THERMOSTAT	PART NO.	SIZE	DESCRIPTION
2	Thermostat	FP-RE33705		Thermostat code 2204; Housing codes 3901, 3904; 180 Deg.
2	Thermostat	FP-AR48675		Thermostat code 2207; Housing codes 3901, 3904; 180 Deg.
1	Thermostat Gasket	FP-T20219		
1	Thermostat Cover Gasket	FP-T20215		Thermostat cover code 2101; Thermostat housing code 3004
1	Thermostat Cover Gasket	FP-R54638		Thermostat cover codes 2105, 2108; Thermostat housing codes 3901, 3904; w/Two thermostats
1	Therm. Hsg. - Water Mfld. Gsk	FP-R54641		Thermostat housing to cyl. head
2	O-Ring	FP-R56461		Thermostat housing tube seals; Housing code 3905; Water pump codes 2004, 2023

## ENGINE BLOCK & PARTS

QTY	GASKETS	PART NO.	SIZE	DESCRIPTION
1	Flywheel Housing Gasket	FP-R97351		Flywheel housing codes 1403, 1404, 1405, 1406, 1407, 1410, 1411, 1421, 1422, 1425, 1432
1	Oil Pan Gasket	FP-R119360		w/Sheet metal pan; Oil pan code 1902; From Ser. No. 103,251; w/Cast iron oil pan
1	Oil Pan Gasket	FP-R119360		w/Sheet metal pan; Oil pan codes 1901, 1903, 1906; w/Cast iron oil pan
1	Oil Pan Gasket	FP-R97342		Oil pan codes 1904, 1905, 1910, 1913, 1919, 1932; w/Stamped Steel Pan
1	Block to End Plate Front Gskt	FP-R131794		Front plate codes 3601, 3602, 3604, 3695; R.H. side gear drive
QTY	GASKET SETS	PART NO.	SIZE	DESCRIPTION
1	In-Frame Gasket Set	FP-PG219S		
1	Complete Overhaul Gasket Set	FP-RE38857		Crankshaft seals not incl.
1	Complete Overhaul Gasket Set	FP-RE38857WS		Incl. crankshaft seals; Rear main brg. seal incl.; Wear sleeve not incl.
QTY	CAM BEARINGS	PART NO.	SIZE	DESCRIPTION
1	Cam Brg.	FP-R91708		Cyl. block codes 4601, 4602, 4623; 2.0MM O/S OD; Balance shaft bushing
1	Cam Brg.	FP-R119874		R.H. Side gear drive
QTY	ENGINE BEARING MISC.	PART NO.	SIZE	DESCRIPTION
1	Bal. Shaft Set	FP-R57160S		
6	Balance Shaft Bearing	FP-R57160		
QTY	OIL COOLERS & FILTERS	PART NO.	SIZE	DESCRIPTION
1	Oil Cooler	FP-RE61767		RePower Engs. DD14964, DD14965; w/Cooler codes 5904, 5906, 5908, 5914, 5916, 5995; w/6 plates; From Ser. No. 185,224
1	Washer	FP-R105714		Oil cooler; Oil Cooler codes 5901, 5904, 5905, 5906, 5907
1	Rect. or Square Seal	FP-R70956		Cooler housing; w/Behr cooler codes 5904, 5906, 5908, 5914, 5916; To Ser. No. 185,223; 2.700" X 3.000" X .180"
1	Rect. or Square Seal	FP-R70956		Cooler housing; RePower Engs. DD14964, DD14965, DD14966, DD14967; Oil cooler code 5995; 2.700" X 3.000" X .180"
CRANKSHAFT/OIL PUMP				
QTY	CRANKSHAFT	PART NO.	SIZE	DESCRIPTION
1	Crankshaft	FP-RE20585		
1	Oil Seal Kit	FP-SK67942		RePower Engs. DD14964, DD14966; Crankshaft codes 4701, 4702, 4707, 4710; Incl. front & rear seals
QTY	SEALS - FRONT CRANK	PART NO.	SIZE	DESCRIPTION
1	Crankshaft Front Seal	FP-AR67942		
1	O-Ring	FP-H35244		Crankshaft pulley; Crankshaft, Bearing codes 4701, 4702, 4708, 4710

(continued on next page)

**52** *Forklift 4039D Eng. Crawler Tractor 4039D Eng. Excavator 4039D Eng. Backhoe 4039D Eng.*  
 (cont.) 3.9L 239 (3917cc) OHV Diesel L4 (Litre Engine), 106mm Bore

### CRANKSHAFT/OIL PUMP (cont.)

QTY	SEALS - FRONT CRANK (cont.)	PART NO.	SIZE	DESCRIPTION
1	O-Ring	FP-H35244		Crankshaft pulley; RePower Engs. DD14965, DD14967; Crankshaft, Bearing codes 4701, 4702, 4708, 4710
QTY	SEALS - REAR CRANK	PART NO.	SIZE	DESCRIPTION
1	Crankshaft Rear Seal	FP-RE24959		Crankshaft, Bearing codes 4701, 4703; Flywheel housing codes 1403, 1404, 1405, 1406, 1407, 1410, 1411, 1421, 1422, 1425, 1432
QTY	MAIN BEARINGS	PART NO.	SIZE	DESCRIPTION
1	Main Set	FP-MBK3004	STD	w/Flanged thrust brg.
1	Main Set	FP-MBK300410	10	w/Flanged thrust brg.
1	Main Set	FP-MBK300420	20	w/Flanged thrust brg.
1	Main Set	FP-MBK300430	30	w/Flanged thrust brg.
4	Plain Main Brg.	FP-RE27352	STD	w/Flangeless thrust brg.
4	Plain Main Brg.	FP-RE27353	10	w/Flangeless thrust brg.
4	Plain Main Brg.	FP-RE27360	20	w/Flangeless thrust brg.
4	Plain Main Brg.	FP-RE27368	30	w/Flangeless thrust brg.
1	Flanged Main Brg.	FP-RE521350	STD	
1	Flanged Main Brg.	FP-RE526754	10	
1	Flanged Main Brg.	FP-RE527235	20	
1	Flanged Main Brg.	FP-RE527236	30	
3	Thrust Washer	FP-R78598	STD	w/Thrust washer; Crank marked R120009, R121018; Note: Applications may use three or four thrust washers
QTY	OIL PUMP	PART NO.	SIZE	DESCRIPTION
1	Pump Repair Kit	FP-RE55343		Pump codes 5001, 5004; w/Pump housing marked R54615; From Ser. No. 427,376
1	O-Ring	FP-R61871		Oil pump inlet; Pump codes 5001, 5002, 5005, 5006, 5007; w/Pump housing marked R54615; To Ser. No. 427,375
1	O-Ring	FP-R74354		Oil pump outlet tube; Pump codes 5001, 5002; w/Pump housing marked R54615
1	Oil Filler Inlet Gasket	FP-R97352		Oil filler neck codes 1101, 1104, 1200, 1201, 1203, 1297, 1299
CYLINDER COMPONENTS				
QTY	LINERS	PART NO.	SIZE	DESCRIPTION
4	Liner w/o Sealing Ring	FP-R116281		
4	Liner w/Sealing Rings	FP-RE500023		
4	Cylinder Kit Complete	FP-RE30250	STD	w/Con. Rod marked R51727, R80034
4	Cyl. Liner Sealing Ring Kit	FP-AR65507		
4	Sealing Ring, Liner	FP-R48767		Rectangle; Top
4	Sealing Ring	FP-SLR2520		Round; Bottom
QTY	PISTONS	PART NO.	SIZE	DESCRIPTION
4	Piston Body w/o Pin	FP-RE19282		
4	Piston Kit w/Pin & Retainers	FP-RE19282WP		
4	Pin	FP-R125754		1.38" pin dia.
8	Piston Pin Retainer	FP-M41029		For 1.38" pin dia.
4	Pin Bushing	FP-R55647		w/Con. Rod marked R51727, R80034; 1.3765" ID, 1.500" OD, 1.570" O.A.L.
QTY	CONNECTING RODS & BRGS.	PART NO.	SIZE	DESCRIPTION
4	Rod Pair	FP-AR97517	STD	w/Con. Rod marked R56187, R116851
4	Rod Pair	FP-AR97653	10	w/Con. Rod marked R56187, R116851
4	Rod Pair	FP-AR97654	20	w/Con. Rod marked R56187, R116851
4	Rod Pair	FP-AR97655	30	w/Con. Rod marked R56187, R116851
4	Rod Pair	FP-RE27348	STD	Crankshaft codes 4702, 4708, 4710; Con. Rod codes 4801, 4802
4	Rod Pair	FP-RE27349	10	Crankshaft codes 4702, 4708, 4710; Con. Rod codes 4801, 4802
4	Rod Pair	FP-RE27358	20	Crankshaft codes 4702, 4708, 4710; Con. Rod codes 4801, 4802
4	Rod Pair	FP-RE27364	30	Crankshaft codes 4702, 4708, 4710; Con. Rod codes 4801, 4802
4	Rod Pair	FP-RE27348	STD	RePower Engs. DD14964, DD14965; w/Con. Rod marked R80034
4	Rod Pair	FP-RE27349	10	RePower Engs. DD14964, DD14965; w/Con. Rod marked R80034
4	Rod Pair	FP-RE27358	20	RePower Engs. DD14964, DD14965; w/Con. Rod marked R80034
4	Rod Pair	FP-RE27364	30	RePower Engs. DD14964, DD14965; w/Con. Rod marked R80034
QTY	PISTON RINGS	PART NO.	SIZE	DESCRIPTION
4	Ring Set Single Cylinder	FP-RE507852	STD	1-1/8, 1-3/32, 1-.136 (1 cyl. set)
4	Ring Set Single Cylinder	FP-RE66820	STD	1-1/8, 1-3/32, 1-.136 (1 cyl. set)

(continued on next page)



# John Deere Off Highway

Forklift 4039D Eng. Crawler Tractor 4039D Eng. Excavator 4039D Eng. Backhoe 4039D Eng. **52**  
3.9L 239 (3917cc) OHV Diesel L4 (Litre Engine), 106mm Bore (cont.)

## KITS

QTY	OVERHAUL KIT	PART NO.	SIZE	DESCRIPTION
1	In-Frame Overhaul Kit	FP-239DIFK		w/Con. Rod marked R80034; Incl. front & rear seals; Crankshaft codes 4702, 4708, 4710; Con. Rod codes 4801, 4802
1	Complete Overhaul Kit	FP-239DOHK		w/Con. Rod marked R80034; Incl. front & rear seals; Crankshaft codes 4702, 4708, 4710; Con. Rod codes 4801, 4802; Incl. Torque-To-Yield con. rod bolts

Backhoe 4039T Eng. Sprayer 4039T Eng. **53**  
3.9L 239 (3917cc) OHV Turbo-Diesel L4 (Litre Engine), 106mm Bore

## CYL. HEAD & PARTS

QTY	GASKETS	PART NO.	SIZE	DESCRIPTION
1	Valve Cover Gasket	FP-R73521		w/Stamped Steel Cover; Rocker arm cover codes 1101, 1102, 1104, 1106, 1110, 1114
1	Head Gasket	FP-R125863		From Ser. No. 300,000
1	Head Set	FP-RE38851		From Ser. No. 300,000
QTY	VALVE	PART NO.	SIZE	DESCRIPTION
4	Intake	FP-R98062	STD	1 groove; Chrome plated stem; 1.8350" Head Dia., .3100" Stem Dia., 5.2780" O.A.L.
4	Intake	FP-R97490	15	1 groove; Chrome plated stem; 1.8350" Head Dia., .3250" Stem Dia., 5.2780" O.A.L.
4	Exhaust	FP-R90692	STD	1 groove; Chrome plated stem; 1.6730" Head Dia., .3095" Stem Dia., 5.2550" O.A.L.
4	Exhaust	FP-R97492	15	1 groove; Chrome plated stem; 1.6730" Head Dia., .3245" Stem Dia., 5.2550" O.A.L.
16	Keeper	FP-R91889		Exh. & Int.
QTY	VALVE SEAT	PART NO.	SIZE	DESCRIPTION
4	Exh.	FP-R85687	STD	
4	Int.	FP-R98335		.020" Dia. O/S face width; 1.8575" OD, 1.5500" ID, .2580" Depth
4	Int.	FP-R98063	STD	1.8575" OD, 1.5500" ID, .2580" Depth
QTY	VALVE SPRING	PART NO.	SIZE	DESCRIPTION
8	Spring	FP-R26125		Exh. & Int.; 2.1200" Free Height
QTY	VALVE MISC.	PART NO.	SIZE	DESCRIPTION
8	Rotocap	FP-RE60005		Exh. & Int.
1	Oil Filler Cap Gasket	FP-T20328		Oil filler neck codes 1101, 1104, 1201, 1202, 1203, 1206
1	Oil Filler Cap Gasket	FP-R80135		Oil filler neck codes 1204, 1205, 1207; L.H. Auxiliary drive
QTY	VALVE SEAL	PART NO.	SIZE	DESCRIPTION
8	Valve Stem Seal	FP-RE31617		Exh. & Int.; From Ser. No. 300,000; Positive type
8	Valve Stem Seal	FP-R87627		Exh. & Int.; O-Ring type

## ELECTRICAL

QTY	ELECTRICAL	PART NO.	SIZE	DESCRIPTION
1	Starter to Block Gasket	FP-R53108		3-Hole mount; Starting motor codes 3001, 3002, 3007, 3015, 3017, 3019
QTY	ALTERNATOR	PART NO.	SIZE	DESCRIPTION
1	Ball Brg.	FP-JD9449		Front; Delco-Remy components; Codes 3114, 3115, 3116; 78 amp alternator
2	Ball Brg.	FP-JD9449		Front & Rear; Motorola components; Codes 3101, 3116, 3129; 12 Volt, 65 amp alternator
2	Ball Brg.	FP-JD9449		Front & Rear; Motorola components; Codes 3117, 3118, 3119, 3120; 24 Volt, 45 amp alternator
2	Ball Brg.	FP-JD9449		Front & Rear; Motorola No. 70D42076T02; Codes 3108, 3109, 3130; 65 amp alternator

## INT & EXH MANIFOLDS

QTY	INT. & EXH. MANIFOLDS	PART NO.	SIZE	DESCRIPTION
4	Exhaust Manifold Gasket	FP-R90658		Exh. manifold codes 2803, 2806, 2819, 2822
1	Air Intake Gasket	FP-R81275		Int. manifold codes 1713, 1714, 1718

## CAMSHAFT GROUP

QTY	TIMING COVER	PART NO.	SIZE	DESCRIPTION
1	Timing Gear Cover Gasket	FP-T20273		Access cover
1	Timing Gear Cover Gasket	FP-R97454		Front cover
QTY	CAMSHAFT/LIFTER	PART NO.	SIZE	DESCRIPTION
8	Lifter	FP-T20073		

(continued on next page)

**53 Backhoe 4039T Eng. Sprayer 4039T Eng.**  
 (cont.) 3.9L 239 (3917cc) OHV Turbo-Diesel L4 (Litre Engine), 106mm Bore

FUEL SYSTEM & PARTS				
QTY	FUEL INJECTION	PART NO.	SIZE	DESCRIPTION
1	Injector Pump Gasket	FP-R125066		Gear cover
4	Fuel Injector Nozzle	FP-RE36939		w/Injector marked 28484
4	Fuel Injector Seal	FP-R79605		Fuel line connection; Nozzle codes 1602, 1603, 1604, 1613, 1615, 1619; Nozzle marked 28484; 9.270MM X 13.600MM X 5.080MM
4	Fuel Injector Seal	FP-R79605		Fuel line connection; RePower Engs.; Nozzle code 1695; 9.270MM X 13.600MM X 5.080MM
4	Fuel Injector Nut	FP-R79604		w/Injector marked 28484
2	Clamp	FP-R34766		Pump codes 3701, 3702, 3707, 3712
8	Washer Type Seal	FP-R51936		Leak-off & return line seals; Nozzle codes 1601, 1602, 1603, 1604, 1609, 1613, 1615, 1619, 1620, 1621, 1651
8	Washer Type Seal	FP-R51936		RePower Engs.; Leak-off & return line seals; Nozzle code 1695
4	Washer Type Seal	FP-R48000		Lower; w/Nozzle code 1604
QTY	FUEL FILTERS & PUMP	PART NO.	SIZE	DESCRIPTION
1	Mechanical Fuel Pump	FP-RE42211		Pump codes 3701, 3702, 3703, 3704, 3706; For fuel filter & final filter; Transfer pump
1	O-Ring	FP-R26286		Fuel inj. pump codes 1602, 1603, 1609, 1614, 1618, 1623, 1624, 1643, 1646, 1664; Fuel inlet fitting seal
1	Fuel Transfer Pump Gasket	FP-R97350		Pump code 3799; Cover gskt.
QTY	TURBOCHARGER	PART NO.	SIZE	DESCRIPTION
1	Turbocharger Oil Drain Gasket	FP-R105346		Turbo codes 6501, 6506, 6512, 6513
1	Turbocharger Mounting Gasket	FP-R89879		
1	Turbocharger Oil Supply Gskt.	FP-R97348		Turbo code 6501
COOLING SYSTEM				
QTY	WATER PUMP	PART NO.	SIZE	DESCRIPTION
1	Water Pump Impeller	FP-R47191		w/Pump housing marked R66420, R68733
1	Water Pump Impeller	FP-R56812		w/Pump housing marked R90783
1	Water Pump Impeller	FP-R94419		Pump code 2021; w/Pump housing marked R73604, R100871, R111028
1	Water Pump Impeller	FP-R94419		Pump code 2022; w/Pump housing marked R55164
1	Water Pump Impeller	FP-R94419		Pump code 2026; w/Pump housing marked R100871, R111028
1	Water Pump Repair/Rebuild Kit	FP-864340979		w/Pump housing marked R51661, R73606, R73724, R79171
1	Water Pump Repair/Rebuild Kit	FP-944840979		w/Pump housing marked R52009
1	Water Pump Repair/Rebuild Kit	FP-RE62658		w/Pump housing marked R55164, R73604
1	Water Pump Repair/Rebuild Kit	FP-925740979		w/Pump housing marked R56787, R62902
1	Water Pump Repair/Rebuild Kit	FP-RE62661		w/Pump housing marked R66420, R68733
1	Water Pump Housing Gasket	FP-R55405		w/Pump housing marked R55164
1	Water Pump Housing Gasket	FP-R97455		w/Pump housing marked R73604, R100871, R111028
1	Water Pump Housing Gasket	FP-R56809		w/Pump housing marked R90783
1	Oil Seal Kit	FP-AR101549		Water Pump; w/Pump housing marked R55164, R90783
1	Water Pump Mounting Gasket	FP-T20243		w/H/D Pump housing marked R100812, R127918
1	Water Pump Mounting Gasket	FP-T20243		w/Pump housing marked R55164, R73604, R90783, R90784, R100871, R104648, R111028; w/Cast iron impeller marked T30897
1	O-Ring	FP-U13639		Coolant heater codes 2601, 2602; Adapter seal; 1.475" X .118"
1	Shaft & Bearing Assembly	FP-JD9257		w/Pump housing marked R55164, R73604, R100871, R111028
1	Shaft & Bearing Assembly	FP-JD8643		w/Pump housing marked R90783
QTY	THERMOSTAT	PART NO.	SIZE	DESCRIPTION
2	Thermostat	FP-AR48675		Thermostat code 2207; Thermostat housing codes 3901, 3904; 180 Deg.
1	Thermostat	FP-RE33705		Thermostat housing codes 2204, 2207, 2208; 180 Deg.
1	Thermostat Gasket	FP-T20219		Single thermostat cover codes 2101, 2102, 2204, 3901
1	Thermostat Cover Gasket	FP-T20215		
1	Thermostat Cover Gasket	FP-R54638		Thermostat housing codes 3901, 3904; Thermostat cover codes 2102, 2108; w/Two thermostats
1	Therm. Hsg. - Water Mfld. Gsk	FP-R54641		Thermostat housing to cyl. head
2	O-Ring	FP-R56461		Thermostat housing tube seals; Housing code 3901
QTY	MISCELLANEOUS	PART NO.	SIZE	DESCRIPTION
2	Water Line Gasket	FP-R97346		
ENGINE BLOCK & PARTS				
QTY	GASKETS	PART NO.	SIZE	DESCRIPTION
1	Flywheel Housing Gasket	FP-R97351		Flywheel housing codes 1403, 1404, 1405, 1406, 1407, 1410, 1411, 1421, 1422, 1425, 1432
1	Oil Pan Gasket	FP-R119360		w/Sheet metal pan; Oil pan codes 1901, 1903, 1906; w/Cast iron oil pan
1	Oil Pan Gasket	FP-R97342		Oil pan codes 1904, 1905, 1908, 1910, 1913, 1919, 1932; w/Stamped Steel Pan

(continued on next page)



# John Deere Off Highway

*Backhoe 4039T Eng. Sprayer 4039T Eng. 53*  
3.9L 239 (3917cc) OHV Turbo-Diesel L4 (Litre Engine), 106mm Bore (cont.)

<b>ENGINE BLOCK &amp; PARTS (cont.)</b>				
QTY	GASKETS (cont.)	PART NO.	SIZE	DESCRIPTION
1	Block to End Plate Front Gskt	FP-R131794		Front plate codes 3601, 3602, 3604, 3695; R.H. side gear drive
QTY	GASKET SETS	PART NO.	SIZE	DESCRIPTION
1	In-Frame Gasket Set	FP-PG219S		
1	Complete Overhaul Gasket Set	FP-RE38857		Crankshaft seals not incl.
1	Complete Overhaul Gasket Set	FP-RE38857WS		Incl. crankshaft seals; Rear main brg. seal incl.; Wear sleeve not incl.
QTY	CAM BEARINGS	PART NO.	SIZE	DESCRIPTION
1	Cam Brg.	FP-R91708		Cyl. block codes 4601, 4602, 4623; 2.0MM O/S OD; Balance shaft bushing
1	Cam Brg.	FP-R119874		R.H. Side gear drive
QTY	ENGINE BEARING MISC.	PART NO.	SIZE	DESCRIPTION
1	Bal. Shaft Set	FP-R57160S		
6	Balance Shaft Bearing	FP-R57160		
QTY	OIL COOLERS & FILTERS	PART NO.	SIZE	DESCRIPTION
1	Oil Cooler	FP-RE61767		RePower Engs. DD14964, DD14965; w/Cooler codes 5904, 5906, 5908, 5914, 5916, 5995; w/6 plates; From Ser. No. 185,224
1	Washer	FP-R105714		Oil cooler; Oil Cooler codes 5901, 5904, 5905, 5906, 5907
2	O-Ring	FP-R52811		Aftercooled; Adapter seal
1	Rect. or Square Seal	FP-R70956		Cooler housing; w/Behr cooler codes 5904, 5906, 5908, 5914, 5916; To Ser. No. 185,223; 2.700" X 3.000" X .180"
1	Rect. or Square Seal	FP-R70956		Cooler housing; RePower Engs. DD14964, DD14965, DD14966, DD14967; Oil cooler code 5995; 2.700" X 3.000" X .180"
<b>CRANKSHAFT/OIL PUMP</b>				
QTY	CRANKSHAFT	PART NO.	SIZE	DESCRIPTION
1	Crankshaft	FP-RE20585		
1	Oil Seal Kit	FP-SK67942		RePower Engs. DD14964, DD14965, DD14966, DD14967; Crankshaft codes 4701, 4702, 4703, 4707, 4708, 4710; Incl. front & rear seals
QTY	SEALS - FRONT CRANK	PART NO.	SIZE	DESCRIPTION
1	Crankshaft Front Seal	FP-AR67942		
1	O-Ring	FP-H35244		Crankshaft pulley; Pulley codes 1301, 1307, 1315; Crankshaft, Bearing codes 4701, 4702
1	O-Ring	FP-H35244		Crankshaft pulley; RePower Engs. DD14965, DD14967; Pulley codes 1301, 1307, 1315; Crankshaft, Bearing codes 4701, 4702
QTY	SEALS - REAR CRANK	PART NO.	SIZE	DESCRIPTION
1	Crankshaft Rear Seal	FP-RE24959		Crankshaft, Bearing codes 4701, 4703; Flywheel housing codes 1403, 1404, 1405, 1406, 1407, 1410, 1411, 1421, 1422, 1425, 1432
QTY	MAIN BEARINGS	PART NO.	SIZE	DESCRIPTION
1	Main Set	FP-MBK3004	STD	w/Flanged thrust brg.
1	Main Set	FP-MBK300410	10	w/Flanged thrust brg.
1	Main Set	FP-MBK300420	20	w/Flanged thrust brg.
1	Main Set	FP-MBK300430	30	w/Flanged thrust brg.
4	Plain Main Brg.	FP-RE27352	STD	w/Flangeless thrust brg.
4	Plain Main Brg.	FP-RE27353	10	w/Flangeless thrust brg.
4	Plain Main Brg.	FP-RE27360	20	w/Flangeless thrust brg.
4	Plain Main Brg.	FP-RE27368	30	w/Flangeless thrust brg.
1	Flanged Main Brg.	FP-RE521350	STD	
1	Flanged Main Brg.	FP-RE526754	10	
1	Flanged Main Brg.	FP-RE527235	20	
1	Flanged Main Brg.	FP-RE527236	30	
3	Thrust Washer	FP-R78598	STD	w/Thrust washer; Crank marked R120009, R121018; Note: Applications may use three or four thrust washers
QTY	OIL PUMP	PART NO.	SIZE	DESCRIPTION
1	Pump Repair Kit	FP-RE55343		Pump codes 5001, 5004; w/Pump housing marked R54615; From Ser. No. 427,376
1	O-Ring	FP-R61871		Oil pump inlet; Pump codes 5001, 5005, 5006, 5007; w/Pump housing marked R54615
1	O-Ring	FP-R61871		Oil pump inlet; RePower Engs.; Pump codes 5002, 5008; w/Pump housing marked R54615
1	O-Ring	FP-R74354		Oil pump outlet tube; Pump codes 5001, 5002, 5005, 5006, 5007, 5008; w/Pump housing marked R54615
1	Oil Filler Inlet Gasket	FP-R97352		Oil filler neck codes 1101, 1104, 1200, 1201, 1203, 1297, 1299

(continued on next page)

# John Deere Off Highway



**53 Backhoe 4039T Eng. Sprayer 4039T Eng.**  
 (cont.) 3.9L 239 (3917cc) OHV Turbo-Diesel L4 (Litre Engine), 106mm Bore

## CYLINDER COMPONENTS

QTY	LINERS	PART NO.	SIZE	DESCRIPTION
4	Liner w/o Sealing Ring	FP-R116281		
4	Liner w/Sealing Rings	FP-RE500023		
4	Cylinder Kit Complete	FP-RE33115		w/Con. Rod marked R58979, R80032, R113612
4	Cyl. Liner Sealing Ring Kit	FP-AR65507		
4	Sealing Ring, Liner	FP-R48767		Rectangle; Top
4	Sealing Ring, Liner	FP-R26121		Round; Middle
4	Sealing Ring	FP-SLR2520		Round; Bottom

QTY	PISTONS	PART NO.	SIZE	DESCRIPTION
4	Piston Body w/o Pin	FP-RE48368		
4	Piston Kit w/Pin & Retainers	FP-RE48368WP		
4	Pin	FP-R124230		1.62" pin dia.
8	Piston Pin Retainer	FP-R54114		For 1.62" pin dia.
4	Pin Bushing	FP-R57451		w/Con. Rod marked R80032, R113612, R122191; Rod, piston & liner codes 4039, 4802; 1.621" ID, 1.813" OD, 1.370" O.A.L.

QTY	CONNECTING RODS & BRGS.	PART NO.	SIZE	DESCRIPTION
4	Rod Pair	FP-AR97517	STD	w/Con. Rod marked R56187, R116851
4	Rod Pair	FP-AR97653	10	w/Con. Rod marked R56187, R116851
4	Rod Pair	FP-AR97654	20	w/Con. Rod marked R56187, R116851
4	Rod Pair	FP-AR97655	30	w/Con. Rod marked R56187, R116851
4	Rod Pair	FP-RE27348	STD	Crankshaft code 4702; Con. Rod code 4803
4	Rod Pair	FP-RE27349	10	Crankshaft code 4702; Con. Rod code 4803
4	Rod Pair	FP-RE27358	20	Crankshaft code 4702; Con. Rod code 4803
4	Rod Pair	FP-RE27364	30	Crankshaft code 4702; Con. Rod code 4803
4	Rod Pair	FP-RE27348	STD	RePower Engs. DD14964, DD14965; w/Con. Rod marked R80032
4	Rod Pair	FP-RE27349	10	RePower Engs. DD14964, DD14965; w/Con. Rod marked R80032
4	Rod Pair	FP-RE27358	20	RePower Engs. DD14964, DD14965; w/Con. Rod marked R80032
4	Rod Pair	FP-RE27364	30	RePower Engs. DD14964, DD14965; w/Con. Rod marked R80032

QTY	PISTON RINGS	PART NO.	SIZE	DESCRIPTION
4	Ring Set Single Cylinder	FP-RE507852	STD	1-1/8, 1-3/32, 1-.136 (1 cyl. set)
4	Ring Set Single Cylinder	FP-RE66820	STD	1-1/8, 1-3/32, 1-.136 (1 cyl. set)

## KITS

QTY	OVERHAUL KIT	PART NO.	SIZE	DESCRIPTION
1	In-Frame Overhaul Kit	FP-239TIFK		w/Con. Rod marked R80032, R113612, R58979; Incl. Torque-To-Yield con. rod bolts
1	Complete Overhaul Kit	FP-239TOHK		w/Con. Rod marked R80032, R113612, R56187, R58979; Incl. Torque-To-Yield con. rod bolts

**54 Forklift 4241G Eng. Loader 4241G Eng. Wheel Tractor 4241G Eng. Loader Tractor 4241G Eng. Dozer 4241G Eng. Backhoe 4241G Eng.**  
 3.9L 241 OHV L4, 4.25" Bore

## CYL. HEAD & PARTS

QTY	VALVE	PART NO.	SIZE	DESCRIPTION
16	Keeper	FP-41339		1 groove; Square cut key groove
16	Keeper	FP-T20077		1 groove; Square cut key groove; Hardened
16	Keeper, Bulk	VK-138B		1 groove; Square cut key groove; Carton of 1000

QTY	VALVE SPRING	PART NO.	SIZE	DESCRIPTION
8	Spring	FP-R26125		2.1200" Free Height

## METERS

QTY	METERS	PART NO.	SIZE	DESCRIPTION
1	Hour Meter Housing Gasket	FP-R26173		
1	Speed/Hour Meter Gasket	FP-R44853		

## CAMSHAFT GROUP

QTY	TIMING COVER	PART NO.	SIZE	DESCRIPTION
1	Front Timing Cover Gasket	FP-R26084		

QTY	CAMSHAFT/LIFTER	PART NO.	SIZE	DESCRIPTION
8	Lifter	FP-R52773		

(continued on next page)





# John Deere Off Highway

**Forklift 4241G Eng. Loader 4241G Eng. Wheel Tractor 4241G Eng. Loader Tractor 4241G 54**  
**Eng. Dozer 4241G Eng. Backhoe 4241G Eng. (cont.)**  
 3.9L 241 OHV L4, 4.25" Bore

## COOLING SYSTEM

QTY	WATER PUMP	PART NO.	SIZE	DESCRIPTION
1	Shaft & Bearing Assembly	FP-JD9355		w/Pump housing marked R41313, R41317, R44116, R44119, R48742
1	Thermostat	FP-R36846		w/Housing marked R41853, R42664; 180 Deg. to 200 Deg. range
1	Thermostat Cover Gasket	FP-R42694		One hole

## ENGINE BLOCK & PARTS

QTY	GASKETS	PART NO.	SIZE	DESCRIPTION
1	Washer	FP-B3586R		Oil filter cover packing
1	Cam Set	FP-3R46903	STD	
3	Cam Brg.	FP-R46903	STD	

## CRANKSHAFT/OIL PUMP

QTY	SEALS - FRONT CRANK	PART NO.	SIZE	DESCRIPTION
1	Oil Seal Kit	FP-AR49025		
1	Oil Seal	FP-RE22764		PTFE
1	Main Set	FP-MBK3001	STD	w/Flanged brg.
1	Main Set	FP-MBK300110	10	w/Flanged brg.
1	Main Set	FP-MBK300120	20	w/Flanged brg.
1	Main Set	FP-MBK300130	30	w/Flanged brg.
1	Main Set	FP-MBK300	STD	w/Thrust washer
1	Main Set	FP-MBK30010	10	w/Thrust washer
1	Main Set	FP-MBK30020	20	w/Thrust washer
1	Main Set	FP-MBK30030	30	w/Thrust washer
2	O-Ring	FP-A4730R		Dipstick
1	O-Ring	FP-R495R		Pump intake tube; Smooth
1	Oil Filter Seal Ring	FP-R26163		Filter body
1	Oil Filter Housing Gasket	FP-R26354		

## CYLINDER COMPONENTS

QTY	LINERS	PART NO.	SIZE	DESCRIPTION
4	Sealing Ring, Liner	FP-112847		To Ser. No. 357,083
4	Pin Bushing	FP-3129YA20		1.252" ID, 1.3785" OD, 1.510" O.A.L.
4	Rod Pair	FP-AR45723	STD	
4	Rod Pair	FP-AR46396	10	
4	Rod Pair	FP-AR46397	20	
4	Rod Pair	FP-AR46398	30	

**Loader 4241LP Eng. (LPG). Wheel Tractor 4241LP Eng. (LPG). Loader Tractor 4241LP 55**  
**Eng. (LPG).**  
 3.9L 241 OHV LPG L4, 4.25" Bore

## CYL. HEAD & PARTS

QTY	VALVE	PART NO.	SIZE	DESCRIPTION
16	Keeper	FP-41339		1 groove; Square cut key groove
16	Keeper	FP-T20077		1 groove; Square cut key groove; Hardened
16	Keeper, Bulk	VK-138B		1 groove; Square cut key groove; Carton of 1000
8	Spring	FP-R26125		2.1200" Free Height

## METERS

QTY	METERS	PART NO.	SIZE	DESCRIPTION
1	Hour Meter Housing Gasket	FP-R26173		
1	Speed/Hour Meter Gasket	FP-R44853		

(continued on next page)

# John Deere Off Highway



<b>55</b> Loader 4241LP Eng. (LPG). Wheel Tractor 4241LP Eng. (LPG). Loader Tractor 4241LP (cont.) Eng. (LPG). 3.9L 241 OHV LPG L4, 4.25" Bore				
<b>CAMSHAFT GROUP</b>				
<b>QTY</b>	<b>TIMING COVER</b>	<b>PART NO.</b>	<b>SIZE</b>	<b>DESCRIPTION</b>
1	Front Timing Cover Gasket	FP-R26084		
<b>QTY</b>	<b>CAMSHAFT/LIFTER</b>	<b>PART NO.</b>	<b>SIZE</b>	<b>DESCRIPTION</b>
8	Lifter	FP-R52773		
<b>COOLING SYSTEM</b>				
<b>QTY</b>	<b>WATER PUMP</b>	<b>PART NO.</b>	<b>SIZE</b>	<b>DESCRIPTION</b>
1	Shaft & Bearing Assembly	FP-JD9355		w/Pump housing marked R41313, R41317, R44116, R44119, R48742
<b>QTY</b>	<b>THERMOSTAT</b>	<b>PART NO.</b>	<b>SIZE</b>	<b>DESCRIPTION</b>
1	Thermostat	FP-R36846		w/Housing marked R41853, R42664; 180 Deg. to 200 Deg. range
1	Thermostat Cover Gasket	FP-R42694		One hole
<b>ENGINE BLOCK &amp; PARTS</b>				
<b>QTY</b>	<b>GASKETS</b>	<b>PART NO.</b>	<b>SIZE</b>	<b>DESCRIPTION</b>
1	Washer	FP-B3586R		Oil filter cover packing
<b>QTY</b>	<b>CAM BEARINGS</b>	<b>PART NO.</b>	<b>SIZE</b>	<b>DESCRIPTION</b>
1	Cam Set	FP-3R46903	STD	
3	Cam Brg.	FP-R46903	STD	
<b>CRANKSHAFT/OIL PUMP</b>				
<b>QTY</b>	<b>SEALS - FRONT CRANK</b>	<b>PART NO.</b>	<b>SIZE</b>	<b>DESCRIPTION</b>
1	Oil Seal Kit	FP-AR49025		
<b>QTY</b>	<b>SEALS - REAR CRANK</b>	<b>PART NO.</b>	<b>SIZE</b>	<b>DESCRIPTION</b>
1	Oil Seal	FP-RE22764		PTFE
<b>QTY</b>	<b>MAIN BEARINGS</b>	<b>PART NO.</b>	<b>SIZE</b>	<b>DESCRIPTION</b>
1	Main Set	FP-MBK3001	STD	w/Flanged brg.
1	Main Set	FP-MBK300110	10	w/Flanged brg.
1	Main Set	FP-MBK300120	20	w/Flanged brg.
1	Main Set	FP-MBK300130	30	w/Flanged brg.
1	Main Set	FP-MBK300	STD	w/Thrust washer
1	Main Set	FP-MBK30010	10	w/Thrust washer
1	Main Set	FP-MBK30020	20	w/Thrust washer
1	Main Set	FP-MBK30030	30	w/Thrust washer
<b>QTY</b>	<b>OIL PUMP</b>	<b>PART NO.</b>	<b>SIZE</b>	<b>DESCRIPTION</b>
2	O-Ring	FP-A4730R		Dipstick
1	O-Ring	FP-R495R		Pump intake tube; Smooth
1	Oil Filter Seal Ring	FP-R26163		Filter body
1	Oil Filter Housing Gasket	FP-R26354		
<b>CYLINDER COMPONENTS</b>				
<b>QTY</b>	<b>LINERS</b>	<b>PART NO.</b>	<b>SIZE</b>	<b>DESCRIPTION</b>
4	Sealing Ring, Liner	FP-112847		To Ser. No. 357,083
<b>QTY</b>	<b>PISTONS</b>	<b>PART NO.</b>	<b>SIZE</b>	<b>DESCRIPTION</b>
4	Pin Bushing	FP-3129YA20		1.252" ID, 1.3785" OD, 1.510" O.A.L.
<b>QTY</b>	<b>CONNECTING RODS &amp; BRGS.</b>	<b>PART NO.</b>	<b>SIZE</b>	<b>DESCRIPTION</b>
4	Rod Pair	FP-AR45723	STD	
4	Rod Pair	FP-AR46396	10	
4	Rod Pair	FP-AR46397	20	
4	Rod Pair	FP-AR46398	30	
<b>56</b> Wheel Tractor 4241NG Eng. (Natural Gas). Loader Tractor 4241NG Eng. (Natural Gas). 3.9L 241 OHV NG L4, 4.25" Bore				
<b>CYL. HEAD &amp; PARTS</b>				
<b>QTY</b>	<b>VALVE</b>	<b>PART NO.</b>	<b>SIZE</b>	<b>DESCRIPTION</b>
16	Keeper	FP-41339		1 groove; Square cut key groove
16	Keeper	FP-T20077		1 groove; Square cut key groove; Hardened
16	Keeper, Bulk	VK-138B		1 groove; Square cut key groove; Carton of 1000
<b>QTY</b>	<b>VALVE SPRING</b>	<b>PART NO.</b>	<b>SIZE</b>	<b>DESCRIPTION</b>
8	Spring	FP-R26125		2.1200" Free Height

(continued on next page)



# John Deere Off Highway

Wheel Tractor 4241NG Eng. (Natural Gas). Loader Tractor 4241NG Eng. (Natural Gas). 56 3.9L 241 OHV NG L4, 4.25" Bore (cont.)				
<b>METERS</b>				
<b>QTY</b>	<b>METERS</b>	<b>PART NO.</b>	<b>SIZE</b>	<b>DESCRIPTION</b>
1	Hour Meter Housing Gasket	FP-R26173		
1	Speed/Hour Meter Gasket	FP-R44853		
<b>CAMSHAFT GROUP</b>				
<b>QTY</b>	<b>TIMING COVER</b>	<b>PART NO.</b>	<b>SIZE</b>	<b>DESCRIPTION</b>
1	Front Timing Cover Gasket	FP-R26084		
<b>QTY</b>	<b>CAMSHAFT/LIFTER</b>	<b>PART NO.</b>	<b>SIZE</b>	<b>DESCRIPTION</b>
8	Lifter	FP-R52773		
<b>COOLING SYSTEM</b>				
<b>QTY</b>	<b>WATER PUMP</b>	<b>PART NO.</b>	<b>SIZE</b>	<b>DESCRIPTION</b>
1	Shaft & Bearing Assembly	FP-JD9355		w/Pump housing marked R41313, R41317, R44116, R44119, R48742
<b>QTY</b>	<b>THERMOSTAT</b>	<b>PART NO.</b>	<b>SIZE</b>	<b>DESCRIPTION</b>
1	Thermostat	FP-R36846		w/Housing marked R41853, R42664; 180 Deg. to 200 Deg. range
1	Thermostat Cover Gasket	FP-R42694		One hole
<b>ENGINE BLOCK &amp; PARTS</b>				
<b>QTY</b>	<b>GASKETS</b>	<b>PART NO.</b>	<b>SIZE</b>	<b>DESCRIPTION</b>
1	Washer	FP-B3586R		Oil filter cover packing
<b>QTY</b>	<b>CAM BEARINGS</b>	<b>PART NO.</b>	<b>SIZE</b>	<b>DESCRIPTION</b>
1	Cam Set	FP-3R46903	STD	
3	Cam Brg.	FP-R46903	STD	
<b>CRANKSHAFT/OIL PUMP</b>				
<b>QTY</b>	<b>SEALS - FRONT CRANK</b>	<b>PART NO.</b>	<b>SIZE</b>	<b>DESCRIPTION</b>
1	Oil Seal Kit	FP-AR49025		
<b>QTY</b>	<b>SEALS - REAR CRANK</b>	<b>PART NO.</b>	<b>SIZE</b>	<b>DESCRIPTION</b>
1	Oil Seal	FP-RE22764		PTFE
<b>QTY</b>	<b>MAIN BEARINGS</b>	<b>PART NO.</b>	<b>SIZE</b>	<b>DESCRIPTION</b>
1	Main Set	FP-MBK3001	STD	w/Flanged brg.
1	Main Set	FP-MBK300110	10	w/Flanged brg.
1	Main Set	FP-MBK300120	20	w/Flanged brg.
1	Main Set	FP-MBK300130	30	w/Flanged brg.
1	Main Set	FP-MBK300	STD	w/Thrust washer
1	Main Set	FP-MBK30010	10	w/Thrust washer
1	Main Set	FP-MBK30020	20	w/Thrust washer
1	Main Set	FP-MBK30030	30	w/Thrust washer
<b>QTY</b>	<b>OIL PUMP</b>	<b>PART NO.</b>	<b>SIZE</b>	<b>DESCRIPTION</b>
2	O-Ring	FP-A4730R		Dipstick
1	O-Ring	FP-R495R		Pump intake tube; Smooth
1	Oil Filter Seal Ring	FP-R26163		Filter body
1	Oil Filter Housing Gasket	FP-R26354		
<b>CYLINDER COMPONENTS</b>				
<b>QTY</b>	<b>LINERS</b>	<b>PART NO.</b>	<b>SIZE</b>	<b>DESCRIPTION</b>
4	Sealing Ring, Liner	FP-112847		To Ser. No. 357,083
<b>QTY</b>	<b>PISTONS</b>	<b>PART NO.</b>	<b>SIZE</b>	<b>DESCRIPTION</b>
4	Pin Bushing	FP-3129YA20		1.252" ID, 1.3785" OD, 1.510" O.A.L.
<b>QTY</b>	<b>CONNECTING RODS &amp; BRGS.</b>	<b>PART NO.</b>	<b>SIZE</b>	<b>DESCRIPTION</b>
4	Rod Pair	FP-AR45723	STD	
4	Rod Pair	FP-AR46396	10	
4	Rod Pair	FP-AR46397	20	
4	Rod Pair	FP-AR46398	30	
Combine 248G Eng. (Gas or LPG). Power Unit 248G Eng. (Gas or LPG). 57 4.1L 248 OHV L6, 3.875" Bore				
<b>CRANKSHAFT/OIL PUMP</b>				
<b>QTY</b>	<b>SEALS - REAR CRANK</b>	<b>PART NO.</b>	<b>SIZE</b>	<b>DESCRIPTION</b>
1	Crankshaft Rear Seal	FP-RE24959		

(continued on next page)

<b>57 Combine 248G Eng. (Gas or LPG). Power Unit 248G Eng. (Gas or LPG).</b> (cont.) 4.1L 248 OHV L6, 3.875" Bore				
<b>CYLINDER COMPONENTS</b>				
<b>QTY</b>	<b>PISTONS</b>	<b>PART NO.</b>	<b>SIZE</b>	<b>DESCRIPTION</b>
6	Pin Bushing	FP-2599Y20		
<b>QTY</b>	<b>CONNECTING RODS &amp; BRGS.</b>	<b>PART NO.</b>	<b>SIZE</b>	<b>DESCRIPTION</b>
6	Rod Pair	FP-2595A	STD	A-Series aluminum bearings
6	Rod Pair	FP-2595A10	10	A-Series aluminum bearings
6	Rod Pair	FP-2595A20	20	A-Series aluminum bearings
6	Rod Pair	FP-2595A30	30	A-Series aluminum bearings
<b>58 Combine 248D Eng. Power Unit 248D Eng.</b> 4.1L 248 OHV Diesel L6, 3.875" Bore				
<b>CRANKSHAFT/OIL PUMP</b>				
<b>QTY</b>	<b>SEALS - REAR CRANK</b>	<b>PART NO.</b>	<b>SIZE</b>	<b>DESCRIPTION</b>
1	Crankshaft Rear Seal	FP-RE24959		
<b>CYLINDER COMPONENTS</b>				
<b>QTY</b>	<b>PISTONS</b>	<b>PART NO.</b>	<b>SIZE</b>	<b>DESCRIPTION</b>
6	Pin Bushing	FP-2599Y20		
<b>QTY</b>	<b>CONNECTING RODS &amp; BRGS.</b>	<b>PART NO.</b>	<b>SIZE</b>	<b>DESCRIPTION</b>
6	Rod Pair	FP-2595A	STD	A-Series aluminum bearings
6	Rod Pair	FP-2595A10	10	A-Series aluminum bearings
6	Rod Pair	FP-2595A20	20	A-Series aluminum bearings
6	Rod Pair	FP-2595A30	30	A-Series aluminum bearings
<b>59 Loader 254D Eng. Power Unit 254D Eng. Wheel Tractor 254D Eng.</b> 4.2L 254 OHV Diesel L4, 4.125" Bore				
<b>CYL. HEAD &amp; PARTS</b>				
<b>QTY</b>	<b>VALVE</b>	<b>PART NO.</b>	<b>SIZE</b>	<b>DESCRIPTION</b>
4	Intake	FP-R26124	STD	1.7770" Head Dia., .3720" Stem Dia., 6.2580" O.A.L.
4	Exhaust	FP-R26123	STD	1.5900" Head Dia., .3720" Stem Dia., 6.2580" O.A.L.
4	Exhaust	FP-V4100	STD	1.5900" Head Dia., .3720" Stem Dia., 6.2580" O.A.L.
16	Keeper	FP-B367R		2 groove
16	Keeper	VK-66R		2 groove; Hardened
<b>QTY</b>	<b>VALVE SEAT</b>	<b>PART NO.</b>	<b>SIZE</b>	<b>DESCRIPTION</b>
4	Exh.	245-1625-1	Std Only	1.6300" OD, 1.3750" ID, .2160" Depth
<b>QTY</b>	<b>VALVE GUIDE</b>	<b>PART NO.</b>	<b>SIZE</b>	<b>DESCRIPTION</b>
8	Guide	FP-R28654		.3750" ID, 3.3130" O.A.L.
<b>QTY</b>	<b>VALVE SPRING</b>	<b>PART NO.</b>	<b>SIZE</b>	<b>DESCRIPTION</b>
8	Spring	FP-R26125		2.1200" Free Height
<b>QTY</b>	<b>VALVE SEAL</b>	<b>PART NO.</b>	<b>SIZE</b>	<b>DESCRIPTION</b>
8	Valve Stem Seal	ST-2004		Positive type; Installation requires valve guide machining; Rubber/PTFE
8	Valve Stem Seal Bulk	ST-2004BC		Positive type; Installation requires valve guide machining; Carton of 100; Rubber/PTFE
<b>ENGINE BLOCK &amp; PARTS</b>				
<b>QTY</b>	<b>CAM BEARINGS</b>	<b>PART NO.</b>	<b>SIZE</b>	<b>DESCRIPTION</b>
1	Cam Set	FP-3R46903	STD	
3	Cam Brg.	FP-R46903	STD	
<b>CRANKSHAFT/OIL PUMP</b>				
<b>QTY</b>	<b>SEALS - FRONT CRANK</b>	<b>PART NO.</b>	<b>SIZE</b>	<b>DESCRIPTION</b>
1	Oil Seal Kit	FP-AR49025		
<b>QTY</b>	<b>SEALS - REAR CRANK</b>	<b>PART NO.</b>	<b>SIZE</b>	<b>DESCRIPTION</b>
1	Oil Seal	FP-RE22764		PTFE
<b>QTY</b>	<b>MAIN BEARINGS</b>	<b>PART NO.</b>	<b>SIZE</b>	<b>DESCRIPTION</b>
1	Main Set	FP-MBK400E4	STD	w/Flanged brg.; w/Block marked R26150, R26160
1	Main Set	FP-MBK400E410	10	w/Flanged brg.; w/Block marked R26150, R26160
1	Main Set	FP-MBK400E420	20	w/Flanged brg.; w/Block marked R26150, R26160
1	Main Set	FP-MBK400E430	30	w/Flanged brg.; w/Block marked R26150, R26160
1	Main Set	FP-MBK400L4	STD	w/Thrust washer; w/Block marked R40910, R40920, R46350, R46430, R49540
1	Main Set	FP-MBK400L410	10	w/Thrust washer; w/Block marked R40910, R40920, R46350, R46430, R49540

(continued on next page)



# John Deere Off Highway

**Loader 254D Eng. Power Unit 254D Eng. Wheel Tractor 254D Eng. 59**  
4.2L 254 OHV Diesel L4, 4.125" Bore (cont.)

### CRANKSHAFT/OIL PUMP (cont.)

QTY	MAIN BEARINGS (cont.)	PART NO.	SIZE	DESCRIPTION
1	Main Set	FP-MBK400L420	20	w/Thrust washer; w/Block marked R40910, R40920, R46350, R46430, R49540

### CYLINDER COMPONENTS

QTY	LINERS	PART NO.	SIZE	DESCRIPTION
4	Liner w/o Sealing Ring	FP-R32050	STD	OVERBORE To 4.250"
4	Liner w/Sealing Rings	FP-R32050WS	STD	OVERBORE To 4.250"
4	Cylinder Kit Complete	FP-RE23173	STD	OVERBORE To 4.250"
4	Sealing Ring, Liner	FP-112847		OVERBORE To 4.250"

QTY	PISTONS	PART NO.	SIZE	DESCRIPTION
4	Piston Kit w/Pin & Retainers	FP-RE23172WP	STD	OVERBORE To 4.250"
4	Pin Bushing	FP-R30939		
4	Pin Bushing	FP-3129YA20		1.252" ID, 1.3785" OD, 1.510" O.A.L.

QTY	CONNECTING RODS & BRGS.	PART NO.	SIZE	DESCRIPTION
4	Rod Pair	FP-AR45723	STD	
4	Rod Pair	FP-AR46396	10	
4	Rod Pair	FP-AR46397	20	
4	Rod Pair	FP-AR46398	30	

QTY	PISTON RINGS	PART NO.	SIZE	DESCRIPTION
4	Ring Set Single Cylinder	FP-AR55630	STD	OVERBORE To 4.250"; 1-1/8, 1-3/32, 1-1/4 (1 cyl. set)
2	Premium Set	FP-AR55630S	STD	OVERBORE To 4.250"; 2-1/8, 2-3/32, 2-1/4 (2 cyl. set)
4	Premium Single Cylinder Set	W-9348KX + Std Only		OVERBORE To 4.250"; 1-1/8, 1-3/32, 1-1/4 (2 cyl. set); When depleted use FP-AR55630

### KITS

QTY	OVERHAUL KIT	PART NO.	SIZE	DESCRIPTION
1	Complete Overhaul Kit	FP-270EOHK		OVERBORE To 4.250"; Model 3010; w/Block marked R26150, R26160; Incl. Torque-To-Yield con. rod bolts

**Loader 4270D Eng. Wheel Tractor 4270D Eng. Loader Tractor 4270D Eng. Backhoe 4270D 60**  
Eng.  
4.4L 270 OHV Diesel L4, 4.25" Bore

### CYL. HEAD & PARTS

QTY	GASKETS	PART NO.	SIZE	DESCRIPTION
1	Valve Cover Gasket	FP-R49865		
1	Head Gasket	FP-R48292		From Ser. No. 280,001
1	Head Gasket	FP-R45616		To Ser. No. 280,000
1	Head Set	FP-AR53034		From Ser. No. 280,001
1	Head Set	FP-AR53032		To Ser. No. 280,000

QTY	HEAD BOLTS	PART NO.	SIZE	DESCRIPTION
4	Head Bolt	FP-R88042		w/Block marked R40620, R40700, R40910, R45950, R47520, R48430, R50610, R72127; From Ser. No. 280,001; 3.250" length
3	Head Bolt	FP-R88043		w/Block marked R40620, R40700, R40910, R45950, R47520, R48430, R50610, R72127; From Ser. No. 280,001; 5.250" length
6	Head Bolt	FP-R88044		w/Block marked R40620, R40700, R40910, R45950, R47520, R48430, R50610, R72127; From Ser. No. 280,001; 6.250" length
5	Head Bolt	FP-R88045		w/Block marked R40620, R40700, R40910, R45950, R47520, R48430, R50610, R72127; From Ser. No. 280,001; 7.250" length

QTY	VALVE	PART NO.	SIZE	DESCRIPTION
4	Intake	FP-R44174	STD	From Ser. No. 157,002 to Ser. No. 280,000; 2 groove; Chrome plated stem; 1.9020" Head Dia., .3720" Stem Dia., 6.2450" O.A.L.
4	Intake	FP-R43883	STD	From Ser. No. 280,001; 1 groove; Chrome plated stem; 1.9020" Head Dia., .3720" Stem Dia., 6.1510" O.A.L.
4	Intake	FP-R45003	3	From Ser. No. 280,001; 1 groove; Chrome plated stem; 1.9020" Head Dia., .3750" Stem Dia., 6.1510" O.A.L.
4	Intake	FP-R45005	30	From Ser. No. 280,001; 1 groove; Chrome plated stem; 1.9020" Head Dia., .4020" Stem Dia., 6.1510" O.A.L.
4	Intake	FP-R26124	STD	To Ser. No. 157,001; 1.7770" Head Dia., .3720" Stem Dia., 6.2580" O.A.L.

(continued on next page)

**60** Loader 4270D Eng. Wheel Tractor 4270D Eng. Loader Tractor 4270D Eng. Backhoe 4270D  
 (cont.) Eng.  
 4.4L 270 OHV Diesel L4, 4.25" Bore

CYL. HEAD & PARTS (cont.)				
QTY	VALVE (cont.)	PART NO.	SIZE	DESCRIPTION
4	Exhaust	FP-R44175	STD	From Ser. No. 157,002 to Ser. No. 280,000; 2 groove; Chrome plated stem; 1.7150" Head Dia., .3720" Stem Dia., 6.2270" O.A.L.
4	Exhaust	FP-R43679	STD	From Ser. No. 280,001; 1 groove; Chrome plated stem; 1.7150" Head Dia., .3720" Stem Dia., 6.1330" O.A.L.
4	Exhaust	FP-R43787	3	From Ser. No. 280,001; 1 groove; Chrome plated stem; 1.7150" Head Dia., .3750" Stem Dia., 6.1330" O.A.L.
4	Exhaust	FP-R43788	15	From Ser. No. 280,001; 1 groove; Chrome plated stem; 1.7150" Head Dia., .3870" Stem Dia., 6.1330" O.A.L.
4	Exhaust	FP-R43789	30	From Ser. No. 280,001; 1 groove; Chrome plated stem; 1.7150" Head Dia., .4020" Stem Dia., 6.1330" O.A.L.
4	Exhaust	FP-R26123	STD	To Ser. No. 157,001; 1.5900" Head Dia., .3720" Stem Dia., 6.2580" O.A.L.
16	Keeper	FP-B367R		Model JD500 To Ser. No. 123,113; 2 groove
16	Keeper	VK-66R		Model JD500 To Ser. No. 123,113; 2 groove; Hardened
16	Keeper	FP-41339		Model 3020 From Ser. No. 123,000; 1 groove; Square cut key groove
16	Keeper	FP-T20077		Model 3020 From Ser. No. 123,000; 1 groove; Square cut key groove; Hardened
16	Keeper	FP-B367R		Model 3020 To Ser. No. 122,999; 2 groove
16	Keeper	VK-66R		Model 3020 To Ser. No. 122,999; 2 groove; Hardened
16	Keeper	FP-41339		Models JD500A, JD500B From Ser. No. 123,114; 1 groove; Square cut key groove
16	Keeper	FP-T20077		Models JD500A, JD500B From Ser. No. 123,114; 1 groove; Square cut key groove; Hardened
16	Keeper, Bulk	VK-138B		Model 3020 From Ser. No. 123,000; 1 groove; Square cut key groove; Carton of 1000
16	Keeper, Bulk	VK-138B		Models JD500A, JD500B From Ser. No. 123,114; 1 groove; Square cut key groove; Carton of 1000
QTY	VALVE SEAT	PART NO.	SIZE	DESCRIPTION
4	Exh.	FP-R43681	STD	1.7555" OD, 1.5000" ID, .2480" Depth
4	Int.	FP-R43680	STD	
QTY	VALVE GUIDE	PART NO.	SIZE	DESCRIPTION
8	Guide	FP-R28654		Model JD500 To Ser. No. 123,113; .3750" ID, 3.3130" O.A.L.
8	Guide	FP-R28654		Model 3020 To Ser. No. 122,999; .3750" ID, 3.3130" O.A.L.
QTY	VALVE SPRING	PART NO.	SIZE	DESCRIPTION
8	Spring	FP-R26125		2.1200" Free Height
QTY	VALVE MISC.	PART NO.	SIZE	DESCRIPTION
4	Rotocap	FP-RE11410		Exh.; Model 3020 From Ser. No. 123,000
4	Rotocap	FP-RE11410		Exh.; Models JD500A, JD500B From Ser. No. 123,114
QTY	VALVE SEAL	PART NO.	SIZE	DESCRIPTION
4	Valve Stem Seal	ST-2011		Int.; Model JD500 To Ser. No. 123,113; Positive type; Rubber/PTFE
4	Valve Stem Seal	ST-2011		Int.; Model 3020 To Ser. No. 122,999; Positive type; Rubber/PTFE
4	Valve Stem Seal Bulk	ST-2011BC		Int.; Model JD500 To Ser. No. 123,113; Positive type; Carton of 100; Rubber/PTFE
4	Valve Stem Seal Bulk	ST-2011BC		Int.; Model 3020 To Ser. No. 122,999; Positive type; Carton of 100; Rubber/PTFE
METERS				
QTY	METERS	PART NO.	SIZE	DESCRIPTION
1	Hour Meter Housing Gasket	FP-R26173		
1	Speed/Hour Meter Gasket	FP-R44853		
INT & EXH MANIFOLDS				
QTY	INT. & EXH. MANIFOLDS	PART NO.	SIZE	DESCRIPTION
2	Exhaust Manifold Gasket	FP-R83021		One Exh. hole
2	Exhaust Manifold Gasket	FP-R83020		Two Exh. holes
2	Intake Manifold Gasket	FP-R26297		
1	Cyl. Block Valley Cover Gskt.	FP-R46192		
CAMSHAFT GROUP				
QTY	TIMING COVER	PART NO.	SIZE	DESCRIPTION
1	Crankshaft Front Cover Gasket	FP-R26058		
1	Front Timing Cover Gasket	FP-R26084		

(continued on next page)



# John Deere Off Highway

Loader 4270D Eng. Wheel Tractor 4270D Eng. Loader Tractor 4270D Eng. Backhoe 4270D **60**  
 Eng. (cont.)  
 4.4L 270 OHV Diesel L4, 4.25" Bore

CAMSHAFT GROUP (cont.)				
QTY	CAMSHAFT/LIFTER	PART NO.	SIZE	DESCRIPTION
1	Camshaft Plug	FP-R26115		
8	Lifter	FP-R52773		From Ser. No. 280,001
8	Lifter	FP-R26342		To Ser. No. 280,000
FUEL SYSTEM & PARTS				
QTY	FUEL INJECTION	PART NO.	SIZE	DESCRIPTION
8	Clamp	FP-R34766		From Ser. No. 68,000
QTY	FUEL FILTERS & PUMP	PART NO.	SIZE	DESCRIPTION
1	Mechanical Fuel Pump	FP-RE42211		From Ser. No. 280,001; Transfer pump
1	Mechanical Fuel Pump	FP-RE43273		To Ser. No. 280,000
COOLING SYSTEM				
QTY	WATER PUMP	PART NO.	SIZE	DESCRIPTION
1	Water Pump Impeller	FP-R40979		w/Pump housing marked R41315, R44122
1	Water Pump Repair/Rebuild Kit	FP-AR55617		w/Pump housing marked R26337, R27547, R34964
1	Water Pump Repair/Rebuild Kit	FP-AR98564		w/Pump housing marked R34964
1	Water Pump Repair/Rebuild Kit	FP-AR55619		w/Pump housing marked R41315, R41318, R44122, R48743
1	Water Pump Housing Gasket	FP-R26343		w/Pump housing marked R41315, R44122
1	Water Pump Mounting Gasket	FP-R26341		w/Pump housing marked R41315, R44122
4	O-Ring	FP-T13119		Manifold bypass tubes
1	Shaft & Bearing Assembly	FP-JD9212		w/Pump housing marked R26337, R27544, R34977, R34982
1	Shaft & Bearing Assembly	FP-JD9355		w/Pump housing marked R41315, R41318, R44122, R48743
QTY	THERMOSTAT	PART NO.	SIZE	DESCRIPTION
1	Thermostat	FP-R36846		w/Housing marked R41853, R42664; 180 Deg. to 200 Deg. range
1	Thermostat Cover Gasket	FP-R42694		One hole
QTY	MISCELLANEOUS	PART NO.	SIZE	DESCRIPTION
2	Water Manifold Mounting Gskt.	FP-R88397		
ENGINE BLOCK & PARTS				
QTY	GASKETS	PART NO.	SIZE	DESCRIPTION
1	Oil Pan Gasket	FP-R71917		To Ser. No. 280,000
1	Oil Pan Gasket Set	FP-PG402PS		To Ser. No. 280,000
1	Washer	FP-B3586R		Oil filter cover packing
QTY	GASKET SETS	PART NO.	SIZE	DESCRIPTION
1	In-Frame Gasket Set	FP-PG270LS		From Ser. No. 280,001
1	In-Frame Gasket Set	FP-PG270ES		To Ser. No. 280,000
1	Complete Overhaul Gasket Set	FP-AR53035		From Ser. No. 280,001; Crankshaft oil seals not incl.
1	Complete Overhaul Gasket Set	FP-AR53035WS		From Ser. No. 280,001; Incl. Crankshaft oil seals
1	Complete Overhaul Gasket Set	FP-AR53033WS		To Ser. No. 280,000; Compl.; Incl. RMB seal w/wear sleeve; Incl. timing cover seal w/ wear sleeve
1	Complete Overhaul Gasket Set	FP-AR53033		To Ser. No. 280,000; RMB seal w/wear sleeve not incl.; Timing cover seal w/wear sleeve not incl.
1	Kit Gasket Set	260-1395 +		From Ser. No. 123,000 Model 3020; From Ser. No. 123,114 Models JD500A, JD500B; Compl.; Incl. RMB seal & wear sleeve; Incl. timing cover seal & wear sleeve; When depleted use FP-AR53035WS
QTY	CAM BEARINGS	PART NO.	SIZE	DESCRIPTION
1	Cam Set	FP-3R46903	STD	
3	Cam Brg.	FP-R46903	STD	
QTY	OIL COOLERS & FILTERS	PART NO.	SIZE	DESCRIPTION
1	Oil Cooler Base Hsg. Gasket	FP-R34110		To Ser. No. 280,000
1	Oil Cooler Base Gasket	FP-R34109		
1	Oil Cooler Top Gasket	FP-R32123		
CRANKSHAFT/OIL PUMP				
QTY	CRANKSHAFT	PART NO.	SIZE	DESCRIPTION
1	Crankshaft	FP-AR40485		Crankshaft marked R40570
1	Crankshaft	FP-AR26428		To Ser. No. 122,999; w/Balancer drive gears; Crankshaft marked R26540, R46498
1	Oil Seal Kit	FP-SK49025		Incl. front & rear seals
QTY	SEALS - FRONT CRANK	PART NO.	SIZE	DESCRIPTION
1	Oil Seal Kit	FP-AR49025		
QTY	SEALS - REAR CRANK	PART NO.	SIZE	DESCRIPTION
1	Oil Seal	FP-RE22764		PTFE

(continued on next page)

**60** Loader 4270D Eng. Wheel Tractor 4270D Eng. Loader Tractor 4270D Eng. Backhoe 4270D Eng.  
 (cont.) Eng.  
 4.4L 270 OHV Diesel L4, 4.25" Bore

### CRANKSHAFT/OIL PUMP (cont.)

QTY	MAIN BEARINGS	PART NO.	SIZE	DESCRIPTION
1	Main Set	FP-MBK400L4	STD	From Ser. No. 280,001
1	Main Set	FP-MBK400L410	10	From Ser. No. 280,001
1	Main Set	FP-MBK400L420	20	From Ser. No. 280,001
1	Main Set	FP-MBK400E4	STD	To Ser. No. 280,000; w/Flanged brg.
1	Main Set	FP-MBK400E410	10	To Ser. No. 280,000; w/Flanged brg.
1	Main Set	FP-MBK400E420	20	To Ser. No. 280,000; w/Flanged brg.
1	Main Set	FP-MBK400E430	30	To Ser. No. 280,000; w/Flanged brg.
4	Plain Main Brg.	FP-AR74814	STD	From Ser. No. 280,001
4	Plain Main Brg.	FP-AR74816	10	From Ser. No. 280,001
4	Plain Main Brg.	FP-AR74817	20	From Ser. No. 280,001
4	Plain Main Brg.	FP-AR74818	30	From Ser. No. 280,001
4	Plain Main Brg.	FP-AR49243	STD	To Ser. No. 280,000
4	Plain Main Brg.	FP-AR49245	10	To Ser. No. 280,000
4	Plain Main Brg.	FP-AR49246	20	To Ser. No. 280,000
4	Plain Main Brg.	FP-AR49247	30	To Ser. No. 280,000
1	Flanged Main Brg.	FP-AR77748	STD	
1	Flanged Main Brg.	FP-AR77750	10	
1	Flanged Main Brg.	FP-AR77751	20	
1	Flanged Main Brg.	FP-AR77752	30	
1	Flanged Main Brg.	FP-AR77754	STD	Flangeless; To Ser. No. 280,000
1	Flanged Main Brg.	FP-AR77756	10	Flangeless; To Ser. No. 280,000
1	Flanged Main Brg.	FP-AR77757	20	Flangeless; To Ser. No. 280,000
1	Flanged Main Brg.	FP-AR77758	30	Flangeless; To Ser. No. 280,000
1	Flanged Main Brg.	FP-AR49242	STD	To Ser. No. 280,000
1	Flanged Main Brg.	FP-AR49238	10	To Ser. No. 280,000
1	Flanged Main Brg.	FP-AR49239	20	To Ser. No. 280,000
1	Flanged Main Brg.	FP-AR49240	30	To Ser. No. 280,000
1	Thrust Washer Set	FP-AR77747	STD	Use w/Flangeless main brg.

QTY	OIL PUMP	PART NO.	SIZE	DESCRIPTION
1	Oil Pump Spring	FP-R26151		
2	O-Ring	FP-A4730R		Dipstick
1	O-Ring	FP-R495R		Pump intake tube; Smooth
1	O-Ring	FP-R495R		Ventilator tube; Smooth
1	Oil Filter Seal Ring	FP-R26163		Filter body
1	Oil Filter Housing Gasket	FP-R26354		

### CYLINDER COMPONENTS

QTY	LINERS	PART NO.	SIZE	DESCRIPTION
4	Liner w/o Sealing Ring	FP-R40615	STD	Model 3020 From Ser. No. 123,000
4	Liner w/o Sealing Ring	FP-R40615	STD	Model 3020 To Ser. No. 122,999 w/Block marked R40930
4	Liner w/o Sealing Ring	FP-R40615	STD	Models JD500, JD500A, JD500B From Ser. No. 123,114
4	Liner w/o Sealing Ring	FP-R40615	STD	Models JD500, JD500A, JD500B To Ser. No. 123,113 w/Block marked R40930
4	Liner w/o Sealing Ring	FP-R32050	STD	To Ser. No. 280,000
4	Liner w/Sealing Rings	FP-R40615WS	STD	Model 3020 From Ser. No. 123,000
4	Liner w/Sealing Rings	FP-R40615WS	STD	Model 3020 To Ser. No. 122,999 w/Block marked R40930
4	Liner w/Sealing Rings	FP-R40615WS	STD	Models JD500, JD500A, JD500B From Ser. No. 123,114
4	Liner w/Sealing Rings	FP-R40615WS	STD	Models JD500, JD500A, JD500B To Ser. No. 123,113 w/Block marked R40930
4	Liner w/Sealing Rings	FP-R32050WS	STD	To Ser. No. 280,000
4	Cylinder Kit Complete	FP-RE23173	STD	w/Block marked R26160, R32020, R40850, R46385; w/Con. Rod marked R26047, R52225, R58880, R66923; To Ser. No. 280,000
4	Cylinder Kit Complete	FP-LKRE23163	STD	w/Block marked R26160, R32020, R40850, R46385; w/Con. Rod marked R26047, R52225, R58880, R66923; To Ser. No. 280,000; High Ring
4	Cylinder Kit Complete	FP-RE23165	STD	w/Block marked R40620, R40700, R47520, R45950, R48430, R50610, R72127; w/Con. Rod marked R26047, R52225, R58880, R66923; From Ser. No. 280,001
4	Cylinder Kit Complete	FP-RE23170	STD	Replacement Block; w/Block marked R46350, R46430, R40910; w/Con. Rod marked R26047, R52225, R58880, R66923; To Ser. No. 280,000
4	Cyl. Liner Sealing Ring Kit	FP-AR65507		
4	Cyl. Liner Sealing Ring Kit	FP-AR40155		To Ser. No. 280,000
4	Sealing Ring, Liner	FP-R48767		Rectangle; Top
4	Sealing Ring, Liner	FP-R26121		Round; Middle
4	Sealing Ring, Liner	FP-112847		To Ser. No. 357,083
4	Sealing Ring	FP-SLR2520		From Ser. No. 123,000; Round; Bottom

(continued on next page)





**Loader 4270D Eng. Wheel Tractor 4270D Eng. Loader Tractor 4270D Eng. Backhoe 4270D 60**  
**Eng. (cont.)**  
 4.4L 270 OHV Diesel L4, 4.25" Bore

**CYLINDER COMPONENTS (cont.)**

QTY	PISTONS	PART NO.	SIZE	DESCRIPTION
4	Piston Body w/o Pin	FP-RE23168		From Ser. No. 280,001
4	Piston Body w/o Pin	FP-RE23172		Replacement Block; To Ser. No. 280,000
4	Piston Kit w/Pin & Retainers	FP-RE23168WP	STD	From Ser. No. 280,001
4	Piston Kit w/Pin & Retainers	FP-RE23172WP	STD	Replacement Block; To Ser. No. 280,000
4	Pin	FP-R44161		
8	Piston Pin Retainer	FP-H80753		To Ser. No. 280,000
4	Pin Bushing	FP-R30939		w/Con. Rod marked R26047, R52225, R58880, R66923
4	Pin Bushing	FP-3129YA20		1.252" ID, 1.3785" OD, 1.510" O.A.L.

QTY	CONNECTING RODS & BRGS.	PART NO.	SIZE	DESCRIPTION
8	Con. Rod Bolt	FP-R66452		w/Con. Rod marked R26047, R52225, R58880, R66923; Torque-To-Yield bolt; Replacement recommended
4	Rod Pair	FP-AR45723	STD	
4	Rod Pair	FP-AR46396	10	
4	Rod Pair	FP-AR46397	20	
4	Rod Pair	FP-AR46398	30	

QTY	PISTON RINGS	PART NO.	SIZE	DESCRIPTION
4	Ring Set Single Cylinder	FP-AR55630	STD	Check piston grooving before supplying ring set; 1-1/8, 1-3/32, 1-1/4 (1 cyl. set)
2	Premium Set	FP-AR55630S	STD	Check piston grooving before supplying ring set; 2-1/8, 2-3/32, 2-1/4 (2 cyl. set)
4	Premium Single Cylinder Set	W-9348KX + Std Only		Check piston grooving before supplying ring set; 1-1/8, 1-3/32, 1-1/4 (2 cyl. set); When depleted use FP-AR55630

**KITS**

QTY	OVERHAUL KIT	PART NO.	SIZE	DESCRIPTION
1	In-Frame Overhaul Kit	FP-270EIFK		w/Block marked R26160, R32020, R40850, R46385; w/Con. Rod marked R26047, R52225, R58880, R66923; To Ser. No. 280,000; Incl. Torque-To-Yield con. rod bolts
1	In-Frame Overhaul Kit	FP-270LIFK		w/Block marked R40620, R40700, R47520, R45950, R48430, R50610, R72127; w/Con. Rod marked R26047, R52225, R58880, R66923; From Ser. No. 280,001; Incl. Torque-To-Yield con. rod bolts
1	In-Frame Overhaul Kit	FP-270RBIFK		Replacement Block; w/Block marked R46350, R46430, R40910; w/Con. Rod marked R26047, R52225, R58880, R66923; To Ser. No. 280,000; Incl. Torque-To-Yield con. rod bolts
1	Complete Overhaul Kit	FP-270EOHK		w/Block marked R26160, R32020, R40850, R46385; w/Con. Rod marked R26047, R52225, R58880, R66923; To Ser. No. 280,000; Incl. Torque-To-Yield con. rod bolts
1	Complete Overhaul Kit	FP-270LOHK		w/Block marked R40620, R40700, R47520, R45950, R48430, R50610, R72127; w/Con. Rod marked R26047, R52225, R58880, R66923; From Ser. No. 280,001; Incl. Torque-To-Yield con. rod bolts
1	Complete Overhaul Kit	FP-270RBOHK		Replacement Block; w/Block marked R46350, R46430, R40910; w/Con. Rod marked R26047, R52225, R58880, R66923; To Ser. No. 280,000; Incl. Torque-To-Yield con. rod bolts

**Power Unit 4045H PowerTech Eng. (2-Valve Cyl. Head). Wheel Tractor 4045H PowerTech 61**  
**Eng. (2-Valve Cyl. Head). Crawler Tractor 4045H PowerTech Eng. (2-Valve Cyl. Head).**  
**Loader Tractor 4045H PowerTech Eng. (2-Valve Cyl. Head). Forestry Tractor 4045H**  
**PowerTech Eng. (2-Valve Cyl. Head). Excavator 4045H PowerTech Eng. (2-Valve Cyl.**  
**Head). Integrated Tool Carrier 4045H PowerTech Eng. (2-Valve Cyl. Head). Telehandler**  
**4045H PowerTech Eng. (2-Valve Cyl. Head).**  
 4.5L 275.8 (4522cc) OHV Turbo-Diesel L4 (PowerTech 2V IC), 106mm Bore

**CYL. HEAD & PARTS**

QTY	GASKETS	PART NO.	SIZE	DESCRIPTION
1	Valve Cover Gasket	FP-R123542		
1	Head Gasket	FP-R116515		
1	Head Set	FP-RE66082		

QTY	VALVE	PART NO.	SIZE	DESCRIPTION
4	Intake	FP-R98062	STD	1 groove; Chrome plated stem; 1.8350" Head Dia., .3100" Stem Dia., 5.2780" O.A.L.
4	Intake	FP-R97490	15	1 groove; Chrome plated stem; 1.8350" Head Dia., .3250" Stem Dia., 5.2780" O.A.L.
4	Exhaust	FP-R90692	STD	1 groove; Chrome plated stem; 1.6730" Head Dia., .3095" Stem Dia., 5.2550" O.A.L.

(continued on next page)  
 + Superseded Part Number

**61** *Power Unit 4045H PowerTech Eng. (2-Valve Cyl. Head). Wheel Tractor 4045H PowerTech Eng. (2-Valve Cyl. Head). Crawler Tractor 4045H PowerTech Eng. (2-Valve Cyl. Head). Loader Tractor 4045H PowerTech Eng. (2-Valve Cyl. Head). Forestry Tractor 4045H PowerTech Eng. (2-Valve Cyl. Head). Excavator 4045H PowerTech Eng. (2-Valve Cyl. Head). Integrated Tool Carrier 4045H PowerTech Eng. (2-Valve Cyl. Head). Telehandler 4045H PowerTech Eng. (2-Valve Cyl. Head).*  
 4.5L 275.8 (4522cc) OHV Turbo-Diesel L4 (PowerTech 2V IC), 106mm Bore

### CYL. HEAD & PARTS (cont.)

QTY	VALVE (cont.)	PART NO.	SIZE	DESCRIPTION
4	Exhaust	FP-R97492	15	1 groove; Chrome plated stem; 1.6730" Head Dia., .3245" Stem Dia., 5.2550" O.A.L.
16	Keeper	FP-R91889		Exh. & Int.
QTY	VALVE SEAT	PART NO.	SIZE	DESCRIPTION
4	Exh.	FP-R85687	STD	
4	Int.	FP-R98335		.020" Dia. O/S face width; 1.8575" OD, 1.5500" ID, .2580" Depth
4	Int.	FP-R98063	STD	1.8575" OD, 1.5500" ID, .2580" Depth
QTY	VALVE SPRING	PART NO.	SIZE	DESCRIPTION
8	Spring	FP-R26125		Exh. & Int.; 2.1200" Free Height
QTY	VALVE MISC.	PART NO.	SIZE	DESCRIPTION
8	Rotocap	FP-RE60005		Exh. & Int.
QTY	VALVE SEAL	PART NO.	SIZE	DESCRIPTION
8	Valve Stem Seal	FP-RE31617		Exh. & Int.; Positive type

### ELECTRICAL

QTY	ELECTRICAL	PART NO.	SIZE	DESCRIPTION
1	Starter to Block Gasket	FP-R53108		3-Hole mount; Starting motor codes 3005, 3006, 3010, 3011, 3012

### FUEL SYSTEM & PARTS

QTY	FUEL INJECTION	PART NO.	SIZE	DESCRIPTION
4	Fuel Injector Nozzle	FP-RE48786		Nozzle codes 16BF, 16CE, 16CM, 16GL, 16LP, 16LQ, 16NH, 16OR, 16OS, 1606, 1608, 1675, 1677, 1682, 1683, 1692, 1694, 1695
4	Fuel Injector Nozzle	FP-RE48786		4045H Engs.; Nozzle codes 160B, 160C, 1610, 1611, 1656, 1667
4	Fuel Injector Seal	FP-R92352		Upper packing; w/Injector nozzle codes 16BF, 16CE, 16CM, 16CV, 16GL, 16LP, 16LQ, 16NH, 16OR, 1605, 1606, 1608, 1656, 1667, 1675, 1677, 1682, 1683, 1692, 1694, 1695
4	Fuel Injector Seal	FP-R92352		4045H Engs.; Upper packing; w/Injector nozzle codes 160B, 160C, 1610, 1611
4	Fuel Injector Nut	FP-R79604		w/Injector nozzle codes 16HM, 16HN, 16HP, 16HQ, 16LK, 16LL
1	Washer Type Seal	FP-R51936		Aux. drive line; Line codes 5201, 5202, 5203, 5205, 5206
2	Washer Type Seal	FP-R51936		Fuel line; Aftercooled; Line codes 160B, 1611
2	Washer Type Seal	FP-R51936		Fuel line; Line codes 16BF, 16CE, 16CM, 16CV, 16GL, 16LN, 16LP, 16LQ, 16NH, 16OR, 1605, 1671, 1677, 1682

### COOLING SYSTEM

QTY	WATER PUMP	PART NO.	SIZE	DESCRIPTION
1	Water Pump - Heavy Duty	FP-RE500737 *		Standard flow
1	Water Pump Filter	FP-R98527		w/Pump housing marked RE70683

### ENGINE BLOCK & PARTS

QTY	GASKETS	PART NO.	SIZE	DESCRIPTION
1	Oil Pan Gasket	FP-R97342		Oil pan codes 1904, 1905; w/Stamped Steel Pan
2	O-Ring	FP-U13639		Block coolant drain plug seal; Coolant heater codes 2601, 2602; 1.475" X .118"
QTY	CAM BEARINGS	PART NO.	SIZE	DESCRIPTION
1	Cam Brg.	FP-R119874		
QTY	ENGINE BEARING MISC.	PART NO.	SIZE	DESCRIPTION
4	Balance Shaft Bearing	FP-R115299		4045H Engs.; Balance shaft code 4501

### CRANKSHAFT/OIL PUMP

QTY	SEALS - FRONT CRANK	PART NO.	SIZE	DESCRIPTION
1	Crankshaft Front Seal	FP-AR67942		
QTY	SEALS - REAR CRANK	PART NO.	SIZE	DESCRIPTION
1	Crankshaft Rear Seal	FP-RE24959		
QTY	MAIN BEARINGS	PART NO.	SIZE	DESCRIPTION
4	Plain Main Brg.	FP-RE65165	STD	Crankshaft and Bearing code 4701
4	Plain Main Brg.	FP-RE65911	.25MM	Crankshaft and Bearing code 4701
1	Flanged Main Brg.	FP-RE65168	STD	Crankshaft and Bearing code 4701

(continued on next page)



# John Deere Off Highway

**Power Unit 4045H PowerTech Eng. (2-Valve Cyl. Head). Wheel Tractor 4045H PowerTech 61 Eng. (2-Valve Cyl. Head). Crawler Tractor 4045H PowerTech Eng. (2-Valve Cyl. Head). (cont.) Loader Tractor 4045H PowerTech Eng. (2-Valve Cyl. Head). Forestry Tractor 4045H PowerTech Eng. (2-Valve Cyl. Head). Excavator 4045H PowerTech Eng. (2-Valve Cyl. Head). Integrated Tool Carrier 4045H PowerTech Eng. (2-Valve Cyl. Head). Telehandler 4045H PowerTech Eng. (2-Valve Cyl. Head).**  
 4.5L 275.8 (4522cc) OHV Turbo-Diesel L4 (PowerTech 2V IC), 106mm Bore

## CRANKSHAFT/OIL PUMP (cont.)

QTY	MAIN BEARINGS (cont.)	PART NO.	SIZE	DESCRIPTION
1	Flanged Main Brg.	FP-RE65912	.25MM	Crankshaft and Bearing code 4701

## CYLINDER COMPONENTS

QTY	LINERS	PART NO.	SIZE	DESCRIPTION
4	Liner w/o Sealing Ring	FP-R121867	STD	
4	Liner w/Sealing Rings	FP-RE500024	STD	
4	Cylinder Kit Complete	FP-RE507920	STD	Piston, Con. Rod, Cyl. liner code 4803; To Ser. No. 825,562
4	Cylinder Kit Complete	FP-RE507850	STD	4045H Eng.s.; Piston, Con. Rod, Cyl. liner code 4809; w/Con. Rod marked R500335
4	Cyl. Liner Sealing Ring Kit	FP-AR65507		

QTY	PISTONS	PART NO.	SIZE	DESCRIPTION
4	Piston Body w/o Pin	FP-RE505100	STD	Piston, Con. Rod, Cyl. liner code 4803; To Ser. No. 825,562; w/Con. Rod marked R123959; Small Pin
4	Piston Body w/o Pin	FP-RE55512	STD	Piston, Con. Rod, Cyl. liner code 4809; Large Pin; w/Con. Rod marked R500335
4	Pin	FP-R123178		Piston, Con. Rod, Cyl. liner code 4803; To Ser. No. 825,562; w/Con. Rod marked R123959; Small Pin; 1.375" pin dia.
4	Pin	FP-R123177		4045H Eng.s.; Piston, Con. Rod, Cyl. liner code 4809; w/Con. Rod marked R500335; Large Pin; 1.62" pin dia.
8	Piston Pin Retainer	FP-M41029		w/Con. Rod marked R123959; Small Pin; For 1.38" pin dia.
8	Piston Pin Retainer	FP-R54114		4045H Eng.s.; w/Con. Rod marked R500335; Large Pin; For 1.62" pin dia.
4	Pin Bushing	FP-R123960		w/Con. Rod marked R123959; Small Pin; 1.375" pin dia.
4	Pin Bushing	FP-R114082		4045H Eng.s.; w/Con. Rod marked R500335; Large Pin
4	Piston Pin Kit	FP-RE63915		4045H Eng.s.; Piston, Con. Rod, Cyl. liner code 4809; w/Con. Rod marked R500335; Large Pin; Incl. Pin, Retainers & Bushing

QTY	CONNECTING RODS & BRGS.	PART NO.	SIZE	DESCRIPTION
8	Con. Rod Bolt	FP-R114083		Cyl. Liner code 4803; w/Con. Rod marked R123959; To Ser. No. 793,991; Small Pin
8	Con. Rod Bolt	FP-R501124		Cyl. Liner code 4803; w/Con. Rod marked R123959, R500000; From Ser. No. 36,628
8	Con. Rod Bolt	FP-R501124		Cyl. Liner code 4809; w/Con. Rod marked R500000; From Ser. No. 36,628
8	Con. Rod Bolt	FP-R114083		Cyl. Liner code 4809; w/Con. Rod marked R500335; To Ser. No. 793,991
8	Con. Rod Bolt	FP-R501124		4045H Eng.s.; Cyl. Liner code 4809; w/Con. Rod marked R500335; From Ser. No. 36,628
8	Con. Rod Bolt	FP-R114083		4045H Eng.s.; Cyl. Liner code 4809; w/Con. Rod marked R500335; To Ser. No. 793,991; Small Pin
4	Rod Pair	FP-RE65908	STD	Cyl. Liner code 4809; w/Con. Rod marked R500335
4	Rod Pair	FP-RE65909	.25MM	Cyl. Liner code 4809; w/Con. Rod marked R500335
4	Rod Pair	FP-RE65908	STD	Cyl. Liner codes 4801, 4803; w/Con. Rod marked R123959, R500000
4	Rod Pair	FP-RE65909	.25MM	Cyl. Liner codes 4801, 4803; w/Con. Rod marked R123959, R500000

QTY	PISTON RINGS	PART NO.	SIZE	DESCRIPTION
4	Ring Set Single Cylinder	FP-RE507852	STD	Use w/FP-RE55512 piston; 1-1/8, 1-3/32, 1-.136 (1 cyl. set)
4	Ring Set Single Cylinder	FP-RE66820	STD	Use w/FP-RE55512 piston; 1-1/8, 1-3/32, 1-.136 (1 cyl. set)
4	Ring Set Single Cylinder	FP-RE66271	STD	Use w/FP-RE59277 piston
4	Ring Set Single Cylinder	FP-RE66271	STD	4045H Eng.s.; Use w/RE505100 piston

## KITS

QTY	OVERHAUL KIT	PART NO.	SIZE	DESCRIPTION
1	In-Frame Overhaul Kit	FP-IFKPT4045T		Piston, Con. Rod, Cyl. liner code 4803; To Ser. No. 825,562

62 Power Unit 4045H PowerTech Eng. (4-Valve Cyl. Head). Wheel Tractor 4045H PowerTech Eng. (4-Valve Cyl. Head). 4.5L 275.8 (4522cc) OHV Turbo-Diesel L4 (PowerTech 4V IC), 106mm Bore				
<b>CYL. HEAD &amp; PARTS</b>				
<b>QTY</b>	<b>GASKETS</b>	<b>PART NO.</b>	<b>SIZE</b>	<b>DESCRIPTION</b>
1	Valve Cover Gasket	FP-R123542		
1	Head Gasket	FP-R116515		
1	Head Set	FP-RE66082		
<b>ELECTRICAL</b>				
<b>QTY</b>	<b>ELECTRICAL</b>	<b>PART NO.</b>	<b>SIZE</b>	<b>DESCRIPTION</b>
1	Starter to Block Gasket	FP-R53108		3-Hole mount; Starting motor codes 3005, 3006, 3010, 3011, 3012
<b>COOLING SYSTEM</b>				
<b>QTY</b>	<b>WATER PUMP</b>	<b>PART NO.</b>	<b>SIZE</b>	<b>DESCRIPTION</b>
1	Water Pump - Heavy Duty	FP-RE500737 *		Standard flow
1	Water Pump Filter	FP-R98527		w/Pump housing marked RE70683
<b>ENGINE BLOCK &amp; PARTS</b>				
<b>QTY</b>	<b>GASKETS</b>	<b>PART NO.</b>	<b>SIZE</b>	<b>DESCRIPTION</b>
1	Oil Pan Gasket	FP-R97342		Oil pan codes 1904, 1905; w/Stamped Steel Pan
2	O-Ring	FP-U13639		Block coolant drain plug seal; Coolant heater codes 2601, 2602; 1.475" X .118"
<b>QTY</b>	<b>CAM BEARINGS</b>	<b>PART NO.</b>	<b>SIZE</b>	<b>DESCRIPTION</b>
1	Cam Brg.	FP-R119874		
<b>QTY</b>	<b>ENGINE BEARING MISC.</b>	<b>PART NO.</b>	<b>SIZE</b>	<b>DESCRIPTION</b>
4	Balance Shaft Bearing	FP-R115299		4045H Engs.; Balance shaft code 4501
<b>CRANKSHAFT/OIL PUMP</b>				
<b>QTY</b>	<b>SEALS - FRONT CRANK</b>	<b>PART NO.</b>	<b>SIZE</b>	<b>DESCRIPTION</b>
1	Crankshaft Front Seal	FP-AR67942		
<b>QTY</b>	<b>SEALS - REAR CRANK</b>	<b>PART NO.</b>	<b>SIZE</b>	<b>DESCRIPTION</b>
1	Crankshaft Rear Seal	FP-RE24959		
<b>QTY</b>	<b>MAIN BEARINGS</b>	<b>PART NO.</b>	<b>SIZE</b>	<b>DESCRIPTION</b>
4	Plain Main Brg.	FP-RE65165	STD	Crankshaft and Bearing code 4701
4	Plain Main Brg.	FP-RE65911	.25MM	Crankshaft and Bearing code 4701
1	Flanged Main Brg.	FP-RE65168	STD	Crankshaft and Bearing code 4701
1	Flanged Main Brg.	FP-RE65912	.25MM	Crankshaft and Bearing code 4701
<b>CYLINDER COMPONENTS</b>				
<b>QTY</b>	<b>LINERS</b>	<b>PART NO.</b>	<b>SIZE</b>	<b>DESCRIPTION</b>
4	Liner w/o Sealing Ring	FP-R121867	STD	
4	Liner w/Sealing Rings	FP-RE500024	STD	
4	Cylinder Kit Complete	FP-RE507920	STD	Piston, Con. Rod, Cyl. liner code 4803; To Ser. No. 825,562
4	Cylinder Kit Complete	FP-RE507850	STD	Piston, Con. Rod, Cyl. liner code 4809; w/Con. Rod marked R500335
4	Cyl. Liner Sealing Ring Kit	FP-AR65507		
<b>QTY</b>	<b>PISTONS</b>	<b>PART NO.</b>	<b>SIZE</b>	<b>DESCRIPTION</b>
4	Piston Body w/o Pin	FP-RE505100	STD	Piston, Con. Rod, Cyl. liner code 4803; To Ser. No. 825,562; w/Con. Rod marked R123959; Small Pin
4	Piston Body w/o Pin	FP-RE55512	STD	Piston, Con. Rod, Cyl. liner code 4809; Large Pin; w/Con. Rod marked R500335
4	Pin	FP-R123178		Piston, Con. Rod, Cyl. liner code 4803; To Ser. No. 825,562; w/Con. Rod marked R123959; Small Pin; 1.375" pin dia.
4	Pin	FP-R123177		4045H Engs.; Piston, Con. Rod, Cyl. liner code 4809; w/Con. Rod marked R500335; Large Pin; 1.62" pin dia.
8	Piston Pin Retainer	FP-M41029		w/Con. Rod marked R123959; Small Pin; For 1.38" pin dia.
8	Piston Pin Retainer	FP-R54114		4045H Engs.; w/Con. Rod marked R500335; Large Pin; For 1.62" pin dia.
4	Pin Bushing	FP-R123960		w/Con. Rod marked R123959; Small Pin; 1.375" pin dia.
4	Pin Bushing	FP-R114082		4045H Engs.; w/Con. Rod marked R500335; Large Pin
4	Piston Pin Kit	FP-RE63915		4045H Engs.; Piston, Con. Rod, Cyl. liner code 4809; w/Con. Rod marked R500335; Large Pin; Incl. Pin, Retainers & Bushing
<b>QTY</b>	<b>CONNECTING RODS &amp; BRGS.</b>	<b>PART NO.</b>	<b>SIZE</b>	<b>DESCRIPTION</b>
8	Con. Rod Bolt	FP-R114083		Cyl. Liner code 4803; w/Con. Rod marked R123959; To Ser. No. 793,991; Small Pin
8	Con. Rod Bolt	FP-R501124		Cyl. Liner code 4803; w/Con. Rod marked R123959, R500000; From Ser. No. 36,628

(continued on next page)



# John Deere Off Highway

**Power Unit 4045H PowerTech Eng. (4-Valve Cyl. Head). Wheel Tractor 4045H PowerTech 62 Eng. (4-Valve Cyl. Head). (cont.)**  
4.5L 275.8 (4522cc) OHV Turbo-Diesel L4 (PowerTech 4V IC), 106mm Bore

## CYLINDER COMPONENTS (cont.)

QTY	CONNECTING RODS & BRGS. (cont.)	PART NO.	SIZE	DESCRIPTION
8	Con. Rod Bolt	FP-R501124		Cyl. Liner code 4809; w/Con. Rod marked R500000; From Ser. No. 36,628
8	Con. Rod Bolt	FP-R114083		Cyl. Liner code 4809; w/Con. Rod marked R500335; To Ser. No. 793,991
8	Con. Rod Bolt	FP-R501124		4045H Engs.; Cyl. Liner code 4809; w/Con. Rod marked R500335; From Ser. No. 36,628
8	Con. Rod Bolt	FP-R114083		4045H Engs.; Cyl. Liner code 4809; w/Con. Rod marked R500335; To Ser. No. 793,991; Small Pin
4	Rod Pair	FP-RE65908	STD	Cyl. Liner codes 4801, 4803; w/Con. Rod marked R123959, R500000
4	Rod Pair	FP-RE65909	.25MM	Cyl. Liner codes 4801, 4803; w/Con. Rod marked R123959, R500000
4	Rod Pair	FP-RE65908	STD	4045H Engs.; Cyl. Liner code 4809; w/Con. Rod marked R500335
4	Rod Pair	FP-RE65909	.25MM	4045H Engs.; Cyl. Liner code 4809; w/Con. Rod marked R500335
QTY	PISTON RINGS	PART NO.	SIZE	DESCRIPTION
4	Ring Set Single Cylinder	FP-RE507852	STD	Use w/FP-RE55512 piston; 1-1/8, 1-3/32, 1-.136 (1 cyl. set)
4	Ring Set Single Cylinder	FP-RE66820	STD	Use w/FP-RE55512 piston; 1-1/8, 1-3/32, 1-.136 (1 cyl. set)
4	Ring Set Single Cylinder	FP-RE66271	STD	Use w/FP-RE59277, FP-RE505100 pistons

## KITS

QTY	OVERHAUL KIT	PART NO.	SIZE	DESCRIPTION
1	In-Frame Overhaul Kit	FP-IFKPT4045T		Piston, Con. Rod, Cyl. liner code 4803; To Ser. No. 825,562

**Loader 4045D Eng. Crawler Tractor 4045D Eng. Loader Tractor 4045D Eng. Backhoe 4045D 63 Eng.**  
4.5L 275.8 (4522cc) OHV Diesel L4 (Litre Engine), 106mm Bore

## CYL. HEAD & PARTS

QTY	GASKETS	PART NO.	SIZE	DESCRIPTION
1	Valve Cover Gasket	FP-R73521		w/Stamped Steel Cover; Rocker arm cover codes 1101, 1102, 1104, 1106, 1110, 1114
1	Head Gasket	FP-R125863		From Ser. No. 300,000
1	Head Gasket	FP-R125863		RePower Engs.
1	Head Set	FP-RE38851		From Ser. No. 300,000
QTY	VALVE	PART NO.	SIZE	DESCRIPTION
4	Intake	FP-R98062	STD	1 groove; Chrome plated stem; 1.8350" Head Dia., .3100" Stem Dia., 5.2780" O.A.L.
4	Intake	FP-R97490	15	1 groove; Chrome plated stem; 1.8350" Head Dia., .3250" Stem Dia., 5.2780" O.A.L.
4	Exhaust	FP-R90692	STD	1 groove; Chrome plated stem; 1.6730" Head Dia., .3095" Stem Dia., 5.2550" O.A.L.
4	Exhaust	FP-R97492	15	1 groove; Chrome plated stem; 1.6730" Head Dia., .3245" Stem Dia., 5.2550" O.A.L.
16	Keeper	FP-R91889		
QTY	VALVE SEAT	PART NO.	SIZE	DESCRIPTION
4	Exh.	FP-R85687	STD	
4	Int.	FP-R98335		.020" Dia. O/S face width; 1.8575" OD, 1.5500" ID, .2580" Depth
4	Int.	FP-R98063	STD	1.8575" OD, 1.5500" ID, .2580" Depth
QTY	VALVE SPRING	PART NO.	SIZE	DESCRIPTION
8	Spring	FP-R26125		2.1200" Free Height
QTY	VALVE MISC.	PART NO.	SIZE	DESCRIPTION
8	Rotocap	FP-RE60005		Exh. & Int.
1	Oil Filler Cap Gasket	FP-R80135		Oil filler neck code 1207; L.H. Auxiliary drive
1	Oil Filler Cap Gasket	FP-T20328		Oil filler neck codes 1101, 1104, 1201, 1202, 1206
QTY	VALVE SEAL	PART NO.	SIZE	DESCRIPTION
8	Valve Stem Seal	FP-RE31617		Positive type
8	Valve Stem Seal	FP-R87627		Exh. & Int.; To Ser. No. 299,999; O-Ring type
QTY	ROCKER PARTS	PART NO.	SIZE	DESCRIPTION
1	O-Ring	FP-R56463		Rocker cover breather tube; Breather tube codes 2902, 2904, 2905, 2909, 2910, 2912, 2999

(continued on next page)

**63** Loader 4045D Eng. Crawler Tractor 4045D Eng. Loader Tractor 4045D Eng. Backhoe 4045D Eng.  
(cont.)  
4.5L 275.8 (4522cc) OHV Diesel L4 (Litre Engine), 106mm Bore

ELECTRICAL				
QTY	ELECTRICAL	PART NO.	SIZE	DESCRIPTION
1	Starter to Block Gasket	FP-R53108		3-Hole mount; Starting motor codes 3001, 3002, 3007, 3015, 3017, 3019
QTY	ALTERNATOR	PART NO.	SIZE	DESCRIPTION
1	Ball Brg.	FP-JD9449		Front; Delco-Remy components; Codes 3114, 3115, 3116; 78 amp alternator
2	Ball Brg.	FP-JD9449		Front & Rear; Motorola components; Codes 3101, 3116, 3129; 12 Volt, 65 amp alternator
2	Ball Brg.	FP-JD9449		Front & Rear; Motorola components; Codes 3117, 3118, 3119, 3120; 24 Volt, 45 amp alternator
2	Ball Brg.	FP-JD9449		Front & Rear; Motorola No. 70D42076T02; Codes 3108, 3109, 3130; 65 amp alternator
INT & EXH MANIFOLDS				
QTY	INT. & EXH. MANIFOLDS	PART NO.	SIZE	DESCRIPTION
4	Exhaust Manifold Gasket	FP-R90658		Exh. manifold codes 2801, 2802, 2803, 2806, 2807, 2812, 2819
4	Exhaust Manifold Gasket	FP-R90658		RePower Engs.; Exh. manifold code 2803
1	Air Intake Gasket	FP-R81275		Int. manifold codes 1701, 1703, 1707, 1709
1	Air Intake Gasket	FP-R81275		RePower Engs.; Int. manifold code 1703
CAMSHAFT GROUP				
QTY	TIMING COVER	PART NO.	SIZE	DESCRIPTION
1	Timing Gear Cover Gasket	FP-R108654		Timing cover code 4404
1	Timing Gear Cover Gasket	FP-R97454		Use w/L.H. side gear dr. timing gear cover; Gear cover codes 4401, 4402, 4403, 4408, 4409, 4410, 4411, 4414, 4419; Front cover
QTY	CAMSHAFT/LIFTER	PART NO.	SIZE	DESCRIPTION
8	Lifter	FP-T20073		
FUEL SYSTEM & PARTS				
QTY	FUEL INJECTION	PART NO.	SIZE	DESCRIPTION
1	Injector Pump Gasket	FP-R125066		Gear cover
4	Fuel Injector Nozzle	FP-RE36939		w/Injector marked 28484
4	Fuel Injector Seal	FP-R79605		Fuel line connection; Nozzle codes 1601, 1602, 1609, 1619, 1623; 9.270MM X 13.600MM X 5.080MM
4	Fuel Injector Seal	FP-R92352		Upper packing; w/Injector nozzle codes 1601, 1602, 1609, 1619, 1623
4	Fuel Injector Nut	FP-R79604		w/Injector marked 28484
8	Washer Type Seal	FP-R51936		Leak-off & return line seals; Nozzle code 1623; w/Nozzle marked 28484
4	Washer Type Seal	FP-R48000		Lower; w/Nozzle marked 28484
QTY	FUEL FILTERS & PUMP	PART NO.	SIZE	DESCRIPTION
1	Mechanical Fuel Pump	FP-RE42211		Fuel transfer pump codes 3701, 3702, 3704, 3706; Transfer pump
2	O-Ring	FP-R26286		Fuel inj. pump code 1602, 1626, 1635, 1636; Fuel inlet fitting seals
2	O-Ring	FP-R26286		RePower Engs.; Codes 1651, 1652; Fuel inlet fitting seals
COOLING SYSTEM				
QTY	WATER PUMP	PART NO.	SIZE	DESCRIPTION
1	Water Pump Impeller	FP-R47191		w/Pump housing marked R66420, R68733
1	Water Pump Impeller	FP-R56812		w/Pump housing marked R90784, R104648
1	Water Pump Impeller	FP-R94419		Pump code 2001; w/Pump housing marked R59049
1	Water Pump Impeller	FP-R94419		Pump codes 2020, 2021, 2026; w/Pump housing marked R111084
1	Water Pump Repair/Rebuild Kit	FP-864340979		w/Pump housing marked R51661, R73606, R73724, R79171
1	Water Pump Repair/Rebuild Kit	FP-925740979		w/Pump housing marked R56787, R62902
1	Water Pump Repair/Rebuild Kit	FP-RE62661		w/Pump housing marked R66420, R68733
1	Water Pump Repair/Rebuild Kit	FP-RE62658		w/Pump housing marked R73604
1	Water Pump Repair/Rebuild Kit	FP-RE62659		RePower Engs.; Pump code 2001; w/Pump housing marked R59049
1	Water Pump Housing Gasket	FP-R55405		w/Pump housing marked R59049
1	Water Pump Housing Gasket	FP-R97455		w/Pump housing marked R73604, R111084
1	Water Pump Housing Gasket	FP-R56809		w/Pump housing marked R90783, R90784, R104648
1	Oil Seal Kit	FP-AR101549		Water Pump; w/Pump housing marked R59049, R90784, R104648, R111084
1	Water Pump Mounting Gasket	FP-T20243		w/H/D Pump housing marked R100812, R127918
1	Water Pump Mounting Gasket	FP-T20243		w/Pump housing marked R59049, R73604, R90783, R90784, R104648, R111084, R122337

(continued on next page)



# John Deere Off Highway

Loader 4045D Eng. Crawler Tractor 4045D Eng. Loader Tractor 4045D Eng. Backhoe 4045D **63**  
 Eng. (cont.)  
 4.5L 275.8 (4522cc) OHV Diesel L4 (Litre Engine), 106mm Bore

## COOLING SYSTEM (cont.)

QTY	WATER PUMP (cont.)	PART NO.	SIZE	DESCRIPTION
1	Shaft & Bearing Assembly	FP-JD9257		w/Pump housing marked R111084
1	Shaft & Bearing Assembly	FP-JD8643		w/Pump housing marked R90784, R104648
QTY	THERMOSTAT	PART NO.	SIZE	DESCRIPTION
2	Thermostat	FP-AR48675		Thermostat codes 2201, 2204, 2205, 4045; Housing marked R100878; 180 Deg.
1	Thermostat Gasket	FP-T20219		
1	Thermostat Cover Gasket	FP-T20215		Thermostat cover codes 2101, 2102, 2109
1	Thermostat Cover Gasket	FP-R54638		Thermostat cover codes 2102, 2106; Thermostat housing code 3903; w/Two thermostats
1	Therm. Hsg. - Water Mfld. Gsk	FP-R54641		Thermostat housing to cyl. head

## ENGINE BLOCK & PARTS

QTY	GASKETS	PART NO.	SIZE	DESCRIPTION
1	Flywheel Housing Gasket	FP-R97351		Flywheel housing codes 1403, 1404, 1405, 1406, 1407, 1410, 1411, 1421, 1422, 1425, 1432
1	Oil Pan Gasket	FP-R119360		w/Sheet metal pan; Oil pan codes 1901, 1903, 1906; w/Cast iron oil pan
1	Oil Pan Gasket	FP-R97342		Oil pan codes 1908, 1910; w/Alum. oil pan; w/Stamped Steel Pan
1	Oil Pan Gasket	FP-R119360		RePower Eng.s.; Oil pan code 1901; w/Cast iron oil pan
1	Oil Pan Gasket	FP-R97342		RePower Eng.s.; Oil pan code 1908; w/Stamped Steel Pan
1	Oil Pan Gasket Set	FP-PG301PS		Oil pan codes 1908, 1910; w/Alum. oil pan
1	O-Ring	FP-U13639		Block coolant drain plug seal; Gear cover codes 4404, 4409, 4410; Heater codes 2601, 2602; 1.475" X .118"
1	Block to End Plate Front Gskt	FP-R131794		Front plate codes 3601, 3602, 3604; R.H. side gear drive

QTY	GASKET SETS	PART NO.	SIZE	DESCRIPTION
1	In-Frame Gasket Set	FP-PG219S		
1	Complete Overhaul Gasket Set	FP-RE37715		Crankshaft seals not incl.
1	Complete Overhaul Gasket Set	FP-RE37715WS		Incl. crankshaft seals; Rear main brg. seal incl.; Wear sleeve not incl.

QTY	CAM BEARINGS	PART NO.	SIZE	DESCRIPTION
1	Cam Brg.	FP-R119874		From Ser. No. 100,000 to Ser. No. 499,999; Codes 4601, 4604, 4605, 4607, 4610

QTY	ENGINE BEARING MISC.	PART NO.	SIZE	DESCRIPTION
1	Bal. Shaft Set	FP-R57160S		
6	Balance Shaft Bearing	FP-R57160		

QTY	OIL COOLERS & FILTERS	PART NO.	SIZE	DESCRIPTION
2	Oil Cooler Gasket	FP-R98486		Oil cooler core flange gskt.; w/Oil cooler & filter code 5901
1	Oil Cooler Gasket	FP-R98487		Oil cooler lower cover gskt.; w/Oil cooler & filter code 5901; Lower oil cooler cover
1	O-Ring	FP-R61871		Oil cooler & line codes 5901, 5902, 5903, 5905, 5906, 5907; To Ser. No. 362,468
1	O-Ring	FP-R56814		Oil cooler housing inner seal; Cooler codes 5901, 5902, 5903, 5905, 5906, 5907
1	O-Ring	FP-R56815		Oil cooler housing outer seal; Cooler codes 5901, 5902, 5903, 5905, 5906, 5907
1	Rect. or Square Seal	FP-R70956		Cooler housing; w/Behr cooler codes 5911, 5912, 5913, 5919, 5921; 2.700" X 3.000" X .180"
1	Oil Cooler to Block Gasket	FP-R98489		Oil cooler & filter codes 5901, 5902, 5903, 5905, 5906, 5907
1	Oil Cooler Adapter Cover Gskt	FP-R114097		Filter adapter codes 5913, 5919, 5921; From Ser. No. 100,000 to Ser. No. 499,999

## CRANKSHAFT/OIL PUMP

QTY	CRANKSHAFT	PART NO.	SIZE	DESCRIPTION
1	Crankshaft	FP-RE56792		Crankshaft marked R54501, R108657
1	Crankshaft	FP-RE54883		From Ser. No. 100,000 to Ser. No. 499,999; Crankshaft marked R120009, R90825; 60MM snout
1	Oil Seal Kit	FP-SK67942		Incl. front & rear seals; Crankshaft codes 4703, 4704, 4708

QTY	SEALS - FRONT CRANK	PART NO.	SIZE	DESCRIPTION
1	Crankshaft Front Seal	FP-AR67942		Crankshaft codes 4704, 4708
1	O-Ring	FP-H35244		Crankshaft pulley; Pulley codes 1301, 1307, 1308, 1312, 1316; Crankshaft, Bearing codes 4701, 4703, 4704, 4708

QTY	SEALS - REAR CRANK	PART NO.	SIZE	DESCRIPTION
1	Crankshaft Rear Seal	FP-RE24959		Crankshaft, Bearing codes 4701, 4703; Flywheel housing codes 1403, 1404, 1405, 1406, 1407, 1410, 1411, 1421, 1425, 1432

QTY	MAIN BEARINGS	PART NO.	SIZE	DESCRIPTION
1	Main Set	FP-MBK3004	STD	w/Flanged thrust brg.

(continued on next page)

## 63 Loader 4045D Eng. Crawler Tractor 4045D Eng. Loader Tractor 4045D Eng. Backhoe 4045D (cont.) Eng.

4.5L 275.8 (4522cc) OHV Diesel L4 (Litre Engine), 106mm Bore

### CRANKSHAFT/OIL PUMP (cont.)

QTY	MAIN BEARINGS (cont.)	PART NO.	SIZE	DESCRIPTION
1	Main Set	FP-MBK300410	10	w/Flanged thrust brg.
1	Main Set	FP-MBK300420	20	w/Flanged thrust brg.
1	Main Set	FP-MBK300430	30	w/Flanged thrust brg.
4	Plain Main Brg.	FP-RE27352	STD	w/Flangeless thrust brg.
4	Plain Main Brg.	FP-RE27353	10	w/Flangeless thrust brg.
4	Plain Main Brg.	FP-RE27360	20	w/Flangeless thrust brg.
4	Plain Main Brg.	FP-RE27368	30	w/Flangeless thrust brg.
1	Flanged Main Brg.	FP-RE521350	STD	
1	Flanged Main Brg.	FP-RE526754	10	
1	Flanged Main Brg.	FP-RE527235	20	
1	Flanged Main Brg.	FP-RE527236	30	
3	Thrust Washer	FP-R78598	STD	w/Thrust washer; Crank marked R120009, R121018

QTY	OIL PUMP	PART NO.	SIZE	DESCRIPTION
1	Pump Repair Kit	FP-RE55343		Pump code 5001; w/Pump housing marked R54615; From Ser. No. 427,007
1	O-Ring	FP-R61871		Oil pump inlet; Pump code 5006
1	O-Ring	FP-R61871		Oil pump inlet; Pump codes 5001, 5003, 5004, 5010; w/Pump housing marked R54615, R54629, R97587
1	O-Ring	FP-R74354		Oil pump outlet tube; Pump codes 5006, 5010; w/Pump housing marked R54615
1	Oil Filler Inlet Gasket	FP-R97352		Oil filler neck codes 1201, 1202, 1201, 1203, 1297, 1299
1	Oil Filter Adapter Gasket	FP-R98488		w/Filter adapter marked R91597, R131238
1	Oil Pump Seal Ring	FP-R79563		Oil pump outlet adapter; Pump codes 5001, 5003

### CYLINDER COMPONENTS

QTY	LINERS	PART NO.	SIZE	DESCRIPTION
4	Liner w/o Sealing Ring	FP-R121867	STD	Hi-Ring
4	Liner w/Sealing Rings	FP-RE500024	STD	
4	Cylinder Kit Complete	FP-RE28966	STD	Hi-Ring; 1.62" pin dia.
4	Cyl. Liner Sealing Ring Kit	FP-AR65507		Hi-Ring
4	Sealing Ring, Liner	FP-R48767		Hi-Ring; Rectangle; Top
4	Sealing Ring, Liner	FP-R26121		Hi-Ring; Round; Middle
4	Sealing Ring	FP-SLR2520		Hi-Ring; Round; Bottom

QTY	PISTONS	PART NO.	SIZE	DESCRIPTION
4	Piston Body w/o Pin	FP-RE28919	STD	Hi-Ring; 1.62" Pin dia.
4	Piston Kit w/Pin & Retainers	FP-RE28919WP		From Ser. No. 100,000 to Ser. No. 499,999
4	Pin	FP-R124230		Hi-Ring; 1.62" pin dia.
8	Piston Pin Retainer	FP-R54114		Hi-Ring; For 1.62" pin dia.
4	Pin Bushing	FP-R57451		w/Con. Rod marked R56187, R58979, R80032, R113612; Pin dia. 1.62"; 1.621" ID, 1.813" OD, 1.370" O.A.L.

QTY	CONNECTING RODS & BRGS.	PART NO.	SIZE	DESCRIPTION
8	Con. Rod Bolt	FP-R74195		w/Con. Rod marked R54617, R56187, R116851; Torque-To-Yield bolt; Replacement recommended
4	Rod Pair	FP-RE27348	STD	
4	Rod Pair	FP-RE27349	10	
4	Rod Pair	FP-RE27358	20	
4	Rod Pair	FP-RE27364	30	
4	Rod Pair	FP-AR97517	STD	w/Con. Rod marked R56187, R116851
4	Rod Pair	FP-AR97653	10	w/Con. Rod marked R56187, R116851
4	Rod Pair	FP-AR97654	20	w/Con. Rod marked R56187, R116851
4	Rod Pair	FP-AR97655	30	w/Con. Rod marked R56187, R116851

QTY	PISTON RINGS	PART NO.	SIZE	DESCRIPTION
4	Ring Set Single Cylinder	FP-RE507852	STD	Piston & Liner code 4802; 1-1/8, 1-3/32, 1-.136 (1 cyl. set)
4	Ring Set Single Cylinder	FP-RE66820	STD	Piston & Liner code 4802; 1-1/8, 1-3/32, 1-.136 (1 cyl. set)

KITS				
QTY	OVERHAUL KIT	PART NO.	SIZE	DESCRIPTION
1	In-Frame Overhaul Kit	FP-4045DIFK		w/Con. Rod marked R54617, R56187, R116851; w/Flangeless thrust brg.; Hi-Ring; Incl. Torque-To-Yield con. rod bolts
1	Complete Overhaul Kit	FP-4045DOHK		From Ser. No. 100,000 to Ser. No. 499,999; Camshaft codes 4601, 4604, 4605, 4607, 4610; w/Con. Rod marked R56187; Piston pin dia. 1.62"; w/Flangeless thrust brg.; Hi-Ring; Incl. front & rear seals; Crankshaft codes 4703, 4704, 4708; Incl. Torque-To-Yield con. rod bolts





Forklift 4045D PowerTech Eng. Loader 4045D PowerTech Eng. Power Unit 4045D <b>64</b> PowerTech Eng. Wheel Tractor 4045D PowerTech Eng. Crawler Tractor 4045D PowerTech Eng. Loader Tractor 4045D PowerTech Eng. Dozer 4045D PowerTech Eng. Backhoe 4045D PowerTech Eng. Track Loader 4045D PowerTech Eng. 4.5L 275.8 (4522cc) OHV Diesel L4 (PowerTech 2V), 106mm Bore				
<b>CYL. HEAD &amp; PARTS</b>				
<b>QTY</b>	<b>GASKETS</b>	<b>PART NO.</b>	<b>SIZE</b>	<b>DESCRIPTION</b>
1	Valve Cover Gasket	FP-R123542		
1	Head Gasket	FP-R116515		
1	Head Set	FP-RE66082		
<b>QTY</b>	<b>VALVE</b>	<b>PART NO.</b>	<b>SIZE</b>	<b>DESCRIPTION</b>
4	Intake	FP-R98062	STD	1 groove; Chrome plated stem; 1.8350" Head Dia., .3100" Stem Dia., 5.2780" O.A.L.
4	Intake	FP-R97490	15	1 groove; Chrome plated stem; 1.8350" Head Dia., .3250" Stem Dia., 5.2780" O.A.L.
4	Exhaust	FP-R90692	STD	1 groove; Chrome plated stem; 1.6730" Head Dia., .3095" Stem Dia., 5.2550" O.A.L.
4	Exhaust	FP-R97492	15	1 groove; Chrome plated stem; 1.6730" Head Dia., .3245" Stem Dia., 5.2550" O.A.L.
16	Keeper	FP-R91889		Exh. & Int.
<b>QTY</b>	<b>VALVE SEAT</b>	<b>PART NO.</b>	<b>SIZE</b>	<b>DESCRIPTION</b>
4	Exh.	FP-R85687	STD	
4	Int.	FP-R98335		.020" Dia. O/S face width; 1.8575" OD, 1.5500" ID, .2580" Depth
4	Int.	FP-R98063	STD	1.8575" OD, 1.5500" ID, .2580" Depth
<b>QTY</b>	<b>VALVE SPRING</b>	<b>PART NO.</b>	<b>SIZE</b>	<b>DESCRIPTION</b>
8	Spring	FP-R26125		Exh. & Int.; 2.1200" Free Height
<b>QTY</b>	<b>VALVE MISC.</b>	<b>PART NO.</b>	<b>SIZE</b>	<b>DESCRIPTION</b>
8	Rotocap	FP-RE60005		Exh. & Int.
<b>ELECTRICAL</b>				
<b>QTY</b>	<b>ELECTRICAL</b>	<b>PART NO.</b>	<b>SIZE</b>	<b>DESCRIPTION</b>
1	Starter to Block Gasket	FP-R53108		3-Hole mount; Starting motor codes 3006, 3010
<b>FUEL SYSTEM &amp; PARTS</b>				
<b>QTY</b>	<b>FUEL INJECTION</b>	<b>PART NO.</b>	<b>SIZE</b>	<b>DESCRIPTION</b>
4	Fuel Injector Seal	FP-R92352		Upper packing; w/Injector nozzle codes 16BG, 16BH, 16BJ, 16CL, 16DL, 16GB, 16GC, 16HJ, 16HK, 16HV, 16KE, 16LM, 16LN, 1601, 1602, 1603, 1663, 1671, 1672, 1673, 1674, 1691
4	Fuel Injector Nut	FP-R79604		w/Injector nozzle codes 16HR, 16HS, 16HT, 16HU
1	Washer Type Seal	FP-R51936		Aux. drive line; Line codes 5201, 5202, 5205
2	Washer Type Seal	FP-R51936		Fuel line; Line codes 16BG, 16BJ, 16CL, 16DL, 16GB, 16GC, 16HJ, 16HK, 16HV, 1601, 1603, 1663, 1671, 1673, 1691
<b>COOLING SYSTEM</b>				
<b>QTY</b>	<b>WATER PUMP</b>	<b>PART NO.</b>	<b>SIZE</b>	<b>DESCRIPTION</b>
1	Water Pump - Heavy Duty	FP-RE500737 *		Standard flow
1	Water Pump Filter	FP-R98527		w/Pump housing marked RE70683
<b>ENGINE BLOCK &amp; PARTS</b>				
<b>QTY</b>	<b>GASKETS</b>	<b>PART NO.</b>	<b>SIZE</b>	<b>DESCRIPTION</b>
1	Oil Pan Gasket	FP-R97342		Oil pan codes 1904, 1905; w/Stamped Steel Pan
1	O-Ring	FP-U13639		Block coolant drain plug seal; Coolant heater codes 2601, 2602; 1.475" X .118"
<b>QTY</b>	<b>CAM BEARINGS</b>	<b>PART NO.</b>	<b>SIZE</b>	<b>DESCRIPTION</b>
1	Cam Brg.	FP-R119874		
<b>QTY</b>	<b>ENGINE BEARING MISC.</b>	<b>PART NO.</b>	<b>SIZE</b>	<b>DESCRIPTION</b>
4	Balance Shaft Bearing	FP-R115299		Balance shaft code 4502
<b>CRANKSHAFT/OIL PUMP</b>				
<b>QTY</b>	<b>SEALS - FRONT CRANK</b>	<b>PART NO.</b>	<b>SIZE</b>	<b>DESCRIPTION</b>
1	Crankshaft Front Seal	FP-AR67942		
<b>QTY</b>	<b>SEALS - REAR CRANK</b>	<b>PART NO.</b>	<b>SIZE</b>	<b>DESCRIPTION</b>
1	Crankshaft Rear Seal	FP-RE24959		
<b>QTY</b>	<b>MAIN BEARINGS</b>	<b>PART NO.</b>	<b>SIZE</b>	<b>DESCRIPTION</b>
4	Plain Main Brg.	FP-RE65165	STD	Crankshaft and Bearing code 4701
4	Plain Main Brg.	FP-RE65911	.25MM	Crankshaft and Bearing code 4701
1	Flanged Main Brg.	FP-RE65168	STD	Crankshaft and Bearing code 4701
1	Flanged Main Brg.	FP-RE65912	.25MM	Crankshaft and Bearing code 4701

(continued on next page)

**64** *Forklift 4045D PowerTech Eng. Loader 4045D PowerTech Eng. Power Unit 4045D (cont.) PowerTech Eng. Wheel Tractor 4045D PowerTech Eng. Crawler Tractor 4045D PowerTech Eng. Loader Tractor 4045D PowerTech Eng. Dozer 4045D PowerTech Eng. Backhoe 4045D PowerTech Eng. Track Loader 4045D PowerTech Eng.*  
4.5L 275.8 (4522cc) OHV Diesel L4 (PowerTech 2V), 106mm Bore

### CYLINDER COMPONENTS

QTY	LINERS	PART NO.	SIZE	DESCRIPTION
4	Liner w/o Sealing Ring	FP-R121867	STD	
4	Liner w/Sealing Rings	FP-RE500024	STD	
4	Cylinder Kit Complete	FP-RE65966	STD	Piston, Con. Rod, Cyl. liner code 4801
4	Cylinder Kit Complete	FP-RE507920	STD	Piston, Con. Rod, Cyl. liner code 4803; Use w/RE59277, RE505100 piston; To Ser. No. 825,562
4	Cyl. Liner Sealing Ring Kit	FP-AR65507		
QTY	PISTONS	PART NO.	SIZE	DESCRIPTION
4	Piston Body w/o Pin	FP-RE505101	STD	Piston, Con. Rod, Cyl. liner code 4801
4	Piston Body w/o Pin	FP-RE505100	STD	Piston, Con. Rod, Cyl. liner code 4803; To Ser. No. 825,562; w/Con. Rod marked R123959; Small Pin
4	Pin	FP-R123178		Piston, Con. Rod, Cyl. liner codes 4801, 4803; To Ser. No. 825,562; w/Con. Rod marked R123959; Small Pin; 1.375" pin dia.
8	Piston Pin Retainer	FP-M41029		w/Con. Rod marked R123959; Small Pin; For 1.38" pin dia.
4	Pin Bushing	FP-R123960		w/Con. Rod marked R123959; Small Pin; 1.375" pin dia.
QTY	CONNECTING RODS & BRGS.	PART NO.	SIZE	DESCRIPTION
8	Con. Rod Bolt	FP-R501124		Cyl. Liner code 4801, 4803; w/Con. Rod marked R123959, R500000; From Ser. No. 36,628
8	Con. Rod Bolt	FP-R114083		Cyl. Liner codes 4801, 4803; w/Con. Rod marked R123959; To Ser. No. 793,991; Small Pin
4	Rod Pair	FP-RE65908	STD	Cyl. Liner codes 4801, 4803; w/Con. Rod marked R123959, R500000
4	Rod Pair	FP-RE65909	.25MM	Cyl. Liner codes 4801, 4803; w/Con. Rod marked R123959, R500000
QTY	PISTON RINGS	PART NO.	SIZE	DESCRIPTION
4	Ring Set Single Cylinder	FP-RE66271	STD	Use w/FP-RE59277, RE505101 piston
KITS				
QTY	OVERHAUL KIT	PART NO.	SIZE	DESCRIPTION
1	In-Frame Overhaul Kit	FP-IFKPT4045T		Piston, Con. Rod, Cyl. liner code 4803; Use w/RE59277, RE505100 piston; To Ser. No. 825,562

**65** *Loader 4045T Eng. Crawler Tractor 4045T Eng. Loader Tractor 4045T Eng. Excavator 4045T Eng. Skidder 4045T Eng. Backhoe 4045T Eng.*  
4.5L 275.8 (4522cc) OHV Turbo-Diesel L4 (Litre Engine), 106mm Bore

### CYL. HEAD & PARTS

QTY	GASKETS	PART NO.	SIZE	DESCRIPTION
1	Valve Cover Gasket	FP-R73521		w/Stamped Steel Cover; Rocker arm cover codes 1101, 1102, 1104, 1106, 1110, 1114
1	Valve Cover Gasket	FP-R75728		RePower Eng.s.; Valve cover code 1110; Early design
1	Valve Cover Gasket	FP-R73521		RePower Eng.s.; Valve cover code 1110; Late design
1	Head Gasket	FP-R125863		From Ser. No. 300,000
1	Head Gasket	FP-R125863		RePower Eng.s.
1	Head Set	FP-RE38851		
QTY	VALVE	PART NO.	SIZE	DESCRIPTION
4	Intake	FP-R98062	STD	1 groove; Chrome plated stem; 1.8350" Head Dia., .3100" Stem Dia., 5.2780" O.A.L.
4	Intake	FP-R97490	15	1 groove; Chrome plated stem; 1.8350" Head Dia., .3250" Stem Dia., 5.2780" O.A.L.
4	Exhaust	FP-R90692	STD	1 groove; Chrome plated stem; 1.6730" Head Dia., .3095" Stem Dia., 5.2550" O.A.L.
4	Exhaust	FP-R97492	15	1 groove; Chrome plated stem; 1.6730" Head Dia., .3245" Stem Dia., 5.2550" O.A.L.
16	Keeper	FP-R91889		
QTY	VALVE SEAT	PART NO.	SIZE	DESCRIPTION
4	Exh.	FP-R85687	STD	
4	Int.	FP-R98335		.020" Dia. O/S face width; 1.8575" OD, 1.5500" ID, .2580" Depth
4	Int.	FP-R98063	STD	1.8575" OD, 1.5500" ID, .2580" Depth
QTY	VALVE SPRING	PART NO.	SIZE	DESCRIPTION
8	Spring	FP-R26125		2.1200" Free Height

(continued on next page)



# John Deere Off Highway

Loader 4045T Eng. Crawler Tractor 4045T Eng. Loader Tractor 4045T Eng. Excavator 4045T 65  
 Eng. Skidder 4045T Eng. Backhoe 4045T Eng. (cont.)  
 4.5L 275.8 (4522cc) OHV Turbo-Diesel L4 (Litre Engine), 106mm Bore

## CYL. HEAD & PARTS (cont.)

QTY	VALVE MISC.	PART NO.	SIZE	DESCRIPTION
8	Rotocap	FP-RE60005		Exh. & Int.
1	Oil Filler Cap Gasket	FP-R80135		Oil filler neck code 1207; L.H. Auxiliary drive
1	Oil Filler Cap Gasket	FP-T20328		Oil filler neck codes 1101, 1104, 1201, 1202, 1206
QTY	VALVE SEAL	PART NO.	SIZE	DESCRIPTION
8	Valve Stem Seal	FP-RE31617		Positive type
8	Valve Stem Seal	FP-R87627		Exh. & Int.; To Ser. No. 299,999; O-Ring type
QTY	ROCKER PARTS	PART NO.	SIZE	DESCRIPTION
1	O-Ring	FP-R56463		Rocker cover breather tube; Breather tube codes 2902, 2904, 2905, 2909, 2910, 2912, 2999
1	O-Ring	FP-R56463		Rocker cover breather tube; RePower Eng.s.; Breather tube code 2910

## ELECTRICAL

QTY	ELECTRICAL	PART NO.	SIZE	DESCRIPTION
1	Starter to Block Gasket	FP-R53108		3-Hole mount; Starting motor codes 3001, 3002, 3007, 3015, 3017, 3019
QTY	ALTERNATOR	PART NO.	SIZE	DESCRIPTION
1	Ball Brg.	FP-JD9449		Front; Delco-Remy components; Codes 3114, 3115, 3116; 78 amp alternator
2	Ball Brg.	FP-JD9449		Front & Rear; Motorola components; Codes 3101, 3116, 3129; 12 Volt, 65 amp alternator
2	Ball Brg.	FP-JD9449		Front & Rear; Motorola components; Codes 3117, 3118, 3119, 3120; 24 Volt, 45 amp alternator
2	Ball Brg.	FP-JD9449		Front & Rear; Motorola No. 70D42076T02; Codes 3108, 3109, 3130; 65 amp alternator

## INT & EXH MANIFOLDS

QTY	INT. & EXH. MANIFOLDS	PART NO.	SIZE	DESCRIPTION
4	Exhaust Manifold Gasket	FP-R90658		Exh. manifold codes 2803, 2806, 2812, 2819, 2822
4	Exhaust Manifold Gasket	FP-R90658		RePower Eng.s.; Exh. manifold code 2803
1	Air Intake Gasket	FP-R81275		Int. manifold codes 1713, 1718

## CAMSHAFT GROUP

QTY	TIMING COVER	PART NO.	SIZE	DESCRIPTION
1	Timing Gear Cover Gasket	FP-T20273		Access cover
1	Timing Gear Cover Gasket	FP-R108654		Timing cover code 4404
1	Timing Gear Cover Gasket	FP-R97454		Use w/L.H. side gear dr. timing gear cover; Gear cover codes 4401, 4402, 4403, 4408, 4409, 4410, 4411, 4414, 4419; Front cover
QTY	CAMSHAFT/LIFTER	PART NO.	SIZE	DESCRIPTION
8	Lifter	FP-T20073		

## FUEL SYSTEM & PARTS

QTY	FUEL INJECTION	PART NO.	SIZE	DESCRIPTION
1	Injector Pump Gasket	FP-R125066		Gear cover
4	Fuel Injector Nozzle	FP-RE36939		w/Injector marked 28484
4	Fuel Injector Seal	FP-R79605		Fuel line connection; Nozzle codes 1601, 1602, 1609, 1619, 1623; 9.270MM X 13.600MM X 5.080MM
4	Fuel Injector Seal	FP-R92352		Upper packing; w/Injector nozzle codes 1601, 1602, 1609, 1619, 1623
4	Fuel Injector Nut	FP-R79604		w/Injector marked 28484
8	Washer Type Seal	FP-R51936		Leak-off & return line seals; Nozzle code 1619; w/Nozzle marked 28484
4	Washer Type Seal	FP-R48000		Lower; w/Nozzle marked 28484
QTY	FUEL FILTERS & PUMP	PART NO.	SIZE	DESCRIPTION
1	Mechanical Fuel Pump	FP-RE42211		Fuel transfer pump codes 3701, 3702, 3704, 3706; Transfer pump
2	O-Ring	FP-R26286		Fuel inj. pump codes 1602, 1603, 1625, 1627, 1629, 1630, 1631, 1637, 1641, 1642, 1644, 1645; Fuel inlet fitting seals
2	O-Ring	FP-R26286		RePower Eng.s.; Fuel inj. pump codes 1651, 1652; Fuel inlet fitting seals
QTY	TURBOCHARGER	PART NO.	SIZE	DESCRIPTION
1	Turbocharger Oil Drain Gasket	FP-R105346		
1	Turbocharger Mounting Gasket	FP-R89879		
1	Turbo Exhaust Int. Cover Gskt	FP-R92097		Turbo codes 6504, 6505
1	Turbocharger Oil Supply Gskt.	FP-R97348		

(continued on next page)

**65** Loader 4045T Eng. Crawler Tractor 4045T Eng. Loader Tractor 4045T Eng. Excavator 4045T Eng. Skidder 4045T Eng. Backhoe 4045T Eng.  
4.5L 275.8 (4522cc) OHV Turbo-Diesel L4 (Litre Engine), 106mm Bore

COOLING SYSTEM				
QTY	WATER PUMP	PART NO.	SIZE	DESCRIPTION
1	Water Pump Impeller	FP-R47191		w/Pump housing marked R66420, R68733
1	Water Pump Impeller	FP-R56812		w/Pump housing marked R90784, R104648
1	Water Pump Impeller	FP-R94419		RePower Engs.; Pump code 2001; w/Pump housing marked R59049
1	Water Pump Repair/Rebuild Kit	FP-925740979		w/Pump housing marked R56787, R6290202
1	Water Pump Repair/Rebuild Kit	FP-RE62661		w/Pump housing marked R66420, R68733
1	Water Pump Repair/Rebuild Kit	FP-RE62658		w/Pump housing marked R73604
1	Water Pump Repair/Rebuild Kit	FP-RE62659		RePower Engs.; Pump code 2001; w/Pump housing marked R59049
1	Water Pump Housing Gasket	FP-R55405		w/Pump housing marked R59049
1	Water Pump Housing Gasket	FP-R97455		w/Pump housing marked R73604, R111084
1	Water Pump Housing Gasket	FP-R56809		w/Pump housing marked R90783, R90784, R104648
1	Oil Seal Kit	FP-AR101549		Water Pump; w/Pump housing marked R90784, R104648, R111084
1	Water Pump Mounting Gasket	FP-T20243		w/H/D Pump housing marked R100812, R127918
1	Water Pump Mounting Gasket	FP-T20243		w/Pump housing marked R73604, R90783, R90784, R104648, R111084, R122337
1	Shaft & Bearing Assembly	FP-JD9257		w/Pump housing marked R59049, R111084
1	Shaft & Bearing Assembly	FP-JD8643		w/Pump housing marked R90784, R104648
QTY	THERMOSTAT	PART NO.	SIZE	DESCRIPTION
2	Thermostat	FP-AR48675		Thermostat code 4045; Housing marked R100878; 180 Deg.
2	Thermostat	FP-AR48675		Thermostat codes 2201, 2205, 2207; Housing codes 3901, 3904; 180 Deg.
1	Thermostat Gasket	FP-T20219		
1	Thermostat Cover Gasket	FP-T20215		Thermostat cover codes 2101, 2102, 2109
1	Thermostat Cover Gasket	FP-R54638		Thermostat cover codes 2102, 2106; Thermostat housing codes 3901, 3903, 3904; w/Two thermostats
1	Therm. Hsg. - Water Mfld. Gsk	FP-R54641		Thermostat housing to cyl. head
2	O-Ring	FP-R56461		Thermostat housing tube seals; Housing code 3905; Water pump codes 2004, 2023
ENGINE BLOCK & PARTS				
QTY	GASKETS	PART NO.	SIZE	DESCRIPTION
1	Flywheel Housing Gasket	FP-R97351		Flywheel housing codes 1403, 1404, 1405, 1406, 1407, 1410, 1411, 1421, 1422, 1425, 1432
1	Oil Pan Gasket	FP-R119360		w/Sheet metal pan; Oil pan codes 1906, 1908; w/Cast iron oil pan
1	Oil Pan Gasket	FP-R97342		Oil pan codes 1908, 1910; w/Alum. oil pan; w/Stamped Steel Pan
1	Oil Pan Gasket	FP-R97342		RePower Engs.; Oil pan code 1908; w/Stamped Steel Pan
1	Oil Pan Gasket Set	FP-PG301PS		To Ser. No. 427,006; w/Alum. oil pan
1	O-Ring	FP-U13639		Block coolant drain plug seal; Gear cover codes 4404, 4409, 4410; Heater codes 2601, 2602; 1.475" X .118"
1	Block to End Plate Front Gskt	FP-R131794		Front plate codes 3601, 3602, 3604; R.H. side gear drive
QTY	GASKET SETS	PART NO.	SIZE	DESCRIPTION
1	In-Frame Gasket Set	FP-PG219S		
1	Complete Overhaul Gasket Set	FP-RE37715		Crankshaft seals not incl.
1	Complete Overhaul Gasket Set	FP-RE37715WS		Incl. crankshaft seals; Rear main brg. seal incl.; Wear sleeve not incl.
QTY	CAM BEARINGS	PART NO.	SIZE	DESCRIPTION
1	Cam Brg.	FP-R119874		From Ser. No. 100,000 to Ser. No. 499,999; Codes 4601, 4604, 4605, 4607, 4610
QTY	ENGINE BEARING MISC.	PART NO.	SIZE	DESCRIPTION
1	Bal. Shaft Set	FP-R57160S		
6	Balance Shaft Bearing	FP-R57160		
QTY	OIL COOLERS & FILTERS	PART NO.	SIZE	DESCRIPTION
2	Oil Cooler Gasket	FP-R98486		Oil cooler core flange gskt.; w/Oil cooler & filter code 5901
1	Oil Cooler Gasket	FP-R98487		Oil cooler lower cover gskt.; w/Oil cooler & filter code 5901; Lower oil cooler cover
1	O-Ring	FP-R61871		Oil cooler & line codes 5901, 5902, 5905, 5906, 5907; To Ser. No. 362,468
1	O-Ring	FP-R56462		Oil cooler adapter code 5913; To Ser. No. 206,997; Adapter cover bolt seal
1	O-Ring	FP-R56193		Oil cooler housing outer seal; Cooler codes 5902, 5903
1	O-Ring	FP-R56815		Oil cooler housing outer seal; Cooler codes 5905, 5906, 5907
1	Rect. or Square Seal	FP-R70956		Cooler housing; w/Behr cooler codes 5911, 5912, 5913, 5919, 5921; 2.700" X 3.000" X .180"
1	Oil Cooler Cover Gasket	FP-R98471		Oil cooler & filter codes 5902, 5903
1	Oil Cooler to Block Gasket	FP-R98489		Oil cooler & filter codes 5901, 5902, 5903, 5905, 5906, 5907

(continued on next page)



# John Deere Off Highway

Loader 4045T Eng. Crawler Tractor 4045T Eng. Loader Tractor 4045T Eng. Excavator 4045T 65  
 Eng. Skidder 4045T Eng. Backhoe 4045T Eng. (cont.)  
 4.5L 275.8 (4522cc) OHV Turbo-Diesel L4 (Litre Engine), 106mm Bore

## ENGINE BLOCK & PARTS (cont.)

OIL COOLERS & FILTERS				
QTY	(cont.)	PART NO.	SIZE	DESCRIPTION
1	Oil Cooler Adapter Cover Gskt	FP-R114097		Filter adapter codes 5913, 5919, 5921; From Ser. No. 100,000 to Ser. No. 499,999
CRANKSHAFT/OIL PUMP				
QTY	CRANKSHAFT	PART NO.	SIZE	DESCRIPTION
1	Crankshaft	FP-RE56792		Crankshaft marked R54501, R108657
1	Crankshaft	FP-RE54883		From Ser. No. 100,000 to Ser. No. 499,999; Crankshaft marked R120009, R90825; 60MM snout
1	Oil Seal Kit	FP-SK67942		Incl. front & rear seals; Crankshaft codes 4703, 4704, 4708
QTY	SEALS - FRONT CRANK	PART NO.	SIZE	DESCRIPTION
1	Crankshaft Front Seal	FP-AR67942		Front; Crankshaft codes 4704, 4708
1	O-Ring	FP-H35244		Crankshaft pulley; Pulley codes 1301, 1307, 1308, 1312, 1316; Crankshaft, Bearing codes 4701, 4703, 4704, 4708
QTY	SEALS - REAR CRANK	PART NO.	SIZE	DESCRIPTION
1	Crankshaft Rear Seal	FP-RE24959		Crankshaft, Bearing codes 4701, 4703; Flywheel housing codes 1403, 1404, 1405, 1406, 1407, 1410, 1411, 1421, 1425, 1432
QTY	MAIN BEARINGS	PART NO.	SIZE	DESCRIPTION
1	Main Set	FP-MBK3004	STD	w/Flanged thrust brg.
1	Main Set	FP-MBK300410	10	w/Flanged thrust brg.
1	Main Set	FP-MBK300420	20	w/Flanged thrust brg.
1	Main Set	FP-MBK300430	30	w/Flanged thrust brg.
4	Plain Main Brg.	FP-RE27352	STD	w/Flangeless thrust brg.
4	Plain Main Brg.	FP-RE27353	10	w/Flangeless thrust brg.
4	Plain Main Brg.	FP-RE27360	20	w/Flangeless thrust brg.
4	Plain Main Brg.	FP-RE27368	30	w/Flangeless thrust brg.
1	Flanged Main Brg.	FP-RE521350	STD	
1	Flanged Main Brg.	FP-RE526754	10	
1	Flanged Main Brg.	FP-RE527235	20	
1	Flanged Main Brg.	FP-RE527236	30	
3	Thrust Washer	FP-R78598	STD	w/Thrust washer; Crank marked R120009, R121018
QTY	OIL PUMP	PART NO.	SIZE	DESCRIPTION
1	Pump Repair Kit	FP-RE55343		Pump code 5001; w/Pump housing marked R54615; From Ser. No. 427,007
1	O-Ring	FP-R61871		Oil pump inlet; Pump code 5006
1	O-Ring	FP-R61871		Oil pump inlet; Pump codes 5001, 5003, 5004, 5010; w/Pump housing marked R54615, R54629, R97587
1	O-Ring	FP-R74354		Oil pump outlet tube; Pump codes 5006, 5010; Outlet seal; w/Pump housing marked R54615
1	Oil Filler Inlet Gasket	FP-R97352		Oil filler neck codes 1201, 1202, 1203, 1297, 1299
1	Oil Filter Adapter Gasket	FP-R98488		w/Filter adapter marked R91597, R131238
1	Oil Pump Seal Ring	FP-R79563		Oil pump outlet adapter; Pump codes 5001, 5003
CYLINDER COMPONENTS				
QTY	LINERS	PART NO.	SIZE	DESCRIPTION
4	Liner w/o Sealing Ring	FP-R121867	STD	Hi-Ring
4	Liner w/Sealing Rings	FP-RE500024	STD	
4	Cylinder Kit Complete	FP-RE53073	STD	Hi-Ring & RePower Engs.
4	Cyl. Liner Sealing Ring Kit	FP-AR65507		Hi-Ring
4	Sealing Ring, Liner	FP-R48767		Hi-Ring; Rectangle; Top
4	Sealing Ring, Liner	FP-R26121		Hi-Ring; Round; Middle
4	Sealing Ring	FP-SLR2520		Hi-Ring; Round; Bottom
QTY	PISTONS	PART NO.	SIZE	DESCRIPTION
4	Piston Body w/o Pin	FP-RE48469	STD	Hi-Ring & RePower Engs.
4	Piston Kit w/Pin & Retainers	FP-RE48469WP		From Ser. No. 100,000 to Ser. No. 499,999
4	Pin	FP-R124230		Hi-Ring; 1.62" pin dia.
8	Piston Pin Retainer	FP-R54114		Hi-Ring; For 1.62" pin dia.
4	Pin Bushing	FP-R57451		w/Con. Rod marked R56187, R58979, R80032, R113612; Pin dia. 1.62"; 1.621" ID, 1.813" OD, 1.370" O.A.L.
4	Pin Bushing	FP-R114082		Aftercooled; w/Con. Rod code 4809; w/Con. Rod marked R500335
QTY	CONNECTING RODS & BRGS.	PART NO.	SIZE	DESCRIPTION
8	Con. Rod Bolt	FP-R74195		w/Con. Rod marked R54617, R56187, R116851; Torque-To-Yield bolt; Replacement recommended
4	Rod Pair	FP-AR97517	STD	w/Con. Rod marked R56187, R116851

(continued on next page)

**65** Loader 4045T Eng. Crawler Tractor 4045T Eng. Loader Tractor 4045T Eng. Excavator 4045T (cont.) Eng. Skidder 4045T Eng. Backhoe 4045T Eng.  
4.5L 275.8 (4522cc) OHV Turbo-Diesel L4 (Litre Engine), 106mm Bore

### CYLINDER COMPONENTS (cont.)

CONNECTING RODS & BRGS. (cont.)				
QTY		PART NO.	SIZE	DESCRIPTION
4	Rod Pair	FP-AR97653	10	w/Con. Rod marked R56187, R116851
4	Rod Pair	FP-AR97654	20	w/Con. Rod marked R56187, R116851
4	Rod Pair	FP-AR97655	30	w/Con. Rod marked R56187, R116851
PISTON RINGS				
QTY		PART NO.	SIZE	DESCRIPTION
4	Ring Set Single Cylinder	FP-RE507852	STD	Piston & Liner code 4802; 1-1/8, 1-3/32, 1-.136 (1 cyl. set)
4	Ring Set Single Cylinder	FP-RE66820	STD	Piston & Liner code 4802; 1-1/8, 1-3/32, 1-.136 (1 cyl. set)

### KITS

QTY	OVERHAUL KIT	PART NO.	SIZE	DESCRIPTION
1	In-Frame Overhaul Kit	FP-4045TIFK		w/Con. Rod marked R56187, R116851; w/Flangeless thrust brg.; Hi-Ring; RePower Eng.s.; Incl. Torque-To-Yield con. rod bolts
1	Complete Overhaul Kit	FP-4045TOHK		From Ser. No. 100,000 to Ser. No. 499,999; Camshaft codes 4601, 4604, 4605, 4607, 4610; w/Con. Rod marked R56187; Piston pin dia. 1.62"; w/Flangeless thrust brg.; RePower Eng.s.; Hi-Ring; Incl. front & rear seals; Crankshaft codes 4703, 4704, 4708; Incl. Torque-To-Yield con. rod bolts

**66** Forklift 4045T PowerTech Eng. Loader 4045T PowerTech Eng. Power Unit 4045T PowerTech Eng. Wheel Tractor 4045T PowerTech Eng. Windrower 4045T PowerTech Eng. Crawler Tractor 4045T PowerTech Eng. Loader Tractor 4045T PowerTech Eng. Forestry Tractor 4045T PowerTech Eng. Excavator 4045T PowerTech Eng. Dozer 4045T PowerTech Eng. Backhoe 4045T PowerTech Eng. Sprayer 4045T PowerTech Eng. Integrated Tool Carrier 4045T PowerTech Eng. Telehandler 4045T PowerTech Eng.  
4.5L 275.8 (4522cc) OHV Turbo-Diesel L4 (PowerTech 2V), 106mm Bore

### CYL. HEAD & PARTS

GASKETS				
QTY		PART NO.	SIZE	DESCRIPTION
1	Valve Cover Gasket	FP-R123542		
1	Head Gasket	FP-R116515		
1	Head Set	FP-RE66082		
VALVE				
QTY		PART NO.	SIZE	DESCRIPTION
4	Intake	FP-R98062	STD	1 groove; Chrome plated stem; 1.8350" Head Dia., .3100" Stem Dia., 5.2780" O.A.L.
4	Intake	FP-R97490	15	1 groove; Chrome plated stem; 1.8350" Head Dia., .3250" Stem Dia., 5.2780" O.A.L.
4	Exhaust	FP-R90692	STD	1 groove; Chrome plated stem; 1.6730" Head Dia., .3095" Stem Dia., 5.2550" O.A.L.
4	Exhaust	FP-R97492	15	1 groove; Chrome plated stem; 1.6730" Head Dia., .3245" Stem Dia., 5.2550" O.A.L.
16	Keeper	FP-R91889		Exh. & Int.
VALVE SEAT				
QTY		PART NO.	SIZE	DESCRIPTION
4	Exh.	FP-R85687	STD	
4	Int.	FP-R98335		.020" Dia. O/S face width; 1.8575" OD, 1.5500" ID, .2580" Depth
4	Int.	FP-R98063	STD	1.8575" OD, 1.5500" ID, .2580" Depth
VALVE SPRING				
QTY		PART NO.	SIZE	DESCRIPTION
8	Spring	FP-R26125		Exh. & Int.; 2.1200" Free Height
VALVE MISC.				
QTY		PART NO.	SIZE	DESCRIPTION
8	Rotocap	FP-RE60005		Exh. & Int.

### ELECTRICAL

ELECTRICAL				
QTY		PART NO.	SIZE	DESCRIPTION
1	Starter to Block Gasket	FP-R53108		3-Hole mount; Starting motor codes 3005, 3006, 3010, 3011, 3012

### FUEL SYSTEM & PARTS

FUEL INJECTION				
QTY		PART NO.	SIZE	DESCRIPTION
4	Fuel Injector Nozzle	FP-RE48786		Nozzle codes 16BF, 16CE, 16CM, 16GL, 16LP, 16LQ, 16NH, 16OR, 16OS, 1606, 1608, 1675, 1677, 1682, 1683, 1692, 1694, 1695
4	Fuel Injector Seal	FP-R92352		Upper packing; w/Injector nozzle codes 16BF, 16CE, 16CM, 16CV, 16GL, 16LP, 16LQ, 16NH, 16OR, 1605, 1606, 1608, 1656, 1667, 1675, 1677, 1682, 1683, 1692, 1694, 1695
4	Fuel Injector Nut	FP-R79604		w/Injector nozzle codes 16HM, 16HN, 16HP, 16HQ, 16LK, 16LL
1	Washer Type Seal	FP-R51936		Aux. drive line; Line codes 5201, 5202, 5203, 5205, 5206

(continued on next page)

<b>Forklift 4045T PowerTech Eng. Loader 4045T PowerTech Eng. Power Unit 4045T 66            PowerTech Eng. Wheel Tractor 4045T PowerTech Eng. Windrower 4045T PowerTech (cont.)            Eng. Crawler Tractor 4045T PowerTech Eng. Loader Tractor 4045T PowerTech Eng.            Forestry Tractor 4045T PowerTech Eng. Excavator 4045T PowerTech Eng. Dozer 4045T            PowerTech Eng. Backhoe 4045T PowerTech Eng. Sprayer 4045T PowerTech Eng.            Integrated Tool Carrier 4045T PowerTech Eng. Telehandler 4045T PowerTech Eng.            4.5L 275.8 (4522cc) OHV Turbo-Diesel L4 (PowerTech 2V), 106mm Bore</b>				
<b>FUEL SYSTEM &amp; PARTS (cont.)</b>				
<b>QTY</b>	<b>FUEL INJECTION (cont.)</b>	<b>PART NO.</b>	<b>SIZE</b>	<b>DESCRIPTION</b>
2	Washer Type Seal	FP-R51936		Fuel line; Aftercooled; Line codes 160B, 1611
2	Washer Type Seal	FP-R51936		Fuel line; Line codes 16BF, 16CE, 16CM, 16CV, 16GL, 16LN, 16LP, 16LQ, 16NH, 16OR, 1605, 1671, 1677, 1682
<b>COOLING SYSTEM</b>				
<b>QTY</b>	<b>WATER PUMP</b>	<b>PART NO.</b>	<b>SIZE</b>	<b>DESCRIPTION</b>
1	Water Pump - Heavy Duty	FP-RE500737 *		Standard flow
1	Water Pump Filter	FP-R98527		w/Pump housing marked RE70683
<b>QTY</b>	<b>THERMOSTAT</b>	<b>PART NO.</b>	<b>SIZE</b>	<b>DESCRIPTION</b>
1	Thermostat	FP-AR48675		w/Housing marked R54808, R59501, R89294, R100878; 180 Deg.
1	Thermostat	FP-RE33705		w/Housing marked T19651, T20218, R60256, R127777; 180 Deg.
<b>ENGINE BLOCK &amp; PARTS</b>				
<b>QTY</b>	<b>GASKETS</b>	<b>PART NO.</b>	<b>SIZE</b>	<b>DESCRIPTION</b>
1	Oil Pan Gasket	FP-R97342		Oil pan codes 1904, 1905; w/Stamped Steel Pan
2	O-Ring	FP-U13639		Block coolant drain plug seal; Coolant heater codes 2601, 2602; 1.475" X .118"
<b>QTY</b>	<b>CAM BEARINGS</b>	<b>PART NO.</b>	<b>SIZE</b>	<b>DESCRIPTION</b>
1	Cam Brg.	FP-R119874		
<b>QTY</b>	<b>ENGINE BEARING MISC.</b>	<b>PART NO.</b>	<b>SIZE</b>	<b>DESCRIPTION</b>
4	Balance Shaft Bearing	FP-R115299		Balance shaft code 4501
<b>CRANKSHAFT/OIL PUMP</b>				
<b>QTY</b>	<b>CRANKSHAFT</b>	<b>PART NO.</b>	<b>SIZE</b>	<b>DESCRIPTION</b>
1	Oil Seal Kit	FP-SK67942		Incl. front & rear seals
<b>QTY</b>	<b>SEALS - FRONT CRANK</b>	<b>PART NO.</b>	<b>SIZE</b>	<b>DESCRIPTION</b>
1	Crankshaft Front Seal	FP-AR67942		
<b>QTY</b>	<b>SEALS - REAR CRANK</b>	<b>PART NO.</b>	<b>SIZE</b>	<b>DESCRIPTION</b>
1	Crankshaft Rear Seal	FP-RE24959		
<b>QTY</b>	<b>MAIN BEARINGS</b>	<b>PART NO.</b>	<b>SIZE</b>	<b>DESCRIPTION</b>
4	Plain Main Brg.	FP-RE65165	STD	Crankshaft and Bearing code 4701
4	Plain Main Brg.	FP-RE65911	.25MM	Crankshaft and Bearing code 4701
1	Flanged Main Brg.	FP-RE65168	STD	Crankshaft and Bearing code 4701
1	Flanged Main Brg.	FP-RE65912	.25MM	Crankshaft and Bearing code 4701
<b>CYLINDER COMPONENTS</b>				
<b>QTY</b>	<b>LINERS</b>	<b>PART NO.</b>	<b>SIZE</b>	<b>DESCRIPTION</b>
4	Liner w/o Sealing Ring	FP-R121867	STD	
4	Liner w/Sealing Rings	FP-RE500024	STD	
4	Cylinder Kit Complete	FP-RE507920	STD	Piston, Con. Rod, Cyl. liner code 4803; To Ser. No. 825,562
4	Cylinder Kit Complete	FP-RE507850	STD	Piston, Con. Rod, Cyl. liner code 4809; w/Con. Rod marked R500335
4	Cyl. Liner Sealing Ring Kit	FP-AR65507		
<b>QTY</b>	<b>PISTONS</b>	<b>PART NO.</b>	<b>SIZE</b>	<b>DESCRIPTION</b>
4	Piston Body w/o Pin	FP-RE505100	STD	Piston, Con. Rod, Cyl. liner code 4803; To Ser. No. 825,562; w/Con. Rod marked R123959; Small Pin
4	Piston Body w/o Pin	FP-RE55512	STD	Piston, Con. Rod, Cyl. liner code 4809; Large Pin; w/Con. Rod marked R500335
4	Pin	FP-R123178		Piston, Con. Rod, Cyl. liner code 4803; To Ser. No. 825,562; w/Con. Rod marked R123959; Small Pin; 1.375" pin dia.
4	Pin	FP-R123177		Piston, Con. Rod, Cyl. liner code 4809; w/Con. Rod marked R500335; Large Pin; 1.62" pin dia.
8	Piston Pin Retainer	FP-M41029		w/Con. Rod marked R123959; Small Pin; For 1.38" pin dia.
8	Piston Pin Retainer	FP-R54114		w/Con. Rod marked R500335; Large Pin; For 1.62" pin dia.
4	Pin Bushing	FP-R123960		w/Con. Rod marked R123959; Small Pin; 1.375" pin dia.
4	Pin Bushing	FP-R114082		w/Con. Rod marked R500335; Large Pin
4	Piston Pin Kit	FP-RE63915		Piston, Con. Rod, Cyl. liner code 4809; w/Con. Rod marked R500335; Large Pin; Incl. Pin, Retainers & Bushing

(continued on next page)

**66** *Forklift 4045T PowerTech Eng. Loader 4045T PowerTech Eng. Power Unit 4045T PowerTech Eng. Wheel Tractor 4045T PowerTech Eng. Windrower 4045T PowerTech Eng. Crawler Tractor 4045T PowerTech Eng. Loader Tractor 4045T PowerTech Eng. Forestry Tractor 4045T PowerTech Eng. Excavator 4045T PowerTech Eng. Dozer 4045T PowerTech Eng. Backhoe 4045T PowerTech Eng. Sprayer 4045T PowerTech Eng. Integrated Tool Carrier 4045T PowerTech Eng. Telehandler 4045T PowerTech Eng.*  
 4.5L 275.8 (4522cc) OHV Turbo-Diesel L4 (PowerTech 2V), 106mm Bore

### CYLINDER COMPONENTS (cont.)

CONNECTING RODS & BRGS.				
QTY		PART NO.	SIZE	DESCRIPTION
8	Con. Rod Bolt	FP-R114083		Cyl. Liner code 4803; w/Con. Rod marked R123959; To Ser. No. 793,991; Small Pin
8	Con. Rod Bolt	FP-R501124		Cyl. Liner code 4803; w/Con. Rod marked R123959, R500000; From Ser. No. 36,628
8	Con. Rod Bolt	FP-R501124		Cyl. Liner code 4809; w/Con. Rod marked R500000, R500335; From Ser. No. 36,628
8	Con. Rod Bolt	FP-R114083		Cyl. Liner code 4809; w/Con. Rod marked R500335; To Ser. No. 793,991; Small Pin
4	Rod Pair	FP-RE65908	STD	Cyl. Liner code 4809; w/Con. Rod marked R500335
4	Rod Pair	FP-RE65909	.25MM	Cyl. Liner code 4809; w/Con. Rod marked R500335
4	Rod Pair	FP-RE65908	STD	Cyl. Liner codes 4801, 4803; w/Con. Rod marked R123959, R500000
4	Rod Pair	FP-RE65909	.25MM	Cyl. Liner codes 4801, 4803; w/Con. Rod marked R123959, R500000
PISTON RINGS				
QTY		PART NO.	SIZE	DESCRIPTION
4	Ring Set Single Cylinder	FP-RE66271	STD	
4	Ring Set Single Cylinder	FP-RE507852	STD	Use w/FP-RE55512 piston; 1-1/8, 1-3/32, 1-.136 (1 cyl. set)
4	Ring Set Single Cylinder	FP-RE66820	STD	Use w/FP-RE55512 piston; 1-1/8, 1-3/32, 1-.136 (1 cyl. set)
4	Ring Set Single Cylinder	FP-RE66271	STD	Use w/FP-RE59277, RE505100 pistons

### KITS

QTY	OVERHAUL KIT	PART NO.	SIZE	DESCRIPTION
1	In-Frame Overhaul Kit	FP-IFKPT4045T		Piston, Con. Rod, Cyl. liner code 4803; To Ser. No. 825,562

**67** *Loader 4276D Eng. Wheel Tractor 4276D Eng. Crawler Tractor 4276D Eng. Loader Tractor 4276D Eng. Excavator 4276D Eng. Skidder 4276D Eng. Dozer 4276D Eng. Backhoe 4276D Eng. Feller Buncher 4276D Eng.*  
 4.5L 276 OHV Diesel L4 (Standard), 4.1875" Bore

### CYL. HEAD & PARTS

GASKETS				
QTY		PART NO.	SIZE	DESCRIPTION
1	Valve Cover Gasket	FP-R73521		Rocker arm cover codes 1102, 1104, 1110
1	Valve Cover Gasket	FP-T20075		To Ser. No. 598,042
1	Head Gasket	FP-R125863		From Ser. No. 100,001; Manufactured after 1983
1	Head Gasket	FP-R125863		From Ser. No. 290,000 to Ser. No. 621,172; Manufactured 1974-83
1	Head Set	FP-RE38851		From Ser. No. 100,001; Manufactured after 1983
1	Head Set	FP-RE38851		From Ser. No. 290,000 to Ser. No. 621,172; Manufactured 1974-83
VALVE				
QTY		PART NO.	SIZE	DESCRIPTION
4	Intake	FP-R79623	STD	2 groove; Chrome plated stem; 1.7720" Head Dia., .3720" Stem Dia., 5.1560" O.A.L.
4	Intake	FP-R79628	3	2 groove; Chrome plated stem; 1.7720" Head Dia., .3750" Stem Dia., 5.1560" O.A.L.
4	Intake	FP-R79629	15	2 groove; Chrome plated stem; 1.7720" Head Dia., .3870" Stem Dia., 5.1560" O.A.L.
4	Intake	FP-R79630	30	2 groove; Chrome plated stem; 1.7720" Head Dia., .4020" Stem Dia., 5.1560" O.A.L.
4	Exhaust	FP-R79624	STD	1 groove; Chrome plated stem; 1.5750" Head Dia., .3720" Stem Dia., 5.1560" O.A.L.
4	Exhaust	FP-R79625	3	1 groove; Chrome plated stem; 1.5750" Head Dia., .3750" Stem Dia., 5.1560" O.A.L.
4	Exhaust	FP-R79626	15	1 groove; Chrome plated stem; 1.5750" Head Dia., .3870" Stem Dia., 5.1560" O.A.L.
4	Exhaust	FP-R79627	30	1 groove; Chrome plated stem; 1.5750" Head Dia., .4020" Stem Dia., 5.1560" O.A.L.
16	Keeper	FP-41339		1 groove; Square cut key groove
16	Keeper	FP-T20077		1 groove; Square cut key groove; Hardened
16	Keeper, Bulk	VK-138B		1 groove; Square cut key groove; Carton of 1000
VALVE SEAT				
QTY		PART NO.	SIZE	DESCRIPTION
4	Exh.	FP-R73064	STD	

(continued on next page)





# John Deere Off Highway

Loader 4276D Eng. Wheel Tractor 4276D Eng. Crawler Tractor 4276D Eng. Loader Tractor 67  
 4276D Eng. Excavator 4276D Eng. Skidder 4276D Eng. Dozer 4276D Eng. Backhoe 4276D (cont.)  
 Eng. Feller Buncher 4276D Eng.  
 4.5L 276 OHV Diesel L4 (Standard), 4.1875" Bore

## CYL. HEAD & PARTS (cont.)

QTY	VALVE SEAT (cont.)	PART NO.	SIZE	DESCRIPTION
4	Int.	FP-R51734	STD	
QTY	VALVE SPRING	PART NO.	SIZE	DESCRIPTION
8	Spring	FP-R26125		2.1200" Free Height
QTY	VALVE MISC.	PART NO.	SIZE	DESCRIPTION
4	Rotocap	FP-RE11410		
1	Bushing	FP-T26321		Lower
1	Bushing	FP-T20034		Upper
1	Oil Filler Cap Gasket	FP-T20328		Rocker arm cover codes 1101, 1104; Oil filler neck codes 1201, 1202, 1203
QTY	VALVE SEAL	PART NO.	SIZE	DESCRIPTION
8	Valve Stem Seal	FP-R87627		Exh. & Int.; From Ser. No. 724,327; O-Ring type
QTY	ROCKER PARTS	PART NO.	SIZE	DESCRIPTION
1	O-Ring	FP-R56463		Rocker cover breather tube; Breather tube codes 2909, 2915

## ELECTRICAL

QTY	ELECTRICAL	PART NO.	SIZE	DESCRIPTION
1	Starter to Block Gasket	FP-R53108		3-Hole mount; Starting motor codes 3001, 3017, 3018
QTY	ALTERNATOR	PART NO.	SIZE	DESCRIPTION
1	Ball Brg.	FP-JD9449		Front; Delco-Remy No. 1102936; 61 amp alternator
1	Ball Brg.	FP-JD9449		Front; Motorola No. A12NJD453; 35 amp alternator
1	Ball Brg.	FP-JD9449		Front; Motorola No. A12NJD604; 55 amp alternator
1	Ball Brg.	FP-JD9449		Front; Motorola No. 8TA2009ES; 30 amp alternator
1	Ball Brg.	FP-JD9449		Front; 12 Volt, 63 amp alternator; 72 amp alternator; 78 amp alternator
2	Ball Brg.	FP-JD9449		Front & Rear; Codes 3101, 3102, 3103, 3104, 3105, 3106, 3107, 3108, 3109, 3110, 3111, 3112, 3113, 3114, 3115, 3116, 3129; 65 amp alternator

## INT & EXH MANIFOLDS

QTY	INT. & EXH. MANIFOLDS	PART NO.	SIZE	DESCRIPTION
4	Exhaust Manifold Gasket	FP-R90658		
1	Air Intake Gasket	FP-R81275		

## CAMSHAFT GROUP

QTY	TIMING COVER	PART NO.	SIZE	DESCRIPTION
1	Timing Gear Cover Gasket	FP-T20273		Access cover
1	Timing Gear Cover Gasket	FP-R97454		Front cover
QTY	CAMSHAFT/LIFTER	PART NO.	SIZE	DESCRIPTION
8	Lifter	FP-T20073		

## FUEL SYSTEM & PARTS

QTY	FUEL INJECTION	PART NO.	SIZE	DESCRIPTION
1	Injector Pump Gasket	FP-R125066		Gear cover
4	Fuel Injector Nozzle	FP-RE37503		Nozzle codes 1602, 1603, 1605; From Ser. No. 100,001; Manufactured after 1983
4	Fuel Injector Nozzle	FP-RE37503		Nozzle codes 1602, 1603, 1605; From Ser. No. 290,000 to Ser. No. 621,172; Manufactured 1974-83
4	Fuel Injector Seal	FP-R79605		Fuel line connection; Nozzle codes 1602, 1603, 1605; 9.270MM X 13.600MM X 5.080MM
4	Fuel Injector Seal	FP-R92352		Upper packing; w/Stanadyne® nozzle No. 26993
8	Washer	FP-T20055		Pump codes 1602, 1603
4	Fuel Injector Nut	FP-R79604		w/Injector marked 20291, 20504, 22205, 22264, 26993
8	Washer Type Seal	FP-R51936		Leak-off & return line seals; Nozzle codes 1602, 1603, 1613
4	Washer Type Seal	FP-R48000		Lower; w/Nozzle codes 1602, 1603, 1625; w/Nozzle marked 26993
4	Washer Type Seal	FP-R60746		Upper; Nozzle codes 1602, 1603, 1605; From Ser. No. 609,312
QTY	FUEL FILTERS & PUMP	PART NO.	SIZE	DESCRIPTION
1	Mechanical Fuel Pump	FP-RE42211		Transfer pump
1	Fuel Transfer Pump Gasket	FP-R97350		

## COOLING SYSTEM

QTY	WATER PUMP	PART NO.	SIZE	DESCRIPTION
1	Water Pump Impeller	FP-R47191		w/Pump housing marked R66420, R68733
1	Water Pump Impeller	FP-R94419		Pump code 2001; w/Pump housing marked R54805, R59049

(continued on next page)

**67** Loader 4276D Eng. Wheel Tractor 4276D Eng. Crawler Tractor 4276D Eng. Loader Tractor  
 (cont.) 4276D Eng. Excavator 4276D Eng. Skidder 4276D Eng. Dozer 4276D Eng. Backhoe 4276D  
 Eng. Feller Buncher 4276D Eng.  
 4.5L 276 OHV Diesel L4 (Standard), 4.1875" Bore

### COOLING SYSTEM (cont.)

QTY	WATER PUMP (cont.)	PART NO.	SIZE	DESCRIPTION
1	Water Pump Repair/Rebuild Kit	FP-925740979		w/Pump housing marked R56787, R62902
1	Water Pump Repair/Rebuild Kit	FP-RE62661		w/Pump housing marked R66420, R68733
1	Water Pump Housing Gasket	FP-R55405		w/Pump housing marked R54805, R59049
1	Oil Seal Kit	FP-AR101549		Water Pump; w/Pump housing marked R55164, R90783
1	Water Pump Mounting Gasket	FP-T20243		w/Pump housing marked R54805, R59049
1	Shaft & Bearing Assembly	FP-JD9257		w/Pump housing marked R54805, R59049
QTY	THERMOSTAT	PART NO.	SIZE	DESCRIPTION
2	Thermostat	FP-AR48675		Thermostat code 2204; Thermostat cover code 2102 Vertical, 2201 Horizontal; Housing marked R89294, From Ser. No. 366,183; 180 Deg.
2	Thermostat	FP-AR48675		Thermostat code 2204; Thermostat cover code 2102 Vertical, 2201 Horizontal; To Ser. No. 366,182; 180 Deg.
1	Thermostat Gasket	FP-T20219		Thermostat cover code 2101, 2102
1	Thermostat Cover Gasket	FP-T20215		Thermostat cover codes 2101, 2102
2	O-Ring	FP-R56461		Thermostat housing tube seals; Housing code 2204; To Ser. No. 366,182

### ENGINE BLOCK & PARTS

QTY	GASKETS	PART NO.	SIZE	DESCRIPTION
1	Flywheel Housing Gasket	FP-R97351		
1	Oil Pan Gasket	FP-R119360		From Ser. No. 100,001; Manufactured after 1983; Oil pan codes 1901, 1902, 1903; w/Cast iron oil pan
1	Oil Pan Gasket	FP-R119360		From Ser. No. 290,000 to Ser. No. 621,172; Manufactured 1974-83; Oil pan codes 1901, 1903; w/Cast iron oil pan
1	Oil Pan Gasket	FP-R97342		Oil pan code 1908; w/Stamped Steel Pan
1	O-Ring	FP-U13639		Block coolant drain plug seal; 1.475" X .118"
1	Block to End Plate Front Gskt	FP-R131794		From Ser. No. 100,001; Manufactured after 1983
1	Block to End Plate Front Gskt	FP-R131794		From Ser. No. 290,000 to Ser. No. 621,172; Manufactured 1974-83

QTY	GASKET SETS	PART NO.	SIZE	DESCRIPTION
1	Gasket Conversion Set	FP-PG219CS		Wear sleeve incl.
1	In-Frame Gasket Set	FP-PG219S		
1	Complete Overhaul Gasket Set	FP-RE37715		Crankshaft seals not incl.
1	Complete Overhaul Gasket Set	FP-RE37715WS		Incl. crankshaft seals; Rear main brg. seal incl.; Wear sleeve not incl.
1	Kit Gasket Set	260-1392		Compl.; Rear main brg. seal incl.; Wear sleeve incl.

QTY	ENGINE BEARING MISC.	PART NO.	SIZE	DESCRIPTION
1	Bal. Shaft Set	FP-R57160S		
6	Balance Shaft Bearing	FP-R57160		

QTY	OIL COOLERS & FILTERS	PART NO.	SIZE	DESCRIPTION
1	Oil Cooler Gasket	FP-R98486		From Ser. No. 100,001; Manufactured after 1983
1	Oil Cooler Gasket	FP-R98487		From Ser. No. 100,001; Manufactured after 1983; Lower oil cooler cover
1	Oil Cooler Gasket	FP-R98486		From Ser. No. 290,000 to Ser. No. 621,172; Manufactured 1974-83
1	Oil Cooler Gasket	FP-R98487		From Ser. No. 290,000 to Ser. No. 621,172; Manufactured 1974-83; Lower oil cooler cover
1	O-Ring	FP-A4730R		From Ser. No. 100,001; Manufactured after 1983; Oil cooler to block check valve seal
1	O-Ring	FP-A4730R		From Ser. No. 290,000 to Ser. No. 621,172; Manufactured 1974-83; Oil cooler to block check valve seal
1	O-Ring	FP-R56814		Oil cooler housing inner seal; From Ser. No. 100,001; Manufactured after 1983
1	O-Ring	FP-R56814		Oil cooler housing inner seal; From Ser. No. 290,000 to Ser. No. 621,172; Manufactured 1974-83
1	O-Ring	FP-R56815		Oil cooler housing outer seal; From Ser. No. 100,001; Manufactured after 1983
1	O-Ring	FP-R56815		Oil cooler housing outer seal; From Ser. No. 290,000 to Ser. No. 621,172; Manufactured 1974-83

### CRANKSHAFT/OIL PUMP

QTY	CRANKSHAFT	PART NO.	SIZE	DESCRIPTION
1	Crankshaft	FP-RE56792		Crankshaft marked R54501, R108657
1	Oil Seal Kit	FP-SK67942		Incl. front & rear seals; Crankshaft marked R120009
QTY	SEALS - FRONT CRANK	PART NO.	SIZE	DESCRIPTION
1	Crankshaft Front Seal	FP-AR67942		

(continued on next page)



# John Deere Off Highway

Loader 4276D Eng. Wheel Tractor 4276D Eng. Crawler Tractor 4276D Eng. Loader Tractor 67  
 4276D Eng. Excavator 4276D Eng. Skidder 4276D Eng. Dozer 4276D Eng. Backhoe 4276D (cont.)  
 Eng. Feller Buncher 4276D Eng.  
 4.5L 276 OHV Diesel L4 (Standard), 4.1875" Bore

## CRANKSHAFT/OIL PUMP (cont.)

QTY	SEALS - FRONT CRANK (cont.)	PART NO.	SIZE	DESCRIPTION
1	O-Ring	FP-H35244		Crankshaft pulley; w/Crankshaft marked R12009
QTY	SEALS - REAR CRANK	PART NO.	SIZE	DESCRIPTION
1	Crankshaft Rear Seal	FP-RE24959		Crankshaft codes 1301, 1302; Flywheel housing codes 1403, 1404, 1405, 1421, 1425, 1432
QTY	MAIN BEARINGS	PART NO.	SIZE	DESCRIPTION
1	Main Set	FP-MBK3004	STD	w/Flanged thrust brg.
1	Main Set	FP-MBK300410	10	w/Flanged thrust brg.
1	Main Set	FP-MBK300420	20	w/Flanged thrust brg.
1	Main Set	FP-MBK300430	30	w/Flanged thrust brg.
4	Plain Main Brg.	FP-RE27352	STD	w/Flangeless thrust brg.
4	Plain Main Brg.	FP-RE27353	10	w/Flangeless thrust brg.
4	Plain Main Brg.	FP-RE27360	20	w/Flangeless thrust brg.
4	Plain Main Brg.	FP-RE27368	30	w/Flangeless thrust brg.
1	Flanged Main Brg.	FP-RE521350	STD	
1	Flanged Main Brg.	FP-RE526754	10	
1	Flanged Main Brg.	FP-RE527235	20	
1	Flanged Main Brg.	FP-RE527236	30	
4	Thrust Washer	FP-R78598	STD	
QTY	OIL PUMP	PART NO.	SIZE	DESCRIPTION
1	O-Ring	FP-R61871		Oil pump inlet; w/Pump housing marked R54629
1	O-Ring	FP-R80632		Oil Pump outlet tube
1	Oil Filler Inlet Gasket	FP-R97352		Oil filler neck codes 1201, 1202, 1203
1	Oil Filter Adapter Gasket	FP-R98488		w/Filter adapter marked R131238
1	Oil Pump Seal Ring	FP-R79563		Oil pump outlet adapter; w/Pump marked R54629; To Ser. No. 122,703
CYLINDER COMPONENTS				
QTY	LINERS	PART NO.	SIZE	DESCRIPTION
4	Liner w/o Sealing Ring	FP-R121867	STD	
4	Liner w/Sealing Rings	FP-RE500024	STD	1.38" pin dia.
4	Cylinder Kit Complete	FP-RE19831	STD	w/Con. Rod marked R54617; 1.38" pin dia.
4	Cylinder Kit Complete	FP-RE19833	STD	w/Con. Rod marked R56187, R116851; Pin dia. 1.62"
4	Cylinder Kit Complete	FP-RE28966	STD	1.62" pin dia.
4	Cyl. Liner Sealing Ring Kit	FP-AR65507		
4	Sealing Ring, Liner	FP-R48767		Rectangle; Top
4	Sealing Ring, Liner	FP-R26121		Round; Middle
4	Sealing Ring	FP-SLR2520		Round; Bottom
QTY	PISTONS	PART NO.	SIZE	DESCRIPTION
4	Piston Body w/o Pin	FP-AR63342	STD	1.38" pin dia.
4	Piston Body w/o Pin	FP-AR68188	STD	1.62" pin dia.
4	Piston Kit w/Pin & Retainers	FP-AR63342WP	STD	1.38" pin dia.
4	Piston Kit w/Pin & Retainers	FP-AR68188WP	STD	1.62" pin dia.
4	Pin	FP-R125754		1.38" pin dia.
4	Pin	FP-R124230		1.62" pin dia.
8	Piston Pin Retainer	FP-R54114		For 1.62" pin dia.
8	Piston Pin Retainer	FP-M41029		Small Pin; For 1.38" pin dia.
4	Pin Bushing	FP-R57450		w/Con. Rod marked R54617; Pin dia. 1.38"; w/1.38" pin dia.
4	Pin Bushing	FP-R57451		w/Con. Rod marked R56187, R116851; Pin dia. 1.62"; 1.621" ID, 1.813" OD, 1.370" O.A.L.
QTY	CONNECTING RODS & BRGS.	PART NO.	SIZE	DESCRIPTION
8	Con. Rod Bolt	FP-R74195		w/Con. Rod marked R54617, R56187, R116851; Torque-To-Yield bolt; Replacement recommended
4	Rod Pair	FP-AR97517	STD	
4	Rod Pair	FP-AR97653	10	
4	Rod Pair	FP-AR97654	20	
4	Rod Pair	FP-AR97655	30	
QTY	PISTON RINGS	PART NO.	SIZE	DESCRIPTION
4	Ring Set Single Cylinder	FP-RE507852	STD	1-1/8, 1-3/32, 1-.136 (1 cyl. set)
4	Ring Set Single Cylinder	FP-RE66820	STD	1-1/8, 1-3/32, 1-.136 (1 cyl. set)
KITS				
QTY	OVERHAUL KIT	PART NO.	SIZE	DESCRIPTION
1	In-Frame Overhaul Kit	FP-276DSPIFK		w/Con. Rod marked R54617; Pin dia. 1.38"; w/1.38" pin dia.

(continued on next page)

**67** Loader 4276D Eng. Wheel Tractor 4276D Eng. Crawler Tractor 4276D Eng. Loader Tractor 4276D Eng. Excavator 4276D Eng. Skidder 4276D Eng. Dozer 4276D Eng. Backhoe 4276D Eng. Feller Buncher 4276D Eng.  
4.5L 276 OHV Diesel L4 (Standard), 4.1875" Bore

**KITS (cont.)**

QTY	OVERHAUL KIT (cont.)	PART NO.	SIZE	DESCRIPTION
1	In-Frame Overhaul Kit	FP-276DLPIFK		w/Con. Rod marked R56187, R116851; Pin dia. 1.62"; w/1.62" pin dia.
1	Complete Overhaul Kit	FP-276DSPOHK		w/Con. Rod marked R54617; Pin dia. 1.38"; Incl. front & rear seals; Crankshaft marked R120009; w/1.38" pin dia.
1	Complete Overhaul Kit	FP-276DLPOHK		w/Con. Rod marked R56187, R116851; Pin dia. 1.62"; Incl. front & rear seals; Crankshaft marked R120009; w/1.62" pin dia.

**68** Loader 4276T Eng. Wheel Tractor 4276T Eng. Crawler Tractor 4276T Eng. Loader Tractor 4276T Eng. Excavator 4276T Eng. Skidder 4276T Eng. Dozer 4276T Eng. Backhoe 4276T Eng.  
4.5L 276 OHV Turbo-Diesel L4 (Standard), 4.1875" Bore

**CYL. HEAD & PARTS**

QTY	GASKETS	PART NO.	SIZE	DESCRIPTION
1	Valve Cover Gasket	FP-R73521		Rocker arm cover codes 1101, 1102, 1104, 1110
1	Valve Cover Gasket	FP-T20075		To Ser. No. 598,042
1	Head Gasket	FP-R125863		From Ser. No. 100,001; Manufactured after 1983
1	Head Gasket	FP-R125863		From Ser. No. 290,000 to Ser. No. 621,172; Manufactured 1974-83
1	Head Set	FP-RE38851		From Ser. No. 100,001; Manufactured after 1983
1	Head Set	FP-RE38851		From Ser. No. 290,000 to Ser. No. 621,172; Manufactured 1974-83
QTY	VALVE	PART NO.	SIZE	DESCRIPTION
4	Intake	FP-R83071	STD	Stellite; 2 groove; Chrome plated stem; 1.8210" Head Dia., .3720" Stem Dia., 5.1660" O.A.L.
4	Intake	FP-R89223	3	Stellite; 2 groove; Chrome plated stem; 1.8210" Head Dia., .3750" Stem Dia., 5.1660" O.A.L.
4	Intake	FP-R89224	15	Stellite; 2 groove; Chrome plated stem; 1.8210" Head Dia., .3870" Stem Dia., 5.1660" O.A.L.
4	Intake	FP-R79623	STD	2 groove; Chrome plated stem; 1.7720" Head Dia., .3720" Stem Dia., 5.1560" O.A.L.
4	Intake	FP-R79628	3	2 groove; Chrome plated stem; 1.7720" Head Dia., .3750" Stem Dia., 5.1560" O.A.L.
4	Intake	FP-R79629	15	2 groove; Chrome plated stem; 1.7720" Head Dia., .3870" Stem Dia., 5.1560" O.A.L.
4	Intake	FP-R79630	30	2 groove; Chrome plated stem; 1.7720" Head Dia., .4020" Stem Dia., 5.1560" O.A.L.
4	Exhaust	FP-R79624	STD	1 groove; Chrome plated stem; 1.5750" Head Dia., .3720" Stem Dia., 5.1560" O.A.L.
4	Exhaust	FP-R79625	3	1 groove; Chrome plated stem; 1.5750" Head Dia., .3750" Stem Dia., 5.1560" O.A.L.
4	Exhaust	FP-R79626	15	1 groove; Chrome plated stem; 1.5750" Head Dia., .3870" Stem Dia., 5.1560" O.A.L.
4	Exhaust	FP-R79627	30	1 groove; Chrome plated stem; 1.5750" Head Dia., .4020" Stem Dia., 5.1560" O.A.L.
16	Keeper	FP-41339		1 groove; Square cut key groove
16	Keeper	FP-T20077		1 groove; Square cut key groove; Hardened
16	Keeper, Bulk	VK-138B		1 groove; Square cut key groove; Carton of 1000
QTY	VALVE SEAT	PART NO.	SIZE	DESCRIPTION
4	Exh.	FP-R51734	STD	
4	Int.	FP-R73064	STD	
QTY	VALVE SPRING	PART NO.	SIZE	DESCRIPTION
8	Spring	FP-R26125		2.1200" Free Height
QTY	VALVE MISC.	PART NO.	SIZE	DESCRIPTION
8	Rotocap	FP-RE11410		Exh. & Int.
1	Bushing	FP-T26321		Lower
1	Bushing	FP-T20034		Upper
1	Oil Filler Cap Gasket	FP-T20328		Rocker arm cover codes 1101, 1104; Oil filler neck codes 1201, 1202, 1203
QTY	VALVE SEAL	PART NO.	SIZE	DESCRIPTION
8	Valve Stem Seal	FP-R87627		O-Ring type
QTY	ROCKER PARTS	PART NO.	SIZE	DESCRIPTION
1	O-Ring	FP-R56463		Rocker cover breather tube; Breather tube codes 2909, 2915

(continued on next page)



# John Deere Off Highway

Loader 4276T Eng. Wheel Tractor 4276T Eng. Crawler Tractor 4276T Eng. Loader Tractor 68  
 4276T Eng. Excavator 4276T Eng. Skidder 4276T Eng. Dozer 4276T Eng. Backhoe 4276T Eng. (cont.)  
 Eng.  
 4.5L 276 OHV Turbo-Diesel L4 (Standard), 4.1875" Bore

ELECTRICAL				
QTY	ELECTRICAL	PART NO.	SIZE	DESCRIPTION
1	Starter to Block Gasket	FP-R53108		3-Hole mount; Starting motor codes 3001, 3017, 3018
QTY	ALTERNATOR	PART NO.	SIZE	DESCRIPTION
1	Ball Brg.	FP-JD9449		Front; Delco-Remy No. 1102936; 61 amp alternator
1	Ball Brg.	FP-JD9449		Front; Motorola No. A12NJD453; 35 amp alternator
1	Ball Brg.	FP-JD9449		Front; Motorola No. A12NJD604; 55 amp alternator
1	Ball Brg.	FP-JD9449		Front; Motorola No. 8TA2009ES; 30 amp alternator
1	Ball Brg.	FP-JD9449		Front; 12 Volt, 63 amp alternator; 72 amp alternator; 78 amp alternator
2	Ball Brg.	FP-JD9449		Front & Rear; Codes 3101, 3102, 3103, 3104, 3105, 3106, 3107, 3108, 3109, 3110, 3111, 3112, 3113, 3114, 3115, 3116, 3129; 65 amp alternator
INT & EXH MANIFOLDS				
QTY	INT. & EXH. MANIFOLDS	PART NO.	SIZE	DESCRIPTION
4	Exhaust Manifold Gasket	FP-R90658		
1	Air Intake Gasket	FP-R81275		
CAMSHAFT GROUP				
QTY	TIMING COVER	PART NO.	SIZE	DESCRIPTION
1	Timing Gear Cover Gasket	FP-T20273		Access cover
1	Timing Gear Cover Gasket	FP-R97454		Front cover
QTY	CAMSHAFT/LIFTER	PART NO.	SIZE	DESCRIPTION
8	Lifter	FP-T20073		
FUEL SYSTEM & PARTS				
QTY	FUEL INJECTION	PART NO.	SIZE	DESCRIPTION
1	Injector Pump Gasket	FP-R125066		Gear cover
4	Fuel Injector Nozzle	FP-RE37503		Nozzle codes 1602, 1603, 1605; From Ser. No. 100,001; Manufactured after 1983
4	Fuel Injector Nozzle	FP-RE37503		Nozzle codes 1602, 1603, 1605; From Ser. No. 290,000 to Ser. No. 621,172; Manufactured 1974-83
4	Fuel Injector Seal	FP-R79605		Fuel line connection; Nozzle codes 1602, 1603, 1605; 9.270MM X 13.600MM X 5.080MM
4	Fuel Injector Seal	FP-R92352		Upper packing; w/Stanadyne® nozzle No. 26993
4	Fuel Injector Nut	FP-R79604		w/Injector marked 20291, 20504, 22205, 22264, 26993
8	Washer Type Seal	FP-R51936		Leak-off & return line seals; Nozzle codes 1602, 1603, 1605
4	Washer Type Seal	FP-R48000		Lower; w/Nozzle codes 1602, 1603, 1605; w/Nozzle marked 26993
4	Washer Type Seal	FP-R60746		Upper; Nozzle codes 1602, 1603, 1605; From Ser. No. 609,312
QTY	FUEL FILTERS & PUMP	PART NO.	SIZE	DESCRIPTION
1	Mechanical Fuel Pump	FP-RE42211		Transfer pump
1	Fuel Transfer Pump Gasket	FP-R97350		
QTY	TURBOCHARGER	PART NO.	SIZE	DESCRIPTION
1	Turbocharger Oil Drain Gasket	FP-R105346		
1	Turbocharger Mounting Gasket	FP-R89879		From Ser. No. 100,001; Manufactured after 1983
1	Turbocharger Mounting Gasket	FP-R89879		From Ser. No. 290,000 to Ser. No. 621,172; Manufactured 1974-83
1	Turbocharger Oil Supply Gskt.	FP-R97348		To Ser. No. 148,514
COOLING SYSTEM				
QTY	WATER PUMP	PART NO.	SIZE	DESCRIPTION
1	Water Pump Impeller	FP-R47191		w/Pump housing marked R66420, R68733
1	Water Pump Impeller	FP-R56812		Pump code 2001
1	Water Pump Repair/Rebuild Kit	FP-864340979		w/Pump housing marked R51661, R73606, R73724, R79171
1	Water Pump Repair/Rebuild Kit	FP-RE62661		w/Pump housing marked R66420, R68733
1	Water Pump Housing Gasket	FP-R56809		w/Pump housing marked AR80116
1	Oil Seal Kit	FP-AR101549		Water Pump; w/Pump housing marked AR80116
1	Water Pump Mounting Gasket	FP-T20243		w/Pump housing marked R54805, R59049
1	Shaft & Bearing Assembly	FP-JD8643		w/Pump housing marked AR80116
QTY	THERMOSTAT	PART NO.	SIZE	DESCRIPTION
2	Thermostat	FP-AR48675		Thermostat code 2204; 180 Deg.
1	Thermostat Gasket	FP-T20219		Thermostat housing code 3901
1	Thermostat Cover Gasket	FP-T20215		Thermostat cover codes 2101, 2102
2	O-Ring	FP-R56461		Thermostat housing tube seals; Housing code 3901

(continued on next page)

**68** Loader 4276T Eng. Wheel Tractor 4276T Eng. Crawler Tractor 4276T Eng. Loader Tractor  
 (cont.) 4276T Eng. Excavator 4276T Eng. Skidder 4276T Eng. Dozer 4276T Eng. Backhoe 4276T  
 Eng.  
 4.5L 276 OHV Turbo-Diesel L4 (Standard), 4.1875" Bore

ENGINE BLOCK & PARTS				
QTY	GASKETS	PART NO.	SIZE	DESCRIPTION
1	Flywheel Housing Gasket	FP-R97351		Use w/Flywheel housing marked R120034, R98778; Use w/thin profile flywheel housing
1	Oil Pan Gasket	FP-R97342		w/Stamped Steel Pan
1	O-Ring	FP-U13639		Block coolant drain plug seal; 1.475" X .118"
1	Block to End Plate Front Gskt	FP-R131794		From Ser. No. 100,001; Manufactured after 1983
1	Block to End Plate Front Gskt	FP-R131794		From Ser. No. 290,000 to Ser. No. 621,172; Manufactured 1974-83
QTY	GASKET SETS	PART NO.	SIZE	DESCRIPTION
1	Gasket Conversion Set	FP-PG219CS		Wear sleeve incl.
1	In-Frame Gasket Set	FP-PG219S		
1	Complete Overhaul Gasket Set	FP-RE37715		Crankshaft seals not incl.
1	Complete Overhaul Gasket Set	FP-RE37715WS		Incl. crankshaft seals; Rear main brg. seal incl.; Wear sleeve not incl.
1	Kit Gasket Set	260-1392		Compl.; Rear main brg. seal incl.; Wear sleeve incl.
QTY	ENGINE BEARING MISC.	PART NO.	SIZE	DESCRIPTION
1	Bal. Shaft Set	FP-R57160S		
6	Balance Shaft Bearing	FP-R57160		
QTY	OIL COOLERS & FILTERS	PART NO.	SIZE	DESCRIPTION
1	Oil Cooler Gasket	FP-R98486		From Ser. No. 100,001; Manufactured after 1983
1	Oil Cooler Gasket	FP-R98487		From Ser. No. 100,001; Manufactured after 1983; Lower oil cooler cover
1	Oil Cooler Gasket	FP-R98486		From Ser. No. 290,000 to Ser. No. 621,172; Manufactured 1974-83
1	Oil Cooler Gasket	FP-R98487		From Ser. No. 290,000 to Ser. No. 621,172; Manufactured 1974-83; Lower oil cooler cover
1	O-Ring	FP-A4730R		From Ser. No. 100,001; Manufactured after 1983; Oil cooler to block check valve seal
1	O-Ring	FP-A4730R		From Ser. No. 290,000 to Ser. No. 621,172; Manufactured 1974-83; Oil cooler to block check valve seal
1	O-Ring	FP-R56815		Oil cooler housing outer seal; From Ser. No. 100,001; Manufactured after 1983
1	O-Ring	FP-R56815		Oil cooler housing outer seal; From Ser. No. 290,000 to Ser. No. 621,172; Manufactured 1974-83
CRANKSHAFT/OIL PUMP				
QTY	CRANKSHAFT	PART NO.	SIZE	DESCRIPTION
1	Crankshaft	FP-RE56792		Crankshaft marked R54501, R108657
1	Oil Seal Kit	FP-SK67942		Incl. front & rear seals; Crankshaft codes 1301, 1302; Crankshaft marked R120009
QTY	SEALS - FRONT CRANK	PART NO.	SIZE	DESCRIPTION
1	Crankshaft Front Seal	FP-AR67942		
1	O-Ring	FP-H35244		Crankshaft pulley; Crankshaft marked R12009
QTY	SEALS - REAR CRANK	PART NO.	SIZE	DESCRIPTION
1	Crankshaft Rear Seal	FP-RE24959		
QTY	MAIN BEARINGS	PART NO.	SIZE	DESCRIPTION
1	Main Set	FP-MBK3004	STD	w/Flanged thrust brg.
1	Main Set	FP-MBK300410	10	w/Flanged thrust brg.
1	Main Set	FP-MBK300420	20	w/Flanged thrust brg.
1	Main Set	FP-MBK300430	30	w/Flanged thrust brg.
4	Plain Main Brg.	FP-RE27352	STD	w/Flangeless thrust brg.
4	Plain Main Brg.	FP-RE27353	10	w/Flangeless thrust brg.
4	Plain Main Brg.	FP-RE27360	20	w/Flangeless thrust brg.
4	Plain Main Brg.	FP-RE27368	30	w/Flangeless thrust brg.
1	Flanged Main Brg.	FP-RE521350	STD	
1	Flanged Main Brg.	FP-RE526754	10	
1	Flanged Main Brg.	FP-RE527235	20	
1	Flanged Main Brg.	FP-RE527236	30	
4	Thrust Washer	FP-R78598	STD	
QTY	OIL PUMP	PART NO.	SIZE	DESCRIPTION
1	O-Ring	FP-R61871		Oil pump inlet; w/Pump housing marked R54629
1	O-Ring	FP-R80632		Oil Pump outlet tube
1	Oil Filler Inlet Gasket	FP-R97352		Oil filler neck codes 1201, 1202, 1203
1	Oil Filter Adapter Gasket	FP-R98488		w/Filter adapter marked R131238

(continued on next page)



# John Deere Off Highway

Loader 4276T Eng. Wheel Tractor 4276T Eng. Crawler Tractor 4276T Eng. Loader Tractor 68  
 4276T Eng. Excavator 4276T Eng. Skidder 4276T Eng. Dozer 4276T Eng. Backhoe 4276T Eng. (cont.)  
 Eng.  
 4.5L 276 OHV Turbo-Diesel L4 (Standard), 4.1875" Bore

## CRANKSHAFT/OIL PUMP (cont.)

QTY	OIL PUMP (cont.)	PART NO.	SIZE	DESCRIPTION
1	Oil Pump Seal Ring	FP-R79563		Oil pump outlet adapter; w/Pump marked R54629; To Ser. No. 122,703

## CYLINDER COMPONENTS

QTY	LINERS	PART NO.	SIZE	DESCRIPTION
4	Liner w/o Sealing Ring	FP-R121867	STD	
4	Liner w/Sealing Rings	FP-RE500024	STD	Pin dia. 1.62"
4	Cylinder Kit Complete	FP-RE19832	STD	w/Con. Rod marked R56187; Pin dia. 1.62"
4	Cyl. Liner Sealing Ring Kit	FP-AR65507		
4	Sealing Ring, Liner	FP-R48767		Rectangle; Top
4	Sealing Ring, Liner	FP-R26121		Round; Middle
4	Sealing Ring	FP-SLR2520		Round; Bottom

QTY	PISTONS	PART NO.	SIZE	DESCRIPTION
4	Piston Body w/o Pin	FP-AR96389		
4	Piston Kit w/Pin & Retainers	FP-AR96389WP		
4	Pin	FP-R124230		1.62" pin dia.
8	Piston Pin Retainer	FP-R54114		For 1.62" pin dia.
4	Pin Bushing	FP-R57451		w/Con. Rod marked R56187, R116851; Pin dia. 1.62"; 1.621" ID, 1.813" OD, 1.370" O.A.L.

QTY	CONNECTING RODS & BRGS.	PART NO.	SIZE	DESCRIPTION
8	Con. Rod Bolt	FP-R74195		w/Con. Rod marked R54617, R56187, R116851; Torque-To-Yield bolt; Replacement recommended
4	Rod Pair	FP-AR97517	STD	
4	Rod Pair	FP-AR97653	10	
4	Rod Pair	FP-AR97654	20	
4	Rod Pair	FP-AR97655	30	

QTY	PISTON RINGS	PART NO.	SIZE	DESCRIPTION
4	Ring Set Single Cylinder	FP-RE507852	STD	1-1/8, 1-3/32, 1-.136 (1 cyl. set)
4	Ring Set Single Cylinder	FP-RE66820	STD	1-1/8, 1-3/32, 1-.136 (1 cyl. set)

## KITS

QTY	OVERHAUL KIT	PART NO.	SIZE	DESCRIPTION
1	In-Frame Overhaul Kit	FP-276TIFK		w/Con. Rod marked R56187, R116851; Pin dia. 1.62"; Incl. Torque-To-Yield con. rod bolts
1	Complete Overhaul Kit	FP-276TOHK		w/Con. Rod marked R56187, R116851; Pin dia. 1.62"; Incl. front & rear seals; Crankshaft codes 1301, 1302; Crankshaft marked R120009; Incl. Torque-To-Yield con. rod bolts

Combine JXC Eng. 69  
 4.6L 282 L-HEAD L6, 3.75" Bore (Hercules Eng.)

## CYL. HEAD & PARTS

QTY	VALVE GUIDE	PART NO.	SIZE	DESCRIPTION
12	Guide	FP-VG414		.3745" ID, 2.3600" O.A.L.

## ENGINE BLOCK & PARTS

QTY	CAM BEARINGS	PART NO.	SIZE	DESCRIPTION
1	Cam Set	FP-1090M		

## CRANKSHAFT/OIL PUMP

QTY	MAIN BEARINGS	PART NO.	SIZE	DESCRIPTION
1	Plain Main Brg.	FP-2241CP10	10	Position 1
1	Plain Main Brg.	FP-2241CP20	20	Position 1
1	Plain Main Brg.	FP-2241CP30	30	Position 1
4	Plain Main Brg.	FP-2243CP10	10	Position 2-3-5-6
4	Plain Main Brg.	FP-2243CP20	20	Position 2-3-5-6
4	Plain Main Brg.	FP-2243CP30	30	Position 2-3-5-6
1	Plain Main Brg.	FP-2242CP10	10	Position 4
1	Plain Main Brg.	FP-2242CP20	20	Position 4
1	Plain Main Brg.	FP-2242CP30	30	Position 4
1	Plain Main Brg.	FP-2244CP10	10	Position 7
1	Plain Main Brg.	FP-2244CP20	20	Position 7
1	Plain Main Brg.	FP-2244CP30	30	Position 7

(continued on next page)

<b>69 Combine JXC Eng.</b> (cont.) 4.6L 282 L-HEAD L6, 3.75" Bore (Hercules Eng.)				
<b>CYLINDER COMPONENTS</b>				
<b>QTY</b>	<b>PISTONS</b>	<b>PART NO.</b>	<b>SIZE</b>	<b>DESCRIPTION</b>
6	Pin Bushing	FP-1424X		Drilled rod type bushing
<b>QTY</b>	<b>CONNECTING RODS &amp; BRGS.</b>	<b>PART NO.</b>	<b>SIZE</b>	<b>DESCRIPTION</b>
6	Rod Pair	FP-1420CP	STD	w/1.9870-1.9880" std. shaft size
6	Rod Pair	FP-1420CP10	10	w/1.9870-1.9880" std. shaft size
6	Rod Pair	FP-1420CP20	20	w/1.9870-1.9880" std. shaft size
6	Rod Pair	FP-1420CP40	40	w/1.9870-1.9880" std. shaft size
<b>QTY</b>	<b>PISTON RINGS</b>	<b>PART NO.</b>	<b>SIZE</b>	<b>DESCRIPTION</b>
1	Premium Set	FP-645KX	STD	3-1/8, 1-3/16
<b>70 Wheel Tractor 4-71 (2-Valve Cyl. Head), 4-71N (4-Valve Cyl. Head) Eng.</b> 4.7L 284 OHV Diesel L4 (4-71), 4.25" Bore (Detroit Diesel Eng.)				
<b>CYL. HEAD &amp; PARTS</b>				
<b>QTY</b>	<b>GASKETS</b>	<b>PART NO.</b>	<b>SIZE</b>	<b>DESCRIPTION</b>
1	Valve Cover Gasket	FP-5104081		Engs. w/cast Alum. valve cover; Silicone
1	Valve Cover Gasket	FP-5143406		Engs. w/Steel valve cover; Neoprene
<b>QTY</b>	<b>VALVE</b>	<b>PART NO.</b>	<b>SIZE</b>	<b>DESCRIPTION</b>
8	Exhaust	FP-5185327		4-71 Engs.; 1 groove, 30 deg. seat; 1.5840" Head Dia., .3420" Stem Dia., 6.4440" O.A.L.
16	Exhaust	FP-8922516		4-71N Engs.; 30 deg. seat; 1.1800" Head Dia., .3103" Stem Dia., 5.5280" O.A.L.
8	Exhaust Valve Kit	FP-5193197		4-71 Engs.; 30 deg. seat; Contains (1) FP-5185327 & (2) FP-23507238; 30 Degree
8	Exhaust Valve Kit	FP-5193666		4-71 Engs.; 30 deg. seat; Jet Blade; Contains (1) FP-5186381 & (2) FP-23507238; 30 Degree
8	Exhaust Valve Kit	FP-5192718		4-71 Engs.; 45 deg. seat; Contains (1) FP-5178472 & (2) FP-23507238; 45 Degree
16	Exhaust Valve Kit	FP-5149386		4-71N Engs.; Contains (1) FP-5104280 & (2) FP-5111337
16	Exhaust Valve Kit	FP-23500501		4-71N Engs.; Contains (1) FP-8922516 & (2) FP-5111337
16	Keeper	FP-23507238		4-71 Engs.; 1 groove; Square cut key groove
16	Keeper	VK-115R		4-71 Engs.; 1 groove; Square cut key groove; Hardened
16	Keeper	VK-63		4-71 Engs.; 2 groove; Round key groove
32	Keeper	FP-5111337		4-71N Engs.; 1 groove; Square cut key groove
32	Keeper	VK-144R		4-71N Engs.; 1 groove; Square cut key groove; Hardened
16	Keeper, Bulk	VK-115B		4-71 Engs.; 1 groove; Square cut key groove; Carton of 1000
<b>QTY</b>	<b>VALVE SEAT</b>	<b>PART NO.</b>	<b>SIZE</b>	<b>DESCRIPTION</b>
8	Exh.	FP-5198230	10	4-71 Engs.; 30 deg. seat; 30 Deg. seat; .010" O/S; 1.6380" OD, 1.3440" ID, .2485" Depth
8	Exh.	FP-8927920	STD	4-71 Engs.; 30 deg. seat; 30 Deg. seat; 1.6280" OD, 1.3440" ID, .2485" Depth
16	Exh.	FP-5197167	10	4-71N Engs.; 30 deg. seat; 30 Deg. seat; .010" O/S; 1.2720" OD, .9770" ID, .2355" Depth
16	Exh.	FP-5101101	STD	4-71N Engs.; 30 deg. seat; 30 Deg. seat; 1.2620" OD, .9770" ID, .2490" Depth
<b>QTY</b>	<b>VALVE GUIDE</b>	<b>PART NO.</b>	<b>SIZE</b>	<b>DESCRIPTION</b>
8	Guide	FP-5192717		4-71 Engs.; .0162" O/S
8	Guide	FP-5120930		4-71 Engs.; .3450" ID, 3.2500" O.A.L.
16	Guide	FP-5129919		4-71N Engs.; 2 3/8" length; Cut for seal; 2 3/8" length; .3130" ID, 2.3800" O.A.L.
<b>QTY</b>	<b>VALVE SPRING</b>	<b>PART NO.</b>	<b>SIZE</b>	<b>DESCRIPTION</b>
8	Spring	FP-5150289		4-71 Engs.; .177" Wire dia.
16	Spring	FP-5147347		4-71N Engs.; .148" Wire dia.
8	Valve Spring Seat	FP-5150292		4-71 Engs.
16	Valve Spring Seat	FP-51117562		4-71N Engs.
16	Spring Insert	FP-5111467		Exh. Valve Spring Washer
8	Spring Cap	FP-5150291		4-71 Engs.
16	Spring Cap	FP-5117563		4-71N Engs.
<b>QTY</b>	<b>PUSH RODS</b>	<b>PART NO.</b>	<b>SIZE</b>	<b>DESCRIPTION</b>
12	Push Rod	FP-5128640		
12	Push Rod Seat	FP-5123250		Lower
12	Push Rod Seat	FP-5150302		Upper; Flange type
12	Push Rod Spring	FP-5186858		.177" Wire diameter
12	Push Rod Retainer	FP-5150303		
12	Lock Nut	FP-5151601		Push rod; 5/16" - 24
12	Rect. or Square Seal	FP-5154472		Push rod

(continued on next page)





# John Deere Off Highway

## Wheel Tractor 4-71 (2-Valve Cyl. Head), 4-71N (4-Valve Cyl. Head) Engs. 70 4.7L 284 OHV Diesel L4 (4-71), 4.25" Bore (Detroit Diesel Eng.) (cont.)

CYL. HEAD & PARTS (cont.)				
QTY	VALVE SEAL	PART NO.	SIZE	DESCRIPTION
8	Valve Stem Seal	ST-2001		4-71 Engs.; Positive type; Installation requires valve guide machining; Rubber/PTFE
8	Valve Stem Seal	FP-23500480		4-71 Engs.; O.D. .562"
16	Valve Stem Seal	FP-8921209		4-71N Engs.; Use w/FP-5129919 guide
8	Valve Stem Seal Bulk	ST-2001BC		4-71 Engs.; Positive type; Installation requires valve guide machining; Carton of 100; Rubber/PTFE
QTY	ROCKER PARTS	PART NO.	SIZE	DESCRIPTION
4	Arm Assy.	FP-5148472		Exh. Left
4	Arm Assy.	FP-5148475		Exh. Right
4	Arm Assy.	FP-8923554		Injector
2	Rocker Shaft	FP-23500714		
8	Rocker Shaft Bracket Bolt	FP-5150325		1/2" - 13 x 4.250"
24	Arm Support	FP-5103903		
8	Rocker Bushing	FP-23517217		Large; .8755" ID, .9475" OD, .840" Length, .0360" Wall thickness
4	Rocker Bushing	FP-8924355		Large; Injector bushing
4	Rocker Bushing	FP-8924354		Small; Injector bushing
8	Rocker Bushing	FP-8924354		Small; Rocker bushing
8	Rocker Bushing	FP-5123700		Exh.; Clevis bushing; .5625" OD
4	Rocker Bushing	FP-5123700		Injector; Clevis bushing; .5625" OD
12	Follower Assy.	FP-8924439		
24	Cam Follower Roller Set	FP-8923814		Incl. pin & roller
8	Valve Bridge Adj. Screw	FP-5129101		5/16" - 24 x 1"
8	Valve Bridge	FP-5117565		
8	Valve Bridge Guide	FP-5117564		Press fit
8	Valve Bridge Guide	FP-5196843		Threaded
8	Rocker Arm Clevis Pin	FP-5150314		Exh.
4	Rocker Arm Clevis Pin	FP-5150314		Injector
CAMSHAFT GROUP				
QTY	TIMING	PART NO.	SIZE	DESCRIPTION
1	Idler Gear Hub Assembly	FP-5124458		
QTY	CAMSHAFT TIMING	PART NO.	SIZE	DESCRIPTION
2	Camshaft Pulley Spacer	FP-5121071		Front
QTY	CAMSHAFT/LIFTER	PART NO.	SIZE	DESCRIPTION
2	Camshaft Thrust Washer	FP-5111424	STD	
2	Camshaft Thrust Washer	FP-5194826	5	
2	Camshaft Thrust Washer	FP-5194827	10	
8	Bolt	FP-443603		Cam guide; .250" x 20 x .750"
8	Lock Washer	FP-103319		Cam guide; .250"
8	Lock Washer	FP-103320		Cam guide; 5/16"
ACCESSORY DRIVE				
QTY	ACCESSORY DRIVE	PART NO.	SIZE	DESCRIPTION
1	Oil Seal	FP-5131329		
FUEL SYSTEM & PARTS				
QTY	FUEL INJECTION	PART NO.	SIZE	DESCRIPTION
4	Fuel Injector Seal Ring	FP-5104701		Viton®
4	Injector Hole Tube Kit	FP-8925981		Viton®
ENGINE BLOCK & PARTS				
QTY	GASKETS	PART NO.	SIZE	DESCRIPTION
2	Cylinder Cover Gasket	FP-23505518		End plate
QTY	GASKET SETS	PART NO.	SIZE	DESCRIPTION
1	Complete Overhaul Gasket Set	FP-23512675		High block; Crankshaft seals not incl.
1	Complete Overhaul Gasket Set	FP-23512675WS		High block; Incl. Crankshaft seals
1	Complete Overhaul Gasket Set	FP-5192922		Low block
QTY	CAM BEARINGS	PART NO.	SIZE	DESCRIPTION
2	Cam Brg.	FP-5111423	STD	Position Front & Rear; Grooved
3	Cam Brg.	FP-5196026	STD	Position Inter.; w/o Steel bushing in ctr. hole; Aluminum Blocks only
3	Cam Brg.	FP-5196022	STD	Position Inter.; W/Steel bushing in ctr. hole
CRANKSHAFT/OIL PUMP				
QTY	SEALS - FRONT CRANK	PART NO.	SIZE	DESCRIPTION
1	Oil Seal Spacer	FP-23507306		Front; 2.50" ID x 2.81" Length
1	Oil Seal Spacer	FP-5192496		Rear; Exc. for double lip seal

(continued on next page)

**70 Wheel Tractor 4-71 (2-Valve Cyl. Head), 4-71N (4-Valve Cyl. Head) Eng.**  
 (cont.) 4.7L 284 OHV Diesel L4 (4-71), 4.25" Bore (Detroit Diesel Eng.)

**CRANKSHAFT/OIL PUMP (cont.)**

SEALS - FRONT CRANK				
QTY		PART NO.	SIZE	DESCRIPTION
1	Oil Seal	FP-5115454		Single Lip, Std.
1	Oil Seal	FP-5143108		Submersible
SEALS - REAR CRANK				
QTY		PART NO.	SIZE	DESCRIPTION
1	Oil Seal	FP-5196927		Double Lip; O/S Shaft Dia. 4.812"
1	Oil Seal	FP-5127821		Double Lip, Std.; Shaft Dia. 4.687"
1	Oil Seal	FP-5197860		Single lip; O/S Shaft dia. 4.812"
1	Oil Seal	FP-5114335		Single Lip, Std.; Shaft Dia. 4.687"
1	Redi-Sleeve	FP-23507225		
MAIN BEARINGS				
QTY		PART NO.	SIZE	DESCRIPTION
5	Plain Main Brg.	FP-5192874	STD	
5	Plain Main Brg.	FP-5192875	2	
5	Plain Main Brg.	FP-5192876	10	
5	Plain Main Brg.	FP-5192877	20	
5	Plain Main Brg.	FP-5192878	30	
5	Plain Main Brg.	FP-5193738	40	
5	Plain Main Brg.	FP-5193739	50	
1	Thrust Washer Set	FP-5159353S	STD	Position Rear
4	Thrust Washer	FP-5159353	STD	Position Rear
4	Thrust Washer	FP-5160542	5	Position Rear
4	Thrust Washer	FP-5192111	10	Position Rear

**CYLINDER COMPONENTS**

LINERS				
QTY		PART NO.	SIZE	DESCRIPTION
4	Liner w/o Sealing Ring	FP-5102316	5	Flanged, .810" port length
4	Liner w/o Sealing Ring	FP-5102317	10	Flanged, .810" port length
4	Liner w/o Sealing Ring	FP-5102318	20	Flanged, .810" port length
4	Liner w/o Sealing Ring	FP-5102319	30	Flanged, .810" port length
4	Liner w/o Sealing Ring	FP-5193732	5	Flanged, 1.050" port length
4	Liner w/o Sealing Ring	FP-5193733	10	Flanged, 1.050" port length
4	Liner w/o Sealing Ring	FP-5193734	20	Flanged, 1.050" port length
4	Liner w/o Sealing Ring	FP-5193735	30	Flanged, 1.050" port length
4	Liner w/o Sealing Ring	FP-23504931	STD	No. 1 Bore; Flanged, .810" port length
4	Liner w/o Sealing Ring	FP-23502020	STD	No. 1 Bore; Flanged, 1.050" port length
4	Liner w/o Sealing Ring	FP-23504932	STD	No. 2 Bore; Flanged, .810" port length
4	Liner w/o Sealing Ring	FP-23502021	STD	No. 2 Bore; Flanged, 1.050" port length
4	Liner w/o Sealing Ring	FP-23504933	STD	No. 3 Bore; Flanged, .810" port length
4	Liner w/o Sealing Ring	FP-23502022	STD	No. 3 Bore; Flanged, 1.050" port length
4	Liner w/o Sealing Ring	FP-23504934	STD	No. 4 Bore; Flanged, .810" port length
4	Liner w/o Sealing Ring	FP-23504936	STD	No. 4 Bore; Flanged, 1.050" port length
4	Cylinder Kit Complete	FP-235229495	5	w/Cross Head style piston; 1.050" port length sleeve
4	Cylinder Kit Complete	FP-23522951	10	w/Cross Head style piston; 1.050" port length sleeve
4	Cylinder Kit Complete	FP-23522525	20	w/Cross Head style piston; 1.050" port length sleeve
4	Cylinder Kit Complete	FP-2352294930	30	w/Cross Head style piston; 1.050" port length sleeve
4	Cylinder Kit Complete	FP-235053095	5	4-71 Eng.s.; w/Trunk style piston; .810" port length sleeve
4	Cylinder Kit Complete	FP-2350530910	10	4-71 Eng.s.; w/Trunk style piston; .810" port length sleeve
4	Cylinder Kit Complete	FP-2350530920	20	4-71 Eng.s.; w/Trunk style piston; .810" port length sleeve
4	Cylinder Kit Complete	FP-2350530930	30	4-71 Eng.s.; w/Trunk style piston; .810" port length sleeve
4	Cylinder Kit Complete	FP-235053065	5	4-71N Eng.s.; w/Trunk style piston; 1.05" port length sleeve
4	Cylinder Kit Complete	FP-5149263	10	4-71N Eng.s.; w/Trunk style piston; 1.05" port length sleeve
4	Cylinder Kit Complete	FP-5149264	20	4-71N Eng.s.; w/Trunk style piston; 1.05" port length sleeve
4	Cylinder Kit Complete	FP-2350530630	30	4-71N Eng.s.; w/Trunk style piston; 1.05" port length sleeve
4	Cylinder Kit Complete	FP-20022	STD	No. 1 Bore; w/Cross Head style piston
4	Cylinder Kit Complete	FP-20014	STD	No. 1 Bore; 4-71 Eng.s.; w/Trunk style piston
4	Cylinder Kit Complete	FP-20011	STD	No. 1 Bore; 4-71N Eng.s.; w/Trunk style piston; 1.05" port length sleeve
4	Cylinder Kit Complete	FP-23522949	STD	No. 2 Bore; w/Cross Head style piston; 1.050" port length sleeve
4	Cylinder Kit Complete	FP-23505308	STD	No. 2 Bore; 4-71 Eng.s.; w/Trunk style piston; .810" port length sleeve
4	Cylinder Kit Complete	FP-23505305	STD	No. 2 Bore; 4-71N Eng.s.; w/Trunk style piston; 1.05" port length sleeve
4	Cylinder Kit Complete	FP-23522947	STD	No. 3 Bore; w/Cross Head style piston; 1.050" port length sleeve
4	Cylinder Kit Complete	FP-23505309	STD	No. 3 Bore; 4-71 Eng.s.; w/Trunk style piston
4	Cylinder Kit Complete	FP-23505306	STD	No. 3 Bore; 4-71N Eng.s.; w/Trunk style piston; 1.05" port length sleeve
4	Cylinder Kit Complete	FP-23522521	STD	No. 4 Bore; w/Cross Head style piston; 1.050" port length sleeve
4	Cylinder Kit Complete	FP-235053091	1	No. 4 Bore; 4-71 Eng.s.; w/Trunk style piston; .810" port length sleeve

(continued on next page)



## Wheel Tractor 4-71 (2-Valve Cyl. Head), 4-71N (4-Valve Cyl. Head) Eng. 70 4.7L 284 OHV Diesel L4 (4-71), 4.25" Bore (Detroit Diesel Eng.) (cont.)

<b>CYLINDER COMPONENTS (cont.)</b>				
<b>QTY</b>	<b>LINERS (cont.)</b>	<b>PART NO.</b>	<b>SIZE</b>	<b>DESCRIPTION</b>
4	Cylinder Kit Complete	FP-5149261	STD	No. 4 Bore; 4-71N Eng.; w/Trunk style piston; 1.05" port length sleeve
4	Liner Kit w/o Sleeve	FP-LCK5309		4-71 Eng.; 17.5:1 C.R.; w/Trunk style piston
4	Liner Kit w/o Sleeve	FP-LCK5306		4-71N Eng.; 18.7:1 C.R.; w/Trunk style piston
4	O-Ring	FP-8922221		w/Cross Head style piston
4	Cntr. Bore Insert	FP-5199871		.0015" Thicker than std., for .010-.030 O/S sleeves
4	Cntr. Bore Insert	FP-5148399		.0015" Thicker than std., for std.-.005 O/S sleeves
4	Cntr. Bore Insert	FP-5148440		.0015" Thinner than std., for std.-.005 O/S sleeves
4	Cntr. Bore Insert	FP-5194073		.0035 Thinner than std., for std.-.005 O/S sleeves
4	Cntr. Bore Insert	FP-5194163		.0040 Thinner than std., for .010-.030 O/S sleeves
4	Cntr. Bore Insert	FP-5194164		.0080" Thinner than std., for .010-.030 O/S sleeves
4	Cntr. Bore Insert	FP-5193316		Std. thickness (.1795-.1800), for .010-.030 O/S sleeves
4	Cntr. Bore Insert	FP-5184484		Std. thickness (.1795-.1800), for std.-.005 O/S sleeves
<b>QTY</b>	<b>PISTONS</b>	<b>PART NO.</b>	<b>SIZE</b>	<b>DESCRIPTION</b>
4	Piston Kit w/Pin & Retainers	FP-23522497	STD	w/Cross Head style piston
4	Piston With Retainers	FP-5189054	STD	4-71 Eng.; w/Trunk style piston; Dish Head, Cast Iron; 4-1/8, 2-3/16 Ring Groove
4	Piston With Retainers	FP-5149234	STD	4-71N Eng.; w/Trunk style piston
4	Piston Dome Kit	FP-23522475		17.0:1 C.R.; w/Cross Head style piston
4	Piston Dome Kit	FP-23522535		18.7:1 C.R.; w/Cross Head style piston
4	Crosshead Piston Dome	FP-23521992	STD	17.0:1 C.R.; w/Cross Head style piston
4	Crosshead Piston Dome	FP-23522026	STD	18.7:1 C.R.; w/Cross Head style piston
4	Piston Skirt	FP-23522070	STD	w/Cross Head style piston
4	Pin	FP-5144744	STD	w/Cross Head style piston; Nut plate type
4	Pin	FP-5101120	STD	w/Cross Head style piston; Slipper type
4	Pin	FP-5188406	STD	w/Trunk style piston
4	Pin	FP-5144495	STD	w/Trunk style piston; Drilled
4	Pin	FP-5130881	STD	w/Trunk style piston; Non-drilled
8	Piston Pin Retainer	FP-5180250		w/Cross Head style piston
8	Piston Pin Retainer	FP-5188405		w/Trunk style piston
8	Piston Pin Bolt	FP-5148373		7/16" - 20 x 2.00" Length
8	Piston Pin Bolt Spacer	FP-5144846		w/Cross Head style piston
4	Piston Pin Slipper Bearing	FP-23501687		w/Cross Head style piston; Slipper type design - 1 per cyl.
8	Pin Bushing	FP-5157274		w/.015" extra ID bore stock
8	Pin Bushing	FP-2409Y		w/1.5020" I.D., 1.7510" O.D., .7600" O.A.L.
<b>QTY</b>	<b>CONNECTING RODS &amp; BRGS.</b>	<b>PART NO.</b>	<b>SIZE</b>	<b>DESCRIPTION</b>
8	Con. Rod Bolt	FP-5132383		.4375" x 20 x 3.52"
8	Con. Rod Nut	FP-5117629		.4375" x 20
4	Rod Pair	FP-23511129	STD	Upper brg. w/2 oil slots
4	Rod Pair	FP-23511131	2	Upper brg. w/2 oil slots
4	Rod Pair	FP-23511133	10	Upper brg. w/2 oil slots
4	Rod Pair	FP-23511135	20	Upper brg. w/2 oil slots
4	Rod Pair	FP-23511137	30	Upper brg. w/2 oil slots
4	Rod Pair	FP-5193741	40	Upper brg. w/2 oil slots
<b>QTY</b>	<b>PISTON RINGS</b>	<b>PART NO.</b>	<b>SIZE</b>	<b>DESCRIPTION</b>
4	Ring Set Single Cylinder	FP-23522955	STD	w/Cross Head style piston; Std. gap Fire Ring
4	Ring Set Single Cylinder	FP-23522954	STD	w/Cross Head style piston; Wide gap Fire Ring
4	Ring Set Single Cylinder	FP-5193477	STD	4-71 Eng.; w/Trunk style piston; 4-1/8, 2-3/16 (1 cyl. set w/4 Chrome rings)
4	Ring Set Single Cylinder	FP-23514970	STD	4-71N Eng.; w/Trunk style piston; 4-.084, 2-3/16 (1 cyl. Set)
4	Compression Ring	FP-8924084		w/Cross Head style piston; Std. gap Fire Ring
4	Compression Ring	FP-8924083		w/Cross Head style piston; Wide gap Fire Ring
8	Compression Ring	FP-8926351		w/Cross Head style piston; 2nd & 3rd grooves
16	Compression Ring	FP-5185325		4-71 Eng.; Trunk style piston
12	Compression Ring	FP-5102648		4-71N Eng.; Trunk style piston
8	Ring, Oil Control Set	FP-23522534		w/Cross Head style piston
4	Ring, Oil Control Set	FP-23514965		4-71N Eng.; Trunk style piston; Set for one piston
<b>KITS</b>				
<b>QTY</b>	<b>OVERHAUL KIT</b>	<b>PART NO.</b>	<b>SIZE</b>	<b>DESCRIPTION</b>
1	In-Frame Overhaul Kit	FP-471XH		Cross head turbo; w/4 valve head; Upper rod brg. w/2 oil slots
1	In-Frame Overhaul Kit	FP-4712V		4-71 Eng.; w/Trunk style piston; w/2 valve head; Upper rod brg. w/2 oil slots
1	In-Frame Overhaul Kit	FP-471NA		4-71N Eng.; w/Trunk style piston; w/4 valve head; Upper rod brg. w/2 oil slots
1	Complete Overhaul Kit	FP-471XHOH		w/Cross Head style piston; Upper brg. w/2 oil slots; Incl. High block gsks.

(continued on next page)

<b>70 Wheel Tractor 4-71 (2-Valve Cyl. Head), 4-71N (4-Valve Cyl. Head) Engs.</b> (cont.) 4.7L 284 OHV Diesel L4 (4-71), 4.25" Bore (Detroit Diesel Eng.)				
<b>KITS (cont.)</b>				
<b>QTY</b>	<b>OVERHAUL KIT (cont.)</b>	<b>PART NO.</b>	<b>SIZE</b>	<b>DESCRIPTION</b>
1	Complete Overhaul Kit	FP-4712VOH		4-71 Engs.; w/Trunk style piston; Upper brg. w/2 oil slots; Incl. High block & Low block gskt. sets
1	Complete Overhaul Kit	FP-471NAOH		4-71N Engs.; w/Trunk style piston; Upper brg. w/2 oil slots; Incl. High block gskts.
<b>71 Combine 301G Eng. Wheel Tractor 301G Eng.</b> 4.9L 302 OHV L6, 4" Bore				
<b>CYL. HEAD &amp; PARTS</b>				
<b>QTY</b>	<b>VALVE</b>	<b>PART NO.</b>	<b>SIZE</b>	<b>DESCRIPTION</b>
6	Intake	FP-V1635		1.6880" Head Dia., .3720" Stem Dia., 5.7000" O.A.L.
6	Exhaust	FP-V1634		1.5000" Head Dia., .3720" Stem Dia., 5.7310" O.A.L.
24	Keeper	FP-B367R		2 groove
<b>QTY</b>	<b>VALVE SEAT</b>	<b>PART NO.</b>	<b>SIZE</b>	<b>DESCRIPTION</b>
6	Int.	FP-R78702	STD	1.7550" OD, 1.5000" ID, .2160" Depth
<b>QTY</b>	<b>VALVE GUIDE</b>	<b>PART NO.</b>	<b>SIZE</b>	<b>DESCRIPTION</b>
12	Guide	FP-VG606		.3750" ID, 2.9400" O.A.L.
<b>ENGINE BLOCK &amp; PARTS</b>				
<b>QTY</b>	<b>CAM BEARINGS</b>	<b>PART NO.</b>	<b>SIZE</b>	<b>DESCRIPTION</b>
1	Cam Set	FP-4R46903	STD	
4	Cam Brg.	FP-R46903	STD	
<b>CRANKSHAFT/OIL PUMP</b>				
<b>QTY</b>	<b>SEALS - REAR CRANK</b>	<b>PART NO.</b>	<b>SIZE</b>	<b>DESCRIPTION</b>
1	Oil Seal	FP-RE22764		PTFE
<b>QTY</b>	<b>MAIN BEARINGS</b>	<b>PART NO.</b>	<b>SIZE</b>	<b>DESCRIPTION</b>
1	Main Set	FP-MBK3007	STD	Early Engs.; w/Flanged brg.
1	Main Set	FP-MBK300710	10	Early Engs.; w/Flanged brg.
1	Main Set	FP-MBK300720	20	Early Engs.; w/Flanged brg.
1	Main Set	FP-MBK300730	30	Early Engs.; w/Flanged brg.
1	Main Set	FP-MBK3005	STD	Late Engs.; w/Thrust washer; w/Blocks marked R40930, R40940
1	Main Set	FP-MBK300510	10	Late Engs.; w/Thrust washer; w/Blocks marked R40930, R40940
1	Main Set	FP-MBK300520	20	Late Engs.; w/Thrust washer; w/Blocks marked R40930, R40940
1	Main Set	FP-MBK300530	30	Late Engs.; w/Thrust washer; w/Blocks marked R40930, R40940
1	Thrust Washer Set	FP-AR77747	STD	
<b>CYLINDER COMPONENTS</b>				
<b>QTY</b>	<b>LINERS</b>	<b>PART NO.</b>	<b>SIZE</b>	<b>DESCRIPTION</b>
6	Sleeve Assy.	FP-SL2084		Contains piston to replace O.E. No. R26089R; O-rings in block
<b>QTY</b>	<b>PISTONS</b>	<b>PART NO.</b>	<b>SIZE</b>	<b>DESCRIPTION</b>
6	Pin Bushing	FP-3129YA20		1.252" ID, 1.3785" OD, 1.510" O.A.L.
<b>QTY</b>	<b>CONNECTING RODS &amp; BRGS.</b>	<b>PART NO.</b>	<b>SIZE</b>	<b>DESCRIPTION</b>
6	Rod Pair	FP-AR45723	STD	
6	Rod Pair	FP-AR46396	10	
6	Rod Pair	FP-AR46397	20	
6	Rod Pair	FP-AR46398	30	
<b>QTY</b>	<b>PISTON RINGS</b>	<b>PART NO.</b>	<b>SIZE</b>	<b>DESCRIPTION</b>
3	Premium Set	FP-5834KX	STD	3-3/32, 2-1/4 (2 cyl. set)
6	Premium Single Cylinder Set	W-5834KX Std Only		3-3/32, 2-1/4 (1 cyl. set)
<b>72 Combine 6303G Eng. Cotton Picker 6303G Eng. Power Unit JD303G, 6303G Engs. Wheel Tractor 6303G Eng. Loader Tractor 6303G Eng.</b> 5.0L 303 OHV L6, 3.8594" Bore				
<b>CYL. HEAD &amp; PARTS</b>				
<b>QTY</b>	<b>GASKETS</b>	<b>PART NO.</b>	<b>SIZE</b>	<b>DESCRIPTION</b>
1	Head Gasket	FP-R98462		
<b>QTY</b>	<b>VALVE</b>	<b>PART NO.</b>	<b>SIZE</b>	<b>DESCRIPTION</b>
24	Keeper	FP-41339		1 groove; Square cut key groove
24	Keeper	FP-T20077		1 groove; Square cut key groove; Hardened
24	Keeper, Bulk	VK-138B		1 groove; Square cut key groove; Carton of 1000
<b>QTY</b>	<b>VALVE SPRING</b>	<b>PART NO.</b>	<b>SIZE</b>	<b>DESCRIPTION</b>
12	Spring	FP-R26125		2.1200" Free Height

(continued on next page)



# John Deere Off Highway

Combine 6303G Eng. Cotton Picker 6303G Eng. Power Unit JD303G, 6303G Engs. Wheel **72**  
 Tractor 6303G Eng. Loader Tractor 6303G Eng. (cont.)  
 5.0L 303 OHV L6, 3.8594" Bore

CYL. HEAD & PARTS (cont.)				
<b>QTY</b>	<b>ROCKER PARTS</b>	<b>PART NO.</b>	<b>SIZE</b>	<b>DESCRIPTION</b>
1	O-Ring	FP-R56463		Rocker cover breather tube
ELECTRICAL				
<b>QTY</b>	<b>ALTERNATOR</b>	<b>PART NO.</b>	<b>SIZE</b>	<b>DESCRIPTION</b>
1	Ball Brg.	FP-JD9449		Front; Motorola Nos. TA12NJD400, 8TA200ES
2	Ball Brg.	FP-JD9449		Front & Rear; 65 amp alternator
CAMSHAFT GROUP				
<b>QTY</b>	<b>CAMSHAFT/LIFTER</b>	<b>PART NO.</b>	<b>SIZE</b>	<b>DESCRIPTION</b>
12	Lifter	FP-T20073		
COOLING SYSTEM				
<b>QTY</b>	<b>WATER PUMP</b>	<b>PART NO.</b>	<b>SIZE</b>	<b>DESCRIPTION</b>
1	Water Pump Impeller	FP-R94419		w/Pump housing marked R48992
1	Water Pump Impeller	FP-R40979		Models 55, 95H, 95LL, 699
1	Water Pump Repair/Rebuild Kit	FP-939840979		w/Pump housing marked R29701, R48994
1	Water Pump Housing Gasket	FP-T25485		w/Pump housing marked R48994
1	Water Pump Housing Gasket	FP-R97455		Model 6600
1	Water Intake Gasket	FP-T23132		
1	Water Pump Mounting Gasket	FP-T20243		w/Pump housing marked AR80112, RE19939
1	Shaft & Bearing Assembly	FP-JD9398		w/Pump housing marked R48994
<b>QTY</b>	<b>THERMOSTAT</b>	<b>PART NO.</b>	<b>SIZE</b>	<b>DESCRIPTION</b>
1	Thermostat	FP-AR70601		Models 55, 95H, 95LL, 699, 6600; 180 Deg.
1	Thermostat	FP-AR77411		Models 55, 95H, 95LL, 699, 6600; 195 Deg.
1	Thermostat Cover Gasket	FP-T24932		Water manifold marked R61178
ENGINE BLOCK & PARTS				
<b>QTY</b>	<b>GASKETS</b>	<b>PART NO.</b>	<b>SIZE</b>	<b>DESCRIPTION</b>
1	Flywheel Housing Gasket	FP-R97351		
1	Block to End Plate Front Gskt	FP-R131794		
CRANKSHAFT/OIL PUMP				
<b>QTY</b>	<b>CRANKSHAFT</b>	<b>PART NO.</b>	<b>SIZE</b>	<b>DESCRIPTION</b>
1	Oil Seal Kit	FP-SK67942		Incl. front & rear seals
<b>QTY</b>	<b>SEALS - FRONT CRANK</b>	<b>PART NO.</b>	<b>SIZE</b>	<b>DESCRIPTION</b>
1	Crankshaft Front Seal	FP-AR67942		
1	O-Ring	FP-H35244		Crankshaft pulley
<b>QTY</b>	<b>SEALS - REAR CRANK</b>	<b>PART NO.</b>	<b>SIZE</b>	<b>DESCRIPTION</b>
1	Crankshaft Rear Seal	FP-RE24959		
<b>QTY</b>	<b>MAIN BEARINGS</b>	<b>PART NO.</b>	<b>SIZE</b>	<b>DESCRIPTION</b>
1	Main Set	FP-MBK3003	STD	w/Flanged thrust brg.
1	Main Set	FP-MBK300310	10	w/Flanged thrust brg.
1	Main Set	FP-MBK300320	20	w/Flanged thrust brg.
1	Main Set	FP-MBK300330	30	w/Flanged thrust brg.
<b>QTY</b>	<b>OIL PUMP</b>	<b>PART NO.</b>	<b>SIZE</b>	<b>DESCRIPTION</b>
1	Pump Repair Kit	FP-RE55343		w/Pump housing marked R54615
1	O-Ring	FP-A4730R		From Ser. No. 243,648; Oil pump pickup to pump cover seal
1	O-Ring	FP-R61871		Oil pump inlet
CYLINDER COMPONENTS				
<b>QTY</b>	<b>LINERS</b>	<b>PART NO.</b>	<b>SIZE</b>	<b>DESCRIPTION</b>
6	Liner w/Sealing Rings	FP-AR51902	STD	Early Model JD544
6	Liner w/Sealing Rings	FP-T32340WS	STD	Exc. Early Model JD544
<b>QTY</b>	<b>PISTONS</b>	<b>PART NO.</b>	<b>SIZE</b>	<b>DESCRIPTION</b>
6	Pin Bushing	FP-T23471		1.1896" ID, 1.313" OD, 1.570" O.A.L.
6	Pin Bushing	FP-R55647		1.3765" ID, 1.500" OD, 1.570" O.A.L.
<b>QTY</b>	<b>CONNECTING RODS &amp; BRGS.</b>	<b>PART NO.</b>	<b>SIZE</b>	<b>DESCRIPTION</b>
6	Rod Pair	FP-RE27348	STD	
6	Rod Pair	FP-RE27349	10	
6	Rod Pair	FP-RE27358	20	
6	Rod Pair	FP-RE27364	30	
<b>QTY</b>	<b>PISTON RINGS</b>	<b>PART NO.</b>	<b>SIZE</b>	<b>DESCRIPTION</b>
6	Ring Set Single Cylinder	FP-AR70633	STD	2-3/32, 1-.196 (1 cyl. set)

**73** Combine 6303D Eng. Cotton Picker 6303D Eng. Grader 6303D Eng. Loader 6303D Eng.  
 Power Unit JD303D, 6303D Engs. Loader Tractor 6303D Eng. Skidder 6303D Eng.  
 5.0L 303 OHV Diesel L6, 3.8594" Bore

CYL. HEAD & PARTS				
QTY	GASKETS	PART NO.	SIZE	DESCRIPTION
1	Head Gasket	FP-R98462		
1	Head Set	FP-RE38849		
QTY	VALVE	PART NO.	SIZE	DESCRIPTION
6	Intake	FP-R79623	STD	2 groove; Chrome plated stem; 1.7720" Head Dia., .3720" Stem Dia., 5.1560" O.A.L.
6	Intake	FP-R79628	3	2 groove; Chrome plated stem; 1.7720" Head Dia., .3750" Stem Dia., 5.1560" O.A.L.
6	Intake	FP-R79629	15	2 groove; Chrome plated stem; 1.7720" Head Dia., .3870" Stem Dia., 5.1560" O.A.L.
6	Intake	FP-R79630	30	2 groove; Chrome plated stem; 1.7720" Head Dia., .4020" Stem Dia., 5.1560" O.A.L.
6	Exhaust	FP-R79624	STD	1 groove; Chrome plated stem; 1.5750" Head Dia., .3720" Stem Dia., 5.1560" O.A.L.
6	Exhaust	FP-R79625	3	1 groove; Chrome plated stem; 1.5750" Head Dia., .3750" Stem Dia., 5.1560" O.A.L.
6	Exhaust	FP-R79626	15	1 groove; Chrome plated stem; 1.5750" Head Dia., .3870" Stem Dia., 5.1560" O.A.L.
6	Exhaust	FP-R79627	30	1 groove; Chrome plated stem; 1.5750" Head Dia., .4020" Stem Dia., 5.1560" O.A.L.
24	Keeper	FP-41339		1 groove; Square cut key groove
24	Keeper	FP-T20077		1 groove; Square cut key groove; Hardened
24	Keeper, Bulk	VK-138B		1 groove; Square cut key groove; Carton of 1000
QTY	VALVE SEAT	PART NO.	SIZE	DESCRIPTION
6	Exh.	FP-R51734	STD	
6	Int.	FP-R73064	STD	
QTY	VALVE SPRING	PART NO.	SIZE	DESCRIPTION
12	Spring	FP-R26125		2.1200" Free Height
QTY	VALVE MISC.	PART NO.	SIZE	DESCRIPTION
6	Rotocap	FP-RE11410		Exh.
1	Bushing	FP-T26321		Lower
1	Bushing	FP-T20034		Upper
QTY	VALVE SEAL	PART NO.	SIZE	DESCRIPTION
12	Valve Stem Seal	FP-R87627		O-Ring type
QTY	ROCKER PARTS	PART NO.	SIZE	DESCRIPTION
1	O-Ring	FP-R56463		Rocker cover breather tube
ELECTRICAL				
QTY	ALTERNATOR	PART NO.	SIZE	DESCRIPTION
1	Ball Brg.	FP-JD9449		Front; Motorola Nos. TA12NJD400, 8TA200ES
2	Ball Brg.	FP-JD9449		Front & Rear; 65 amp alternator
INT & EXH MANIFOLDS				
QTY	INT. & EXH. MANIFOLDS	PART NO.	SIZE	DESCRIPTION
6	Exhaust Manifold Gasket	FP-R90658		
2	Air Intake Gasket	FP-R81275		
CAMSHAFT GROUP				
QTY	CAMSHAFT/LIFTER	PART NO.	SIZE	DESCRIPTION
12	Lifter	FP-T20073		
FUEL SYSTEM & PARTS				
QTY	FUEL INJECTION	PART NO.	SIZE	DESCRIPTION
6	Fuel Injector Nozzle	FP-AR89564		
12	Washer	FP-T20055		
18	Clamp	FP-R34766		To Ser. No. 108,848
6	Washer Type Seal	FP-R48000		Lower; w/Nozzle marked 18742, 19762, 20500, 20631, 22042, 22202
6	Washer Type Seal	FP-R60746		Upper; w/Nozzle marked 20631, 22042, 22202
QTY	FUEL FILTERS & PUMP	PART NO.	SIZE	DESCRIPTION
1	Mechanical Fuel Pump	FP-RE42211		Transfer pump
1	Fuel Transfer Pump Gasket	FP-R97350		
COOLING SYSTEM				
QTY	WATER PUMP	PART NO.	SIZE	DESCRIPTION
1	Water Pump Impeller	FP-R40979		Models 55, 95H, 95LL, 699
1	Water Pump Repair/Rebuild Kit	FP-939840979		w/Pump housing marked R29701, R48994

(continued on next page)



# John Deere Off Highway

**Combine 6303D Eng. Cotton Picker 6303D Eng. Grader 6303D Eng. Loader 6303D Eng. 73  
Power Unit JD303D, 6303D Engs. Loader Tractor 6303D Eng. Skidder 6303D Eng. (cont.)  
5.0L 303 OHV Diesel L6, 3.8594" Bore**

<b>COOLING SYSTEM (cont.)</b>				
<b>QTY</b>	<b>WATER PUMP (cont.)</b>	<b>PART NO.</b>	<b>SIZE</b>	<b>DESCRIPTION</b>
1	Water Pump Housing Gasket	FP-T25485		w/Pump housing marked R48994
1	Water Intake Gasket	FP-T23132		
1	Water Pump Mounting Gasket	FP-T20243		w/Pump housing marked AR80112, RE19939
1	Shaft & Bearing Assembly	FP-JD9398		w/Pump housing marked R48994
<b>QTY</b>	<b>THERMOSTAT</b>	<b>PART NO.</b>	<b>SIZE</b>	<b>DESCRIPTION</b>
1	Thermostat Cover Gasket	FP-T24932		Water manifold marked R61178
<b>QTY</b>	<b>MISCELLANEOUS</b>	<b>PART NO.</b>	<b>SIZE</b>	<b>DESCRIPTION</b>
1	Water Manifold Gasket	FP-T23002		
<b>ENGINE BLOCK &amp; PARTS</b>				
<b>QTY</b>	<b>GASKETS</b>	<b>PART NO.</b>	<b>SIZE</b>	<b>DESCRIPTION</b>
1	Flywheel Housing Gasket	FP-R97351		
1	Oil Pan Gasket	FP-R97344		
1	Block to End Plate Front Gskt	FP-R131794		
<b>QTY</b>	<b>GASKET SETS</b>	<b>PART NO.</b>	<b>SIZE</b>	<b>DESCRIPTION</b>
1	In-Frame Gasket Set	FP-PG303S		
1	Complete Overhaul Gasket Set	FP-RE38568		Crankshaft seals not incl.
1	Complete Overhaul Gasket Set	FP-RE38568WS		Incl. crankshaft seals
<b>CRANKSHAFT/OIL PUMP</b>				
<b>QTY</b>	<b>CRANKSHAFT</b>	<b>PART NO.</b>	<b>SIZE</b>	<b>DESCRIPTION</b>
1	Crankshaft	FP-AT22562		
1	Oil Seal Kit	FP-SK67942		Incl. front & rear seals
<b>QTY</b>	<b>SEALS - FRONT CRANK</b>	<b>PART NO.</b>	<b>SIZE</b>	<b>DESCRIPTION</b>
1	Crankshaft Front Seal	FP-AR67942		
<b>QTY</b>	<b>SEALS - REAR CRANK</b>	<b>PART NO.</b>	<b>SIZE</b>	<b>DESCRIPTION</b>
1	Crankshaft Rear Seal	FP-RE24959		
<b>QTY</b>	<b>MAIN BEARINGS</b>	<b>PART NO.</b>	<b>SIZE</b>	<b>DESCRIPTION</b>
1	Main Set	FP-MBK3006	STD	w/Flanged thrust brg.
1	Main Set	FP-MBK300610	10	w/Flanged thrust brg.
1	Main Set	FP-MBK300620	20	w/Flanged thrust brg.
1	Main Set	FP-MBK300630	30	w/Flanged thrust brg.
6	Plain Main Brg.	FP-RE27352	STD	
6	Plain Main Brg.	FP-RE27353	10	
6	Plain Main Brg.	FP-RE27360	20	
6	Plain Main Brg.	FP-RE27368	30	
1	Flanged Main Brg.	FP-RE521350	STD	
1	Flanged Main Brg.	FP-RE526754	10	
1	Flanged Main Brg.	FP-RE527235	20	
1	Flanged Main Brg.	FP-RE527236	30	
4	Thrust Washer	FP-R78598	STD	
<b>QTY</b>	<b>OIL PUMP</b>	<b>PART NO.</b>	<b>SIZE</b>	<b>DESCRIPTION</b>
1	Pump Repair Kit	FP-RE55343		w/Pump housing marked R54615
1	O-Ring	FP-R74354		w/Pump housing marked R54615
1	O-Ring	FP-A4730R		From Ser. No. 243,648; Oil pump pickup to pump cover seal
<b>CYLINDER COMPONENTS</b>				
<b>QTY</b>	<b>LINERS</b>	<b>PART NO.</b>	<b>SIZE</b>	<b>DESCRIPTION</b>
6	Liner w/o Sealing Ring	FP-T32340	STD	O-Rings in block
6	Liner w/o Sealing Ring	FP-R48635	STD	O-Rings on liner
6	Liner w/Sealing Rings	FP-T32340WS	STD	From Ser. No. 158,976
6	Liner w/Sealing Rings	FP-AR51902	STD	To Ser. No. 158,975
6	Cylinder Kit Complete	FP-AR71591		w/Con. Rod marked T20007, R81410; From Ser. No. 158,796; Contains FP-T32340-WS liner; O-rings in block
6	Cylinder Kit Complete	FP-CK34818635	STD	w/Con. Rod marked T20007, R81410; To Ser. No. 158,795; Contains FP-AR51902 liner; O-rings on liner
6	Cyl. Liner Sealing Ring Kit	FP-AR71617		
6	Sealing Ring, Liner	FP-R48767		Rectangle; Top
6	Sealing Ring, Liner	FP-R48637		Rectangle; Top & Bottom
6	Sealing Ring, Liner	FP-R48638		Round
6	Sealing Ring	FP-SLR2497		Round; Bottom; In block
<b>QTY</b>	<b>PISTONS</b>	<b>PART NO.</b>	<b>SIZE</b>	<b>DESCRIPTION</b>
6	Piston Body w/o Pin	FP-T23481		
6	Piston Kit w/Pin & Retainers	FP-T23481WP		
6	Pin	FP-T23482		

(continued on next page)

**73** Combine 6303D Eng. Cotton Picker 6303D Eng. Grader 6303D Eng. Loader 6303D Eng.  
 (cont.) Power Unit JD303D, 6303D Engs. Loader Tractor 6303D Eng. Skidder 6303D Eng.  
 5.0L 303 OHV Diesel L6, 3.8594" Bore

### CYLINDER COMPONENTS (cont.)

QTY	PISTONS (cont.)	PART NO.	SIZE	DESCRIPTION
12	Piston Pin Retainer	FP-R51112		
6	Pin Bushing	FP-T23471		w/Con. Rod marked R81410, T20007; 1.1896" ID, 1.313" OD, 1.570" O.A.L.
6	Pin Bushing	FP-R55647		1.3765" ID, 1.500" OD, 1.570" O.A.L.
QTY	CONNECTING RODS & BRGS.	PART NO.	SIZE	DESCRIPTION
12	Con. Rod Bolt	FP-R80033		w/Con. Rod marked R80032, R80034, R81410, R105011, R113612; Torque-To-Yield bolt; Replacement recommended
12	Con. Rod Bolt	FP-R74194		w/Con. Rod marked T20007, R51727, R58979; Torque-To-Yield bolt; Replacement recommended
6	Rod Pair	FP-RE27348	STD	
6	Rod Pair	FP-RE27349	10	
6	Rod Pair	FP-RE27358	20	
6	Rod Pair	FP-RE27364	30	
QTY	PISTON RINGS	PART NO.	SIZE	DESCRIPTION
6	Ring Set Single Cylinder	FP-AR70633	STD	2-3/32, 1-.196 (1 cyl. set)
KITS				
QTY	OVERHAUL KIT	PART NO.	SIZE	DESCRIPTION
1	In-Frame Overhaul Kit	FP-303LIFK		w/Block marked R53260, R55035, R72970, R55351, R79280, T32346; w/Con. Rod marked T20007; From Ser. No. 158,796; O-rings in block; Incl. Torque-To-Yield con. rod bolts
1	In-Frame Overhaul Kit	FP-303EORLIFK		w/Block marked T24967, T24968; w/Con. Rod marked T20007; To Ser. No. 158,795; O-rings on liner; Incl. Torque-To-Yield con. rod bolts
1	Complete Overhaul Kit	FP-303LOHK		w/Block marked R53260, R55035, R55351, R72970, T32346; w/Con. Rod marked T20007; From Ser. No. 158,796; O-rings in block; Incl. Torque-To-Yield con. rod bolts
1	Complete Overhaul Kit	FP-303EORLOHK		w/Block marked T24967, T24968; w/Con. Rod marked T20007; To Ser. No. 158,795; O-rings on liner; Incl. Torque-To-Yield con. rod bolts

**74** Combine 6303LP Eng. (LPG). Cotton Picker 6303LP Eng. (LPG). Power Unit 6303LP Eng. (LPG). Wheel Tractor 6303LP Eng. (LPG). Loader Tractor 6303LP Eng. (LPG).  
 5.0L 303 OHV LPG L6, 3.8594" Bore

### CYL. HEAD & PARTS

QTY	GASKETS	PART NO.	SIZE	DESCRIPTION
1	Valve Cover Gasket	FP-T20467		
1	Head Gasket	FP-R98462		
QTY	VALVE SEAL	PART NO.	SIZE	DESCRIPTION
6	Valve Stem Seal	FP-R87627		O-Ring type

### CAMSHAFT GROUP

QTY	CAMSHAFT/LIFTER	PART NO.	SIZE	DESCRIPTION
12	Lifter	FP-T20073		

### COOLING SYSTEM

QTY	WATER PUMP	PART NO.	SIZE	DESCRIPTION
1	Water Pump Impeller	FP-R40979		Models 55, 95H, 95LL, 699
1	Water Pump Housing Gasket	FP-T25485		w/Pump housing marked R48994
1	Water Intake Gasket	FP-T23132		
1	Water Pump Mounting Gasket	FP-T20243		w/Pump housing marked AR80112, RE19939
QTY	THERMOSTAT	PART NO.	SIZE	DESCRIPTION
1	Thermostat Cover Gasket	FP-T24932		Water manifold marked R61178

### ENGINE BLOCK & PARTS

QTY	GASKETS	PART NO.	SIZE	DESCRIPTION
1	Oil Pan Gasket	FP-R97344		
1	Block to End Plate Front Gskt	FP-R131794		

### CRANKSHAFT/OIL PUMP

QTY	CRANKSHAFT	PART NO.	SIZE	DESCRIPTION
1	Crankshaft	FP-AT22562		
1	Oil Seal Kit	FP-SK67942		Incl. front & rear seals

(continued on next page)





# John Deere Off Highway

**Combine 6303LP Eng. (LPG). Cotton Picker 6303LP Eng. (LPG). Power Unit 6303LP Eng. 74 (LPG). Wheel Tractor 6303LP Eng. (LPG). Loader Tractor 6303LP Eng. (LPG). (cont.)**  
5.0L 303 OHV LPG L6, 3.8594" Bore

## CRANKSHAFT/OIL PUMP (cont.)

QTY	SEALS - FRONT CRANK	PART NO.	SIZE	DESCRIPTION
1	Crankshaft Front Seal	FP-AR67942		
1	O-Ring	FP-H35244		Crankshaft pulley; w/Crankshaft marked R108679
QTY	SEALS - REAR CRANK	PART NO.	SIZE	DESCRIPTION
1	Crankshaft Rear Seal	FP-RE24959		Crank marked R108679
QTY	MAIN BEARINGS	PART NO.	SIZE	DESCRIPTION
6	Plain Main Brg.	FP-RE27352	STD	
6	Plain Main Brg.	FP-RE27353	10	
6	Plain Main Brg.	FP-RE27360	20	
6	Plain Main Brg.	FP-RE27368	30	
1	Flanged Main Brg.	FP-RE521350	STD	
1	Flanged Main Brg.	FP-RE526754	10	
1	Flanged Main Brg.	FP-RE527235	20	
1	Flanged Main Brg.	FP-RE527236	30	
4	Thrust Washer	FP-R78598	STD	Crank marked R108679
QTY	OIL PUMP	PART NO.	SIZE	DESCRIPTION
1	Pump Repair Kit	FP-RE55343		w/Pump housing marked R54615
1	O-Ring	FP-R74354		w/Pump housing marked R54615

## CYLINDER COMPONENTS

QTY	LINERS	PART NO.	SIZE	DESCRIPTION
6	Liner w/o Sealing Ring	FP-T32340	STD	From Ser. No. 157,229; O-Rings in block
6	Liner w/Sealing Rings	FP-AR51902	STD	To Ser. No. 157,228
6	Sealing Ring, Liner	FP-R48767		From Ser. No. 157,228 to Ser. No. 158,975; Rectangle; Top
6	Sealing Ring, Liner	FP-R48637		To Ser. No. 157,228; Rectangle; Top & Bottom
6	Sealing Ring, Liner	FP-R48638		To Ser. No. 158,975; Round
QTY	PISTONS	PART NO.	SIZE	DESCRIPTION
6	Pin Bushing	FP-T23471		1.1896" ID, 1.313" OD, 1.570" O.A.L.
QTY	CONNECTING RODS & BRGS.	PART NO.	SIZE	DESCRIPTION
6	Rod Pair	FP-RE27348	STD	
6	Rod Pair	FP-RE27349	10	
6	Rod Pair	FP-RE27358	20	
6	Rod Pair	FP-RE27364	30	

**Wheel Tractor A Eng. 75**  
5.0L 308 OHV L2, 5.5" Bore

## ENGINE BLOCK & PARTS

QTY	GASKET SETS	PART NO.	SIZE	DESCRIPTION
1	Complete Overhaul Gasket Set	FP-PG308FS		Models A, AH, AI, AN, ANH, AW, AWH; From Ser. No. 41000 to 487999
1	Complete Overhaul Gasket Set	FP-PG308XFS		Models A, AH, AI, AN, ANH, AW, AWH; From Ser. No. 584000
1	Complete Overhaul Gasket Set	FP-PG308FS		Models AO, AR; From Ser. No. 250000 to Ser. No. 259999
QTY	CAM BEARINGS	PART NO.	SIZE	DESCRIPTION
2	Cone Taper Brg.	FP-JD8135		Position 1-2; From Ser. No. 620,324
2	Cup Taper Brg.	FP-JD7438		Position 1-2; From Ser. No. 620,324

## CYLINDER COMPONENTS

QTY	PISTONS	PART NO.	SIZE	DESCRIPTION
2	Pin Bushing	FP-9759		w/1.750" ID, 1.895" OD, 2.500" O.A.L.
2	Pin Bushing	9759 +		w/1.750" ID, 1.895" OD, 2.500" O.A.L.; When depleted use FP-9759
QTY	CONNECTING RODS & BRGS.	PART NO.	SIZE	DESCRIPTION
2	Rod Pair	FP-1910CP	STD	Insert type brgs.; From Ser. No. 488,000
2	Rod Pair	FP-1910CP10	10	Insert type brgs.; From Ser. No. 488,000
2	Rod Pair	FP-1910CP20	20	Insert type brgs.; From Ser. No. 488,000
QTY	PISTON RINGS	PART NO.	SIZE	DESCRIPTION
1	Standard Set	FP-5097C	STD	4-3/16, 1-5/16

<b>76 Wheel Tractor A, 60 Engs.</b> 5.3L 321 OHV L2, 5.5" Bore				
<b>ENGINE BLOCK &amp; PARTS</b>				
<b>QTY</b>	<b>GASKET SETS</b>	<b>PART NO.</b>	<b>SIZE</b>	<b>DESCRIPTION</b>
1	Complete Overhaul Gasket Set	FP-PG308FS		Models A, AH, AI, AN, ANH, AW, AWH; From Ser. No. 41000 to Ser. No. 487999
1	Complete Overhaul Gasket Set	FP-PG308XFS		Models A, AH, AI, AN, ANH, AW, AWH; From Ser. No. 584000
1	Complete Overhaul Gasket Set	FP-PG308FS		Models AO, AR; From Ser. No. 250000 to Ser. No. 259999
<b>QTY</b>	<b>CAM BEARINGS</b>	<b>PART NO.</b>	<b>SIZE</b>	<b>DESCRIPTION</b>
2	Cone Taper Brg.	FP-JD8135		Position 1-2; From Ser. No. 620,324
2	Cup Taper Brg.	FP-JD7438		Position 1-2; From Ser. No. 620,324
<b>CYLINDER COMPONENTS</b>				
<b>QTY</b>	<b>PISTONS</b>	<b>PART NO.</b>	<b>SIZE</b>	<b>DESCRIPTION</b>
2	Pin Bushing	FP-9759		w/1.750" ID, 1.895" OD, 2.500" O.A.L.
2	Pin Bushing	9759 +		w/1.750" ID, 1.895" OD, 2.500" O.A.L.; When depleted use FP-9759
<b>QTY</b>	<b>CONNECTING RODS &amp; BRGS.</b>	<b>PART NO.</b>	<b>SIZE</b>	<b>DESCRIPTION</b>
2	Rod Pair	FP-1910CP	STD	Insert type brgs.; From Ser. No. 488,000
2	Rod Pair	FP-1910CP10	10	Insert type brgs.; From Ser. No. 488,000
2	Rod Pair	FP-1910CP20	20	Insert type brgs.; From Ser. No. 488,000
<b>QTY</b>	<b>PISTON RINGS</b>	<b>PART NO.</b>	<b>SIZE</b>	<b>DESCRIPTION</b>
1	Standard Set	FP-5097C	STD	4-3/16, 1-5/16
<b>77 Combine 6329G Eng. Cotton Picker 6329G Eng. Power Unit JD329G, 6329G Engs.</b> 5.4L 329 OHV L6, 4.0156" Bore				
<b>CYL. HEAD &amp; PARTS</b>				
<b>QTY</b>	<b>GASKETS</b>	<b>PART NO.</b>	<b>SIZE</b>	<b>DESCRIPTION</b>
1	Valve Cover Gasket	FP-R75728		Combine Model 6600; From Ser. No. 4,193 to Ser. No. 157,490
<b>QTY</b>	<b>VALVE</b>	<b>PART NO.</b>	<b>SIZE</b>	<b>DESCRIPTION</b>
24	Keeper	FP-41339		1 groove; Square cut key groove
24	Keeper	FP-T20077		1 groove; Square cut key groove; Hardened
24	Keeper, Bulk	VK-138B		1 groove; Square cut key groove; Carton of 1000
<b>QTY</b>	<b>VALVE SPRING</b>	<b>PART NO.</b>	<b>SIZE</b>	<b>DESCRIPTION</b>
12	Spring	FP-R26125		2.1200" Free Height
<b>QTY</b>	<b>VALVE MISC.</b>	<b>PART NO.</b>	<b>SIZE</b>	<b>DESCRIPTION</b>
1	Oil Filler Cap Gasket	FP-T20328		
<b>QTY</b>	<b>ROCKER PARTS</b>	<b>PART NO.</b>	<b>SIZE</b>	<b>DESCRIPTION</b>
1	O-Ring	FP-R56463		Rocker cover breather tube
<b>ELECTRICAL</b>				
<b>QTY</b>	<b>ALTERNATOR</b>	<b>PART NO.</b>	<b>SIZE</b>	<b>DESCRIPTION</b>
1	Ball Brg.	FP-JD9449		Front; Motorola Nos. TA12NJD400, 8TA2009ES; 30 amp alternator
2	Ball Brg.	FP-JD9449		Front & Rear; Motorola Nos. 8MA2X01, 8MR2001
2	Ball Brg.	FP-JD9449		Front & Rear; 55 amp alternator; 65 amp alternator; 72 amp alternator
<b>CAMSHAFT GROUP</b>				
<b>QTY</b>	<b>CAMSHAFT/LIFTER</b>	<b>PART NO.</b>	<b>SIZE</b>	<b>DESCRIPTION</b>
12	Lifter	FP-T20073		
<b>COOLING SYSTEM</b>				
<b>QTY</b>	<b>WATER PUMP</b>	<b>PART NO.</b>	<b>SIZE</b>	<b>DESCRIPTION</b>
1	Water Pump Impeller	FP-R94419		w/Pump housing marked R48992
1	Water Pump Impeller	FP-R40979		w/Pump housing marked R48994, R56787
1	Water Pump Repair/Rebuild Kit	FP-939840979		w/Pump housing marked R29701, R48994
1	Water Pump Housing Gasket	FP-T25485		w/Pump housing marked R48994, R56787
1	Water Intake Gasket	FP-T23132		
1	Water Pump Mounting Gasket	FP-T20243		w/Pump housing marked R48992, R48994, R56787
1	Shaft & Bearing Assembly	FP-JD9398		w/Pump housing marked R48994
<b>QTY</b>	<b>THERMOSTAT</b>	<b>PART NO.</b>	<b>SIZE</b>	<b>DESCRIPTION</b>
1	Thermostat Cover Gasket	FP-T24932		Water manifold marked T24931, R61178
<b>QTY</b>	<b>MISCELLANEOUS</b>	<b>PART NO.</b>	<b>SIZE</b>	<b>DESCRIPTION</b>
1	Water Manifold Gasket	FP-T23002		

(continued on next page)



# John Deere Off Highway

**Combine 6329G Eng. Cotton Picker 6329G Eng. Power Unit JD329G, 6329G Engs. 77**  
5.4L 329 OHV L6, 4.0156" Bore (cont.)

ENGINE BLOCK & PARTS				
QTY	GASKETS	PART NO.	SIZE	DESCRIPTION
1	Block to End Plate Front Gskt	FP-R131794		Combine Model 6600; Cotton Picker Models 499 & 699
QTY	OIL COOLERS & FILTERS	PART NO.	SIZE	DESCRIPTION
1	Washer	FP-R105714		Oil cooler; From Ser. No. 4,193 to Ser. No. 7,500
1	Rect. or Square Seal	FP-R70956		Cooler housing; From Ser. No. 248,001; 2.700" X 3.000" X .180"
CRANKSHAFT/OIL PUMP				
QTY	CRANKSHAFT	PART NO.	SIZE	DESCRIPTION
1	Oil Seal Kit	FP-SK67942		Incl. front & rear seals
QTY	SEALS - FRONT CRANK	PART NO.	SIZE	DESCRIPTION
1	Crankshaft Front Seal	FP-AR67942		
QTY	SEALS - REAR CRANK	PART NO.	SIZE	DESCRIPTION
1	Crankshaft Rear Seal	FP-RE24959		
QTY	MAIN BEARINGS	PART NO.	SIZE	DESCRIPTION
1	Main Set	FP-MBK3003	STD	w/Flanged thrust brg.
1	Main Set	FP-MBK300310	10	w/Flanged thrust brg.
1	Main Set	FP-MBK300320	20	w/Flanged thrust brg.
1	Main Set	FP-MBK300330	30	w/Flanged thrust brg.
QTY	OIL PUMP	PART NO.	SIZE	DESCRIPTION
1	O-Ring	FP-R61871		Oil pump inlet; w/Pump housing marked R54615; From Ser. No. 243,645
1	O-Ring	FP-R74354		Oil pump outlet tube; w/Pump housing marked R54615, T20078
CYLINDER COMPONENTS				
QTY	LINERS	PART NO.	SIZE	DESCRIPTION
6	Liner w/Sealing Rings	FP-T32343WS	STD	Top sleeve seal; Model 6600 From Ser. No. 4,193 to Ser. No. 157,490; Rectangle
6	Sealing Ring	FP-SLR2515		
QTY	PISTONS	PART NO.	SIZE	DESCRIPTION
6	Pin Bushing	FP-T23471		1.1896" ID, 1.313" OD, 1.570" O.A.L.
6	Pin Bushing	FP-R55647		1.3765" ID, 1.500" OD, 1.570" O.A.L.
QTY	CONNECTING RODS & BRGS.	PART NO.	SIZE	DESCRIPTION
6	Rod Pair	FP-RE27348	STD	
6	Rod Pair	FP-RE27349	10	
6	Rod Pair	FP-RE27358	20	
6	Rod Pair	FP-RE27364	30	

**Combine 6329D Eng. Cotton Picker 6329D Eng. Grader 6329D Eng. Loader 6329D Eng. 78**  
**Power Unit JD329D, 6329D Engs. Wheel Tractor 6329D Eng. Skidder 6329D Eng.**  
5.4L 329 OHV Diesel L6, 4.0156" Bore

CYL. HEAD & PARTS				
QTY	GASKETS	PART NO.	SIZE	DESCRIPTION
1	Valve Cover Gasket	FP-R75728		Combine Model 6600; From Ser. No. 4,193 to Ser. No. 157,490 To Ser. No. 608,510 From Ser. No. 608,511 From Ser. No. 608,511
1	Valve Cover Gasket	FP-T20467		
1	Head Gasket	FP-R114157		
1	Head Set	FP-RE38852		
QTY	VALVE	PART NO.	SIZE	DESCRIPTION
6	Intake	FP-R98062	STD	1 groove; Chrome plated stem; 1.8350" Head Dia., .3100" Stem Dia., 5.2780" O.A.L.
6	Intake	FP-R79623	STD	2 groove; Chrome plated stem; 1.7720" Head Dia., .3720" Stem Dia., 5.1560" O.A.L.
6	Intake	FP-R79628	3	2 groove; Chrome plated stem; 1.7720" Head Dia., .3750" Stem Dia., 5.1560" O.A.L.
6	Intake	FP-R79629	15	2 groove; Chrome plated stem; 1.7720" Head Dia., .3870" Stem Dia., 5.1560" O.A.L.
6	Intake	FP-R79630	30	2 groove; Chrome plated stem; 1.7720" Head Dia., .4020" Stem Dia., 5.1560" O.A.L.
6	Exhaust	FP-R79624	STD	1 groove; Chrome plated stem; 1.5750" Head Dia., .3720" Stem Dia., 5.1560" O.A.L.
6	Exhaust	FP-R79625	3	1 groove; Chrome plated stem; 1.5750" Head Dia., .3750" Stem Dia., 5.1560" O.A.L.
6	Exhaust	FP-R79626	15	1 groove; Chrome plated stem; 1.5750" Head Dia., .3870" Stem Dia., 5.1560" O.A.L.
6	Exhaust	FP-R79627	30	1 groove; Chrome plated stem; 1.5750" Head Dia., .4020" Stem Dia., 5.1560" O.A.L.

(continued on next page)

**78** Combine 6329D Eng. Cotton Picker 6329D Eng. Grader 6329D Eng. Loader 6329D Eng.  
 (cont.) Power Unit JD329D, 6329D Engs. Wheel Tractor 6329D Eng. Skidder 6329D Eng.  
 5.4L 329 OHV Diesel L6, 4.0156" Bore

### CYL. HEAD & PARTS (cont.)

QTY	VALVE (cont.)	PART NO.	SIZE	DESCRIPTION
6	Exhaust	FP-R90692	STD	1 groove; Chrome plated stem; 1.6730" Head Dia., .3095" Stem Dia., 5.2550" O.A.L.
24	Keeper	FP-41339		1 groove; Square cut key groove
24	Keeper	FP-T20077		1 groove; Square cut key groove; Hardened
24	Keeper, Bulk	VK-138B		1 groove; Square cut key groove; Carton of 1000
QTY	VALVE SEAT	PART NO.	SIZE	DESCRIPTION
6	Exh.	FP-R51734	STD	
6	Int.	FP-R73064	STD	
QTY	VALVE SPRING	PART NO.	SIZE	DESCRIPTION
12	Spring	FP-R26125		2.1200" Free Height
QTY	VALVE MISC.	PART NO.	SIZE	DESCRIPTION
12	Rotocap	FP-RE11410		Exh. & Int.
1	Bushing	FP-T26321		Lower
1	Bushing	FP-T20034		Upper
1	Oil Filler Cap Gasket	FP-T20328		Rocker arm cover code 1103; Oil filler neck codes 1201, 1202, 1203
QTY	VALVE SEAL	PART NO.	SIZE	DESCRIPTION
6	Valve Stem Seal	FP-R87627		Exh.; From Ser. No. 724,327; O-Ring type
QTY	ROCKER PARTS	PART NO.	SIZE	DESCRIPTION
1	O-Ring	FP-R56463		Rocker cover breather tube; Breather tube code 2901 R.H.; Codes 2902, 2903 L.H.

### ELECTRICAL

QTY	ELECTRICAL	PART NO.	SIZE	DESCRIPTION
1	Starter to Block Gasket	FP-R53108		3-Hole mount; Starting motor codes 3001, 3003
QTY	ALTERNATOR	PART NO.	SIZE	DESCRIPTION
1	Ball Brg.	FP-JD9449		Front; w/24 Volt alternator conversion
1	Ball Brg.	FP-JD9449		Front; Delco-Remy Nos. 1100490, 1102932, 1105174; Code 3103; 72 amp alternator
1	Ball Brg.	FP-JD9449		Front; Motorola No. A12NJD604; Code 3102; 55 amp alternator
1	Ball Brg.	FP-JD9449		Front; Motorola Nos. TA12NJD400, 8TA2009ES; 30 amp alternator
2	Ball Brg.	FP-JD9449		Front & Rear; Motorola No. 70D42179T02; 24 Volt alternator
2	Ball Brg.	FP-JD9449		Front & Rear; Motorola Nos. 8MA2X01, 8MR2001; 55 amp alternator; 65 amp alternator; 72 amp alternator

### INT & EXH MANIFOLDS

QTY	INT. & EXH. MANIFOLDS	PART NO.	SIZE	DESCRIPTION
6	Exhaust Manifold Gasket	FP-R90658		
2	Air Intake Gasket	FP-R81275		

### CAMSHAFT GROUP

QTY	TIMING COVER	PART NO.	SIZE	DESCRIPTION
1	Timing Gear Cover Gasket	FP-T20273		Access cover
1	Timing Gear Cover Gasket	FP-R97454		Front cover
QTY	CAMSHAFT/LIFTER	PART NO.	SIZE	DESCRIPTION
12	Lifter	FP-T20073		

### FUEL SYSTEM & PARTS

QTY	FUEL INJECTION	PART NO.	SIZE	DESCRIPTION
1	Injector Pump Gasket	FP-R125066		Gear cover
6	Fuel Injector Nozzle	FP-AR89564		
6	Fuel Injector Seal	FP-R79605		Fuel line connection; Nozzle codes 1602, 1603; 9.270MM X 13.600MM X 5.080MM
12	Washer	FP-T20055		Pump codes 1602, 1603
6	Fuel Injector Nut	FP-R79604		w/Injector marked 22202
12	Washer Type Seal	FP-R51936		Leak-off & return line seals; Nozzle codes 1602, 1603
6	Washer Type Seal	FP-R48000		Lower; w/Nozzle codes 1602, 1603
6	Washer Type Seal	FP-R48000		Lower; w/Nozzle marked 18742, 19762, 20500, 20631, 22042, 22202
6	Washer Type Seal	FP-R60746		Upper; Nozzle codes 1602, 1603; w/Nozzle marked 20631, 22042, 22202; From Ser. No. 608,908
QTY	FUEL FILTERS & PUMP	PART NO.	SIZE	DESCRIPTION
1	Mechanical Fuel Pump	FP-RE42211		Transfer pump
1	Fuel Transfer Pump Gasket	FP-R97350		

(continued on next page)



# John Deere Off Highway

**Combine 6329D Eng. Cotton Picker 6329D Eng. Grader 6329D Eng. Loader 6329D Eng. 78  
Power Unit JD329D, 6329D Engs. Wheel Tractor 6329D Eng. Skidder 6329D Eng. (cont.)  
5.4L 329 OHV Diesel L6, 4.0156" Bore**

<b>COOLING SYSTEM</b>				
<b>QTY</b>	<b>WATER PUMP</b>	<b>PART NO.</b>	<b>SIZE</b>	<b>DESCRIPTION</b>
1	Water Pump Impeller	FP-R94419		w/Pump housing marked R48992
1	Water Pump Impeller	FP-R47191		w/Pump housing marked R66420, R68733
1	Water Pump Impeller	FP-R40979		Pump code 2004; w/Pump housing marked R48994, R56787
1	Water Pump Repair/Rebuild Kit	FP-939840979		w/Pump housing marked R29701, R48994
1	Water Pump Repair/Rebuild Kit	FP-RE62661		w/Pump housing marked R66420, R68733
1	Water Pump Housing Gasket	FP-T25485		w/Pump housing marked R48994, R56787
1	Oil Seal Kit	FP-AR101549		Water Pump; w/Pump housing marked R48994
1	Water Intake Gasket	FP-T23132		
1	Water Pump Mounting Gasket	FP-T20243		w/Pump housing marked R48992, R48994, R56787
1	Shaft & Bearing Assembly	FP-JD9398		w/Pump housing marked R48994
<b>QTY</b>	<b>THERMOSTAT</b>	<b>PART NO.</b>	<b>SIZE</b>	<b>DESCRIPTION</b>
1	Thermostat	FP-AR70601		Thermostat code 2204; Thermostat cover code 2102; Housing marked T24931; To Ser. No. 366,210; 180 Deg.
1	Thermostat	FP-AR77411		Thermostat code 2204; Thermostat cover code 2102; Housing marked T24931; To Ser. No. 366,210; 195 Deg.
1	Thermostat Gasket	FP-T20219		
1	Thermostat Cover Gasket	FP-T20215		Cover to housing
1	Thermostat Cover Gasket	FP-T24932		Water manifold marked T24931, R61178
1	Therm. Hsg. - Water Mfld. Gsk	FP-R54641		Thermostat housing to cyl. head; From Ser. No. 277,648
<b>QTY</b>	<b>MISCELLANEOUS</b>	<b>PART NO.</b>	<b>SIZE</b>	<b>DESCRIPTION</b>
3	Water Manifold Gasket	FP-T23002		
<b>ENGINE BLOCK &amp; PARTS</b>				
<b>QTY</b>	<b>GASKETS</b>	<b>PART NO.</b>	<b>SIZE</b>	<b>DESCRIPTION</b>
1	Flywheel Housing Gasket	FP-R97351		
1	Oil Pan Gasket	FP-R97344		
1	Oil Pan Gasket	FP-R97345		From Ser. No. 100,001; Manufactured after 1983
1	Oil Pan Gasket	FP-R97345		From Ser. No. 290,000 to Ser. No. 621,172; Manufactured 1974-83
1	Oil Pan Gasket Set	FP-PG302PS		From Ser. No. 100,001; Manufactured after 1983
1	Oil Pan Gasket Set	FP-PG302PS		From Ser. No. 248,001 to Ser. No. 621,172; Manufactured 1974-83
1	Block to End Plate Front Gskt	FP-R131794		
<b>QTY</b>	<b>GASKET SETS</b>	<b>PART NO.</b>	<b>SIZE</b>	<b>DESCRIPTION</b>
1	In-Frame Gasket Set	FP-PG329S		
1	Complete Overhaul Gasket Set	FP-RE38859		Crankshaft seals not incl.
1	Complete Overhaul Gasket Set	FP-RE38859WS		Incl. crankshaft seals
<b>QTY</b>	<b>OIL COOLERS &amp; FILTERS</b>	<b>PART NO.</b>	<b>SIZE</b>	<b>DESCRIPTION</b>
1	Washer	FP-R105714		From Ser. No. 3,701 to Ser. No. 157,490
1	Washer	FP-R105714		From Ser. No. 6,501 to Ser. No. 152,270
1	Rect. or Square Seal	FP-R70956		Cooler housing; Oil cooler codes 5901, 5902; From Ser. No. 248,001; 2.700" X 3.000" X .180"
<b>CRANKSHAFT/OIL PUMP</b>				
<b>QTY</b>	<b>CRANKSHAFT</b>	<b>PART NO.</b>	<b>SIZE</b>	<b>DESCRIPTION</b>
1	Crankshaft	FP-AT22562		
1	Oil Seal Kit	FP-SK67942		Incl. front & rear seals; Crankshaft marked R108579, R108679, T23264, T23266, T23267
<b>QTY</b>	<b>SEALS - FRONT CRANK</b>	<b>PART NO.</b>	<b>SIZE</b>	<b>DESCRIPTION</b>
1	Crankshaft Front Seal	FP-AR67942		
1	O-Ring	FP-H35244		Crankshaft pulley; Pulley codes 1302, 1308, 4101; Crankshaft marked R108679, RE60489, T23266
<b>QTY</b>	<b>SEALS - REAR CRANK</b>	<b>PART NO.</b>	<b>SIZE</b>	<b>DESCRIPTION</b>
1	Crankshaft Rear Seal	FP-RE24959		Crankshaft codes 1302, 1308
<b>QTY</b>	<b>MAIN BEARINGS</b>	<b>PART NO.</b>	<b>SIZE</b>	<b>DESCRIPTION</b>
1	Main Set	FP-MBK3006	STD	w/Flanged thrust brg.
1	Main Set	FP-MBK300610	10	w/Flanged thrust brg.
1	Main Set	FP-MBK300620	20	w/Flanged thrust brg.
1	Main Set	FP-MBK300630	30	w/Flanged thrust brg.
6	Plain Main Brg.	FP-RE27352	STD	
6	Plain Main Brg.	FP-RE27353	10	
6	Plain Main Brg.	FP-RE27360	20	
6	Plain Main Brg.	FP-RE27368	30	
1	Flanged Main Brg.	FP-RE521350	STD	
1	Flanged Main Brg.	FP-RE526754	10	
1	Flanged Main Brg.	FP-RE527235	20	

(continued on next page)

**78** Combine 6329D Eng. Cotton Picker 6329D Eng. Grader 6329D Eng. Loader 6329D Eng.  
 (cont.) Power Unit JD329D, 6329D Engs. Wheel Tractor 6329D Eng. Skidder 6329D Eng.  
 5.4L 329 OHV Diesel L6, 4.0156" Bore

CRANKSHAFT/OIL PUMP (cont.)				
<b>QTY</b>	<b>MAIN BEARINGS</b> (cont.)	<b>PART NO.</b>	<b>SIZE</b>	<b>DESCRIPTION</b>
1	Flanged Main Brg.	FP-RE527236	30	
4	Thrust Washer	FP-R78598	STD	
<b>QTY</b>	<b>OIL PUMP</b>	<b>PART NO.</b>	<b>SIZE</b>	<b>DESCRIPTION</b>
1	Pump Repair Kit	FP-RE55343		w/Pump housing marked R54615
1	O-Ring	FP-R61871		Oil pump inlet; From Ser. No. 243,645; w/Pump housing marked R54615
1	O-Ring	FP-R74354		Oil pump outlet tube; w/Pump housing marked R54615, T20078
1	Oil Filler Inlet Gasket	FP-R97352		Oil filler neck codes 1201, 1202, 1203
CYLINDER COMPONENTS				
<b>QTY</b>	<b>LINERS</b>	<b>PART NO.</b>	<b>SIZE</b>	<b>DESCRIPTION</b>
6	Liner w/o Sealing Ring	FP-R116463	STD	w/o Piston spray cooling; O-rings in block; From Ser. No. 100,001
6	Liner w/o Sealing Ring	FP-R116463	STD	w/o Piston spray cooling; O-rings in block; From Ser. No. 290,000 to Ser. No. 621,172
6	Liner w/o Sealing Ring	FP-T32343	STD	From Ser. No. 277,550
6	Liner w/Sealing Rings	FP-T32343WS	STD	From Ser. No. 277,550
6	Liner w/Sealing Rings	FP-AR51903	STD	To Ser. No. 277,549; Incl. 2-FPR4863R (Rect., upper step & lower groove on sleeve) & 1-FPT32341 (Top groove on sleeve) sealing rings.
6	Cylinder Kit Complete	FP-AR78041	STD	w/Con. Rod marked R51727; From Ser. No. 277,550; O-Rings in block; Pin dia. 1.38"
6	Cylinder Kit Complete	FP-AR71593	STD	w/Con. Rod marked T20007, R81410; To Ser. No. 277,549; O-rings in block; Pin dia. 1.19"
6	Cylinder Kit Complete	FP-CK83108636	STD	w/Con. Rod marked T20007, R81410; To Ser. No. 277,549; O-rings on liner
6	Cyl. Liner Sealing Ring Kit	FP-AR71618		
6	Sealing Ring, Liner	FP-R48637		Rectangle; Top & Bottom
6	Sealing Ring, Liner	FP-T32341		Round
6	Sealing Ring	FP-SLR2515		Rectangle
6	Sealing Ring	FP-SLR2388		Round
<b>QTY</b>	<b>PISTONS</b>	<b>PART NO.</b>	<b>SIZE</b>	<b>DESCRIPTION</b>
6	Piston Body w/o Pin	FP-AR77762	STD	From Ser. No. 277,550
6	Piston Body w/o Pin	FP-AR78310	STD	To Ser. No. 277,549
6	Piston Kit w/Pin & Retainers	FP-AR77762WP	STD	From Ser. No. 277,550
6	Piston Kit w/Pin & Retainers	FP-AR78310WP	STD	To Ser. No. 277,549
6	Pin	FP-R125754		From Ser. No. 277,550; 1.38" pin dia.
6	Pin	FP-T26149		To Ser. No. 277,549
12	Piston Pin Retainer	FP-M41029		From Ser. No. 277,550; For 1.38" pin dia.
12	Piston Pin Retainer	FP-R51112		To Ser. No. 277,549
6	Pin Bushing	FP-R55647		w/Con. Rod marked R51727, R80034; 1.3765" ID, 1.500" OD, 1.570" O.A.L.
6	Pin Bushing	FP-T23471		w/Con. Rod marked R81410, T20007; 1.1896" ID, 1.313" OD, 1.570" O.A.L.
<b>QTY</b>	<b>CONNECTING RODS &amp; BRGS.</b>	<b>PART NO.</b>	<b>SIZE</b>	<b>DESCRIPTION</b>
12	Con. Rod Bolt	FP-R80033		w/Con. Rod marked R80032, R80034, R81410, R105011, R113612; Torque-To-Yield bolt; Replacement recommended
12	Con. Rod Bolt	FP-R74194		w/Con. Rod marked T20007, R51727, R58979; Torque-To-Yield bolt; Replacement recommended
6	Rod Pair	FP-RE27348	STD	
6	Rod Pair	FP-RE27349	10	
6	Rod Pair	FP-RE27358	20	
6	Rod Pair	FP-RE27364	30	
<b>QTY</b>	<b>PISTON RINGS</b>	<b>PART NO.</b>	<b>SIZE</b>	<b>DESCRIPTION</b>
6	Ring Set Single Cylinder	FP-AR55759	STD	1-1/8, 1-3/32, 1-.1965 (1 cyl. set)
KITS				
<b>QTY</b>	<b>OVERHAUL KIT</b>	<b>PART NO.</b>	<b>SIZE</b>	<b>DESCRIPTION</b>
1	In-Frame Overhaul Kit	FP-329LIFK		w/Con. Rod marked R51727; Pin dia. 1.38"; From Ser. No. 277,550; Incl. Torque-To-Yield con. rod bolts
1	In-Frame Overhaul Kit	FP-329EORLIFK		w/Con. Rod marked T20007; O-rings on liner; To Ser. No. 277,549; Incl. Torque-To-Yield con. rod bolts
1	In-Frame Overhaul Kit	FP-329MIFK		w/Con. Rod marked T20007; Pin dia. 1.19"; To Ser. No. 277,549; O-rings in block; Incl. Torque-To-Yield con. rod bolts

(continued on next page)



# John Deere Off Highway

**Combine 6329D Eng. Cotton Picker 6329D Eng. Grader 6329D Eng. Loader 6329D Eng. 78**  
**Power Unit JD329D, 6329D Engs. Wheel Tractor 6329D Eng. Skidder 6329D Eng. (cont.)**  
 5.4L 329 OHV Diesel L6, 4.0156" Bore

### KITS (cont.)

QTY	OVERHAUL KIT (cont.)	PART NO.	SIZE	DESCRIPTION
1	Complete Overhaul Kit	FP-329LOHK		w/Con. Rod marked R51727; Pin dia. 1.38"; From Ser. No. 277,550; Incl. front & rear seals; Crankshaft marked R108579, R108679, T23264, T23266, T23267; Incl. Torque-To-Yield con. rod bolts
1	Complete Overhaul Kit	FP-329EORLOHK		w/Con. Rod marked T20007; O-rings on liner; To Ser. No. 277,549; Incl. front & rear seals; Crankshaft marked R108579, R108679, T23264, T23266, T23267; Incl. Torque-To-Yield con. rod bolts
1	Complete Overhaul Kit	FP-329MOHK		w/Con. Rod marked T20007; Pin dia. 1.19"; To Ser. No. 277,549; O-rings in block; Incl. front & rear seals; Crankshaft marked R108579, R108679, T23264, T23266, T23267; Incl. Torque-To-Yield con. rod bolts

**Combine 6329LP Eng. (LPG). Cotton Picker 6329LP Eng. (LPG). Power Unit 6329LP Eng. 79**  
**(LPG).**  
 5.4L 329 OHV LPG L6, 4.0156" Bore

### CYL. HEAD & PARTS

QTY	GASKETS	PART NO.	SIZE	DESCRIPTION
1	Valve Cover Gasket	FP-R75728		Combine Model 6600; From Ser. No. 4,193 to Ser. No. 157,490
1	Head Set	FP-RE38852		
QTY	VALVE MISC.	PART NO.	SIZE	DESCRIPTION
1	Oil Filler Cap Gasket	FP-T20328		

### ELECTRICAL

QTY	ALTERNATOR	PART NO.	SIZE	DESCRIPTION
1	Ball Brg.	FP-JD9449		Front; Motorola Nos. TA12NJD400, 8TA2009ES; 30 amp alternator
2	Ball Brg.	FP-JD9449		Front & Rear; Motorola Nos. 8MA2X01, 8MR2001
2	Ball Brg.	FP-JD9449		Front & Rear; 55 amp alternator; 65 amp alternator; 72 amp alternator

### COOLING SYSTEM

QTY	WATER PUMP	PART NO.	SIZE	DESCRIPTION
1	Water Pump Impeller	FP-R40979		w/Pump housing marked R48994, R56787
1	Water Pump Housing Gasket	FP-T25485		w/Pump housing marked R48994, R56787
1	Water Intake Gasket	FP-T23132		
1	Water Pump Mounting Gasket	FP-T20243		w/Pump housing marked R48992, R48994, R56787
QTY	THERMOSTAT	PART NO.	SIZE	DESCRIPTION
1	Thermostat Cover Gasket	FP-T24932		Water manifold marked T24931, R61178
QTY	MISCELLANEOUS	PART NO.	SIZE	DESCRIPTION
1	Water Manifold Gasket	FP-T23002		

### CRANKSHAFT/OIL PUMP

QTY	CRANKSHAFT	PART NO.	SIZE	DESCRIPTION
1	Oil Seal Kit	FP-SK67942		Incl. front & rear seals
QTY	OIL PUMP	PART NO.	SIZE	DESCRIPTION
1	O-Ring	FP-R74354		Oil pump outlet tube seal; w/Pump housing marked R54615, T20078

### CYLINDER COMPONENTS

QTY	LINERS	PART NO.	SIZE	DESCRIPTION
6	Cylinder Kit Complete	FP-AR71593	STD	Top sleeve seal; Cotton Picker Models 499 & 699; Pin dia. 1.19"
6	Sealing Ring	FP-SLR2515		Top sleeve seal; Cotton Picker Models 499 & 699; Rectangle

**Grader 6329T Eng. Loader 6329T Eng. Wheel Tractor 6329T Eng. Skidder 6329T Eng. 80**  
**Backhoe 6329T Eng.**  
 5.4L 329 OHV Turbo-Diesel L6, 4.0156" Bore

### CYL. HEAD & PARTS

QTY	GASKETS	PART NO.	SIZE	DESCRIPTION
1	Head Set	FP-RE38852		

### FUEL SYSTEM & PARTS

QTY	TURBOCHARGER	PART NO.	SIZE	DESCRIPTION
1	Turbocharger Mounting Gasket	FP-R89879		

(continued on next page)

**80** Grader 6329T Eng. Loader 6329T Eng. Wheel Tractor 6329T Eng. Skidder 6329T Eng.  
 (cont.) Backhoe 6329T Eng.  
 5.4L 329 OHV Turbo-Diesel L6, 4.0156" Bore

### ENGINE BLOCK & PARTS

QTY	GASKET SETS	PART NO.	SIZE	DESCRIPTION
1	In-Frame Gasket Set	FP-PG329S		

### CRANKSHAFT/OIL PUMP

QTY	CRANKSHAFT	PART NO.	SIZE	DESCRIPTION
1	Oil Seal Kit	FP-SK67942		Incl. front & rear seals

QTY	SEALS - FRONT CRANK	PART NO.	SIZE	DESCRIPTION
1	Crankshaft Front Seal	FP-AR67942		

QTY	SEALS - REAR CRANK	PART NO.	SIZE	DESCRIPTION
1	Crankshaft Rear Seal	FP-RE24959		

QTY	MAIN BEARINGS	PART NO.	SIZE	DESCRIPTION
1	Main Set	FP-MBK3006	STD	w/Flanged thrust brg.
1	Main Set	FP-MBK300610	10	w/Flanged thrust brg.
1	Main Set	FP-MBK300620	20	w/Flanged thrust brg.
1	Main Set	FP-MBK300630	30	w/Flanged thrust brg.

### CYLINDER COMPONENTS

QTY	PISTONS	PART NO.	SIZE	DESCRIPTION
6	Pin Bushing	FP-T23471		1.1896" ID, 1.313" OD, 1.570" O.A.L.
6	Pin Bushing	FP-R55647		1.3765" ID, 1.500" OD, 1.570" O.A.L.

QTY	CONNECTING RODS & BRGS.	PART NO.	SIZE	DESCRIPTION
6	Rod Pair	FP-RE27348	STD	
6	Rod Pair	FP-RE27349	10	
6	Rod Pair	FP-RE27358	20	
6	Rod Pair	FP-RE27364	30	

**81** Combine 6341G Eng. Power Unit 6341G Eng. Wheel Tractor 6341G Eng. Loader Tractor  
 6341G Eng.  
 5.6L 340 OHV L6, 4.25" Bore

### CYL. HEAD & PARTS

QTY	VALVE	PART NO.	SIZE	DESCRIPTION
6	Intake	FP-V1635		1.6880" Head Dia., .3720" Stem Dia., 5.7000" O.A.L.
6	Exhaust	FP-V1634		1.5000" Head Dia., .3720" Stem Dia., 5.7310" O.A.L.
24	Keeper	FP-B367R		2 groove
24	Keeper	VK-66R		2 groove; Hardened

QTY	VALVE SEAT	PART NO.	SIZE	DESCRIPTION
6	Int.	FP-R78702	STD	1.7550" OD, 1.5000" ID, .2160" Depth

QTY	VALVE GUIDE	PART NO.	SIZE	DESCRIPTION
12	Guide	FP-VG606		.3750" ID, 2.9400" O.A.L.

QTY	VALVE SEAL	PART NO.	SIZE	DESCRIPTION
12	Valve Stem Seal	ST-2004		Positive type; Installation requires valve guide machining; Rubber/PTFE
12	Valve Stem Seal Bulk	ST-2004BC		Positive type; Installation requires valve guide machining; Carton of 100; Rubber/PTFE

### ENGINE BLOCK & PARTS

QTY	CAM BEARINGS	PART NO.	SIZE	DESCRIPTION
1	Cam Set	FP-4R46903	STD	
4	Cam Brg.	FP-R46903	STD	

### CRANKSHAFT/OIL PUMP

QTY	SEALS - FRONT CRANK	PART NO.	SIZE	DESCRIPTION
1	Oil Seal Kit	FP-AR49025		

QTY	SEALS - REAR CRANK	PART NO.	SIZE	DESCRIPTION
1	Oil Seal	FP-RE22764		PTFE

QTY	MAIN BEARINGS	PART NO.	SIZE	DESCRIPTION
1	Main Set	FP-MBK3007	STD	
1	Main Set	FP-MBK300710	10	
1	Main Set	FP-MBK300720	20	
1	Main Set	FP-MBK300730	30	

(continued on next page)





# John Deere Off Highway

**Combine 6341G Eng. Power Unit 6341G Eng. Wheel Tractor 6341G Eng. Loader Tractor 81**  
**6341G Eng. (cont.)**  
 5.6L 340 OHV L6, 4.25" Bore

### CYLINDER COMPONENTS

QTY	LINERS	PART NO.	SIZE	DESCRIPTION
6	Sleeve Assy.	FP-SL2279		Exc. Models 4000, 4020 w/Block marked R40940, R49550
6	Sealing Ring, Liner	FP-112847		Exc. Models 4000, 4020 w/Block marked R40940, R49550
QTY	PISTONS	PART NO.	SIZE	DESCRIPTION
6	Cast Piston	FP-2279P	STD	Cast; 3-3/32", 1-1/4" Ring Groove, 2.6525" CD, 1.2500" Pin Dia., Recessed Head Wedge Shape .470" deep x 3.500" wide - 7.5:1 C.R.; Repl. O.E. Nos. R33372, R34617
6	Pin Bushing	FP-R30939		
QTY	CONNECTING RODS & BRGS.	PART NO.	SIZE	DESCRIPTION
6	Rod Pair	FP-AR45723	STD	
6	Rod Pair	FP-AR46396	10	
6	Rod Pair	FP-AR46397	20	
6	Rod Pair	FP-AR46398	30	
QTY	PISTON RINGS	PART NO.	SIZE	DESCRIPTION
6	Ring Set Single Cylinder	FP-W5589KX	STD	Check piston grooving before supplying ring set
3	Premium Set	FP-5589KX	STD	Check piston grooving before supplying ring set; 3-3/32, 1-1/4 (2 cyl. set)

**Wheel Tractor 6341LP Eng. (LPG). Loader Tractor 6341LP Eng. (LPG). 82**  
 5.6L 340 OHV LPG L6, 4.25" Bore

### CYL. HEAD & PARTS

QTY	VALVE	PART NO.	SIZE	DESCRIPTION
6	Intake	FP-V1635		1.6880" Head Dia., .3720" Stem Dia., 5.7000" O.A.L.
6	Exhaust	FP-V1634		1.5000" Head Dia., .3720" Stem Dia., 5.7310" O.A.L.
24	Keeper	FP-B367R		2 groove
24	Keeper	VK-66R		2 groove; Hardened
QTY	VALVE SEAT	PART NO.	SIZE	DESCRIPTION
6	Int.	FP-R78702	STD	1.7550" OD, 1.5000" ID, .2160" Depth
QTY	VALVE GUIDE	PART NO.	SIZE	DESCRIPTION
12	Guide	FP-VG606		.3750" ID, 2.9400" O.A.L.
QTY	VALVE SEAL	PART NO.	SIZE	DESCRIPTION
12	Valve Stem Seal	ST-2004		Positive type; Installation requires valve guide machining; Rubber/PTFE
12	Valve Stem Seal Bulk	ST-2004BC		Positive type; Installation requires valve guide machining; Carton of 100; Rubber/PTFE

### ENGINE BLOCK & PARTS

QTY	CAM BEARINGS	PART NO.	SIZE	DESCRIPTION
1	Cam Set	FP-4R46903	STD	
4	Cam Brg.	FP-R46903	STD	

### CRANKSHAFT/OIL PUMP

QTY	SEALS - FRONT CRANK	PART NO.	SIZE	DESCRIPTION
1	Oil Seal Kit	FP-AR49025		
QTY	SEALS - REAR CRANK	PART NO.	SIZE	DESCRIPTION
1	Oil Seal	FP-RE22764		PTFE
QTY	MAIN BEARINGS	PART NO.	SIZE	DESCRIPTION
1	Main Set	FP-MBK3007	STD	
1	Main Set	FP-MBK300710	10	
1	Main Set	FP-MBK300720	20	
1	Main Set	FP-MBK300730	30	

### CYLINDER COMPONENTS

QTY	LINERS	PART NO.	SIZE	DESCRIPTION
6	Sleeve Assy.	FP-SL2454		Exc. Models 4000, 4020 w/Block marked R40940, R49550
6	Sealing Ring, Liner	FP-112847		Exc. Models 4000, 4020 w/Block marked R40940, R49550
QTY	PISTONS	PART NO.	SIZE	DESCRIPTION
6	Cast Piston	FP-2454P	STD	Cast; 3-3/32", 1-1/4" Ring Groove, 2.655" CD, 1.2500" Pin Dia., Flat Head; Repl. O.E. Nos. R33374, R40778
6	Pin Bushing	FP-3129YA20		1.252" ID, 1.3785" OD, 1.510" O.A.L.
QTY	CONNECTING RODS & BRGS.	PART NO.	SIZE	DESCRIPTION
6	Rod Pair	FP-AR45723	STD	

(continued on next page)

# John Deere Off Highway



**82** Wheel Tractor 6341LP Eng. (LPG). Loader Tractor 6341LP Eng. (LPG).  
(cont.) 5.6L 340 OHV LPG L6, 4.25" Bore

## CYLINDER COMPONENTS (cont.)

CONNECTING RODS & BRGS. (cont.)				
QTY		PART NO.	SIZE	DESCRIPTION
6	Rod Pair	FP-AR46396	10	
6	Rod Pair	FP-AR46397	20	
6	Rod Pair	FP-AR46398	30	
PISTON RINGS				
QTY		PART NO.	SIZE	DESCRIPTION
6	Ring Set Single Cylinder	FP-W5589KX	STD	
3	Premium Set	FP-5589KX	STD	3-3/32, 1-1/4 (2 cyl. set)

**83** Grader 6059D Eng. Loader 6059D Eng.  
5.9L 358.4 (5876cc) OHV Diesel L6 (Litre Engine), 106mm Bore

## CYL. HEAD & PARTS

GASKETS				
QTY		PART NO.	SIZE	DESCRIPTION
1	Valve Cover Gasket	FP-R75728		Rocker cover codes 1102, 1103, 1104, 1105; RePower Engs.; Valve cover codes 1110, 1112
1	Head Gasket	FP-R114157		Cyl. head code 5101; RePower Engs.
1	Head Set	FP-RE38852		Cyl. head code 5101; RePower Engs.
VALVE				
QTY		PART NO.	SIZE	DESCRIPTION
6	Intake	FP-R98062	STD	1 groove; Chrome plated stem; 1.8350" Head Dia., .3100" Stem Dia., 5.2780" O.A.L.
6	Intake	FP-R97490	15	1 groove; Chrome plated stem; 1.8350" Head Dia., .3250" Stem Dia., 5.2780" O.A.L.
6	Exhaust	FP-R90692	STD	1 groove; Chrome plated stem; 1.6730" Head Dia., .3095" Stem Dia., 5.2550" O.A.L.
6	Exhaust	FP-R97492	15	1 groove; Chrome plated stem; 1.6730" Head Dia., .3245" Stem Dia., 5.2550" O.A.L.
24	Keeper	FP-R91889		
VALVE SEAT				
QTY		PART NO.	SIZE	DESCRIPTION
6	Exh.	FP-R85687	STD	
6	Int.	FP-R98335		.020" Dia. O/S face width; 1.8575" OD, 1.5500" ID, .2580" Depth
6	Int.	FP-R98063	STD	1.8575" OD, 1.5500" ID, .2580" Depth
VALVE SPRING				
QTY		PART NO.	SIZE	DESCRIPTION
12	Spring	FP-R26125		2.1200" Free Height
VALVE MISC.				
QTY		PART NO.	SIZE	DESCRIPTION
12	Rotocap	FP-RE60005		Exh. & Int.
1	Oil Filler Cap Gasket	FP-R80135		Oil filler neck code 1204; L.H. Auxiliary drive
1	Oil Filler Cap Gasket	FP-T20328		Rocker arm cover codes 1103, 1104; Oil filler neck codes 1202, 1203
VALVE SEAL				
QTY		PART NO.	SIZE	DESCRIPTION
12	Valve Stem Seal	FP-RE31617		Exh. & Int.; From Ser. No. 300,000; Positive type
12	Valve Stem Seal	FP-R87627		Exh. & Int.; O-Ring type
ROCKER PARTS				
QTY		PART NO.	SIZE	DESCRIPTION
1	O-Ring	FP-R56463		Rocker cover breather tube; Breather tube codes 2901, 2902, 2905, 2909, 2912, 2999
1	O-Ring	FP-R56463		Rocker cover breather tube; RePower Engs.; Breather tube code 2909

## ELECTRICAL

ELECTRICAL				
QTY		PART NO.	SIZE	DESCRIPTION
1	Starter to Block Gasket	FP-R53108		3-Hole mount; Starting motor codes 3002, 3013, 3016 L.H.; Starting motor codes 3007, 3015, 3016 R.H.
ALTERNATOR				
QTY		PART NO.	SIZE	DESCRIPTION
1	Ball Brg.	FP-JD9449		Front; Codes 3111, 3114, 3115; 12 Volt, 78 amp alternator
2	Ball Brg.	FP-JD9449		Front & Rear; Codes 3101, 3109; 12 Volt, 65 amp alternator
2	Ball Brg.	FP-JD9449		Front & Rear; Codes 3117, 3119, 3140; 24 Volt, 45 amp alternator

## INT & EXH MANIFOLDS

INT. & EXH. MANIFOLDS				
QTY		PART NO.	SIZE	DESCRIPTION
6	Exhaust Manifold Gasket	FP-R90658		
2	Air Intake Gasket	FP-R81275		

## CAMSHAFT GROUP

TIMING COVER				
QTY		PART NO.	SIZE	DESCRIPTION
1	Timing Gear Cover Gasket	FP-T20273		Access cover
1	Timing Gear Cover Gasket	FP-R97454		Front cover

(continued on next page)



# John Deere Off Highway

*Grader 6059D Eng. Loader 6059D Eng. 83*  
5.9L 358.4 (5876cc) OHV Diesel L6 (Litre Engine), 106mm Bore (cont.)

<b>FUEL SYSTEM &amp; PARTS</b>				
<b>QTY</b>	<b>FUEL INJECTION</b>	<b>PART NO.</b>	<b>SIZE</b>	<b>DESCRIPTION</b>
1	Injector Pump Gasket	FP-R125066		Gear cover
6	Fuel Injector Nozzle	FP-RE36935		w/Injector marked 28480
6	Fuel Injector Seal	FP-R79605		Fuel line connection; Nozzle code 1695; Nozzle marked 28480; 9.270MM X 13.600MM X 5.080MM
6	Fuel Injector Seal	FP-R79605		RePower Eng.s.; Fuel line connection; Nozzle code 1695; Nozzle marked 28480; 9.270MM X 13.600MM X 5.080MM
6	Fuel Injector Nut	FP-R79604		w/Injector marked 28480
2	Clamp	FP-R34766		Pump codes 3702, 3710
12	Washer Type Seal	FP-R51936		Leak-off & return line seals; Nozzle codes 1602, 1603, 1653
12	Washer Type Seal	FP-R51936		Nozzle code 1695; w/Nozzle marked 28480
12	Washer Type Seal	FP-R51936		RePower Eng.s.; Nozzle code 1695; w/Nozzle marked 28480
6	Washer Type Seal	FP-R48000		Lower; w/Nozzle marked 28480
6	Washer Type Seal	FP-R60746		Upper; w/Nozzle marked 28480
<b>COOLING SYSTEM</b>				
<b>QTY</b>	<b>WATER PUMP</b>	<b>PART NO.</b>	<b>SIZE</b>	<b>DESCRIPTION</b>
1	Water Pump Impeller	FP-R47191		w/Pump housing marked R66420, R68733
1	Water Pump Impeller	FP-R56812		w/Pump housing marked R90783
1	Water Pump Impeller	FP-R94419		Pump code 2002; w/Pump housing marked R100871, R111028, RE48161
1	Water Pump Repair/Rebuild Kit	FP-864340979		w/Pump housing marked R51661, R73606, R73724, R79171
1	Water Pump Repair/Rebuild Kit	FP-925740979		w/Pump housing marked R56787, R62902
1	Water Pump Repair/Rebuild Kit	FP-RE62661		w/Pump housing marked R66420, R68733
1	Water Pump Repair/Rebuild Kit	FP-RE62658		w/Pump housing marked R73604
1	Water Pump Repair/Rebuild Kit	FP-RE70143		From Ser. No. 100,000 to Ser. No. 499,999; w/Cast iron impeller
1	Water Pump Housing Gasket	FP-R97455		w/Pump housing marked R73604; Back plate to pump
1	Oil Seal Kit	FP-AR101549		Water Pump; w/Pump housing marked R90783, R100871, R111028
1	Water Pump Mounting Gasket	FP-T20243		w/Pump housing marked R73604, R90783, R100871; Pump to block
1	Shaft & Bearing Assembly	FP-JD9257		w/Pump housing marked R100871, R111028
1	Shaft & Bearing Assembly	FP-JD8643		w/Pump housing marked R90783
<b>QTY</b>	<b>THERMOSTAT</b>	<b>PART NO.</b>	<b>SIZE</b>	<b>DESCRIPTION</b>
2	Thermostat	FP-AR48675		Housing codes 3901, 3903; Thermostat cover code 2204 Vertical, 2108 Horizontal; 180 Deg.
2	Thermostat	FP-AR48675		RePower Eng.s.; Thermostat codes 2204, 2209; Housing codes 3901, 3903; 180 Deg.
1	Thermostat Cover Gasket	FP-R54638		Thermostat cover codes 2102, 2204, 2108, 2111; Thermostat housing codes 3901, 3903, 3904; w/Two thermostats
1	Therm. Hsg. - Water Mfld. Gsk	FP-R54641		Thermostat housing to cyl. head
2	O-Ring	FP-R56461		Thermostat housing tube seals; Housing code 3901
<b>ENGINE BLOCK &amp; PARTS</b>				
<b>QTY</b>	<b>GASKETS</b>	<b>PART NO.</b>	<b>SIZE</b>	<b>DESCRIPTION</b>
1	Flywheel Housing Gasket	FP-R97351		
1	Oil Pan Gasket	FP-R97344		
1	Oil Pan Gasket Set	FP-PG303PS		
1	Oil Pan Gasket Set	FP-PG302PS		From Ser. No. 362,801
2	O-Ring	FP-U13639		Block coolant drain plug seal; Coolant heater codes 2601, 2602; 1.475" X .118"
1	Block to End Plate Front Gskt	FP-R131794		Front plate codes 3601, 3602; R.H. side gear drive
1	Block to End Plate Front Gskt	FP-R131794		RePower Eng.s.; Front plate codes 3604, 3695
<b>QTY</b>	<b>GASKET SETS</b>	<b>PART NO.</b>	<b>SIZE</b>	<b>DESCRIPTION</b>
1	In-Frame Gasket Set	FP-PG359S		
1	Complete Overhaul Gasket Set	FP-RE38858		Crankshaft seals not incl.
1	Complete Overhaul Gasket Set	FP-RE38858WS		Incl. crankshaft seals
<b>QTY</b>	<b>CAM BEARINGS</b>	<b>PART NO.</b>	<b>SIZE</b>	<b>DESCRIPTION</b>
1	Cam Brg.	FP-R119874		
<b>QTY</b>	<b>OIL COOLERS &amp; FILTERS</b>	<b>PART NO.</b>	<b>SIZE</b>	<b>DESCRIPTION</b>
1	Oil Cooler	FP-RE61767		w/6 plates; Cooler codes 5904, 5906; From Ser. No. 185,224
1	Washer	FP-R105714		Oil cooler; Modine Oil Cooler codes 5911, 5915
<b>CRANKSHAFT/OIL PUMP</b>				
<b>QTY</b>	<b>CRANKSHAFT</b>	<b>PART NO.</b>	<b>SIZE</b>	<b>DESCRIPTION</b>
1	Oil Seal Kit	FP-SK67942		Crankshaft codes 4701, 4703, 4708, 4709; Incl. front & rear seals; Crankshaft marked T23266, R108658, R108679, R126982

(continued on next page)

# John Deere Off Highway



**83** Grader 6059D Eng. Loader 6059D Eng.  
(cont.) 5.9L 358.4 (5876cc) OHV Diesel L6 (Litre Engine), 106mm Bore

CRANKSHAFT/OIL PUMP (cont.)				
QTY	DESCRIPTION	PART NO.	SIZE	DESCRIPTION
1	CRANKSHAFT (cont.) Oil Seal Kit	FP-SK67942		Crankshaft codes 4701, 4703, 4708, 4709; Incl. front & rear seals; RePower Eng.s.; Crankshaft marked T23266, R108658, R108679, R126982
1	SEALS - FRONT CRANK Crankshaft Front Seal	FP-AR67942		Crankshaft pulley; Pulley codes 1303, 1308, 1312, 1338; Crankshaft, Bearing codes 4701, 4703, 4708, 4709; Crankshaft marked R108658, R108679
1	O-Ring	FP-H35244		
1	SEALS - REAR CRANK Crankshaft Rear Seal	FP-RE24959		
1	MAIN BEARINGS Main Set	FP-MBK3006	STD	w/Flanged thrust brg.
1	Main Set	FP-MBK300610	10	w/Flanged thrust brg.
1	Main Set	FP-MBK300620	20	w/Flanged thrust brg.
1	Main Set	FP-MBK300630	30	w/Flanged thrust brg.
6	Plain Main Brg.	FP-RE27352	STD	w/Flangeless thrust brg.
6	Plain Main Brg.	FP-RE27353	10	w/Flangeless thrust brg.
6	Plain Main Brg.	FP-RE27360	20	w/Flangeless thrust brg.
6	Plain Main Brg.	FP-RE27368	30	w/Flangeless thrust brg.
1	Flanged Main Brg.	FP-RE521350	STD	
1	Flanged Main Brg.	FP-RE526754	10	
1	Flanged Main Brg.	FP-RE527235	20	
1	Flanged Main Brg.	FP-RE527236	30	
1	OIL PUMP Pump Repair Kit	FP-RE55343		Pump codes 5001, 5005; w/Pump housing marked R54615
1	O-Ring	FP-R61871		Oil pump inlet; H/D Pump codes 5003, 5007, 5012
1	O-Ring	FP-R61871		Oil pump inlet; Pump codes 5001, 5002, 5004, 5007, 5010
1	O-Ring	FP-R61871		Oil pump inlet; RePower Eng.s. DD15691
1	O-Ring	FP-R74354		Oil pump outlet tube; RePower Eng.s.; Pump codes 5001, 5002, 5004, 5007, 5010; w/Pump housing marked R54615
1	Oil Filler Inlet Gasket	FP-R97352		Oil filler neck codes 1201, 1203, 1299
CYLINDER COMPONENTS				
6	LINERS Liner w/o Sealing Ring	FP-R116281		w/Con. Rod marked R51727, R80034
6	Liner w/Sealing Rings	FP-RE500023		
6	Cylinder Kit Complete	FP-RE30250	STD	
6	Cyl. Liner Sealing Ring Kit	FP-AR65507		
6	Sealing Ring, Liner	FP-R48767		
6	Sealing Ring, Liner	FP-R26121		
6	Sealing Ring	FP-SLR2520		Rectangle; Top Round; Middle Round; Bottom
6	PISTONS Piston Body w/o Pin	FP-RE19282		1.38" pin dia. For 1.38" pin dia. w/Con. Rod marked R51727, R80034; 1.3765" ID, 1.500" OD, 1.570" O.A.L.
6	Piston Kit w/Pin & Retainers	FP-RE19282WP		
6	Pin	FP-R125754		
12	Piston Pin Retainer	FP-M41029		
6	Pin Bushing	FP-R55647		
12	CONNECTING RODS & BRGS. Con. Rod Bolt	FP-R80033		w/Con. Rod marked R51727, R80032, R80034, R113612; Torque-To-Yield bolt; Replacement recommended
6	Rod Pair	FP-RE27348	STD	
6	Rod Pair	FP-RE27349	10	
6	Rod Pair	FP-RE27358	20	
6	Rod Pair	FP-RE27364	30	
6	PISTON RINGS Ring Set Single Cylinder	FP-RE507852	STD	1-1/8, 1-3/32, 1-.136 (1 cyl. set)
6	Ring Set Single Cylinder	FP-RE66820	STD	1-1/8, 1-3/32, 1-.136 (1 cyl. set)
KITS				
1	OVERHAUL KIT In-Frame Overhaul Kit	FP-359DIFK		w/Con. Rod marked R51727, R80034; w/Flangeless thrust brg.; Incl. Torque-To-Yield con. rod bolts
1	Complete Overhaul Kit	FP-359DOHK		w/Con. Rod marked R51727, R80034; w/Flangeless thrust brg.; Incl. front & rear seals; Incl. Torque-To-Yield con. rod bolts



**Grader 6059T Eng. Loader 6059T Eng. Skidder 6059T Eng. 84**  
5.9L 358.4 (5876cc) OHV Turbo-Diesel L6 (Litre Engine), 106mm Bore

<b>CYL. HEAD &amp; PARTS</b>				
<b>QTY</b>	<b>GASKETS</b>	<b>PART NO.</b>	<b>SIZE</b>	<b>DESCRIPTION</b>
1	Valve Cover Gasket	FP-R75728		Rocker cover codes 1102, 1103, 1104, 1105, 1112
1	Head Gasket	FP-R114157		Cyl. head code 5101
1	Head Set	FP-RE38852		Cyl. head code 5101
<b>QTY</b>	<b>VALVE</b>	<b>PART NO.</b>	<b>SIZE</b>	<b>DESCRIPTION</b>
6	Intake	FP-R98062	STD	1 groove; Chrome plated stem; 1.8350" Head Dia., .3100" Stem Dia., 5.2780" O.A.L.
6	Intake	FP-R97490	15	1 groove; Chrome plated stem; 1.8350" Head Dia., .3250" Stem Dia., 5.2780" O.A.L.
6	Exhaust	FP-R90692	STD	1 groove; Chrome plated stem; 1.6730" Head Dia., .3095" Stem Dia., 5.2550" O.A.L.
6	Exhaust	FP-R97492	15	1 groove; Chrome plated stem; 1.6730" Head Dia., .3245" Stem Dia., 5.2550" O.A.L.
24	Keeper	FP-R91889		
<b>QTY</b>	<b>VALVE SEAT</b>	<b>PART NO.</b>	<b>SIZE</b>	<b>DESCRIPTION</b>
6	Exh.	FP-R85687	STD	
6	Int.	FP-R98335		.020" Dia. O/S face width; 1.8575" OD, 1.5500" ID, .2580" Depth
6	Int.	FP-R98063	STD	1.8575" OD, 1.5500" ID, .2580" Depth
<b>QTY</b>	<b>VALVE SPRING</b>	<b>PART NO.</b>	<b>SIZE</b>	<b>DESCRIPTION</b>
12	Spring	FP-R26125		2.1200" Free Height
<b>QTY</b>	<b>VALVE MISC.</b>	<b>PART NO.</b>	<b>SIZE</b>	<b>DESCRIPTION</b>
12	Rotocap	FP-RE60005		Exh. & Int.
1	Oil Filler Cap Gasket	FP-R80135		Oil filler neck code 1204; L.H. Auxiliary drive
1	Oil Filler Cap Gasket	FP-T20328		Rocker arm cover codes 1103, 1104; Oil filler neck codes 1202, 1203
<b>QTY</b>	<b>VALVE SEAL</b>	<b>PART NO.</b>	<b>SIZE</b>	<b>DESCRIPTION</b>
12	Valve Stem Seal	FP-RE31617		Exh. & Int.; From Ser. No. 300,000; Positive type
12	Valve Stem Seal	FP-R87627		Exh. & Int.; O-Ring type
<b>QTY</b>	<b>ROCKER PARTS</b>	<b>PART NO.</b>	<b>SIZE</b>	<b>DESCRIPTION</b>
1	O-Ring	FP-R56463		Rocker cover breather tube; Breather tube codes 2902, 2905, 2909, 2912, 2999
<b>ELECTRICAL</b>				
<b>QTY</b>	<b>ELECTRICAL</b>	<b>PART NO.</b>	<b>SIZE</b>	<b>DESCRIPTION</b>
1	Starter to Block Gasket	FP-R53108		3-Hole mount; Starting motor codes 3002, 3013, 3016 L.H.; Starting motor codes 3007, 3015, 3016 R.H.
<b>INT &amp; EXH MANIFOLDS</b>				
<b>QTY</b>	<b>INT. &amp; EXH. MANIFOLDS</b>	<b>PART NO.</b>	<b>SIZE</b>	<b>DESCRIPTION</b>
6	Exhaust Manifold Gasket	FP-R90658		
2	Air Intake Gasket	FP-R81275		
<b>QTY</b>	<b>AIR INTAKE</b>	<b>PART NO.</b>	<b>SIZE</b>	<b>DESCRIPTION</b>
1	O-Ring	FP-R56905		Air intake system code 1709
<b>CAMSHAFT GROUP</b>				
<b>QTY</b>	<b>TIMING COVER</b>	<b>PART NO.</b>	<b>SIZE</b>	<b>DESCRIPTION</b>
1	Timing Gear Cover Gasket	FP-R97454		Front cover
<b>FUEL SYSTEM &amp; PARTS</b>				
<b>QTY</b>	<b>FUEL INJECTION</b>	<b>PART NO.</b>	<b>SIZE</b>	<b>DESCRIPTION</b>
1	Injector Pump Gasket	FP-R125066		Gear cover
6	Fuel Injector Nozzle	FP-RE36939		w/Injector marked 28484
6	Fuel Injector Seal	FP-R79605		Fuel line connection; RePower Engs.; Nozzle code 1695; Nozzle marked 28484; 9.270MM X 13.600MM X 5.080MM
6	Fuel Injector Nut	FP-R79604		w/Injector marked 28484
2	Clamp	FP-R34766		Pump codes 3702, 3710
12	Washer Type Seal	FP-R51936		Leak-off & return line seals; Nozzle codes 1602, 1603, 1653
12	Washer Type Seal	FP-R51936		RePower Engs.; Nozzle code 1695; w/Nozzle marked 28480
6	Washer Type Seal	FP-R48000		Lower; w/Nozzle marked 28484
<b>QTY</b>	<b>TURBOCHARGER</b>	<b>PART NO.</b>	<b>SIZE</b>	<b>DESCRIPTION</b>
1	Turbocharger Oil Drain Gasket	FP-R105346		w/Turbo oil line codes 6501, 6512, 6515
1	Turbocharger Mounting Gasket	FP-R43751		From Ser. No. 100,000 to Ser. No. 499,999; Codes 6506, 6512
1	Turbocharger Mounting Gasket	FP-R89879		RePower Engs.
1	Turbocharger Oil Supply Gskt.	FP-R97348		Turbo codes 6501, 6515

(continued on next page)

**84 Grader 6059T Eng. Loader 6059T Eng. Skidder 6059T Eng.**  
 (cont.) 5.9L 358.4 (5876cc) OHV Turbo-Diesel L6 (Litre Engine), 106mm Bore

COOLING SYSTEM				
QTY	WATER PUMP	PART NO.	SIZE	DESCRIPTION
1	Water Pump Impeller	FP-R47191		w/Pump housing marked R66420, R68733
1	Water Pump Impeller	FP-R56812		w/Pump housing marked R90783
1	Water Pump Impeller	FP-R94419		Pump code 2002; w/Pump housing marked R100871, R111028, RE48161
1	Water Pump Repair/Rebuild Kit	FP-864340979		w/Pump housing marked R51661, R73606, R73724, R79171
1	Water Pump Repair/Rebuild Kit	FP-925740979		w/Pump housing marked R56787, R62902
1	Water Pump Repair/Rebuild Kit	FP-RE62661		w/Pump housing marked R66420, R68733
1	Water Pump Repair/Rebuild Kit	FP-RE62658		w/Pump housing marked R73604
1	Water Pump Repair/Rebuild Kit	FP-RE70143		From Ser. No. 100,000 to Ser. No. 499,999; w/Cast iron impeller
1	Water Pump Housing Gasket	FP-R97455		w/Pump housing marked R73604, R100871, R111028
1	Water Pump Housing Gasket	FP-R56809		w/Pump housing marked R90783
1	Oil Seal Kit	FP-AR101549		Water Pump; w/Pump housing marked R90783, R100871, R111028
1	Water Pump Mounting Gasket	FP-T20243		w/Pump housing marked R73604, R86824, R90783, R100871, R111028
1	Shaft & Bearing Assembly	FP-JD9257		w/Pump housing marked R100871, R111028
1	Shaft & Bearing Assembly	FP-JD8643		w/Pump housing marked R90783
QTY	THERMOSTAT	PART NO.	SIZE	DESCRIPTION
2	Thermostat	FP-AR48675		Thermostat codes 2204, 2209; Thermostat cover code 2204 Vertical, 2108 Horizontal; Housing codes 3901, 3903; 180 Deg.
1	Thermostat Cover Gasket	FP-R54638		Thermostat cover codes 2102, 2204, 2108, 2111; Thermostat housing codes 3901, 3903, 3904; w/Two thermostats
1	Therm. Hsg. - Water Mfld. Gsk	FP-R54641		Thermostat housing to cyl. head
2	O-Ring	FP-R56461		Thermostat housing tube seals; Housing codes 3901, 3904
QTY	MISCELLANEOUS	PART NO.	SIZE	DESCRIPTION
2	Water Line Gasket	FP-R97346		
ENGINE BLOCK & PARTS				
QTY	GASKETS	PART NO.	SIZE	DESCRIPTION
1	Flywheel Housing Gasket	FP-R97351		
1	Oil Pan Gasket	FP-R97344		Oil pan codes 1905, 1906, 1909, 1917, 1918, 1931, 1935
1	Oil Pan Gasket Set	FP-PG303PS		
1	Oil Pan Gasket Set	FP-PG302PS		From Ser. No. 362,801
2	O-Ring	FP-U13639		Block coolant drain plug seal; Coolant heater codes 2601, 2602; 1.475" X .118"
1	Block to End Plate Front Gskt	FP-R131794		Front plate codes 3601, 3602
QTY	GASKET SETS	PART NO.	SIZE	DESCRIPTION
1	In-Frame Gasket Set	FP-PG359S		
1	Complete Overhaul Gasket Set	FP-RE38858		Crankshaft seals not incl.
1	Complete Overhaul Gasket Set	FP-RE38858WS		Incl. crankshaft seals
QTY	CAM BEARINGS	PART NO.	SIZE	DESCRIPTION
1	Cam Brg.	FP-R119874		
QTY	OIL COOLERS & FILTERS	PART NO.	SIZE	DESCRIPTION
1	Oil Cooler	FP-RE61767		w/6 plates; Cooler codes 5904, 5906; From Ser. No. 185,224
1	Washer	FP-R105714		Oil cooler; Modine Oil Cooler codes 5911, 5915
1	Rect. or Square Seal	FP-R70956		Cooler housing; Cooler codes 5904, 5906, 5907; To Ser. No. 185,223; 2.700" X 3.000" X .180"
1	Rect. or Square Seal	FP-R70956		Cooler housing; RePower Eng.; Cooler code 5995; To Ser. No. 185,223; 2.700" X 3.000" X .180"
CRANKSHAFT/OIL PUMP				
QTY	CRANKSHAFT	PART NO.	SIZE	DESCRIPTION
1	Oil Seal Kit	FP-SK67942		Crankshaft codes 4701, 4703, 4708, 4709; Incl. front & rear seals; Crankshaft marked T23266, R108658, R108679, R126982
1	Oil Seal Kit	FP-SK67942		Crankshaft codes 4701, 4703, 4708, 4709; Incl. front & rear seals; RePower Eng.; Crankshaft marked T23266, R108658, R108679, R126982
QTY	SEALS - FRONT CRANK	PART NO.	SIZE	DESCRIPTION
1	Crankshaft Front Seal	FP-AR67942		
1	O-Ring	FP-H35244		Crankshaft pulley; Pulley codes 1303, 1308, 1312, 1338; Crankshaft, Bearing codes 4701, 4703, 4708, 4709; Crankshaft marked R108658, R108679
QTY	SEALS - REAR CRANK	PART NO.	SIZE	DESCRIPTION
1	Crankshaft Rear Seal	FP-RE24959		
QTY	MAIN BEARINGS	PART NO.	SIZE	DESCRIPTION
1	Main Set	FP-MBK3006	STD	w/Flanged thrust brg.

(continued on next page)



# John Deere Off Highway

**Grader 6059T Eng. Loader 6059T Eng. Skidder 6059T Eng. 84**  
5.9L 358.4 (5876cc) OHV Turbo-Diesel L6 (Litre Engine), 106mm Bore (cont.)

## CRANKSHAFT/OIL PUMP (cont.)

QTY	MAIN BEARINGS (cont.)	PART NO.	SIZE	DESCRIPTION
1	Main Set	FP-MBK300610	10	w/Flanged thrust brg.
1	Main Set	FP-MBK300620	20	w/Flanged thrust brg.
1	Main Set	FP-MBK300630	30	w/Flanged thrust brg.
6	Plain Main Brg.	FP-RE27352	STD	w/Flangeless thrust brg.
6	Plain Main Brg.	FP-RE27353	10	w/Flangeless thrust brg.
6	Plain Main Brg.	FP-RE27360	20	w/Flangeless thrust brg.
6	Plain Main Brg.	FP-RE27368	30	w/Flangeless thrust brg.
1	Flanged Main Brg.	FP-RE521350	STD	
1	Flanged Main Brg.	FP-RE526754	10	
1	Flanged Main Brg.	FP-RE527235	20	
1	Flanged Main Brg.	FP-RE527236	30	

QTY	OIL PUMP	PART NO.	SIZE	DESCRIPTION
1	Pump Repair Kit	FP-RE55343		Pump code 5001; w/Pump housing marked R54615
1	O-Ring	FP-R61871		Oil pump inlet; H/D Pump codes 5003, 5007, 5012
1	O-Ring	FP-R61871		Oil pump inlet; Pump codes 5001, 5002, 5004, 5007, 5010
1	O-Ring	FP-R61871		Oil pump inlet; RePower Engs. DD15691
1	O-Ring	FP-R74354		Oil pump outlet tube; Pump code 5010; w/Pump housing marked R54615
1	O-Ring	FP-R74354		Oil pump outlet tube; Pump codes 5001, 5002,5004, 5007; RePower Engs.; w/Pump housing marked R54615
1	Oil Filler Inlet Gasket	FP-R97352		Oil filler neck codes 1201, 1203, 1299

## CYLINDER COMPONENTS

QTY	LINERS	PART NO.	SIZE	DESCRIPTION
6	Liner w/o Sealing Ring	FP-R116281		
6	Liner w/Sealing Rings	FP-RE500023		
6	Cylinder Kit Complete	FP-RE33115		w/Con. Rod marked R80032, R113612
6	Cyl. Liner Sealing Ring Kit	FP-AR65507		
6	Sealing Ring, Liner	FP-R48767		Rectangle; Top
6	Sealing Ring, Liner	FP-R26121		Round; Middle
6	Sealing Ring	FP-SLR2520		Round; Bottom

QTY	PISTONS	PART NO.	SIZE	DESCRIPTION
6	Piston Body w/o Pin	FP-RE48368		
6	Piston Kit w/Pin & Retainers	FP-RE48368WP		
6	Pin	FP-R124230		1.62" pin dia.
12	Piston Pin Retainer	FP-R54114		For 1.62" pin dia.
6	Pin Bushing	FP-R57451		w/Con. Rod marked R56187, R58979, R80032, R113612; Pin dia. 1.62"; 1.621" ID, 1.813" OD, 1.370" O.A.L.

QTY	CONNECTING RODS & BRGS.	PART NO.	SIZE	DESCRIPTION
12	Con. Rod Bolt	FP-R80033		w/Con. Rod marked R80032, R80034, R81410, R105011, R113612; Torque-To-Yield bolt; Replacement recommended
6	Rod Pair	FP-RE27348	STD	
6	Rod Pair	FP-RE27349	10	
6	Rod Pair	FP-RE27358	20	
6	Rod Pair	FP-RE27364	30	

QTY	PISTON RINGS	PART NO.	SIZE	DESCRIPTION
6	Ring Set Single Cylinder	FP-RE507852	STD	1-1/8, 1-3/32, 1-.136 (1 cyl. set)
6	Ring Set Single Cylinder	FP-RE66820	STD	1-1/8, 1-3/32, 1-.136 (1 cyl. set)

## KITS

QTY	OVERHAUL KIT	PART NO.	SIZE	DESCRIPTION
1	In-Frame Overhaul Kit	FP-359TIFK		w/Con. Rod marked R80032, R113612; w/Flangeless thrust brg.; Incl. Torque-To-Yield con. rod bolts
1	Complete Overhaul Kit	FP-359TOHK		w/Con. Rod marked R80032, R113612; w/Flangeless thrust brg.; Pin dia. 1.62"; Incl. front & rear seals; Crankshaft marked R108658, R108679, R126982, T23266; Incl. Torque-To-Yield con. rod bolts

**Combine 6359D Eng. Cotton Picker 6359D Eng. Grader 6359D Eng. Wheel Tractor 6359D 85**  
**Eng.**  
5.9L 359 OHV Diesel L6, 4.1875" Bore

## CYL. HEAD & PARTS

QTY	GASKETS	PART NO.	SIZE	DESCRIPTION
1	Head Set	FP-RE38852		

(continued on next page)

**85** Combine 6359D Eng. Cotton Picker 6359D Eng. Grader 6359D Eng. Wheel Tractor 6359D  
 (cont.) Eng.  
 5.9L 359 OHV Diesel L6, 4.1875" Bore

### CYL. HEAD & PARTS (cont.)

QTY	VALVE	PART NO.	SIZE	DESCRIPTION
6	Intake	FP-R79623	STD	2 groove; Chrome plated stem; 1.7720" Head Dia., .3720" Stem Dia., 5.1560" O.A.L.
6	Intake	FP-R79628	3	2 groove; Chrome plated stem; 1.7720" Head Dia., .3750" Stem Dia., 5.1560" O.A.L.
6	Intake	FP-R79629	15	2 groove; Chrome plated stem; 1.7720" Head Dia., .3870" Stem Dia., 5.1560" O.A.L.
6	Intake	FP-R79630	30	2 groove; Chrome plated stem; 1.7720" Head Dia., .4020" Stem Dia., 5.1560" O.A.L.
6	Exhaust	FP-R79624	STD	1 groove; Chrome plated stem; 1.5750" Head Dia., .3720" Stem Dia., 5.1560" O.A.L.
6	Exhaust	FP-R79625	3	1 groove; Chrome plated stem; 1.5750" Head Dia., .3750" Stem Dia., 5.1560" O.A.L.
6	Exhaust	FP-R79626	15	1 groove; Chrome plated stem; 1.5750" Head Dia., .3870" Stem Dia., 5.1560" O.A.L.
6	Exhaust	FP-R79627	30	1 groove; Chrome plated stem; 1.5750" Head Dia., .4020" Stem Dia., 5.1560" O.A.L.
24	Keeper	FP-41339		1 groove; Square cut key groove
24	Keeper	FP-T20077		1 groove; Square cut key groove; Hardened
24	Keeper, Bulk	VK-138B		1 groove; Square cut key groove; Carton of 1000
QTY	VALVE SEAT	PART NO.	SIZE	DESCRIPTION
6	Exh.	FP-R51734	STD	
6	Int.	FP-R73064	STD	
QTY	VALVE SPRING	PART NO.	SIZE	DESCRIPTION
12	Spring	FP-R26125		2.1200" Free Height
QTY	VALVE MISC.	PART NO.	SIZE	DESCRIPTION
12	Rotocap	FP-RE11410		Exh. & Int.
1	Bushing	FP-T26321		Lower
1	Bushing	FP-T20034		Upper
1	Oil Filler Cap Gasket	FP-R80135		Oil filler neck code 1201; From Ser. No. 607,181; L.H. Auxiliary drive
1	Oil Filler Cap Gasket	FP-T20328		Rocker arm cover code 1103; Oil filler neck codes 1201, 1202, 1203, 1206
QTY	VALVE SEAL	PART NO.	SIZE	DESCRIPTION
12	Valve Stem Seal	FP-R87627		Exh. & Int.; O-Ring type
QTY	ROCKER PARTS	PART NO.	SIZE	DESCRIPTION
1	O-Ring	FP-R56463		Rocker cover breather tube; Breather tube code 2901 R.H.; Codes 2902, 2903 L.H.; Codes 2905, 2909, 2915
ELECTRICAL				
QTY	ELECTRICAL	PART NO.	SIZE	DESCRIPTION
1	Starter to Block Gasket	FP-R53108		3-Hole mount; Starting motor codes 3002, 3011, 3013, 3016, 3017, 3018
QTY	ALTERNATOR	PART NO.	SIZE	DESCRIPTION
1	Ball Brg.	FP-JD9449		Front; Delco-Remy Nos. 1100490, 1103128, 1105175; Code 3103; 12 Volt, 72 amp alternator
1	Ball Brg.	FP-JD9449		Front; Delco-Remy Nos. 1100491, 1100580; Code 3102; 12 Volt, 55 amp alternator
1	Ball Brg.	FP-JD9449		Front; Delco-Remy Nos. 1102926, 1103124, 1105422; Code 3105; 12 Volt, 63 amp alternator
1	Ball Brg.	FP-JD9449		Front; Motorola Code 3104; 12 Volt, 30 amp alternator
2	Ball Brg.	FP-JD9449		Front & Rear; Code 3101; 65 amp alternator
2	Ball Brg.	FP-JD9449		Front & Rear; Code 3109; w/Auxiliary drive gear; 65 amp alternator
2	Ball Brg.	FP-JD9449		Front & Rear; Code 3117; 24 Volt, 45 amp alternator
2	Ball Brg.	FP-JD9449		Front & Rear; Motorola replacement; 12 Volt, 65 amp alternator
2	Ball Brg.	FP-JD9449		Front & Rear; Motorola No. 70D42179T02; 24 Volt, 45 amp alternator
INT & EXH MANIFOLDS				
QTY	INT. & EXH. MANIFOLDS	PART NO.	SIZE	DESCRIPTION
6	Exhaust Manifold Gasket	FP-R90658		
2	Air Intake Gasket	FP-R81275		
CAMSHAFT GROUP				
QTY	TIMING COVER	PART NO.	SIZE	DESCRIPTION
1	Timing Gear Cover Gasket	FP-T20273		Access cover

(continued on next page)





# John Deere Off Highway

Combine 6359D Eng. Cotton Picker 6359D Eng. Grader 6359D Eng. Wheel Tractor 6359D **85**  
Eng. (cont.)  
5.9L 359 OHV Diesel L6, 4.1875" Bore

CAMSHAFT GROUP (cont.)				
QTY	TIMING COVER (cont.)	PART NO.	SIZE	DESCRIPTION
1	Timing Gear Cover Gasket	FP-R97454		Front cover
QTY	CAMSHAFT/LIFTER	PART NO.	SIZE	DESCRIPTION
12	Lifter	FP-T20073		
FUEL SYSTEM & PARTS				
QTY	FUEL INJECTION	PART NO.	SIZE	DESCRIPTION
1	Injector Pump Gasket	FP-R125066		Gear cover
6	Fuel Injector Seal	FP-R79605		Fuel line connection; Nozzle marked 27333; 9.270MM X 13.600MM X 5.080MM
12	Washer	FP-T20055		Pump codes 1602, 1603
6	Fuel Injector Nut	FP-R79604		w/Injector marked 27333; From Ser. No. 410,664
12	Washer Type Seal	FP-R51936		Leak-off & return line seals; Nozzle codes 1602, 1603, 1619, 1624; w/Nozzle marked 27333
6	Washer Type Seal	FP-R48000		Lower; w/Nozzle marked 27333
6	Washer Type Seal	FP-R60746		Upper; w/Nozzle marked 27333
QTY	FUEL FILTERS & PUMP	PART NO.	SIZE	DESCRIPTION
1	Mechanical Fuel Pump	FP-RE42211		Transfer pump
1	Fuel Transfer Pump Gasket	FP-R97350		
COOLING SYSTEM				
QTY	WATER PUMP	PART NO.	SIZE	DESCRIPTION
1	Water Pump Impeller	FP-R47191		w/Pump housing marked R66420, R68733
1	Water Pump Impeller	FP-R56812		w/Pump housing marked R90783
1	Water Pump Repair/Rebuild Kit	FP-864340979		w/Pump housing marked R51661, R73606, R73724, R79171
1	Water Pump Repair/Rebuild Kit	FP-RE62661		w/Pump housing marked R66420, R68733
1	Water Pump Housing Gasket	FP-R56809		w/Pump housing marked R90783
1	Oil Seal Kit	FP-AR101549		Water Pump; w/Pump housing marked R90783
1	Water Pump Mounting Gasket	FP-T20243		w/Pump housing marked R56060, R56813, R70612, R78287, R86824, R90783, R99665
1	Shaft & Bearing Assembly	FP-JD8643		w/Pump housing marked R90783
QTY	THERMOSTAT	PART NO.	SIZE	DESCRIPTION
2	Thermostat	FP-AR48675		Thermostat code 2204; Thermostat cover code 2102 Vertical; Housing code 3901; 180 Deg.
1	Thermostat Gasket	FP-T20219		Thermostat housing code 3901
1	Thermostat Cover Gasket	FP-R54638		Thermostat cover codes 2102, 2108, 2111; Thermostat housing code 3901; w/Two thermostats
1	Therm. Hsg. - Water Mfld. Gsk	FP-R54641		Thermostat housing to cyl. head
2	O-Ring	FP-R56461		Thermostat housing tube seals; Housing codes 3901, 3904
ENGINE BLOCK & PARTS				
QTY	GASKETS	PART NO.	SIZE	DESCRIPTION
1	Flywheel Housing Gasket	FP-R97351		
1	Oil Pan Gasket	FP-R97344		
1	Oil Pan Gasket Set	FP-PG303PS		Oil pump codes 5001, 5002
1	Block to End Plate Front Gskt	FP-R131794		Front plate code 3601
QTY	GASKET SETS	PART NO.	SIZE	DESCRIPTION
1	In-Frame Gasket Set	FP-PG359S		
1	Complete Overhaul Gasket Set	FP-RE38858		Crankshaft seals not incl.
1	Complete Overhaul Gasket Set	FP-RE38858WS		Incl. crankshaft seals
QTY	OIL COOLERS & FILTERS	PART NO.	SIZE	DESCRIPTION
1	Washer	FP-R105714		Oil cooler; Modine Oil Cooler codes 5911, 5915
1	Rect. or Square Seal	FP-R70956		Cooler housing; Cooler codes 5904, 5906, 5911; Water pump codes 2004, 2008, 2023; To Ser. No. 198,385; 2.700" X 3.000" X .180"
CRANKSHAFT/OIL PUMP				
QTY	CRANKSHAFT	PART NO.	SIZE	DESCRIPTION
1	Crankshaft	FP-AT22562		
1	Oil Seal Kit	FP-SK67942		Incl. front & rear seals; Crankshaft code 4701; Crankshaft marked R108679
QTY	SEALS - FRONT CRANK	PART NO.	SIZE	DESCRIPTION
1	Crankshaft Front Seal	FP-AR67942		
1	O-Ring	FP-H35244		Crankshaft pulley; Crankshaft, Bearing code 4701; Crankshaft marked R108679, R60489, T23266

(continued on next page)

**85** Combine 6359D Eng. Cotton Picker 6359D Eng. Grader 6359D Eng. Wheel Tractor 6359D  
 (cont.) Eng.  
 5.9L 359 OHV Diesel L6, 4.1875" Bore

### CRANKSHAFT/OIL PUMP (cont.)

QTY	SEALS - REAR CRANK	PART NO.	SIZE	DESCRIPTION
1	Crankshaft Rear Seal	FP-RE24959		Crankshaft, Bearing code 4701; Flywheel housing codes 1403, 1404, 1405, 1410, 1411, 1420, 1422, 1425
QTY	MAIN BEARINGS	PART NO.	SIZE	DESCRIPTION
1	Main Set	FP-MBK3006	STD	w/Flanged thrust brg.
1	Main Set	FP-MBK300610	10	w/Flanged thrust brg.
1	Main Set	FP-MBK300620	20	w/Flanged thrust brg.
1	Main Set	FP-MBK300630	30	w/Flanged thrust brg.
6	Plain Main Brg.	FP-RE27352	STD	
6	Plain Main Brg.	FP-RE27353	10	
6	Plain Main Brg.	FP-RE27360	20	
6	Plain Main Brg.	FP-RE27368	30	
1	Flanged Main Brg.	FP-RE521350	STD	
1	Flanged Main Brg.	FP-RE526754	10	
1	Flanged Main Brg.	FP-RE527235	20	
1	Flanged Main Brg.	FP-RE527236	30	
4	Thrust Washer	FP-R78598	STD	
QTY	OIL PUMP	PART NO.	SIZE	DESCRIPTION
1	Pump Repair Kit	FP-RE55343		Pump code 5001; w/Pump housing marked R54615
1	O-Ring	FP-R61871		Oil pump inlet; Pump codes 5001, 5003, 5007; w/Pump housing marked R54615
1	O-Ring	FP-R74354		Oil pump outlet tube; Pump codes 5001, 5002; w/Pump housing marked R54615
1	Oil Filler Inlet Gasket	FP-R97352		Oil filler neck codes 1200, 1201, 1202, 1203, 1206, 1298, 1299
1	Oil Pump Seal Ring	FP-R79563		Oil pump outlet adapter; Pump code 5001; w/Pump marked R54629

### CYLINDER COMPONENTS

QTY	LINERS	PART NO.	SIZE	DESCRIPTION
6	Liner w/o Sealing Ring	FP-R116281		
6	Liner w/Sealing Rings	FP-RE500023		
6	Cylinder Kit Complete	FP-RE30250	STD	w/Con. Rod marked R51727, R80034
6	Cyl. Liner Sealing Ring Kit	FP-AR65507		
6	Sealing Ring, Liner	FP-R48767		Rectangle; Top
6	Sealing Ring, Liner	FP-R26121		Round; Middle
6	Sealing Ring	FP-SLR2520		Round; Bottom
QTY	PISTONS	PART NO.	SIZE	DESCRIPTION
6	Piston Body w/o Pin	FP-RE19282		
6	Piston Kit w/Pin & Retainers	FP-RE19282WP		
6	Pin	FP-R125754		1.38" pin dia.
12	Piston Pin Retainer	FP-M41029		For 1.38" pin dia.
6	Pin Bushing	FP-R55647		w/Con. Rod marked R51727, R80034; 1.3765" ID, 1.500" OD, 1.570" O.A.L.
6	Pin Bushing	FP-T23471		1.1896" ID, 1.313" OD, 1.570" O.A.L.
QTY	CONNECTING RODS & BRGS.	PART NO.	SIZE	DESCRIPTION
12	Con. Rod Bolt	FP-R80033		w/Con. Rod marked R51727, R80034; Torque-To-Yield bolt; Replacement recommended
12	Con. Rod Bolt	FP-R74194		w/Con. Rod marked T20007, R51727, R58979; Torque-To-Yield bolt; Replacement recommended
6	Rod Pair	FP-RE27348	STD	
6	Rod Pair	FP-RE27349	10	
6	Rod Pair	FP-RE27358	20	
6	Rod Pair	FP-RE27364	30	
QTY	PISTON RINGS	PART NO.	SIZE	DESCRIPTION
6	Ring Set Single Cylinder	FP-RE507852	STD	1-1/8, 1-3/32, 1-.136 (1 cyl. set)
6	Ring Set Single Cylinder	FP-RE66820	STD	1-1/8, 1-3/32, 1-.136 (1 cyl. set)

### KITS

QTY	OVERHAUL KIT	PART NO.	SIZE	DESCRIPTION
1	In-Frame Overhaul Kit	FP-359DIFK		w/Con. Rod marked R51727, R80034; Incl. Torque-To-Yield con. rod bolts
1	Complete Overhaul Kit	FP-359DOHK		w/Con. Rod marked R51727, R80034; Incl. front & rear seals; Crankshaft code 4701; Crankshaft marked R108679; Incl. Torque-To-Yield con. rod bolts



# John Deere Off Highway

Combine 6359T Eng. Cotton Picker 6359T Eng. Grader 6359T Eng. Loader 6359T Eng. 86  
 Wheel Tractor 6359T Eng. Loader Tractor 6359T Eng. Skidder 6359T Eng. Backhoe 6359T  
 Eng.  
 5.9L 359 OHV Turbo-Diesel L6, 4.1875" Bore

## CYL. HEAD & PARTS

QTY	GASKETS	PART NO.	SIZE	DESCRIPTION
1	Head Set	FP-RE38852		
QTY	VALVE	PART NO.	SIZE	DESCRIPTION
6	Intake	FP-R89219	STD	6359T Engs.; Optional Non-Stellite; 1 groove; Chrome plated stem; 1.8210" Head Dia., .3720" Stem Dia., 5.1560" O.A.L.
6	Intake	FP-R83071	STD	6359T Engs.; Stellite; 2 groove; Chrome plated stem; 1.8210" Head Dia., .3720" Stem Dia., 5.1660" O.A.L.
6	Intake	FP-R89223	3	6359T Engs.; Stellite; 2 groove; Chrome plated stem; 1.8210" Head Dia., .3750" Stem Dia., 5.1660" O.A.L.
6	Intake	FP-R89224	15	6359T Engs.; Stellite; 2 groove; Chrome plated stem; 1.8210" Head Dia., .3870" Stem Dia., 5.1660" O.A.L.
6	Exhaust	FP-R79624	STD	1 groove; Chrome plated stem; 1.5750" Head Dia., .3720" Stem Dia., 5.1560" O.A.L.
6	Exhaust	FP-R79625	3	1 groove; Chrome plated stem; 1.5750" Head Dia., .3750" Stem Dia., 5.1560" O.A.L.
6	Exhaust	FP-R79626	15	1 groove; Chrome plated stem; 1.5750" Head Dia., .3870" Stem Dia., 5.1560" O.A.L.
6	Exhaust	FP-R79627	30	1 groove; Chrome plated stem; 1.5750" Head Dia., .4020" Stem Dia., 5.1560" O.A.L.
24	Keeper	FP-41339		1 groove; Square cut key groove
24	Keeper	FP-T20077		1 groove; Square cut key groove; Hardened
24	Keeper, Bulk	VK-138B		1 groove; Square cut key groove; Carton of 1000
QTY	VALVE SPRING	PART NO.	SIZE	DESCRIPTION
12	Spring	FP-R26125		2.1200" Free Height
QTY	VALVE MISC.	PART NO.	SIZE	DESCRIPTION
12	Rotocap	FP-RE11410		Exh. & Int.
1	Oil Filler Cap Gasket	FP-R80135		Oil filler neck code 1201; From Ser. No. 607,181; L.H. Auxiliary drive
1	Oil Filler Cap Gasket	FP-T20328		Rocker arm cover code 1103; Oil filler neck code 1201; To Ser. No. 607,180; Oil filler neck codes 1202, 1203, 1206
1	Oil Filler Cap Gasket	FP-T20328		Rocker arm cover codes 1103, 1104
QTY	VALVE SEAL	PART NO.	SIZE	DESCRIPTION
12	Valve Stem Seal	FP-R87627		O-Ring type
QTY	ROCKER PARTS	PART NO.	SIZE	DESCRIPTION
1	O-Ring	FP-R56463		Aftercooled; Rocker cover breather tube; Breather tube codes 2902, 2905
1	O-Ring	FP-R56463		Rocker cover breather tube; Breather tube code 2901 R.H.; Codes 2902, 2903 L.H.; Codes 2905, 2909, 2915
ELECTRICAL				
QTY	ELECTRICAL	PART NO.	SIZE	DESCRIPTION
1	Starter to Block Gasket	FP-R53108		3-Hole mount; Starting motor codes 3002, 3011, 3013, 3016, 3017, 3018
QTY	ALTERNATOR	PART NO.	SIZE	DESCRIPTION
1	Ball Brg.	FP-JD9449		Front; Delco-Remy Nos. 1100490, 1103128, 1105175; Code 3103; 12 Volt, 72 amp alternator
1	Ball Brg.	FP-JD9449		Front; Delco-Remy Nos. 1100491, 1100580; Code 3102; 12 Volt, 55 amp alternator
1	Ball Brg.	FP-JD9449		Front; Delco-Remy Nos. 1102926, 1103124, 1105422; Code 3105; 12 Volt, 63 amp alternator
1	Ball Brg.	FP-JD9449		Front; Delco-Remy Nos. 1103128, 1105175; Code 3103; 12 Volt, 72 amp alternator
1	Ball Brg.	FP-JD9449		Front; Motorola Code 3104; 12 Volt, 30 amp alternator
2	Ball Brg.	FP-JD9449		Front & Rear; Code 3101; 65 amp alternator
2	Ball Brg.	FP-JD9449		Front & Rear; Code 3109; w/Auxiliary drive gear; 65 amp alternator
2	Ball Brg.	FP-JD9449		Front & Rear; Code 3117; 24 Volt, 45 amp alternator
2	Ball Brg.	FP-JD9449		Front & Rear; Motorola replacement; 12 Volt, 65 amp alternator
2	Ball Brg.	FP-JD9449		Front & Rear; Motorola No. 70D42179T02; 24 Volt, 45 amp alternator
INT & EXH MANIFOLDS				
QTY	INT. & EXH. MANIFOLDS	PART NO.	SIZE	DESCRIPTION
2	Air Intake Gasket	FP-R81275		

(continued on next page)

<b>86</b> Combine 6359T Eng. Cotton Picker 6359T Eng. Grader 6359T Eng. Loader 6359T Eng. (cont.) Wheel Tractor 6359T Eng. Loader Tractor 6359T Eng. Skidder 6359T Eng. Backhoe 6359T Eng. 5.9L 359 OHV Turbo-Diesel L6, 4.1875" Bore				
<b>CAMSHAFT GROUP</b>				
<b>QTY</b>	<b>TIMING COVER</b>	<b>PART NO.</b>	<b>SIZE</b>	<b>DESCRIPTION</b>
1	Timing Gear Cover Gasket	FP-R97454		6359T; Fuel pump to cover; Front cover
1	Timing Gear Cover Gasket	FP-T20273		6359T; Timing gear cover; Access cover
<b>QTY</b>	<b>CAMSHAFT/LIFTER</b>	<b>PART NO.</b>	<b>SIZE</b>	<b>DESCRIPTION</b>
12	Lifter	FP-T20073		
<b>FUEL SYSTEM &amp; PARTS</b>				
<b>QTY</b>	<b>FUEL INJECTION</b>	<b>PART NO.</b>	<b>SIZE</b>	<b>DESCRIPTION</b>
1	Injector Pump Gasket	FP-R125066		6359T Engs.; Gear cover
6	Fuel Injector Seal	FP-R79605		Fuel line connection; Nozzle marked 26992, 27337; 9.270MM X 13.600MM X 5.080MM
6	Fuel Injector Nut	FP-R79604		w/Injector marked 27333; From Ser. No. 410,664
12	Washer Type Seal	FP-R51936		Leak-off & return line seals; Nozzle codes 1602, 1603, 1621, 1624; w/Nozzle marked 26992, 27337; From Ser. No. 410,664
6	Washer Type Seal	FP-R48000		Lower; w/Nozzle marked 26992, 27337
6	Washer Type Seal	FP-R60746		Upper; w/Nozzle marked 26992, 27337; To Ser. No. 753,261
<b>QTY</b>	<b>TURBOCHARGER</b>	<b>PART NO.</b>	<b>SIZE</b>	<b>DESCRIPTION</b>
1	Turbocharger Oil Drain Gasket	FP-R105346		
1	Turbocharger Mounting Gasket	FP-R89879		
1	Turbocharger Oil Supply Gskt.	FP-R97348		Turbo code 6501
<b>COOLING SYSTEM</b>				
<b>QTY</b>	<b>WATER PUMP</b>	<b>PART NO.</b>	<b>SIZE</b>	<b>DESCRIPTION</b>
1	Water Pump Impeller	FP-R47191		w/Pump housing marked R66420, R68733
1	Water Pump Impeller	FP-R56812		w/Pump housing marked R90783
1	Water Pump Repair/Rebuild Kit	FP-864340979		w/Pump housing marked R51661, R73606, R73724, R79171
1	Water Pump Repair/Rebuild Kit	FP-RE62661		w/Pump housing marked R66420, R68733
1	Water Pump Housing Gasket	FP-R56809		w/Pump housing marked R90783
1	Oil Seal Kit	FP-AR101549		Water Pump; w/Pump housing marked R90783
1	Water Pump Mounting Gasket	FP-T20243		w/Pump housing marked R78287, R85023, R86824, R90783, R99665
1	Shaft & Bearing Assembly	FP-JD8643		w/Pump housing marked R90783
<b>QTY</b>	<b>THERMOSTAT</b>	<b>PART NO.</b>	<b>SIZE</b>	<b>DESCRIPTION</b>
2	Thermostat	FP-AR48675		Thermostat code 2204; Thermostat cover code 2102 Vertical; Housing code 3901; 180 Deg.
1	Thermostat Gasket	FP-T20219		Thermostat housing code 3901
1	Thermostat Cover Gasket	FP-R54638		Thermostat cover codes 2102, 2108, 2111; Thermostat housing codes 3901, 3904; w/Two thermostats
1	Therm. Hsg. - Water Mfld. Gsk	FP-R54641		Thermostat housing to cyl. head
2	O-Ring	FP-R56461		Thermostat housing tube seals; Housing code 3901
2	O-Ring	FP-R56461		Thermostat housing tube seals; Housing codes 3904, 3905
<b>ENGINE BLOCK &amp; PARTS</b>				
<b>QTY</b>	<b>GASKETS</b>	<b>PART NO.</b>	<b>SIZE</b>	<b>DESCRIPTION</b>
1	Flywheel Housing Gasket	FP-R97351		
1	Oil Pan Gasket Set	FP-PG303PS		Oil pump codes 5001, 5002
1	Block to End Plate Front Gskt	FP-R131794		Front plate code 3602
<b>QTY</b>	<b>GASKET SETS</b>	<b>PART NO.</b>	<b>SIZE</b>	<b>DESCRIPTION</b>
1	In-Frame Gasket Set	FP-PG359S		
1	Complete Overhaul Gasket Set	FP-RE38858		Crankshaft seals not incl.
1	Complete Overhaul Gasket Set	FP-RE38858WS		Incl. crankshaft seals
<b>QTY</b>	<b>OIL COOLERS &amp; FILTERS</b>	<b>PART NO.</b>	<b>SIZE</b>	<b>DESCRIPTION</b>
1	Washer	FP-R105714		Oil cooler; Modine Oil Cooler codes 5911, 5915
1	Rect. or Square Seal	FP-R70956		Cooler housing; Cooler code 5907; Water pump code 2023; To Ser. No. 795,106; 2.700" X 3.000" X .180"
1	Rect. or Square Seal	FP-R70956		Cooler housing; Cooler code 5907; Water pump codes 2004, 2008, 2023; To Ser. No. 498,385; 2.700" X 3.000" X .180"
1	Rect. or Square Seal	FP-R70956		Cooler housing; Cooler code 5911; Water pump codes 2004, 2008, 2023; From Ser. No. 795,107; 2.700" X 3.000" X .180"
<b>CRANKSHAFT/OIL PUMP</b>				
<b>QTY</b>	<b>CRANKSHAFT</b>	<b>PART NO.</b>	<b>SIZE</b>	<b>DESCRIPTION</b>
1	Oil Seal Kit	FP-SK67942		Incl. front & rear seals; Crankshaft code 4701; Crankshaft marked T23266
<b>QTY</b>	<b>SEALS - FRONT CRANK</b>	<b>PART NO.</b>	<b>SIZE</b>	<b>DESCRIPTION</b>
1	Crankshaft Front Seal	FP-AR67942		

(continued on next page)



# John Deere Off Highway

Combine **6359T Eng.** Cotton Picker **6359T Eng.** Grader **6359T Eng.** Loader **6359T Eng.** **86**  
 Wheel Tractor **6359T Eng.** Loader Tractor **6359T Eng.** Skidder **6359T Eng.** Backhoe **6359T** (cont.)  
**Eng.**  
 5.9L 359 OHV Turbo-Diesel L6, 4.1875" Bore

## CRANKSHAFT/OIL PUMP (cont.)

QTY	SEALS - FRONT CRANK (cont.)	PART NO.	SIZE	DESCRIPTION
1	O-Ring	FP-H35244		Crankshaft pulley; Crankshaft, Bearing code 4701; Crankshaft marked R108678, RE60489, T23266
QTY	SEALS - REAR CRANK	PART NO.	SIZE	DESCRIPTION
1	Crankshaft Rear Seal	FP-RE24959		Crankshaft, Bearing code 4701
1	Crankshaft Rear Seal	FP-RE24959		Flywheel housing codes 1403, 1404, 1405, 1410, 1411, 1420, 1422, 1425
QTY	MAIN BEARINGS	PART NO.	SIZE	DESCRIPTION
1	Main Set	FP-MBK3006	STD	w/Flanged thrust brg.
1	Main Set	FP-MBK300610	10	w/Flanged thrust brg.
1	Main Set	FP-MBK300620	20	w/Flanged thrust brg.
1	Main Set	FP-MBK300630	30	w/Flanged thrust brg.
6	Plain Main Brg.	FP-RE27352	STD	
6	Plain Main Brg.	FP-RE27353	10	
6	Plain Main Brg.	FP-RE27360	20	
6	Plain Main Brg.	FP-RE27368	30	
1	Flanged Main Brg.	FP-RE521350	STD	
1	Flanged Main Brg.	FP-RE526754	10	
1	Flanged Main Brg.	FP-RE527235	20	
1	Flanged Main Brg.	FP-RE527236	30	
QTY	OIL PUMP	PART NO.	SIZE	DESCRIPTION
1	O-Ring	FP-R61871		Oil pump inlet; Pump codes 5002, 5003
1	O-Ring	FP-R61871		Oil pump inlet; Pump codes 5004, 5007
1	O-Ring	FP-R74354		Oil pump outlet tube; Pump codes 5001, 5005; w/Pump housing marked R54615
1	Oil Filler Inlet Gasket	FP-R97352		Oil filler neck codes 1200, 1299; w/o filler neck cover gskt.
1	Oil Filler Inlet Gasket	FP-R97352		Oil filler neck codes 1201, 1202, 1203, 1206, 1298, 1299
1	Oil Pump Seal Ring	FP-R79563		Oil pump outlet adapter; Pump codes 5002, 5003, 5007; w/Pump marked R54629

## CYLINDER COMPONENTS

QTY	LINERS	PART NO.	SIZE	DESCRIPTION
6	Liner w/Sealing Rings	FP-RE500023		
6	Cylinder Kit Complete	FP-RE33115		w/Con. Rod marked R58979, R80032, R113612
QTY	PISTONS	PART NO.	SIZE	DESCRIPTION
6	Pin Bushing	FP-R57451		Pin dia. 1.62"; 1.621" ID, 1.813" OD, 1.370" O.A.L.
QTY	CONNECTING RODS & BRGS.	PART NO.	SIZE	DESCRIPTION
12	Con. Rod Bolt	FP-R80033		w/Con. Rod marked R58979, R80032, R113612; Torque-To-Yield bolt; Replacement recommended
6	Rod Pair	FP-RE27348	STD	
6	Rod Pair	FP-RE27349	10	
6	Rod Pair	FP-RE27358	20	
6	Rod Pair	FP-RE27364	30	
QTY	PISTON RINGS	PART NO.	SIZE	DESCRIPTION
6	Ring Set Single Cylinder	FP-RE507852	STD	1-1/8, 1-3/32, 1-.136 (1 cyl. set)
6	Ring Set Single Cylinder	FP-RE66820	STD	1-1/8, 1-3/32, 1-.136 (1 cyl. set)

## KITS

QTY	OVERHAUL KIT	PART NO.	SIZE	DESCRIPTION
1	In-Frame Overhaul Kit	FP-359TIFK		w/Con. Rod marked R58979, R80032, R113612; Incl. Torque-To-Yield con. rod bolts
1	Complete Overhaul Kit	FP-359TOHK		w/Con. Rod marked R58979, R80032, R113612; Incl. front & rear seals; Crankshaft code 4701; Crankshaft marked T23266; Incl. Torque-To-Yield con. rod bolts

Combine **6362G Eng.** Power Unit **6362G Eng.** Wheel Tractor **6362G Eng.** Loader Tractor **87**  
**6362G Eng.**  
 5.9L 362 OHV L6, 4.25" Bore

## CYL. HEAD & PARTS

QTY	GASKETS	PART NO.	SIZE	DESCRIPTION
1	Ventilator Pump Gasket	FP-R31340		

(continued on next page)

# John Deere Off Highway



**87** Combine 6362G Eng. Power Unit 6362G Eng. Wheel Tractor 6362G Eng. Loader Tractor  
 (cont.) 6362G Eng.  
 5.9L 362 OHV L6, 4.25" Bore

CYL. HEAD & PARTS (cont.)				
<b>QTY</b>	<b>VALVE</b>	<b>PART NO.</b>	<b>SIZE</b>	<b>DESCRIPTION</b>
24	Keeper	FP-41339		1 groove; Square cut key groove
24	Keeper	FP-T20077		1 groove; Square cut key groove; Hardened
24	Keeper, Bulk	VK-138B		1 groove; Square cut key groove; Carton of 1000
<b>QTY</b>	<b>VALVE SPRING</b>	<b>PART NO.</b>	<b>SIZE</b>	<b>DESCRIPTION</b>
12	Spring	FP-R26125		2.1200" Free Height
METERS				
<b>QTY</b>	<b>METERS</b>	<b>PART NO.</b>	<b>SIZE</b>	<b>DESCRIPTION</b>
1	Hour Meter Housing Gasket	FP-R26173		
1	Speed/Hour Meter Gasket	FP-R44853		From Ser. No. 282,363
CAMSHAFT GROUP				
<b>QTY</b>	<b>TIMING COVER</b>	<b>PART NO.</b>	<b>SIZE</b>	<b>DESCRIPTION</b>
1	Front Timing Cover Gasket	FP-R26084		
COOLING SYSTEM				
<b>QTY</b>	<b>WATER PUMP</b>	<b>PART NO.</b>	<b>SIZE</b>	<b>DESCRIPTION</b>
4	O-Ring	FP-T13119		Manifold bypass tubes
1	Shaft & Bearing Assembly	FP-JD9355		w/Pump housing marked R41313, R41317, R44116, R44119, R48742
<b>QTY</b>	<b>THERMOSTAT</b>	<b>PART NO.</b>	<b>SIZE</b>	<b>DESCRIPTION</b>
2	Thermostat Cover Gasket	FP-R42694		One hole
<b>QTY</b>	<b>MISCELLANEOUS</b>	<b>PART NO.</b>	<b>SIZE</b>	<b>DESCRIPTION</b>
2	Water Manifold Mounting Gskt.	FP-R88397		
ENGINE BLOCK & PARTS				
<b>QTY</b>	<b>GASKETS</b>	<b>PART NO.</b>	<b>SIZE</b>	<b>DESCRIPTION</b>
1	Oil Pan Gasket	FP-R49377		
1	Washer	FP-B3586R		Oil filter cover packing
<b>QTY</b>	<b>CAM BEARINGS</b>	<b>PART NO.</b>	<b>SIZE</b>	<b>DESCRIPTION</b>
1	Cam Set	FP-4R46903	STD	
4	Cam Brg.	FP-R46903	STD	
<b>QTY</b>	<b>OIL COOLERS &amp; FILTERS</b>	<b>PART NO.</b>	<b>SIZE</b>	<b>DESCRIPTION</b>
2	O-Ring	FP-B2762R		Cooler bypass tube; To Ser. No. 282,362
1	Oil Cooler Side-Upper Gasket	FP-R27951		
1	Oil Cooler Top Gasket	FP-R32123		
CRANKSHAFT/OIL PUMP				
<b>QTY</b>	<b>MAIN BEARINGS</b>	<b>PART NO.</b>	<b>SIZE</b>	<b>DESCRIPTION</b>
1	Main Set	FP-MBK3005	STD	Late Engs.
1	Main Set	FP-MBK300510	10	Late Engs.
1	Main Set	FP-MBK300520	20	Late Engs.
1	Main Set	FP-MBK300530	30	Late Engs.
1	Thrust Washer Set	FP-AR77747	STD	
<b>QTY</b>	<b>OIL PUMP</b>	<b>PART NO.</b>	<b>SIZE</b>	<b>DESCRIPTION</b>
1	O-Ring	FP-R495R		Ventilator tube; Smooth
1	Oil Filter Seal Ring	FP-R26163		Filter body; To Ser. No. 357,083
1	Oil Filter Housing Gasket	FP-R26354		
CYLINDER COMPONENTS				
<b>QTY</b>	<b>LINERS</b>	<b>PART NO.</b>	<b>SIZE</b>	<b>DESCRIPTION</b>
6	Sealing Ring, Liner	FP-112847		From Ser. No. 357,084
<b>QTY</b>	<b>PISTONS</b>	<b>PART NO.</b>	<b>SIZE</b>	<b>DESCRIPTION</b>
6	Pin Bushing	FP-3129YA20		1.252" ID, 1.3785" OD, 1.510" O.A.L.
<b>QTY</b>	<b>CONNECTING RODS &amp; BRGS.</b>	<b>PART NO.</b>	<b>SIZE</b>	<b>DESCRIPTION</b>
6	Rod Pair	FP-AR45723	STD	
6	Rod Pair	FP-AR46396	10	
6	Rod Pair	FP-AR46397	20	
6	Rod Pair	FP-AR46398	30	



# John Deere Off Highway

**Wheel Tractor 6362LP Eng. (LPG) 88**  
5.9L 362 OHV LPG L6, 4.25" Bore

<b>CYL. HEAD &amp; PARTS</b>				
<b>QTY</b>	<b>GASKETS</b>	<b>PART NO.</b>	<b>SIZE</b>	<b>DESCRIPTION</b>
1	Ventilator Pump Gasket	FP-R31340		
<b>METERS</b>				
<b>QTY</b>	<b>METERS</b>	<b>PART NO.</b>	<b>SIZE</b>	<b>DESCRIPTION</b>
1	Hour Meter Housing Gasket	FP-R26173		
1	Speed/Hour Meter Gasket	FP-R44853		From Ser. No. 282,363
<b>CAMSHAFT GROUP</b>				
<b>QTY</b>	<b>TIMING COVER</b>	<b>PART NO.</b>	<b>SIZE</b>	<b>DESCRIPTION</b>
1	Front Timing Cover Gasket	FP-R26084		
<b>COOLING SYSTEM</b>				
<b>QTY</b>	<b>WATER PUMP</b>	<b>PART NO.</b>	<b>SIZE</b>	<b>DESCRIPTION</b>
4	O-Ring	FP-T13119		Manifold bypass tubes
1	Shaft & Bearing Assembly	FP-JD9355		w/Pump housing marked R41313, R41317, R44116, R44119, R48742
<b>QTY</b>	<b>MISCELLANEOUS</b>	<b>PART NO.</b>	<b>SIZE</b>	<b>DESCRIPTION</b>
2	Water Manifold Mounting Gskt.	FP-R88397		
<b>ENGINE BLOCK &amp; PARTS</b>				
<b>QTY</b>	<b>GASKETS</b>	<b>PART NO.</b>	<b>SIZE</b>	<b>DESCRIPTION</b>
1	Washer	FP-B3586R		Oil filter cover packing
<b>QTY</b>	<b>OIL COOLERS &amp; FILTERS</b>	<b>PART NO.</b>	<b>SIZE</b>	<b>DESCRIPTION</b>
2	O-Ring	FP-B2762R		Cooler bypass tube; To Ser. No. 282,362
<b>CRANKSHAFT/OIL PUMP</b>				
<b>QTY</b>	<b>OIL PUMP</b>	<b>PART NO.</b>	<b>SIZE</b>	<b>DESCRIPTION</b>
1	O-Ring	FP-R495R		Ventilator tube; Smooth
1	Oil Filter Seal Ring	FP-R26163		Filter body; To Ser. No. 357,083
1	Oil Filter Housing Gasket	FP-R26354		

**Wheel Tractor 6362NG Eng. (Natural Gas) 89**  
5.9L 362 OHV NG L6, 4.25" Bore

<b>CYL. HEAD &amp; PARTS</b>				
<b>QTY</b>	<b>GASKETS</b>	<b>PART NO.</b>	<b>SIZE</b>	<b>DESCRIPTION</b>
1	Ventilator Pump Gasket	FP-R31340		
<b>METERS</b>				
<b>QTY</b>	<b>METERS</b>	<b>PART NO.</b>	<b>SIZE</b>	<b>DESCRIPTION</b>
1	Hour Meter Housing Gasket	FP-R26173		
1	Speed/Hour Meter Gasket	FP-R44853		From Ser. No. 282,363
<b>CAMSHAFT GROUP</b>				
<b>QTY</b>	<b>TIMING COVER</b>	<b>PART NO.</b>	<b>SIZE</b>	<b>DESCRIPTION</b>
1	Front Timing Cover Gasket	FP-R26084		
<b>COOLING SYSTEM</b>				
<b>QTY</b>	<b>WATER PUMP</b>	<b>PART NO.</b>	<b>SIZE</b>	<b>DESCRIPTION</b>
4	O-Ring	FP-T13119		Manifold bypass tubes
1	Shaft & Bearing Assembly	FP-JD9355		w/Pump housing marked R41313, R41317, R44116, R44119, R48742
<b>QTY</b>	<b>MISCELLANEOUS</b>	<b>PART NO.</b>	<b>SIZE</b>	<b>DESCRIPTION</b>
2	Water Manifold Mounting Gskt.	FP-R88397		
<b>ENGINE BLOCK &amp; PARTS</b>				
<b>QTY</b>	<b>GASKETS</b>	<b>PART NO.</b>	<b>SIZE</b>	<b>DESCRIPTION</b>
1	Oil Pan Gasket	FP-R49377		
<b>CRANKSHAFT/OIL PUMP</b>				
<b>QTY</b>	<b>OIL PUMP</b>	<b>PART NO.</b>	<b>SIZE</b>	<b>DESCRIPTION</b>
1	O-Ring	FP-R495R		Ventilator tube; Smooth
1	Oil Filter Seal Ring	FP-R26163		Filter body; To Ser. No. 357,083
1	Oil Filter Housing Gasket	FP-R26354		

# John Deere Off Highway



<b>90</b> <i>Wheel Tractor 720, 730 Engs.</i> 5.9L 362 OHV L2, 6" Bore				
<b>ELECTRICAL</b>				
<b>QTY</b>	<b>ALTERNATOR</b>	<b>PART NO.</b>	<b>SIZE</b>	<b>DESCRIPTION</b>
1	Ball Brg.	FP-JD9449		Front; Motorola; 12 Volt, 35 amp alternator, 55 amp alternator; To Ser. No. 282,362
<b>CAMSHAFT GROUP</b>				
<b>QTY</b>	<b>CAMSHAFT/LIFTER</b>	<b>PART NO.</b>	<b>SIZE</b>	<b>DESCRIPTION</b>
4	Lifter	FP-R52773		
<b>FUEL SYSTEM &amp; PARTS</b>				
<b>QTY</b>	<b>FUEL INJECTION</b>	<b>PART NO.</b>	<b>SIZE</b>	<b>DESCRIPTION</b>
1	Washer	FP-R40777		Ventilator pump housing
<b>ENGINE BLOCK &amp; PARTS</b>				
<b>QTY</b>	<b>CAM BEARINGS</b>	<b>PART NO.</b>	<b>SIZE</b>	<b>DESCRIPTION</b>
2	Cone Taper Brg.	FP-JD8135		Position 1-2
2	Cup Taper Brg.	FP-JD7438		Position 1-2
<b>CRANKSHAFT/OIL PUMP</b>				
<b>QTY</b>	<b>SEALS - FRONT CRANK</b>	<b>PART NO.</b>	<b>SIZE</b>	<b>DESCRIPTION</b>
1	Oil Seal	FP-3K9619		
<b>QTY</b>	<b>OIL PUMP</b>	<b>PART NO.</b>	<b>SIZE</b>	<b>DESCRIPTION</b>
2	O-Ring	FP-A4730R		Dipstick
<b>91</b> <i>Wheel Tractor 720, 730 Engs.</i> 5.9L 362 OHV Diesel L2, 6" Bore				
<b>ELECTRICAL</b>				
<b>QTY</b>	<b>ALTERNATOR</b>	<b>PART NO.</b>	<b>SIZE</b>	<b>DESCRIPTION</b>
1	Ball Brg.	FP-JD9449		Front; Motorola; 12 Volt, 35 amp alternator, 55 amp alternator; To Ser. No. 282,362
<b>METERS</b>				
<b>QTY</b>	<b>METERS</b>	<b>PART NO.</b>	<b>SIZE</b>	<b>DESCRIPTION</b>
1	Speed/Hour Meter Gasket	FP-R44853		From Ser. No. 282,363
<b>COOLING SYSTEM</b>				
<b>QTY</b>	<b>THERMOSTAT</b>	<b>PART NO.</b>	<b>SIZE</b>	<b>DESCRIPTION</b>
2	Thermostat Cover Gasket	FP-R42694		One hole
<b>CRANKSHAFT/OIL PUMP</b>				
<b>QTY</b>	<b>SEALS - FRONT CRANK</b>	<b>PART NO.</b>	<b>SIZE</b>	<b>DESCRIPTION</b>
1	Oil Seal	FP-3K9619		
<b>QTY</b>	<b>OIL PUMP</b>	<b>PART NO.</b>	<b>SIZE</b>	<b>DESCRIPTION</b>
2	O-Ring	FP-A4730R		Dipstick
<b>92</b> <i>Wheel Tractor 720, 730 Engs.</i> 6.2L 378 OHV L2, 6.125" Bore				
<b>ENGINE BLOCK &amp; PARTS</b>				
<b>QTY</b>	<b>CAM BEARINGS</b>	<b>PART NO.</b>	<b>SIZE</b>	<b>DESCRIPTION</b>
2	Cone Taper Brg.	FP-JD8135		Position 1-2
2	Cup Taper Brg.	FP-JD7438		Position 1-2
<b>CRANKSHAFT/OIL PUMP</b>				
<b>QTY</b>	<b>SEALS - FRONT CRANK</b>	<b>PART NO.</b>	<b>SIZE</b>	<b>DESCRIPTION</b>
1	Oil Seal	FP-3K9619		
<b>93</b> <i>Wheel Tractor 70 Eng.</i> 6.2L 380 OHV L2, 5.875" Bore				
<b>ENGINE BLOCK &amp; PARTS</b>				
<b>QTY</b>	<b>CAM BEARINGS</b>	<b>PART NO.</b>	<b>SIZE</b>	<b>DESCRIPTION</b>
2	Cone Taper Brg.	FP-JD8135		Position 1-2
2	Cup Taper Brg.	FP-JD7438		Position 1-2

(continued on next page)





# John Deere Off Highway

Wheel Tractor 70 Eng. 93  
6.2L 380 OHV L2, 5.875" Bore (cont.)

## CYLINDER COMPONENTS

QTY	CONNECTING RODS & BRGS.	PART NO.	SIZE	DESCRIPTION
2	Rod Pair	FP-2155SB	STD	

Power Unit 6381D Eng. Wheel Tractor 6381D Eng. 94  
6.2L 381 OHV Diesel L6, 4.125" Bore

## CYL. HEAD & PARTS

QTY	VALVE	PART NO.	SIZE	DESCRIPTION
6	Intake	FP-R26124	STD	1.7770" Head Dia., .3720" Stem Dia., 6.2580" O.A.L.
6	Exhaust	FP-R26123	STD	1.5900" Head Dia., .3720" Stem Dia., 6.2580" O.A.L.
6	Exhaust	FP-V4100	STD	1.5900" Head Dia., .3720" Stem Dia., 6.2580" O.A.L.
24	Keeper	FP-B367R		2 groove
24	Keeper	VK-66R		2 groove; Hardened
QTY	VALVE SEAT	PART NO.	SIZE	DESCRIPTION
6	Exh.	245-1625-1	Std Only	1.6300" OD, 1.3750" ID, .2160" Depth
QTY	VALVE GUIDE	PART NO.	SIZE	DESCRIPTION
12	Guide	FP-R28654		.3750" ID, 3.3130" O.A.L.
QTY	VALVE SPRING	PART NO.	SIZE	DESCRIPTION
12	Spring	FP-R26125		2.1200" Free Height
QTY	VALVE SEAL	PART NO.	SIZE	DESCRIPTION
12	Valve Stem Seal	ST-2004		Positive type; Installation requires valve guide machining; Rubber/PTFE
12	Valve Stem Seal Bulk	ST-2004BC		Positive type; Installation requires valve guide machining; Carton of 100; Rubber/PTFE

## ENGINE BLOCK & PARTS

QTY	CAM BEARINGS	PART NO.	SIZE	DESCRIPTION
1	Cam Set	FP-4R46903	STD	
4	Cam Brg.	FP-R46903	STD	

## CRANKSHAFT/OIL PUMP

QTY	SEALS - FRONT CRANK	PART NO.	SIZE	DESCRIPTION
1	Oil Seal Kit	FP-AR49025		
QTY	SEALS - REAR CRANK	PART NO.	SIZE	DESCRIPTION
1	Oil Seal	FP-RE22764		PTFE
QTY	MAIN BEARINGS	PART NO.	SIZE	DESCRIPTION
1	Main Set	FP-MBK400E6	STD	w/Flanged brg.
1	Main Set	FP-MBK400E610	10	w/Flanged brg.
1	Main Set	FP-MBK400E620	20	w/Flanged brg.
1	Main Set	FP-MBK400E630	30	w/Flanged brg.
1	Main Set	FP-MBK400L6	STD	w/Thrust washer; w/Block marked R40930, R40940
1	Main Set	FP-MBK400L610	10	w/Thrust washer; w/Block marked R40930, R40940
1	Main Set	FP-MBK400L620	20	w/Thrust washer; w/Block marked R40930, R40940
1	Main Set	FP-MBK400L630	30	w/Thrust washer; w/Block marked R40930, R40940
1	Thrust Washer Set	FP-AR77747	STD	

## CYLINDER COMPONENTS

QTY	LINERS	PART NO.	SIZE	DESCRIPTION
6	Liner w/o Sealing Ring	FP-R32050	STD	OVERBORE To 4.250"
6	Liner w/Sealing Rings	FP-R32050WS	STD	OVERBORE To 4.250"
6	Cylinder Kit Complete	FP-RE23173	STD	OVERBORE To 4.250"
6	Sealing Ring, Liner	FP-112847		OVERBORE To 4.250"
QTY	PISTONS	PART NO.	SIZE	DESCRIPTION
6	Piston Kit w/Pin & Retainers	FP-RE23172WP	STD	OVERBORE To 4.250"
6	Pin Bushing	FP-R30939		
6	Pin Bushing	FP-3129YA20		1.252" ID, 1.3785" OD, 1.510" O.A.L.
QTY	CONNECTING RODS & BRGS.	PART NO.	SIZE	DESCRIPTION
6	Rod Pair	FP-AR45723	STD	
6	Rod Pair	FP-AR46396	10	
6	Rod Pair	FP-AR46397	20	
6	Rod Pair	FP-AR46398	30	
QTY	PISTON RINGS	PART NO.	SIZE	DESCRIPTION
6	Ring Set Single Cylinder	FP-AR55630	STD	OVERBORE To 4.250"; 1-1/8, 1-3/32, 1-1/4 (1 cyl. set)
3	Premium Set	FP-AR55630S	STD	OVERBORE To 4.250"; 2-1/8, 2-3/32, 2-1/4 (2 cyl. set)

(continued on next page)

**94 Power Unit 6381D Eng. Wheel Tractor 6381D Eng.**  
(cont.) 6.2L 381 OHV Diesel L6, 4.125" Bore

**CYLINDER COMPONENTS (cont.)**

QTY	PISTON RINGS (cont.)	PART NO.	SIZE	DESCRIPTION
6	Premium Single Cylinder Set	W-9348KX +	Std Only	OVERBORE To 4.250"; 1-1/8, 1-3/32, 1-1/4 (2 cyl. set); When depleted use FP-AR55630

**KITS**

QTY	OVERHAUL KIT	PART NO.	SIZE	DESCRIPTION
1	Complete Overhaul Kit	FP-404DEOHK		OVERBORE To 4.250"; w/Flanged main brg.; Incl. Torque-To-Yield con. rod bolts

**95 Combine 6404D Eng. Power Unit JD404D, 6404D Engs. Wheel Tractor 6404D Eng. Loader Tractor 6404D Eng. Backhoe 6404D Eng.**  
6.6L 404 OHV Diesel L6 (Early), 4.25" Bore

**CYL. HEAD & PARTS**

QTY	GASKETS	PART NO.	SIZE	DESCRIPTION
1	Valve Cover Gasket	FP-R49866		
1	Head Gasket	FP-R45615		To Ser. No. 214,999
1	Head Gasket	FP-R48291		To Ser. No. 357,083
1	Head Set	FP-AR53630		From Ser. No. 215,000 to Ser. No. 335,845
1	Head Set	FP-AR63940		From Ser. No. 355,846
1	Head Set	FP-AR53625		Replacement Block; To Ser. No. 214,999
QTY	HEAD BOLTS	PART NO.	SIZE	DESCRIPTION
6	Head Bolt	FP-R88042		w/Block marked R40610, R43310, R45980, R47020, R47110, R47170, R48440, R49470, R49650, R59850, R72128; From Ser. No. 215,000; 3.250" length
5	Head Bolt	FP-R88043		w/Block marked R40610, R43310, R45980, R47020, R47110, R47170, R48440, R49470, R49650, R59850, R72128; From Ser. No. 215,000; 5.250" length
8	Head Bolt	FP-R88044		w/Block marked R40610, R43310, R45980, R47020, R47110, R47170, R48440, R49470, R49650, R59850, R72128; From Ser. No. 215,000; 6.250" length
7	Head Bolt	FP-R88045		w/Block marked R40610, R43310, R45980, R47020, R47110, R47170, R48440, R49470, R49650, R59850, R72128; From Ser. No. 215,000; 7.250" length
QTY	VALVE	PART NO.	SIZE	DESCRIPTION
6	Intake	FP-R43883	STD	From Ser. No. 215,000; 1 groove; Chrome plated stem; 1.9020" Head Dia., .3720" Stem Dia., 6.1510" O.A.L.
6	Intake	FP-R45003	3	From Ser. No. 215,000; 1 groove; Chrome plated stem; 1.9020" Head Dia., .3750" Stem Dia., 6.1510" O.A.L.
6	Intake	FP-R45005	30	From Ser. No. 215,000; 1 groove; Chrome plated stem; 1.9020" Head Dia., .4020" Stem Dia., 6.1510" O.A.L.
6	Intake	FP-R44174	STD	From Ser. No. 82,802 to Ser. No. 214,999; 2 groove; Chrome plated stem; 1.9020" Head Dia., .3720" Stem Dia., 6.2450" O.A.L.
6	Intake	FP-R26124	STD	To Ser. No. 82,801; 1.7770" Head Dia., .3720" Stem Dia., 6.2580" O.A.L.
6	Exhaust	FP-R43679	STD	From Ser. No. 215,000; 1 groove; Chrome plated stem; 1.7150" Head Dia., .3720" Stem Dia., 6.1330" O.A.L.
6	Exhaust	FP-R43787	3	From Ser. No. 215,000; 1 groove; Chrome plated stem; 1.7150" Head Dia., .3750" Stem Dia., 6.1330" O.A.L.
6	Exhaust	FP-R43788	15	From Ser. No. 215,000; 1 groove; Chrome plated stem; 1.7150" Head Dia., .3870" Stem Dia., 6.1330" O.A.L.
6	Exhaust	FP-R43789	30	From Ser. No. 215,000; 1 groove; Chrome plated stem; 1.7150" Head Dia., .4020" Stem Dia., 6.1330" O.A.L.
6	Exhaust	FP-R44175	STD	From Ser. No. 82,802 to Ser. No. 214,999; 2 groove; Chrome plated stem; 1.7150" Head Dia., .3720" Stem Dia., 6.2270" O.A.L.
6	Exhaust	FP-R26123	STD	To Ser. No. 82,801; 1.5900" Head Dia., .3720" Stem Dia., 6.2580" O.A.L.
24	Keeper	FP-T20077		From Ser. No. 215,000; 1 groove; Square cut key groove; Hardened
24	Keeper	FP-41339		Model JD600 From Ser. No. 215,000; 1 groove; Square cut key groove
24	Keeper	FP-B367R		Model JD600 To Ser. No. 214,999; 2 groove
24	Keeper	VK-66R		Model JD600 To Ser. No. 214,999; 2 groove; Hardened
24	Keeper	FP-B367R		Model 4020 To Ser. No. 200,999; 2 groove
24	Keeper	VK-66R		Model 4020 To Ser. No. 200,999; 2 groove; Hardened
24	Keeper	FP-41339		Models 4000, 4020 From Ser. No. 201,000; 1 groove; Square cut key groove
24	Keeper, Bulk	VK-138B		Model JD600 From Ser. No. 215,000; 1 groove; Square cut key groove; Carton of 1000

(continued on next page)

+ Superseded Part Number



# John Deere Off Highway

Combine 6404D Eng. Power Unit JD404D, 6404D Engs. Wheel Tractor 6404D Eng. Loader 95 Tractor 6404D Eng. Backhoe 6404D Eng. (cont.)  
6.6L 404 OHV Diesel L6 (Early), 4.25" Bore

## CYL. HEAD & PARTS (cont.)

QTY	VALVE (cont.)	PART NO.	SIZE	DESCRIPTION
24	Keeper, Bulk	VK-138B		Models 4000, 4020 From Ser. No. 201,000; 1 groove; Square cut key groove; Carton of 1000
6	Exh.	FP-R43681	STD	1.7555" OD, 1.5000" ID, .2480" Depth
6	Int.	FP-R43680	STD	
6	Int.	FP-R82508	10	1.7650" OD, 1.5000" ID, .2160" Depth
12	VALVE GUIDE Guide	FP-R28654		Exh. & Int.; To Ser. No. 214,999; .3750" ID, 3.3130" O.A.L.
12	VALVE SPRING Spring	FP-R26125		2.1200" Free Height
6	VALVE MISC. Rotocap	FP-RE11410		Exh.; From Ser. No. 215,000
1	Oil Filler Cap Gasket	FP-T20328		Rocker arm cover code 1101
6	VALVE SEAL Valve Stem Seal	ST-2011		Int.; Model JD600 To Ser. No. 214,999; Positive type; Rubber/PTFE
6	Valve Stem Seal	ST-2011		Int.; Model 4020 To Ser. No. 200,999; Positive type; Rubber/PTFE
6	Valve Stem Seal Bulk	ST-2011BC		Int.; Model JD600 To Ser. No. 214,999; Positive type; Carton of 100; Rubber/PTFE
6	Valve Stem Seal Bulk	ST-2011BC		Int.; Model 4020 To Ser. No. 200,999; Positive type; Carton of 100; Rubber/PTFE

## ELECTRICAL

QTY	ELECTRICAL	PART NO.	SIZE	DESCRIPTION
1	Starter to Block Gasket	FP-R53108		3-Hole mount; Starting motor code 3004
1	ALTERNATOR Ball Brg.	FP-JD9449		Front; Motorola; 12 Volt, 35 amp alternator, 72 amp alternator; To Ser. No. 357,083

## METERS

QTY	METERS	PART NO.	SIZE	DESCRIPTION
1	Hour Meter Housing Gasket	FP-R26173		To Ser. No. 357,083
1	Speed/Hour Meter Gasket	FP-R62410		To Ser. No. 357,083

## INT & EXH MANIFOLDS

QTY	INT. & EXH. MANIFOLDS	PART NO.	SIZE	DESCRIPTION
2	Exhaust Manifold Gasket	FP-R83021		One Exh. hole
2	Exhaust Manifold Gasket	FP-R83020		Two Exh. holes
3	Intake Manifold Gasket	FP-R26297		From Ser. No. 357,084; w/Int. manifold R46411, AR45275
3	Intake Manifold Gasket	FP-R26297		To Ser. No. 357,083; w/Int. manifolds R46411, AR45275
1	Cyl. Block Valley Cover Gskt.	FP-R46192		From Ser. No. 215,000 to Ser. No. 335,845
1	Cyl. Block Valley Cover Gskt.	FP-R46192		Replacement Block; To Ser. No. 214,999

## CAMSHAFT GROUP

QTY	TIMING COVER	PART NO.	SIZE	DESCRIPTION
1	Crankshaft Front Cover Gasket	FP-R26058		
1	Timing Gear Cover Gasket	FP-R50390		Access cover
1	Timing Gear Cover Gasket	FP-R50353		From Ser. No. 357,084
1	Timing Gear Cover Gasket	FP-R46984		Housing to block
1	Front Timing Cover Gasket	FP-R26084		From Ser. No. 357,084
1	Front Timing Cover Gasket	FP-R46158		To Ser. No. 357,083
1	CAMSHAFT/LIFTER Camshaft	FP-R71530		From Ser. No. 215,000; w/Camshaft marked R65565, R71530
1	Camshaft Plug	FP-R26115		
12	Lifter	FP-R52773		From Ser. No. 215,000
12	Lifter	FP-R26342		To Ser. No. 214,999
1	Prelube	55-400		4 oz. bottle; 1.5 oz. packet No. 55-403 also avail.
1	CAMSHAFT KIT Cam/Lifter Kit	FP-AR100386		Cam marked R65565, R71530; From Ser. No. 215,000; Incl. (12) FP-R52773, (1) FP-R71530

## FUEL SYSTEM & PARTS

QTY	FUEL INJECTION	PART NO.	SIZE	DESCRIPTION
12	Washer	FP-R48693		Inj. leak-off screw; From Ser. No. 357,084

(continued on next page)

**95** Combine 6404D Eng. Power Unit JD404D, 6404D Engs. Wheel Tractor 6404D Eng. Loader  
 (cont.) Tractor 6404D Eng. Backhoe 6404D Eng.  
 6.6L 404 OHV Diesel L6 (Early), 4.25" Bore

FUEL SYSTEM & PARTS (cont.)				
QTY	FUEL INJECTION (cont.)	PART NO.	SIZE	DESCRIPTION
6	Washer	FP-R64840		Injector nozzle; From Ser. No. 500,000; Steel
21	Clamp	FP-R34766		Pump code 1602; From Ser. No. 500,000
12	Clamp	FP-R34766		Pump codes 1602, 1603; To Ser. No. 499,999
6	Fuel Line Connector Gasket	FP-R59294		Leak-off connector washer; From Ser. No. 500,000; Alum.
QTY	FUEL FILTERS & PUMP	PART NO.	SIZE	DESCRIPTION
1	Mechanical Fuel Pump	FP-RE42211		From Ser. No. 82,802 to Ser. No. 422,385; Transfer pump
1	Mechanical Fuel Pump	FP-RE43273		From Ser. No. 90,999
1	Mechanical Fuel Pump	FP-AR57264		To Ser. No. 82,801
1	O-Ring	FP-R26286		Filter line to pump
6	O-Ring	FP-R51603		Fuel nozzle; From Ser. No. 500,000
COOLING SYSTEM				
QTY	WATER PUMP	PART NO.	SIZE	DESCRIPTION
1	Water Pump Impeller	FP-R40979		w/Pump housing marked R41315, R44122; To Ser. No. 357,083
1	Water Pump Repair/Rebuild Kit	FP-AR55617		w/Pump housing marked R26337, R27547
1	Water Pump Repair/Rebuild Kit	FP-AR98564		w/Pump housing marked R34964
1	Water Pump Housing Gasket	FP-R50410		w/Pump housing marked R51683
1	Water Pump Spacer Gasket	FP-R42406		w/Pump housing marked R51683
4	O-Ring	FP-T13119		Manifold bypass tubes
1	Shaft & Bearing Assembly	FP-JD9212		w/Pump housing marked R26377, R27547, R34977, R34982; To Ser. No. 214,999
1	Shaft & Bearing Assembly	FP-JD9355		w/Pump housing marked R41315, R41318, R44122, R48743; To Ser. No. 357,083
1	Shaft & Bearing Assembly	FP-JD9257		w/Pump housing marked R51683
QTY	THERMOSTAT	PART NO.	SIZE	DESCRIPTION
2	Thermostat	FP-R36846		w/Housing marked R41853, R42664; 180 Deg. to 200 Deg. range
2	Thermostat Cover Gasket	FP-R42694		One hole
1	Thermostat Cover Gasket	FP-R46479		Two hole
QTY	MISCELLANEOUS	PART NO.	SIZE	DESCRIPTION
2	Water Manifold Mounting Gskt.	FP-R88397		From Ser. No. 357,083
1	Cyl. Block Water Hole Cvr Gsk	FP-R43595		Cyl. head water opening cover gskt.
ENGINE BLOCK & PARTS				
QTY	GASKETS	PART NO.	SIZE	DESCRIPTION
1	Oil Pan Gasket	FP-R71918		
1	Oil Pan Gasket	FP-R49377		From Ser. No. 357,084
1	Washer	FP-B3586R		Oil filter cover packing; To Ser. No. 357,083
QTY	GASKET SETS	PART NO.	SIZE	DESCRIPTION
1	In-Frame Gasket Set	FP-PG404DLS		From Ser. No. 215,000
1	In-Frame Gasket Set	FP-PG404DMS		From Ser. No. 215,000 to Ser. No. 335,845
1	In-Frame Gasket Set	FP-PG404DES		To Ser. No. 214,999
1	Complete Overhaul Gasket Set	FP-AR53631		From Ser. No. 215,000 to Ser. No. 335,845; Crankshaft seals not incl.
1	Complete Overhaul Gasket Set	FP-AR53631WS		From Ser. No. 215,000 to Ser. No. 335,845; Incl. Crankshaft seals
1	Complete Overhaul Gasket Set	FP-AR63938		From Ser. No. 335,846; Crankshaft seals not incl.
1	Complete Overhaul Gasket Set	FP-AR63938WS		From Ser. No. 335,846; Incl. Crankshaft seals
1	Complete Overhaul Gasket Set	FP-AR53626		Replacement Block; To Ser. No. 214,999; Crankshaft seals not incl.
1	Complete Overhaul Gasket Set	FP-AR53626WS		Replacement Block; To Ser. No. 214,999; Incl. Crankshaft seals
QTY	CAM BEARINGS	PART NO.	SIZE	DESCRIPTION
1	Cam Set	FP-4R46903	STD	
4	Cam Brg.	FP-R46903	STD	
QTY	OIL COOLERS & FILTERS	PART NO.	SIZE	DESCRIPTION
1	Oil Cooler	FP-AR55394		From Ser. No. 335,846
1	Oil Cooler Installation Kit	FP-58952		From Ser. No. 357,084
2	Oil Cooler Gasket	FP-R27948		To Ser. No. 357,083
2	O-Ring	FP-B2762R		Cooler bypass tube; To Ser. No. 357,083
1	Oil Cooler Base Hsg. Gasket	FP-R34110		From Ser. No. 215,000 to Ser. No. 335,845
1	Oil Cooler Base Hsg. Gasket	FP-R34110		Replacement Block; To Ser. No. 214,999
1	Oil Cooler Base Gasket	FP-R34109		From Ser. No. 215,000 to Ser. No. 335,845
1	Oil Cooler Base Gasket	FP-R34109		Replacement Block; To Ser. No. 214,999
1	Oil Cooler Cover Gasket	FP-R50419		
2	Oil Cooler Side-Upper Gasket	FP-R27951		To Ser. No. 357,083
1	Oil Cooler Top Gasket	FP-R32123		To Ser. No. 357,083
1	Oil Cooler to Filter Gasket	FP-R43558		To Ser. No. 357,083

(continued on next page)



# John Deere Off Highway

Combine 6404D Eng. Power Unit JD404D, 6404D Engs. Wheel Tractor 6404D Eng. Loader 95  
Tractor 6404D Eng. Backhoe 6404D Eng. (cont.)  
6.6L 404 OHV Diesel L6 (Early), 4.25" Bore

## CRANKSHAFT/OIL PUMP

QTY	CRANKSHAFT	PART NO.	SIZE	DESCRIPTION
1	Crankshaft	FP-RE53422		Gears incl.
1	Crankshaft	FP-AR96189		Gears not incl.
1	Oil Seal Kit	FP-SK49025		Incl. front & rear seals
QTY	SEALS - FRONT CRANK	PART NO.	SIZE	DESCRIPTION
1	Oil Seal Kit	FP-AR49025		
QTY	SEALS - REAR CRANK	PART NO.	SIZE	DESCRIPTION
1	Oil Seal	FP-RE22764		PTFE
QTY	MAIN BEARINGS	PART NO.	SIZE	DESCRIPTION
1	Main Set	FP-MBK400L4	STD	From Ser. No. 215,000; w/5 main brgs.
1	Main Set	FP-MBK400L410	10	From Ser. No. 215,000; w/5 main brgs.
1	Main Set	FP-MBK400L420	20	From Ser. No. 215,000; w/5 main brgs.
1	Main Set	FP-MBK400L6	STD	From Ser. No. 215,000; w/7 main brgs.
1	Main Set	FP-MBK400L610	10	From Ser. No. 215,000; w/7 main brgs.
1	Main Set	FP-MBK400L620	20	From Ser. No. 215,000; w/7 main brgs.
1	Main Set	FP-MBK400L630	30	From Ser. No. 215,000; w/7 main brgs.
1	Main Set	FP-MBK400E6	STD	To Ser. No. 214,999; w/Flanged brg.
1	Main Set	FP-MBK400E610	10	To Ser. No. 214,999; w/Flanged brg.
1	Main Set	FP-MBK400E620	20	To Ser. No. 214,999; w/Flanged brg.
1	Main Set	FP-MBK400E630	30	To Ser. No. 214,999; w/Flanged brg.
6	Plain Main Brg.	FP-AR74814	STD	From Ser. No. 215,000
6	Plain Main Brg.	FP-AR74816	10	From Ser. No. 215,000
6	Plain Main Brg.	FP-AR74817	20	From Ser. No. 215,000
6	Plain Main Brg.	FP-AR74818	30	From Ser. No. 215,000
6	Plain Main Brg.	FP-AR49243	STD	To Ser. No. 214,999
6	Plain Main Brg.	FP-AR49245	10	To Ser. No. 214,999
6	Plain Main Brg.	FP-AR49246	20	To Ser. No. 214,999
6	Plain Main Brg.	FP-AR49247	30	To Ser. No. 214,999
1	Flanged Main Brg.	FP-AR77748	STD	
1	Flanged Main Brg.	FP-AR77750	10	
1	Flanged Main Brg.	FP-AR77751	20	
1	Flanged Main Brg.	FP-AR77752	30	
1	Flanged Main Brg.	FP-AR49242	STD	Flanged; To Ser. No. 214,999
1	Flanged Main Brg.	FP-AR49238	10	Flanged; To Ser. No. 214,999
1	Flanged Main Brg.	FP-AR49239	20	Flanged; To Ser. No. 214,999
1	Flanged Main Brg.	FP-AR49240	30	Flanged; To Ser. No. 214,999
1	Flanged Main Brg.	FP-AR77754	STD	Flangeless; To Ser. No. 214,999
1	Flanged Main Brg.	FP-AR77756	10	Flangeless; To Ser. No. 214,999
1	Flanged Main Brg.	FP-AR77757	20	Flangeless; To Ser. No. 214,999
1	Flanged Main Brg.	FP-AR77758	30	Flangeless; To Ser. No. 214,999
1	Thrust Washer Set	FP-AR77747	STD	Use w/Flangeless main brg.
QTY	OIL PUMP	PART NO.	SIZE	DESCRIPTION
1	Oil Pump Spring	FP-R26151		
1	O-Ring	FP-A4730R		To Ser. No. 357,083; Dip stick seal
1	O-Ring	FP-R59343		Ventilator tube seal; Rocker cover codes 1101, 1102; Grooved
1	O-Ring	FP-R495R		Ventilator tube seal; Rocker cover codes 1101, 1102; Smooth
1	Oil Pump Cover Gasket	FP-R52049		Int. gskt.
1	Rect. or Square Seal	FP-R43660		Filter to housing
1	Oil Filter Seal Ring	FP-R26163		Filter body; To Ser. No. 357,083
1	Bypass Body to Cyl. Gasket	FP-R34753		To Ser. No. 357,083
1	Oil Filter Housing Gasket	FP-R26354		
1	Oil Filter to Block Gasket	FP-R43774		w/Filter body marked R54561, R59483, R62110
CYLINDER COMPONENTS				
QTY	LINERS	PART NO.	SIZE	DESCRIPTION
6	Liner w/o Sealing Ring	FP-R40615	STD	From Ser. No. 215,000
6	Liner w/o Sealing Ring	FP-R40615	STD	Replacement Block; To Ser. No. 214,999
6	Liner w/o Sealing Ring	FP-R32050	STD	To Ser. No. 214,999
6	Liner w/Sealing Rings	FP-R40615WS	STD	Model JD404 From Ser. No. 215,000
6	Liner w/Sealing Rings	FP-R40615WS	STD	Model JD600 From Ser. No. 215,000
6	Liner w/Sealing Rings	FP-R32050WS	STD	Models JD404, JD600 To Ser. No. 214,999
6	Liner w/Sealing Rings	FP-R40615WS	STD	Models 4000, 4020 From Ser. No. 201,000
6	Liner w/Sealing Rings	FP-R32050WS	STD	Models 4000, 4020 To Ser. No. 200,999
6	Cylinder Kit Complete	FP-RE23173	STD	w/Block marked R26070, R33180, R34340, R40890, R40900; w/Con. Rod marked R26047, R52225, R58880, R66923; To Ser. No. 214,999
6	Cylinder Kit Complete	FP-LKRE23163	STD	w/Block marked R26070, R33180, R34340, R40890, R40900; To Ser. No. 214,999; High Ring

(continued on next page)

**95** Combine 6404D Eng. Power Unit JD404D, 6404D Engs. Wheel Tractor 6404D Eng. Loader  
 (cont.) Tractor 6404D Eng. Backhoe 6404D Eng.  
 6.6L 404 OHV Diesel L6 (Early), 4.25" Bore

## CYLINDER COMPONENTS (cont.)

QTY	LINERS (cont.)	PART NO.	SIZE	DESCRIPTION
6	Cylinder Kit Complete	FP-RE23165	STD	w/Block marked R40610, R43310, R45980, R47020, R47110, R47170, R48440; w/Con. Rod marked R26047, R52225, R58880, R66923; From Ser. No. 215,000 to Ser. No. 335,845
6	Cylinder Kit Complete	FP-RE23160	STD	w/Block marked R49470, R49650, R59850, R72128; w/Con. Rod marked R26047, R52225, R58880, R66923; From Ser. No. 335,846
6	Cylinder Kit Complete	FP-RE23170	STD	Replacement Block; w/Block marked R40930; w/Con. Rod marked R26047, R52225, R58880, R66923; To Ser. No. 214,999
6	Cyl. Liner Sealing Ring Kit	FP-AR65507		From Ser. No. 215,000
6	Cyl. Liner Sealing Ring Kit	FP-AR65507		Replacement Block; To Ser. No. 214,999
6	Cyl. Liner Sealing Ring Kit	FP-AR40155		To Ser. No. 214,999
6	Sealing Ring, Liner	FP-R48767		From Ser. No. 215,000 to Ser. No. 335,845; Rectangle; Top
6	Sealing Ring, Liner	FP-R26121		From Ser. No. 215,000 to Ser. No. 335,845; Round; Middle
6	Sealing Ring, Liner	FP-R48767		From Ser. No. 335,846; Rectangle; Top
6	Sealing Ring, Liner	FP-R26121		From Ser. No. 335,846; Round; Middle
6	Sealing Ring, Liner	FP-112847		From Ser. No. 357,084
6	Sealing Ring, Liner	FP-R48767		Replacement Block; To Ser. No. 214,999; Rectangle; Top
6	Sealing Ring, Liner	FP-R26121		Replacement Block; To Ser. No. 214,999; Round; Middle
6	Sealing Ring	FP-SLR2520		From Ser. No. 215,000; Round; Bottom
6	Sealing Ring	FP-SLR2378		Rectangle
6	Sealing Ring	FP-SLR2520		Replacement Block; To Ser. No. 214,999; Round; Bottom
QTY	PISTONS	PART NO.	SIZE	DESCRIPTION
6	Piston Body w/o Pin	FP-RE23168		From Ser. No. 215,000
6	Piston Body w/o Pin	FP-RE23163		From Ser. No. 335,846; High Ring
6	Piston Body w/o Pin	FP-RE23172		Replacement Block; To Ser. No. 214,999
6	Piston Kit w/Pin & Retainers	FP-RE23168WP	STD	From Ser. No. 215,000
6	Piston Kit w/Pin & Retainers	FP-RE23163WP	STD	From Ser. No. 335,846; High Ring
6	Piston Kit w/Pin & Retainers	FP-RE23172WP	STD	Replacement Block; To Ser. No. 214,999
6	Pin	FP-R44161		Replacement Block; To Ser. No. 214,999
12	Piston Pin Retainer	FP-H80753		
6	Pin Bushing	FP-R30939		w/Con. Rod marked R26047, R52225, R58880, R69923
QTY	CONNECTING RODS & BRGS.	PART NO.	SIZE	DESCRIPTION
12	Con. Rod Bolt	FP-R66452		w/Con. Rod marked R26047, R52225, R58880, R66923; Torque-To-Yield bolt; Replacement recommended
6	Rod Pair	FP-AR45723	STD	
6	Rod Pair	FP-AR46396	10	
6	Rod Pair	FP-AR46397	20	
6	Rod Pair	FP-AR46398	30	
QTY	PISTON RINGS	PART NO.	SIZE	DESCRIPTION
6	Ring Set Single Cylinder	FP-AR65502	STD	From Ser. No. 335,846; 1-1/8, 1-3/32, 1-3/16 (1 cyl. set)
6	Ring Set Single Cylinder	FP-AR55630	STD	To Ser. No. 214,999; 1-1/8, 1-3/32, 1-1/4 (1 cyl. set)
6	Ring Set Single Cylinder	FP-AR51741	STD	2-5/32, 1-3/16 (1 cyl. set)
3	Premium Set	FP-AR55630S	STD	Check piston grooving before supplying ring set; 2-1/8, 2-3/32, 2-1/4 (2 cyl. set)
6	Premium Single Cylinder Set	W-9348KX + Std Only		Check piston grooving before supplying ring set; 1-1/8, 1-3/32, 1-1/4 (2 cyl. set); When depleted use FP-AR55630
KITS				
QTY	OVERHAUL KIT	PART NO.	SIZE	DESCRIPTION
1	In-Frame Overhaul Kit	FP-404DEIFK		w/Block marked R26070, R33180, R34340, R40890, R40900; w/Con. Rod marked R26047, R52225, R58880, R66923; To Ser. No. 214,999; Incl. Torque-To-Yield con. rod bolts
1	In-Frame Overhaul Kit	FP-404DMIFK		w/Block marked R40610, R43310, R45980, R47020, R47110, R47170, R48440; w/Con. Rod marked R26047, R52225, R58880, R66923; From Ser. No. 215,000 to Ser. No. 335,845; Incl. Torque-To-Yield con. rod bolts
1	In-Frame Overhaul Kit	FP-404DLIFK		w/Block marked R49470, R49650, R59850, R72128; w/Con. Rod marked R26047, R52225, R58880, R66923; From Ser. No. 335,846; Incl. Torque-To-Yield con. rod bolts
1	In-Frame Overhaul Kit	FP-404DRBIFK		Replacement Block; w/Block marked R40930; w/Con. Rod marked R26047, R52225, R58880, R66923; To Ser. No. 214,999; Incl. Torque-To-Yield con. rod bolts
1	Complete Overhaul Kit	FP-404DEOHK		w/Block marked R26070, R33180, R34340, R40890, R40900; w/Con. Rod marked R26047, R52225, R58880, R66923; To Ser. No. 214,999; Incl. Torque-To-Yield con. rod bolts

(continued on next page)



# John Deere Off Highway

**Combine 6404D Eng. Power Unit JD404D, 6404D Engs. Wheel Tractor 6404D Eng. Loader 95  
Tractor 6404D Eng. Backhoe 6404D Eng. (cont.)  
6.6L 404 OHV Diesel L6 (Early), 4.25" Bore**

### KITS (cont.)

QTY	OVERHAUL KIT (cont.)	PART NO.	SIZE	DESCRIPTION
1	Complete Overhaul Kit	FP-404DMOHK		w/Block marked R40610, R43310, R45980, R47020, R47110, R47170, R48440; w/Con. Rod marked R26047, R52225, R58880, R66923; From Ser. No. 215,000 to Ser. No. 335,845; Incl. Torque-To-Yield con. rod bolts
1	Complete Overhaul Kit	FP-404DLOHK		w/Block marked R49470, R49650, R59850, R72128; w/Con. Rod marked R26047, R52225, R58880, R66923; From Ser. No. 335,846; Incl. Torque-To-Yield con. rod bolts
1	Complete Overhaul Kit	FP-404DRBOHK		Replacement Block; w/Block marked R40930; w/Con. Rod marked R26047, R52225, R58880, R66923; To Ser. No. 214,999; Incl. Torque-To-Yield con. rod bolts

**Combine 6404D Eng. Harvester 6404D Eng. Power Unit JD404D, 6404D Engs. Wheel 96  
Tractor 6404D Eng. Loader Tractor 6404D Eng.  
6.6L 404 OHV Diesel L6 (Late), 4.25" Bore**

### CYL. HEAD & PARTS

QTY	VALVE	PART NO.	SIZE	DESCRIPTION
6	Intake	FP-R43883	STD	1 groove; Chrome plated stem; 1.9020" Head Dia., .3720" Stem Dia., 6.1510" O.A.L.
6	Intake	FP-R45003	3	1 groove; Chrome plated stem; 1.9020" Head Dia., .3750" Stem Dia., 6.1510" O.A.L.
6	Intake	FP-R45005	30	1 groove; Chrome plated stem; 1.9020" Head Dia., .4020" Stem Dia., 6.1510" O.A.L.
6	Exhaust	FP-R43679	STD	1 groove; Chrome plated stem; 1.7150" Head Dia., .3720" Stem Dia., 6.1330" O.A.L.
6	Exhaust	FP-R43787	3	1 groove; Chrome plated stem; 1.7150" Head Dia., .3750" Stem Dia., 6.1330" O.A.L.
6	Exhaust	FP-R43788	15	1 groove; Chrome plated stem; 1.7150" Head Dia., .3870" Stem Dia., 6.1330" O.A.L.
6	Exhaust	FP-R43789	30	1 groove; Chrome plated stem; 1.7150" Head Dia., .4020" Stem Dia., 6.1330" O.A.L.
24	Keeper	FP-41339		1 groove; Square cut key groove
24	Keeper	FP-T20077		1 groove; Square cut key groove; Hardened
24	Keeper, Bulk	VK-138B		1 groove; Square cut key groove; Carton of 1000
QTY	VALVE SEAT	PART NO.	SIZE	DESCRIPTION
6	Exh.	FP-R43681	STD	1.7555" OD, 1.5000" ID, .2480" Depth
6	Int.	FP-R43680	STD	
QTY	VALVE SPRING	PART NO.	SIZE	DESCRIPTION
12	Spring	FP-R26125		2.1200" Free Height
QTY	VALVE MISC.	PART NO.	SIZE	DESCRIPTION
6	Rotocap	FP-RE11410		Exh.

### CAMSHAFT GROUP

QTY	CAMSHAFT/LIFTER	PART NO.	SIZE	DESCRIPTION
1	Camshaft	FP-R71530		Model 4230 From Ser. No. 335,846
1	Camshaft	FP-R71530		Models 4040, 4320, 4430, 7700
1	Prelube	55-400		4 oz. bottle; 1.5 oz. packet No. 55-403 also avail.

### ENGINE BLOCK & PARTS

QTY	GASKET SETS	PART NO.	SIZE	DESCRIPTION
1	Kit Gasket Set	FP-2601399		Compl.; Rear main brg. seal incl. and wear sleeve incl.; Timing cover seal and wear sleeve incl.
1	Kit Gasket Set	260-1399		Compl.; Rear main brg. seal incl. and wear sleeve incl.; Timing cover seal and wear sleeve incl.
QTY	CAM BEARINGS	PART NO.	SIZE	DESCRIPTION
1	Cam Set	FP-4R46903	STD	
4	Cam Brg.	FP-R46903	STD	

### CRANKSHAFT/OIL PUMP

QTY	SEALS - FRONT CRANK	PART NO.	SIZE	DESCRIPTION
1	Oil Seal Kit	FP-AR49025		
QTY	SEALS - REAR CRANK	PART NO.	SIZE	DESCRIPTION
1	Oil Seal	FP-RE22764		PTFE
QTY	MAIN BEARINGS	PART NO.	SIZE	DESCRIPTION
1	Main Set	FP-MBK400L4	STD	w/5 main brgs.
1	Main Set	FP-MBK400L410	10	w/5 main brgs.

(continued on next page)

**96** Combine 6404D Eng. Harvester 6404D Eng. Power Unit JD404D, 6404D Engs. Wheel  
(cont.) Tractor 6404D Eng. Loader Tractor 6404D Eng.  
6.6L 404 OHV Diesel L6 (Late), 4.25" Bore

**CRANKSHAFT/OIL PUMP (cont.)**

QTY	MAIN BEARINGS (cont.)	PART NO.	SIZE	DESCRIPTION
1	Main Set	FP-MBK400L420	20	w/5 main brgs.
1	Main Set	FP-MBK400L6	STD	w/7 main brgs.
1	Main Set	FP-MBK400L610	10	w/7 main brgs.
1	Main Set	FP-MBK400L620	20	w/7 main brgs.
1	Main Set	FP-MBK400L630	30	Engs. w/7 main brgs.
1	Thrust Washer Set	FP-AR77747	STD	

**CYLINDER COMPONENTS**

QTY	LINERS	PART NO.	SIZE	DESCRIPTION
6	Liner w/o Sealing Ring	FP-R40615	STD	
6	Liner w/Sealing Rings	FP-R40615WS	STD	
6	Cylinder Kit Complete	FP-RE23160	STD	w/Block marked R49470, R49650, R59850, R72128; w/Con. Rod marked R26047, R52225, R58880, R66923; From Ser. No. 335,846

QTY	PISTONS	PART NO.	SIZE	DESCRIPTION
6	Pin Bushing	FP-R30939		
6	Pin Bushing	FP-3129YA20		1.252" ID, 1.3785" OD, 1.510" O.A.L.
6	Pin Bushing	FP-R42173		1.627" ID, 1.8155" OD, 1.500" O.A.L.

QTY	CONNECTING RODS & BRGS.	PART NO.	SIZE	DESCRIPTION
6	Rod Pair	FP-AR45723	STD	
6	Rod Pair	FP-AR46396	10	
6	Rod Pair	FP-AR46397	20	
6	Rod Pair	FP-AR46398	30	

QTY	PISTON RINGS	PART NO.	SIZE	DESCRIPTION
6	Ring Set Single Cylinder	FP-AR55630	STD	Check piston grooving before supplying ring set; 1-1/8, 1-3/32, 1-1/4 (1 cyl. set)
6	Ring Set Single Cylinder	FP-AR65502	STD	1-1/8, 1-3/32, 1-3/16 (1 cyl. set)
6	Ring Set Single Cylinder	FP-AR51741	STD	2-5/32, 1-3/16 (1 cyl. set)
3	Premium Set	FP-AR55630S	STD	Check piston grooving before supplying ring set; 2-1/8, 2-3/32, 2-1/4 (2 cyl. set)
6	Premium Single Cylinder Set	W-9348KX + Std Only		Check piston grooving before supplying ring set; 1-1/8, 1-3/32, 1-1/4 (2 cyl. set); When depleted use FP-AR55630

**KITS**

QTY	OVERHAUL KIT	PART NO.	SIZE	DESCRIPTION
1	Complete Overhaul Kit	FP-404DLOHK		w/Block marked R49470, R49650, R59850, R72128; w/Con. Rod marked R26047, R52225, R58880, R66923; From Ser. No. 335,846; Incl. Torque-To-Yield con. rod bolts

**97** Wheel Tractor 6404D Eng.  
6.6L 404 OHV Diesel L6 (5 Main), 4.25" Bore

**ENGINE BLOCK & PARTS**

QTY	CAM BEARINGS	PART NO.	SIZE	DESCRIPTION
1	Cam Set	FP-4R46903	STD	
4	Cam Brg.	FP-R46903	STD	

**CRANKSHAFT/OIL PUMP**

QTY	SEALS - FRONT CRANK	PART NO.	SIZE	DESCRIPTION
1	Oil Seal Kit	FP-AR49025		

QTY	SEALS - REAR CRANK	PART NO.	SIZE	DESCRIPTION
1	Oil Seal	FP-RE22764		PTFE

QTY	MAIN BEARINGS	PART NO.	SIZE	DESCRIPTION
1	Main Set	FP-MBK400L4	STD	Late Engs.; w/Thrust washer
1	Main Set	FP-MBK400L410	10	Late Engs.; w/Thrust washer
1	Main Set	FP-MBK400L420	20	Late Engs.; w/Thrust washer

**CYLINDER COMPONENTS**

QTY	PISTONS	PART NO.	SIZE	DESCRIPTION
6	Pin Bushing	FP-3129YA20		1.252" ID, 1.3785" OD, 1.510" O.A.L.

QTY	CONNECTING RODS & BRGS.	PART NO.	SIZE	DESCRIPTION
6	Rod Pair	FP-AR45723	STD	
6	Rod Pair	FP-AR46396	10	
6	Rod Pair	FP-AR46397	20	

(continued on next page)





# John Deere Off Highway

Wheel Tractor 6404D Eng. 97  
6.6L 404 OHV Diesel L6 (5 Main), 4.25" Bore (cont.)

## CYLINDER COMPONENTS (cont.)

QTY	CONNECTING RODS & BRGS. (cont.)	PART NO.	SIZE	DESCRIPTION
6	Rod Pair	FP-AR46398	30	

Combine 6404A, 6404T Engs. Harvester 6404A, 6404T Engs. Loader 6404A, 6404T Engs. 98  
Wheel Tractor 6404A, 6404T Engs. Excavator 6404A, 6404T Engs. Skidder 6404A, 6404T Engs. Compactor 6404A, 6404T Engs. Feller Buncher 6404A, 6404T Engs. Forage Harvester 6404A, 6404T Engs.  
6.6L 404 OHV Turbo-Diesel L6 (Aftercooled), 4.25" Bore

## CYL. HEAD & PARTS

QTY	GASKETS	PART NO.	SIZE	DESCRIPTION
1	Valve Cover Gasket	FP-R49866		Rocker cover codes 1101, 1102; From Ser. No. 67,685
1	Head Gasket	FP-R48291		
1	Head Set	FP-AR63270		

QTY	HEAD BOLTS	PART NO.	SIZE	DESCRIPTION
6	Head Bolt	FP-R88042		w/Block marked R43310, R45980, R47020, R47110, R49470, R49650, R59850, R72128; 3.250" length
5	Head Bolt	FP-R88043		w/Block marked R43310, R45980, R47020, R47110, R49470, R49650, R59850, R72128; 5.250" length
8	Head Bolt	FP-R88044		w/Block marked R43310, R45980, R47020, R47110, R49470, R49650, R59850, R72128; 6.250" length
7	Head Bolt	FP-R88045		w/Block marked R43310, R45980, R47020, R47110, R49470, R49650, R59850, R72128; 7.250" length

QTY	VALVE	PART NO.	SIZE	DESCRIPTION
6	Intake	FP-R43914	STD	From Ser. No. 245,547 to Ser No. 335,845; 1 groove; Chrome plated stem; 1.7500" Head Dia., .3720" Stem Dia., 6.1280" O.A.L.
6	Intake	FP-R50358	STD	From Ser. No. 335,846; 1 groove; 1.7150" Head Dia., .3720" Stem Dia., 6.1920" O.A.L.
6	Intake	FP-R55055	3	From Ser. No. 335,846; 1 groove; 1.7150" Head Dia., .3750" Stem Dia., 6.1920" O.A.L.
6	Intake	FP-R43883	STD	To Ser. No. 245,546; 1 groove; Chrome plated stem; 1.9020" Head Dia., .3720" Stem Dia., 6.1510" O.A.L.
6	Intake	FP-R45003	3	To Ser. No. 245,546; 1 groove; Chrome plated stem; 1.9020" Head Dia., .3750" Stem Dia., 6.1510" O.A.L.
6	Intake	FP-R45005	30	To Ser. No. 245,546; 1 groove; Chrome plated stem; 1.9020" Head Dia., .4020" Stem Dia., 6.1510" O.A.L.
6	Exhaust	FP-R50357	STD	From Ser. No. 335,846; 1 groove; Chrome plated stem; 1.7150" Head Dia., .3720" Stem Dia., 6.2080" O.A.L.
6	Exhaust	FP-R43679	STD	To Ser. No. 335,845; 1 groove; Chrome plated stem; 1.7150" Head Dia., .3720" Stem Dia., 6.1330" O.A.L.
6	Exhaust	FP-R43787	3	To Ser. No. 335,845; 1 groove; Chrome plated stem; 1.7150" Head Dia., .3750" Stem Dia., 6.1330" O.A.L.
6	Exhaust	FP-R43788	15	To Ser. No. 335,845; 1 groove; Chrome plated stem; 1.7150" Head Dia., .3870" Stem Dia., 6.1330" O.A.L.
6	Exhaust	FP-R43789	30	To Ser. No. 335,845; 1 groove; Chrome plated stem; 1.7150" Head Dia., .4020" Stem Dia., 6.1330" O.A.L.
24	Keeper	FP-41339		1 groove; Square cut key groove
24	Keeper	FP-T20077		1 groove; Square cut key groove; Hardened
24	Keeper, Bulk	VK-138B		1 groove; Square cut key groove; Carton of 1000

QTY	VALVE SEAT	PART NO.	SIZE	DESCRIPTION
6	Exh.	FP-R50356	STD	From Ser. No. 335,846
6	Exh.	FP-R55061	10	From Ser. No. 335,846
6	Exh.	FP-R43681	STD	Models 5200, 7200 To Eng. Ser. No. 335,845; Models 4320, 4620; 1.7555" OD, 1.5000" ID, .2480" Depth
6	Int.	FP-R78702	STD	From Ser. No. 245,757; 1.7550" OD, 1.5000" ID, .2160" Depth
6	Int.	FP-R82508	10	From Ser. No. 245,757; 1.7650" OD, 1.5000" ID, .2160" Depth
6	Int.	FP-R43680	STD	To Ser. No. 245,756

QTY	VALVE SPRING	PART NO.	SIZE	DESCRIPTION
12	Spring	FP-R26125		2.1200" Free Height

QTY	VALVE MISC.	PART NO.	SIZE	DESCRIPTION
6	Rotocap	FP-RE11410		Exh.; From Ser. No. 215,000
1	Oil Filler Cap Gasket	FP-T20328		Rocker arm cover code 1101

## ELECTRICAL

QTY	ELECTRICAL	PART NO.	SIZE	DESCRIPTION
1	Starter to Block Gasket	FP-R53108		3-Hole mount; Starting motor code 3004

(continued on next page)

<b>98</b> Combine 6404A, 6404T Engs. Harvester 6404A, 6404T Engs. Loader 6404A, 6404T Engs. (cont.) Wheel Tractor 6404A, 6404T Engs. Excavator 6404A, 6404T Engs. Skidder 6404A, 6404T Engs. Compactor 6404A, 6404T Engs. Feller Buncher 6404A, 6404T Engs. Forage Harvester 6404A, 6404T Engs. 6.6L 404 OHV Turbo-Diesel L6 (Aftercooled), 4.25" Bore				
<b>ELECTRICAL (cont.)</b>				
<b>QTY</b>	<b>ALTERNATOR</b>	<b>PART NO.</b>	<b>SIZE</b>	<b>DESCRIPTION</b>
1	Ball Brg.	FP-JD9449		Front; Delco-Remy; 12 Volt alternator
1	Ball Brg.	FP-JD9449		Front; Motorola; 12 Volt, 35 amp alternator; 72 amp alternator; To Ser. No. 357,083
<b>METERS</b>				
<b>QTY</b>	<b>METERS</b>	<b>PART NO.</b>	<b>SIZE</b>	<b>DESCRIPTION</b>
1	Speed/Hour Meter Gasket	FP-R62410		To Ser. No. 357,083
<b>INT &amp; EXH MANIFOLDS</b>				
<b>QTY</b>	<b>INT. &amp; EXH. MANIFOLDS</b>	<b>PART NO.</b>	<b>SIZE</b>	<b>DESCRIPTION</b>
2	Exhaust Manifold Gasket	FP-R83021		One Exh. hole
2	Exhaust Manifold Gasket	FP-R83020		Two Exh. holes
3	Intake Manifold Gasket	FP-R50397		Two Int. holes
3	Intake Manifold Gasket	FP-R130573		6404A Engs.; To Ser. No. 357,083
<b>QTY</b>	<b>AIR INTAKE</b>	<b>PART NO.</b>	<b>SIZE</b>	<b>DESCRIPTION</b>
1	O-Ring	FP-R50406		Manifold coupling; 6404A Engs.; Small end; From Ser. No. 357,084
1	O-Ring	FP-R50406		Manifold coupling; 6404T Engs.; Small end; From Ser. No. 512,306
<b>CAMSHAFT GROUP</b>				
<b>QTY</b>	<b>TIMING COVER</b>	<b>PART NO.</b>	<b>SIZE</b>	<b>DESCRIPTION</b>
1	Crankshaft Front Cover Gasket	FP-R26058		
1	Timing Gear Cover Gasket	FP-R50390		Access cover
1	Timing Gear Cover Gasket	FP-R50353		From Ser. No. 357,084
1	Timing Gear Cover Gasket	FP-R47047		To Ser. No. 357,083
<b>QTY</b>	<b>CAMSHAFT/LIFTER</b>	<b>PART NO.</b>	<b>SIZE</b>	<b>DESCRIPTION</b>
1	Camshaft	FP-R71529		w/Camshaft marked R64086, R77259
1	Camshaft	FP-R71530		6404T Engs.; From Ser. No. 335,846
1	Camshaft Plug	FP-R26115		
12	Lifter	FP-R52773		
1	Prelube	55-400		4 oz. bottle; 1.5 oz. packet No. 55-403 also avail.
<b>QTY</b>	<b>CAMSHAFT KIT</b>	<b>PART NO.</b>	<b>SIZE</b>	<b>DESCRIPTION</b>
1	Cam/Lifter Kit	FP-AR100385		w/Camshaft marked R64086, R77259; Incl. (12) FP-R52773, (1) FP-R71529
<b>FUEL SYSTEM &amp; PARTS</b>				
<b>QTY</b>	<b>FUEL INJECTION</b>	<b>PART NO.</b>	<b>SIZE</b>	<b>DESCRIPTION</b>
12	Washer	FP-R48693		Inj. leak-off screw; w/Bosch nozzle; To Ser. No. 445,569
6	Washer	FP-R64840		Injector nozzle; From Ser. No. 445,570; Steel
21	Clamp	FP-R34766		Pump codes 1601, 1604; From Ser. No. 445,570
6	Fuel Line Connector Gasket	FP-R59294		Leak-off connector washer; From Ser. No. 445,570; Aftercooled; Alum.
1	Washer Type Seal	FP-R51936		To Ser. No. 445,569
<b>QTY</b>	<b>FUEL FILTERS &amp; PUMP</b>	<b>PART NO.</b>	<b>SIZE</b>	<b>DESCRIPTION</b>
6	O-Ring	FP-R51603		Fuel nozzle; Injector nozzle codes 1601, 1604; From Ser. No. 445,570
1	O-Ring	FP-R375R		Fuel check valve; From Ser. No. 424,132
<b>QTY</b>	<b>TURBOCHARGER</b>	<b>PART NO.</b>	<b>SIZE</b>	<b>DESCRIPTION</b>
1	Turbocharger Mounting Gasket	FP-R43751		
<b>COOLING SYSTEM</b>				
<b>QTY</b>	<b>WATER PUMP</b>	<b>PART NO.</b>	<b>SIZE</b>	<b>DESCRIPTION</b>
1	Water Pump Impeller	FP-R50411		w/Pump housing marked R50408
1	Water Pump Repair/Rebuild Kit	FP-925750411		w/Pump housing marked R50408
1	Water Pump Repair/Rebuild Kit	FP-935550411		w/Pump housing marked R54955
1	Water Pump Housing Gasket	FP-R50410		w/Pump housing marked R50408
1	Water Pump Housing Gasket	FP-R42404		To Ser. No. 335,845
1	Water Pump Plate Gasket	FP-R43117		w/Pump housing marked R42402, R43114, R46561; To Ser. No. 357,083
2	Water Pump Spacer Gasket	FP-R42406		w/Pump housing marked R42402, R43114, R46561, R50408
1	Shaft & Bearing Assembly	FP-JD9257		w/Pump housing marked R42402, R43114, R46561, R50408
1	Shaft & Bearing Assembly	FP-JD9355		w/Pump housing marked R54955; From Ser. No. 335,846

(continued on next page)



# John Deere Off Highway

Combine 6404A, 6404T Engs. Harvester 6404A, 6404T Engs. Loader 6404A, 6404T Engs. **98**  
 Wheel Tractor 6404A, 6404T Engs. Excavator 6404A, 6404T Engs. Skidder 6404A, 6404T (cont.)  
 Engs. Compactor 6404A, 6404T Engs. Feller Buncher 6404A, 6404T Engs. Forage  
 Harvester 6404A, 6404T Engs.  
 6.6L 404 OHV Turbo-Diesel L6 (Aftercooled), 4.25" Bore

## COOLING SYSTEM (cont.)

QTY	THERMOSTAT	PART NO.	SIZE	DESCRIPTION
2	Thermostat	FP-AR48675		From Ser. No. 357,084; 180 Deg.
1	Thermostat Cover Gasket	FP-R46479		To Ser. No. 357,083; Two hole

QTY	MISCELLANEOUS	PART NO.	SIZE	DESCRIPTION
2	Water Manifold Mounting Gskt.	FP-R88397		
1	Cyl. Block Water Hole Cvr Gsk	FP-R43595		Cyl. head water opening cover gskt.

## ENGINE BLOCK & PARTS

QTY	GASKETS	PART NO.	SIZE	DESCRIPTION
1	Oil Pan Gasket	FP-R71918		
1	Oil Pan Gasket	FP-R49377		From Ser. No. 357,084
1	Cylinder Cover Gasket	FP-R45968		To Ser. No. 357,083

QTY	GASKET SETS	PART NO.	SIZE	DESCRIPTION
1	In-Frame Gasket Set	FP-PG404TAS		
1	Complete Overhaul Gasket Set	FP-AR63269		From Ser. No. 335,846; Crankshaft oil seals not incl.
1	Complete Overhaul Gasket Set	FP-AR53094		To Ser. No. 335,845; Crankshaft oil seals not incl.
1	Complete Overhaul Gasket Set	FP-AR63269WS		6404A Engs.; From Ser. No. 335,846; Incl. Crankshaft oil seals; Rear main brg. seal incl.; Wear sleeve; Timing cover seal and wear sleeve not incl.
1	Complete Overhaul Gasket Set	FP-AR53094WS		6404A Engs.; To Ser. No. 335,845; Incl. Crankshaft oil seals; Rear main brg. seal incl.; Wear sleeve; Timing cover seal and wear sleeve not incl.
1	Kit Gasket Set	260-1398		6404A Engs.; Compl.; Rear main brg. seal incl.; Wear sleeve incl.; Timing cover seal and wear sleeve incl.

QTY	CAM BEARINGS	PART NO.	SIZE	DESCRIPTION
1	Cam Set	FP-4R46903	STD	
6	Cam Brg.	FP-R46903	STD	

QTY	OIL COOLERS & FILTERS	PART NO.	SIZE	DESCRIPTION
1	Aftercooler Gasket Set	FP-404A		6404A Engs.; To Ser. No. 357,083
2	Aftercooler Intake Gasket	FP-R47394		6404A Engs.; To Ser. No. 357,083
1	Oil Cooler	FP-AT25038		w/13 plate
1	Oil Cooler	FP-AR55394		w/8 plate
1	Oil Cooler Installation Kit	FP-58952		From Ser. No. 357,084
2	Oil Cooler Gasket	FP-R27948		To Ser. No. 357,083
2	O-Ring	FP-R52811		Intercooler inlet & outlet tube seals
4	O-Ring	FP-R51203		Oil cooler inlet & outlet seals; To Ser. No. 357,083
1	Oil Cooler Cover Gasket	FP-R50419		

## CRANKSHAFT/OIL PUMP

QTY	CRANKSHAFT	PART NO.	SIZE	DESCRIPTION
1	Crankshaft	FP-RE53422		Gears incl.
1	Crankshaft	FP-AR96189		Gears not incl.
1	Oil Seal Kit	FP-SK49025		Incl. front & rear seals

QTY	SEALS - FRONT CRANK	PART NO.	SIZE	DESCRIPTION
1	Oil Seal Kit	FP-AR49025		

QTY	SEALS - REAR CRANK	PART NO.	SIZE	DESCRIPTION
1	Oil Seal	FP-RE22764		PTFE

QTY	MAIN BEARINGS	PART NO.	SIZE	DESCRIPTION
1	Main Set	FP-MBK400L4	STD	w/5 main brgs.
1	Main Set	FP-MBK400L410	10	w/5 main brgs.
1	Main Set	FP-MBK400L420	20	w/5 main brgs.
1	Main Set	FP-MBK400L6	STD	w/7 main brgs.
1	Main Set	FP-MBK400L610	10	w/7 main brgs.
1	Main Set	FP-MBK400L620	20	w/7 main brgs.
1	Main Set	FP-MBK400L630	30	w/7 main brgs.
6	Plain Main Brg.	FP-AR74814	STD	From Ser. No. 215,000
6	Plain Main Brg.	FP-AR74816	10	From Ser. No. 215,000
6	Plain Main Brg.	FP-AR74817	20	From Ser. No. 215,000
6	Plain Main Brg.	FP-AR74818	30	From Ser. No. 215,000
1	Flanged Main Brg.	FP-AR77748	STD	
1	Flanged Main Brg.	FP-AR77750	10	
1	Flanged Main Brg.	FP-AR77751	20	
1	Flanged Main Brg.	FP-AR77752	30	
1	Thrust Washer Set	FP-AR77747	STD	

(continued on next page)

**98** Combine 6404A, 6404T Engs. Harvester 6404A, 6404T Engs. Loader 6404A, 6404T Engs. (cont.) Wheel Tractor 6404A, 6404T Engs. Excavator 6404A, 6404T Engs. Skidder 6404A, 6404T Engs. Compactor 6404A, 6404T Engs. Feller Buncher 6404A, 6404T Engs. Forage Harvester 6404A, 6404T Engs.  
6.6L 404 OHV Turbo-Diesel L6 (Aftercooled), 4.25" Bore

### CRANKSHAFT/OIL PUMP (cont.)

QTY	OIL PUMP	PART NO.	SIZE	DESCRIPTION
1	Oil Pump Spring	FP-R26151		
1	O-Ring	FP-R50405		Intake coupling; Large end
1	O-Ring	FP-R59343		Ventilator tube; Rocker cover codes 1101, 1102; Can be used in place of FP-R495R; Grooved
1	O-Ring	FP-R495R		Ventilator tube; Rocker cover codes 1101, 1102; Can be used in place of FP-R59343; Smooth
1	Oil Pump Cover Gasket	FP-R52049		Int. gskt.
1	Rect. or Square Seal	FP-R43660		Filter to housing
1	Oil Filter to Block Gasket	FP-R43774		w/Filter body marked R46424, R54561, R59483, R62110

### CYLINDER COMPONENTS

QTY	LINERS	PART NO.	SIZE	DESCRIPTION
6	Liner w/o Sealing Ring	FP-R40615	STD	
6	Liner w/Sealing Rings	FP-R40615WS	STD	
6	Cylinder Kit Complete	FP-AR51798	STD	w/Block marked R43310, R45980, R47020, R47110; w/Con. Rod R41423, R58882, R66922; To Ser. No. 335,845
6	Cylinder Kit Complete	FP-AR63272	STD	w/Block marked R49470, R49650, R59850, R72128; w/Con. Rod marked R41423, R58882, R66922; From Ser. No. 335,846
6	Cyl. Liner Sealing Ring Kit	FP-AR65507		
6	Sealing Ring, Liner	FP-112847		
6	Sealing Ring, Liner	FP-R48767		Rectangle; Top
6	Sealing Ring, Liner	FP-R26121		Round; Middle
6	Sealing Ring	FP-SLR2378		Rectangle
6	Sealing Ring	FP-SLR2520		Round; Bottom

QTY	PISTONS	PART NO.	SIZE	DESCRIPTION
6	Piston Body w/o Pin	FP-AR54552		Model 7020 From Ser. No. 335,846
6	Piston Body w/o Pin	FP-AR50624		Model 7020 To Ser. No. 335,845
6	Piston Body w/o Pin	FP-AR50624		Models 4320, 4520 & 4620
6	Piston Body w/o Pin	FP-AR54552		Models 4430, 4630
6	Piston Body w/o Pin	FP-AR54552		Models 6602, 7700
6	Piston Kit w/Pin & Retainers	FP-AR54552WP	STD	Model 7020 From Ser. No. 335,846
6	Piston Kit w/Pin & Retainers	FP-AR50624WP	STD	Model 7020 To Ser. No. 335,845
6	Piston Kit w/Pin & Retainers	FP-AR50624WP	STD	Models 4320, 4520 & 4620
6	Piston Kit w/Pin & Retainers	FP-AR54552WP	STD	Models 4430, 4630; Model 7020 From Ser. No. 335,846; Models 6602, 7700
6	Piston Kit w/Pin & Retainers	FP-AR54552WP	STD	Models 6602, 7700
6	Pin	FP-R41425		
12	Piston Pin Retainer	FP-R54114		From Ser. No. 335,846; For 1.62" pin dia.
12	Piston Pin Retainer	FP-R41426		To Ser. No. 335,845
6	Pin Bushing	FP-R42173		w/Con. Rod marked R41423, R58882, R66922; 1.627" ID, 1.8155" OD, 1.500" O.A.L.

QTY	CONNECTING RODS & BRGS.	PART NO.	SIZE	DESCRIPTION
12	Con. Rod Bolt	FP-R66452		Torque-To-Yield bolt; Replacement recommended
6	Rod Pair	FP-AR45723	STD	
6	Rod Pair	FP-AR73277	STD	
6	Rod Pair	FP-AR46396	10	
6	Rod Pair	FP-AR73279	10	
6	Rod Pair	FP-AR46397	20	
6	Rod Pair	FP-AR73280	20	
6	Rod Pair	FP-AR46398	30	
6	Rod Pair	FP-AR73281	30	

QTY	PISTON RINGS	PART NO.	SIZE	DESCRIPTION
6	Ring Set Single Cylinder	FP-AR55630	STD	Check piston grooving before supplying ring set; 1-1/8, 1-3/32, 1-1/4 (1 cyl. set)
6	Ring Set Single Cylinder	FP-AR65502	STD	1-1/8, 1-3/32, 1-3/16 (1 cyl. set)
6	Ring Set Single Cylinder	FP-AR51741	STD	2-5/32, 1-3/16 (1 cyl. set)
3	Premium Set	FP-AR55630S	STD	Check piston grooving before supplying ring set; 2-1/8, 2-3/32, 2-1/4 (2 cyl. set)
6	Premium Single Cylinder Set	W-9348KX + Std Only		Check piston grooving before supplying ring set; 1-1/8, 1-3/32, 1-1/4 (2 cyl. set); When depleted use FP-AR55630

(continued on next page)



# John Deere Off Highway

**Combine 6404A, 6404T Engs. Harvester 6404A, 6404T Engs. Loader 6404A, 6404T Engs. 98**  
**Wheel Tractor 6404A, 6404T Engs. Excavator 6404A, 6404T Engs. Skidder 6404A, 6404T (cont.)**  
**Engs. Compactor 6404A, 6404T Engs. Feller Buncher 6404A, 6404T Engs. Forage**  
**Harvester 6404A, 6404T Engs.**  
 6.6L 404 OHV Turbo-Diesel L6 (Aftercooled), 4.25" Bore

## KITS

QTY	OVERHAUL KIT	PART NO.	SIZE	DESCRIPTION
1	In-Frame Overhaul Kit	FP-404TAEIFK		w/Block marked R43310, R45980, R47020, R47110; w/Con. Rod marked R41423, R58882, R66922; To Ser. No. 335,845; Incl. Torque-To-Yield con. rod bolts
1	In-Frame Overhaul Kit	FP-404TALIFK		w/Block marked R49470, R49650, R59850, R72128; w/Con. Rod marked R41423, R58882, R66922; From Ser. No. 335,846; Incl. Torque-To-Yield con. rod bolts
1	Complete Overhaul Kit	FP-404TAEOHK		w/Block marked R43310, R45980, R47020, R47110; w/Con. Rod marked R41423, R58882, R66922; To Ser. No. 335,845; Incl. Torque-To-Yield con. rod bolts
1	Complete Overhaul Kit	FP-404TALOHK		w/Block marked R49470, R49650, R59850, R72128; w/Con. Rod marked R41423, R58882, R66922; From Ser. No. 335,846; Incl. Torque-To-Yield con. rod bolts

**Wheel Tractor 6404T Eng. 99**  
 6.6L 404 OHV Turbo-Diesel L6 (Early), 4.25" Bore

## CYL. HEAD & PARTS

QTY	GASKETS	PART NO.	SIZE	DESCRIPTION
1	Valve Cover Gasket	FP-R49866		Rocker cover codes 1101, 1102; From Ser. No. 67,685
1	Head Gasket	FP-R48291		
1	Head Set	FP-AR63270		
QTY	HEAD BOLTS	PART NO.	SIZE	DESCRIPTION
6	Head Bolt	FP-R88042		w/Block marked R43310, R45980, R47020, R47110, R49470, R49650, R59850, R72128; 3.250" length
5	Head Bolt	FP-R88043		w/Block marked R43310, R45980, R47020, R47110, R49470, R49650, R59850, R72128; 5.250" length
8	Head Bolt	FP-R88044		w/Block marked R43310, R45980, R47020, R47110, R49470, R49650, R59850, R72128; 6.250" length
7	Head Bolt	FP-R88045		w/Block marked R43310, R45980, R47020, R47110, R49470, R49650, R59850, R72128; 7.250" length
QTY	VALVE	PART NO.	SIZE	DESCRIPTION
6	Intake	FP-R43914	STD	From Ser. No. 245,547 to Ser. No. 335,845; 1 groove; Chrome plated stem; 1.7500" Head Dia., .3720" Stem Dia., 6.1280" O.A.L.
6	Intake	FP-R50358	STD	From Ser. No. 335,846; 1 groove; 1.7150" Head Dia., .3720" Stem Dia., 6.1920" O.A.L.
6	Intake	FP-R55055	3	From Ser. No. 335,846; 1 groove; 1.7150" Head Dia., .3750" Stem Dia., 6.1920" O.A.L.
6	Intake	FP-R43883	STD	To Ser. No. 245,546; 1 groove; Chrome plated stem; 1.9020" Head Dia., .3720" Stem Dia., 6.1510" O.A.L.
6	Intake	FP-R45003	3	To Ser. No. 245,546; 1 groove; Chrome plated stem; 1.9020" Head Dia., .3750" Stem Dia., 6.1510" O.A.L.
6	Intake	FP-R45005	30	To Ser. No. 245,546; 1 groove; Chrome plated stem; 1.9020" Head Dia., .4020" Stem Dia., 6.1510" O.A.L.
6	Exhaust	FP-R50357	STD	From Ser. No. 335,846; 1 groove; Chrome plated stem; 1.7150" Head Dia., .3720" Stem Dia., 6.2080" O.A.L.
6	Exhaust	FP-R43679	STD	To Ser. No. 335,845; 1 groove; Chrome plated stem; 1.7150" Head Dia., .3720" Stem Dia., 6.1330" O.A.L.
6	Exhaust	FP-R43787	3	To Ser. No. 335,845; 1 groove; Chrome plated stem; 1.7150" Head Dia., .3750" Stem Dia., 6.1330" O.A.L.
6	Exhaust	FP-R43788	15	To Ser. No. 335,845; 1 groove; Chrome plated stem; 1.7150" Head Dia., .3870" Stem Dia., 6.1330" O.A.L.
6	Exhaust	FP-R43789	30	To Ser. No. 335,845; 1 groove; Chrome plated stem; 1.7150" Head Dia., .4020" Stem Dia., 6.1330" O.A.L.
24	Keeper	FP-41339		1 groove; Square cut key groove
24	Keeper	FP-T20077		1 groove; Square cut key groove; Hardened
24	Keeper, Bulk	VK-138B		1 groove; Square cut key groove; Carton of 1000
QTY	VALVE SEAT	PART NO.	SIZE	DESCRIPTION
6	Exh.	FP-R50356	STD	From Ser. No. 335,846
6	Exh.	FP-R55061	10	From Ser. No. 335,846
6	Exh.	FP-R43681	STD	Models 5200, 7200 To Eng. Ser. No. 335,845; Models 4320, 4620; 1.7555" OD, 1.5000" ID, .2480" Depth
6	Int.	FP-R78702	STD	From Ser. No. 245,757; 1.7550" OD, 1.5000" ID, .2160" Depth
6	Int.	FP-R82508	10	From Ser. No. 245,757; 1.7650" OD, 1.5000" ID, .2160" Depth
6	Int.	FP-R43680	STD	To Ser. No. 245,756

(continued on next page)

# John Deere Off Highway



<b>99 Wheel Tractor 6404T Eng.</b>				
<b>(cont.) 6.6L 404 OHV Turbo-Diesel L6 (Early), 4.25" Bore</b>				
<b>CYL. HEAD &amp; PARTS (cont.)</b>				
<b>QTY</b>	<b>VALVE SPRING</b>	<b>PART NO.</b>	<b>SIZE</b>	<b>DESCRIPTION</b>
12	Spring	FP-R26125		2.1200" Free Height
<b>QTY</b>	<b>VALVE MISC.</b>	<b>PART NO.</b>	<b>SIZE</b>	<b>DESCRIPTION</b>
6	Rotocap	FP-RE11410		Exh.; From Ser. No. 215,000
1	Oil Filler Cap Gasket	FP-T20328		Rocker arm cover code 1101
<b>ELECTRICAL</b>				
<b>QTY</b>	<b>ELECTRICAL</b>	<b>PART NO.</b>	<b>SIZE</b>	<b>DESCRIPTION</b>
1	Starter to Block Gasket	FP-R53108		3-Hole mount; Starting motor code 3004
<b>METERS</b>				
<b>QTY</b>	<b>METERS</b>	<b>PART NO.</b>	<b>SIZE</b>	<b>DESCRIPTION</b>
1	Speed/Hour Meter Gasket	FP-R62410		To Ser. No. 357,083
<b>INT &amp; EXH MANIFOLDS</b>				
<b>QTY</b>	<b>INT. &amp; EXH. MANIFOLDS</b>	<b>PART NO.</b>	<b>SIZE</b>	<b>DESCRIPTION</b>
2	Exhaust Manifold Gasket	FP-R83021		One Exh. hole
2	Exhaust Manifold Gasket	FP-R83020		Two Exh. holes
3	Intake Manifold Gasket	FP-R130573		To Ser. No. 357,083
3	Intake Manifold Gasket	FP-R50397		Two Int. holes
<b>CAMSHAFT GROUP</b>				
<b>QTY</b>	<b>TIMING COVER</b>	<b>PART NO.</b>	<b>SIZE</b>	<b>DESCRIPTION</b>
1	Crankshaft Front Cover Gasket	FP-R26058		
1	Timing Gear Cover Gasket	FP-R50390		Access cover
1	Timing Gear Cover Gasket	FP-R50353		From Ser. No. 357,084
1	Timing Gear Cover Gasket	FP-R47047		To Ser. No. 357,083
<b>QTY</b>	<b>CAMSHAFT/LIFTER</b>	<b>PART NO.</b>	<b>SIZE</b>	<b>DESCRIPTION</b>
1	Camshaft	FP-R71529		
1	Camshaft	FP-R71530		From Ser. No. 335,846
1	Camshaft Plug	FP-R26115		
12	Lifter	FP-R52773		
1	Prelube	55-400		4 oz. bottle; 1.5 oz. packet No. 55-403 also avail.
<b>QTY</b>	<b>CAMSHAFT KIT</b>	<b>PART NO.</b>	<b>SIZE</b>	<b>DESCRIPTION</b>
1	Cam/Lifter Kit	FP-AR100385		Incl. (12) FP-R52773, (1) FP-R71529
<b>FUEL SYSTEM &amp; PARTS</b>				
<b>QTY</b>	<b>FUEL INJECTION</b>	<b>PART NO.</b>	<b>SIZE</b>	<b>DESCRIPTION</b>
12	Washer	FP-R48693		Inj. leak-off screw; w/Bosch nozzle; To Ser. No. 445,569
6	Washer	FP-R64840		Injector nozzle; From Ser. No. 445,570; Steel
21	Clamp	FP-R34766		Pump codes 1601, 1604; From Ser. No. 445,570
6	Fuel Line Connector Gasket	FP-R59294		Leak-off connector washer; From Ser. No. 445,570; Aftercooled; Alum.
1	Washer Type Seal	FP-R51936		To Ser. No. 445,569
<b>QTY</b>	<b>FUEL FILTERS &amp; PUMP</b>	<b>PART NO.</b>	<b>SIZE</b>	<b>DESCRIPTION</b>
6	O-Ring	FP-R51603		Fuel nozzle; Injector nozzle codes 1601, 1604; w/Bosch injector; To Ser. No. 445,569
6	O-Ring	FP-R51603		Fuel nozzle; Injector nozzle codes 1601, 1604; From Ser. No. 445,570
1	O-Ring	FP-R375R		Fuel check valve; From Ser. No. 424,132
<b>QTY</b>	<b>TURBOCHARGER</b>	<b>PART NO.</b>	<b>SIZE</b>	<b>DESCRIPTION</b>
1	Turbocharger Mounting Gasket	FP-R43751		
<b>COOLING SYSTEM</b>				
<b>QTY</b>	<b>WATER PUMP</b>	<b>PART NO.</b>	<b>SIZE</b>	<b>DESCRIPTION</b>
1	Water Pump Impeller	FP-R50411		w/Pump housing marked R50408
1	Water Pump Repair/Rebuild Kit	FP-925750411		w/Pump housing marked R50408
1	Water Pump Repair/Rebuild Kit	FP-935550411		w/Pump housing marked R54955
1	Water Pump Housing Gasket	FP-R50410		w/Pump housing marked R50408
1	Water Pump Housing Gasket	FP-R42404		To Ser. No. 335,845
1	Water Pump Plate Gasket	FP-R43117		w/Pump housing marked R42402, R43114, R46561; To Ser. No. 357,083
2	Water Pump Spacer Gasket	FP-R42406		w/Pump housing marked R42402, R43114, R46561, R50408
1	Shaft & Bearing Assembly	FP-JD9257		w/Pump housing marked R42402, R43114, R46561, R50408
1	Shaft & Bearing Assembly	FP-JD9355		w/Pump housing marked R54955; From Ser. No. 335,846
<b>QTY</b>	<b>THERMOSTAT</b>	<b>PART NO.</b>	<b>SIZE</b>	<b>DESCRIPTION</b>
2	Thermostat	FP-AR48675		180 Deg.
1	Thermostat Cover Gasket	FP-R46479		Two hole

(continued on next page)



# John Deere Off Highway

*Wheel Tractor 6404T Eng. 99*  
6.6L 404 OHV Turbo-Diesel L6 (Early), 4.25" Bore (cont.)

<b>COOLING SYSTEM (cont.)</b>				
QTY	MISCELLANEOUS	PART NO.	SIZE	DESCRIPTION
2	Water Manifold Mounting Gskt.	FP-R88397		
1	Cyl. Block Water Hole Cvr Gsk	FP-R43595		Cyl. head water opening cover gskt.
<b>ENGINE BLOCK &amp; PARTS</b>				
QTY	GASKETS	PART NO.	SIZE	DESCRIPTION
1	Oil Pan Gasket	FP-R71918		
1	Oil Pan Gasket	FP-R49377		From Ser. No. 357,084
1	Cylinder Cover Gasket	FP-R45968		To Ser. No. 357,083
QTY	GASKET SETS	PART NO.	SIZE	DESCRIPTION
1	In-Frame Gasket Set	FP-PG404TAS		
1	Complete Overhaul Gasket Set	FP-AR63269		From Ser. No. 335,846; Crankshaft oil seals not incl.
1	Complete Overhaul Gasket Set	FP-AR63269WS		From Ser. No. 335,846; Incl. Crankshaft oil seals; Rear main brg. seal incl.; Wear sleeve; Timing cover seal and wear sleeve not incl.
1	Complete Overhaul Gasket Set	FP-AR53094		To Ser. No. 335,845; Crankshaft oil seals not incl.
1	Complete Overhaul Gasket Set	FP-AR53094WS		To Ser. No. 335,845; Incl. Crankshaft oil seals; Rear main brg. seal incl.; Wear sleeve; Timing cover seal and wear sleeve not incl.
QTY	CAM BEARINGS	PART NO.	SIZE	DESCRIPTION
1	Cam Set	FP-4R46903	STD	
6	Cam Brg.	FP-R46903	STD	
QTY	OIL COOLERS & FILTERS	PART NO.	SIZE	DESCRIPTION
1	Aftercooler Gasket Set	FP-404A		To Ser. No. 357,083
2	Aftercooler Intake Gasket	FP-R47394		To Ser. No. 357,083
2	Oil Cooler Gasket	FP-R27948		To Ser. No. 357,083
1	Oil Cooler Cover Gasket	FP-R50419		
<b>CRANKSHAFT/OIL PUMP</b>				
QTY	CRANKSHAFT	PART NO.	SIZE	DESCRIPTION
1	Crankshaft	FP-RE53422		Gears incl.
1	Crankshaft	FP-AR96189		Gears not incl.
1	Oil Seal Kit	FP-SK49025		Incl. front & rear seals
QTY	SEALS - FRONT CRANK	PART NO.	SIZE	DESCRIPTION
1	Oil Seal Kit	FP-AR49025		
QTY	SEALS - REAR CRANK	PART NO.	SIZE	DESCRIPTION
1	Oil Seal	FP-RE22764		PTFE
QTY	MAIN BEARINGS	PART NO.	SIZE	DESCRIPTION
1	Main Set	FP-MBK400L6	STD	w/7 main brgs.
1	Main Set	FP-MBK400L610	10	w/7 main brgs.
1	Main Set	FP-MBK400L620	20	w/7 main brgs.
1	Main Set	FP-MBK400L630	30	w/7 main brgs.
1	Main Set	FP-MBK400L4	STD	From Ser. No. 215,000; w/5 main brgs.
1	Main Set	FP-MBK400L410	10	From Ser. No. 215,000; w/5 main brgs.
1	Main Set	FP-MBK400L420	20	From Ser. No. 215,000; w/5 main brgs.
6	Plain Main Brg.	FP-AR74814	STD	From Ser. No. 215,000
6	Plain Main Brg.	FP-AR74816	10	From Ser. No. 215,000
6	Plain Main Brg.	FP-AR74817	20	From Ser. No. 215,000
6	Plain Main Brg.	FP-AR74818	30	From Ser. No. 215,000
1	Flanged Main Brg.	FP-AR77748	STD	
1	Flanged Main Brg.	FP-AR77750	10	
1	Flanged Main Brg.	FP-AR77751	20	
1	Flanged Main Brg.	FP-AR77752	30	
1	Thrust Washer Set	FP-AR77747	STD	
QTY	OIL PUMP	PART NO.	SIZE	DESCRIPTION
1	O-Ring	FP-R50405		Intake coupling; Large end
1	O-Ring	FP-R59343		Ventilator tube; Rocker cover codes 1101, 1102; Can be used in place of FP-R495R; Grooved
1	O-Ring	FP-R495R		Ventilator tube; Rocker cover codes 1101, 1102; Can be used in place of FP-R59343; Smooth
1	Oil Pump Cover Gasket	FP-R52049		Int. gskt.
1	Rect. or Square Seal	FP-R43660		Filter to housing
1	Oil Filter to Block Gasket	FP-R43774		w/Filter body marked R46424, R54561, R59483, R62110
<b>CYLINDER COMPONENTS</b>				
QTY	LINERS	PART NO.	SIZE	DESCRIPTION
6	Liner w/o Sealing Ring	FP-R40615	STD	
6	Liner w/Sealing Rings	FP-R40615WS	STD	

(continued on next page)

**99 Wheel Tractor 6404T Eng.**  
(cont.) 6.6L 404 OHV Turbo-Diesel L6 (Early), 4.25" Bore

CYLINDER COMPONENTS (cont.)				
QTY	LINERS (cont.)	PART NO.	SIZE	DESCRIPTION
6	Cylinder Kit Complete	FP-AR51798	STD	w/Block marked R43310, R45980, R47020, R47110; w/Con. Rod R41423, R58882, R66922; To Ser. No. 335,845
6	Cylinder Kit Complete	FP-AR63272	STD	w/Block marked R49470, R49650, R59850, R72128; w/Con. Rod marked R41423, R58882, R66922; From Ser. No. 335,846
6	Cyl. Liner Sealing Ring Kit	FP-AR65507		
6	Sealing Ring, Liner	FP-112847		
6	Sealing Ring, Liner	FP-R48767		Rectangle; Top
6	Sealing Ring, Liner	FP-R26121		Round; Middle
6	Sealing Ring	FP-SLR2378		Rectangle
6	Sealing Ring	FP-SLR2520		Round; Bottom
QTY	PISTONS	PART NO.	SIZE	DESCRIPTION
6	Piston Body w/o Pin	FP-AR54552		From Ser. No. 335,846
6	Piston Body w/o Pin	FP-AR50624		To Ser. No. 335,845
6	Piston Kit w/Pin & Retainers	FP-AR54552WP	STD	From Ser. No. 335,846
6	Piston Kit w/Pin & Retainers	FP-AR50624WP	STD	To Ser. No. 335,845
6	Pin	FP-R41425		
12	Piston Pin Retainer	FP-R54114		From Ser. No. 335,846; For 1.62" pin dia.
12	Piston Pin Retainer	FP-R41426		To Ser. No. 335,845
6	Pin Bushing	FP-R42173		w/Con. Rod marked R41423, R58882, R66922; 1.627" ID, 1.8155" OD, 1.500" O.A.L.
QTY	CONNECTING RODS & BRGS.	PART NO.	SIZE	DESCRIPTION
12	Con. Rod Bolt	FP-R66452		Torque-To-Yield bolt; Replacement recommended
6	Rod Pair	FP-AR45723	STD	
6	Rod Pair	FP-AR73277	STD	
6	Rod Pair	FP-AR46396	10	
6	Rod Pair	FP-AR73279	10	
6	Rod Pair	FP-AR46397	20	
6	Rod Pair	FP-AR73280	20	
6	Rod Pair	FP-AR46398	30	
6	Rod Pair	FP-AR73281	30	
QTY	PISTON RINGS	PART NO.	SIZE	DESCRIPTION
6	Ring Set Single Cylinder	FP-AR55630	STD	Check piston grooving before supplying ring set; 1-1/8, 1-3/32, 1-1/4 (1 cyl. set)
6	Ring Set Single Cylinder	FP-AR65502	STD	1-1/8, 1-3/32, 1-3/16 (1 cyl. set)
3	Premium Set	FP-AR55630S	STD	Check piston grooving before supplying ring set; 2-1/8, 2-3/32, 2-1/4 (2 cyl. set)
6	Premium Single Cylinder Set	W-9348KX + Std Only		Check piston grooving before supplying ring set; 1-1/8, 1-3/32, 1-1/4 (2 cyl. set); When depleted use FP-AR55630
KITS				
QTY	OVERHAUL KIT	PART NO.	SIZE	DESCRIPTION
1	In-Frame Overhaul Kit	FP-404TAEIFK		w/Block marked R43310, R45980, R47020, R47110; w/Con. Rod marked R41423, R58882, R66922; To Ser. No. 335,845; Incl. Torque-To-Yield con. rod bolts
1	In-Frame Overhaul Kit	FP-404TALIFK		w/Block marked R49470, R49650, R59850, R72128; w/Con. Rod marked R41423, R58882, R66922; From Ser. No. 335,846; Incl. Torque-To-Yield con. rod bolts
1	Complete Overhaul Kit	FP-404TAEOHK		w/Block marked R43310, R45980, R47020, R47110; w/Con. Rod marked R41423, R58882, R66922; To Ser. No. 335,845; Incl. Torque-To-Yield con. rod bolts
1	Complete Overhaul Kit	FP-404TALOHK		w/Block marked R49470, R49650, R59850, R72128; w/Con. Rod marked R41423, R58882, R66922; From Ser. No. 335,846; Incl. Torque-To-Yield con. rod bolts

**100 Wheel Tractor 70 Eng.**  
6.8L 413 OHV L2, 6.125" Bore

ENGINE BLOCK & PARTS				
QTY	CAM BEARINGS	PART NO.	SIZE	DESCRIPTION
2	Cone Taper Brg.	FP-JD8135		Position 1-2
2	Cup Taper Brg.	FP-JD7438		Position 1-2
CYLINDER COMPONENTS				
QTY	CONNECTING RODS & BRGS.	PART NO.	SIZE	DESCRIPTION
2	Rod Pair	FP-2155SB	STD	





# John Deere Off Highway

Power Unit 6068HN PowerTech Eng. (Natural Gas). Wheel Tractor 6068HN PowerTech 101 Eng. (Natural Gas). 6.8L 413.8 (6784cc) OHV Turbo-NG L6 (PowerTech 2V IC), 106mm Bore				
<b>CYL. HEAD &amp; PARTS</b>				
<b>QTY</b>	<b>GASKETS</b>	<b>PART NO.</b>	<b>SIZE</b>	<b>DESCRIPTION</b>
1	Valve Cover Gasket	FP-R123543		
1	Head Gasket	FP-R116516		
<b>QTY</b>	<b>VALVE</b>	<b>PART NO.</b>	<b>SIZE</b>	<b>DESCRIPTION</b>
24	Keeper	FP-R91889		Head & valve code 5113
<b>QTY</b>	<b>VALVE SPRING</b>	<b>PART NO.</b>	<b>SIZE</b>	<b>DESCRIPTION</b>
12	Spring	FP-R26125		Head & valve code 5113; 2.1200" Free Height
<b>QTY</b>	<b>VALVE MISC.</b>	<b>PART NO.</b>	<b>SIZE</b>	<b>DESCRIPTION</b>
12	Rotocap	FP-RE60005		Exh. & Int.; Head & valve code 5113
<b>INT &amp; EXH MANIFOLDS</b>				
<b>QTY</b>	<b>INT. &amp; EXH. MANIFOLDS</b>	<b>PART NO.</b>	<b>SIZE</b>	<b>DESCRIPTION</b>
6	Exhaust Manifold Gasket	FP-R90658		Exh. manifold, shield code 2817
<b>COOLING SYSTEM</b>				
<b>QTY</b>	<b>WATER PUMP</b>	<b>PART NO.</b>	<b>SIZE</b>	<b>DESCRIPTION</b>
1	Water Pump Filter	FP-R98527		Water pump code 4404; Pump marked R500401
<b>QTY</b>	<b>THERMOSTAT</b>	<b>PART NO.</b>	<b>SIZE</b>	<b>DESCRIPTION</b>
1	Thermostat	FP-AR72852		Thermostat code 2203; 192 Deg.
1	O-Ring	FP-R26286		Sensor seal; Thermostat codes 2108, 2203
<b>ENGINE BLOCK &amp; PARTS</b>				
<b>QTY</b>	<b>GASKETS</b>	<b>PART NO.</b>	<b>SIZE</b>	<b>DESCRIPTION</b>
1	Oil Pan Gasket	FP-R123354		
2	O-Ring	FP-U13639		Block coolant drain plug seal; Block code 4604; 1.475" X .118"
<b>QTY</b>	<b>CAM BEARINGS</b>	<b>PART NO.</b>	<b>SIZE</b>	<b>DESCRIPTION</b>
1	Cam Brg.	FP-R119874		Block code 4604
<b>CRANKSHAFT/OIL PUMP</b>				
<b>QTY</b>	<b>MAIN BEARINGS</b>	<b>PART NO.</b>	<b>SIZE</b>	<b>DESCRIPTION</b>
6	Plain Main Brg.	FP-RE65165	STD	Crankshaft and Bearing code 4702; w/Crankshaft marked R116076
6	Plain Main Brg.	FP-RE65911	.25MM	Crankshaft and Bearing code 4702; w/Crankshaft marked R116076
1	Flanged Main Brg.	FP-RE65168	STD	Crankshaft and Bearing code 4702; w/Crankshaft marked R116076
1	Flanged Main Brg.	FP-RE65912	.25MM	Crankshaft and Bearing code 4702; w/Crankshaft marked R116076
<b>QTY</b>	<b>OIL PUMP</b>	<b>PART NO.</b>	<b>SIZE</b>	<b>DESCRIPTION</b>
1	O-Ring	FP-R61871		Oil pump code 5001; Oil pump inlet seal
1	O-Ring	FP-R72328		Vent tube elbow seal; Rocker arm cover code 1104
<b>CYLINDER COMPONENTS</b>				
<b>QTY</b>	<b>LINERS</b>	<b>PART NO.</b>	<b>SIZE</b>	<b>DESCRIPTION</b>
6	Cyl. Liner Sealing Ring Kit	FP-AR65507		Piston & rod bearing code 4811
<b>QTY</b>	<b>PISTONS</b>	<b>PART NO.</b>	<b>SIZE</b>	<b>DESCRIPTION</b>
6	Pin	FP-R123177		Piston & rod bearing code 4811; 1.62" pin dia.
12	Piston Pin Retainer	FP-R54114		Piston & rod bearing code 4811; For 1.62" pin dia.
6	Pin Bushing	FP-R114082		Use w/Con. Rod marked R500335
6	Piston Pin Kit	FP-RE63915		Piston & rod bearing code 4811; Incl. Pin, Retainers & Bushing
<b>QTY</b>	<b>CONNECTING RODS &amp; BRGS.</b>	<b>PART NO.</b>	<b>SIZE</b>	<b>DESCRIPTION</b>
12	Con. Rod Bolt	FP-R501124		Use w/Con. Rod marked R500335
6	Rod Pair	FP-RE65908	STD	Piston & rod bearing code 4811
6	Rod Pair	FP-RE65909	.25MM	Piston & Rod bearing code 4811
<b>QTY</b>	<b>PISTON RINGS</b>	<b>PART NO.</b>	<b>SIZE</b>	<b>DESCRIPTION</b>
6	Ring Set Single Cylinder	FP-RE507852	STD	Piston & rod bearing code 4811; 1-1/8, 1-3/32, 1-.136 (1 cyl. set)
6	Ring Set Single Cylinder	FP-RE66820	STD	Piston & rod bearing code 4811; 1-1/8, 1-3/32, 1-.136 (1 cyl. set)

**102** Combine 6068H PowerTech Eng. (2-Valve Cyl. Head). Grader 6068H PowerTech Eng. (2-Valve Cyl. Head). Power Unit 6068H PowerTech Eng. (2-Valve Cyl. Head). Wheel Tractor 6068H PowerTech Eng. (2-Valve Cyl. Head). Windrower 6068H PowerTech Eng. (2-Valve Cyl. Head). Crawler Tractor 6068H PowerTech Eng. (2-Valve Cyl. Head). Loader Tractor 6068H PowerTech Eng. (2-Valve Cyl. Head). Forestry Tractor 6068H PowerTech Eng. (2-Valve Cyl. Head). Excavator 6068H PowerTech Eng. (2-Valve Cyl. Head). Backhoe 6068H PowerTech Eng. (2-Valve Cyl. Head). Sprayer 6068H PowerTech Eng. (2-Valve Cyl. Head). Integrated Tool Carrier 6068H PowerTech Eng. (2-Valve Cyl. Head).  
6.8L 413.8 (6784cc) OHV Turbo-Diesel L6 (PowerTech 2V IC), 106mm Bore

### CYL. HEAD & PARTS

QTY	GASKETS	PART NO.	SIZE	DESCRIPTION
1	Valve Cover Gasket	FP-R123543		
1	Head Gasket	FP-R116516		
1	Head Set	FP-RE66083		
QTY	VALVE	PART NO.	SIZE	DESCRIPTION
6	Intake	FP-R98062	STD	1 groove; Chrome plated stem; 1.8350" Head Dia., .3100" Stem Dia., 5.2780" O.A.L.
6	Intake	FP-R97490	15	1 groove; Chrome plated stem; 1.8350" Head Dia., .3250" Stem Dia., 5.2780" O.A.L.
6	Exhaust	FP-R90692	STD	1 groove; Chrome plated stem; 1.6730" Head Dia., .3095" Stem Dia., 5.2550" O.A.L.
6	Exhaust	FP-R97492	15	1 groove; Chrome plated stem; 1.6730" Head Dia., .3245" Stem Dia., 5.2550" O.A.L.
24	Keeper	FP-R91889		
QTY	VALVE SEAT	PART NO.	SIZE	DESCRIPTION
6	Exh.	FP-R85687	STD	
6	Int.	FP-R98335		.020" Dia. O/S face width; 1.8575" OD, 1.5500" ID, .2580" Depth
6	Int.	FP-R98063	STD	1.8575" OD, 1.5500" ID, .2580" Depth
QTY	VALVE SPRING	PART NO.	SIZE	DESCRIPTION
12	Spring	FP-R26125		2.1200" Free Height
QTY	VALVE MISC.	PART NO.	SIZE	DESCRIPTION
12	Rotocap	FP-RE60005		Exh. & Int.
QTY	VALVE SEAL	PART NO.	SIZE	DESCRIPTION
12	Valve Stem Seal	FP-RE31617		Exh. & Int.; From Ser. No. 300,000; Positive type
12	Valve Stem Seal	FP-R87627		Exh. & Int.; O-Ring type

### ELECTRICAL

QTY	ELECTRICAL	PART NO.	SIZE	DESCRIPTION
1	Starter to Block Gasket	FP-R53108		3-Hole mount; Starting motor codes 3003, 3006, 3010, 3011, 3013, 3025, 3026

### FUEL SYSTEM & PARTS

QTY	FUEL INJECTION	PART NO.	SIZE	DESCRIPTION
6	Fuel Injector Nozzle	FP-RE48786		
6	Fuel Injector Seal	FP-R92352		Upper packing
6	Washer Type Seal	FP-R48000		Lower packing
12	Washer Type Seal	FP-R51936		Fuel line; Line codes 1613, 1614, 1615, 1619, 1621, 1622, 1623, 1668, 1678, 1680, 1681, 1685, 1686, 1688, 1697, 160D; To Ser. No. 715,739
12	Washer Type Seal	FP-R51936		Fuel line; Line codes 1619, 1681, 1685, 1686, 1696, 1697, 16CM, 16CN, 16CP, 16CW, 16CX, 16CY, 16DY, 16LS, 16LT, 16LU, 16MG, 16MH, 16ML, 16MM

### COOLING SYSTEM

QTY	WATER PUMP	PART NO.	SIZE	DESCRIPTION
1	Water Pump - Heavy Duty	FP-RE500737 *		Standard flow
1	Water Pump Filter	FP-R98527		w/Pump housing marked R500734, RE70683, RE70985; High Flow

### ENGINE BLOCK & PARTS

QTY	GASKETS	PART NO.	SIZE	DESCRIPTION
1	Oil Pan Gasket	FP-R123354		
2	O-Ring	FP-U13639		Block coolant drain plug seal; Coolant heater codes 2601, 2602; 1.475" X .118"
QTY	CAM BEARINGS	PART NO.	SIZE	DESCRIPTION
1	Cam Brg.	FP-R119874		

(continued on next page)



<p align="center"><i>Combine 6068H PowerTech Eng. (2-Valve Cyl. Head). Grader 6068H PowerTech Eng. (2-Valve Cyl. Head). Power Unit 6068H PowerTech Eng. (2-Valve Cyl. Head). Wheel Tractor 6068H PowerTech Eng. (2-Valve Cyl. Head). Windrower 6068H PowerTech Eng. (2-Valve Cyl. Head). Crawler Tractor 6068H PowerTech Eng. (2-Valve Cyl. Head). Loader Tractor 6068H PowerTech Eng. (2-Valve Cyl. Head). Forestry Tractor 6068H PowerTech Eng. (2-Valve Cyl. Head). Excavator 6068H PowerTech Eng. (2-Valve Cyl. Head). Backhoe 6068H PowerTech Eng. (2-Valve Cyl. Head). Sprayer 6068H PowerTech Eng. (2-Valve Cyl. Head). Integrated Tool Carrier 6068H PowerTech Eng. (2-Valve Cyl. Head).</i></p> <p align="center">6.8L 413.8 (6784cc) OHV Turbo-Diesel L6 (PowerTech 2V IC), 106mm Bore</p>				
CRANKSHAFT/OIL PUMP				
QTY	SEALS - REAR CRANK	PART NO.	SIZE	DESCRIPTION
1	Crankshaft Rear Seal	FP-RE24959		
QTY	MAIN BEARINGS	PART NO.	SIZE	DESCRIPTION
6	Plain Main Brg.	FP-RE65165	STD	Crankshaft and Bearing codes 4702, 4703
6	Plain Main Brg.	FP-RE65911	.25MM	Crankshaft and Bearing codes 4702, 4703
1	Flanged Main Brg.	FP-RE65168	STD	Crankshaft and Bearing codes 4702, 4703
1	Flanged Main Brg.	FP-RE65912	.25MM	Crankshaft and Bearing codes 4702, 4703
QTY	OIL PUMP	PART NO.	SIZE	DESCRIPTION
1	O-Ring	FP-R61871		Oil tube from pump to block
CYLINDER COMPONENTS				
QTY	LINERS	PART NO.	SIZE	DESCRIPTION
6	Liner w/o Sealing Ring	FP-R121867	STD	
6	Liner w/Sealing Rings	FP-RE500024	STD	
6	Cylinder Kit Complete	FP-RE507920	STD	Con. Rod, Bearing & Piston codes 4807
6	Cyl. Liner Sealing Ring Kit	FP-AR65507		
QTY	PISTONS	PART NO.	SIZE	DESCRIPTION
6	Piston Body w/o Pin	FP-RE55512	STD	Con. Rod Bearing & Piston code 4810
6	Piston Body w/o Pin	FP-RE505100	STD	Con. Rod, Bearing & Piston codes 4807
6	Pin	FP-R123178		Con. Rod, Bearing & Piston code 4807; 1.375" pin dia.
6	Pin	FP-R123177		Con. Rod, Bearing & Piston codes 4810; 1.62" pin dia.
12	Piston Pin Retainer	FP-M41029		Con. Rod, Bearing & Piston codes 4805, 4807; For 1.38" pin dia.
12	Piston Pin Retainer	FP-R54114		Con. Rod, Bearing & Piston codes 4810; For 1.62" pin dia.
6	Pin Bushing	FP-R114082		Con. Rod, Bearing & Piston code 4810; w/Con. Rod marked R500335
6	Pin Bushing	FP-R123960		Con. Rod, Bearing & Piston codes 4807, 4810; 1.375" pin dia.
6	Piston Pin Kit	FP-RE63915		Con. Rod, Bearing & Piston codes 4810; Incl. Pin, Retainers & Bushing
QTY	CONNECTING RODS & BRGS.	PART NO.	SIZE	DESCRIPTION
12	Con. Rod Bolt	FP-R114083		Cyl. Liner code 4807; w/Con. Rod marked R123959; To Ser. No. 794,054
12	Con. Rod Bolt	FP-R501124		Cyl. Liner code 4807; w/Con. Rod marked R500000; From Ser. No. 794,055
12	Con. Rod Bolt	FP-R114083		Cyl. Liner code 4810; w/Con. Rod marked R500335
12	Con. Rod Bolt	FP-R501124		Cyl. Liner code 4810; w/Con. Rod marked R500335
12	Con. Rod Bolt	FP-R501124		Cyl. Liner code 4810; w/Con. Rod marked R500335; From Ser. No. 794,055
12	Con. Rod Bolt	FP-R114083		Cyl. Liner codes 4807, 4810; w/Con. Rod marked R500000, R500335; From Ser. No. 794,055
6	Rod Pair	FP-RE65908	STD	Cyl. Liner code 4810; w/Con. Rod marked R500335
6	Rod Pair	FP-RE65909	.25MM	Cyl. Liner code 4810; w/Con. Rod marked R500335
6	Rod Pair	FP-RE65908	STD	Cyl. Liner codes 4807, 4810; w/Con. Rod marked R500000, R500335
6	Rod Pair	FP-RE65909	.25MM	Cyl. Liner codes 4807, 4810; w/Con. Rod marked R500000, R500335
QTY	PISTON RINGS	PART NO.	SIZE	DESCRIPTION
6	Ring Set Single Cylinder	FP-RE66271	STD	Piston & Liner code 4807
6	Ring Set Single Cylinder	FP-RE507852	STD	Piston & Liner code 4810; 1-1/8, 1-3/32, 1-.136 (1 cyl. set)
6	Ring Set Single Cylinder	FP-RE66820	STD	Piston & Liner code 4810; 1-1/8, 1-3/32, 1-.136 (1 cyl. set)
KITS				
QTY	OVERHAUL KIT	PART NO.	SIZE	DESCRIPTION
1	In-Frame Overhaul Kit	FP-IFKPT6068		Con. Rod, Bearing & Piston codes 4807

**103** *Combine 6068H PowerTech Eng. (4-Valve Cyl. Head). Cotton Picker 6068H PowerTech Eng. (4-Valve Cyl. Head). Harvester 6068H PowerTech Eng. (4-Valve Cyl. Head). Grader 6068H PowerTech Eng. (4-Valve Cyl. Head). Power Unit 6068H PowerTech Eng. (4-Valve Cyl. Head). Wheel Tractor 6068H PowerTech Eng. (4-Valve Cyl. Head). Loader Tractor 6068H PowerTech Eng. (4-Valve Cyl. Head). Excavator 6068H PowerTech Eng. (4-Valve Cyl. Head). Sprayer 6068H PowerTech Eng. (4-Valve Cyl. Head). Logger 6068H PowerTech Eng. (4-Valve Cyl. Head). Feller Buncher 6068H PowerTech Eng. (4-Valve Cyl. Head).*  
 6.8L 413.8 (6784cc) OHV Turbo-Diesel L6 (PowerTech 4V IC), 106mm Bore

### CYL. HEAD & PARTS

QTY	GASKETS	PART NO.	SIZE	DESCRIPTION
1	Valve Cover Gasket	FP-R123543		
1	Head Gasket	FP-R116516		
1	Head Set	FP-RE66083		

### ELECTRICAL

QTY	ELECTRICAL	PART NO.	SIZE	DESCRIPTION
1	Starter to Block Gasket	FP-R53108		3-Hole mount; Starting motor codes 3003, 3006, 3010, 3011, 3013, 3025, 3026

### COOLING SYSTEM

QTY	WATER PUMP	PART NO.	SIZE	DESCRIPTION
1	Water Pump - Heavy Duty	FP-RE500737 *		Standard flow
1	Water Pump Filter	FP-R98527		w/Pump housing marked RE70683, RE70985
1	Water Pump Filter	FP-R98527		w/Pump housing marked R500734; High Flow

### ENGINE BLOCK & PARTS

QTY	GASKETS	PART NO.	SIZE	DESCRIPTION
1	Oil Pan Gasket	FP-R123354		
2	O-Ring	FP-U13639		Block coolant drain plug seal; Coolant heater codes 2601, 2602; 1.475" X .118"

QTY	CAM BEARINGS	PART NO.	SIZE	DESCRIPTION
1	Cam Brg.	FP-R119874		

### CRANKSHAFT/OIL PUMP

QTY	SEALS - REAR CRANK	PART NO.	SIZE	DESCRIPTION
1	Crankshaft Rear Seal	FP-RE24959		

QTY	MAIN BEARINGS	PART NO.	SIZE	DESCRIPTION
6	Plain Main Brg.	FP-RE65165	STD	Crankshaft and Bearing codes 4702, 4703
6	Plain Main Brg.	FP-RE65911	.25MM	Crankshaft and Bearing codes 4702, 4703
1	Flanged Main Brg.	FP-RE65168	STD	Crankshaft and Bearing codes 4702, 4703
1	Flanged Main Brg.	FP-RE65912	.25MM	Crankshaft and Bearing codes 4702, 4703

QTY	OIL PUMP	PART NO.	SIZE	DESCRIPTION
1	O-Ring	FP-R61871		Oil tube from pump to block

### CYLINDER COMPONENTS

QTY	LINERS	PART NO.	SIZE	DESCRIPTION
6	Cyl. Liner Sealing Ring Kit	FP-AR65507		

QTY	PISTONS	PART NO.	SIZE	DESCRIPTION
6	Pin	FP-R123178		Con. Rod, Bearing & Piston code 4807; 1.375" pin dia.
6	Pin	FP-R123177		Con. Rod, Bearing & Piston codes 4810; 1.62" pin dia.
12	Piston Pin Retainer	FP-M41029		Con. Rod, Bearing & Piston codes 4805, 4807; For 1.38" pin dia.
12	Piston Pin Retainer	FP-R54114		Con. Rod, Bearing & Piston codes 4810; For 1.62" pin dia.
6	Pin Bushing	FP-R114082		Con. Rod, Bearing & Piston code 4810; w/Con. Rod marked R500335
6	Pin Bushing	FP-R123960		Con. Rod, Bearing & Piston codes 4807, 4810; 1.375" pin dia.
6	Piston Pin Kit	FP-RE63915		Con. Rod, Bearing & Piston codes 4810; Incl. Pin, Retainers & Bushing

QTY	CONNECTING RODS & BRGS.	PART NO.	SIZE	DESCRIPTION
12	Con. Rod Bolt	FP-R501124		Cyl. Liner code 4810; w/Con. Rod marked R500335; From Ser. No. 794,055
6	Rod Pair	FP-RE65908	STD	Cyl. Liner codes 4807, 4810; w/Con. Rod marked R500000, R500335
6	Rod Pair	FP-RE65909	.25MM	Cyl. Liner codes 4807, 4810; w/Con. Rod marked R500000, R500335

(continued on next page)



**Combine 6068H PowerTech Eng. (4-Valve Cyl. Head). Cotton Picker 6068H PowerTech Eng. (4-Valve Cyl. Head). Harvester 6068H PowerTech Eng. (4-Valve Cyl. Head). Grader (cont.) 6068H PowerTech Eng. (4-Valve Cyl. Head). Power Unit 6068H PowerTech Eng. (4-Valve Cyl. Head). Wheel Tractor 6068H PowerTech Eng. (4-Valve Cyl. Head). Loader 6068H PowerTech Eng. (4-Valve Cyl. Head). Excavator 6068H PowerTech Eng. (4-Valve Cyl. Head). Sprayer 6068H PowerTech Eng. (4-Valve Cyl. Head). Logger 6068H PowerTech Eng. (4-Valve Cyl. Head). Feller Buncher 6068H PowerTech Eng. (4-Valve Cyl. Head).**

6.8L 413.8 (6784cc) OHV Turbo-Diesel L6 (PowerTech 4V IC), 106mm Bore

### KITS

QTY	OVERHAUL KIT	PART NO.	SIZE	DESCRIPTION
1	In-Frame Overhaul Kit	FP-IFKPT6068		

**Combine 6068D PowerTech Eng. Cotton Picker 6068D PowerTech Eng. Grader 6068D PowerTech Eng. Loader 6068D PowerTech Eng. Power Unit 6068D PowerTech Eng. Wheel Tractor 6068D PowerTech Eng. Forestry Tractor 6068D PowerTech Eng. Excavator 6068D PowerTech Eng. Skidder 6068D PowerTech Eng. Dozer 6068D PowerTech Eng. Sprayer 6068D PowerTech Eng.**

6.8L 413.8 (6784cc) OHV Diesel L6 (PowerTech 2V), 106mm Bore

### CYL. HEAD & PARTS

QTY	GASKETS	PART NO.	SIZE	DESCRIPTION
1	Valve Cover Gasket	FP-R123543		
1	Head Gasket	FP-R116516		
1	Head Set	FP-RE66083		
QTY	VALVE	PART NO.	SIZE	DESCRIPTION
6	Intake	FP-R98062	STD	1 groove; Chrome plated stem; 1.8350" Head Dia., .3100" Stem Dia., 5.2780" O.A.L.
6	Intake	FP-R97490	15	1 groove; Chrome plated stem; 1.8350" Head Dia., .3250" Stem Dia., 5.2780" O.A.L.
6	Exhaust	FP-R90692	STD	1 groove; Chrome plated stem; 1.6730" Head Dia., .3095" Stem Dia., 5.2550" O.A.L.
6	Exhaust	FP-R97492	15	1 groove; Chrome plated stem; 1.6730" Head Dia., .3245" Stem Dia., 5.2550" O.A.L.
24	Keeper	FP-R91889		
QTY	VALVE SEAT	PART NO.	SIZE	DESCRIPTION
6	Exh.	FP-R85687	STD	
6	Int.	FP-R98335		.020" Dia. O/S face width; 1.8575" OD, 1.5500" ID, .2580" Depth
6	Int.	FP-R98063	STD	1.8575" OD, 1.5500" ID, .2580" Depth
QTY	VALVE SPRING	PART NO.	SIZE	DESCRIPTION
12	Spring	FP-R26125		2.1200" Free Height
QTY	VALVE MISC.	PART NO.	SIZE	DESCRIPTION
12	Rotocap	FP-RE60005		Exh. & Int.
QTY	VALVE SEAL	PART NO.	SIZE	DESCRIPTION
12	Valve Stem Seal	FP-RE31617		Exh. & Int.; From Ser. No. 300,000; Positive type
12	Valve Stem Seal	FP-R87627		Exh. & Int.; O-Ring type

### ELECTRICAL

QTY	ELECTRICAL	PART NO.	SIZE	DESCRIPTION
1	Starter to Block Gasket	FP-R53108		3-Hole mount; Starting motor codes 3003, 3006, 3010, 3011, 3013, 3025, 3026

### FUEL SYSTEM & PARTS

QTY	FUEL INJECTION	PART NO.	SIZE	DESCRIPTION
6	Fuel Injector Seal	FP-R92352		Upper packing
6	Washer Type Seal	FP-R48000		Lower packing
11	Washer Type Seal	FP-R51936		Fuel line; Line code 16LR; From Ser. No. 707,096
11	Washer Type Seal	FP-R51936		Fuel line; Line codes 1613, 1614, 1615, 1622, 1623, 1668, 1678, 1686, 1696

### COOLING SYSTEM

QTY	WATER PUMP	PART NO.	SIZE	DESCRIPTION
1	Water Pump - Heavy Duty	FP-RE500737 *		Standard flow
1	Water Pump Filter	FP-R98527		w/Pump housing marked RE70683, RE70985
QTY	THERMOSTAT	PART NO.	SIZE	DESCRIPTION
1	Thermostat	FP-RE33705		w/Housing marked T19651, T20218, R60256, R127777; 180 Deg.

(continued on next page)

\* New Item — Check For Availability

**104** Combine 6068D PowerTech Eng. Cotton Picker 6068D PowerTech Eng. Grader 6068D PowerTech Eng. Loader 6068D PowerTech Eng. Power Unit 6068D PowerTech Eng. Wheel Tractor 6068D PowerTech Eng. Forestry Tractor 6068D PowerTech Eng. Excavator 6068D PowerTech Eng. Skidder 6068D PowerTech Eng. Dozer 6068D PowerTech Eng. Sprayer 6068D PowerTech Eng.  
6.8L 413.8 (6784cc) OHV Diesel L6 (PowerTech 2V), 106mm Bore

### ENGINE BLOCK & PARTS

QTY	GASKETS	PART NO.	SIZE	DESCRIPTION
1	Oil Pan Gasket	FP-R123354		
2	O-Ring	FP-U13639		Block coolant drain plug seal; Coolant heater codes 2601, 2602; 1.475" X .118"
QTY	CAM BEARINGS	PART NO.	SIZE	DESCRIPTION
1	Cam Brg.	FP-R119874		
CRANKSHAFT/OIL PUMP				
QTY	SEALS - FRONT CRANK	PART NO.	SIZE	DESCRIPTION
1	O-Ring	FP-H35244		Crankshaft Pulley
QTY	SEALS - REAR CRANK	PART NO.	SIZE	DESCRIPTION
1	Crankshaft Rear Seal	FP-RE24959		
QTY	MAIN BEARINGS	PART NO.	SIZE	DESCRIPTION
6	Plain Main Brg.	FP-RE65165	STD	Crankshaft and Bearing code 4702
6	Plain Main Brg.	FP-RE65911	.25MM	Crankshaft and Bearing code 4702
1	Flanged Main Brg.	FP-RE65168	STD	Crankshaft and Bearing code 4702
1	Flanged Main Brg.	FP-RE65912	.25MM	Crankshaft and Bearing code 4702
QTY	OIL PUMP	PART NO.	SIZE	DESCRIPTION
1	O-Ring	FP-R61871		Oil tube from pump to block

### CYLINDER COMPONENTS

QTY	LINERS	PART NO.	SIZE	DESCRIPTION
6	Liner w/o Sealing Ring	FP-R121867	STD	
6	Liner w/Sealing Rings	FP-RE500024	STD	
6	Cylinder Kit Complete	FP-RE65966	STD	
6	Cyl. Liner Sealing Ring Kit	FP-AR65507		
QTY	PISTONS	PART NO.	SIZE	DESCRIPTION
6	Piston Body w/o Pin	FP-RE505101	STD	Con. Rod, Bearing & Piston code 4805
6	Pin	FP-R123178		Con. Rod, Bearing & Piston code 4805; 1.375" pin dia.
12	Piston Pin Retainer	FP-M41029		Con. Rod, Bearing & Piston code 4805; For 1.38" pin dia.
6	Pin Bushing	FP-R123960		Con. Rod, Bearing & Piston code 4805; 1.375" pin dia.
QTY	CONNECTING RODS & BRGS.	PART NO.	SIZE	DESCRIPTION
12	Con. Rod Bolt	FP-R114083		Con. Rod, Bearing & Piston code 4805; w/Con. Rod marked R123959; To Ser. No. 794,054; Machine split rod
12	Con. Rod Bolt	FP-R501124		Con. Rod, Bearing & Piston code 4805; w/Con. Rod marked R500000; From Ser. No. 794,055; Fractured split rod
6	Rod Pair	FP-RE65908	STD	Con. Rod, Bearing & Piston code 4805; w/Con. Rod marked R123959, R500000
6	Rod Pair	FP-RE65909	.25MM	Con. Rod, Bearing & Piston code 4805; w/Con. Rod marked R123959, R500000
QTY	PISTON RINGS	PART NO.	SIZE	DESCRIPTION
6	Ring Set Single Cylinder	FP-RE66271	STD	

### KITS

QTY	OVERHAUL KIT	PART NO.	SIZE	DESCRIPTION
1	In-Frame Overhaul Kit	FP-IFKPT6068		

**105** Power Unit 6068N PowerTech Eng. (Natural Gas). Wheel Tractor 6068N PowerTech Eng. (Natural Gas).  
6.8L 413.8 (6784cc) OHV NG L6 (PowerTech 2V), 106mm Bore

### CYL. HEAD & PARTS

QTY	GASKETS	PART NO.	SIZE	DESCRIPTION
1	Valve Cover Gasket	FP-R123543		
1	Head Gasket	FP-R116516		
QTY	VALVE	PART NO.	SIZE	DESCRIPTION
24	Keeper	FP-R91889		Head & valve code 5113
QTY	VALVE SPRING	PART NO.	SIZE	DESCRIPTION
12	Spring	FP-R26125		Head & valve code 5113; 2.1200" Free Height

(continued on next page)



# John Deere Off Highway

*Power Unit 6068N PowerTech Eng. (Natural Gas). Wheel Tractor 6068N PowerTech Eng. 105 (Natural Gas). (cont.)*  
6.8L 413.8 (6784cc) OHV NG L6 (PowerTech 2V), 106mm Bore

**CYL. HEAD & PARTS (cont.)**

QTY	VALVE MISC.	PART NO.	SIZE	DESCRIPTION
12	Rotocap	FP-RE60005		Exh. & Int.; Head & valve code 5113

**INT & EXH MANIFOLDS**

QTY	INT. & EXH. MANIFOLDS	PART NO.	SIZE	DESCRIPTION
6	Exhaust Manifold Gasket	FP-R90658		Exh. manifold, shield code 2817

**COOLING SYSTEM**

QTY	WATER PUMP	PART NO.	SIZE	DESCRIPTION
1	Water Pump Filter	FP-R98527		Water pump code 4404; Pump marked R500401

QTY	THERMOSTAT	PART NO.	SIZE	DESCRIPTION
1	Thermostat	FP-AR72852		Thermostat code 2203; 192 Deg.
1	O-Ring	FP-R26286		Sensor seal; Thermostat codes 2108, 2203

**ENGINE BLOCK & PARTS**

QTY	GASKETS	PART NO.	SIZE	DESCRIPTION
1	Oil Pan Gasket	FP-R123354		
2	O-Ring	FP-U13639		Block coolant drain plug seal; Block code 4604; 1.475" X .118"

QTY	CAM BEARINGS	PART NO.	SIZE	DESCRIPTION
1	Cam Brg.	FP-R119874		Block code 4604

**CRANKSHAFT/OIL PUMP**

QTY	MAIN BEARINGS	PART NO.	SIZE	DESCRIPTION
6	Plain Main Brg.	FP-RE65165	STD	Crankshaft and Bearing code 4702; w/Crankshaft marked R116076
6	Plain Main Brg.	FP-RE65911	.25MM	Crankshaft and Bearing code 4702; w/Crankshaft marked R116076
1	Flanged Main Brg.	FP-RE65168	STD	Crankshaft and Bearing code 4702; w/Crankshaft marked R116076
1	Flanged Main Brg.	FP-RE65912	.25MM	Crankshaft and Bearing code 4702; w/Crankshaft marked R116076

QTY	OIL PUMP	PART NO.	SIZE	DESCRIPTION
1	O-Ring	FP-R61871		Oil pump code 5001; Oil pump inlet seal
1	O-Ring	FP-R72328		Vent tube elbow seal; Rocker arm cover code 1104

**CYLINDER COMPONENTS**

QTY	LINERS	PART NO.	SIZE	DESCRIPTION
6	Cyl. Liner Sealing Ring Kit	FP-AR65507		Piston & rod bearing code 4811

QTY	PISTONS	PART NO.	SIZE	DESCRIPTION
6	Pin	FP-R123177		Piston & rod bearing code 4811; 1.62" pin dia.
12	Piston Pin Retainer	FP-R54114		Piston & rod bearing code 4811; For 1.62" pin dia.
6	Pin Bushing	FP-R114082		Use w/Con. Rod marked R500335
6	Piston Pin Kit	FP-RE63915		Piston & rod bearing code 4811; Incl. Pin, Retainers & Bushing

QTY	CONNECTING RODS & BRGS.	PART NO.	SIZE	DESCRIPTION
12	Con. Rod Bolt	FP-R501124		Use w/Con. Rod marked R500335
6	Rod Pair	FP-RE65908	STD	Piston & rod bearing code 4811
6	Rod Pair	FP-RE65909	.25MM	Piston & Rod bearing code 4811

QTY	PISTON RINGS	PART NO.	SIZE	DESCRIPTION
6	Ring Set Single Cylinder	FP-RE507852	STD	Piston & rod bearing code 4811; 1-1/8, 1-3/32, 1-.136 (1 cyl. set)
6	Ring Set Single Cylinder	FP-RE66820	STD	Piston & rod bearing code 4811; 1-1/8, 1-3/32, 1-.136 (1 cyl. set)

*Cotton Picker 6068T Eng. Loader 6068T Eng. Crawler Tractor 6068T Eng. Excavator 6068T 106 Eng. Skidder 6068T Eng. Feller Buncher 6068T Eng.*  
6.8L 413.8 (6784cc) OHV Turbo-Diesel L6 (Litre Engine), 106mm Bore

**CYL. HEAD & PARTS**

QTY	GASKETS	PART NO.	SIZE	DESCRIPTION
1	Valve Cover Gasket	FP-R75728		RePower Engs.; Valve cover code 1110
1	Valve Cover Gasket	FP-R75728		Rocker cover codes 1102, 1103, 1104
1	Head Gasket	FP-R114157		Cyl. head code 5101
1	Head Set	FP-RE29859		Cyl. head code 5101

QTY	VALVE	PART NO.	SIZE	DESCRIPTION
6	Intake	FP-R98062	STD	1 groove; Chrome plated stem; 1.8350" Head Dia., .3100" Stem Dia., 5.2780" O.A.L.

(continued on next page)

**106** Cotton Picker 6068T Eng. Loader 6068T Eng. Crawler Tractor 6068T Eng. Excavator 6068T Eng. Skidder 6068T Eng. Feller Buncher 6068T Eng.  
6.8L 413.8 (6784cc) OHV Turbo-Diesel L6 (Litre Engine), 106mm Bore

## CYL. HEAD & PARTS (cont.)

QTY	VALVE (cont.)	PART NO.	SIZE	DESCRIPTION
6	Intake	FP-R97490	15	1 groove; Chrome plated stem; 1.8350" Head Dia., .3250" Stem Dia., 5.2780" O.A.L.
6	Exhaust	FP-R90692	STD	1 groove; Chrome plated stem; 1.6730" Head Dia., .3095" Stem Dia., 5.2550" O.A.L.
6	Exhaust	FP-R97492	15	1 groove; Chrome plated stem; 1.6730" Head Dia., .3245" Stem Dia., 5.2550" O.A.L.
24	Keeper	FP-R91889		
QTY	VALVE SEAT	PART NO.	SIZE	DESCRIPTION
6	Exh.	FP-R85687	STD	
6	Int.	FP-R98335		.020" Dia. O/S face width; 1.8575" OD, 1.5500" ID, .2580" Depth
6	Int.	FP-R98063	STD	1.8575" OD, 1.5500" ID, .2580" Depth
QTY	VALVE SPRING	PART NO.	SIZE	DESCRIPTION
12	Spring	FP-R26125		2.1200" Free Height
QTY	VALVE MISC.	PART NO.	SIZE	DESCRIPTION
12	Rotocap	FP-RE60005		Exh. & Int.
1	Oil Filler Cap Gasket	FP-T20328		Rocker arm cover code 1103; Oil filler neck codes 1201, 1202, 1203
QTY	VALVE SEAL	PART NO.	SIZE	DESCRIPTION
12	Valve Stem Seal	FP-RE31617		Exh. & Int.; From Ser. No. 300,000; Positive type
12	Valve Stem Seal	FP-R87627		Exh. & Int.; O-Ring type
QTY	ROCKER PARTS	PART NO.	SIZE	DESCRIPTION
1	O-Ring	FP-R56463		Rocker cover breather tube; Breather tube codes 2902, 2905, 2909, 2912
1	O-Ring	FP-R56463		Rocker cover breather tube; RePower Eng.s.; Breather tube code 2909
ELECTRICAL				
QTY	ELECTRICAL	PART NO.	SIZE	DESCRIPTION
1	Starter to Block Gasket	FP-R53108		3-Hole mount; Starting motor codes 3002, 3007, 3011, 3013, 3015, 3016, 3017, 3018, 3019
QTY	ALTERNATOR	PART NO.	SIZE	DESCRIPTION
1	Ball Brg.	FP-JD9449		Front; w/24 Volt alternator conversion
1	Ball Brg.	FP-JD9449		Front; Delco-Remy No. 1102936; Code 3105; 12 Volt, 61 amp alternator
1	Ball Brg.	FP-JD9449		Front; Delco-Remy Nos. 1100490, 1102932, 1105174; Code 3103; 12 Volt, 72 amp alternator
1	Ball Brg.	FP-JD9449		Front; Delco-Remy Nos. 1100491, 1100580; Code 3102
1	Ball Brg.	FP-JD9449		Front; Motorola No. 8TA2009ES; Code 3104; 12 Volt, 30 amp alternator
2	Ball Brg.	FP-JD9449		Front & Rear; Motorola No. 70D42179T02; 24 Volt alternator
2	Ball Brg.	FP-JD9449		Front & Rear; Motorola Replacement Nos. 8EM2009NA, 8EM2009NB alternator
INT & EXH MANIFOLDS				
QTY	INT. & EXH. MANIFOLDS	PART NO.	SIZE	DESCRIPTION
6	Exhaust Manifold Gasket	FP-R90658		
2	Air Intake Gasket	FP-R81275		
QTY	AIR INTAKE	PART NO.	SIZE	DESCRIPTION
1	O-Ring	FP-R56905		Air intake system code 1709
1	O-Ring	FP-R56905		RePower Eng.s.; Air intake system code 1733
CAMSHAFT GROUP				
QTY	TIMING COVER	PART NO.	SIZE	DESCRIPTION
1	Timing Gear Cover Gasket	FP-T20273		Access cover
1	Timing Gear Cover Gasket	FP-R97454		Front cover
QTY	CAMSHAFT/LIFTER	PART NO.	SIZE	DESCRIPTION
12	Lifter	FP-T20073		
FUEL SYSTEM & PARTS				
QTY	FUEL INJECTION	PART NO.	SIZE	DESCRIPTION
1	Injector Pump Gasket	FP-R125066		Gear cover
6	Fuel Injector Nozzle	FP-RE36939		w/Injector marked 28484
6	Fuel Injector Seal	FP-R79605		Fuel line connection; Nozzle codes 1622, 1623, 1642, 1643, 1654; Nozzle marked 28484; 9.270MM X 13.600MM X 5.080MM
6	Fuel Injector Nut	FP-R79604		w/Injector marked 28484

(continued on next page)





# John Deere Off Highway

Cotton Picker 6068T Eng. Loader 6068T Eng. Crawler Tractor 6068T Eng. Excavator 6068T 106  
 Eng. Skidder 6068T Eng. Feller Buncher 6068T Eng. (cont.)  
 6.8L 413.8 (6784cc) OHV Turbo-Diesel L6 (Litre Engine), 106mm Bore

## FUEL SYSTEM & PARTS (cont.)

QTY	FUEL INJECTION (cont.)	PART NO.	SIZE	DESCRIPTION
12	Washer Type Seal	FP-R51936		Leak-off & return line seals; Nozzle codes 1602, 1610, 1612, 1619
QTY	<b>TURBOCHARGER</b>	<b>PART NO.</b>	<b>SIZE</b>	<b>DESCRIPTION</b>
1	Turbocharger Oil Drain Gasket	FP-R105346		w/Turbo oil line codes 6501, 6502, 6506, 6512, 6568
1	Turbocharger Mounting Gasket	FP-R43751		From Ser. No. 100,000 to Ser. No. 499,999; Codes 6506, 6512
1	Turbocharger Mounting Gasket	FP-R89879		RePower Eng.s.; Codes 6502, 6506, 6568

## COOLING SYSTEM

QTY	WATER PUMP	PART NO.	SIZE	DESCRIPTION
1	Water Pump Shaft	FP-R82052		w/Pump housing marked R80168
1	Water Pump Impeller	FP-R47191		w/Pump housing marked R66420, R68733
1	Water Pump Impeller	FP-R56812		w/Pump housing marked R80168, R90784, R104648, R120869
1	Water Pump Repair/Rebuild Kit	FP-RE19511		w/Pump housing marked R60601, R67741, R67748, R72644
1	Water Pump Repair/Rebuild Kit	FP-RE62661		w/Pump housing marked R66420, R68733
1	Water Pump Repair/Rebuild Kit	FP-RE70143		From Ser. No. 100,000 to Ser. No. 499,999; w/Cast iron impeller
2	Ball Brg.	FP-JD7686		Front/Rear shaft bearing; Pump code 2025; w/Pump housing marked R80168, R120869; w/H/D water pump
2	Ball Brg.	FP-JD7686		Front/Rear shaft bearing; Pump code 2025; RePower Eng.s.; w/Pump housing marked R80168
2	Ball Brg.	FP-JD10329		Front & Rear; Fan hub shaft bearing; w/Pump housing marked R120869, R80168
1	Water Pump Housing Gasket	FP-R56809		w/Pump housing marked R90783
1	Oil Seal Kit	FP-AR101549		Water Pump; w/Pump housing marked R80168, R90784, R104648, R120869
1	Water Pump Mounting Gasket	FP-T20243		w/Pump housing marked R80168, R90783, R90784, R104648, R120869
1	Oil Seal	FP-AR90860		Pump code 2025; w/H/D water pump; w/housing marked R80168, R120869
1	Oil Seal	FP-AR90860		RePower Eng.s.; Pump code 2025; w/housing marked R80168
1	Shaft & Bearing Assembly	FP-JD8643		w/Pump housing marked R90784, R104648
QTY	<b>THERMOSTAT</b>	<b>PART NO.</b>	<b>SIZE</b>	<b>DESCRIPTION</b>
2	Thermostat	FP-AR48675		Thermostat code 2204; Thermostat cover code 2102 Vertical, 2104 Horizontal; Housing code 3901; 180 Deg.
1	Thermostat Cover Gasket	FP-R54638		Thermostat cover codes 2102, 2104, 2108; Thermostat housing code 3901; w/Two thermostats
1	Therm. Hsg. - Water Mfld. Gsk	FP-R54641		Thermostat housing to cyl. head
2	O-Ring	FP-R56461		Thermostat housing tube seals; Housing codes 3901, 3905

## ENGINE BLOCK & PARTS

QTY	GASKETS	PART NO.	SIZE	DESCRIPTION
1	Flywheel Housing Gasket	FP-R97351		
1	Oil Pan Gasket Set	FP-PG303PS		
2	O-Ring	FP-U13639		Block coolant drain plug seal; Coolant heater codes 2601, 2602; 1.475" X .118"
1	Block to End Plate Front Gskt	FP-R131794		Front plate codes 3601, 3602
QTY	<b>GASKET SETS</b>	<b>PART NO.</b>	<b>SIZE</b>	<b>DESCRIPTION</b>
1	In-Frame Gasket Set	FP-PG359S		
1	Complete Overhaul Gasket Set	FP-RE38555		Crankshaft seals not incl.
1	Complete Overhaul Gasket Set	FP-RE38555WS		Incl. crankshaft seals; Rear main brg. seal incl.; Wear sleeve not incl.
QTY	<b>CAM BEARINGS</b>	<b>PART NO.</b>	<b>SIZE</b>	<b>DESCRIPTION</b>
1	Cam Brg.	FP-R119874		From Ser. No. 100,000 to Ser. No. 499,999
QTY	<b>OIL COOLERS &amp; FILTERS</b>	<b>PART NO.</b>	<b>SIZE</b>	<b>DESCRIPTION</b>
1	Oil Cooler Gasket	FP-R27948		Lower core to housing ; Cooler code 5911
1	Oil Cooler Gasket	FP-R98485		Lower cover to housing gskt.
1	Oil Cooler Gasket	FP-R98484		Oil cooler core to housing gskt.
1	Oil Cooler Gasket	FP-R98485		RePower Eng.s.; From Ser. No. 100,000 to Ser. No. 499,999; Lower cover to housing gskt.
1	Oil Cooler Gasket	FP-R98484		RePower Eng.s.; From Ser. No. 100,000 to Ser. No. 499,999; Oil cooler core to housing gskt.
1	O-Ring	FP-R56462		Oil cooler adapter code 5913; Adapter cover bolt seal
1	O-Ring	FP-R56192		Oil cooler housing inner seal; Cooler code 5911
1	O-Ring	FP-R56814		Oil cooler housing inner seal; Cooler codes 5908, 5909, 5912
1	O-Ring	FP-R56192		Oil cooler housing inner seal; RePower Eng.s.; Cooler code 5909
1	O-Ring	FP-R56193		Oil cooler housing outer seal; Cooler code 5911
1	O-Ring	FP-R56193		Oil cooler housing outer seal; RePower Eng.s.; Cooler code 5909

(continued on next page)

**106** Cotton Picker 6068T Eng. Loader 6068T Eng. Crawler Tractor 6068T Eng. Excavator 6068T  
 (cont.) Eng. Skidder 6068T Eng. Feller Buncher 6068T Eng.  
 6.8L 413.8 (6784cc) OHV Turbo-Diesel L6 (Litre Engine), 106mm Bore

## ENGINE BLOCK & PARTS (cont.)

OIL COOLERS & FILTERS				
QTY	(cont.)	PART NO.	SIZE	DESCRIPTION
1	Rect. or Square Seal	FP-R70956		Cooler housing; Cooler code 5904; Ten plates; 2.700" X 3.000" X .180"
1	Oil Cooler Cover Gasket	FP-R98471		
1	Oil Cooler to Block Gasket	FP-R98489		From Ser. No. 100,000 to Ser. No. 499,999
1	Oil Cooler to Block Gasket	FP-R98489		RePower Eng.s.; From Ser. No. 100,000 to Ser. No. 499,999
1	Oil Cooler Adapter Cover Gskt	FP-R114097		Filter adapter code 5904; From Ser. No. 100,000 to Ser. No. 499,999

## CRANKSHAFT/OIL PUMP

QTY	CRANKSHAFT	PART NO.	SIZE	DESCRIPTION
1	Crankshaft	FP-RE45517		
1	Oil Seal Kit	FP-SK67942		RePower Eng.s.; Crankshaft code 4701; w/Crankshaft marked R104523, R121027; Incl. front & rear seals

QTY	SEALS - FRONT CRANK	PART NO.	SIZE	DESCRIPTION
1	Crankshaft Front Seal	FP-AR67942		
1	O-Ring	FP-H35244		Crankshaft pulley; Pulley codes 1303, 1308; Crankshaft, Bearing code 4701; Crankshaft marked R104523, R121027

QTY	SEALS - REAR CRANK	PART NO.	SIZE	DESCRIPTION
1	Crankshaft Rear Seal	FP-RE24959		

QTY	MAIN BEARINGS	PART NO.	SIZE	DESCRIPTION
1	Main Set	FP-MBK3006	STD	
1	Main Set	FP-MBK300610	10	
1	Main Set	FP-MBK300620	20	
1	Main Set	FP-MBK300630	30	
6	Plain Main Brg.	FP-RE27352	STD	w/Flangeless thrust brg.
6	Plain Main Brg.	FP-RE27353	10	w/Flangeless thrust brg.
6	Plain Main Brg.	FP-RE27360	20	w/Flangeless thrust brg.
6	Plain Main Brg.	FP-RE27368	30	w/Flangeless thrust brg.
1	Flanged Main Brg.	FP-RE521350	STD	
1	Flanged Main Brg.	FP-RE526754	10	
1	Flanged Main Brg.	FP-RE527235	20	
1	Flanged Main Brg.	FP-RE527236	30	

QTY	OIL PUMP	PART NO.	SIZE	DESCRIPTION
1	O-Ring	FP-R61871		Oil pump inlet; H/D Pump code 5003
1	O-Ring	FP-R61871		Oil pump inlet; Pump codes 5001, 5002, 5005; From Ser. No. 427,376; w/Pump housing marked R54615
1	O-Ring	FP-R61871		Oil pump inlet; RePower Eng.s.; Pump codes 5012
2	O-Ring	FP-R80632		Oil Pump outlet
1	Oil Filler Inlet Gasket	FP-R97352		Oil filler neck codes 1201, 1202, 1203, 1299
1	Oil Filter Adapter Gasket	FP-R98488		w/Filter adapter marked R56189, R91597, R113646, R131238
1	Oil Pump Seal Ring	FP-R79563		Oil pump outlet adapter; Pump codes 5001, 5002; w/Pump marked R54629

## CYLINDER COMPONENTS

QTY	LINERS	PART NO.	SIZE	DESCRIPTION
6	Liner w/o Sealing Ring	FP-R121867	STD	
6	Liner w/Sealing Rings	FP-RE500024	STD	
6	Cylinder Kit Complete	FP-RE53073	STD	Hi-Ring
6	Cyl. Liner Sealing Ring Kit	FP-AR65507		
6	Sealing Ring, Liner	FP-R48767		Rectangle; Top
6	Sealing Ring, Liner	FP-R26121		Round; Middle
6	Sealing Ring	FP-SLR2520		Round; Bottom

QTY	PISTONS	PART NO.	SIZE	DESCRIPTION
6	Piston Body w/o Pin	FP-RE48469	STD	Hi-Ring
6	Piston Kit w/Pin & Retainers	FP-AR96389WP		w/Con. Rod marked 56187
6	Piston Kit w/Pin & Retainers	FP-RE48469WP		Hi-Ring
6	Pin	FP-R124230		Hi-Ring; 1.62" pin dia.
12	Piston Pin Retainer	FP-R54114		Hi-Ring; For 1.62" pin dia.
6	Pin Bushing	FP-R57451		w/Con. Rod marked R56187, R58979, R80032, R113612; Pin dia. 1.62"; 1.621" ID, 1.813" OD, 1.370" O.A.L.
6	Pin Bushing	FP-R114082		Con. Rod, Bearing & Piston code 4810; w/Con. Rod marked R500335

(continued on next page)



# John Deere Off Highway

*Cotton Picker 6068T Eng. Loader 6068T Eng. Crawler Tractor 6068T Eng. Excavator 6068T 106  
Eng. Skidder 6068T Eng. Feller Buncher 6068T Eng. (cont.)  
6.8L 413.8 (6784cc) OHV Turbo-Diesel L6 (Litre Engine), 106mm Bore*

## CYLINDER COMPONENTS (cont.)

QTY	CONNECTING RODS & BRGS.	PART NO.	SIZE	DESCRIPTION
12	Con. Rod Bolt	FP-R74195		w/Con. Rod marked R54617, R56187, R116851; Torque-To-Yield bolt; Replacement recommended
6	Rod Pair	FP-AR97517	STD	
6	Rod Pair	FP-AR97653	10	
6	Rod Pair	FP-AR97654	20	
6	Rod Pair	FP-AR97655	30	
QTY	PISTON RINGS	PART NO.	SIZE	DESCRIPTION
6	Ring Set Single Cylinder	FP-RE507852	STD	1-1/8, 1-3/32, 1-.136 (1 cyl. set)
6	Ring Set Single Cylinder	FP-RE66820	STD	1-1/8, 1-3/32, 1-.136 (1 cyl. set)
KITS				
QTY	OVERHAUL KIT	PART NO.	SIZE	DESCRIPTION
1	In-Frame Overhaul Kit	FP-6068TIFK		w/Con. Rod marked R54617, R56187, R116851; w/Flangeless thrust brg.; Hi-Ring; Incl. Torque-To-Yield con. rod bolts
1	Complete Overhaul Kit	FP-6068TOHK		From Ser. No. 100,000 to Ser. No. 499,999; w/Con. Rod marked R56187; Piston pin dia. 1.62"; w/Flangeless thrust brg.; Incl. front & rear seals; RePower Eng.s.; Crankshaft code 4701; Crankshaft marked R104523, R121027; Hi-Ring; Incl. Torque-To-Yield con. rod bolts

*Power Unit 6068TN PowerTech Eng. (Natural Gas). Wheel Tractor 6068TN PowerTech 107  
Eng. (Natural Gas).  
6.8L 413.8 (6784cc) OHV Turbo-NG L6 (PowerTech 2V), 106mm Bore*

## CYL. HEAD & PARTS

QTY	GASKETS	PART NO.	SIZE	DESCRIPTION
1	Valve Cover Gasket	FP-R123543		
1	Head Gasket	FP-R116516		
QTY	VALVE	PART NO.	SIZE	DESCRIPTION
24	Keeper	FP-R91889		Head & valve code 5113
QTY	VALVE SPRING	PART NO.	SIZE	DESCRIPTION
12	Spring	FP-R26125		Head & valve code 5113; 2.1200" Free Height
QTY	VALVE MISC.	PART NO.	SIZE	DESCRIPTION
12	Rotocap	FP-RE60005		Exh. & Int.; Head & valve code 5113

## INT & EXH MANIFOLDS

QTY	INT. & EXH. MANIFOLDS	PART NO.	SIZE	DESCRIPTION
6	Exhaust Manifold Gasket	FP-R90658		Exh. manifold, shield code 2817

## FUEL SYSTEM & PARTS

QTY	TURBOCHARGER	PART NO.	SIZE	DESCRIPTION
1	O-Ring	FP-R80632		Turbo oil line code 6529; Oil inlet adapter seal

## COOLING SYSTEM

QTY	WATER PUMP	PART NO.	SIZE	DESCRIPTION
1	Water Pump Filter	FP-R98527		Water pump code 4404; Pump marked R500401, R500734; High Flow
QTY	THERMOSTAT	PART NO.	SIZE	DESCRIPTION
1	Thermostat	FP-AR72852		Thermostat code 2203; 192 Deg.
1	O-Ring	FP-R26286		Sensor seal; Thermostat codes 2108, 2203

## ENGINE BLOCK & PARTS

QTY	GASKETS	PART NO.	SIZE	DESCRIPTION
2	O-Ring	FP-U13639		Block coolant drain plug seal; Block code 4604; 1.475" X .118"
QTY	CAM BEARINGS	PART NO.	SIZE	DESCRIPTION
1	Cam Brg.	FP-R119874		Block code 4604

## CRANKSHAFT/OIL PUMP

QTY	MAIN BEARINGS	PART NO.	SIZE	DESCRIPTION
6	Plain Main Brg.	FP-RE65165	STD	Crankshaft and Bearing codes 4702, 4703; w/Crankshaft marked R116076
6	Plain Main Brg.	FP-RE65911	.25MM	Crankshaft and Bearing codes 4702, 4703; w/Crankshaft marked R116076
1	Flanged Main Brg.	FP-RE65168	STD	Crankshaft and Bearing codes 4702, 4703; w/Crankshaft marked R116076

(continued on next page)

**107 Power Unit 6068TN PowerTech Eng. (Natural Gas). Wheel Tractor 6068TN PowerTech Eng. (Natural Gas).**  
6.8L 413.8 (6784cc) OHV Turbo-NG L6 (PowerTech 2V), 106mm Bore

**CRANKSHAFT/OIL PUMP (cont.)**

QTY	DESCRIPTION	PART NO.	SIZE	DESCRIPTION
1	MAIN BEARINGS (cont.) Flanged Main Brg.	FP-RE65912	.25MM	Crankshaft and Bearing codes 4702, 4703; w/Crankshaft marked R116076
1	O-Ring	FP-R61871		Oil pump code 5001; Oil pump inlet seal
1	O-Ring	FP-R72328		Vent tube elbow seal; Rocker arm cover code 1104

**CYLINDER COMPONENTS**

QTY	DESCRIPTION	PART NO.	SIZE	DESCRIPTION
6	LINERS Cyl. Liner Sealing Ring Kit	FP-AR65507		Piston & rod bearing code 4811
6	PISTONS Pin Piston Pin Retainer Pin Bushing Piston Pin Kit	FP-R123177		Piston & rod bearing code 4811; 1.62" pin dia.
12		FP-R54114		Piston & rod bearing code 4811; For 1.62" pin dia.
6		FP-R114082		Use w/Con. Rod marked R500335
6		FP-RE63915		Piston & rod bearing code 4811; Incl. Pin, Retainers & Bushing
12	CONNECTING RODS & BRGS. Con. Rod Bolt Rod Pair Rod Pair	FP-R501124		Use w/Con. Rod marked R500335
6		FP-RE65908	STD	Piston & rod bearing code 4811; w/Con. Rod marked R114081
6		FP-RE65909	.25MM	Piston & Rod bearing code 4811; w/Con. Rod marked R114081
6	PISTON RINGS Ring Set Single Cylinder Ring Set Single Cylinder	FP-RE507852	STD	Piston & rod bearing code 4811; 1-1/8, 1-3/32, 1-.136 (1 cyl. set)
6		FP-RE66820	STD	Piston & rod bearing code 4811; 1-1/8, 1-3/32, 1-.136 (1 cyl. set)

**108 Combine 6068T PowerTech Eng. Cotton Picker 6068T PowerTech Eng. Grader 6068T PowerTech Eng. Loader 6068T PowerTech Eng. Power Unit 6068T PowerTech Eng. Wheel Tractor 6068T PowerTech Eng. Windrower 6068T PowerTech Eng. Crawler Tractor 6068T PowerTech Eng. Loader Tractor 6068T PowerTech Eng. Forestry Tractor 6068T PowerTech Eng. Excavator 6068T PowerTech Eng. Skidder 6068T PowerTech Eng. Dozer 6068T PowerTech Eng. Backhoe 6068T PowerTech Eng. Sprayer 6068T PowerTech Eng. Integrated Tool Carrier 6068T PowerTech Eng.**  
6.8L 413.8 (6784cc) OHV Turbo-Diesel L6 (PowerTech 2V), 106mm Bore

**CYL. HEAD & PARTS**

QTY	DESCRIPTION	PART NO.	SIZE	DESCRIPTION
1	GASKETS Valve Cover Gasket Head Gasket Head Set	FP-R123543		
1		FP-R116516		
1		FP-RE66083		
6	VALVE Intake Intake Exhaust Exhaust Keeper	FP-R98062	STD	1 groove; Chrome plated stem; 1.8350" Head Dia., .3100" Stem Dia., 5.2780" O.A.L.
6		FP-R97490	15	1 groove; Chrome plated stem; 1.8350" Head Dia., .3250" Stem Dia., 5.2780" O.A.L.
6		FP-R90692	STD	1 groove; Chrome plated stem; 1.6730" Head Dia., .3095" Stem Dia., 5.2550" O.A.L.
6		FP-R97492	15	1 groove; Chrome plated stem; 1.6730" Head Dia., .3245" Stem Dia., 5.2550" O.A.L.
24		FP-R91889		
6	VALVE SEAT Exh. Int. Int.	FP-R85687	STD	
6		FP-R98335		.020" Dia. O/S face width; 1.8575" OD, 1.5500" ID, .2580" Depth
6		FP-R98063	STD	1.8575" OD, 1.5500" ID, .2580" Depth
12	VALVE SPRING Spring	FP-R26125		2.1200" Free Height
12	VALVE MISC. Rotocap	FP-RE60005		Exh. & Int.
12	VALVE SEAL Valve Stem Seal Valve Stem Seal	FP-RE31617		Exh. & Int.; From Ser. No. 300,000; Positive type
12		FP-R87627		Exh. & Int.; O-Ring type

**ELECTRICAL**

QTY	DESCRIPTION	PART NO.	SIZE	DESCRIPTION
1	ELECTRICAL Starter to Block Gasket	FP-R53108		3-Hole mount; Starting motor codes 3003, 3006, 3010, 3011, 3013, 3025, 3026

(continued on next page)



**Combine 6068T PowerTech Eng. Cotton Picker 6068T PowerTech Eng. Grader 6068T 108**  
**PowerTech Eng. Loader 6068T PowerTech Eng. Power Unit 6068T PowerTech Eng. (cont.)**  
**Wheel Tractor 6068T PowerTech Eng. Windrower 6068T PowerTech Eng. Crawler Tractor**  
**6068T PowerTech Eng. Loader Tractor 6068T PowerTech Eng. Forestry Tractor 6068T**  
**PowerTech Eng. Excavator 6068T PowerTech Eng. Skidder 6068T PowerTech Eng. Dozer**  
**6068T PowerTech Eng. Backhoe 6068T PowerTech Eng. Sprayer 6068T PowerTech Eng.**  
**Integrated Tool Carrier 6068T PowerTech Eng.**  
 6.8L 413.8 (6784cc) OHV Turbo-Diesel L6 (PowerTech 2V), 106mm Bore

FUEL SYSTEM & PARTS				
QTY	FUEL INJECTION	PART NO.	SIZE	DESCRIPTION
6	Fuel Injector Nozzle	FP-RE48786		
6	Fuel Injector Seal	FP-R92352		Upper packing
6	Washer Type Seal	FP-R48000		Lower packing
12	Washer Type Seal	FP-R51936		Fuel line; Line codes 1613, 1614, 1615, 1619, 1621, 1622, 1623, 1668, 1678, 1680, 1681, 1685, 1686, 1688, 1697, 160D; To Ser. No. 715,739
12	Washer Type Seal	FP-R51936		Fuel line; Line codes 1619, 1681, 1685, 1686, 1696, 1697, 16CM, 16CN, 16CP, 16CW, 16CX, 16CY, 16DY, 16LS, 16LT, 16LU, 16MG, 16MH, 16ML, 16MM
COOLING SYSTEM				
QTY	WATER PUMP	PART NO.	SIZE	DESCRIPTION
1	Water Pump - Heavy Duty	FP-RE500737 *		Standard flow
1	Water Pump Filter	FP-R98527		w/Pump housing marked RE70683, RE70985
1	Water Pump Filter	FP-R98527		w/Pump housing marked R500734; High Flow
ENGINE BLOCK & PARTS				
QTY	GASKETS	PART NO.	SIZE	DESCRIPTION
2	O-Ring	FP-U13639		Block coolant drain plug seal; Coolant heater codes 2601, 2602; 1.475" X .118"
QTY	CAM BEARINGS	PART NO.	SIZE	DESCRIPTION
1	Cam Brg.	FP-R119874		
CRANKSHAFT/OIL PUMP				
QTY	SEALS - REAR CRANK	PART NO.	SIZE	DESCRIPTION
1	Crankshaft Rear Seal	FP-RE24959		
QTY	MAIN BEARINGS	PART NO.	SIZE	DESCRIPTION
6	Plain Main Brg.	FP-RE65165	STD	Crankshaft and Bearing codes 4702, 4703
6	Plain Main Brg.	FP-RE65911	.25MM	Crankshaft and Bearing codes 4702, 4703
1	Flanged Main Brg.	FP-RE65168	STD	Crankshaft and Bearing codes 4702, 4703
1	Flanged Main Brg.	FP-RE65912	.25MM	Crankshaft and Bearing codes 4702, 4703
QTY	OIL PUMP	PART NO.	SIZE	DESCRIPTION
1	O-Ring	FP-R61871		Oil tube from pump to block
CYLINDER COMPONENTS				
QTY	LINERS	PART NO.	SIZE	DESCRIPTION
6	Liner w/o Sealing Ring	FP-R121867	STD	
6	Liner w/Sealing Rings	FP-RE500024	STD	
6	Cyl. Liner Sealing Ring Kit	FP-AR65507		
QTY	PISTONS	PART NO.	SIZE	DESCRIPTION
6	Piston Body w/o Pin	FP-RE55512	STD	Con. Rod Bearing & Piston code 4810
6	Piston Body w/o Pin	FP-RE505100	STD	Con. Rod, Bearing & Piston codes 4807
6	Pin	FP-R123178		Con. Rod, Bearing & Piston code 4807; 1.375" pin dia.
6	Pin	FP-R123177		Con. Rod, Bearing & Piston codes 4810; 1.62" pin dia.
12	Piston Pin Retainer	FP-M41029		Con. Rod, Bearing & Piston codes 4805, 4807; For 1.38" pin dia.
12	Piston Pin Retainer	FP-R54114		Con. Rod, Bearing & Piston codes 4810; For 1.62" pin dia.
6	Pin Bushing	FP-R114082		Con. Rod, Bearing & Piston code 4810; w/Con. Rod marked R500335
6	Pin Bushing	FP-R123960		Con. Rod, Bearing & Piston codes 4807, 4810; w/Con. Rod marked R500000, R123959; 1.375" pin dia.
6	Piston Pin Kit	FP-RE63915		Con. Rod, Bearing & Piston codes 4810; Incl. Pin, Retainers & Bushing
QTY	CONNECTING RODS & BRGS.	PART NO.	SIZE	DESCRIPTION
12	Con. Rod Bolt	FP-R114083		Cyl. Liner code 4807; w/Con. Rod marked R123959; To Ser. No. 794,054
12	Con. Rod Bolt	FP-R501124		Cyl. Liner code 4807,4810; w/Con. Rod marked R500000, R500335; From Ser. No. 794,055
12	Con. Rod Bolt	FP-R114083		Cyl. Liner codes 4807, 4810; w/Con. Rod marked R500000, R500335; From Ser. No. 794,055

(continued on next page)

\* New Item — Check For Availability

**108** Combine 6068T PowerTech Eng. Cotton Picker 6068T PowerTech Eng. Grader 6068T PowerTech Eng. Loader 6068T PowerTech Eng. Power Unit 6068T PowerTech Eng. Wheel Tractor 6068T PowerTech Eng. Windrower 6068T PowerTech Eng. Crawler Tractor 6068T PowerTech Eng. Loader Tractor 6068T PowerTech Eng. Forestry Tractor 6068T PowerTech Eng. Excavator 6068T PowerTech Eng. Skidder 6068T PowerTech Eng. Dozer 6068T PowerTech Eng. Backhoe 6068T PowerTech Eng. Sprayer 6068T PowerTech Eng. Integrated Tool Carrier 6068T PowerTech Eng.  
6.8L 413.8 (6784cc) OHV Turbo-Diesel L6 (PowerTech 2V), 106mm Bore

### CYLINDER COMPONENTS (cont.)

QTY	CONNECTING RODS & BRGS. (cont.)	PART NO.	SIZE	DESCRIPTION
6	Rod Pair	FP-RE65908	STD	Cyl. Liner codes 4807, 4810; w/Con. Rod marked R500000, R500335
6	Rod Pair	FP-RE65909	.25MM	Cyl. Liner codes 4807, 4810; w/Con. Rod marked R500000, R500335
QTY	PISTON RINGS	PART NO.	SIZE	DESCRIPTION
6	Ring Set Single Cylinder	FP-RE66271	STD	Piston & Liner code 4807
6	Ring Set Single Cylinder	FP-RE507852	STD	Piston & Liner code 4810; 1-1/8, 1-3/32, 1-.136 (1 cyl. set)
6	Ring Set Single Cylinder	FP-RE66820	STD	Piston & Liner code 4810; 1-1/8, 1-3/32, 1-.136 (1 cyl. set)

### KITS

QTY	OVERHAUL KIT	PART NO.	SIZE	DESCRIPTION
1	In-Frame Overhaul Kit	FP-IFKPT6068		Con. Rod, Bearing & Piston codes 4807

**109** Grader 6414D Eng. Loader 6414D Eng. Crawler Tractor 6414D Eng. Loader Tractor 6414D Eng. Skidder 6414D Eng.  
6.8L 414 OHV Diesel L6 (Standard), 4.1875" Bore

### CYL. HEAD & PARTS

QTY	GASKETS	PART NO.	SIZE	DESCRIPTION
1	Valve Cover Gasket	FP-R75728		Rocker cover codes 1102, 1103; From Ser. No. 608,511
1	Valve Cover Gasket	FP-T20467		To Ser. No. 103,088
1	Head Gasket	FP-R114157		From Ser. No. 100,001; Manufactured after 1983
1	Head Gasket	FP-R114157		From Ser. No. 290,001 to Ser. No. 621,172; Manufactured 1974-83
1	Head Set	FP-RE38852		From Ser. No. 100,001; Manufactured after 1983
1	Head Set	FP-RE38852		From Ser. No. 290,001 to Ser. No. 621,172; Manufactured 1974-83
QTY	VALVE	PART NO.	SIZE	DESCRIPTION
6	Intake	FP-R89219	STD	Optional Non-Stellite; 1 groove; Chrome plated stem; 1.8210" Head Dia., .3720" Stem Dia., 5.1560" O.A.L.
6	Intake	FP-R83071	STD	Stellite; 2 groove; Chrome plated stem; 1.8210" Head Dia., .3720" Stem Dia., 5.1660" O.A.L.
6	Intake	FP-R89223	3	Stellite; 2 groove; Chrome plated stem; 1.8210" Head Dia., .3750" Stem Dia., 5.1660" O.A.L.
6	Intake	FP-R89224	15	Stellite; 2 groove; Chrome plated stem; 1.8210" Head Dia., .3870" Stem Dia., 5.1660" O.A.L.
6	Intake	FP-R79623	STD	2 groove; Chrome plated stem; 1.7720" Head Dia., .3720" Stem Dia., 5.1560" O.A.L.
6	Intake	FP-R79628	3	2 groove; Chrome plated stem; 1.7720" Head Dia., .3750" Stem Dia., 5.1560" O.A.L.
6	Intake	FP-R79629	15	2 groove; Chrome plated stem; 1.7720" Head Dia., .3870" Stem Dia., 5.1560" O.A.L.
6	Intake	FP-R79630	30	2 groove; Chrome plated stem; 1.7720" Head Dia., .4020" Stem Dia., 5.1560" O.A.L.
6	Exhaust	FP-R79624	STD	1 groove; Chrome plated stem; 1.5750" Head Dia., .3720" Stem Dia., 5.1560" O.A.L.
6	Exhaust	FP-R79625	3	1 groove; Chrome plated stem; 1.5750" Head Dia., .3750" Stem Dia., 5.1560" O.A.L.
6	Exhaust	FP-R79626	15	1 groove; Chrome plated stem; 1.5750" Head Dia., .3870" Stem Dia., 5.1560" O.A.L.
6	Exhaust	FP-R79627	30	1 groove; Chrome plated stem; 1.5750" Head Dia., .4020" Stem Dia., 5.1560" O.A.L.
24	Keeper	FP-41339		1 groove; Square cut key groove
24	Keeper	FP-T20077		1 groove; Square cut key groove; Hardened
24	Keeper, Bulk	VK-138B		1 groove; Square cut key groove; Carton of 1000
QTY	VALVE SEAT	PART NO.	SIZE	DESCRIPTION
6	Exh.	FP-R51734	STD	
6	Int.	FP-R73064	STD	

(continued on next page)



# John Deere Off Highway

Grader 6414D Eng. Loader 6414D Eng. Crawler Tractor 6414D Eng. Loader Tractor 6414D 109  
 Eng. Skidder 6414D Eng. (cont.)  
 6.8L 414 OHV Diesel L6 (Standard), 4.1875" Bore

## CYL. HEAD & PARTS (cont.)

QTY	VALVE SPRING	PART NO.	SIZE	DESCRIPTION
12	Spring	FP-R26125		2.1200" Free Height
QTY	VALVE MISC.	PART NO.	SIZE	DESCRIPTION
6	Rotocap	FP-RE11410		Exh.
1	Bushing	FP-T26321		Lower
1	Bushing	FP-T20034		Upper
1	Oil Filler Cap Gasket	FP-T20328		Rocker arm cover code 1103
QTY	VALVE SEAL	PART NO.	SIZE	DESCRIPTION
12	Valve Stem Seal	FP-R87627		Exh. & Int.; O-Ring type
QTY	ROCKER PARTS	PART NO.	SIZE	DESCRIPTION
1	O-Ring	FP-R56463		Rocker cover breather tube; Breather tube codes 2909, 2915

## ELECTRICAL

QTY	ELECTRICAL	PART NO.	SIZE	DESCRIPTION
1	Starter to Block Gasket	FP-R53108		3-Hole mount; Starting motor codes 3002, 3011, 3013, 3016, 3017, 3018
QTY	ALTERNATOR	PART NO.	SIZE	DESCRIPTION
1	Ball Brg.	FP-JD9449		Front; w/24 Volt alternator conversion
1	Ball Brg.	FP-JD9449		Front; Delco-Remy No. 1102936; Code 3105; 12 Volt, 61 amp alternator
1	Ball Brg.	FP-JD9449		Front; Delco-Remy Nos. 1100490, 1102932, 1105174; Code 3103; 12 Volt, 72 amp alternator
1	Ball Brg.	FP-JD9449		Front; Delco-Remy Nos. 1100491, 1100580; Code 3102; 12 Volt, 55 amp alternator
1	Ball Brg.	FP-JD9449		Front; Motorola No. 8TA2009ES; Code 3104; 12 Volt, 30 amp alternator
2	Ball Brg.	FP-JD9449		Front & Rear; Motorola No. 70D42179T02; 24 Volt alternator
2	Ball Brg.	FP-JD9449		Front & Rear; Motorola Replacement Nos. 8EM2009NA, 8EM2009NB alternator

## INT & EXH MANIFOLDS

QTY	INT. & EXH. MANIFOLDS	PART NO.	SIZE	DESCRIPTION
6	Exhaust Manifold Gasket	FP-R90658		
2	Air Intake Gasket	FP-R81275		

## CAMSHAFT GROUP

QTY	TIMING COVER	PART NO.	SIZE	DESCRIPTION
1	Timing Gear Cover Gasket	FP-T20273		Access cover
1	Timing Gear Cover Gasket	FP-R97454		Front cover
QTY	CAMSHAFT/LIFTER	PART NO.	SIZE	DESCRIPTION
12	Lifter	FP-T20073		

## FUEL SYSTEM & PARTS

QTY	FUEL INJECTION	PART NO.	SIZE	DESCRIPTION
1	Injector Pump Gasket	FP-R125066		Gear cover
6	Fuel Injector Nozzle	FP-RE37503		Nozzle codes 1602, 1603; From Ser. No. 100,001; Manufactured after 1983
6	Fuel Injector Nozzle	FP-RE37503		Nozzle codes 1602, 1603, 1605; From Ser. No. 290,000 to Ser. No. 621,172; Manufactured 1974-83
6	Fuel Injector Seal	FP-R79605		Fuel line connection; Nozzle codes 1602, 1603; 9.270MM X 13.600MM X 5.080MM
6	Fuel Injector Seal	FP-R92352		Upper packing; w/Stanadyne® nozzle No. 26993
6	Fuel Injector Nut	FP-R79604		w/Injector marked 20291, 22205, 22264, 26993
12	Washer Type Seal	FP-R51936		Leak-off & return line seals; Nozzle codes 1602, 1603, 1607
6	Washer Type Seal	FP-R48000		Lower; w/Nozzle codes 1602, 1603
6	Washer Type Seal	FP-R60746		Upper; Nozzle codes 1602, 1603
QTY	FUEL FILTERS & PUMP	PART NO.	SIZE	DESCRIPTION
1	Mechanical Fuel Pump	FP-RE42211		Transfer pump
1	Fuel Transfer Pump Gasket	FP-R97350		

## COOLING SYSTEM

QTY	WATER PUMP	PART NO.	SIZE	DESCRIPTION
1	Water Pump Impeller	FP-R47191		w/Pump housing marked R66420, R68733
2	Water Pump Repair/Rebuild Kit	FP-RE62661		w/Pump housing marked R66420, R68733
1	Water Pump Housing Gasket	FP-R56809		w/Pump housing marked R56813, R90784, R104648
1	Oil Seal Kit	FP-AR101549		Water Pump; w/Pump housing marked R56813, R90784, R104648

(continued on next page)

**109 Grader 6414D Eng. Loader 6414D Eng. Crawler Tractor 6414D Eng. Loader Tractor 6414D**  
 (cont.) **Eng. Skidder 6414D Eng.**  
 6.8L 414 OHV Diesel L6 (Standard), 4.1875" Bore

COOLING SYSTEM (cont.)				
QTY	WATER PUMP (cont.)	PART NO.	SIZE	DESCRIPTION
1	Water Pump Mounting Gasket	FP-T20243		w/Pump housing marked R56813, R90784, R104648
QTY	THERMOSTAT	PART NO.	SIZE	DESCRIPTION
2	Thermostat	FP-AR48675		Thermostat code 2204; Thermostat cover code 2102 Vertical; Housing code 2108 Horizontal, 3901 Vertical; 180 Deg.
1	Therm. Hsg. - Water Mfld. Gsk	FP-R54641		Thermostat housing to cyl. head
2	O-Ring	FP-R56461		Thermostat housing tube seals; Housing code 3901
ENGINE BLOCK & PARTS				
QTY	GASKETS	PART NO.	SIZE	DESCRIPTION
1	Flywheel Housing Gasket	FP-R97351		From Ser. No. 100,001; Manufactured after 1983
1	Flywheel Housing Gasket	FP-R97351		From Ser. No. 290,000 to Ser. No. 621,172
1	Oil Pan Gasket	FP-R97344		From Ser. No. 100,000; Manufactured after 1983
1	Oil Pan Gasket	FP-R97344		From Ser. No. 290,000 to Ser. No. 621,172; Manufactured 1974-83
1	Oil Pan Gasket Set	FP-PG303PS		From Ser. No. 100,000; Manufactured after 1983
1	Oil Pan Gasket Set	FP-PG303PS		From Ser. No. 290,000 to Ser. No. 621,172; Manufactured 1974-83
1	Block to End Plate Front Gskt	FP-R131794		From Ser. No. 100,001; Manufactured after 1983
1	Block to End Plate Front Gskt	FP-R131794		From Ser. No. 290,000 to Ser. No. 621,172; Manufactured 1974-83
QTY	GASKET SETS	PART NO.	SIZE	DESCRIPTION
1	In-Frame Gasket Set	FP-PG359S		
1	Complete Overhaul Gasket Set	FP-RE38555		Crankshaft seals not incl.
1	Complete Overhaul Gasket Set	FP-RE38555WS		Incl. crankshaft seals; Rear main brg. seal incl.; Wear sleeve not incl.
QTY	OIL COOLERS & FILTERS	PART NO.	SIZE	DESCRIPTION
1	O-Ring	FP-A4730R		From Ser. No. 100,001; Manufactured after 1983; Oil cooler to block check valve seal
1	O-Ring	FP-A4730R		From Ser. No. 290,000 to Ser. No. 621,172; Manufactured 1974-83; Oil cooler to block check valve seal
1	O-Ring	FP-R56814		Oil cooler housing inner seal; From Ser. No. 128,418
1	O-Ring	FP-R56192		Oil cooler housing inner seal; To Ser. No. 128,417
1	O-Ring	FP-R56193		Oil cooler housing outer seal; To Ser. No. 128,417
1	Oil Cooler to Block Gasket	FP-R98489		From Ser. No. 620,694
1	Oil Cooler to Head Gasket	FP-R98834		From Ser. No. 100,000; Manufactured after 1983
1	Oil Cooler to Head Gasket	FP-R98834		From Ser. No. 290,000 to Ser. No. 621,172; Manufactured 1974-83
CRANKSHAFT/OIL PUMP				
QTY	CRANKSHAFT	PART NO.	SIZE	DESCRIPTION
1	Crankshaft	FP-RE45517		
1	Oil Seal Kit	FP-SK67942		Incl. front & rear seals; Crankshaft codes 1302; Crankshaft marked R104523, R108679, R54619
QTY	SEALS - FRONT CRANK	PART NO.	SIZE	DESCRIPTION
1	Crankshaft Front Seal	FP-AR67942		
1	O-Ring	FP-H35244		Crankshaft pulley; Pulley codes 1302, 1308, 1314, 1338, 4101
QTY	SEALS - REAR CRANK	PART NO.	SIZE	DESCRIPTION
1	Crankshaft Rear Seal	FP-RE24959		Crankshaft codes 1303, 1308; Flywheel housing codes 1403, 1405, 1421, 1422, 1425
QTY	MAIN BEARINGS	PART NO.	SIZE	DESCRIPTION
1	Main Set	FP-MBK3006	STD	w/Flanged thrust brg.
1	Main Set	FP-MBK300610	10	w/Flanged thrust brg.
1	Main Set	FP-MBK300620	20	w/Flanged thrust brg.
1	Main Set	FP-MBK300630	30	w/Flanged thrust brg.
6	Plain Main Brg.	FP-RE27352	STD	w/Flangeless thrust brg.
6	Plain Main Brg.	FP-RE27353	10	w/Flangeless thrust brg.
6	Plain Main Brg.	FP-RE27360	20	w/Flangeless thrust brg.
6	Plain Main Brg.	FP-RE27368	30	w/Flangeless thrust brg.
1	Flanged Main Brg.	FP-RE521350	STD	
1	Flanged Main Brg.	FP-RE526754	10	
1	Flanged Main Brg.	FP-RE527235	20	
1	Flanged Main Brg.	FP-RE527236	30	
QTY	OIL PUMP	PART NO.	SIZE	DESCRIPTION
1	O-Ring	FP-R61871		Oil pump inlet; w/Pump housing marked R54629
2	O-Ring	FP-R80632		Oil Pump outlet tube
1	Oil Filler Inlet Gasket	FP-R97352		Oil filler neck code 1200

(continued on next page)





# John Deere Off Highway

**Grader 6414D Eng. Loader 6414D Eng. Crawler Tractor 6414D Eng. Loader Tractor 6414D 109  
Eng. Skidder 6414D Eng. (cont.)  
6.8L 414 OHV Diesel L6 (Standard), 4.1875" Bore**

## CRANKSHAFT/OIL PUMP (cont.)

QTY	OIL PUMP (cont.)	PART NO.	SIZE	DESCRIPTION
1	Oil Filter Adapter Gasket	FP-R98488		w/Filter adapter marked R91597, R131238; From Ser. No. 128,418
1	Oil Pump Seal Ring	FP-R79563		Oil pump outlet adapter; w/Pump marked R54629; To Ser. No. 122,430

## CYLINDER COMPONENTS

QTY	LINERS	PART NO.	SIZE	DESCRIPTION
6	Liner w/o Sealing Ring	FP-R121867	STD	
6	Liner w/Sealing Rings	FP-RE500024	STD	
6	Cylinder Kit Complete	FP-RE19833	STD	w/Con. Rod marked R56187
6	Cyl. Liner Sealing Ring Kit	FP-AR65507		
6	Sealing Ring, Liner	FP-R48767		Rectangle; Top
6	Sealing Ring, Liner	FP-R26121		Round; Middle
6	Sealing Ring	FP-SLR2520		Round; Bottom

QTY	PISTONS	PART NO.	SIZE	DESCRIPTION
6	Piston Body w/o Pin	FP-AR68188	STD	1.62" pin dia.
6	Piston Kit w/Pin & Retainers	FP-AR68188WP	STD	1.62" pin dia.
6	Pin	FP-R124230		1.62" pin dia.
12	Piston Pin Retainer	FP-R54114		For 1.62" pin dia.
6	Pin Bushing	FP-R57451		w/Con. Rod marked R56187, R58979; Pin dia. 1.62"; 1.621" ID, 1.813" OD, 1.370" O.A.L.

QTY	CONNECTING RODS & BRGS.	PART NO.	SIZE	DESCRIPTION
12	Con. Rod Bolt	FP-R74195		w/Con. Rod marked R54617, R56187, R116851; Torque-To-Yield bolt; Replacement recommended
6	Rod Pair	FP-AR97517	STD	
6	Rod Pair	FP-AR97653	10	
6	Rod Pair	FP-AR97654	20	
6	Rod Pair	FP-AR97655	30	

QTY	PISTON RINGS	PART NO.	SIZE	DESCRIPTION
6	Ring Set Single Cylinder	FP-RE507852	STD	1-1/8, 1-3/32, 1-.136 (1 cyl. set)
6	Ring Set Single Cylinder	FP-RE66820	STD	1-1/8, 1-3/32, 1-.136 (1 cyl. set)

## KITS

QTY	OVERHAUL KIT	PART NO.	SIZE	DESCRIPTION
1	In-Frame Overhaul Kit	FP-414DIFK		w/Con. Rod marked R56187, R116851; Incl. Torque-To-Yield con. rod bolts
1	Complete Overhaul Kit	FP-414DOHK		w/Con. Rod marked R56187, R116851; Pin dia. 1.62"; Incl. Torque-To-Yield con. rod bolts

**Grader 6414T Eng. Loader 6414T Eng. Crawler Tractor 6414T Eng. Loader Tractor 6414T 110  
Eng. Forestry Tractor 6414T Eng. Excavator 6414T Eng. Skidder 6414T Eng. Dozer 6414T  
Eng. Feller Buncher 6414T Eng.  
6.8L 414 OHV Turbo-Diesel L6 (Standard), 4.1875" Bore**

## CYL. HEAD & PARTS

QTY	GASKETS	PART NO.	SIZE	DESCRIPTION
1	Valve Cover Gasket	FP-R75728		Rocker cover codes 1102, 1103; From Ser. No. 608,511
1	Valve Cover Gasket	FP-T20467		To Ser. No. 608,510
1	Head Gasket	FP-R114157		From Ser. No. 100,001; Manufactured after 1983
1	Head Gasket	FP-R114157		From Ser. No. 290,001 to Ser. No. 621,172; Manufactured 1974-83
1	Head Set	FP-RE38852		From Ser. No. 100,001; Manufactured after 1983
1	Head Set	FP-RE38852		From Ser. No. 290,001 to Ser. No. 621,172; Manufactured 1974-83

QTY	VALVE	PART NO.	SIZE	DESCRIPTION
6	Intake	FP-R89219	STD	Optional Non-Stellite; 1 groove; Chrome plated stem; 1.8210" Head Dia., .3720" Stem Dia., 5.1560" O.A.L.
6	Intake	FP-R83071	STD	Stellite; 2 groove; Chrome plated stem; 1.8210" Head Dia., .3720" Stem Dia., 5.1660" O.A.L.
6	Intake	FP-R89223	3	Stellite; 2 groove; Chrome plated stem; 1.8210" Head Dia., .3750" Stem Dia., 5.1660" O.A.L.
6	Intake	FP-R89224	15	Stellite; 2 groove; Chrome plated stem; 1.8210" Head Dia., .3870" Stem Dia., 5.1660" O.A.L.
6	Intake	FP-R79623	STD	2 groove; Chrome plated stem; 1.7720" Head Dia., .3720" Stem Dia., 5.1560" O.A.L.

(continued on next page)

**110** Grader 6414T Eng. Loader 6414T Eng. Crawler Tractor 6414T Eng. Loader Tractor 6414T  
 (cont.) Eng. Forestry Tractor 6414T Eng. Excavator 6414T Eng. Skidder 6414T Eng. Dozer 6414T  
 Eng. Feller Buncher 6414T Eng.  
 6.8L 414 OHV Turbo-Diesel L6 (Standard), 4.1875" Bore

## CYL. HEAD & PARTS (cont.)

QTY	VALVE (cont.)	PART NO.	SIZE	DESCRIPTION
6	Intake	FP-R79628	3	2 groove; Chrome plated stem; 1.7720" Head Dia., .3750" Stem Dia., 5.1560" O.A.L.
6	Intake	FP-R79629	15	2 groove; Chrome plated stem; 1.7720" Head Dia., .3870" Stem Dia., 5.1560" O.A.L.
6	Intake	FP-R79630	30	2 groove; Chrome plated stem; 1.7720" Head Dia., .4020" Stem Dia., 5.1560" O.A.L.
6	Exhaust	FP-R79624	STD	1 groove; Chrome plated stem; 1.5750" Head Dia., .3720" Stem Dia., 5.1560" O.A.L.
6	Exhaust	FP-R79625	3	1 groove; Chrome plated stem; 1.5750" Head Dia., .3750" Stem Dia., 5.1560" O.A.L.
6	Exhaust	FP-R79626	15	1 groove; Chrome plated stem; 1.5750" Head Dia., .3870" Stem Dia., 5.1560" O.A.L.
6	Exhaust	FP-R79627	30	1 groove; Chrome plated stem; 1.5750" Head Dia., .4020" Stem Dia., 5.1560" O.A.L.
24	Keeper	FP-41339		1 groove; Square cut key groove
24	Keeper	FP-T20077		1 groove; Square cut key groove; Hardened
24	Keeper, Bulk	VK-138B		1 groove; Square cut key groove; Carton of 1000
QTY	VALVE SEAT	PART NO.	SIZE	DESCRIPTION
6	Exh.	FP-R51734	STD	
6	Int.	FP-R73064	STD	
QTY	VALVE SPRING	PART NO.	SIZE	DESCRIPTION
12	Spring	FP-R26125		2.1200" Free Height
QTY	VALVE MISC.	PART NO.	SIZE	DESCRIPTION
12	Rotocap	FP-RE11410		Exh. & Int.
1	Bushing	FP-T26321		Lower
1	Bushing	FP-T20034		Upper
1	Oil Filler Cap Gasket	FP-T20328		Rocker arm cover code 1103
QTY	VALVE SEAL	PART NO.	SIZE	DESCRIPTION
12	Valve Stem Seal	FP-R87627		Exh. & Int.; O-Ring type
QTY	ROCKER PARTS	PART NO.	SIZE	DESCRIPTION
1	O-Ring	FP-R56463		Rocker cover breather tube; Breather tube codes 2909, 2915
ELECTRICAL				
QTY	ELECTRICAL	PART NO.	SIZE	DESCRIPTION
1	Starter to Block Gasket	FP-R53108		3-Hole mount; Starting motor codes 3002, 3011, 3013, 3016, 3017, 3018
QTY	ALTERNATOR	PART NO.	SIZE	DESCRIPTION
1	Ball Brg.	FP-JD9449		Front; w/24 Volt alternator conversion
1	Ball Brg.	FP-JD9449		Front; Delco-Remy No. 1102936; Code 3105; 12 Volt, 61 amp alternator
1	Ball Brg.	FP-JD9449		Front; Delco-Remy Nos. 1100490, 1102932, 1105174; Code 3103; 12 Volt, 72 amp alternator
1	Ball Brg.	FP-JD9449		Front; Delco-Remy Nos. 1100491, 1100580; Code 3102
1	Ball Brg.	FP-JD9449		Front; Motorola No. 8TA2009ES; Code 3104; 12 Volt, 30 amp alternator
2	Ball Brg.	FP-JD9449		Front & Rear; Motorola No. 70D42179T02; 24 Volt alternator
2	Ball Brg.	FP-JD9449		Front & Rear; Motorola Replacement Nos. 8EM2009NA, 8EM2009NB alternator
INT & EXH MANIFOLDS				
QTY	INT. & EXH. MANIFOLDS	PART NO.	SIZE	DESCRIPTION
6	Exhaust Manifold Gasket	FP-R90658		
3	Air Intake Gasket	FP-R81275		
QTY	AIR INTAKE	PART NO.	SIZE	DESCRIPTION
1	O-Ring	FP-R56905		Air intake system code 1718
CAMSHAFT GROUP				
QTY	TIMING COVER	PART NO.	SIZE	DESCRIPTION
1	Timing Gear Cover Gasket	FP-T20273		Access cover
1	Timing Gear Cover Gasket	FP-R97454		Front cover
QTY	CAMSHAFT/LIFTER	PART NO.	SIZE	DESCRIPTION
12	Lifter	FP-T20073		

(continued on next page)



# John Deere Off Highway

**Grader 6414T Eng. Loader 6414T Eng. Crawler Tractor 6414T Eng. Loader Tractor 6414T 110  
Eng. Forestry Tractor 6414T Eng. Excavator 6414T Eng. Skidder 6414T Eng. Dozer 6414T (cont.)  
Eng. Feller Buncher 6414T Eng.  
6.8L 414 OHV Turbo-Diesel L6 (Standard), 4.1875" Bore**

<b>FUEL SYSTEM &amp; PARTS</b>				
<b>QTY</b>	<b>FUEL INJECTION</b>	<b>PART NO.</b>	<b>SIZE</b>	<b>DESCRIPTION</b>
1	Injector Pump Gasket	FP-R125066		Gear cover
6	Fuel Injector Nozzle	FP-RE37503		Nozzle codes 1602, 1603; From Ser. No. 100,001; Manufactured after 1983
6	Fuel Injector Nozzle	FP-RE37503		Nozzle codes 1602, 1603; From Ser. No. 290,000 to Ser. No. 621,172; Manufactured 1974-83
6	Fuel Injector Seal	FP-R79605		Fuel line connection; Nozzle codes 1602, 1603; 9.270MM X 13.600MM X 5.080MM
6	Fuel Injector Seal	FP-R92352		Upper packing; w/Stanadyne® nozzle No. 26993
6	Fuel Injector Nut	FP-R79604		w/Injector marked 20291, 22205, 22264, 26993
12	Washer Type Seal	FP-R51936		Leak-off & return line seals; Nozzle codes 1602, 1603, 1609
6	Washer Type Seal	FP-R48000		Lower; w/Nozzle codes 1602, 1603; w/Nozzle marked 26933
6	Washer Type Seal	FP-R60746		Upper; Nozzle codes 1602, 1603
<b>QTY</b>	<b>FUEL FILTERS &amp; PUMP</b>	<b>PART NO.</b>	<b>SIZE</b>	<b>DESCRIPTION</b>
1	Mechanical Fuel Pump	FP-RE42211		Transfer pump
1	Fuel Transfer Pump Gasket	FP-R97350		
<b>QTY</b>	<b>TURBOCHARGER</b>	<b>PART NO.</b>	<b>SIZE</b>	<b>DESCRIPTION</b>
1	Turbocharger Oil Drain Gasket	FP-R105346		w/Turbo oil line codes 6504, 6530
1	Turbocharger Mounting Gasket	FP-R89879		
1	Turbocharger Oil Supply Gskt.	FP-R97348		From Ser. No. 100,001 to Ser. No. 148,514; Manufactured 1983-86
1	Turbocharger Oil Supply Gskt.	FP-R97348		From Ser. No. 290,000 to Ser. No. 621,172; Manufactured 1974-83
<b>COOLING SYSTEM</b>				
<b>QTY</b>	<b>WATER PUMP</b>	<b>PART NO.</b>	<b>SIZE</b>	<b>DESCRIPTION</b>
1	Water Pump Impeller	FP-R56812		w/Pump housing marked R56813, R90784, R104648
1	Water Pump Housing Gasket	FP-R56809		
1	Oil Seal Kit	FP-AR101549		Water Pump; w/Pump housing marked R56813, R90784, R104648
1	Water Pump Mounting Gasket	FP-T20243		w/Pump housing marked R56813, R90784, R104648
1	Shaft & Bearing Assembly	FP-JD8643		w/Pump housing marked R56813, R90784, R104648
<b>QTY</b>	<b>THERMOSTAT</b>	<b>PART NO.</b>	<b>SIZE</b>	<b>DESCRIPTION</b>
1	Therm. Hsg. - Water Mfld. Gsk	FP-R54641		Thermostat housing to cyl. head
2	O-Ring	FP-R56461		Thermostat housing tube seals; Housing code 3901
<b>ENGINE BLOCK &amp; PARTS</b>				
<b>QTY</b>	<b>GASKETS</b>	<b>PART NO.</b>	<b>SIZE</b>	<b>DESCRIPTION</b>
1	Flywheel Housing Gasket	FP-R97351		From Ser. No. 100,001; Manufactured after 1983
1	Flywheel Housing Gasket	FP-R97351		From Ser. No. 290,000 to Ser. No. 621,172
1	Oil Pan Gasket	FP-R97344		
1	Oil Pan Gasket Set	FP-PG303PS		From Ser. No. 100,001; Manufactured after 1983
1	Oil Pan Gasket Set	FP-PG303PS		From Ser. No. 290,001 to Ser. No. 621,172; Manufactured 1974-83
1	Block to End Plate Front Gskt	FP-R131794		From Ser. No. 100,001; Manufactured after 1983
1	Block to End Plate Front Gskt	FP-R131794		From Ser. No. 290,001 to Ser. No. 621,172; Manufactured 1974-83
<b>QTY</b>	<b>GASKET SETS</b>	<b>PART NO.</b>	<b>SIZE</b>	<b>DESCRIPTION</b>
1	In-Frame Gasket Set	FP-PG359S		
1	Complete Overhaul Gasket Set	FP-RE38555		Crankshaft seals not incl.
1	Complete Overhaul Gasket Set	FP-RE38555WS		Incl. crankshaft seals; Rear main brg. seal incl.; Wear sleeve not incl.
<b>QTY</b>	<b>OIL COOLERS &amp; FILTERS</b>	<b>PART NO.</b>	<b>SIZE</b>	<b>DESCRIPTION</b>
1	O-Ring	FP-A4730R		From Ser. No. 100,001; Manufactured after 1983; Oil cooler to block check valve seal
1	O-Ring	FP-A4730R		From Ser. No. 290,000 to Ser. No. 621,172; Manufactured 1974-83; Oil cooler to block check valve seal
1	O-Ring	FP-R56814		Oil cooler housing inner seal; From Ser. No. 138,460
1	O-Ring	FP-R56192		Oil cooler housing inner seal; To Ser. No. 138,459
1	O-Ring	FP-R56193		Oil cooler housing outer seal; To Ser. No. 138,459
1	Oil Cooler Cover Gasket	FP-R98471		
1	Oil Cooler to Block Gasket	FP-R98489		From Ser. No. 620,694
1	Oil Cooler to Head Gasket	FP-R98834		From Ser. No. 100,001; Manufactured after 1983
1	Oil Cooler to Head Gasket	FP-R98834		From Ser. No. 290,001 to Ser. No. 621,172; Manufactured 1974-83

(continued on next page)

**110** Grader 6414T Eng. Loader 6414T Eng. Crawler Tractor 6414T Eng. Loader Tractor 6414T  
 (cont.) Eng. Forestry Tractor 6414T Eng. Excavator 6414T Eng. Skidder 6414T Eng. Dozer 6414T  
 Eng. Feller Buncher 6414T Eng.  
 6.8L 414 OHV Turbo-Diesel L6 (Standard), 4.1875" Bore

### CRANKSHAFT/OIL PUMP

QTY	CRANKSHAFT	PART NO.	SIZE	DESCRIPTION
1	Crankshaft	FP-RE45517		
1	Oil Seal Kit	FP-SK67942		Incl. front & rear seals; Crankshaft code 1302; Crankshaft marked R104523, R108679, R54619
QTY	SEALS - FRONT CRANK	PART NO.	SIZE	DESCRIPTION
1	Crankshaft Front Seal	FP-AR67942		
1	O-Ring	FP-H35244		Crankshaft pulley; Pulley codes 1302, 1308, 1314, 1338, 4101
QTY	SEALS - REAR CRANK	PART NO.	SIZE	DESCRIPTION
1	Crankshaft Rear Seal	FP-RE24959		Crankshaft codes 1302, 1308; Flywheel housing codes 1403, 1405, 1421, 1422, 1425
QTY	MAIN BEARINGS	PART NO.	SIZE	DESCRIPTION
1	Main Set	FP-MBK3006	STD	
1	Main Set	FP-MBK300610	10	
1	Main Set	FP-MBK300620	20	
1	Main Set	FP-MBK300630	30	
6	Plain Main Brg.	FP-RE27352	STD	w/Flangeless thrust brg.
6	Plain Main Brg.	FP-RE27353	10	w/Flangeless thrust brg.
6	Plain Main Brg.	FP-RE27360	20	w/Flangeless thrust brg.
6	Plain Main Brg.	FP-RE27368	30	w/Flangeless thrust brg.
1	Flanged Main Brg.	FP-RE521350	STD	
1	Flanged Main Brg.	FP-RE526754	10	
1	Flanged Main Brg.	FP-RE527235	20	
1	Flanged Main Brg.	FP-RE527236	30	
QTY	OIL PUMP	PART NO.	SIZE	DESCRIPTION
1	O-Ring	FP-R61871		Oil pump inlet; w/Pump housing marked R54629
2	O-Ring	FP-R80632		Oil Pump outlet tube
1	Oil Filler Inlet Gasket	FP-R97352		Oil filler neck code 1200
1	Oil Pump Seal Ring	FP-R79563		Oil pump outlet adapter; w/Pump marked R54629; To Ser. No. 122,430

### CYLINDER COMPONENTS

QTY	LINERS	PART NO.	SIZE	DESCRIPTION
6	Liner w/o Sealing Ring	FP-R121867	STD	
6	Liner w/Sealing Rings	FP-RE500024	STD	
6	Cylinder Kit Complete	FP-RE19832	STD	w/Con. Rod marked R56187; Pin dia. 1.62"
6	Cyl. Liner Sealing Ring Kit	FP-AR65507		
6	Sealing Ring, Liner	FP-R48767		Rectangle; Top
6	Sealing Ring, Liner	FP-R26121		Round; Middle
6	Sealing Ring	FP-SLR2520		Round; Bottom
QTY	PISTONS	PART NO.	SIZE	DESCRIPTION
6	Piston Body w/o Pin	FP-AR96389		
6	Piston Kit w/Pin & Retainers	FP-AR96389WP		w/Con. Rod marked 56187
6	Pin	FP-R124230		1.62" pin dia.
12	Piston Pin Retainer	FP-R54114		For 1.62" pin dia.
6	Pin Bushing	FP-R57451		w/Con. Rod marked R56187, R58979; Pin dia. 1.62"; 1.621" ID, 1.813" OD, 1.370" O.A.L.
QTY	CONNECTING RODS & BRGS.	PART NO.	SIZE	DESCRIPTION
12	Con. Rod Bolt	FP-R74195		w/Con. Rod marked R54617, R56187, R116851; Torque-To-Yield bolt; Replacement recommended
6	Rod Pair	FP-AR97517	STD	
6	Rod Pair	FP-AR97653	10	
6	Rod Pair	FP-AR97654	20	
6	Rod Pair	FP-AR97655	30	
QTY	PISTON RINGS	PART NO.	SIZE	DESCRIPTION
6	Ring Set Single Cylinder	FP-RE507852	STD	1-1/8, 1-3/32, 1-.136 (1 cyl. set)
6	Ring Set Single Cylinder	FP-RE66820	STD	1-1/8, 1-3/32, 1-.136 (1 cyl. set)

### KITS

QTY	OVERHAUL KIT	PART NO.	SIZE	DESCRIPTION
1	In-Frame Overhaul Kit	FP-414TIFK		w/Con. Rod marked R56187, R116851; Pin dia. 1.62"; Incl. Torque-To-Yield con. rod bolts
1	Complete Overhaul Kit	FP-414TOHK		w/Con. Rod marked R56187, R116851; Pin dia. 1.62"; Incl. Torque-To-Yield con. rod bolts



# John Deere Off Highway

*Wheel Tractor G Eng. 111*  
6.8L 414 OHV L2, 6.125" Bore

ENGINE BLOCK & PARTS				
QTY	CAM BEARINGS	PART NO.	SIZE	DESCRIPTION
2	Cone Taper Brg.	FP-JD8135		Position 1-2; From Ser. No. G34691
2	Cup Taper Brg.	FP-JD7438		Position 1-2; From Ser. No. G34691
CRANKSHAFT/OIL PUMP				
QTY	CRANKSHAFT	PART NO.	SIZE	DESCRIPTION
1	Oil Seal Kit	FP-SK67942		Incl. front & rear seals
QTY	SEALS - FRONT CRANK	PART NO.	SIZE	DESCRIPTION
1	Crankshaft Front Seal	FP-AR67942		
QTY	SEALS - REAR CRANK	PART NO.	SIZE	DESCRIPTION
1	Crankshaft Rear Seal	FP-RE24959		
CYLINDER COMPONENTS				
QTY	PISTONS	PART NO.	SIZE	DESCRIPTION
2	Pin Bushing	FP-9759		w/1.750" ID, 1.895" OD, 2.500" O.A.L.
2	Pin Bushing	9759 +		w/1.750" ID, 1.895" OD, 2.500" O.A.L.; When depleted use FP-9759
QTY	CONNECTING RODS & BRGS.	PART NO.	SIZE	DESCRIPTION
2	Rod Pair	FP-2155SB	STD	w/insert type brgs.
<b>Wheel Tractor 6-71 In-Line (2-Valve Cyl. Head), 6-71N In-Line (4-Valve Cyl. Head) Engs. 112</b> 7.0L 426 OHV Diesel L6 (6-71), 4.25" Bore (Detroit Diesel Eng.)				
CYL. HEAD & PARTS				
QTY	GASKETS	PART NO.	SIZE	DESCRIPTION
1	Valve Cover Gasket	FP-5104019		Engs. w/cast Alum. valve cover; Silicone
1	Valve Cover Gasket	FP-5143407		Engs. w/steel valve cover; Neoprene
QTY	VALVE	PART NO.	SIZE	DESCRIPTION
12	Exhaust	FP-5185327		6-71 Engs.; 1 groove, 30 deg. seat; 1.5840" Head Dia., .3420" Stem Dia., 6.4440" O.A.L.
12	Exhaust	FP-8922516		6-71N Engs.; 30 deg. seat; 1.1800" Head Dia., .3103" Stem Dia., 5.5280" O.A.L.
12	Exhaust Valve Kit	FP-5193197		6-71 Engs.; 30 deg. seat; Contains (1) FP-5185327 & (2) FP-23507238; 30 Degree
12	Exhaust Valve Kit	FP-5193666		6-71 Engs.; 30 deg. seat; Jet Blade; Contains (1) FP-5186381 & (2) FP-23507238; 30 Degree
12	Exhaust Valve Kit	FP-5192718		6-71 Engs.; 45 deg. seat; Contains (1) FP-5178472 & (2) FP-23507238; 45 Degree
24	Exhaust Valve Kit	FP-5149386		6-71N Engs.; Contains (1) FP-5104280 & (2) FP-5111337
24	Exhaust Valve Kit	FP-23500501		6-71N Engs.; Contains (1) FP-8922516 & (2) FP-5111337
24	Keeper	FP-23507238		6-71 Engs.; 1 groove; Square cut key groove
48	Keeper	FP-5111337		6-71N Engs.; 1 groove; Square cut key groove
48	Keeper	VK-144R		6-71N Engs.; 1 groove; Square cut key groove; Hardened
QTY	VALVE SEAT	PART NO.	SIZE	DESCRIPTION
12	Exh.	FP-5198230	10	6-71 Engs.; 30 deg. seat; 30 Deg. seat; .010" O/S; 1.6380" OD, 1.3440" ID, .2485" Depth
12	Exh.	FP-8927920	STD	6-71 Engs.; 30 deg. seat; 30 Deg. seat; 1.6280" OD, 1.3440" ID, .2485" Depth
24	Exh.	FP-5197167	10	6-71N Engs.; 30 deg. seat; 30 Deg. seat; .010" O/S; 1.2720" OD, .9770" ID, .2355" Depth
24	Exh.	FP-5101101	STD	6-71N Engs.; 30 deg. seat; 30 Deg. seat; 1.2620" OD, .9770" ID, .2490" Depth
QTY	VALVE GUIDE	PART NO.	SIZE	DESCRIPTION
12	Guide	FP-5192717		6-71 Engs.; .0162" O/S
12	Guide	FP-5120930		6-71 Engs.; .3450" ID, 3.2500" O.A.L.
24	Guide	FP-5129919		6-71N Engs.; 2 3/8" length; Cut for seal; 2 3/8" length; .3130" ID, 2.3800" O.A.L.
QTY	VALVE SPRING	PART NO.	SIZE	DESCRIPTION
12	Spring	FP-5150289		6-71 Engs.; .177" Wire dia.
24	Spring	FP-5111339		Exh.; 6-71N Engs.; From Ser. No. 6V-8192; .135" Wire dia.
24	Spring	FP-5147347		Exh.; 6-71N Engs.; To Ser. No. 6V-8191; .148" Wire dia.
12	Valve Spring Seat	FP-5150292		6-71 Engs.
24	Valve Spring Seat	FP-5117562		6-71N Engs.
24	Spring Insert	FP-5111467		Exh. Valve Spring Washer
12	Spring Cap	FP-5150291		6-71 Engs.
24	Spring Cap	FP-5117563		6-71N Engs.

(continued on next page)

## 112 Wheel Tractor 6-71 In-Line (2-Valve Cyl. Head), 6-71N In-Line (4-Valve Cyl. Head) Engs. (cont.) 7.0L 426 OHV Diesel L6 (6-71), 4.25" Bore (Detroit Diesel Eng.)

CYL. HEAD & PARTS (cont.)				
QTY	PUSH RODS	PART NO.	SIZE	DESCRIPTION
18	Push Rod	FP-5128640		
18	Push Rod Seat	FP-5123250		Lower
18	Push Rod Seat	FP-5150302		Upper; Flange type
18	Push Rod Spring	FP-5186858		.177" Wire diameter
18	Push Rod Retainer	FP-5150303		
18	Lock Nut	FP-5151601		Push rod; 5/16" - 24
18	Rect. or Square Seal	FP-5154472		Push rod
QTY	VALVE SEAL	PART NO.	SIZE	DESCRIPTION
12	Valve Stem Seal	FP-23500480		6-71 Engs.
24	Valve Stem Seal	FP-8921209		6-71N Engs.; Use w/FP-5129919 guide
QTY	ROCKER PARTS	PART NO.	SIZE	DESCRIPTION
6	Arm Assy.	FP-5148472		Exh. Left
6	Arm Assy.	FP-5148475		Exh. Right
6	Arm Assy.	FP-8923554		Injector
2	Rocker Shaft	FP-23500714		
12	Rocker Shaft Bracket Bolt	FP-5150325		1/2" - 13 x 4.250"
24	Arm Support	FP-5103903		
12	Rocker Bushing	FP-23517217		Large; .8755" ID, .9475" OD, .840" Length, .0360" Wall thickness
6	Rocker Bushing	FP-8924355		Large; Injector bushing
6	Rocker Bushing	FP-8924354		Small; Injector bushing
12	Rocker Bushing	FP-8924354		Small; Rocker bushing
12	Rocker Bushing	FP-5123700		Exh.; Clevis bushing; .5625" OD
6	Rocker Bushing	FP-5123700		Injector; Clevis bushing; .5625" OD
12	Follower Assy.	FP-8924439		
24	Cam Follower Roller Set	FP-8923814		Incl. pin & roller
12	Valve Bridge Adj. Screw	FP-5129101		5/16" - 24 x 1"
12	Valve Bridge	FP-5117565		
12	Valve Bridge Guide	FP-5117564		Press fit
12	Valve Bridge Guide	FP-51175646		Press fit w/.006" O/S
12	Valve Bridge Guide	FP-5196843		Threaded
12	Rocker Arm Clevis Pin	FP-5150314		Exh.
6	Rocker Arm Clevis Pin	FP-5150314		Injector
CAMSHAFT GROUP				
QTY	TIMING	PART NO.	SIZE	DESCRIPTION
1	Idler Gear Hub Assembly	FP-5124458		
QTY	CAMSHAFT TIMING	PART NO.	SIZE	DESCRIPTION
2	Camshaft Pulley Spacer	FP-5121071		
QTY	CAMSHAFT/LIFTER	PART NO.	SIZE	DESCRIPTION
1	Camshaft	FP-5149393		Advanced timing; R.H. rotation
12	Bolt	FP-443603		Cam guide; .250" x 20 x .750"
12	Lock Washer	FP-103319		Cam guide; .250"
12	Lock Washer	FP-103320		Cam guide; 5/16"
1	Prelube	55-400		4 oz. bottle; 1.5 oz. packet No. 55-403 also avail.
ACCESSORY DRIVE				
QTY	ACCESSORY DRIVE	PART NO.	SIZE	DESCRIPTION
1	Oil Seal	FP-5131329		
FUEL SYSTEM & PARTS				
QTY	FUEL INJECTION	PART NO.	SIZE	DESCRIPTION
6	Fuel Injector Seal Ring	FP-5104701		Viton®
6	Injector Hole Tube Kit	FP-8925981		Viton®
ENGINE BLOCK & PARTS				
QTY	GASKETS	PART NO.	SIZE	DESCRIPTION
2	Cylinder Cover Gasket	FP-23505518		End plate
QTY	GASKET SETS	PART NO.	SIZE	DESCRIPTION
1	Complete Overhaul Gasket Set	FP-23512676		High block; Compl., Bi-directional front & rear crank seals not incl.; Valve cover gskts. not incl.
1	Complete Overhaul Gasket Set	FP-23512676WS		High block; Incl. seals; Compl., Incl. bi-directional front & rear crank seals; valve cover gskts. not incl.
1	Complete Overhaul Gasket Set	FP-5192923		Low block
1	Kit Gasket Set	260-1256		In Frm.; Valve cover gskts. not incl.
QTY	CAM BEARINGS	PART NO.	SIZE	DESCRIPTION
2	Cam Brg.	FP-5111423	STD	Position Front & Rear; Balance shaft brg.; From Ser. No. 6A-57745; Grooved

(continued on next page)



# John Deere Off Highway

Wheel Tractor 6-71 In-Line (2-Valve Cyl. Head), 6-71N In-Line (4-Valve Cyl. Head) Engs. **112**  
 7.0L 426 OHV Diesel L6 (6-71), 4.25" Bore (Detroit Diesel Eng.) (cont.)

## ENGINE BLOCK & PARTS (cont.)

QTY	CAM BEARINGS (cont.)	PART NO.	SIZE	DESCRIPTION
2	Cam Brg.	FP-5111423	STD	Position Front & Rear; Cam brg.; From Ser. No. 6A-57745; Grooved
5	Cam Brg.	FP-5196026	STD	Position Inter.; w/o Steel bushing in ctr. hole; Aluminum Blocks only
5	Cam Brg.	FP-5196022	STD	Position Inter.; W/Steel bushing in ctr. hole

## CRANKSHAFT/OIL PUMP

QTY	SEALS - FRONT CRANK	PART NO.	SIZE	DESCRIPTION
1	Oil Seal Spacer	FP-23507306		Front; 2.50" ID x 2.81" Length
1	Oil Seal Spacer	FP-5192496		Rear; Exc. for double lip seal
1	Oil Seal	FP-5115454		Single Lip, Std.
1	Oil Seal	FP-5143108		Submersible

QTY	SEALS - REAR CRANK	PART NO.	SIZE	DESCRIPTION
1	Oil Seal	FP-5196927		Double Lip; O/S Shaft Dia. 4.812"
1	Oil Seal	FP-5127821		Double Lip, Std.; Shaft Dia. 4.687"
1	Oil Seal	FP-5197860		Single lip; O/S Shaft dia. 4.812"
1	Oil Seal	FP-5114335		Single Lip, Std.; Shaft Dia. 4.687"
1	Redi-Sleeve	FP-23507225		Shaft dia. 4.812"

QTY	MAIN BEARINGS	PART NO.	SIZE	DESCRIPTION
7	Plain Main Brg.	FP-5192874	STD	
7	Plain Main Brg.	FP-5192875	2	
7	Plain Main Brg.	FP-5192876	10	
7	Plain Main Brg.	FP-5192877	20	
7	Plain Main Brg.	FP-5192878	30	
7	Plain Main Brg.	FP-5193738	40	
7	Plain Main Brg.	FP-5193739	50	
1	Thrust Washer Set	FP-5159353S	STD	Position Rear
4	Thrust Washer	FP-5159353	STD	Position Rear
4	Thrust Washer	FP-5160542	5	Position Rear
4	Thrust Washer	FP-5192111	10	Position Rear

## CYLINDER COMPONENTS

QTY	LINERS	PART NO.	SIZE	DESCRIPTION
6	Liner w/o Sealing Ring	FP-5102316	5	Flanged, .810" port length
6	Liner w/o Sealing Ring	FP-5102317	10	Flanged, .810" port length
6	Liner w/o Sealing Ring	FP-5102318	20	Flanged, .810" port length
6	Liner w/o Sealing Ring	FP-5102319	30	Flanged, .810" port length
6	Liner w/o Sealing Ring	FP-5193732	5	Flanged, 1.050" port length
6	Liner w/o Sealing Ring	FP-5193733	10	Flanged, 1.050" port length
6	Liner w/o Sealing Ring	FP-5193734	20	Flanged, 1.050" port length
6	Liner w/o Sealing Ring	FP-5193735	30	Flanged, 1.050" port length
6	Liner w/o Sealing Ring	FP-23504931	STD	No. 1 Bore; Flanged, .810" port length
6	Liner w/o Sealing Ring	FP-23502020	STD	No. 1 Bore; Flanged, 1.050" port length
6	Liner w/o Sealing Ring	FP-23504932	STD	No. 2 Bore; Flanged, .810" port length
6	Liner w/o Sealing Ring	FP-23502021	STD	No. 2 Bore; Flanged, 1.050" port length
6	Liner w/o Sealing Ring	FP-23504933	STD	No. 3 Bore; Flanged, .810" port length
6	Liner w/o Sealing Ring	FP-23502022	STD	No. 3 Bore; Flanged, 1.050" port length
6	Liner w/o Sealing Ring	FP-23504934	STD	No. 4 Bore; Flanged, .810" port length
6	Liner w/o Sealing Ring	FP-23504936	STD	No. 4 Bore; Flanged, 1.050" port length
6	Cylinder Kit Complete	FP-235229495	5	w/Cross Head style piston; 1.050" port length sleeve
6	Cylinder Kit Complete	FP-23522951	10	w/Cross Head style piston; 1.050" port length sleeve
6	Cylinder Kit Complete	FP-23522525	20	w/Cross Head style piston; 1.050" port length sleeve
6	Cylinder Kit Complete	FP-2352294930	30	w/Cross Head style piston; 1.050" port length sleeve
6	Cylinder Kit Complete	FP-235053095	5	6-71 Engs.; w/Trunk style piston; .810" port length sleeve
6	Cylinder Kit Complete	FP-2350530910	10	6-71 Engs.; w/Trunk style piston; .810" port length sleeve
6	Cylinder Kit Complete	FP-2350530920	20	6-71 Engs.; w/Trunk style piston; .810" port length sleeve
6	Cylinder Kit Complete	FP-2350530930	30	6-71 Engs.; w/Trunk style piston; .810" port length sleeve
6	Cylinder Kit Complete	FP-235053065	5	6-71N Engs.; w/Trunk style piston; 1.05" port length sleeve
6	Cylinder Kit Complete	FP-5149263	10	6-71N Engs.; w/Trunk style piston; 1.05" port length sleeve
6	Cylinder Kit Complete	FP-5149264	20	6-71N Engs.; w/Trunk style piston; 1.05" port length sleeve
6	Cylinder Kit Complete	FP-2350530630	30	6-71N Engs.; w/Trunk style piston; 1.05" port length sleeve
6	Cylinder Kit Complete	FP-20022	STD	No. 1 Bore; w/Cross Head style piston
6	Cylinder Kit Complete	FP-20014	STD	No. 1 Bore; 6-71 Engs.; w/Trunk style piston
6	Cylinder Kit Complete	FP-20011	STD	No. 1 Bore; 6-71N Engs.; w/Trunk style piston; 1.05" port length sleeve
6	Cylinder Kit Complete	FP-23522949	STD	No. 2 Bore; w/Cross Head style piston; 1.050" port length sleeve
6	Cylinder Kit Complete	FP-23505308	STD	No. 2 Bore; 6-71 Engs.; w/Trunk style piston; .810" port length sleeve

(continued on next page)

## 112 Wheel Tractor 6-71 In-Line (2-Valve Cyl. Head), 6-71N In-Line (4-Valve Cyl. Head) Engs. (cont.) 7.0L 426 OHV Diesel L6 (6-71), 4.25" Bore (Detroit Diesel Eng.)

<b>CYLINDER COMPONENTS (cont.)</b>				
<b>QTY</b>	<b>LINERS (cont.)</b>	<b>PART NO.</b>	<b>SIZE</b>	<b>DESCRIPTION</b>
6	Cylinder Kit Complete	FP-23505305	STD	No. 2 Bore; 6-71N Engs.; w/Trunk style piston; 1.05" port length sleeve
6	Cylinder Kit Complete	FP-23522947	STD	No. 3 Bore; w/Cross Head style piston; 1.050" port length sleeve
6	Cylinder Kit Complete	FP-23505309	STD	No. 3 Bore; 6-71 Engs.; w/Trunk style piston
6	Cylinder Kit Complete	FP-23505306	STD	No. 3 Bore; 6-71N Engs.; w/Trunk style piston; 1.05" port length sleeve
6	Cylinder Kit Complete	FP-23522521	STD	No. 4 Bore; w/Cross Head style piston; 1.050" port length sleeve
6	Cylinder Kit Complete	FP-235053091	1	No. 4 Bore; 6-71 Engs.; w/Trunk style piston; .810" port length sleeve
6	Cylinder Kit Complete	FP-5149261	STD	No. 4 Bore; 6-71N Engs.; w/Trunk style piston; 1.05" port length sleeve
6	Liner Kit w/o Sleeve	FP-LCK5309		6-71 Engs.; 17.5:1 C.R.; w/Trunk style piston
6	Liner Kit w/o Sleeve	FP-LCK5306		6-71N Engs.; 18.7:1 C.R.; w/Trunk style piston
6	O-Ring	FP-8922221		w/Cross Head style piston
6	Cntr. Bore Insert	FP-5199871		.0015" Thicker than std., for .010-.030 O/S sleeves
6	Cntr. Bore Insert	FP-5148399		.0015" Thicker than std., for std.-.005 O/S sleeves
6	Cntr. Bore Insert	FP-5148440		.0015" Thinner than std., for std.-.005 O/S sleeves
6	Cntr. Bore Insert	FP-5194073		.0035 Thinner than std., for std.-.005 O/S sleeves
6	Cntr. Bore Insert	FP-5194163		.0040 Thinner than std., for .010-.030 O/S sleeves
6	Cntr. Bore Insert	FP-5194164		.0080" Thinner than std., for .010-.030 O/S sleeves
6	Cntr. Bore Insert	FP-5193316		Std. thickness (.1795-.1800), for .010-.030 O/S sleeves
6	Cntr. Bore Insert	FP-5184484		Std. thickness (.1795-.1800), for std.-.005 O/S sleeves
<b>QTY</b>	<b>PISTONS</b>	<b>PART NO.</b>	<b>SIZE</b>	<b>DESCRIPTION</b>
6	Piston Kit w/Pin & Retainers	FP-23522497	STD	w/Cross Head style piston
6	Piston With Retainers	FP-5189054	STD	6-71 Engs.; w/Trunk style piston; Dish Head, Cast Iron; 4-1/8, 2-3/16 Ring Groove
6	Piston With Retainers	FP-5149234	STD	6-71N Engs.; w/Trunk style piston
6	Piston Dome Kit	FP-23522475		17.0:1 C.R.; w/Cross Head style piston
6	Piston Dome Kit	FP-23522535		18.7:1 C.R.; w/Cross Head style piston
6	Crosshead Piston Dome	FP-23521992	STD	17.0:1 C.R.; w/Cross Head style piston
6	Crosshead Piston Dome	FP-23522026	STD	18.7:1 C.R.; w/Cross Head style piston
6	Piston Skirt	FP-23522070	STD	w/Cross Head style piston
6	Pin	FP-5144744	STD	w/Cross Head style piston; Nut plate type
6	Pin	FP-5101120	STD	w/Cross Head style piston; Slipper type
6	Pin	FP-5188406	STD	w/Trunk style piston
6	Pin	FP-5144495	STD	w/Trunk style piston; Drilled
6	Pin	FP-5130881	STD	w/Trunk style piston; Non-drilled
12	Piston Pin Retainer	FP-5180250		w/Cross Head style piston
12	Piston Pin Retainer	FP-5188405		w/Trunk style piston
12	Piston Pin Bolt	FP-5148373		7/16" - 20 x 2.00" Length
12	Piston Pin Bolt Spacer	FP-5144846		w/Cross Head style piston
6	Piston Pin Slipper Bearing	FP-23501687		w/Cross Head style piston; Slipper type design - 1 per cyl.
12	Pin Bushing	FP-5157274		w/.015" extra ID bore stock
12	Pin Bushing	FP-2409Y		w/1.5020" I.D., 1.7510" O.D., .7600" O.A.L.
<b>QTY</b>	<b>CONNECTING RODS &amp; BRGS.</b>	<b>PART NO.</b>	<b>SIZE</b>	<b>DESCRIPTION</b>
12	Con. Rod Bolt	FP-5132383		.4375" x 20 x 3.52"
12	Con. Rod Nut	FP-5117629		.4375" x 20
6	Rod Pair	FP-23511129	STD	Upper brg. w/2 oil slots
6	Rod Pair	FP-23511131	2	Upper brg. w/2 oil slots
6	Rod Pair	FP-23511133	10	Upper brg. w/2 oil slots
6	Rod Pair	FP-23511135	20	Upper brg. w/2 oil slots
6	Rod Pair	FP-23511137	30	Upper brg. w/2 oil slots
6	Rod Pair	FP-5193741	40	Upper brg. w/2 oil slots
<b>QTY</b>	<b>PISTON RINGS</b>	<b>PART NO.</b>	<b>SIZE</b>	<b>DESCRIPTION</b>
6	Ring Set Single Cylinder	FP-23522955	STD	w/Cross Head style piston; Std. gap Fire Ring
6	Ring Set Single Cylinder	FP-23522954	STD	w/Cross Head style piston; Wide gap Fire Ring
6	Ring Set Single Cylinder	FP-5193477	STD	6-71 Engs.; w/Trunk style piston; 4-1/8, 2-3/16 (1 cyl. set w/4 Chrome rings)
6	Ring Set Single Cylinder	FP-23514970	STD	6-71N Engs.; w/Trunk style piston; 4-.084, 2-3/16 (1 cyl. Set)
6	Compression Ring	FP-8924084		w/Cross Head style piston; Std. gap Fire Ring
6	Compression Ring	FP-8924083		w/Cross Head style piston; Wide gap Fire Ring
12	Compression Ring	FP-8926351		w/Cross Head style piston; 2nd & 3rd grooves
24	Compression Ring	FP-5185325		w/Trunk style piston
18	Compression Ring	FP-5102648		6-71N Engs.; Trunk style piston
12	Ring, Oil Control Set	FP-23522534		w/Cross Head style piston
6	Ring, Oil Control Set	FP-23514965		6-71N Engs.; Trunk style piston; Set for one piston

(continued on next page)





# John Deere Off Highway

## Wheel Tractor 6-71 In-Line (2-Valve Cyl. Head), 6-71N In-Line (4-Valve Cyl. Head) Eng. 112 7.0L 426 OHV Diesel L6 (6-71), 4.25" Bore (Detroit Diesel Eng.) (cont.)

KITS				
QTY	OVERHAUL KIT	PART NO.	SIZE	DESCRIPTION
1	In-Frame Overhaul Kit	FP-671XH		w/Cross Head style piston; Upper brg. w/2 oil slots
1	In-Frame Overhaul Kit	FP-6712V		6-71 Eng.; w/Trunk style piston; Upper brg. w/2 oil slots
1	In-Frame Overhaul Kit	FP-671NA		6-71N Eng.; w/Trunk style piston; Upper brg. w/2 oil slots
1	Complete Overhaul Kit	FP-671XHOH		w/Cross Head style piston; Upper brg. w/2 oil slots; Incl. High block gsks.
1	Complete Overhaul Kit	FP-6712VOH		6-71 Eng.; w/Trunk style piston; Upper rod brg. w/2 oil slots; Incl. High block & Low block gskt. sets
1	Complete Overhaul Kit	FP-671NAOH		6-71N Eng.; w/Trunk style piston; Upper brg. w/2 oil slots; Incl. High block gsks.

## Combine 6466D Eng. Wheel Tractor 6466D Eng. 113 7.6L 466 OHV Diesel L6 (Standard), 4.5625" Bore

### CYL. HEAD & PARTS

QTY	GASKETS	PART NO.	SIZE	DESCRIPTION
1	Valve Cover Gasket	FP-R49866		Rocker cover codes 1101, 1102; From Ser. No. 67,685
1	Head Gasket	FP-RE47336		w/O.E. thin black gskt.
1	Head Gasket	FP-R520706		From Ser. No. 67,685
1	Head Set	FP-AR100632		w/O.E. thick black w/blue strips gskt. marked R66065; From Ser. No. 67,685
QTY	HEAD BOLTS	PART NO.	SIZE	DESCRIPTION
11	Head Bolt	FP-R88043		w/Block marked R87554, R87555, R87556, R87557, R87559, R87562, R87563, R87564; From Ser. No. 318,404; 5.250" length
8	Head Bolt	FP-R88044		w/Block marked R87554, R87555, R87556, R87557, R87559, R87562, R87563, R87564; From Ser. No. 318,404; 6.250" length
7	Head Bolt	FP-R88045		w/Block marked R87554, R87555, R87556, R87557, R87559, R87562, R87563, R87564; From Ser. No. 318,404; 7.250" length
6	Head Bolt	FP-R88042		To Ser. No. 318,403; 3.250" length
5	Head Bolt	FP-R88043		To Ser. No. 318,403; 5.250" length
8	Head Bolt	FP-R88044		To Ser. No. 318,403; 6.250" length
7	Head Bolt	FP-R88045		To Ser. No. 318,403; 7.250" length
QTY	VALVE	PART NO.	SIZE	DESCRIPTION
6	Intake	FP-R43883	STD	1 groove; Chrome plated stem; 1.9020" Head Dia., .3720" Stem Dia., 6.1510" O.A.L.
6	Intake	FP-R45003	3	1 groove; Chrome plated stem; 1.9020" Head Dia., .3750" Stem Dia., 6.1510" O.A.L.
6	Intake	FP-R45005	30	1 groove; Chrome plated stem; 1.9020" Head Dia., .4020" Stem Dia., 6.1510" O.A.L.
6	Exhaust	FP-R43679	STD	1 groove; Chrome plated stem; 1.7150" Head Dia., .3720" Stem Dia., 6.1330" O.A.L.
6	Exhaust	FP-R43787	3	1 groove; Chrome plated stem; 1.7150" Head Dia., .3750" Stem Dia., 6.1330" O.A.L.
6	Exhaust	FP-R43788	15	1 groove; Chrome plated stem; 1.7150" Head Dia., .3870" Stem Dia., 6.1330" O.A.L.
6	Exhaust	FP-R43789	30	1 groove; Chrome plated stem; 1.7150" Head Dia., .4020" Stem Dia., 6.1330" O.A.L.
24	Keeper	FP-T20077		From Ser. No. 215,000; 1 groove; Square cut key groove; Hardened
24	Keeper	FP-41339		1 groove; Square cut key groove
24	Keeper, Bulk	VK-138B		1 groove; Square cut key groove; Carton of 1000
QTY	VALVE SEAT	PART NO.	SIZE	DESCRIPTION
6	Exh.	FP-R43681	STD	1.7555" OD, 1.5000" ID, .2480" Depth
6	Int.	FP-R43680	STD	
QTY	VALVE SPRING	PART NO.	SIZE	DESCRIPTION
12	Spring	FP-R26125		2.1200" Free Height
QTY	VALVE MISC.	PART NO.	SIZE	DESCRIPTION
6	Rotocap	FP-RE11410		Exh.; From Ser. No. 215,000
1	Oil Filler Cap Gasket	FP-T20328		
QTY	VALVE SEAL	PART NO.	SIZE	DESCRIPTION
6	Valve Stem Seal	FP-R87627		Int.; O-Ring type
ELECTRICAL				
QTY	ELECTRICAL	PART NO.	SIZE	DESCRIPTION
1	Starter to Block Gasket	FP-R53108		3-Hole mount; Starting motor codes 3004, 3005, 3011, 3016

(continued on next page)

## 113 Combine 6466D Eng. Wheel Tractor 6466D Eng. (cont.) 7.6L 466 OHV Diesel L6 (Standard), 4.5625" Bore

ELECTRICAL (cont.)				
QTY	ALTERNATOR	PART NO.	SIZE	DESCRIPTION
1	Ball Brg.	FP-JD9449		Front; Delco-Remy Nos. 1101268, 1101345, 1103128, 1105174, 1105422; Codes 3103, 3105, 3114; 72 amp alternator; 78 amp alternator
1	Ball Brg.	FP-JD9449		Front; Motorola No. 70D42076T02; Code 3101; 12 Volt, 65 amp alternator
METERS				
QTY	METERS	PART NO.	SIZE	DESCRIPTION
1	Speed/Hour Meter Gasket	FP-R62410		w/Tach. drive code 3303
INT & EXH MANIFOLDS				
QTY	INT. & EXH. MANIFOLDS	PART NO.	SIZE	DESCRIPTION
2	Exhaust Manifold Gasket	FP-R83021		One Exh. hole
2	Exhaust Manifold Gasket	FP-R83020		Two Exh. holes
3	Intake Manifold Gasket	FP-R50397		From Ser. No. 267,638 to Ser. No. 300,411; w/Int. manifold R52288; Two Int. holes
3	Intake Manifold Gasket	FP-R50397		From Ser. No. 300,412; w/Int. manifold R81927; Two Int. holes
3	Intake Manifold Gasket	FP-R26297		To Ser. No. 26637; w/Int. manifold R46411
CAMSHAFT GROUP				
QTY	TIMING COVER	PART NO.	SIZE	DESCRIPTION
1	Crankshaft Front Cover Gasket	FP-R26058		
1	Timing Gear Cover Gasket	FP-R50390		Access cover
1	Timing Gear Cover Gasket	FP-R50353		Timing cover code 2001; To Ser. No. 263,923
QTY	CAMSHAFT/LIFTER	PART NO.	SIZE	DESCRIPTION
1	Camshaft	FP-R71530		Cam marked R65565, R71530
1	Camshaft Plug	FP-R26115		
12	Lifter	FP-R52773		
1	Prelube	55-400		4 oz. bottle; 1.5 oz. packet No. 55-403 also avail.
QTY	CAMSHAFT KIT	PART NO.	SIZE	DESCRIPTION
1	Cam/Lifter Kit	FP-AR100386		Cam marked R65565, R71530; From Ser. No. 215,000; Incl. (12) FP-R52773, (1) FP-R71530
FUEL SYSTEM & PARTS				
QTY	FUEL INJECTION	PART NO.	SIZE	DESCRIPTION
6	Washer	FP-R64840		Injector nozzle; Steel
6	Fuel Injector Nut	FP-R79604		Inj. pump; Line codes 1602, 1603
6	Fuel Line Connector Gasket	FP-R59294		Leak-off connector washer; From Ser. No. 67,685; Alum.
12	Washer Type Seal	FP-R51936		Leak-off & return line seals; Nozzle codes 1602, 1603
QTY	FUEL FILTERS & PUMP	PART NO.	SIZE	DESCRIPTION
1	Mechanical Fuel Pump	FP-AR57264		Fuel pump codes 1602, 1603
6	O-Ring	FP-R77551		Leak-off fitting to nozzle; Viton®
6	O-Ring	FP-R51603		Fuel nozzle
COOLING SYSTEM				
QTY	WATER PUMP	PART NO.	SIZE	DESCRIPTION
1	Water Pump Impeller	FP-R50411		w/Pump housing marked R50408
1	Water Pump Repair/Rebuild Kit	FP-925750411		w/Pump housing marked R50408
1	Ball Brg.	FP-JD10171		Front bearing; w/Pump housing marked R71224
1	Ball Brg.	FP-JD10113		Rear bearing; w/Pump housing marked R71224
1	Water Pump Housing Gasket	FP-R50410		w/Pump housing marked R50408
1	Oil Seal Kit	FP-AR101549		Water Pump; w/Pump housing marked R50408
1	Water Pump Spacer Gasket	FP-R42406		w/Pump housing marked R50408
1	O-Ring	FP-R71596		Pump cover; w/Pump housing marked R71224, R83561
2	O-Ring	FP-R47153		Water manifold; Water manifold code 3905
1	Shaft & Bearing Assembly	FP-JD9257		w/Pump housing marked R58713
1	Water Pump Hub	FP-JD10058		w/Fan Hub bearing codes 2300, 2314
QTY	THERMOSTAT	PART NO.	SIZE	DESCRIPTION
2	Thermostat	FP-AR72852		Thermostat codes 2101, 2103; Thermostat housing code 3905; 192 Deg.
2	Thermostat	FP-AR48675		Thermostat codes 2101, 2103; 180 Deg.
1	Thermostat Cover Gasket	FP-R46479		Thermostat cover codes 2101, 2103; Two hole
1	Therm. Hsg. - Water Mfld. Gsk	FP-R86062		Thermostat housing to cyl. head
QTY	MISCELLANEOUS	PART NO.	SIZE	DESCRIPTION
2	Water Manifold Mounting Gskt.	FP-R88397		
1	Cyl. Block Water Hole Cvr Gsk	FP-R43595		Cyl. head water opening cover gskt.

(continued on next page)



# John Deere Off Highway

Combine **6466D Eng. Wheel Tractor 6466D Eng. 113**  
7.6L 466 OHV Diesel L6 (Standard), 4.5625" Bore (cont.)

ENGINE BLOCK & PARTS				
QTY	GASKETS	PART NO.	SIZE	DESCRIPTION
1	Oil Pan Gasket	FP-R71918		
1	Oil Pan Gasket	FP-R49377		w/Alum. pan; Oil pan codes 1906, 1908; From Ser. No. 67,685
1	Oil Pan Gasket Set	FP-PG400PS		From Ser. No. 67,685; w/Cast iron oil pan
1	Oil Pan Gasket Set	FP-PG401PS		From Ser. No. 67,685; w/Cast iron oil pan
1	Oil Pan Gasket Set	FP-PG403PS		From Ser. No. 67,685; w/Cast iron oil pan
2	O-Ring	FP-U13639		Block coolant drain plug seal; Coolant heater codes 2601, 2602; 1.475" X .118"
1	O-Ring	FP-U13639		Cooler bypass tube inlet seal; To Ser. No. 169,336; 1.475" X .118"
QTY	GASKET SETS	PART NO.	SIZE	DESCRIPTION
1	In-Frame Gasket Set	FP-PG466DS		
1	Complete Overhaul Gasket Set	FP-AR100638		Crankshaft seals not incl.
1	Complete Overhaul Gasket Set	FP-AR100638WS		Incl. crankshaft seals; Rear main brg. seal incl.; Wear sleeve; Timing cover seal & wear sleeve not incl.
1	Kit Gasket Set	260-1400		Compl.; Rear main brg. seal incl. & wear sleeve incl.; Timing cover seal & wear sleeve incl.
QTY	CAM BEARINGS	PART NO.	SIZE	DESCRIPTION
1	Cam Set	FP-4R46903	STD	
4	Cam Brg.	FP-R46903	STD	
QTY	OIL COOLERS & FILTERS	PART NO.	SIZE	DESCRIPTION
1	Oil Cooler	FP-AR55394		From Ser. No. 335,846
1	Oil Cooler Installation Kit	FP-58952		
4	O-Ring	FP-R47153		Cooler tube
1	Oil Cooler Bypass Gasket	FP-R65055		From Ser. No. 676,685
1	Oil Cooler Cover Gasket	FP-R50419		
CRANKSHAFT/OIL PUMP				
QTY	CRANKSHAFT	PART NO.	SIZE	DESCRIPTION
1	Crankshaft	FP-RE53422		Gears incl.
1	Crankshaft	FP-AR96189		Gears not incl.
1	Oil Seal Kit	FP-SK49025		Incl. front & rear seals
QTY	SEALS - FRONT CRANK	PART NO.	SIZE	DESCRIPTION
1	Oil Seal Kit	FP-AR49025		
QTY	SEALS - REAR CRANK	PART NO.	SIZE	DESCRIPTION
1	Oil Seal	FP-RE22764		PTFE
QTY	MAIN BEARINGS	PART NO.	SIZE	DESCRIPTION
1	Main Set	FP-MBK400L4	STD	w/5 main brgs.
1	Main Set	FP-MBK400L410	10	w/5 main brgs.
1	Main Set	FP-MBK400L420	20	w/5 main brgs.
1	Main Set	FP-MBK400L6	STD	w/7 main brgs.
1	Main Set	FP-MBK400L610	10	w/7 main brgs.
1	Main Set	FP-MBK400L620	20	w/7 main brgs.
1	Main Set	FP-MBK400L630	30	w/7 main brgs.
6	Plain Main Brg.	FP-AR74814	STD	
6	Plain Main Brg.	FP-AR74816	10	
6	Plain Main Brg.	FP-AR74817	20	
6	Plain Main Brg.	FP-AR74818	30	
1	Flanged Main Brg.	FP-AR77748	STD	
1	Flanged Main Brg.	FP-AR77750	10	
1	Flanged Main Brg.	FP-AR77751	20	
1	Flanged Main Brg.	FP-AR77752	30	
1	Thrust Washer Set	FP-AR77747	STD	
QTY	OIL PUMP	PART NO.	SIZE	DESCRIPTION
1	Oil Pump Spring	FP-R26151		
2	O-Ring	FP-R71732		Pump; Pump codes 1904, 1906, 1908; w/Pump marked R62946, R124328; From Ser. No. 169,337
4	O-Ring	FP-R71732		Pump; Pump codes 1904, 1908; w/Pump marked R57556; To Ser. No. 169,336
1	O-Ring	FP-R71732		Pump to block; Block codes 4602, 4603; From Ser. No. 169,337
1	O-Ring	FP-R495R		Ventilator tube; Smooth
1	Oil Pump Cover Gasket	FP-R52049		Oil pump codes 1904, 1907, 1908
1	Oil Pump Intake Gasket	FP-R100569		w/Oil pump housing marked R124328
1	Rect. or Square Seal	FP-R43660		Filter to housing; w/housing marked R67409, R71484, R84946
1	Oil Filter to Block Gasket	FP-R43774		w/Filter housing marked R67409, R71484, R84946

(continued on next page)

**113 Combine 6466D Eng. Wheel Tractor 6466D Eng.**  
(cont.) 7.6L 466 OHV Diesel L6 (Standard), 4.5625" Bore

**CYLINDER COMPONENTS**

QTY	LINERS	PART NO.	SIZE	DESCRIPTION
6	Liner w/o Sealing Ring	FP-R87858		
6	Liner w/Sealing Rings	FP-R87858WS		
6	Cylinder Kit Complete	FP-AR83610	STD	w/Block marked R65693, R71688, R72132, R78505, R87555, R87556; w/Con. Rod marked R41423, R58882, R66922
6	Cyl. Liner Sealing Ring Kit	FP-AR98850		

QTY	PISTONS	PART NO.	SIZE	DESCRIPTION
6	Piston Body w/o Pin	FP-AR85629		
6	Piston Kit w/Pin & Retainers	FP-AR85629WP	STD	
6	Pin	FP-R41425		
12	Piston Pin Retainer	FP-E1343FN		
6	Pin Bushing	FP-R42173		w/Con. Rod marked R41423, R58882, R66922; 1.627" ID, 1.8155" OD, 1.500" O.A.L.
6	Pin Bushing	FP-R60724		w/1.875" ID, 2.0622" OD, 1.657" O.A.L.

QTY	CONNECTING RODS & BRGS.	PART NO.	SIZE	DESCRIPTION
12	Con. Rod Bolt	FP-R66452		w/Con. Rod marked R41423, R58882, R66922; Torque-To-Yield bolt; Replacement recommended
6	Rod Pair	FP-AR45723	STD	
6	Rod Pair	FP-AR46396	10	
6	Rod Pair	FP-AR46397	20	
6	Rod Pair	FP-AR46398	30	

QTY	PISTON RINGS	PART NO.	SIZE	DESCRIPTION
6	Ring Set Single Cylinder	FP-AR87753	STD	1-5/32, 1-3/32, 1-3/16 (1 cyl. set)

**KITS**

QTY	OVERHAUL KIT	PART NO.	SIZE	DESCRIPTION
1	In-Frame Overhaul Kit	FP-466DIFK		w/Block marked R65693, R71688, R72132, R78505, R87555, R87556; w/Con. Rod marked R41423, R58882, R66922; To Ser. No. 278,680; Incl. Torque-To-Yield con. rod bolts
1	Complete Overhaul Kit	FP-466DOHK		w/Block marked R65693, R71688, R72132, R78505, R87555, R87556; w/Con. Rod marked R41423, R58882, R66922; To Ser. No. 278,680; Incl. Torque-To-Yield con. rod bolts

**114 Combine 6466A, 6466T Engs. Cotton Picker 6466A Eng. Corn Picker 6466A, 6466T Engs. Harvester 6466A, 6466T Engs. Grader 6466A, 6466T Engs. Loader 6466A, 6466T Engs. Scraper 6466A, 6466T Engs. Wheel Tractor 6466A, 6466T Engs. Crawler Tractor 6466A, 6466T Engs. Forestry Tractor 6466A, 6466T Engs. Excavator 6466A, 6466T Engs. Skidder 6466A, 6466T Engs. Compactor 6466A, 6466T Engs. Dozer 6466A, 6466T Engs. Feller Buncher 6466A, 6466T Engs. Forage Harvester 6466A Eng.**  
7.6L 466 OHV Turbo-Diesel L6 (Standard), 4.5625" Bore

**CYL. HEAD & PARTS**

QTY	GASKETS	PART NO.	SIZE	DESCRIPTION
1	Valve Cover Gasket	FP-R49866		Rocker cover codes 1101, 1102, 1103
1	Head Gasket	FP-RE47336		
1	Head Set	FP-AR98851		

QTY	HEAD BOLTS	PART NO.	SIZE	DESCRIPTION
11	Head Bolt	FP-R88043		w/Block marked R87554, R87555, R87556, R87559, R87562, R87563, R87564; From Ser. No. 318,404; 5.250" length
8	Head Bolt	FP-R88044		w/Block marked R87554, R87555, R87556, R87559, R87562, R87563, R87564; From Ser. No. 318,404; 6.250" length
7	Head Bolt	FP-R88045		w/Block marked R87554, R87555, R87556, R87559, R87562, R87563, R87564; From Ser. No. 318,404; 7.250" length
6	Head Bolt	FP-R88042		To Ser. No. 317,676; 3.250" length
5	Head Bolt	FP-R88043		To Ser. No. 317,676; 5.250" length
8	Head Bolt	FP-R88044		To Ser. No. 317,676; 6.250" length
7	Head Bolt	FP-R88045		To Ser. No. 317,676; 7.250" length

QTY	VALVE	PART NO.	SIZE	DESCRIPTION
6	Intake	FP-R50358	STD	From Ser. No. 335,846; 1 groove; 1.7150" Head Dia., .3720" Stem Dia., 6.1920" O.A.L.
6	Intake	FP-R55055	3	From Ser. No. 335,846; 1 groove; 1.7150" Head Dia., .3750" Stem Dia., 6.1920" O.A.L.
6	Intake	FP-R43914	STD	1 groove; Chrome plated stem; 1.7500" Head Dia., .3720" Stem Dia., 6.1280" O.A.L.
6	Intake	FP-R84618	STD	1 groove; Chrome plated stem; 2.0080" Head Dia., .3730" Stem Dia., 6.0600" O.A.L.

(continued on next page)



# John Deere Off Highway

Combine 6466A, 6466T Engs. Cotton Picker 6466A Eng. Corn Picker 6466A, 6466T Engs. 114  
 Harvester 6466A, 6466T Engs. Grader 6466A, 6466T Engs. Loader 6466A, 6466T Engs. (cont.)  
 Scraper 6466A, 6466T Engs. Wheel Tractor 6466A, 6466T Engs. Crawler Tractor 6466A,  
 6466T Engs. Forestry Tractor 6466A, 6466T Engs. Excavator 6466A, 6466T Engs. Skidder  
 6466A, 6466T Engs. Compactor 6466A, 6466T Engs. Dozer 6466A, 6466T Engs. Feller  
 Buncher 6466A, 6466T Engs. Forage Harvester 6466A Eng.  
 7.6L 466 OHV Turbo-Diesel L6 (Standard), 4.5625" Bore

## CYL. HEAD & PARTS (cont.)

QTY	VALVE (cont.)	PART NO.	SIZE	DESCRIPTION
6	Exhaust	FP-R50357	STD	From Ser. No. 335,846; 1 groove; Chrome plated stem; 1.7150" Head Dia., .3720" Stem Dia., 6.2080" O.A.L.
24	Keeper	FP-41339		1 groove; Square cut key groove
24	Keeper	FP-T20077		1 groove; Square cut key groove; Hardened
24	Keeper, Bulk	VK-138B		1 groove; Square cut key groove; Carton of 1000
QTY	VALVE SEAT	PART NO.	SIZE	DESCRIPTION
6	Exh.	FP-R50356	STD	From Ser. No. 335,846
6	Exh.	FP-R55061	10	From Ser. No. 335,846
6	Int.	FP-R78702	STD	1.7550" OD, 1.5000" ID, .2160" Depth
6	Int.	FP-R82508	10	1.7650" OD, 1.5000" ID, .2160" Depth
QTY	VALVE SPRING	PART NO.	SIZE	DESCRIPTION
12	Spring	FP-R26125		2.1200" Free Height
QTY	VALVE MISC.	PART NO.	SIZE	DESCRIPTION
12	Rotocap	FP-RE11410		Exh. & Int.
1	Oil Filler Cap Gasket	FP-T20328		6466A Engs.
QTY	VALVE SEAL	PART NO.	SIZE	DESCRIPTION
6	Valve Stem Seal	FP-R87627		Int.; O-Ring type

## ELECTRICAL

QTY	ELECTRICAL	PART NO.	SIZE	DESCRIPTION
1	Starter to Block Gasket	FP-R53108		3-Hole mount; Starting motor codes 3004, 3005. 3011, 3016; To Ser. No. 67,684
QTY	ALTERNATOR	PART NO.	SIZE	DESCRIPTION
1	Ball Brg.	FP-JD9449		Front; Delco-Remy Nos. 1101268, 1101345, 1103128, 1105174, 1105422, 1105510; Codes 3102, 3103, 3105, 3114; 12 Volt, 63 amp alternator; 72 amp alternator; 78 amp alternator
1	Ball Brg.	FP-JD9449		Front; Motorola No. 70D42076T02; Code 3101; 12 Volt, 37 amp alternator; 65 amp alternator
1	Ball Brg.	FP-JD9449		Front; Motorola Nos. 70D42179T02, 70D44811E01; Code 3106; 24 Volt, 45 amp alternator; From Ser. No. 296,082

## METERS

QTY	METERS	PART NO.	SIZE	DESCRIPTION
1	Speed/Hour Meter Gasket	FP-R62410		w/Tach. drive code 3303

## INT & EXH MANIFOLDS

QTY	INT. & EXH. MANIFOLDS	PART NO.	SIZE	DESCRIPTION
2	Exhaust Manifold Gasket	FP-R83021		One Exh. hole
2	Exhaust Manifold Gasket	FP-R83020		Two Exh. holes
3	Intake Manifold Gasket	FP-R130573		w/Int. manifold R134429, R134432
3	Intake Manifold Gasket	FP-R50397		From Ser. No. 299,712 to Ser. No. 324,348; w/Int. manifold R81927; Two Int. holes
3	Intake Manifold Gasket	FP-R130573		From Ser. No. 324,349; w/Int. manifold R89790
3	Intake Manifold Gasket	FP-R50397		To Ser. No. 299,711; w/Int. manifold R52288; Two Int. holes
QTY	AIR INTAKE	PART NO.	SIZE	DESCRIPTION
1	O-Ring	FP-R50406		Manifold coupling; Small end; From Ser. No. 67,684
1	O-Ring	FP-R50406		Manifold coupling; Small end; Manifold codes 1705, 1707, 1719, 1726, 1730; To Ser. No. 67,684

## CAMSHAFT GROUP

QTY	TIMING COVER	PART NO.	SIZE	DESCRIPTION
1	Crankshaft Front Cover Gasket	FP-R26058		
1	Timing Gear Cover Gasket	FP-R50390		Access cover
1	Timing Gear Cover Gasket	FP-R50353		Timing cover code 2001; To Ser. No. 263,923
QTY	CAMSHAFT/LIFTER	PART NO.	SIZE	DESCRIPTION
1	Camshaft	FP-R71529		
1	Camshaft	FP-R71530		Model 4440, 4640 From Ser. No. 570,601; Model 4840, 8430 From Ser. No. 572,027; Model 4250, 4450, 4650, 4850, 6620, 6622, 7720, 8450, 8820
1	Camshaft Plug	FP-R26115		
12	Lifter	FP-R52773		

(continued on next page)

**114** Combine 6466A, 6466T Engs. Cotton Picker 6466A Eng. Corn Picker 6466A, 6466T Engs. (cont.) Harvester 6466A, 6466T Engs. Grader 6466A, 6466T Engs. Loader 6466A, 6466T Engs. Scraper 6466A, 6466T Engs. Wheel Tractor 6466A, 6466T Engs. Crawler Tractor 6466A, 6466T Engs. Forestry Tractor 6466A, 6466T Engs. Excavator 6466A, 6466T Engs. Skidder 6466A, 6466T Engs. Compactor 6466A, 6466T Engs. Dozer 6466A, 6466T Engs. Feller Buncher 6466A, 6466T Engs. Forage Harvester 6466A Eng.  
7.6L 466 OHV Turbo-Diesel L6 (Standard), 4.5625" Bore

## CAMSHAFT GROUP (cont.)

QTY	CAMSHAFT/LIFTER (cont.)	PART NO.	SIZE	DESCRIPTION
1	Prelube	55-400		4 oz. bottle; 1.5 oz. packet No. 55-403 also avail.
QTY	CAMSHAFT KIT	PART NO.	SIZE	DESCRIPTION
1	Cam/Lifter Kit	FP-AR100385		Incl. (12) FP-R52773, (1) FP-R71529

## FUEL SYSTEM & PARTS

QTY	FUEL INJECTION	PART NO.	SIZE	DESCRIPTION
6	Washer	FP-R64840		Injector nozzle; Nozzle codes 1601, 1606, 1608, 1610, 1625, 1626, 1630, 1631, 1640, 1657, 1658, 1661, 1663; Steel
6	Fuel Injector Nut	FP-R79604		Inj. pump; Line codes 1606, 1608, 1610, 1625, 1626, 1630, 1631, 1640, 1661, 1663
18	Clamp	FP-R34766		Pump codes 1601, 1606, 1608; To Ser. No. 67,684
6	Fuel Line Connector Gasket	FP-R59294		Leak-off connector washer; w/Connector R59293, R83558; Alum.
6	Fuel Line Connector Gasket	FP-R59294		Leak-off connector washer; From Ser. No. 312,216; w/Connector R59293, R83558; Alum.
12	Washer Type Seal	FP-R51936		6466A Engs.; Leak-off & return line seals; Nozzle code 1606; To Ser. No. 301,495
14	Washer Type Seal	FP-R51936		6466A Engs.; Leak-off & return line seals; Nozzle codes 1606, 1608, 1610, 1626, 1629, 1630, 1631; To Ser. No. 301,495
12	Washer Type Seal	FP-R51936		6466A Engs.; RePower Engs.; Leak-off & return line seals; Nozzle codes 1657, 1658
14	Washer Type Seal	FP-R51936		6466A; Leak-off & return line seals; Nozzle codes 1610, 1625, 1626, 1640, 1661, 1643; From Ser. No. 300,713
12	Washer Type Seal	FP-R51936		6466T Engs.; Leak-off & return line seals; Nozzle codes 1601, 1604, 1610, 1657, 1658; To Ser. No. 301,473
QTY	FUEL FILTERS & PUMP	PART NO.	SIZE	DESCRIPTION
6	O-Ring	FP-R77551		6466A Engs.; Leak-off fitting to nozzle; Nozzle codes 1606, 1608, 1610, 1625, 1626, 1630, 1631, 1640, 1661, 1663; Viton®
6	O-Ring	FP-R77551		6466T Engs.; Leak-off fitting to nozzle; RePower Engs.; Nozzle codes 1657, 1658; Viton®
6	O-Ring	FP-R51603		Fuel nozzle; Injector nozzle codes 1601, 1606, 1608; w/Bosch injector; To Ser. No. 67,684
1	O-Ring	FP-R375R		Fuel check valve
QTY	TURBOCHARGER	PART NO.	SIZE	DESCRIPTION
1	Turbocharger Oil Drain Gasket	FP-R105346		From Ser. No. 67,685
1	Turbocharger Mounting Gasket	FP-R43751		
1	Turbocharger Oil Supply Gskt.	FP-R97348		Turbo code 6501; To Ser. No. 296,156

## COOLING SYSTEM

QTY	WATER PUMP	PART NO.	SIZE	DESCRIPTION
1	Water Pump Shaft	FP-R82052		6466A Engs.; w/Pump housing marked R69945
1	Water Pump Shaft	FP-R70965		6466A Engs.; Water pump code 2014; w/Pump marked R71224, R83561; Gear driven pump
1	Water Pump Impeller	FP-R71225		w/Pump housing marked R71224, R83561
1	Water Pump Impeller	FP-R77388		6466A Engs.; w/Pump housing marked R61439; From Ser. No. 211,132
1	Water Pump Impeller	FP-R50411		6466T Engs.; w/Pump housing marked R50408
1	Water Pump Repair/Rebuild Kit	FP-RE69846		w/Pump housing marked R71224; Gear driven pump
1	Water Pump Repair/Rebuild Kit	FP-RE69847		w/Pump housing marked R83561; Gear driven pump
1	Water Pump Repair/Rebuild Kit	FP-AR103451		6466A Engs.; w/Pump housing marked R69945
1	Water Pump Repair/Rebuild Kit	FP-RE10967		6466A Engs.; Pump code 2001
1	Water Pump Repair/Rebuild Kit	FP-925750411		6466T Engs.; w/Pump housing marked R50408
1	Water Pump Repair/Rebuild Kit	FP-935550411		6466T Engs.; w/Pump housing marked R54955
2	Ball Brg.	FP-JD10329		Fan hub shaft bearing
1	Ball Brg.	FP-JD10171		Front bearing; 6466A Engs.; w/Pump housing marked R71224
1	Ball Brg.	FP-JD10363		Gear driven front bearing; Water pump code 2014; w/Pump housing marked R83561
1	Ball Brg.	FP-JD10362		Gear driven rear bearing; Water pump code 2014; w/Pump housing marked R83561
1	Ball Brg.	FP-JD10113		Rear bearing; 6466A Engs.; w/Pump housing marked R71224
1	Water Pump Housing Gasket	FP-R69944		6466A Engs.; w/Pump housing marked R69945
1	Water Pump Housing Gasket	FP-R61437		6466A Engs.; w/Water pump AR98552; To Ser. No. 211,131
1	Water Pump Housing Gasket	FP-R61437		6466A Engs.; w/Water pump RE10969; From Ser. No. 211,132
1	Water Pump Housing Gasket	FP-R50410		6466T Engs.; w/Pump housing marked R50408

(continued on next page)



# John Deere Off Highway

**Combine 6466A, 6466T Engs. Cotton Picker 6466A Eng. Corn Picker 6466A, 6466T Engs. 114**  
**Harvester 6466A, 6466T Engs. Grader 6466A, 6466T Engs. Loader 6466A, 6466T Engs. (cont.)**  
**Scraper 6466A, 6466T Engs. Wheel Tractor 6466A, 6466T Engs. Crawler Tractor 6466A,**  
**6466T Engs. Forestry Tractor 6466A, 6466T Engs. Excavator 6466A, 6466T Engs. Skidder**  
**6466A, 6466T Engs. Compactor 6466A, 6466T Engs. Dozer 6466A, 6466T Engs. Feller**  
**Buncher 6466A, 6466T Engs. Forage Harvester 6466A Eng.**  
 7.6L 466 OHV Turbo-Diesel L6 (Standard), 4.5625" Bore

## COOLING SYSTEM (cont.)

QTY	WATER PUMP (cont.)	PART NO.	SIZE	DESCRIPTION
1	Oil Seal Kit	FP-AR101549		Water Pump; w/Pump housing marked R50408
1	Water Pump Mounting Gasket	FP-R71315		w/Pump housing marked R71224, R83561; From Ser. No. 67,685
1	Water Pump Inlet Gasket	FP-R71361		w/Pump housing marked R71224, R83561; From Ser. No. 67,685
1	Water Pump Spacer Gasket	FP-R42406		w/Pump housing marked R50408, R58713
1	Oil Seal	FP-RE39134		Water pump code 2014; w/Pump housing marked R71224, R83561
1	O-Ring	FP-R72328		Water tube to thermostat housing seal; Turbo line codes 6501, 6502
1	O-Ring	FP-R71596		Pump cover; w/Pump housing marked R71224, R83561
1	O-Ring	FP-R47153		Water manifold; Water manifold codes 2107, 2108
2	O-Ring	FP-R47153		Water manifold; 6466T Engs.; Water manifold code 3905
2	O-Ring	FP-R47153		Water pump tube; Pump code 2014
1	Oil Seal	FP-RE20768		Fan hub shaft seal; For gear driven water pump
1	Shaft & Bearing Assembly	FP-JD9257		w/Pump housing marked R58713; To Ser. No. 211,131
1	Shaft & Bearing Assembly	FP-JD10238		6466A Engs.; w/Pump housing marked R61439; From Ser. No. 211,132
1	Water Pump Hub	FP-JD10058		w/Fan Hub bearing codes 2300, 2306, 2307, 2309, 2310, 2314
1	Water Pump Filter	FP-R98527		w/Pump housing marked R71224, R83561
2	Thermostat	FP-AR48675		Thermostat codes 2101, 2103, 2107, 2108, 2204; 180 Deg.
2	Thermostat	FP-AR72852		Thermostat codes 2102, 2103; Thermostat housing code 3905; 192 Deg.
1	Thermostat Cover Gasket	FP-R46479		Thermostat cover codes 2101, 2102, 2103, 2104, 2107, 2108; Two hole
1	Therm. Hsg. - Water Mfld. Gsk	FP-R86062		Thermostat housing to cyl. head
1	Water Line Gasket	FP-R97346		w/Int. manifold R59747, R92644; From Ser. No. 67,685
2	Water Manifold Mounting Gskt.	FP-R88397		
1	Cyl. Block Water Hole Cvr Gsk	FP-R43595		Cyl. head water opening cover gskt.

## ENGINE BLOCK & PARTS

QTY	GASKETS	PART NO.	SIZE	DESCRIPTION
1	Oil Pan Gasket	FP-R71918		
1	Oil Pan Gasket	FP-R49377		6466A Engs.; w/Alum. oil pan w/deep sump; Oil pan codes 1906, 1908, 1922
1	Oil Pan Gasket Set	FP-PG401PS		From Ser. No. 67,685; w/Cast iron oil pan
1	Oil Pan Gasket Set	FP-PG400PS		6466A Engs.; From Ser. No. 67,685; w/Cast iron oil pan
2	O-Ring	FP-U13639		Block coolant drain plug seal; Coolant heater codes 2601, 2602; 1.475" X .118"
1	O-Ring	FP-U13639		Cooler bypass tube inlet seal; To Ser. No. 169,336; 1.475" X .118"
1	In-Frame Gasket Set	FP-PG466TAS		6466A Engs.
1	Complete Overhaul Gasket Set	FP-AR98845		Crankshaft seals not incl.
1	Complete Overhaul Gasket Set	FP-AR98845WS		Incl. Crankshaft seals; Rear main brg. seal incl.; Wear sleeve; Timing cover seal & wear sleeve not incl.
1	Kit Gasket Set	260-1400		Compl.; Rear main brg. seal incl. & wear sleeve incl.; Timing cover seal & wear sleeve incl.
1	Cam Set	FP-4R46903	STD	
4	Cam Brg.	FP-R46903	STD	
1	Aftercooler Gasket Set	FP-466A		6466A Engs.; From Ser. No. 67,685
2	Aftercooler Gasket	FP-R97347		6466A Engs.; From Ser. No. 67,685
1	Oil Cooler	FP-AT25038		w/13 plate
1	Oil Cooler Installation Kit	FP-58952		
2	O-Ring	FP-R52811		6466A Engs.; Intercooler inlet & outlet tube seals; Int. manifold codes 1705, 1707, 1719, 1726
4	O-Ring	FP-R47153		Cooler tube
1	Oil Cooler Bypass Gasket	FP-R65055		
1	Oil Cooler Cover Gasket	FP-R50419		

(continued on next page)

**114** Combine 6466A, 6466T Engs. Cotton Picker 6466A Eng. Corn Picker 6466A, 6466T Engs. (cont.) Harvester 6466A, 6466T Engs. Grader 6466A, 6466T Engs. Loader 6466A, 6466T Engs. Scraper 6466A, 6466T Engs. Wheel Tractor 6466A, 6466T Engs. Crawler Tractor 6466A, 6466T Engs. Forestry Tractor 6466A, 6466T Engs. Excavator 6466A, 6466T Engs. Skidder 6466A, 6466T Engs. Compactor 6466A, 6466T Engs. Dozer 6466A, 6466T Engs. Feller Buncher 6466A, 6466T Engs. Forage Harvester 6466A Eng.  
7.6L 466 OHV Turbo-Diesel L6 (Standard), 4.5625" Bore

### CRANKSHAFT/OIL PUMP

QTY	CRANKSHAFT	PART NO.	SIZE	DESCRIPTION
1	Crankshaft	FP-RE53422		Gears incl.
1	Crankshaft	FP-AR96189		Gears not incl.
1	Oil Seal Kit	FP-SK49025		Incl. front & rear seals
QTY	SEALS - FRONT CRANK	PART NO.	SIZE	DESCRIPTION
1	Oil Seal Kit	FP-AR49025		
QTY	SEALS - REAR CRANK	PART NO.	SIZE	DESCRIPTION
1	Oil Seal	FP-RE22764		PTFE
QTY	MAIN BEARINGS	PART NO.	SIZE	DESCRIPTION
1	Main Set	FP-MBK400L6	STD	
1	Main Set	FP-MBK400L610	10	
1	Main Set	FP-MBK400L620	20	
1	Main Set	FP-MBK400L630	30	
6	Plain Main Brg.	FP-AR74814	STD	
6	Plain Main Brg.	FP-AR74816	10	
6	Plain Main Brg.	FP-AR74817	20	
6	Plain Main Brg.	FP-AR74818	30	
1	Flanged Main Brg.	FP-AR77748	STD	
1	Flanged Main Brg.	FP-AR77750	10	
1	Flanged Main Brg.	FP-AR77751	20	
1	Flanged Main Brg.	FP-AR77752	30	
1	Thrust Washer Set	FP-AR77747	STD	
QTY	OIL PUMP	PART NO.	SIZE	DESCRIPTION
1	Oil Pump Spring	FP-R26151		
1	O-Ring	FP-R50405		Intake coupling; 6466A Engs.; Large end; Int. manifold codes 1705, 1707, 1719, 1726, 1730
2	O-Ring	FP-R71732		Pump; Pump codes 1904, 1906, 1908, 1922; w/Pump marked R62946, R124328; From Ser. No. 169,337
4	O-Ring	FP-R71732		Pump; Pump codes 1904, 1908; w/Pump marked R57556; To Ser. No. 169,336
2	O-Ring	FP-R71732		Pump; 6466A Engs.; Pump codes 1904, 1906, 1907, 1908, 1922; w/Pump marked R62946, R124328
1	O-Ring	FP-R71732		Pump to block; Block codes 4602, 4603; From Ser. No. 169,337
1	O-Ring	FP-R495R		Ventilator tube; 6466A Engs.; Smooth
1	Oil Pump Cover Gasket	FP-R52049		6466A Engs.; Oil pump codes 1904, 1907; From Ser. No. 169,337
1	Oil Pump Cover Gasket	FP-R52049		6466A Engs.; Oil pump codes 1904, 1908; To Ser. No. 169,336
1	Oil Pump Intake Gasket	FP-R100569		6466A Engs.; w/Oil pump housing marked R124328
1	Rect. or Square Seal	FP-R43660		Filter to housing; 6466A Engs.; Filter & body codes 1601, 1606, 1608; w/housing marked R54561, R59483, R62110, R67409, R71484, R84946
1	Oil Filter to Block Gasket	FP-R43774		6466A Engs.; w/Filter housing marked R67409, R71484, R84946

### CYLINDER COMPONENTS

QTY	LINERS	PART NO.	SIZE	DESCRIPTION
6	Liner w/o Sealing Ring	FP-R87858		
6	Liner w/Sealing Rings	FP-R87858WS		
6	Cylinder Kit Complete	FP-AR72079	STD	6466A Engs.; w/Block marked R65693, R71688, R72132, R78505, R87555, R87556; w/Con. Rod marked R57303, R67320; To Ser. No. 67,684
6	Cylinder Kit Complete	FP-AR100646	STD	6466A Engs.; w/Block marked R65693, R71688, R72132, R78505, R87555, R87556; w/Con. Rod marked R71074; Piston code 4804; From Ser. No. 67,685
6	Cylinder Kit Complete	FP-AR100960	STD	6466A Engs.; w/Block marked R65693, R71688, R72132, R78505, R87555, R87556; w/Con. Rod marked R71074; Piston code 4806; From Ser. No. 233,593 to Ser. No. 317,858
6	Cylinder Kit Complete	FP-AR72079	STD	6466T Engs.; w/Block marked R65693, R71688, R72132, R78505, R87555, R87556; w/Con. Rod marked R57303, R67320; To Ser. No. 253,372
6	Cylinder Kit Complete	FP-AR100646	STD	6466T Engs.; w/Block marked R65693, R71688, R72132, R78505, R87555, R87556; w/Con. Rod marked R71074; From Ser. No. 253,373
6	Cyl. Liner Sealing Ring Kit	FP-AR98850		

(continued on next page)





# John Deere Off Highway

**Combine 6466A, 6466T Engs. Cotton Picker 6466A Eng. Corn Picker 6466A, 6466T Engs. 114**  
**Harvester 6466A, 6466T Engs. Grader 6466A, 6466T Engs. Loader 6466A, 6466T Engs. (cont.)**  
**Scraper 6466A, 6466T Engs. Wheel Tractor 6466A, 6466T Engs. Crawler Tractor 6466A,**  
**6466T Engs. Forestry Tractor 6466A, 6466T Engs. Excavator 6466A, 6466T Engs. Skidder**  
**6466A, 6466T Engs. Compactor 6466A, 6466T Engs. Dozer 6466A, 6466T Engs. Feller**  
**Buncher 6466A, 6466T Engs. Forage Harvester 6466A Eng.**  
 7.6L 466 OHV Turbo-Diesel L6 (Standard), 4.5625" Bore

## CYLINDER COMPONENTS (cont.)

QTY	PISTONS	PART NO.	SIZE	DESCRIPTION
6	Piston Body w/o Pin	FP-AR100673	STD	6466A Engs.; Piston code 4806; From Ser. No. 233,593 to Ser. No. 317,858
6	Piston Body w/o Pin	FP-AR100616	STD	6466A Engs.; Piston Code 4807; From Ser. No. 317,859
6	Piston Body w/o Pin	FP-AR93629	STD	6466A Engs.; To Ser. No. 253,372
6	Piston Body w/o Pin	FP-AR100616	STD	6466T Engs.; From Ser. No. 67,685
6	Piston Body w/o Pin	FP-AR93629	STD	6466T Engs.; To Ser. No. 67,684
6	Piston Kit w/Pin & Retainers	FP-AR100673WP	STD	6466A Engs.; Piston code 4806; From Ser. No. 233,593 to Ser. No. 317,858
6	Piston Kit w/Pin & Retainers	FP-AR100616WP	STD	6466A Engs.; Piston Code 4807; From Ser. No. 317,859
6	Piston Kit w/Pin & Retainers	FP-AR93629WP	STD	6466A Engs.; To Ser. No. 253,372
6	Piston Kit w/Pin & Retainers	FP-AR100616WP	STD	6466T Engs.; From Ser. No. 67,685
6	Piston Kit w/Pin & Retainers	FP-AR93629WP	STD	6466T Engs.; To Ser. No. 67,684
6	Pin	FP-R57771		
12	Piston Pin Retainer	FP-E1343FN		
6	Pin Bushing	FP-R60724		6466A Engs.; w/Con. Rod marked R67320; To Ser. No. 67,684; w/1.875" ID, 2.0622" OD, 1.657" O.A.L.
6	Pin Bushing	FP-R74008		6466A Engs.; w/Con. Rod marked R71074; From Ser. No. 67,685; 1.877" ID, 2.0622 OD, 1.8728" O.A.L.
6	Pin Bushing	FP-R60724		6466T Engs.; w/Con. Rod marked R57303, R67320; To Ser. No. 253,372; w/1.875" ID, 2.0622" OD, 1.657" O.A.L.
6	Pin Bushing	FP-R74008		6466T Engs.; w/Con. Rod marked R71074; From Ser. No. 253,373; 1.877" ID, 2.0622 OD, 1.8728" O.A.L.

QTY	CONNECTING RODS & BRGS.	PART NO.	SIZE	DESCRIPTION
12	Con. Rod Bolt	FP-R66452		w/Con. Rod marked R57303, R67320, R71074; Torque-To-Yield bolt; Replacement recommended
6	Rod Pair	FP-AR73277	STD	
6	Rod Pair	FP-AR73279	10	
6	Rod Pair	FP-AR73280	20	
6	Rod Pair	FP-AR73281	30	

QTY	PISTON RINGS	PART NO.	SIZE	DESCRIPTION
6	Ring Set Single Cylinder	FP-RE48380	STD	2-5/32, 1-3/16 (1 cyl. set)

## KITS

QTY	OVERHAUL KIT	PART NO.	SIZE	DESCRIPTION
1	In-Frame Overhaul Kit	FP-466AHPFK		6466A Engs.; w/Block marked R65693, R71688, R72132, R78505, R87555, R87556; w/Con. Rod marked R71074; Piston code 4806; From Ser. No. 233,593 to Ser. No. 317,858; Incl. Torque-To-Yield con. rod bolts
1	In-Frame Overhaul Kit	FP-466TAEIFK		6466A Engs.; w/Con. Rod marked R67320; To Ser. No. 67,684; Incl. Torque-To-Yield con. rod bolts
1	In-Frame Overhaul Kit	FP-466TALIFK		6466A Engs.; w/Con. Rod marked R71074; From Ser. No. 67,685; Incl. Torque-To-Yield con. rod bolts
1	In-Frame Overhaul Kit	FP-466TAEIFK		6466T Engs.; w/Con. Rod marked R57303, R67320; To Ser. No. 253,372; Incl. Torque-To-Yield con. rod bolts
1	In-Frame Overhaul Kit	FP-466TALIFK		6466T Engs.; w/Con. Rod marked R71074; From Ser. No. 253,373; Incl. Torque-To-Yield con. rod bolts
1	Complete Overhaul Kit	FP-466AHPHOK		6466A Engs.; w/Block marked R65693, R71688, R72132, R78505, R87555, R87556; w/Con. Rod marked R71074; Piston code 4806; From Ser. No. 233,593 to Ser. No. 317,858; Incl. Torque-To-Yield con. rod bolts
1	Complete Overhaul Kit	FP-466TAEOHK		6466A Engs.; w/Con. Rod marked R67320; To Ser. No. 67,684; Incl. Torque-To-Yield con. rod bolts
1	Complete Overhaul Kit	FP-466TALOHK		6466A Engs.; w/Con. Rod marked R71074; From Ser. No. 67,685; Incl. Torque-To-Yield con. rod bolts
1	Complete Overhaul Kit	FP-466TAEOHK		6466T Engs.; w/Con. Rod marked R57303, R67320; To Ser. No. 253,372; Incl. Torque-To-Yield con. rod bolts
1	Complete Overhaul Kit	FP-466TALOHK		6466T Engs.; w/Con. Rod marked R71074; From Ser. No. 253,373; Incl. Torque-To-Yield con. rod bolts

## 115 Loader 6076D Eng. 7.6L 465.9 (7638cc) OHV Diesel L6 (Litre Engine), 115mm Bore

CYL. HEAD & PARTS				
QTY	GASKETS	PART NO.	SIZE	DESCRIPTION
1	Head Gasket	FP-RE47336		From Ser. No. 500,000
1	Head Set	FP-RG22248		From Ser. No. 500,000
QTY	HEAD BOLTS	PART NO.	SIZE	DESCRIPTION
11	Head Bolt	FP-R88043		To Ser. No. 499,999; 5.250" length
8	Head Bolt	FP-R88044		To Ser. No. 499,999; 6.250" length
7	Head Bolt	FP-R88045		To Ser. No. 499,999; 7.250" length
QTY	VALVE	PART NO.	SIZE	DESCRIPTION
6	Intake	FP-R84618	STD	1 groove; Chrome plated stem; 2.0080" Head Dia., .3730" Stem Dia., 6.0600" O.A.L.
6	Intake	FP-R93308	3	1 groove; Chrome plated stem; 2.0080" Head Dia., .3760" Stem Dia., 6.0600" O.A.L.
6	Exhaust	FP-R84619	STD	1 groove; Chrome plated stem; 1.8500" Head Dia., .3720" Stem Dia., 6.1780" O.A.L.
6	Exhaust	FP-R93311	3	1 groove; Chrome plated stem; 1.8500" Head Dia., .3750" Stem Dia., 6.1780" O.A.L.
12	Valve Stem Cap	FP-T20129		
QTY	VALVE SEAT	PART NO.	SIZE	DESCRIPTION
6	Exh.	FP-R84976	STD	
6	Exh.	FP-R93349	10	
6	Int.	FP-R84977	STD	
6	Int.	FP-R93350	10	
QTY	VALVE SPRING	PART NO.	SIZE	DESCRIPTION
12	Spring	FP-R91822		
QTY	VALVE MISC.	PART NO.	SIZE	DESCRIPTION
12	Rotocap	FP-RE11410		Exh. & Int.
1	Oil Filler Cap Gasket	FP-T20328		Rocker arm cover codes 1101, 1103, 2904, 2908; Oil filler neck codes 1208, 6209
ELECTRICAL				
QTY	ELECTRICAL	PART NO.	SIZE	DESCRIPTION
1	Starter to Block Gasket	FP-R53108		3-Hole mount; Starting motor codes 3004, 3005, 3011, 3016
QTY	ALTERNATOR	PART NO.	SIZE	DESCRIPTION
1	Ball Brg.	FP-JD9449		Front; Delco-Remy components; Code 3132; 24 Volt, 40 amp alternator
1	Ball Brg.	FP-JD9449		Front; Delco-Remy No. 1101345; Code 3114; 12 Volt, 78 amp alternator
1	Ball Brg.	FP-JD9449		Front; Nippondenso components; Code 3143; 12 Volt, 90 amp alternator; Poly-Vee fan drive
1	Ball Brg.	FP-JD9449		Front; Nippondenso components; 12 Volt, 90 amp alternator
2	Ball Brg.	FP-JD9449		Front & Rear; Motorola No. 70D42179T02; Code 3106; 24 Volt, 45 amp alternator
METERS				
QTY	METERS	PART NO.	SIZE	DESCRIPTION
1	O-Ring	FP-R79915		Tach sensor seal to cover; Codes 4402, 4420
INT & EXH MANIFOLDS				
QTY	INT. & EXH. MANIFOLDS	PART NO.	SIZE	DESCRIPTION
3	Intake Manifold Gasket	FP-R130573		From Ser. No. 500,000; w/Int. manifolds R89790, R115393, R130718, R131473, R131651, R131657, R132290, R134429
3	Intake Manifold Gasket	FP-R130573		To Ser. No. 499,999; w/Int. manifolds R89790, R96518
CAMSHAFT GROUP				
QTY	TIMING COVER	PART NO.	SIZE	DESCRIPTION
1	Crankshaft Front Cover Gasket	FP-R26058		To Ser. No. 499,999
QTY	CAMSHAFT/LIFTER	PART NO.	SIZE	DESCRIPTION
1	Camshaft Plug	FP-R82007		
FUEL SYSTEM & PARTS				
QTY	FUEL INJECTION	PART NO.	SIZE	DESCRIPTION
1	Washer	FP-R53901		Control valve seal to housing; Pump housing codes 1601, 1637, 1688, 1689; Filter & line codes 3511, 3512
1	Washer	FP-R53899		Fuel filter codes 3511, 3512
6	Washer	FP-R84472		Injector nozzle; Nozzle codes 1604, 1610, 1616, 1650; .290" X .715" X .079"
6	Fuel Injector Nut	FP-R79604		Inj. pump; Line codes 1601, 1604, 1623, 1637, 1644, 1652, 1667, 1680, 1683, 1686, 1688; To Ser. No. 499,999

(continued on next page)



# John Deere Off Highway

Loader 6076D Eng. 115  
7.6L 465.9 (7638cc) OHV Diesel L6 (Litre Engine), 115mm Bore (cont.)

<b>FUEL SYSTEM &amp; PARTS (cont.)</b>				
QTY	FUEL INJECTION (cont.)	PART NO.	SIZE	DESCRIPTION
13	Washer Type Seal	FP-R51936		Leak-off & return line seals; Nozzle codes 1604, 1610, 1616, 1637, 1650
13	Washer Type Seal	FP-R51936		L.H. & R.H.; Aux. drive line seals
QTY	FUEL FILTERS & PUMP	PART NO.	SIZE	DESCRIPTION
6	O-Ring	FP-R77551		Leak-off fitting to nozzle; Nozzle codes 1601, 1604, 1610, 1615, 1616, 1623, 1637, 1644, 1650; Viton®
QTY	TURBOCHARGER	PART NO.	SIZE	DESCRIPTION
1	O-Ring	FP-R86743		Outer coupling; Manifold code 1726
<b>COOLING SYSTEM</b>				
QTY	WATER PUMP	PART NO.	SIZE	DESCRIPTION
1	Water Pump Impeller	FP-R71225		Water pump code 2032; w/Pump housing marked R83561
2	Ball Brg.	FP-JD10329		Fan hub shaft bearing
1	Ball Brg.	FP-JD10363		Gear driven front bearing; Water pump code 2032; w/Pump housing marked R83561
1	Ball Brg.	FP-JD10362		Gear driven rear bearing; Water pump code 2032; w/Pump housing marked R83561
1	Water Pump Inlet Gasket	FP-R71361		w/Pump housing marked R83561; To Ser. No. 499,999
1	Oil Seal	FP-RE39134		Water pump code 2032; w/Pump housing marked R83561; To Ser. No. 499,999
3	O-Ring	FP-R72328		Water tube to thermostat housing seal; Water pump code 2030; Thermostat housing code 3905
1	O-Ring	FP-R101042		Housing to cover; Water pump code 2030; w/Gear driven pump
1	O-Ring	FP-R71596		Pump cover; w/Pump housing marked R83561; Water pump code 2032
2	O-Ring	FP-R47153		Water pump tube
1	Oil Seal	FP-RE20768		Fan hub shaft seal; For gear driven water pump; From Ser. No. 500,000
1	Water Pump Hub	FP-JD10058		w/Fan Hub bearing codes 2317, 2318, 2324, 2328, 2329, 2330, 2331, 2332, 2334, 2336, 2338, 2339
1	Water Pump Filter	FP-R98527		Water pump code 2032; w/Pump housing marked R83561; From Ser. No. 101,935
QTY	THERMOSTAT	PART NO.	SIZE	DESCRIPTION
2	Thermostat	FP-AR48675		Thermostat code 2204; 180 Deg.
1	Thermostat Cover Gasket	FP-R46479		Thermostat cover codes 2102, 2114, 2204, 3904, 3912; Two hole
2	O-Ring	FP-R47153		Thermostat; Water manifold codes 3904, 3912
QTY	MISCELLANEOUS	PART NO.	SIZE	DESCRIPTION
2	Water Manifold Mounting Gskt.	FP-R88397		
<b>ENGINE BLOCK &amp; PARTS</b>				
QTY	GASKETS	PART NO.	SIZE	DESCRIPTION
1	Front Cover Gasket	FP-R125670		Aux. drive L.H. rear cover gskt.
1	Oil Pan Gasket	FP-R71918		
1	Oil Pan Gasket	FP-R49377		w/Alum. pan; Oil pan codes 1906, 1916, 1922, 1953, 1954
1	Oil Pan Gasket Set	FP-PG400PS		To Ser. No. 499,999; w/Cast iron oil pan
2	O-Ring	FP-U13639		Block coolant drain plug seal; Coolant heater codes 2601, 2602; 1.475" X .118"
QTY	GASKET SETS	PART NO.	SIZE	DESCRIPTION
1	In-Frame Gasket Set	FP-PG6076LS		From Ser. No. 500,000
1	In-Frame Gasket Set	FP-PG6076ES		To Ser. No. 499,999
1	Complete Overhaul Gasket Set	FP-RE64206		From Ser. No. 500,000; Crankshaft seals not incl.
1	Complete Overhaul Gasket Set	FP-RE64206WS		From Ser. No. 500,000; Incl. Crankshaft seals
1	Complete Overhaul Gasket Set	FP-RE35647		To Ser. No. 499,999; Crankshaft seals not incl.
1	Complete Overhaul Gasket Set	FP-RE35647WS		To Ser. No. 499,999; Incl. Crankshaft seals
QTY	CAM BEARINGS	PART NO.	SIZE	DESCRIPTION
1	Cam Brg.	FP-R87561		
QTY	OIL COOLERS & FILTERS	PART NO.	SIZE	DESCRIPTION
4	O-Ring	FP-R47153		Cooler tube
<b>CRANKSHAFT/OIL PUMP</b>				
QTY	CRANKSHAFT	PART NO.	SIZE	DESCRIPTION
1	Crankshaft	FP-RE53422		Gears incl.; Short snout 3.000"
1	Crankshaft	FP-AR96189		Gears not incl.
1	Oil Seal Kit	FP-SK49025		Incl. front & rear seals
QTY	SEALS - FRONT CRANK	PART NO.	SIZE	DESCRIPTION
1	Oil Seal Kit	FP-AR49025		

(continued on next page)

**115 Loader 6076D Eng.**  
(cont.) 7.6L 465.9 (7638cc) OHV Diesel L6 (Litre Engine), 115mm Bore

**CRANKSHAFT/OIL PUMP (cont.)**

QTY	SEALS - REAR CRANK	PART NO.	SIZE	DESCRIPTION
1	Oil Seal	FP-RE22764		PTFE
QTY	MAIN BEARINGS	PART NO.	SIZE	DESCRIPTION
5	Plain Main Brg.	FP-AR74814	STD	
5	Plain Main Brg.	FP-AR74816	10	
5	Plain Main Brg.	FP-AR74817	20	
5	Plain Main Brg.	FP-AR74818	30	
1	Flanged Main Brg.	FP-AR77748	STD	
1	Flanged Main Brg.	FP-AR77750	10	
1	Flanged Main Brg.	FP-AR77751	20	
1	Flanged Main Brg.	FP-AR77752	30	
1	Thrust Washer Set	FP-AR77747	STD	
QTY	OIL PUMP	PART NO.	SIZE	DESCRIPTION
3	O-Ring	FP-U17409		Oil cooler relief valve plug seal; Filter & housing code 5919
4	O-Ring	FP-R71732		Pump by-pass tubes; Pump codes 5001, 5003, 5004; w/Pump marked R62946, R124328
1	Oil Pump Intake Gasket	FP-R100569		w/Oil pump housing marked R124328, R124746; Oil pump pickup codes 1904, 1906, 1908, 1916, 1922, 1953
1	Rect. or Square Seal	FP-R43660		Filter to housing; Filter & body code 5919; w/housing marked R120412
1	Oil Pump Intake Elbow Gasket	FP-R71312		w/Rear deep sump; Oil pump code 5003; Oil pan code 1906
1	Oil Filter to Block Gasket	FP-R43774		Filter housing code 5931

**CYLINDER COMPONENTS**

QTY	LINERS	PART NO.	SIZE	DESCRIPTION
6	Liner w/o Sealing Ring	FP-R87858		
6	Liner w/Sealing Rings	FP-R87858WS		
6	Cylinder Kit Complete	FP-RE60294	STD	w/Con. Rod marked R71074; From Ser. No. 500,000
6	Cylinder Kit Complete	FP-RE48739	STD	w/Con. Rod marked R71074; To Ser. No. 499,999
6	Cyl. Liner Sealing Ring Kit	FP-AR98850		
QTY	PISTONS	PART NO.	SIZE	DESCRIPTION
6	Piston Body w/o Pin	FP-RE57512	STD	From Ser. No. 500,000
6	Piston Body w/o Pin	FP-RE50868	STD	To Ser. No. 499,999
6	Piston Kit w/Pin & Retainers	FP-RE57512WP	STD	From Ser. No. 500,000
6	Piston Kit w/Pin & Retainers	FP-RE50868WP	STD	To Ser. No. 499,999
6	Pin	FP-R57771		
12	Piston Pin Retainer	FP-E1343FN		
6	Pin Bushing	FP-R74008		w/Con. Rod marked R71074; 1.877" ID, 2.0622 OD, 1.8728" O.A.L.
QTY	CONNECTING RODS & BRGS.	PART NO.	SIZE	DESCRIPTION
12	Con. Rod Bolt	FP-R66452		w/Con. Rod marked R71074; Torque-To-Yield bolt; Replacement recommended
6	Rod Pair	FP-AR73277	STD	
6	Rod Pair	FP-AR73279	10	
6	Rod Pair	FP-AR73280	20	
6	Rod Pair	FP-AR73281	30	
QTY	PISTON RINGS	PART NO.	SIZE	DESCRIPTION
6	Ring Set Single Cylinder	FP-RE57517	STD	From Ser. No. 500,000

**KITS**

QTY	OVERHAUL KIT	PART NO.	SIZE	DESCRIPTION
1	In-Frame Overhaul Kit	FP-6076LIFK		w/Con. Rod marked R71074; From Ser. No. 500,000; Incl. Torque-To-Yield con. rod bolts
1	In-Frame Overhaul Kit	FP-6076EIFK		w/Con. Rod marked R71074; To Ser. No. 499,999; Incl. Torque-To-Yield con. rod bolts
1	Complete Overhaul Kit	FP-6076LOHK		w/Con. Rod marked R71074; From Ser. No. 500,000; Incl. Torque-To-Yield con. rod bolts
1	Complete Overhaul Kit	FP-6076EOHK		w/Con. Rod marked R71074; To Ser. No. 499,999; Incl. Torque-To-Yield con. rod bolts

**116 Grader 6076H, 6076T Eng. Loader 6076H, 6076T Engs. Wheel Tractor 6076A, 6076H, 6076T Engs. Excavator 6076H, 6076T Engs. Skidder 6076H, 6076T Engs.**  
7.6L 465.9 (7638cc) OHV Turbo-Diesel L6 (Litre Engine), 115mm Bore

**CYL. HEAD & PARTS**

QTY	GASKETS	PART NO.	SIZE	DESCRIPTION
1	Head Gasket	FP-RE47336		From Ser. No. 500,000

(continued on next page)



# John Deere Off Highway

**Grader 6076H, 6076T Eng. Loader 6076H, 6076T Engs. Wheel Tractor 6076A, 6076H, 116  
6076T Engs. Excavator 6076H, 6076T Engs. Skidder 6076H, 6076T Engs. (cont.)  
7.6L 465.9 (7638cc) OHV Turbo-Diesel L6 (Litre Engine), 115mm Bore**

<b>CYL. HEAD &amp; PARTS (cont.)</b>				
<b>QTY</b>	<b>GASKETS (cont.)</b>	<b>PART NO.</b>	<b>SIZE</b>	<b>DESCRIPTION</b>
1	Head Set	FP-RG22248		From Ser. No. 500,000
<b>QTY</b>	<b>HEAD BOLTS</b>	<b>PART NO.</b>	<b>SIZE</b>	<b>DESCRIPTION</b>
11	Head Bolt	FP-R88043		To Ser. No. 499,999; 5.250" length
8	Head Bolt	FP-R88044		To Ser. No. 499,999; 6.250" length
7	Head Bolt	FP-R88045		To Ser. No. 499,999; 7.250" length
<b>QTY</b>	<b>VALVE</b>	<b>PART NO.</b>	<b>SIZE</b>	<b>DESCRIPTION</b>
6	Intake	FP-R84618	STD	1 groove; Chrome plated stem; 2.0080" Head Dia., .3730" Stem Dia., 6.0600" O.A.L.
6	Intake	FP-R93308	3	1 groove; Chrome plated stem; 2.0080" Head Dia., .3760" Stem Dia., 6.0600" O.A.L.
6	Exhaust	FP-R84619	STD	1 groove; Chrome plated stem; 1.8500" Head Dia., .3720" Stem Dia., 6.1780" O.A.L.
6	Exhaust	FP-R93311	3	1 groove; Chrome plated stem; 1.8500" Head Dia., .3750" Stem Dia., 6.1780" O.A.L.
12	Valve Stem Cap	FP-T20129		
<b>QTY</b>	<b>VALVE SEAT</b>	<b>PART NO.</b>	<b>SIZE</b>	<b>DESCRIPTION</b>
6	Exh.	FP-R84976	STD	
6	Exh.	FP-R93349	10	
6	Int.	FP-R84977	STD	
6	Int.	FP-R93350	10	
<b>QTY</b>	<b>VALVE SPRING</b>	<b>PART NO.</b>	<b>SIZE</b>	<b>DESCRIPTION</b>
12	Spring	FP-R91822		
<b>QTY</b>	<b>VALVE MISC.</b>	<b>PART NO.</b>	<b>SIZE</b>	<b>DESCRIPTION</b>
12	Rotocap	FP-RE11410		Exh. & Int.
1	Oil Filler Cap Gasket	FP-T20328		Rocker arm cover codes 1101, 1103, 2904, 2908; Oil filler neck codes 1208, 6209
<b>ELECTRICAL</b>				
<b>QTY</b>	<b>ELECTRICAL</b>	<b>PART NO.</b>	<b>SIZE</b>	<b>DESCRIPTION</b>
1	Starter to Block Gasket	FP-R53108		3-Hole mount; Starting motor codes 3004, 3005, 3011, 3016
<b>QTY</b>	<b>ALTERNATOR</b>	<b>PART NO.</b>	<b>SIZE</b>	<b>DESCRIPTION</b>
1	Ball Brg.	FP-JD9449		Front; Delco-Remy components; Code 3132; 24 Volt, 40 amp alternator
1	Ball Brg.	FP-JD9449		Front; Nippondenso components; Code 3137; 12 Volt, 70 amp alternator
1	Ball Brg.	FP-JD9449		Front; Nippondenso components; Code 3143; 12 Volt, 90 amp Poly-Vee alternator
2	Ball Brg.	FP-JD9449		Front & Rear; Delco-Remy No. 1101345; Code 3114; 12 Volt, 78 amp alternator
2	Ball Brg.	FP-JD9449		Front & Rear; Motorola No. 70D42179T02; 24 Volt, 45 amp alternator
<b>METERS</b>				
<b>QTY</b>	<b>METERS</b>	<b>PART NO.</b>	<b>SIZE</b>	<b>DESCRIPTION</b>
1	O-Ring	FP-R79915		Tach sensor seal to cover; Codes 4402, 4420
<b>INT &amp; EXH MANIFOLDS</b>				
<b>QTY</b>	<b>INT. &amp; EXH. MANIFOLDS</b>	<b>PART NO.</b>	<b>SIZE</b>	<b>DESCRIPTION</b>
2	Exhaust Manifold Gasket	FP-R83021		One Exh. hole
2	Exhaust Manifold Gasket	FP-R83020		Two Exh. holes
3	Intake Manifold Gasket	FP-R130573		w/Int. manifolds R108608, R127872, R132293
3	Intake Manifold Gasket	FP-R130573		w/Int. manifolds R89791, R91466, R112707
3	Intake Manifold Gasket	FP-R130573		From Ser. No. 500,000; w/Int. manifolds R89790, R115393, R130718, R131473, R131651, R131657, R132290, R134429
3	Intake Manifold Gasket	FP-R130573		To Ser. No. 499,999; w/Int. manifold R89790
<b>CAMSHAFT GROUP</b>				
<b>QTY</b>	<b>TIMING COVER</b>	<b>PART NO.</b>	<b>SIZE</b>	<b>DESCRIPTION</b>
1	Crankshaft Front Cover Gasket	FP-R26058		
1	Timing Gear Cover Gasket	FP-R50390		Access cover
1	Timing Gear Cover Gasket	FP-R99464		From Ser. No. 500,000
1	Timing Gear Cover Gasket	FP-R71314		To Ser. No. 499,999
1	Timing Gear Cover Gasket	FP-R93346		To Ser. No. 499,999; Use w/cover R109662
<b>QTY</b>	<b>CAMSHAFT/LIFTER</b>	<b>PART NO.</b>	<b>SIZE</b>	<b>DESCRIPTION</b>
1	Camshaft Plug	FP-R82007		

(continued on next page)

**116** Grader 6076H, 6076T Eng. Loader 6076H, 6076T Engs. Wheel Tractor 6076A, 6076H, (cont.) 6076T Engs. Excavator 6076H, 6076T Engs. Skidder 6076H, 6076T Engs.  
7.6L 465.9 (7638cc) OHV Turbo-Diesel L6 (Litre Engine), 115mm Bore

FUEL SYSTEM & PARTS				
QTY	FUEL INJECTION	PART NO.	SIZE	DESCRIPTION
1	Washer	FP-R53899		Control valve to pump housing seal; Pump housing codes 1610, 1616, 1626, 1640, 1641, 1650, 1654; Fuel filter codes 3502, 3503, 3511, 3513
1	Washer	FP-R53901		6076A Engs.; Control valve seal to housing; Pump housing codes 1601, 1637, 1650, 1688, 1689; Filter & line codes 3512, 3521
1	Washer	FP-R53901		6076T Engs.; Control valve seal to housing; Pump housing codes 1652, 1652, 1680; Filter & line codes 3512, 3521
6	Washer	FP-R84472		Injector nozzle; 6076A Engs.; Nozzle codes 1601, 1617, 1637, 1686, 1688, 1689; .290" X .715" X .079"
6	Washer	FP-R84472		Injector nozzle; 6076T Engs.; Nozzle codes 1652, 1683; .290" X .715" X .079"
6	Fuel Injector Nut	FP-R79604		6076A Engs.; Inj. pump; Line codes 1601, 1604, 1623, 1637, 1644, 1652, 1667, 1680, 1683, 1686, 1688
13	Washer Type Seal	FP-R51936		Electric fuel shut-off
13	Washer Type Seal	FP-R51936		Leak-off & return line seals; Nozzle codes 1601, 1604, 1611, 1612, 1613, 1615, 1616, 1617, 1622, 1623, 1625, 1626, 1637, 1640, 1641, 1644, 1650, 1652, 1654, 1655, 1656, 1657, 1667, 1676, 1678, 1680, 1683, 1686, 1688, 1689
13	Washer Type Seal	FP-R51936		L.H. & R.H.; Aux. drive line seals
QTY	FUEL FILTERS & PUMP	PART NO.	SIZE	DESCRIPTION
6	O-Ring	FP-R77551		Leak-off fitting to nozzle; Nozzle codes 1601, 1610, 1611, 1612, 1613, 1615, 1616, 1617, 1626, 1637, 1640, 1641, 1644, 1650, 1654, 1667, 1676, 1678, 1684, 1686, 1688, 1689; Viton®
6	O-Ring	FP-R51603		Fuel nozzle; 6076A Engs.; Injector nozzle codes 1611, 1644, 1655; w/Bosch injector
QTY	TURBOCHARGER	PART NO.	SIZE	DESCRIPTION
1	Turbocharger Oil Drain Gasket	FP-R105346		w/Turbo oil line codes 6501, 6502, 6504, 6505, 6506, 6510
1	Turbocharger Mounting Gasket	FP-R89879		
1	O-Ring	FP-R57517		6076A Engs.; Manifold to turbo coupling seal; Int. manifold code 1707
1	O-Ring	FP-R86743		Inner coupling; Manifold code 1707
1	O-Ring	FP-R86743		Outer coupling; Manifold codes 1706, 1709, 1710, 1726, 1731, 1737, 1738
1	O-Ring	FP-R86743		Outer coupling; Manifold codes 1726, 1730; Rear mount turbo code 4307
1	Sealing Ring	FP-R100911		6076A Engs.; Cooler inlet/outlet gskt.
1	Turbo Exhaust Int. Cover Gskt	FP-R92097		6076T Engs.; Rear mounted turbocharger
COOLING SYSTEM				
QTY	WATER PUMP	PART NO.	SIZE	DESCRIPTION
1	Water Pump Shaft	FP-R70965		Water pump codes 2014, 2032; w/Pump marked R83561; Gear driven pump
1	Water Pump Impeller	FP-R71225		Pump codes 2014, 2032; w/Pump housing marked R83561
1	Water Pump Repair/Rebuild Kit	FP-RE69847		w/Pump housing marked R83561; Gear driven pump
2	Ball Brg.	FP-JD10329		Fan hub shaft bearing
1	Ball Brg.	FP-JD10363		Gear driven front bearing; Water pump codes 2014, 2032; w/Pump housing marked R83561
1	Ball Brg.	FP-JD10362		Gear driven rear bearing; Water pump codes 2014, 2032; w/Pump housing marked R83561
1	Water Pump Gasket	FP-R96616		w/Pump cover R96606, R133310; From Ser. No. 500,000
1	Water Pump Housing Gasket	FP-R100367		w/Pump housing marked RE39121, RE68230; w/Raised letter "X"; From Ser. No. 500,000
1	Water Pump Mounting Gasket	FP-R71315		w/Pump housing marked R83561; To Ser. No. 499,999
1	Water Pump Mounting Gasket	FP-R71315		w/Pump housing marked R85677
1	Water Pump Inlet Gasket	FP-R71361		w/Pump housing marked R83561; To Ser. No. 499,999
1	Oil Seal	FP-RE20768		Fan hub shaft seal; For gear driven water pump
1	Oil Seal	FP-RE39134		Water pump codes 2014, 2032; w/Pump housing marked R83561
3	O-Ring	FP-R72328		Water tube to thermostat housing seal; Water pump code 2030; Thermostat housing code 3905
1	O-Ring	FP-R101042		Housing to cover; Water pump codes 2030, 2039; w/Gear driven pump
1	O-Ring	FP-R71596		Pump cover; w/Pump housing marked R83561; Water pump code 2014
2	O-Ring	FP-R47153		Water pump tube
1	Water Pump Hub	FP-JD10058		w/Fan Hub bearing codes 2317, 2318, 2320, 2324, 2327, 2328, 2329, 2330, 2331, 2332, 2334, 2335, 2336, 2338, 2339, 2340

(continued on next page)



# John Deere Off Highway

**Grader 6076H, 6076T Eng. Loader 6076H, 6076T Engs. Wheel Tractor 6076A, 6076H, 116  
6076T Engs. Excavator 6076H, 6076T Engs. Skidder 6076H, 6076T Engs. (cont.)  
7.6L 465.9 (7638cc) OHV Turbo-Diesel L6 (Litre Engine), 115mm Bore**

<b>COOLING SYSTEM (cont.)</b>				
<b>QTY</b>	<b>WATER PUMP (cont.)</b>	<b>PART NO.</b>	<b>SIZE</b>	<b>DESCRIPTION</b>
1	Water Pump Filter	FP-R98527		Water pump codes 2014, 2032; w/Pump housing marked R83561; From Ser. No. 101,935
<b>QTY</b>	<b>THERMOSTAT</b>	<b>PART NO.</b>	<b>SIZE</b>	<b>DESCRIPTION</b>
2	Thermostat	FP-AR72852		Thermostat code 2202; 192 Deg.
2	Thermostat	FP-AR48675		Thermostat code 2204; 180 Deg.
1	Thermostat Cover Gasket	FP-R46479		Thermostat cover codes 2102, 2114, 2204, 3904, 3912; Two hole
1	Therm. Hsg. - Water Mfld. Gsk	FP-R86062		Thermostat housing to cyl. head
2	O-Ring	FP-R47153		Thermostat; Water manifold codes 3904, 3912
<b>QTY</b>	<b>MISCELLANEOUS</b>	<b>PART NO.</b>	<b>SIZE</b>	<b>DESCRIPTION</b>
1	Water Line Gasket	FP-R97346		To Ser. No. 100,770
2	Water Manifold Mounting Gskt.	FP-R88397		
<b>ENGINE BLOCK &amp; PARTS</b>				
<b>QTY</b>	<b>GASKETS</b>	<b>PART NO.</b>	<b>SIZE</b>	<b>DESCRIPTION</b>
1	Front Cover Gasket	FP-R125670		Aux. drive L.H. rear cover gskt.
1	Front Cover Gasket	FP-R104623		From Ser. No. 500,000
1	Front Cover Gasket	FP-R122143		Timing gear cover gskt.; To Ser. No. 499,999
1	Oil Pan Gasket	FP-R71918		
1	Oil Pan Gasket	FP-R49377		w/Alum. pan; Oil pan code 1909
1	Oil Pan Gasket	FP-R49377		6076A Engs.; w/Alum. pan; Oil pan codes 1906, 1908, 1916, 1922, 1953, 1954
1	Oil Pan Gasket Set	FP-PG400PS		6076A Engs.; To Ser. No. 499,999; w/Cast iron oil pan
1	Oil Pan Gasket Set	FP-PG401PS		6076T Engs.; From Ser. No. 180,071; w/Cast iron oil pan & rear sump
2	O-Ring	FP-U13639		Block coolant drain plug seal; Coolant heater codes 2601, 2602; 1.475" X .118"
<b>QTY</b>	<b>GASKET SETS</b>	<b>PART NO.</b>	<b>SIZE</b>	<b>DESCRIPTION</b>
1	In-Frame Gasket Set	FP-PG6076LS		From Ser. No. 500,000
1	In-Frame Gasket Set	FP-PG6076ES		To Ser. No. 499,999
1	Complete Overhaul Gasket Set	FP-RE64206		From Ser. No. 500,000; Crankshaft seals not incl.
1	Complete Overhaul Gasket Set	FP-RE64206WS		From Ser. No. 500,000; Incl. Crankshaft seals
1	Complete Overhaul Gasket Set	FP-RE35647		To Ser. No. 499,999; Crankshaft seals not incl.
1	Complete Overhaul Gasket Set	FP-RE35647WS		To Ser. No. 499,999; Incl. Crankshaft seals
<b>QTY</b>	<b>CAM BEARINGS</b>	<b>PART NO.</b>	<b>SIZE</b>	<b>DESCRIPTION</b>
1	Cam Brg.	FP-R87561		
<b>QTY</b>	<b>OIL COOLERS &amp; FILTERS</b>	<b>PART NO.</b>	<b>SIZE</b>	<b>DESCRIPTION</b>
1	Aftercooler Gasket Set	FP-6076A		6076A Engs.; To Ser. No. 100,770; w/housing No. R50398
1	Aftercooler Gasket Set	FP-6076ADP		6076A Engs.; Use w/housing Nos. R90995, R93918, R110232
2	Aftercooler Gasket	FP-R97347		6076A Engs.
2	Aftercooler Gasket	FP-R88993		6076A Engs.; From Ser. No. 100,177
1	Oil Cooler	FP-AT25038		
1	O-Ring	FP-R52811		6076A Engs.; Intercooler inlet & outlet tube seals; Int. manifold code 1726; To Ser. No. 100,770
4	O-Ring	FP-R47153		Cooler tube
2	O-Ring	FP-R47153		Oil filter tube; Oil filter code 5931
1	Oil Cooler Bypass Gasket	FP-R65055		
1	Oil Cooler Cover Gasket	FP-R128558		From Ser. No. 500,000
1	Oil Cooler Cover Gasket	FP-R50419		To Ser. No. 499,999
1	Oil Cooler Housing Cover Gskt	FP-R128557		From Ser. No. 500,000
<b>CRANKSHAFT/OIL PUMP</b>				
<b>QTY</b>	<b>CRANKSHAFT</b>	<b>PART NO.</b>	<b>SIZE</b>	<b>DESCRIPTION</b>
1	Crankshaft	FP-RE53422		Gears incl.; Short snout 3.000"
1	Crankshaft	FP-AR96189		Gears not incl.
1	Oil Seal Kit	FP-SK49025		Incl. front & rear seals
<b>QTY</b>	<b>SEALS - FRONT CRANK</b>	<b>PART NO.</b>	<b>SIZE</b>	<b>DESCRIPTION</b>
1	Oil Seal Kit	FP-AR49025		
<b>QTY</b>	<b>SEALS - REAR CRANK</b>	<b>PART NO.</b>	<b>SIZE</b>	<b>DESCRIPTION</b>
1	Oil Seal	FP-RE22764		PTFE
<b>QTY</b>	<b>MAIN BEARINGS</b>	<b>PART NO.</b>	<b>SIZE</b>	<b>DESCRIPTION</b>
1	Main Set	FP-MBK400L4	STD	w/5 main brgs.
1	Main Set	FP-MBK400L410	10	w/5 main brgs.
1	Main Set	FP-MBK400L420	20	w/5 main brgs.
1	Main Set	FP-MBK400L6	STD	w/7 main brgs.
1	Main Set	FP-MBK400L610	10	w/7 main brgs.

(continued on next page)

**116** Grader 6076H, 6076T Eng. Loader 6076H, 6076T Engs. Wheel Tractor 6076A, 6076H, (cont.) 6076T Engs. Excavator 6076H, 6076T Engs. Skidder 6076H, 6076T Engs.  
7.6L 465.9 (7638cc) OHV Turbo-Diesel L6 (Litre Engine), 115mm Bore

### CRANKSHAFT/OIL PUMP (cont.)

QTY	MAIN BEARINGS (cont.)	PART NO.	SIZE	DESCRIPTION
1	Main Set	FP-MBK400L620	20	w/7 main brgs.
1	Main Set	FP-MBK400L630	30	w/7 main brgs.
5	Plain Main Brg.	FP-AR74814	STD	
5	Plain Main Brg.	FP-AR74816	10	
5	Plain Main Brg.	FP-AR74817	20	
5	Plain Main Brg.	FP-AR74818	30	
1	Flanged Main Brg.	FP-AR77748	STD	
1	Flanged Main Brg.	FP-AR77750	10	
1	Flanged Main Brg.	FP-AR77751	20	
1	Flanged Main Brg.	FP-AR77752	30	
1	Thrust Washer Set	FP-AR77747	STD	

QTY	OIL PUMP	PART NO.	SIZE	DESCRIPTION
3	O-Ring	FP-U17409		Oil cooler relief valve plug seal; Filter & housing codes 5919, 5931
4	O-Ring	FP-R71732		Pump by-pass tubes; Pump codes 5001, 5003, 5004; w/Pump marked R62946, R124328
1	O-Ring	FP-R50405		Intake coupling; Large end; Int. manifold code 1735
1	Rect. or Square Seal	FP-R43660		Filter to housing; Filter & body code 5919; w/housing marked R120412
1	Oil Pump Intake Elbow Gasket	FP-R71312		w/Rear deep sump; Oil pump code 5003; Oil pan code 1906
1	Oil Filter to Block Gasket	FP-R43774		Filter housing code 5931

### CYLINDER COMPONENTS

QTY	LINERS	PART NO.	SIZE	DESCRIPTION
6	Liner w/o Sealing Ring	FP-R87858		
6	Liner w/Sealing Rings	FP-R87858WS		
6	Cylinder Kit Complete	FP-RE60294	STD	w/Con. Rod marked R71074; From Ser. No. 500,000
6	Cylinder Kit Complete	FP-RE48739	STD	w/Con. Rod marked R71074; To Ser. No. 499,999
6	Cyl. Liner Sealing Ring Kit	FP-AR98850		

QTY	PISTONS	PART NO.	SIZE	DESCRIPTION
6	Piston Body w/o Pin	FP-RE57512	STD	From Ser. No. 500,000
6	Piston Body w/o Pin	FP-RE50868	STD	To Ser. No. 499,999
6	Piston Kit w/Pin & Retainers	FP-RE57512WP	STD	From Ser. No. 500,000
6	Piston Kit w/Pin & Retainers	FP-RE50868WP	STD	To Ser. No. 499,999
6	Pin	FP-R57771		
12	Piston Pin Retainer	FP-E1343FN		
6	Pin Bushing	FP-R74008		w/Con. Rod marked R71074; 1.877" ID, 2.0622 OD, 1.8728" O.A.L.

QTY	CONNECTING RODS & BRGS.	PART NO.	SIZE	DESCRIPTION
12	Con. Rod Bolt	FP-R66452		w/Con. Rod marked R71074; Torque-To-Yield bolt; Replacement recommended
6	Rod Pair	FP-AR73277	STD	
6	Rod Pair	FP-AR73279	10	
6	Rod Pair	FP-AR73280	20	
6	Rod Pair	FP-AR73281	30	

QTY	PISTON RINGS	PART NO.	SIZE	DESCRIPTION
6	Ring Set Single Cylinder	FP-RE57517	STD	From Ser. No. 193,861
6	Ring Set Single Cylinder	FP-RE48380	STD	To Ser. No. 193,860; 2-5/32, 1-3/16 (1 cyl. set)

### KITS

QTY	OVERHAUL KIT	PART NO.	SIZE	DESCRIPTION
1	In-Frame Overhaul Kit	FP-6076LIFK		w/Con. Rod marked R71074; From Ser. No. 500,000; Incl. Torque-To-Yield con. rod bolts
1	In-Frame Overhaul Kit	FP-6076EIFK		w/Con. Rod marked R71074; To Ser. No. 499,999; Incl. Torque-To-Yield con. rod bolts
1	Complete Overhaul Kit	FP-6076LOHK		w/Con. Rod marked R71074; From Ser. No. 500,000; Incl. Torque-To-Yield con. rod bolts
1	Complete Overhaul Kit	FP-6076EOHK		w/Con. Rod marked R71074; To Ser. No. 499,999; Incl. Torque-To-Yield con. rod bolts





# John Deere Off Highway

Power Unit 6081HN PowerTech Eng. (Natural Gas). Wheel Tractor 6081HN PowerTech 117 Eng. (Natural Gas). 8.1L 495.9 (8129cc) OHV Turbo-NG L6 (PowerTech 2V IC), 116mm Bore				
<b>CYL. HEAD &amp; PARTS</b>				
<b>QTY</b>	<b>GASKETS</b>	<b>PART NO.</b>	<b>SIZE</b>	<b>DESCRIPTION</b>
1	Head Gasket	FP-RE55475		
1	Head Set	FP-RE57186		
<b>QTY</b>	<b>VALVE</b>	<b>PART NO.</b>	<b>SIZE</b>	<b>DESCRIPTION</b>
12	Valve Stem Cap	FP-T20129		Exh. & Int.
24	Keeper	FP-T20077		1 groove; Square cut key groove; Hardened
<b>QTY</b>	<b>VALVE MISC.</b>	<b>PART NO.</b>	<b>SIZE</b>	<b>DESCRIPTION</b>
12	Rotocap	FP-RE11410		Exh. & Int.
1	Oil Filler Cap Gasket	FP-R80135		Cover code 5205; L.H. Auxiliary drive
1	Oil Filler Cap Gasket	FP-T20328		Rocker arm cover codes 1105, 2912
<b>CAMSHAFT GROUP</b>				
<b>QTY</b>	<b>TIMING COVER</b>	<b>PART NO.</b>	<b>SIZE</b>	<b>DESCRIPTION</b>
1	Crankshaft Front Cover Gasket	FP-R26058		Rear
1	Timing Gear Cover Gasket	FP-R50390		Access cover
<b>FUEL SYSTEM &amp; PARTS</b>				
<b>QTY</b>	<b>TURBOCHARGER</b>	<b>PART NO.</b>	<b>SIZE</b>	<b>DESCRIPTION</b>
1	Turbocharger Oil Drain Gasket	FP-R105346		w/Turbo oil line codes 6501, 6502, 6504, 6505, 6506, 6507, 6508, 6510, 6511, 6512, 6513, 6529, 6530, 6531
1	Turbocharger Mounting Gasket	FP-R89879		
<b>COOLING SYSTEM</b>				
<b>QTY</b>	<b>WATER PUMP</b>	<b>PART NO.</b>	<b>SIZE</b>	<b>DESCRIPTION</b>
1	Water Pump Gasket	FP-R119383		Pump codes 2015, 5701; w/Pump housing marked R119795
1	Oil Seal	FP-RE39134		Water pump codes 2015, 5701; w/Pump housing marked R119795
1	Water Pump Filter	FP-R98527		w/Pump housing marked R119795
<b>QTY</b>	<b>THERMOSTAT</b>	<b>PART NO.</b>	<b>SIZE</b>	<b>DESCRIPTION</b>
2	Thermostat	FP-AR72852		Water manifold & thermostat codes 2114, 2202, 3901; 192 Deg.
1	Thermostat Gasket	FP-R124211		Water manifold & thermostat codes 2114, 2202, 3901
<b>QTY</b>	<b>MISCELLANEOUS</b>	<b>PART NO.</b>	<b>SIZE</b>	<b>DESCRIPTION</b>
2	Water Manifold Mounting Gskt.	FP-R88397		Water manifold & thermostat codes 2114, 2202, 3901
<b>ENGINE BLOCK &amp; PARTS</b>				
<b>QTY</b>	<b>GASKETS</b>	<b>PART NO.</b>	<b>SIZE</b>	<b>DESCRIPTION</b>
1	Front Cover Gasket	FP-R119384		Timing gear & front seal codes 6201, 7701
1	Oil Pan Gasket	FP-R49377		w/Alum. oil pan w/shallow sump; Oil pan code 1901
1	O-Ring	FP-U13639		Block coolant drain plug seal; Coolant heater code 2601; 1.475" X .118"
1	O-Ring	FP-R71596		Timing gear & front seal codes 6201, 7701; Plate seal
<b>QTY</b>	<b>GASKET SETS</b>	<b>PART NO.</b>	<b>SIZE</b>	<b>DESCRIPTION</b>
1	Complete Overhaul Gasket Set	FP-RE57187		Crankshaft seals not incl.
<b>QTY</b>	<b>CAM BEARINGS</b>	<b>PART NO.</b>	<b>SIZE</b>	<b>DESCRIPTION</b>
4	Cam Brg.	FP-R87561		
<b>QTY</b>	<b>OIL COOLERS &amp; FILTERS</b>	<b>PART NO.</b>	<b>SIZE</b>	<b>DESCRIPTION</b>
1	Oil Cooler	FP-AR55394		Oil cooler code 5901
1	Oil Cooler Bypass Gasket	FP-R109625		Adapter
1	Oil Cooler Housing Gasket	FP-AR58952		Oil cooler code 5901
2	Oil Cooler Adapter Gasket Set	FP-R50424		Oil cooler code 5901
<b>CRANKSHAFT/OIL PUMP</b>				
<b>QTY</b>	<b>CRANKSHAFT</b>	<b>PART NO.</b>	<b>SIZE</b>	<b>DESCRIPTION</b>
1	Oil Seal Kit	FP-SK49025		Incl. front & rear seals
<b>QTY</b>	<b>SEALS - FRONT CRANK</b>	<b>PART NO.</b>	<b>SIZE</b>	<b>DESCRIPTION</b>
1	Oil Seal Kit	FP-AR49025		Timing gear & front seal codes 6201, 7701
<b>QTY</b>	<b>SEALS - REAR CRANK</b>	<b>PART NO.</b>	<b>SIZE</b>	<b>DESCRIPTION</b>
1	Oil Seal	FP-RE22764		PTFE
<b>QTY</b>	<b>MAIN BEARINGS</b>	<b>PART NO.</b>	<b>SIZE</b>	<b>DESCRIPTION</b>
6	Plain Main Brg.	FP-RE529319	STD	
1	Flanged Main Brg.	FP-RE529320	STD	
<b>QTY</b>	<b>OIL PUMP</b>	<b>PART NO.</b>	<b>SIZE</b>	<b>DESCRIPTION</b>
4	O-Ring	FP-R71732		Oil cooler bypass tube seals
2	O-Ring	FP-U17409		Oil cooler relief valve plug seal; Filter & housing code 5901
1	O-Ring	FP-R72328		Rocker arm cover code 1110; Vent tube elbow seal

(continued on next page)

**117** *Power Unit 6081HN PowerTech Eng. (Natural Gas). Wheel Tractor 6081HN PowerTech Eng. (Natural Gas).*  
 8.1L 495.9 (8129cc) OHV Turbo-NG L6 (PowerTech 2V IC), 116mm Bore

### CRANKSHAFT/OIL PUMP (cont.)

QTY	OIL PUMP (cont.)	PART NO.	SIZE	DESCRIPTION
4	O-Ring	FP-R47153		Tube seal; Filter & housing code 5901
2	O-Ring	FP-R71732		Tube seal; Pump code 5002
1	Rect. or Square Seal	FP-R43660		Filter seal; Filter & housing code 5901
1	Oil Filter Seal Ring	FP-R26163		Turbocharger elbow seal
1	Oil Filter Base Gasket	FP-R119847		Filter & housing code 5901

### CYLINDER COMPONENTS

QTY	LINERS	PART NO.	SIZE	DESCRIPTION
6	Cyl. Liner Sealing Ring Kit	FP-AR98850		
QTY	PISTONS	PART NO.	SIZE	DESCRIPTION
6	Pin	FP-R57771		
12	Piston Pin Retainer	FP-E1343FN		
6	Pin Bushing	FP-R74008		1.877" ID, 2.0622 OD, 1.8728" O.A.L.
QTY	CONNECTING RODS & BRGS.	PART NO.	SIZE	DESCRIPTION
12	Con. Rod Bolt	FP-R66452		w/Con. Rod marked R116340; Torque-To-Yield bolt; Replacement recommended
6	Rod Bearing Half Upper/Lower	FP-R525767	STD	

**118** *Off-Highway Truck 6081H PowerTech Eng. (2-Valve Cyl. Head). Combine 6081H PowerTech Eng. (2-Valve Cyl. Head). Cotton Picker 6081H PowerTech Eng. (2-Valve Cyl. Head). Harvester 6081H PowerTech Eng. (2-Valve Cyl. Head). Grader 6081H PowerTech Eng. (2-Valve Cyl. Head). Power Unit 6081H PowerTech Eng. (2-Valve Cyl. Head). Scraper 6081H PowerTech Eng. (2-Valve Cyl. Head). Wheel Tractor 6081H PowerTech Eng. (2-Valve Cyl. Head). Crawler Tractor 6081H PowerTech Eng. (2-Valve Cyl. Head). Loader Tractor 6081H PowerTech Eng. (2-Valve Cyl. Head). Forestry Tractor 6081H PowerTech Eng. (2-Valve Cyl. Head). Excavator 6081H PowerTech Eng. (2-Valve Cyl. Head). Skidder 6081H PowerTech Eng. (2-Valve Cyl. Head). Logger 6081H PowerTech Eng. (2-Valve Cyl. Head). Feller Buncher 6081H PowerTech Eng. (2-Valve Cyl. Head). Forage Harvester 6081H PowerTech Eng. (2-Valve Cyl. Head).*  
 8.1L 495.9 (8129cc) OHV Turbo-Diesel L6 (PowerTech 2V IC), 116mm Bore

### CYL. HEAD & PARTS

QTY	GASKETS	PART NO.	SIZE	DESCRIPTION
1	Valve Cover Gasket	FP-R49866		Rocker cover codes 1102, 1105, 2912
1	Head Gasket	FP-RE55475		
1	Head Set	FP-RE57186		
QTY	VALVE	PART NO.	SIZE	DESCRIPTION
6	Intake	FP-R84618	STD	1 groove; Chrome plated stem; 2.0080" Head Dia., .3730" Stem Dia., 6.0600" O.A.L.
6	Intake	FP-R93308	3	1 groove; Chrome plated stem; 2.0080" Head Dia., .3760" Stem Dia., 6.0600" O.A.L.
6	Exhaust	FP-R84619	STD	1 groove; Chrome plated stem; 1.8500" Head Dia., .3720" Stem Dia., 6.1780" O.A.L.
6	Exhaust	FP-R93311	3	1 groove; Chrome plated stem; 1.8500" Head Dia., .3750" Stem Dia., 6.1780" O.A.L.
12	Valve Stem Cap	FP-T20129		Exh. & Int.
24	Keeper	FP-T20077		Exh. & Int.; 1 groove; Square cut key groove; Hardened
QTY	VALVE SEAT	PART NO.	SIZE	DESCRIPTION
6	Exh.	FP-R119132	STD	
6	Exh.	FP-R93349	10	
6	Int.	FP-R121193	STD	
6	Int.	FP-R93350	10	
QTY	VALVE SPRING	PART NO.	SIZE	DESCRIPTION
12	Spring	FP-R91822		Exh. & Int.
QTY	VALVE MISC.	PART NO.	SIZE	DESCRIPTION
12	Rotocap	FP-RE11410		Exh. & Int.
1	Oil Filler Cap Gasket	FP-T20328		Rocker arm cover codes 1105, 2912

### ELECTRICAL

QTY	ALTERNATOR	PART NO.	SIZE	DESCRIPTION
1	Ball Brg.	FP-JD9449		Front; Code 3143; 12 Volt, 90 amp alternator; Poly-Vee fan drive

(continued on next page)



# John Deere Off Highway

<p align="center"><i>Off-Highway Truck 6081H PowerTech Eng. (2-Valve Cyl. Head). Combine 6081H 118</i>  <b>PowerTech Eng. (2-Valve Cyl. Head). Cotton Picker 6081H PowerTech Eng. (2-Valve Cyl. (cont.)</b>  <b>Head). Harvester 6081H PowerTech Eng. (2-Valve Cyl. Head). Grader 6081H PowerTech</b>  <b>Eng. (2-Valve Cyl. Head). Power Unit 6081H PowerTech Eng. (2-Valve Cyl. Head). Scraper</b>  <b>6081H PowerTech Eng. (2-Valve Cyl. Head). Wheel Tractor 6081H PowerTech Eng.</b>  <b>(2-Valve Cyl. Head). Crawler Tractor 6081H PowerTech Eng. (2-Valve Cyl. Head). Loader</b>  <b>Tractor 6081H PowerTech Eng. (2-Valve Cyl. Head). Forestry Tractor 6081H PowerTech</b>  <b>Eng. (2-Valve Cyl. Head). Excavator 6081H PowerTech Eng. (2-Valve Cyl. Head). Skidder</b>  <b>6081H PowerTech Eng. (2-Valve Cyl. Head). Logger 6081H PowerTech Eng. (2-Valve Cyl.</b>  <b>Head). Feller Buncher 6081H PowerTech Eng. (2-Valve Cyl. Head). Forage Harvester</b>  <b>6081H PowerTech Eng. (2-Valve Cyl. Head).</b></p> <p align="center">8.1L 495.9 (8129cc) OHV Turbo-Diesel L6 (PowerTech 2V IC), 116mm Bore</p>				
<b>INT &amp; EXH MANIFOLDS</b>				
<b>QTY</b>	<b>INT. &amp; EXH. MANIFOLDS</b>	<b>PART NO.</b>	<b>SIZE</b>	<b>DESCRIPTION</b>
2	Exhaust Manifold Gasket	FP-R83020		Codes 2802, 3830; w/two holes; Two Exh. holes
2	Exhaust Manifold Gasket	FP-R83021		Codes 2802, 3830; One Exh. hole
3	Intake Manifold Gasket	FP-R130573		w/Int. manifolds R127427, R131652
<b>CAMSHAFT GROUP</b>				
<b>QTY</b>	<b>TIMING COVER</b>	<b>PART NO.</b>	<b>SIZE</b>	<b>DESCRIPTION</b>
1	Crankshaft Front Cover Gasket	FP-R26058		Housing to block gskt.
<b>QTY</b>	<b>CAMSHAFT/LIFTER</b>	<b>PART NO.</b>	<b>SIZE</b>	<b>DESCRIPTION</b>
1	Camshaft Plug	FP-R82007		
<b>FUEL SYSTEM &amp; PARTS</b>				
<b>QTY</b>	<b>FUEL INJECTION</b>	<b>PART NO.</b>	<b>SIZE</b>	<b>DESCRIPTION</b>
1	Washer	FP-R53899		Control valve to pump housing seal; Inj. pump housing connector codes 1616, 1621, 1632, 1633, 1634, 1635, 1636, 1641, 1655, 1657, 1658, 1659
2	Washer	FP-R53901		Fuel inj. pump connector seal; Filter & line codes 1603, 1604, 1605, 1607, 1608, 1609, 1610, 1611, 1612, 1613, 1615, 1617, 1618, 1619, 1620, 1622, 1623, 1624, 1640, 1656, 1676; w/Bosch pump
6	Washer	FP-R84472		Injector nozzle; Nozzle codes 1601, 1602, 1603, 1604, 1605, 1606, 1607, 1608, 1609, 1613, 1615, 1620, 1621, 1622, 1624, 1630, 1632, 1633, 1635, 1639, 1642, 1648, 1651, 1655, 1657, 1659, 1661, 1662, 1663, 1676; .290" X .715" X .079"
6	Fuel Injector Nut	FP-R79604		Injector line codes 1601, 1602
13	Washer Type Seal	FP-R51936		Fuel line; Line codes 1601, 1602, 1603, 1604, 1605, 1606, 1608, 1610, 1611, 1612, 1616, 1617, 1618, 1619, 1632, 1634, 1636, 1640, 1641, 1643, 1644, 1645, 1646, 1647, 1648, 1649, 1650, 1656, 1661, 1662, 1663, 1667
<b>QTY</b>	<b>TURBOCHARGER</b>	<b>PART NO.</b>	<b>SIZE</b>	<b>DESCRIPTION</b>
1	Turbocharger Oil Drain Gasket	FP-R105346		w/Turbo oil line codes 6501, 6503, 6504, 6505, 6506, 6507, 6508, 6510, 6511, 6512, 6513, 6529, 6530, 6531
1	Turbocharger Mounting Gasket	FP-R89879		
1	O-Ring	FP-R86743		Outer coupling
1	Turbo Exhaust Int. Cover Gskt	FP-R92097		Turbo code 6514
<b>COOLING SYSTEM</b>				
<b>QTY</b>	<b>WATER PUMP</b>	<b>PART NO.</b>	<b>SIZE</b>	<b>DESCRIPTION</b>
2	Ball Brg.	FP-JD10329		Fan hub shaft bearing
1	Water Pump Gasket	FP-R119383		w/Pump housing marked R119795; w/15 tooth gear; High flow
1	Water Pump Gasket	FP-R119383		w/Pump housing marked R119795; w/16 tooth gear; Low flow
1	Oil Seal	FP-RE39134		Water pump codes 2001, 2004; w/Pump housing marked R119795
1	Water Pump Hub	FP-JD10058		w/Fan Hub bearing codes 2305, 2306, 2335, 2336, 2337, 2338, 2339
1	Water Pump Filter	FP-R98527		w/Pump housing marked R119795
<b>QTY</b>	<b>THERMOSTAT</b>	<b>PART NO.</b>	<b>SIZE</b>	<b>DESCRIPTION</b>
2	Thermostat	FP-AR48675		Thermostat code 2204; 180 Deg.
1	Thermostat Gasket	FP-R124211		Thermostat housing to cyl. head
1	Thermostat Cover Gasket	FP-R46479		Thermostat cover codes 2102, 2114; Two hole
1	Therm. Hsg. - Water Mfld. Gsk	FP-R86062		Housing to cyl. head
<b>QTY</b>	<b>MISCELLANEOUS</b>	<b>PART NO.</b>	<b>SIZE</b>	<b>DESCRIPTION</b>
2	Water Manifold Mounting Gskt.	FP-R88397		
<b>ENGINE BLOCK &amp; PARTS</b>				
<b>QTY</b>	<b>GASKETS</b>	<b>PART NO.</b>	<b>SIZE</b>	<b>DESCRIPTION</b>
1	Front Cover Gasket	FP-R125670		Air compressor to timing cover; Midland or Holset

(continued on next page)

**118** *Off-Highway Truck 6081H PowerTech Eng. (2-Valve Cyl. Head). Combine 6081H PowerTech Eng. (2-Valve Cyl. Head). Cotton Picker 6081H PowerTech Eng. (2-Valve Cyl. Head). Harvester 6081H PowerTech Eng. (2-Valve Cyl. Head). Grader 6081H PowerTech Eng. (2-Valve Cyl. Head). Power Unit 6081H PowerTech Eng. (2-Valve Cyl. Head). Scraper 6081H PowerTech Eng. (2-Valve Cyl. Head). Wheel Tractor 6081H PowerTech Eng. (2-Valve Cyl. Head). Crawler Tractor 6081H PowerTech Eng. (2-Valve Cyl. Head). Loader Tractor 6081H PowerTech Eng. (2-Valve Cyl. Head). Forestry Tractor 6081H PowerTech Eng. (2-Valve Cyl. Head). Excavator 6081H PowerTech Eng. (2-Valve Cyl. Head). Skidder 6081H PowerTech Eng. (2-Valve Cyl. Head). Logger 6081H PowerTech Eng. (2-Valve Cyl. Head). Feller Buncher 6081H PowerTech Eng. (2-Valve Cyl. Head). Forage Harvester 6081H PowerTech Eng. (2-Valve Cyl. Head).*  
 8.1L 495.9 (8129cc) OHV Turbo-Diesel L6 (PowerTech 2V IC), 116mm Bore

### ENGINE BLOCK & PARTS (cont.)

QTY	GASKETS (cont.)	PART NO.	SIZE	DESCRIPTION
1	Front Cover Gasket	FP-R119384		Timing gear cover
1	Oil Pan Gasket	FP-R49377		w/Alum. pan; Oil pan codes 1906, 1909, 1914, 1916
1	Oil Pan Gasket	FP-R71918		w/Cast Iron pan
1	O-Ring	FP-U13639		Block coolant drain plug seal; Coolant heater codes 2601, 2602; 1.475" X .118"
QTY	GASKET SETS	PART NO.	SIZE	DESCRIPTION
1	Complete Overhaul Gasket Set	FP-RE57187		From Ser. No. 500,000; Crankshaft seals not incl.
QTY	CAM BEARINGS	PART NO.	SIZE	DESCRIPTION
4	Cam Brg.	FP-R87561		
QTY	OIL COOLERS & FILTERS	PART NO.	SIZE	DESCRIPTION
1	Aftercooler Gasket	FP-R88993		w/Int. manifold codes 1703, 1738
2	Aftercooler Gasket	FP-R88993		w/Int. manifold codes 1705, 1737
1	Oil Cooler	FP-AR55394		
4	O-Ring	FP-R47153		Cooler tube; Cooler code 5901
4	O-Ring	FP-R47153		Oil filter tube; Filter code 5901
1	Oil Cooler Housing Gasket	FP-AR58952		
2	Oil Cooler Adapter Gasket Set	FP-R50424		
CRANKSHAFT/OIL PUMP				
QTY	SEALS - FRONT CRANK	PART NO.	SIZE	DESCRIPTION
1	Oil Seal Kit	FP-AR49025		
QTY	SEALS - REAR CRANK	PART NO.	SIZE	DESCRIPTION
1	Oil Seal	FP-RE22764		PTFE
QTY	MAIN BEARINGS	PART NO.	SIZE	DESCRIPTION
6	Plain Main Brg.	FP-RE529319	STD	
1	Flanged Main Brg.	FP-RE529320	STD	
QTY	OIL PUMP	PART NO.	SIZE	DESCRIPTION
2	O-Ring	FP-U17409		Oil cooler relief valve plug seal; Filter & housing code 5901
1	Oil Pump Intake Gasket	FP-R100569		Oil pump pickup codes 1906, 1909, 1916
1	Oil Filter Base Gasket	FP-R119847		Housing to block gskt.
CYLINDER COMPONENTS				
QTY	LINERS	PART NO.	SIZE	DESCRIPTION
6	Liner w/o Sealing Ring	FP-R520212	STD	
6	Cylinder Kit Complete	FP-RE508156 *	STD	For Low Compression Engines
6	Cylinder Kit Complete	FP-RE64509	STD	Use w/pistons marked RE64170, RE65289, RE70688; For High Compression Engines
6	Cyl. Liner Sealing Ring Kit	FP-AR98850		
QTY	PISTONS	PART NO.	SIZE	DESCRIPTION
6	Piston Body w/o Pin	FP-RE70688	STD	For High Compression Engines
6	Piston Body w/o Pin	FP-RE516291 *	STD	For Low Compression Engines
6	Pin	FP-R57771		
12	Piston Pin Retainer	FP-E1343FN		
6	Pin Bushing	FP-R74008		w/Con. Rod marked R11634, R501034; 1.877" ID, 2.0622 OD, 1.8728" O.A.L.
QTY	CONNECTING RODS & BRGS.	PART NO.	SIZE	DESCRIPTION
12	Con. Rod Bolt	FP-R501035		Fractured split rod
12	Con. Rod Bolt	FP-R66452		To Ser. No. 086,535; w/Con. Rod marked R116340; Machine split rod; Torque-To-Yield bolt; Replacement recommended
6	Rod Bearing Half Upper/Lower	FP-R525767	STD	
QTY	PISTON RINGS	PART NO.	SIZE	DESCRIPTION
6	Ring Set Single Cylinder	FP-RE503528	STD	

(continued on next page)



# John Deere Off Highway

**Off-Highway Truck 6081H PowerTech Eng. (2-Valve Cyl. Head). Combine 6081H 118**  
**PowerTech Eng. (2-Valve Cyl. Head). Cotton Picker 6081H PowerTech Eng. (2-Valve Cyl. (cont.)**  
**Head). Harvester 6081H PowerTech Eng. (2-Valve Cyl. Head). Grader 6081H PowerTech**  
**Eng. (2-Valve Cyl. Head). Power Unit 6081H PowerTech Eng. (2-Valve Cyl. Head). Scraper**  
**6081H PowerTech Eng. (2-Valve Cyl. Head). Wheel Tractor 6081H PowerTech Eng.**  
**(2-Valve Cyl. Head). Crawler Tractor 6081H PowerTech Eng. (2-Valve Cyl. Head). Loader**  
**Tractor 6081H PowerTech Eng. (2-Valve Cyl. Head). Forestry Tractor 6081H PowerTech**  
**Eng. (2-Valve Cyl. Head). Excavator 6081H PowerTech Eng. (2-Valve Cyl. Head). Skidder**  
**6081H PowerTech Eng. (2-Valve Cyl. Head). Logger 6081H PowerTech Eng. (2-Valve Cyl.**  
**Head). Feller Buncher 6081H PowerTech Eng. (2-Valve Cyl. Head). Forage Harvester**  
**6081H PowerTech Eng. (2-Valve Cyl. Head).**  
 8.1L 495.9 (8129cc) OHV Turbo-Diesel L6 (PowerTech 2V IC), 116mm Bore

## KITS

QTY	OVERHAUL KIT	PART NO.	SIZE	DESCRIPTION
1	In-Frame Overhaul Kit	FP-IFKPT6081		
1	Complete Overhaul Kit	FP-OHPT6081		

**Off-Highway Truck 6081A PowerTech Eng. (2-Valve Cyl. Head). Combine 6081A 119**  
**PowerTech Eng. (2-Valve Cyl. Head). Cotton Picker 6081A PowerTech Eng. (2-Valve Cyl.**  
**Head). Harvester 6081A PowerTech Eng. (2-Valve Cyl. Head). Grader 6081A PowerTech**  
**Eng. (2-Valve Cyl. Head). Power Unit 6081A PowerTech Eng. (2-Valve Cyl. Head). Scraper**  
**6081A PowerTech Eng. (2-Valve Cyl. Head). Wheel Tractor 6081A PowerTech Eng.**  
**(2-Valve Cyl. Head). Crawler Tractor 6081A PowerTech Eng. (2-Valve Cyl. Head). Loader**  
**Tractor 6081A PowerTech Eng. (2-Valve Cyl. Head). Forestry Tractor 6081A PowerTech**  
**Eng. (2-Valve Cyl. Head). Excavator 6081A PowerTech Eng. (2-Valve Cyl. Head). Skidder**  
**6081A PowerTech Eng. (2-Valve Cyl. Head). Logger 6081A PowerTech Eng. (2-Valve Cyl.**  
**Head). Feller Buncher 6081A PowerTech Eng. (2-Valve Cyl. Head). Forage Harvester**  
**6081A PowerTech Eng. (2-Valve Cyl. Head).**  
 8.1L 495.9 (8129cc) OHV Turbo-Diesel L6 (PowerTech 2V AC), 116mm Bore

## CYL. HEAD & PARTS

QTY	GASKETS	PART NO.	SIZE	DESCRIPTION
1	Valve Cover Gasket	FP-R49866		Rocker cover codes 1102, 1105, 2912
1	Head Gasket	FP-RE55475		
1	Head Set	FP-RE57186		
QTY	VALVE	PART NO.	SIZE	DESCRIPTION
6	Intake	FP-R84618	STD	1 groove; Chrome plated stem; 2.0080" Head Dia., .3730" Stem Dia., 6.0600" O.A.L.
6	Intake	FP-R93308	3	1 groove; Chrome plated stem; 2.0080" Head Dia., .3760" Stem Dia., 6.0600" O.A.L.
6	Exhaust	FP-R84619	STD	1 groove; Chrome plated stem; 1.8500" Head Dia., .3720" Stem Dia., 6.1780" O.A.L.
6	Exhaust	FP-R93311	3	1 groove; Chrome plated stem; 1.8500" Head Dia., .3750" Stem Dia., 6.1780" O.A.L.
12	Valve Stem Cap	FP-T20129		Exh. & Int.
24	Keeper	FP-T20077		Exh. & Int.; 1 groove; Square cut key groove; Hardened
QTY	VALVE SEAT	PART NO.	SIZE	DESCRIPTION
6	Exh.	FP-R119132	STD	
6	Exh.	FP-R93349	10	
6	Int.	FP-R121193	STD	
6	Int.	FP-R93350	10	
QTY	VALVE SPRING	PART NO.	SIZE	DESCRIPTION
12	Spring	FP-R91822		Exh. & Int.
QTY	VALVE MISC.	PART NO.	SIZE	DESCRIPTION
12	Rotocap	FP-RE11410		Exh. & Int.
1	Oil Filler Cap Gasket	FP-T20328		Rocker arm cover codes 1105, 2912

## ELECTRICAL

QTY	ALTERNATOR	PART NO.	SIZE	DESCRIPTION
1	Ball Brg.	FP-JD9449		Front; Code 3143; 12 Volt, 90 amp alternator; Poly-Vee fan drive

## INT & EXH MANIFOLDS

QTY	INT. & EXH. MANIFOLDS	PART NO.	SIZE	DESCRIPTION
2	Exhaust Manifold Gasket	FP-R83020		Codes 2802, 3830; w/two holes; Two Exh. holes
2	Exhaust Manifold Gasket	FP-R83021		Codes 2802, 3830; One Exh. hole
3	Intake Manifold Gasket	FP-R130573		w/Int. manifolds R127427, R131652

(continued on next page)

**119** *Off-Highway Truck 6081A PowerTech Eng. (2-Valve Cyl. Head). Combine 6081A PowerTech Eng. (2-Valve Cyl. Head). Cotton Picker 6081A PowerTech Eng. (2-Valve Cyl. Head). Harvester 6081A PowerTech Eng. (2-Valve Cyl. Head). Grader 6081A PowerTech Eng. (2-Valve Cyl. Head). Power Unit 6081A PowerTech Eng. (2-Valve Cyl. Head). Scraper 6081A PowerTech Eng. (2-Valve Cyl. Head). Wheel Tractor 6081A PowerTech Eng. (2-Valve Cyl. Head). Crawler Tractor 6081A PowerTech Eng. (2-Valve Cyl. Head). Loader Tractor 6081A PowerTech Eng. (2-Valve Cyl. Head). Forestry Tractor 6081A PowerTech Eng. (2-Valve Cyl. Head). Excavator 6081A PowerTech Eng. (2-Valve Cyl. Head). Skidder 6081A PowerTech Eng. (2-Valve Cyl. Head). Logger 6081A PowerTech Eng. (2-Valve Cyl. Head). Feller Buncher 6081A PowerTech Eng. (2-Valve Cyl. Head). Forage Harvester 6081A PowerTech Eng. (2-Valve Cyl. Head).*  
 8.1L 495.9 (8129cc) OHV Turbo-Diesel L6 (PowerTech 2V AC), 116mm Bore

### CAMSHAFT GROUP

QTY	TIMING COVER	PART NO.	SIZE	DESCRIPTION
1	Crankshaft Front Cover Gasket	FP-R26058		Housing to block gskt.
QTY	CAMSHAFT/LIFTER	PART NO.	SIZE	DESCRIPTION
1	Camshaft Plug	FP-R82007		

### FUEL SYSTEM & PARTS

QTY	FUEL INJECTION	PART NO.	SIZE	DESCRIPTION
1	Washer	FP-R53899		Control valve to pump housing seal; Inj. pump housing connector codes 1616, 1621, 1632, 1633, 1634, 1635, 1636, 1641, 1655, 1657, 1658, 1659
2	Washer	FP-R53901		Fuel inj. pump connector seal; Filter & line codes 1603, 1604, 1605, 1607, 1608, 1609, 1610, 1611, 1612, 1613, 1615, 1617, 1618, 1619, 1620, 1622, 1623, 1624, 1640, 1656, 1676; w/Bosch pump
6	Washer	FP-R84472		Injector nozzle; Nozzle codes 1601, 1602, 1603, 1604, 1605, 1606, 1607, 1608, 1609, 1613, 1615, 1620, 1621, 1622, 1624, 1630, 1632, 1633, 1635, 1639, 1642, 1648, 1651, 1655, 1657, 1659, 1661, 1662, 1663, 1676; .290" X .715" X .079"
6	Fuel Injector Nut	FP-R79604		Injector line codes 1601, 1602
13	Washer Type Seal	FP-R51936		Fuel line; Line codes 1601, 1602, 1603, 1604, 1605, 1606, 1608, 1610, 1611, 1612, 1616, 1617, 1618, 1619, 1632, 1634, 1636, 1640, 1641, 1643, 1644, 1645, 1646, 1647, 1648, 1649, 1650, 1656, 1661, 1662, 1663, 1667
QTY	TURBOCHARGER	PART NO.	SIZE	DESCRIPTION
1	Turbocharger Oil Drain Gasket	FP-R105346		w/Turbo oil line codes 6501, 6503, 6504, 6505, 6506, 6507, 6508, 6510, 6511, 6512, 6513, 6529, 6530, 6531
1	Turbocharger Mounting Gasket	FP-R89879		
1	O-Ring	FP-R86743		Outer coupling
1	Turbo Exhaust Int. Cover Gskt	FP-R92097		Turbo code 6514

### COOLING SYSTEM

QTY	WATER PUMP	PART NO.	SIZE	DESCRIPTION
2	Ball Brg.	FP-JD10329		Fan hub shaft bearing
1	Water Pump Gasket	FP-R119383		w/Pump housing marked R119795; w/15 tooth gear; High flow
1	Water Pump Gasket	FP-R119383		w/Pump housing marked R119795; w/16 tooth gear; Low flow
1	Oil Seal	FP-RE39134		Water pump codes 2001, 2004; w/Pump housing marked R119795
1	Water Pump Hub	FP-JD10058		w/Fan Hub bearing codes 2305, 2306, 2335, 2336, 2337, 2338, 2339
1	Water Pump Filter	FP-R98527		w/Pump housing marked R119795
QTY	THERMOSTAT	PART NO.	SIZE	DESCRIPTION
2	Thermostat	FP-AR48675		Thermostat code 2204; 180 Deg.
1	Thermostat Gasket	FP-R124211		Thermostat housing to cyl. head
1	Thermostat Cover Gasket	FP-R46479		Thermostat cover codes 2102, 2114; Two hole
1	Therm. Hsg. - Water Mfld. Gsk	FP-R86062		Housing to cyl. head
QTY	MISCELLANEOUS	PART NO.	SIZE	DESCRIPTION
2	Water Manifold Mounting Gskt.	FP-R88397		

### ENGINE BLOCK & PARTS

QTY	GASKETS	PART NO.	SIZE	DESCRIPTION
1	Front Cover Gasket	FP-R125670		Air compressor to timing cover; Midland or Holset
1	Front Cover Gasket	FP-R119384		Timing gear cover
1	Oil Pan Gasket	FP-R49377		w/Alum. pan; Oil pan codes 1906, 1909, 1914, 1916
1	Oil Pan Gasket	FP-R71918		w/Cast Iron pan
1	O-Ring	FP-U13639		Block coolant drain plug seal; Coolant heater codes 2601, 2602; 1.475" X .118"

(continued on next page)



# John Deere Off Highway

*Off-Highway Truck 6081A PowerTech Eng. (2-Valve Cyl. Head). Combine 6081A 119 PowerTech Eng. (2-Valve Cyl. Head). Cotton Picker 6081A PowerTech Eng. (2-Valve Cyl. Head). Harvester 6081A PowerTech Eng. (2-Valve Cyl. Head). Grader 6081A PowerTech Eng. (2-Valve Cyl. Head). Power Unit 6081A PowerTech Eng. (2-Valve Cyl. Head). Scraper 6081A PowerTech Eng. (2-Valve Cyl. Head). Wheel Tractor 6081A PowerTech Eng. (2-Valve Cyl. Head). Crawler Tractor 6081A PowerTech Eng. (2-Valve Cyl. Head). Loader Tractor 6081A PowerTech Eng. (2-Valve Cyl. Head). Forestry Tractor 6081A PowerTech Eng. (2-Valve Cyl. Head). Excavator 6081A PowerTech Eng. (2-Valve Cyl. Head). Skidder 6081A PowerTech Eng. (2-Valve Cyl. Head). Logger 6081A PowerTech Eng. (2-Valve Cyl. Head). Feller Buncher 6081A PowerTech Eng. (2-Valve Cyl. Head). Forage Harvester 6081A PowerTech Eng. (2-Valve Cyl. Head).*  
 8.1L 495.9 (8129cc) OHV Turbo-Diesel L6 (PowerTech 2V AC), 116mm Bore

## ENGINE BLOCK & PARTS (cont.)

QTY	GASKET SETS	PART NO.	SIZE	DESCRIPTION
1	Complete Overhaul Gasket Set	FP-RE57187		From Ser. No. 500,000; Crankshaft seals not incl.

QTY	CAM BEARINGS	PART NO.	SIZE	DESCRIPTION
4	Cam Brg.	FP-R87561		

QTY	OIL COOLERS & FILTERS	PART NO.	SIZE	DESCRIPTION
1	Aftercooler Gasket	FP-R88993		w/Int. manifold codes 1703, 1738
2	Aftercooler Gasket	FP-R88993		w/Int. manifold codes 1705, 1737
1	Oil Cooler	FP-AR55394		
4	O-Ring	FP-R47153		Cooler tube; Cooler code 5901
4	O-Ring	FP-R47153		Oil filter tube; Filter code 5901
1	Oil Cooler Housing Gasket	FP-AR58952		
2	Oil Cooler Adapter Gasket Set	FP-R50424		

## CRANKSHAFT/OIL PUMP

QTY	SEALS - FRONT CRANK	PART NO.	SIZE	DESCRIPTION
1	Oil Seal Kit	FP-AR49025		

QTY	SEALS - REAR CRANK	PART NO.	SIZE	DESCRIPTION
1	Oil Seal	FP-RE22764		PTFE

QTY	MAIN BEARINGS	PART NO.	SIZE	DESCRIPTION
6	Plain Main Brg.	FP-RE529319	STD	
1	Flanged Main Brg.	FP-RE529320	STD	

QTY	OIL PUMP	PART NO.	SIZE	DESCRIPTION
2	O-Ring	FP-U17409		Oil cooler relief valve plug seal; Filter & housing code 5901
1	Oil Pump Intake Gasket	FP-R100569		Oil pump pickup codes 1906, 1909, 1916
1	Oil Filter Base Gasket	FP-R119847		Housing to block gskt.

## CYLINDER COMPONENTS

QTY	LINERS	PART NO.	SIZE	DESCRIPTION
6	Liner w/o Sealing Ring	FP-R520212	STD	
6	Cylinder Kit Complete	FP-RE508156 *	STD	For Low Compression Engines
6	Cylinder Kit Complete	FP-RE64509	STD	Use w/pistons marked RE64170, RE65289, RE70688; For High Compression Engines
6	Cyl. Liner Sealing Ring Kit	FP-AR98850		

QTY	PISTONS	PART NO.	SIZE	DESCRIPTION
6	Piston Body w/o Pin	FP-RE516291 *	STD	For Low Compression Engines
6	Piston Body w/o Pin	FP-RE70688	STD	Used w/piston marked RE64170, RE65289, RE70688; For High Compression Engines
6	Pin	FP-R57771		
12	Piston Pin Retainer	FP-E1343FN		
6	Pin Bushing	FP-R74008		w/Con. Rod marked R11634, R501034; 1.877" ID, 2.0622 OD, 1.8728" O.A.L.

QTY	CONNECTING RODS & BRGS.	PART NO.	SIZE	DESCRIPTION
12	Con. Rod Bolt	FP-R501035		Fractured split rod
12	Con. Rod Bolt	FP-R66452		To Ser. No. 086,535; w/Con. Rod marked R116340; Machine split rod; Torque-To-Yield bolt; Replacement recommended
6	Rod Bearing Half Upper/Lower	FP-R525767	STD	

QTY	PISTON RINGS	PART NO.	SIZE	DESCRIPTION
6	Ring Set Single Cylinder	FP-RE503528	STD	

## KITS

QTY	OVERHAUL KIT	PART NO.	SIZE	DESCRIPTION
1	In-Frame Overhaul Kit	FP-IFKPT6081		
1	Complete Overhaul Kit	FP-OHPT6081		

\* New Item — Check For Availability

**120 Power Unit 6081TN PowerTech Eng. (Natural Gas). Wheel Tractor 6081TN PowerTech Eng. (Natural Gas).**  
8.1L 495.9 (8129cc) OHV Turbo-NG L6 (PowerTech 2V), 116mm Bore

CYL. HEAD & PARTS				
<b>QTY</b>	<b>GASKETS</b>	<b>PART NO.</b>	<b>SIZE</b>	<b>DESCRIPTION</b>
1	Head Gasket	FP-RE55475		
1	Head Set	FP-RE57186		
<b>QTY</b>	<b>VALVE</b>	<b>PART NO.</b>	<b>SIZE</b>	<b>DESCRIPTION</b>
12	Valve Stem Cap	FP-T20129		Exh. & Int.
24	Keeper	FP-T20077		1 groove; Square cut key groove; Hardened
<b>QTY</b>	<b>VALVE MISC.</b>	<b>PART NO.</b>	<b>SIZE</b>	<b>DESCRIPTION</b>
12	Rotocap	FP-RE11410		Exh. & Int.
1	Oil Filler Cap Gasket	FP-R80135		Cover code 5205; L.H. Auxiliary drive
1	Oil Filler Cap Gasket	FP-T20328		Rocker arm cover codes 1105, 2912
CAMSHAFT GROUP				
<b>QTY</b>	<b>TIMING COVER</b>	<b>PART NO.</b>	<b>SIZE</b>	<b>DESCRIPTION</b>
1	Crankshaft Front Cover Gasket	FP-R26058		Rear
1	Timing Gear Cover Gasket	FP-R50390		Access cover
<b>QTY</b>	<b>CAMSHAFT/LIFTER</b>	<b>PART NO.</b>	<b>SIZE</b>	<b>DESCRIPTION</b>
1	Camshaft Plug	FP-R82007		
FUEL SYSTEM & PARTS				
<b>QTY</b>	<b>TURBOCHARGER</b>	<b>PART NO.</b>	<b>SIZE</b>	<b>DESCRIPTION</b>
1	Turbocharger Oil Drain Gasket	FP-R105346		w/Turbo oil line codes 6501, 6502, 6504, 6505, 6506, 6507, 6508, 6510, 6511, 6512, 6513, 6529, 6530, 6531
1	Turbocharger Mounting Gasket	FP-R89879		
COOLING SYSTEM				
<b>QTY</b>	<b>WATER PUMP</b>	<b>PART NO.</b>	<b>SIZE</b>	<b>DESCRIPTION</b>
1	Water Pump Gasket	FP-R119383		Pump codes 2015, 5701; w/Pump housing marked R119795
1	Oil Seal	FP-RE39134		Water pump codes 2015, 5701; w/Pump housing marked R119795
1	Water Pump Filter	FP-R98527		w/Pump housing marked R119795
<b>QTY</b>	<b>THERMOSTAT</b>	<b>PART NO.</b>	<b>SIZE</b>	<b>DESCRIPTION</b>
2	Thermostat	FP-AR72852		Water manifold & thermostat codes 2114, 2202, 3901; 192 Deg.
1	Thermostat Gasket	FP-R124211		Water manifold & thermostat codes 2114, 2202, 3901
<b>QTY</b>	<b>MISCELLANEOUS</b>	<b>PART NO.</b>	<b>SIZE</b>	<b>DESCRIPTION</b>
2	Water Manifold Mounting Gskt.	FP-R88397		Water manifold & thermostat codes 2114, 2202, 3901
ENGINE BLOCK & PARTS				
<b>QTY</b>	<b>GASKETS</b>	<b>PART NO.</b>	<b>SIZE</b>	<b>DESCRIPTION</b>
1	Front Cover Gasket	FP-R119384		Timing gear & front seal codes 6201, 7701
1	Oil Pan Gasket	FP-R49377		w/Alum. oil pan w/shallow sump; Oil pan code 1901
1	O-Ring	FP-U13639		Block coolant drain plug seal; Coolant heater code 2601; 1.475" X .118"
1	O-Ring	FP-R71596		Timing gear & front seal codes 6201, 7701; Plate seal
<b>QTY</b>	<b>GASKET SETS</b>	<b>PART NO.</b>	<b>SIZE</b>	<b>DESCRIPTION</b>
1	Complete Overhaul Gasket Set	FP-RE57187		Crankshaft seals not incl.
<b>QTY</b>	<b>CAM BEARINGS</b>	<b>PART NO.</b>	<b>SIZE</b>	<b>DESCRIPTION</b>
4	Cam Brg.	FP-R87561		
<b>QTY</b>	<b>OIL COOLERS &amp; FILTERS</b>	<b>PART NO.</b>	<b>SIZE</b>	<b>DESCRIPTION</b>
1	Oil Cooler	FP-AR55394		Oil cooler code 5901
1	Oil Cooler Bypass Gasket	FP-R109625		Adapter
1	Oil Cooler Housing Gasket	FP-AR58952		Oil cooler code 5901
2	Oil Cooler Adapter Gasket Set	FP-R50424		Oil cooler code 5901
CRANKSHAFT/OIL PUMP				
<b>QTY</b>	<b>SEALS - FRONT CRANK</b>	<b>PART NO.</b>	<b>SIZE</b>	<b>DESCRIPTION</b>
1	Oil Seal Kit	FP-AR49025		Timing gear & front seal codes 6201, 7701
<b>QTY</b>	<b>SEALS - REAR CRANK</b>	<b>PART NO.</b>	<b>SIZE</b>	<b>DESCRIPTION</b>
1	Oil Seal	FP-RE22764		PTFE
<b>QTY</b>	<b>MAIN BEARINGS</b>	<b>PART NO.</b>	<b>SIZE</b>	<b>DESCRIPTION</b>
6	Plain Main Brg.	FP-RE529319	STD	
1	Flanged Main Brg.	FP-RE529320	STD	
<b>QTY</b>	<b>OIL PUMP</b>	<b>PART NO.</b>	<b>SIZE</b>	<b>DESCRIPTION</b>
4	O-Ring	FP-R71732		Oil cooler bypass tube seals
2	O-Ring	FP-U17409		Oil cooler relief valve plug seal; Filter & housing code 5901
1	O-Ring	FP-R72328		Rocker arm cover code 1110; Vent tube elbow seal

(continued on next page)





# John Deere Off Highway

**Power Unit 6081TN PowerTech Eng. (Natural Gas). Wheel Tractor 6081TN PowerTech 120 Eng. (Natural Gas). (cont.)**  
8.1L 495.9 (8129cc) OHV Turbo-NG L6 (PowerTech 2V), 116mm Bore

### CRANKSHAFT/OIL PUMP (cont.)

QTY	OIL PUMP (cont.)	PART NO.	SIZE	DESCRIPTION
4	O-Ring	FP-R47153		Tube seal; Filter & housing code 5901
2	O-Ring	FP-R71732		Tube seal; Pump code 5002
1	Rect. or Square Seal	FP-R43660		Filter seal; Filter & housing code 5901
1	Oil Filter Seal Ring	FP-R26163		Turbocharger elbow seal
1	Oil Filter Base Gasket	FP-R119847		Filter & housing code 5901

### CYLINDER COMPONENTS

QTY	LINERS	PART NO.	SIZE	DESCRIPTION
6	Cyl. Liner Sealing Ring Kit	FP-AR98850		
QTY	PISTONS	PART NO.	SIZE	DESCRIPTION
6	Pin	FP-R57771		
12	Piston Pin Retainer	FP-E1343FN		
6	Pin Bushing	FP-R74008		1.877" ID, 2.0622 OD, 1.8728" O.A.L.
QTY	CONNECTING RODS & BRGS.	PART NO.	SIZE	DESCRIPTION
12	Con. Rod Bolt	FP-R66452		w/Con. Rod marked R116340; Torque-To-Yield bolt; Replacement recommended
6	Rod Bearing Half Upper/Lower	FP-R525767	STD	

**Combine 6081T PowerTech Eng. Cotton Picker 6081T PowerTech Eng. Harvester 6081T 121 PowerTech Eng. Grader 6081T PowerTech Eng. Power Unit 6081T PowerTech Eng. Scraper 6081T PowerTech Eng. Wheel Tractor 6081T PowerTech Eng. Crawler Tractor 6081T PowerTech Eng. Loader Tractor 6081T PowerTech Eng. Forestry Tractor 6081T PowerTech Eng. Excavator 6081T PowerTech Eng. Skidder 6081T PowerTech Eng. Sprayer 6081T PowerTech Eng. Logger 6081T PowerTech Eng. Feller Buncher 6081T PowerTech Eng.**  
8.1L 495.9 (8129cc) OHV Turbo-Diesel L6 (PowerTech 2V), 116mm Bore

### CYL. HEAD & PARTS

QTY	GASKETS	PART NO.	SIZE	DESCRIPTION
1	Valve Cover Gasket	FP-R49866		Rocker cover codes 1102, 1105, 2912
1	Head Gasket	FP-RE55475		
1	Head Set	FP-RE57186		
QTY	VALVE	PART NO.	SIZE	DESCRIPTION
6	Intake	FP-R84618	STD	1 groove; Chrome plated stem; 2.0080" Head Dia., .3730" Stem Dia., 6.0600" O.A.L.
6	Intake	FP-R93308	3	1 groove; Chrome plated stem; 2.0080" Head Dia., .3760" Stem Dia., 6.0600" O.A.L.
6	Exhaust	FP-R84619	STD	1 groove; Chrome plated stem; 1.8500" Head Dia., .3720" Stem Dia., 6.1780" O.A.L.
6	Exhaust	FP-R93311	3	1 groove; Chrome plated stem; 1.8500" Head Dia., .3750" Stem Dia., 6.1780" O.A.L.
12	Valve Stem Cap	FP-T20129		Exh. & Int.
24	Keeper	FP-T20077		Exh. & Int.; 1 groove; Square cut key groove; Hardened
QTY	VALVE SEAT	PART NO.	SIZE	DESCRIPTION
6	Exh.	FP-R119132	STD	
6	Exh.	FP-R93349	10	
6	Int.	FP-R121193	STD	
6	Int.	FP-R93350	10	
QTY	VALVE SPRING	PART NO.	SIZE	DESCRIPTION
12	Spring	FP-R91822		Exh. & Int.
QTY	VALVE MISC.	PART NO.	SIZE	DESCRIPTION
12	Rotocap	FP-RE11410		Exh. & Int.
1	Oil Filler Cap Gasket	FP-T20328		Rocker arm cover codes 1105, 2912

### ELECTRICAL

QTY	ALTERNATOR	PART NO.	SIZE	DESCRIPTION
1	Ball Brg.	FP-JD9449		Front; Code 3143; 12 Volt, 90 amp alternator; Poly-Vee fan drive

### INT & EXH MANIFOLDS

QTY	INT. & EXH. MANIFOLDS	PART NO.	SIZE	DESCRIPTION
2	Exhaust Manifold Gasket	FP-R83020		Codes 2802, 3830; w/two holes; Two Exh. holes
2	Exhaust Manifold Gasket	FP-R83021		Codes 2802, 3830; One Exh. hole
3	Intake Manifold Gasket	FP-R130573		w/Int. manifolds R127427, R131652

(continued on next page)

**121** *Combine 6081T PowerTech Eng. Cotton Picker 6081T PowerTech Eng. Harvester 6081T PowerTech Eng. Grader 6081T PowerTech Eng. Power Unit 6081T PowerTech Eng. Scraper 6081T PowerTech Eng. Wheel Tractor 6081T PowerTech Eng. Crawler Tractor 6081T PowerTech Eng. Loader Tractor 6081T PowerTech Eng. Forestry Tractor 6081T PowerTech Eng. Excavator 6081T PowerTech Eng. Skidder 6081T PowerTech Eng. Sprayer 6081T PowerTech Eng. Logger 6081T PowerTech Eng. Feller Buncher 6081T PowerTech Eng.*

8.1L 495.9 (8129cc) OHV Turbo-Diesel L6 (PowerTech 2V), 116mm Bore

## CAMSHAFT GROUP

QTY	TIMING COVER	PART NO.	SIZE	DESCRIPTION
1	Crankshaft Front Cover Gasket	FP-R26058		Housing to block gskt.

QTY	CAMSHAFT/LIFTER	PART NO.	SIZE	DESCRIPTION
1	Camshaft Plug	FP-R82007		

## FUEL SYSTEM & PARTS

QTY	FUEL INJECTION	PART NO.	SIZE	DESCRIPTION
1	Washer	FP-R53899		Control valve to pump housing seal; Inj. pump housing connector codes 1616, 1621, 1632, 1633, 1634, 1635, 1636, 1641, 1655, 1657, 1658, 1659
2	Washer	FP-R53901		Fuel inj. pump connector seal; Filter & line codes 1603, 1604, 1605, 1607, 1608, 1609, 1610, 1611, 1612, 1613, 1615, 1617, 1618, 1619, 1620, 1622, 1623, 1624, 1640, 1656, 1676; w/Bosch pump
6	Washer	FP-R84472		Injector nozzle; Nozzle codes 1601, 1602, 1603, 1604, 1605, 1606, 1607, 1608, 1609, 1613, 1615, 1620, 1621, 1622, 1624, 1630, 1632, 1633, 1635, 1639, 1642, 1648, 1651, 1655, 1657, 1659, 1661, 1662, 1663, 1676; .290" X .715" X .079"
6	Fuel Injector Nut	FP-R79604		Injector line codes 1601, 1602
13	Washer Type Seal	FP-R51936		Fuel line; Line codes 1601, 1602, 1603, 1604, 1605, 1606, 1608, 1610, 1611, 1612, 1616, 1617, 1618, 1619, 1632, 1634, 1636, 1640, 1641, 1643, 1644, 1645, 1646, 1647, 1648, 1649, 1650, 1656, 1661, 1662, 1663, 1667

QTY	TURBOCHARGER	PART NO.	SIZE	DESCRIPTION
1	Turbocharger Oil Drain Gasket	FP-R105346		w/Turbo oil line codes 6501, 6503, 6504, 6505, 6506, 6507, 6508, 6510, 6511, 6512, 6513, 6529, 6530, 6531
1	Turbocharger Mounting Gasket	FP-R89879		
1	O-Ring	FP-R86743		Outer coupling
1	Turbo Exhaust Int. Cover Gskt	FP-R92097		Turbo code 6514

## COOLING SYSTEM

QTY	WATER PUMP	PART NO.	SIZE	DESCRIPTION
2	Ball Brg.	FP-JD10329		Fan hub shaft bearing
1	Water Pump Gasket	FP-R119383		w/Pump housing marked R119795; w/15 tooth gear; High flow
1	Water Pump Gasket	FP-R119383		w/Pump housing marked R119795; w/16 tooth gear; Low flow
1	Oil Seal	FP-RE39134		Water pump codes 2001, 2004; w/Pump housing marked R119795
1	Water Pump Hub	FP-JD10058		w/Fan Hub bearing codes 2305, 2306, 2335, 2336, 2337, 2338, 2339
1	Water Pump Filter	FP-R98527		w/Pump housing marked R119795

QTY	THERMOSTAT	PART NO.	SIZE	DESCRIPTION
2	Thermostat	FP-AR48675		Thermostat code 2204; 180 Deg.
1	Thermostat Gasket	FP-R124211		Thermostat housing to cyl. head
1	Thermostat Cover Gasket	FP-R46479		Thermostat cover codes 2102, 2114; Two hole
1	Therm. Hsg. - Water Mfld. Gsk	FP-R86062		Housing to cyl. head

QTY	MISCELLANEOUS	PART NO.	SIZE	DESCRIPTION
2	Water Manifold Mounting Gskt.	FP-R88397		

## ENGINE BLOCK & PARTS

QTY	GASKETS	PART NO.	SIZE	DESCRIPTION
1	Front Cover Gasket	FP-R125670		Air compressor to timing cover; Midland or Holset
1	Front Cover Gasket	FP-R119384		Timing gear cover
1	Oil Pan Gasket	FP-R49377		w/Alum. pan; Oil pan codes 1906, 1909, 1914, 1916
1	Oil Pan Gasket	FP-R71918		w/Cast Iron pan
1	O-Ring	FP-U13639		Block coolant drain plug seal; Coolant heater codes 2601, 2602; 1.475" X .118"

QTY	GASKET SETS	PART NO.	SIZE	DESCRIPTION
1	Complete Overhaul Gasket Set	FP-RE57187		From Ser. No. 500,000; Crankshaft seals not incl.

QTY	CAM BEARINGS	PART NO.	SIZE	DESCRIPTION
4	Cam Brg.	FP-R87561		

(continued on next page)



# John Deere Off Highway

Combine 6081T PowerTech Eng. Cotton Picker 6081T PowerTech Eng. Harvester 6081T **121**  
 PowerTech Eng. Grader 6081T PowerTech Eng. Power Unit 6081T PowerTech Eng. (cont.)  
 Scraper 6081T PowerTech Eng. Wheel Tractor 6081T PowerTech Eng. Crawler Tractor  
 6081T PowerTech Eng. Loader Tractor 6081T PowerTech Eng. Forestry Tractor 6081T  
 PowerTech Eng. Excavator 6081T PowerTech Eng. Skidder 6081T PowerTech Eng.  
 Sprayer 6081T PowerTech Eng. Logger 6081T PowerTech Eng. Feller Buncher 6081T  
**PowerTech Eng.**  
 8.1L 495.9 (8129cc) OHV Turbo-Diesel L6 (PowerTech 2V), 116mm Bore

## ENGINE BLOCK & PARTS (cont.)

QTY	OIL COOLERS & FILTERS	PART NO.	SIZE	DESCRIPTION
1	Aftercooler Gasket	FP-R88993		w/Int. manifold codes 1703, 1738
2	Aftercooler Gasket	FP-R88993		w/Int. manifold codes 1705, 1737
1	Oil Cooler	FP-AR55394		
4	O-Ring	FP-R47153		Cooler tube; Cooler code 5901
4	O-Ring	FP-R47153		Oil filter tube; Filter code 5901
1	Oil Cooler Housing Gasket	FP-AR58952		
2	Oil Cooler Adapter Gasket Set	FP-R50424		

## CRANKSHAFT/OIL PUMP

QTY	SEALS - FRONT CRANK	PART NO.	SIZE	DESCRIPTION
1	Oil Seal Kit	FP-AR49025		
QTY	SEALS - REAR CRANK	PART NO.	SIZE	DESCRIPTION
1	Oil Seal	FP-RE22764		PTFE
QTY	MAIN BEARINGS	PART NO.	SIZE	DESCRIPTION
6	Plain Main Brg.	FP-RE529319	STD	
1	Flanged Main Brg.	FP-RE529320	STD	
QTY	OIL PUMP	PART NO.	SIZE	DESCRIPTION
2	O-Ring	FP-U17409		Oil cooler relief valve plug seal; Filter & housing code 5901
1	Oil Pump Intake Gasket	FP-R100569		Oil pump pickup codes 1906, 1909, 1916
1	Oil Filter Base Gasket	FP-R119847		Housing to block gskt.

## CYLINDER COMPONENTS

QTY	LINERS	PART NO.	SIZE	DESCRIPTION
6	Liner w/o Sealing Ring	FP-R520212	STD	
6	Cylinder Kit Complete	FP-RE508156 *	STD	For Low Compression Engines
6	Cylinder Kit Complete	FP-RE64509	STD	Use w/pistons marked RE64170, RE65289, RE70688; For High Compression Engines
6	Cyl. Liner Sealing Ring Kit	FP-AR98850		
QTY	PISTONS	PART NO.	SIZE	DESCRIPTION
6	Piston Body w/o Pin	FP-RE516291 *	STD	For Low Compression Engines
6	Piston Body w/o Pin	FP-RE70688	STD	Used w/piston marked RE64170, RE65289, RE70688; For High Compression Engines
6	Pin	FP-R57771		
12	Piston Pin Retainer	FP-E1343FN		
6	Pin Bushing	FP-R74008		w/Con. Rod marked R11634, R501034; 1.877" ID, 2.0622 OD, 1.8728" O.A.L.
QTY	CONNECTING RODS & BRGS.	PART NO.	SIZE	DESCRIPTION
12	Con. Rod Bolt	FP-R501035		Fractured split rod
12	Con. Rod Bolt	FP-R66452		To Ser. No. 086,535; w/Con. Rod marked R116340; Machine split rod; Torque-To-Yield bolt; Replacement recommended
6	Rod Bearing Half Upper/Lower	FP-R525767	STD	
QTY	PISTON RINGS	PART NO.	SIZE	DESCRIPTION
6	Ring Set Single Cylinder	FP-RE503528	STD	
KITS				
QTY	OVERHAUL KIT	PART NO.	SIZE	DESCRIPTION
1	In-Frame Overhaul Kit	FP-IFKPT6081		
1	Complete Overhaul Kit	FP-OHPT6081		

Scraper 6531D Eng. Wheel Tractor 6531D Eng. Loader Tractor 6531D Eng. Backhoe 6531D **122**  
**Eng.**  
 8.7L 531 OHV Diesel L6, 4.75" Bore

## CYL. HEAD & PARTS

QTY	GASKETS	PART NO.	SIZE	DESCRIPTION
1	Valve Cover Gasket	FP-R74365		
1	Head Gasket	FP-R78513		
1	Head Set	FP-AR53613		

(continued on next page)

\* New Item — Check For Availability

**122** *Scraper 6531D Eng. Wheel Tractor 6531D Eng. Loader Tractor 6531D Eng. Backhoe 6531D Eng.*  
 (cont.) **Eng.**  
 8.7L 531 OHV Diesel L6, 4.75" Bore

<b>CYL. HEAD &amp; PARTS (cont.)</b>				
QTY	GASKETS (cont.)	PART NO.	SIZE	DESCRIPTION
1	Ventilator Pump Gasket	FP-R31340		
QTY	VALVE	PART NO.	SIZE	DESCRIPTION
6	Intake	FP-R42182	STD	Chrome plated stem; 2.1500" Head Dia., .4340" Stem Dia., 6.5960" O.A.L.
6	Exhaust	FP-R45823	STD	Chrome plated stem
12	Valve Stem Cap	FP-R40366		Exh. & Int.
24	Keeper	FP-R35431		Exh. & Int.
QTY	VALVE GUIDE	PART NO.	SIZE	DESCRIPTION
12	Guide	FP-R53192		Exh. & Int.; .4375" ID, 3.1880" O.A.L.
QTY	VALVE SPRING	PART NO.	SIZE	DESCRIPTION
12	Spring	FP-R35157		Exh. & Int.
QTY	VALVE SEAL	PART NO.	SIZE	DESCRIPTION
12	Valve Stem Seal	ST-2007		Positive type; Rubber
6	O-Ring	FP-R35155		Int.
<b>ELECTRICAL</b>				
QTY	ALTERNATOR	PART NO.	SIZE	DESCRIPTION
1	Ball Brg.	FP-JD9449		Front; Motorola; 12 Volt, 72 amp alternator
<b>METERS</b>				
QTY	METERS	PART NO.	SIZE	DESCRIPTION
1	Hour Meter Housing Gasket	FP-R26173		
1	Speed/Hour Meter Gasket	FP-R44853		
<b>INT &amp; EXH MANIFOLDS</b>				
QTY	INT. & EXH. MANIFOLDS	PART NO.	SIZE	DESCRIPTION
2	Exhaust Manifold Gasket	FP-R35067		Inner
2	Exhaust Manifold Gasket	FP-R35068		Outer
3	Intake Manifold Gasket	FP-R35293		One Int. hole
3	Intake Manifold Gasket	FP-R40088		Two Int. holes
2	Int. Manif. Cover Plate Gskt.	FP-R40090		Cover & inlet elbow gskt.; To Ser. No. 284,617
<b>CAMSHAFT GROUP</b>				
QTY	TIMING COVER	PART NO.	SIZE	DESCRIPTION
1	Timing Gear Cover Gasket	FP-R35126		
QTY	CAMSHAFT/LIFTER	PART NO.	SIZE	DESCRIPTION
1	Camshaft Plug	FP-R26115		
<b>FUEL SYSTEM &amp; PARTS</b>				
QTY	FUEL INJECTION	PART NO.	SIZE	DESCRIPTION
1	Injector Pump Gasket	FP-R35349		Gear cover
1	Washer	FP-R40777		Ventilator pump housing
6	Washer	FP-R463R		Injector nozzle; Copper
12	Clamp	FP-R34766		Pump codes 1602, 1603
<b>COOLING SYSTEM</b>				
QTY	WATER PUMP	PART NO.	SIZE	DESCRIPTION
1	Water Pump Cover Gasket	FP-R35263		w/Pump housing marked R36812; Cover to block gskt.
1	Water Pump Cover Gasket	FP-R35262		Inner; w/Pump housing marked R36812
1	Shaft & Bearing Assembly	FP-JD9257		w/Pump housing marked R36812
QTY	THERMOSTAT	PART NO.	SIZE	DESCRIPTION
2	Thermostat Cover Gasket	FP-R42694		One hole
QTY	MISCELLANEOUS	PART NO.	SIZE	DESCRIPTION
2	Water Manifold Mounting Gskt.	FP-R88397		
<b>ENGINE BLOCK &amp; PARTS</b>				
QTY	GASKETS	PART NO.	SIZE	DESCRIPTION
1	Oil Pan Gasket	FP-R71919		
1	Washer	FP-R35034		Oil filter cover packing
QTY	GASKET SETS	PART NO.	SIZE	DESCRIPTION
1	In-Frame Gasket Set	FP-PG531DS		
1	Complete Overhaul Gasket Set	FP-AR53614		Crankshaft seals not incl.
1	Complete Overhaul Gasket Set	FP-AR53614WS		Incl. Crankshaft seals

(continued on next page)



# John Deere Off Highway

Scrapers 6531D Eng. Wheel Tractor 6531D Eng. Loader Tractor 6531D Eng. Backhoe 6531D **122**  
 Eng. (cont.)  
 8.7L 531 OHV Diesel L6, 4.75" Bore

## ENGINE BLOCK & PARTS (cont.)

QTY	CAM BEARINGS	PART NO.	SIZE	DESCRIPTION
1	Cam Set	FP-4R46903	STD	
4	Cam Brg.	FP-R46903	STD	
QTY	OIL COOLERS & FILTERS	PART NO.	SIZE	DESCRIPTION
2	Oil Cooler Gasket	FP-R27948		
1	O-Ring	FP-R375R		Cooler inlet pipe
1	Oil Cooler to Block Gasket	FP-R35105		Front
1	Oil Cooler to Block Gasket	FP-R35104		Rear
CRANKSHAFT/OIL PUMP				
QTY	CRANKSHAFT	PART NO.	SIZE	DESCRIPTION
1	Crankshaft	FP-AR92533		
1	Oil Seal Kit	FP-SK13310		Incl. Seal & Wear sleeve
QTY	SEALS - FRONT CRANK	PART NO.	SIZE	DESCRIPTION
1	Oil Seal Kit	FP-AR49025		
QTY	SEALS - REAR CRANK	PART NO.	SIZE	DESCRIPTION
1	Oil Seal	FP-RE13310		
1	Crankshaft Rear Housing Gskt.	FP-R35043		
QTY	MAIN BEARINGS	PART NO.	SIZE	DESCRIPTION
1	Main Set	FP-MBK531	STD	w/full groove lower brg.; Flanged No. 5 brg.
1	Main Set	FP-MBK53110	10	w/full groove lower brg.; Flanged No. 5 brg.
1	Main Set	FP-MBK53120	20	w/full groove lower brg.; Flanged No. 5 brg.
1	Main Set	FP-MBK53130	30	w/full groove lower brg.; Flanged No. 5 brg.
1	Main Set	FP-MBK619	STD	w/partial groove lower brg.
1	Main Set	FP-MBK61910	10	w/partial groove lower brg.
1	Main Set	FP-MBK61920	20	w/partial groove lower brg.
1	Main Set	FP-MBK61930	30	w/partial groove lower brg.
6	Plain Main Brg.	FP-AR101266	STD	
6	Plain Main Brg.	FP-AR104568	.25MM	
6	Plain Main Brg.	FP-AR104569	.50MM	
6	Plain Main Brg.	FP-AR104570	.75MM	
6	Plain Main Brg.	FP-AR101268	STD	w/partial groove lower brg.
6	Plain Main Brg.	FP-AR104122	.25MM	w/partial groove lower brg.
6	Plain Main Brg.	FP-AR104123	.50MM	w/partial groove lower brg.
6	Plain Main Brg.	FP-AR104124	.75MM	w/partial groove lower brg.
1	Plain Main Brg.	FP-AR101269	STD	w/partial groove lower brg.; Use w/Thrust Washer Set
1	Plain Main Brg.	FP-AR104126	.25MM	w/partial groove lower brg.; Use w/Thrust Washer Set
1	Plain Main Brg.	FP-AR104127	.50MM	w/partial groove lower brg.; Use w/Thrust Washer Set
1	Plain Main Brg.	FP-AR104128	.75MM	w/partial groove lower brg.; Use w/Thrust Washer Set
1	Flanged Main Brg.	FP-AR101267	STD	
1	Flanged Main Brg.	FP-AR104564	.25MM	
1	Flanged Main Brg.	FP-AR104565	.50MM	
1	Flanged Main Brg.	FP-AR104566	.75MM	
QTY	OIL PUMP	PART NO.	SIZE	DESCRIPTION
1	O-Ring	FP-R495R		Ventilator tube; Rocker cover codes 1102, 1104; Smooth
1	Oil Filter Body Gasket	FP-R35032		
CYLINDER COMPONENTS				
QTY	LINERS	PART NO.	SIZE	DESCRIPTION
6	Liner w/o Sealing Ring	FP-R35124		Early Eng.
6	Liner w/o Sealing Ring	FP-R42366		Late Eng.
6	Liner w/Sealing Rings	FP-R35124WS		Early Eng.
6	Liner w/Sealing Rings	FP-R42366WS		Late Eng.
6	Cylinder Kit Complete	FP-CK45065124		Early Eng.; w/Block marked R35130; w/Con. Rod marked R35048, R40238, R53286, R58881, R66927
6	Cylinder Kit Complete	FP-CK65482366	STD	Late Eng.; w/Block marked R40270, R42370, R45300, R47510; w/Con. Rod marked R35048, R40238, R53286, R58881, R66927
6	Cyl. Liner Sealing Ring Kit	FP-AR35992		Early Eng.
6	Cyl. Liner Sealing Ring Kit	FP-AR55951		Late Eng.
6	Sealing Ring	FP-SLR2482		Late Eng.
6	Sealing Ring	FP-SLR2498		Late Eng.
QTY	PISTONS	PART NO.	SIZE	DESCRIPTION
6	Piston Body w/o Pin	FP-AR44506		Early Eng.
6	Piston Body w/o Pin	FP-RE16548		Late Eng.
6	Piston Kit w/Pin & Retainers	FP-AR44506WP		Early Eng.
6	Piston Kit w/Pin & Retainers	FP-RE16548WP		Late Eng.

(continued on next page)

**122** *Scraper 6531D Eng. Wheel Tractor 6531D Eng. Loader Tractor 6531D Eng. Backhoe 6531D Eng.*  
 (cont.) **Eng.**  
 8.7L 531 OHV Diesel L6, 4.75" Bore

**CYLINDER COMPONENTS (cont.)**

QTY	PISTONS (cont.)	PART NO.	SIZE	DESCRIPTION
6	Piston Kit w/Ring Set	FP-AR44505		Early Eng.
6	Piston Kit w/Ring Set	FP-RE16549		Late Eng.
6	Pin	FP-R35053		
12	Piston Pin Retainer	FP-D2824R		
6	Pin Bushing	FP-R36328		w/Con. Rod marked R35048, R40238, R53286, R58881, R66927
6	Pin Bushing	FP-R76783		w/Con. Rod marked R48315, R53287, R58883, R66926; w/1.875" pin dia.; w/1.8762" ID, 2.0622" OD, 1.625" O.A.L.
6	Pin Bushing	FP-3414Y20		w/1.875" OD; w/1.750" pin dia.

**CONNECTING RODS & BRGS.**

QTY		PART NO.	SIZE	DESCRIPTION
12	Con. Rod Bolt	FP-R66453		Torque-To-Yield bolt; Replacement recommended
6	Rod Pair	FP-AR101271	STD	w/o oil hole & groove
6	Rod Pair	FP-AR104130	.25MM	w/o oil hole & groove
6	Rod Pair	FP-AR104131	.50MM	w/o oil hole & groove
6	Rod Pair	FP-AR104132	.75MM	w/o oil hole & groove
6	Rod Pair	FP-AR53020	STD	w/oil hole; w/partial groove
6	Rod Pair	FP-AR57208	10	w/oil hole; w/partial groove
6	Rod Pair	FP-AR57209	20	w/oil hole; w/partial groove
6	Rod Pair	FP-AR57210	30	w/oil hole; w/partial groove

**PISTON RINGS**

QTY		PART NO.	SIZE	DESCRIPTION
6	Ring Set Single Cylinder	FP-AR41295	STD	1-5/32, 1-3/32, 1-1/4 (1 cyl. set)

**KITS**

QTY	OVERHAUL KIT	PART NO.	SIZE	DESCRIPTION
1	In-Frame Overhaul Kit	FP-531DEIFK		Early Eng.; w/Block marked R35130; w/Con. Rod marked R35048, R40238, R53286, R58881, R66927; Incl. Torque-To-Yield con. rod bolts
1	In-Frame Overhaul Kit	FP-531DLIFK		Late Eng.; w/Block marked R40270, R42370, R45300, R47510; w/Con. Rod marked R35048, R40238, R53286, R58881, R66927; Incl. Torque-To-Yield con. rod bolts
1	Complete Overhaul Kit	FP-531DEOHK		Early Eng.; w/Block marked R35130; w/Con. Rod marked R35048, R40238, R53286, R58881, R66927; Incl. Torque-To-Yield con. rod bolts
1	Complete Overhaul Kit	FP-531DLOHK		Late Eng.; w/Block marked R40270, R42370, R45300, R47510; w/Con. Rod marked R35048, R40238, R53286, R58881, R66927; Incl. Torque-To-Yield con. rod bolts

**123** *Harvester 6531A, 6531T Eng. Grader 6531A, 6531T Eng. Loader 6531A, 6531T Eng. Wheel Tractor 6531A, 6531T Eng. Compactor 6531A, 6531T Eng.*  
 8.7L 531 OHV Turbo-Diesel L6, 4.75" Bore

**CYL. HEAD & PARTS**

QTY	GASKETS	PART NO.	SIZE	DESCRIPTION
1	Valve Cover Gasket	FP-R74365		
1	Head Gasket	FP-R78513		6531A Eng.
1	Head Set	FP-AR56154		6531A Eng.
1	Head Set	FP-AR67510		6531T Eng.

**VALVE**

QTY		PART NO.	SIZE	DESCRIPTION
6	Intake	FP-R90602		
6	Exhaust	FP-R90601		
24	Keeper	FP-R35431		Exh. & Int.; Exc. 6531TT Eng.; Model 7520

**VALVE SEAT**

QTY		PART NO.	SIZE	DESCRIPTION
6	Exh.	FP-R48314	STD	
6	Int.	FP-R48313	STD	

**VALVE GUIDE**

QTY		PART NO.	SIZE	DESCRIPTION
12	Guide	FP-R53192		Exh. & Int.; .4375" ID, 3.1880" O.A.L.

**VALVE SPRING**

QTY		PART NO.	SIZE	DESCRIPTION
6	Spring	FP-R49569		Inner
6	Spring	FP-R49571		Outer; 2.5200" Free Height

**VALVE MISC.**

QTY		PART NO.	SIZE	DESCRIPTION
12	Rotocap	FP-R81086		Exh. & Int.
1	Oil Filler Cap Gasket	FP-T20328		6531A Eng.

(continued on next page)



# John Deere Off Highway

**Harvester 6531A, 6531T Engs. Grader 6531A, 6531T Engs. Loader 6531A, 6531T Engs. 123**  
**Wheel Tractor 6531A, 6531T Engs. Compactor 6531A, 6531T Engs. (cont.)**  
 8.7L 531 OHV Turbo-Diesel L6, 4.75" Bore

<b>METERS</b>				
<b>QTY</b>	<b>METERS</b>	<b>PART NO.</b>	<b>SIZE</b>	<b>DESCRIPTION</b>
1	Speed/Hour Meter Gasket	FP-R44853		6531A Engs.
<b>INT &amp; EXH MANIFOLDS</b>				
<b>QTY</b>	<b>INT. &amp; EXH. MANIFOLDS</b>	<b>PART NO.</b>	<b>SIZE</b>	<b>DESCRIPTION</b>
2	Exhaust Manifold Gasket	FP-R80970		1 Hole
2	Exhaust Manifold Gasket	FP-R80969		6531A Engs.; 2 Holes
3	Intake Manifold Gasket	FP-R40088		6531A Engs.; Two Int. holes
<b>CAMSHAFT GROUP</b>				
<b>QTY</b>	<b>CAMSHAFT/LIFTER</b>	<b>PART NO.</b>	<b>SIZE</b>	<b>DESCRIPTION</b>
1	Camshaft Plug	FP-R26115		
<b>FUEL SYSTEM &amp; PARTS</b>				
<b>QTY</b>	<b>FUEL INJECTION</b>	<b>PART NO.</b>	<b>SIZE</b>	<b>DESCRIPTION</b>
1	Injector Pump Gasket	FP-R35349		6531A Engs.; Gear cover
1	Washer	FP-R57851		Inj. pump mounting
12	Washer	FP-R48693		6531A Engs.; Inj. leak-off screw; w/Bosch nozzle
12	Clamp	FP-R34766		6531A Engs.; Pump codes 1601, 1604
1	Washer Type Seal	FP-R51936		6531A Engs.; Leak-off & return line seals; Nozzle codes 1601, 1604
<b>QTY</b>	<b>FUEL FILTERS &amp; PUMP</b>	<b>PART NO.</b>	<b>SIZE</b>	<b>DESCRIPTION</b>
6	O-Ring	FP-R51603		Fuel nozzle; 6531A Engs.; w/Bosch injector
1	O-Ring	FP-R375R		Fuel check valve; 6531A Engs.; From Ser. No. 291,928
<b>QTY</b>	<b>TURBOCHARGER</b>	<b>PART NO.</b>	<b>SIZE</b>	<b>DESCRIPTION</b>
1	Turbocharger Mounting Gasket	FP-R49697		6531A Engs.
1	O-Ring	FP-R49424		Inner coupling; 6531A Engs.
1	O-Ring	FP-R49425		Outer coupling; 6531A Engs.
1	Turbocharger Oil Supply Gskt.	FP-R58222		6531A Engs.
<b>COOLING SYSTEM</b>				
<b>QTY</b>	<b>WATER PUMP</b>	<b>PART NO.</b>	<b>SIZE</b>	<b>DESCRIPTION</b>
1	Water Pump Shaft	FP-R82053		6531T Engs.; w/Pump housing marked R65237
1	Water Pump Repair/Rebuild Kit	FP-RE69840		6531A Engs.; w/Pump housing marked R48818
1	Water Pump Repair/Rebuild Kit	FP-RE69842		6531A Engs.; w/Pump housing marked R65237
2	Water Pump Mounting Gasket	FP-R49495		6531A Engs.; w/Pump housing marked R48818
4	O-Ring	FP-T13119		Manifold bypass tubes
1	Shaft & Bearing Assembly	FP-AU43144		6531A Engs.; w/Pump housing marked R48818, R58705
<b>QTY</b>	<b>THERMOSTAT</b>	<b>PART NO.</b>	<b>SIZE</b>	<b>DESCRIPTION</b>
3	Thermostat	FP-AR48675		6531A Engs.; w/Coolant manifold marked R48578; 180 Deg.
<b>QTY</b>	<b>MISCELLANEOUS</b>	<b>PART NO.</b>	<b>SIZE</b>	<b>DESCRIPTION</b>
2	Water Manifold Mounting Gskt.	FP-R88397		
<b>ENGINE BLOCK &amp; PARTS</b>				
<b>QTY</b>	<b>GASKETS</b>	<b>PART NO.</b>	<b>SIZE</b>	<b>DESCRIPTION</b>
1	Front Cover Gasket	FP-R49483		6531A Engs.; w/Timing gear cover marked R48835
1	Oil Pan Gasket	FP-R71919		
1	O-Ring	FP-P48347		Dipstick tube to block seal
<b>QTY</b>	<b>GASKET SETS</b>	<b>PART NO.</b>	<b>SIZE</b>	<b>DESCRIPTION</b>
1	In-Frame Gasket Set	FP-PG531AS		6531A Engs.
1	In-Frame Gasket Set	FP-PG531TS		6531T Engs.
1	Complete Overhaul Gasket Set	FP-RE17046		6531A Engs.
1	Complete Overhaul Gasket Set	FP-RE17046WS		6531A Engs.; Incl. crankshaft seals
1	Complete Overhaul Gasket Set	FP-RE17050		6531T Engs.
1	Complete Overhaul Gasket Set	FP-RE17050WS		6531T Engs.; Incl. crankshaft seals
<b>QTY</b>	<b>CAM BEARINGS</b>	<b>PART NO.</b>	<b>SIZE</b>	<b>DESCRIPTION</b>
1	Cam Set	FP-4R46903	STD	
4	Cam Brg.	FP-R46903	STD	
<b>QTY</b>	<b>OIL COOLERS &amp; FILTERS</b>	<b>PART NO.</b>	<b>SIZE</b>	<b>DESCRIPTION</b>
1	Aftercooler Gasket Set	FP-500A		6531A Engs.
2	Aftercooler Housing Gasket	FP-R53081		6531A Engs.
2	Oil Cooler Gasket	FP-R49489		6531A Engs.
1	Oil Cooler Top Gasket	FP-R49491		6531A Engs.; Oil cooler to regulator housing front
1	Oil Cooler Top Gasket	FP-R49490		6531A Engs.; Oil cooler to regulator housing rear

(continued on next page)

**123** Harvester 6531A, 6531T Engs. Grader 6531A, 6531T Engs. Loader 6531A, 6531T Engs.  
 (cont.) Wheel Tractor 6531A, 6531T Engs. Compactor 6531A, 6531T Engs.  
 8.7L 531 OHV Turbo-Diesel L6, 4.75" Bore

CRANKSHAFT/OIL PUMP				
QTY	CRANKSHAFT	PART NO.	SIZE	DESCRIPTION
1	Crankshaft	FP-AR92533		
1	Oil Seal Kit	FP-SK13310		Incl. Seal & Wear sleeve
QTY	SEALS - FRONT CRANK	PART NO.	SIZE	DESCRIPTION
1	Oil Seal Kit	FP-AR49025		
QTY	SEALS - REAR CRANK	PART NO.	SIZE	DESCRIPTION
1	Oil Seal	FP-RE13310		
1	Crankshaft Rear Housing Gskt.	FP-R35043		
QTY	MAIN BEARINGS	PART NO.	SIZE	DESCRIPTION
1	Main Set	FP-MBK531	STD	
1	Main Set	FP-MBK53110	10	
1	Main Set	FP-MBK53120	20	
1	Main Set	FP-MBK53130	30	
1	Main Set	FP-MBK619	STD	w/partial groove lower brg.
1	Main Set	FP-MBK61910	10	w/partial groove lower brg.
1	Main Set	FP-MBK61920	20	w/partial groove lower brg.
1	Main Set	FP-MBK61930	30	w/partial groove lower brg.
6	Plain Main Brg.	FP-AR101266	STD	
6	Plain Main Brg.	FP-AR104568	.25MM	
6	Plain Main Brg.	FP-AR104569	.50MM	
6	Plain Main Brg.	FP-AR104570	.75MM	
6	Plain Main Brg.	FP-AR101268	STD	w/partial groove lower brg.
6	Plain Main Brg.	FP-AR104122	.25MM	w/partial groove lower brg.
6	Plain Main Brg.	FP-AR104123	.50MM	w/partial groove lower brg.
6	Plain Main Brg.	FP-AR104124	.75MM	w/partial groove lower brg.
1	Plain Main Brg.	FP-AR101269	STD	w/partial groove lower brg.; Use w/Thrust Washer Set
1	Plain Main Brg.	FP-AR104126	.25MM	w/partial groove lower brg.; Use w/Thrust Washer Set
1	Plain Main Brg.	FP-AR104127	.50MM	w/partial groove lower brg.; Use w/Thrust Washer Set
1	Plain Main Brg.	FP-AR104128	.75MM	w/partial groove lower brg.; Use w/Thrust Washer Set
6	Flanged Main Brg.	FP-AR101267	STD	
6	Flanged Main Brg.	FP-AR104564	.25MM	
6	Flanged Main Brg.	FP-AR104565	.50MM	
6	Flanged Main Brg.	FP-AR104566	.75MM	
1	Thrust Washer Set	FP-AR89622	STD	
1	Thrust Washer Set	FP-AR89971	7	
QTY	OIL PUMP	PART NO.	SIZE	DESCRIPTION
1	O-Ring	FP-R495R		Ventilator tube; Rocker cover codes 1102, 1104; Smooth
1	Rect. or Square Seal	FP-R43660		Filter to housing; 6531A Engs.; w/housing marked R46424; To Ser. No. 357,083
1	Oil Press. Reg. Hsg. Gasket	FP-R49485		6531A Engs.; w/Housing marked R48349; w/one hole
1	Oil Press. Reg. Hsg. Gasket	FP-R49484		6531A Engs.; w/Housing marked R48349, R68157, R71485; w/two holes
CYLINDER COMPONENTS				
QTY	LINERS	PART NO.	SIZE	DESCRIPTION
6	Liner w/o Sealing Ring	FP-R48350		
6	Liner w/Sealing Rings	FP-R48350WS		
6	Cylinder Kit Complete	FP-CK32278350	STD	6531A Engs.; w/Block marked R48260, R72129, R80401; w/Con. Rod marked R48315, R53287, R58883, R66926
6	Cylinder Kit Complete	FP-CK63478350	STD	6531T Engs.; w/Block marked R48260, R72129, R80401; w/Con. Rod marked R48315, R53287, R58883, R66926
6	Sealing Ring, Liner	FP-R49423		
QTY	PISTONS	PART NO.	SIZE	DESCRIPTION
6	Piston Body w/o Pin	FP-AR53227		6531A Engs.
6	Piston Body w/o Pin	FP-AR66347		6531T Engs.
6	Piston Kit w/Pin & Retainers	FP-AR53227WP		6531A Engs.
6	Piston Kit w/Pin & Retainers	FP-AR66347WP		6531T Engs.
6	Piston Kit w/Ring Set	FP-AR53225		6531A Engs.
6	Piston Kit w/Ring Set	FP-AR67512		6531T Engs.
6	Pin	FP-R49418		
12	Piston Pin Retainer	FP-E1343FN		
6	Pin Bushing	FP-R76783		w/Con. Rod marked R48315, R53287, R58883, R66926; w/1.875" pin dia.; w/1.8762" ID, 2.0622" OD, 1.625" O.A.L.
QTY	CONNECTING RODS & BRGS.	PART NO.	SIZE	DESCRIPTION
12	Con. Rod Bolt	FP-R66453		w/Con. Rod marked R48315, R53287, R58883, R66926; Torque-To-Yield bolt; Replacement recommended

(continued on next page)



**Harvester 6531A, 6531T Engs. Grader 6531A, 6531T Engs. Loader 6531A, 6531T Engs. 123**  
**Wheel Tractor 6531A, 6531T Engs. Compactor 6531A, 6531T Engs. (cont.)**  
 8.7L 531 OHV Turbo-Diesel L6, 4.75" Bore

### CYLINDER COMPONENTS (cont.)

CONNECTING RODS & BRGS. (cont.)				
QTY		PART NO.	SIZE	DESCRIPTION
6	Rod Pair	FP-AR101271	STD	w/o oil hole & groove
6	Rod Pair	FP-AR104130	.25MM	w/o oil hole & groove
6	Rod Pair	FP-AR104131	.50MM	w/o oil hole & groove
6	Rod Pair	FP-AR104132	.75MM	w/o oil hole & groove
6	Rod Pair	FP-AR53020	STD	w/oil hole; w/partial groove
6	Rod Pair	FP-AR57208	10	w/oil hole; w/partial groove
6	Rod Pair	FP-AR57209	20	w/oil hole; w/partial groove
6	Rod Pair	FP-AR57210	30	w/oil hole; w/partial groove

QTY	PISTON RINGS	PART NO.	SIZE	DESCRIPTION
6	Ring Set Single Cylinder	FP-AR53226	STD	6531A Engs.

### KITS

QTY	OVERHAUL KIT	PART NO.	SIZE	DESCRIPTION
1	In-Frame Overhaul Kit	FP-531AIFK		6531A Engs.; w/Block marked R48260, R72129, R80401; w/Con. Rod marked R48315, R53287, R58883, R66926
1	In-Frame Overhaul Kit	FP-531TIFK		6531T Engs.; w/Block marked R48260, R72129, R80401; w/Con. Rod marked R48315, R53287, R58883, R66926; Incl. Torque-To-Yield con. rod bolts
1	Complete Overhaul Kit	FP-531AOHK		6531A Engs.; w/Block marked R48260, R72129, R80401; w/Con. Rod marked R48315, R53287, R58883, R66926
1	Complete Overhaul Kit	FP-531TOHK		6531T Engs.; w/Block marked R48260, R72129, R80401; w/Con. Rod marked R48315, R53287, R58883, R66926; Incl. Torque-To-Yield con. rod bolts

**Harvester 6090H Eng. Power Unit 6090H Eng. Wheel Tractor 6090H Eng. 124**  
 9.0L 549 (9000cc) OHV Turbo-Diesel L6 (PowerTech 4V IC), 118.4mm Bore

### CYL. HEAD & PARTS

QTY	VALVE	PART NO.	SIZE	DESCRIPTION
12	Intake	FP-R520223	STD	1 groove; Chrome plated stem; 1.5748" Head Dia., .3142" Stem Dia., 6.4154" O.A.L.
12	Exhaust	FP-R520224	STD	1 groove; Inconel X-751; Chrome plated stem; 1.5748" Head Dia., .3142" Stem Dia., 6.4201" O.A.L.
QTY	VALVE SEAT	PART NO.	SIZE	DESCRIPTION
24	Exh. & Int.	FP-R527285 *	STD	
QTY	VALVE GUIDE	PART NO.	SIZE	DESCRIPTION
24	Guide	FP-R527286 *		
QTY	VALVE SPRING	PART NO.	SIZE	DESCRIPTION
24	Spring	FP-R504235		

### CAMSHAFT GROUP

QTY	CAMSHAFT/LIFTER	PART NO.	SIZE	DESCRIPTION
1	Camshaft Plug	FP-R82007		

### ENGINE BLOCK & PARTS

QTY	CAM BEARINGS	PART NO.	SIZE	DESCRIPTION
6	Cam Brg.	FP-R527877 *	STD	

### CRANKSHAFT/OIL PUMP

QTY	MAIN BEARINGS	PART NO.	SIZE	DESCRIPTION
6	Plain Main Brg.	FP-RE529319	STD	
1	Flanged Main Brg.	FP-RE529320	STD	
QTY	OIL PUMP	PART NO.	SIZE	DESCRIPTION
1	Oil Pump Intake Gasket	FP-R100569		

### CYLINDER COMPONENTS

QTY	LINERS	PART NO.	SIZE	DESCRIPTION
6	Cyl. Liner Sealing Ring Kit	FP-AR98850		
QTY	PISTONS	PART NO.	SIZE	DESCRIPTION
6	Pin	FP-R517073 *	STD	
6	Pin Bushing	FP-R74008		1.877" ID, 2.0622 OD, 1.8728" O.A.L.
QTY	CONNECTING RODS & BRGS.	PART NO.	SIZE	DESCRIPTION
12	Con. Rod Bolt	FP-R501035		Fractured split rod

(continued on next page)

**124 Harvester 6090H Eng. Power Unit 6090H Eng. Wheel Tractor 6090H Eng.**  
 (cont.) 9.0L 549 (9000cc) OHV Turbo-Diesel L6 (PowerTech 4V IC), 118.4mm Bore

**CYLINDER COMPONENTS (cont.)**

QTY	CONNECTING RODS & BRGS. (cont.)	PART NO.	SIZE	DESCRIPTION
6	Rod Pair	FP-RE529318 *	STD	
QTY	PISTON RINGS	PART NO.	SIZE	DESCRIPTION
6	Ring Set Single Cylinder	FP-RE531077 *	STD	

**125 Harvester 6090A Eng. Power Unit 6090A Eng. Wheel Tractor 6090A Eng.**  
 9.0L 549 (9000cc) OHV Turbo-Diesel L6 (PowerTech 4V AC), 118.4mm Bore

**CYL. HEAD & PARTS**

QTY	VALVE	PART NO.	SIZE	DESCRIPTION
12	Intake	FP-R520223	STD	1 groove; Chrome plated stem; 1.5748" Head Dia., .3142" Stem Dia., 6.4154" O.A.L.
12	Exhaust	FP-R520224	STD	1 groove; Inconel X-751; Chrome plated stem; 1.5748" Head Dia., .3142" Stem Dia., 6.4201" O.A.L.
QTY	VALVE SEAT	PART NO.	SIZE	DESCRIPTION
24	Exh. & Int.	FP-R527285 *	STD	
QTY	VALVE GUIDE	PART NO.	SIZE	DESCRIPTION
24	Guide	FP-R527286 *		
QTY	VALVE SPRING	PART NO.	SIZE	DESCRIPTION
24	Spring	FP-R504235		

**CAMSHAFT GROUP**

QTY	CAMSHAFT/LIFTER	PART NO.	SIZE	DESCRIPTION
1	Camshaft Plug	FP-R82007		

**ENGINE BLOCK & PARTS**

QTY	CAM BEARINGS	PART NO.	SIZE	DESCRIPTION
6	Cam Brg.	FP-R527877 *	STD	

**CRANKSHAFT/OIL PUMP**

QTY	MAIN BEARINGS	PART NO.	SIZE	DESCRIPTION
6	Plain Main Brg.	FP-RE529319	STD	
1	Flanged Main Brg.	FP-RE529320	STD	
QTY	OIL PUMP	PART NO.	SIZE	DESCRIPTION
1	Oil Pump Intake Gasket	FP-R100569		

**CYLINDER COMPONENTS**

QTY	LINERS	PART NO.	SIZE	DESCRIPTION
6	Cyl. Liner Sealing Ring Kit	FP-AR98850		
QTY	PISTONS	PART NO.	SIZE	DESCRIPTION
6	Pin	FP-R517073 *	STD	
6	Pin Bushing	FP-R74008		1.877" ID, 2.0622 OD, 1.8728" O.A.L.
QTY	CONNECTING RODS & BRGS.	PART NO.	SIZE	DESCRIPTION
12	Con. Rod Bolt	FP-R501035		Fractured split rod
6	Rod Pair	FP-RE529318 *	STD	
QTY	PISTON RINGS	PART NO.	SIZE	DESCRIPTION
6	Ring Set Single Cylinder	FP-RE531077 *	STD	

**126 Harvester 6090T Eng. Power Unit 6090T Eng. Wheel Tractor 6090T Eng.**  
 9.0L 549 (9000cc) OHV Turbo-Diesel L6 (PowerTech 4V), 118.4mm Bore

**CYL. HEAD & PARTS**

QTY	VALVE	PART NO.	SIZE	DESCRIPTION
12	Intake	FP-R520223	STD	1 groove; Chrome plated stem; 1.5748" Head Dia., .3142" Stem Dia., 6.4154" O.A.L.
12	Exhaust	FP-R520224	STD	1 groove; Inconel X-751; Chrome plated stem; 1.5748" Head Dia., .3142" Stem Dia., 6.4201" O.A.L.
QTY	VALVE SEAT	PART NO.	SIZE	DESCRIPTION
24	Exh. & Int.	FP-R527285 *	STD	
QTY	VALVE GUIDE	PART NO.	SIZE	DESCRIPTION
24	Guide	FP-R527286 *		
QTY	VALVE SPRING	PART NO.	SIZE	DESCRIPTION
24	Spring	FP-R504235		

(continued on next page)



# John Deere Off Highway

*Harvester 6090T Eng. Power Unit 6090T Eng. Wheel Tractor 6090T Eng. 126*  
 9.0L 549 (9000cc) OHV Turbo-Diesel L6 (PowerTech 4V), 118.4mm Bore (cont.)

<b>CAMSHAFT GROUP</b>				
QTY	CAMSHAFT/LIFTER	PART NO.	SIZE	DESCRIPTION
1	Camshaft Plug	FP-R82007		
<b>ENGINE BLOCK &amp; PARTS</b>				
QTY	CAM BEARINGS	PART NO.	SIZE	DESCRIPTION
6	Cam Brg.	FP-R527877 *	STD	
<b>CRANKSHAFT/OIL PUMP</b>				
QTY	MAIN BEARINGS	PART NO.	SIZE	DESCRIPTION
6	Plain Main Brg.	FP-RE529319	STD	
1	Flanged Main Brg.	FP-RE529320	STD	
QTY	OIL PUMP	PART NO.	SIZE	DESCRIPTION
1	Oil Pump Intake Gasket	FP-R100569		
<b>CYLINDER COMPONENTS</b>				
QTY	LINERS	PART NO.	SIZE	DESCRIPTION
6	Cyl. Liner Sealing Ring Kit	FP-AR98850		
QTY	PISTONS	PART NO.	SIZE	DESCRIPTION
6	Pin	FP-R517073 *	STD	
6	Pin Bushing	FP-R74008		1.877" ID, 2.0622 OD, 1.8728" O.A.L.
QTY	CONNECTING RODS & BRGS.	PART NO.	SIZE	DESCRIPTION
12	Con. Rod Bolt	FP-R501035		Fractured split rod
6	Rod Pair	FP-RE529318 *	STD	
QTY	PISTON RINGS	PART NO.	SIZE	DESCRIPTION
6	Ring Set Single Cylinder	FP-RE531077 *	STD	
<p><i>Combine 6619A, 6619T Engs. Harvester 6619A, 6619T Engs. Scraper 6619A, 6619T Engs. 127</i>  <i>Wheel Tractor 6619A, 6619T Engs. Windrower 6619A, 6619T Engs. Crawler Tractor 6619A,</i>  <i>6619T Engs. Excavator 6619A, 6619T Engs. Dozer 6619A, 6619T Engs. Forage Harvester</i>  <i>6619A, 6619T Engs.</i>            10.1L 619 OHV Turbo-Diesel L6, 5.125" Bore</p>				
<b>CYL. HEAD &amp; PARTS</b>				
QTY	GASKETS	PART NO.	SIZE	DESCRIPTION
1	Valve Cover Gasket	FP-R74365		6619A Engs.; Rocker arm cover codes 1102, 1104; To Ser. No. 50,465
1	Head Gasket	FP-RE34009		
1	Head Set	FP-RE37417		
1	Ventilator Housing Gasket	FP-R49492		
QTY	VALVE	PART NO.	SIZE	DESCRIPTION
6	Intake	FP-R75690		Chrome plated stem; 2.0310" Head Dia., .4341" Stem Dia., 6.6620" O.A.L.
6	Exhaust	FP-R63982		1.8750" Head Dia., .4341" Stem Dia., 6.6550" O.A.L.
12	Valve Stem Cap	FP-R40366		Exh. & Int.; From Ser. No. 21,562
24	Keeper	FP-R35431		Exh. & Int.
QTY	VALVE SEAT	PART NO.	SIZE	DESCRIPTION
6	Exh.	FP-R60537	STD	
6	Int.	FP-R59894	STD	
QTY	VALVE GUIDE	PART NO.	SIZE	DESCRIPTION
12	Guide	FP-R53192		.4375" ID, 3.1880" O.A.L.
QTY	VALVE SPRING	PART NO.	SIZE	DESCRIPTION
6	Spring	FP-R49569		Inner
6	Spring	FP-R49571		Outer; 2.5200" Free Height
QTY	VALVE MISC.	PART NO.	SIZE	DESCRIPTION
12	Rotocap	FP-R81086		Exh. & Int.
1	Oil Filler Cap Gasket	FP-T20328		Rocker arm cover code 1104; Oil filler neck code 1201
<b>ELECTRICAL</b>				
QTY	ALTERNATOR	PART NO.	SIZE	DESCRIPTION
1	Ball Brg.	FP-JD9449		Front; 6619A Engs.; Delco-Remy No. 1105510; 24 Volt, 40 amp alternator
1	Ball Brg.	FP-JD9449		Front; 6619A Engs.; Delco-Remy Nos. 1101268, 1101345, 1102932, 1103128, 1105174; Code 3103; 12 Volt, 72 amp alternator

(continued on next page)

\* New Item — Check For Availability

**127** Combine 6619A, 6619T Engs. Harvester 6619A, 6619T Engs. Scraper 6619A, 6619T Engs. (cont.) Wheel Tractor 6619A, 6619T Engs. Windrower 6619A, 6619T Engs. Crawler Tractor 6619A, 6619T Engs. Excavator 6619A, 6619T Engs. Dozer 6619A, 6619T Engs. Forage Harvester 6619A, 6619T Engs.

10.1L 619 OHV Turbo-Diesel L6, 5.125" Bore

## ELECTRICAL (cont.)

QTY	ALTERNATOR (cont.)	PART NO.	SIZE	DESCRIPTION
1	Ball Brg.	FP-JD9449		Front; 6619A Engs.; Motorola No. 70D42076T02; Code 3101; 12 Volt, 65 amp alternator
1	Ball Brg.	FP-JD9449		Front; 6619A Engs.; Motorola Remanufactured; Code 3102; 12 Volt, 51 amp alternator; 55 amp alternator
2	Ball Brg.	FP-JD9449		Front & Rear; 6619A Engs.; Motorola No. 70D42179T02; 24 Volt, 45 amp alternator; To Ser. No. 59,456

## METERS

QTY	METERS	PART NO.	SIZE	DESCRIPTION
1	Speed/Hour Meter Gasket	FP-R62410		6619A Engs.; Tach. drive codes 3300, 3303; From Ser. No. 46,656
1	Speed/Hour Meter Gasket	FP-R44853		6619A Engs.; Tach. drive codes 3300, 3303; To Ser. No. 46,655
1	Speed/Hour Meter Gasket	FP-R62410		6619T Engs.; Cover plate gskt.

## INT & EXH MANIFOLDS

QTY	INT. & EXH. MANIFOLDS	PART NO.	SIZE	DESCRIPTION
2	Exhaust Manifold Gasket	FP-R80970		6619A Engs.; Exh. manifold codes 2802, 2803, 6401, 6403; To Ser. No. 60,152; 1 Hole
2	Exhaust Manifold Gasket	FP-R80969		6619A Engs.; 2 Holes
2	Exhaust Manifold Gasket	FP-R80970		6619T Engs.; To Ser. No. 60,152; 1 Hole
2	Exhaust Manifold Gasket	FP-R80969		6619T Engs.; To Ser. No. 60,152; 2 Holes
3	Intake Manifold Gasket	FP-R40088		Two Int. holes

## CAMSHAFT GROUP

QTY	CAMSHAFT/LIFTER	PART NO.	SIZE	DESCRIPTION
1	Camshaft Plug	FP-R26115		

## FUEL SYSTEM & PARTS

QTY	FUEL INJECTION	PART NO.	SIZE	DESCRIPTION
1	Injector Pump Gasket	FP-R35349		6619A Engs.; Gear cover
1	Injector Pump Gasket	FP-R35349		6619T Engs.; Gear cover; w/Cover marked R55506
12	Washer	FP-R48693		Inj. leak-off screw
6	Washer	FP-R64840		6619A Engs.; Injector nozzle; Nozzle codes 1601, 1606, 1608, 1610; From Ser. No. 50,465; Steel
6	Washer	FP-R64840		6619A Engs.; Injector nozzle; Nozzle codes 1601, 1606, 1637; To Ser. No. 27,969; Steel
6	Washer	FP-R64840		6619A Engs.; Injector nozzle; Nozzle codes 1606, 1608; From Ser. No. 27,970 to Ser. No. 50,464; Steel
6	Washer	FP-R64840		6619T Engs.; Steel
6	Fuel Injector Nut	FP-R79604		Injection pump; Line codes 1601, 1608, 1610, 1637
19	Clamp	FP-R34766		6619A Engs.; Pump codes 1601, 1606; To Ser. No. 27,969
6	Fuel Line Connector Gasket	FP-R59294		6619A Engs.; Leak-off connector washer; w/Connector R59293, R77850, R83558; Alum.
12	Washer Type Seal	FP-R51936		6619A Engs.; Leak-off & return line seals; Pump codes 1601, 1606, 1608, 1610, 1637
12	Washer Type Seal	FP-R51936		6619T Engs.; Leak-off & return line seals

QTY	FUEL FILTERS & PUMP	PART NO.	SIZE	DESCRIPTION
6	O-Ring	FP-R51603		Fuel nozzle; w/Bosch injector
1	O-Ring	FP-R375R		Fuel check valve seal

QTY	TURBOCHARGER	PART NO.	SIZE	DESCRIPTION
1	Turbocharger Oil Drain Gasket	FP-R75691		6619A Engs.; w/Turbo oil line codes 6501, 6502
1	Turbocharger Oil Drain Gasket	FP-R75691		6619T Engs.; w/Turbo oil line code 6503
1	Turbocharger Mounting Gasket	FP-R49697		
1	O-Ring	FP-R57517		6619A Engs.; Manifold to turbo coupling seal; Int. manifold codes 2802, 2803
1	O-Ring	FP-R57517		6619T Engs.; Manifold to turbo coupling seal
1	O-Ring	FP-R49424		Outer coupling; Manifold codes 2802, 2803
1	Turbocharger Oil Supply Gskt.	FP-R58222		6619A Engs.; Turbo codes 6501, 6502
1	Turbocharger Oil Supply Gskt.	FP-R58222		6619T Engs.; Turbo code 6503

## COOLING SYSTEM

QTY	WATER PUMP	PART NO.	SIZE	DESCRIPTION
1	Water Pump Shaft	FP-R82053		6619A Engs.; w/Pump housing marked R65237
1	Water Pump Shaft	FP-R82051		6619A Engs.; w/Pump housing marked R67350, R74445, R86780, R98303, R104709

(continued on next page)



# John Deere Off Highway

Combine 6619A, 6619T Engs. Harvester 6619A, 6619T Engs. Scraper 6619A, 6619T Engs. **127**  
 Wheel Tractor 6619A, 6619T Engs. Windrower 6619A, 6619T Engs. Crawler Tractor 6619A, (cont.)  
 6619T Engs. Excavator 6619A, 6619T Engs. Dozer 6619A, 6619T Engs. Forage Harvester  
**6619A, 6619T Engs.**  
 10.1L 619 OHV Turbo-Diesel L6, 5.125" Bore

COOLING SYSTEM (cont.)				
QTY	WATER PUMP (cont.)	PART NO.	SIZE	DESCRIPTION
1	Water Pump Shaft	FP-R82052		6619T Engs.; w/Pump housing marked R66661
1	Water Pump Impeller	FP-R135265		6619A Engs.; w/Pump housing marked R124057
1	Water Pump Impeller	FP-R82050		6619A Engs.; w/Pump housing marked R74445, R86780, R104709
1	Water Pump Impeller	FP-R84180		6619A Engs.; Pump code 2025; w/Pump housing marked R23992
1	Water Pump Repair/Rebuild Kit	FP-RE69842		w/Pump housing marked R65237
1	Water Pump Repair/Rebuild Kit	FP-RE69841		w/Pump housing marked R66661
1	Water Pump Repair/Rebuild Kit	FP-RE69845		w/Pump housing marked R67350
1	Water Pump Repair/Rebuild Kit	FP-RE68319		Pump code 2025; w/Pump housing marked R74445, R86780, R104709
1	Water Pump Repair/Rebuild Kit	FP-RE69840		6619A Engs.; w/Pump housing marked R48818, R58705, R124257; From Ser. No. 35,958
1	Water Pump Repair/Rebuild Kit	FP-RE69927		6619A Engs.; w/Pump housing marked R74445, R86780, R104709
1	Water Pump Housing Gasket	FP-R99785		6619A Engs.; w/H/D water pump; w/Pump housing marked R74445, R86780, R104709
1	Water Pump Housing Gasket	FP-R69415		6619A Engs.; w/Pump housing marked R58705
1	Water Pump Housing Gasket	FP-R66093		6619T Engs.; w/Pump marked R66661
1	Oil Seal Kit	FP-RE68318		6619A Engs.; w/Pump housing marked R74445, R86760, R104709, R124057; From Ser. No. 39,358
1	Water Pump Mounting Gasket	FP-R49495		w/H/D water pump; w/Pump housing marked R74445, R86780, R104709
1	Water Pump Mounting Gasket	FP-R49495		w/Pump housing marked R58705, R124057
1	Oil Seal	FP-RE20768		6619A Engs.; Front pump bearing seal; w/Pump housing marked R74445, R86780, R104709
1	Oil Seal	FP-AR90860		6619A Engs.; Pump code 2003; w/H/D water pump
1	Oil Seal	FP-RE20767		6619A Engs.; Rear pump bearing seal; w/Pump housing marked R74445, R86780, R104709
1	O-Ring	FP-R72328		6619A Engs.; Turbo line codes 6501, 6502, 6503
1	O-Ring	FP-R72328		6619T Engs.; Turbo line code 6503
1	Shaft & Bearing Assembly	FP-AU43144		6619A Engs.; w/Pump housing marked R124057
QTY	THERMOSTAT	PART NO.	SIZE	DESCRIPTION
3	Thermostat	FP-AR72852		6619A Engs.; Thermostat code 2204; Thermostat housing code 3903; Housing marked R57513; 192 Deg.
3	Thermostat	FP-AR48675		6619A Engs.; Thermostat housing code 3903; Housing marked R57513; 180 Deg.
3	Thermostat	FP-AR48675		6619T Engs.; 180 Deg.
3	Thermostat	FP-AR72852		6619T Engs.; 192 Deg.
1	Thermostat Gasket	FP-R81274		w/3 thermostats
QTY	MISCELLANEOUS	PART NO.	SIZE	DESCRIPTION
2	Water Manifold Mounting Gskt.	FP-R88397		
ENGINE BLOCK & PARTS				
QTY	GASKETS	PART NO.	SIZE	DESCRIPTION
1	Front Cover Gasket	FP-R49483		w/Timing gear cover marked R77301
1	Front Cover Gasket	FP-R49483		6619A Engs.; w/Timing gear cover marked R48835, R67342, R110147
1	Oil Pan Gasket	FP-R71919		6619A Engs.
1	Oil Pan Gasket Set	FP-PG501PS		w/Crankshaft driven oil pump; w/Cast iron oil pan.; From Ser. No. 020,331
1	Oil Pan Gasket Set	FP-PG500PS		w/Crankshaft driven oil pump; w/Cast Iron oil pan; Thin gskt.
QTY	GASKET SETS	PART NO.	SIZE	DESCRIPTION
1	In-Frame Gasket Set	FP-PG619S		
1	Complete Overhaul Gasket Set	FP-RE37416		Crankshaft seals not incl.
1	Complete Overhaul Gasket Set	FP-RE37416WS		6619A Engs.; Crankshaft seals incl.
QTY	CAM BEARINGS	PART NO.	SIZE	DESCRIPTION
1	Cam Set	FP-4R46903	STD	
4	Cam Brg.	FP-R46903	STD	
QTY	OIL COOLERS & FILTERS	PART NO.	SIZE	DESCRIPTION
1	Aftercooler Gasket Set	FP-500A		6619A Engs.
2	Aftercooler Housing Gasket	FP-R53081		6619A Engs.
1	O-Ring	FP-R47153		Cooler tube
2	O-Ring	FP-R47153		Water manifold; 6619A Engs.; Water manifold codes 2802, 2803

(continued on next page)

# John Deere Off Highway



**127** Combine 6619A, 6619T Engs. Harvester 6619A, 6619T Engs. Scraper 6619A, 6619T Engs. Wheel Tractor 6619A, 6619T Engs. Windrower 6619A, 6619T Engs. Crawler Tractor 6619A, 6619T Engs. Excavator 6619A, 6619T Engs. Dozer 6619A, 6619T Engs. Forage Harvester 6619A, 6619T Engs.

10.1L 619 OHV Turbo-Diesel L6, 5.125" Bore

## ENGINE BLOCK & PARTS (cont.)

OIL COOLERS & FILTERS				
QTY	(cont.)	PART NO.	SIZE	DESCRIPTION
2	Oil Cooler Housing Gasket	FP-R57504		
1	Oil Cooler Top Gasket	FP-R49491		Oil cooler to regulator housing front
1	Oil Cooler Top Gasket	FP-R49490		Oil cooler to regulator housing rear
CRANKSHAFT/OIL PUMP				
QTY	CRANKSHAFT	PART NO.	SIZE	DESCRIPTION
1	Crankshaft	FP-AR92533		6619A Engs.; From Ser. No. 33,814; Crankshaft marked R63476, AR78403
1	Oil Seal Kit	FP-SK13310		Incl. Seal & Wear sleeve
QTY	SEALS - FRONT CRANK	PART NO.	SIZE	DESCRIPTION
1	Oil Seal Kit	FP-AR49025		
QTY	SEALS - REAR CRANK	PART NO.	SIZE	DESCRIPTION
1	Oil Seal	FP-RE13310		
1	Crankshaft Rear Housing Gskt.	FP-R35043		
QTY	MAIN BEARINGS	PART NO.	SIZE	DESCRIPTION
1	Main Set	FP-MBK531	STD	
1	Main Set	FP-MBK53110	10	
1	Main Set	FP-MBK53120	20	
1	Main Set	FP-MBK53130	30	
1	Main Set	FP-MBK619	STD	w/partial groove lower brg.
1	Main Set	FP-MBK61910	10	w/partial groove lower brg.
1	Main Set	FP-MBK61920	20	w/partial groove lower brg.
1	Main Set	FP-MBK61930	30	w/partial groove lower brg.
6	Plain Main Brg.	FP-AR101266	STD	
6	Plain Main Brg.	FP-AR104568	.25MM	
6	Plain Main Brg.	FP-AR104569	.50MM	
6	Plain Main Brg.	FP-AR104570	.75MM	
6	Plain Main Brg.	FP-AR101268	STD	w/partial groove lower brg.
6	Plain Main Brg.	FP-AR104122	.25MM	w/partial groove lower brg.
6	Plain Main Brg.	FP-AR104123	.50MM	w/partial groove lower brg.
6	Plain Main Brg.	FP-AR104124	.75MM	w/partial groove lower brg.
1	Plain Main Brg.	FP-AR101269	STD	w/partial groove lower brg.; Use w/Thrust Washer Set
1	Plain Main Brg.	FP-AR104126	.25MM	w/partial groove lower brg.; Use w/Thrust Washer Set
1	Plain Main Brg.	FP-AR104127	.50MM	w/partial groove lower brg.; Use w/Thrust Washer Set
1	Plain Main Brg.	FP-AR104128	.75MM	w/partial groove lower brg.; Use w/Thrust Washer Set
6	Flanged Main Brg.	FP-AR101267	STD	
6	Flanged Main Brg.	FP-AR104564	.25MM	
6	Flanged Main Brg.	FP-AR104565	.50MM	
6	Flanged Main Brg.	FP-AR104566	.75MM	
1	Thrust Washer Set	FP-AR89622	STD	
1	Thrust Washer Set	FP-AR89971	7	
QTY	OIL PUMP	PART NO.	SIZE	DESCRIPTION
2	O-Ring	FP-R71732		6619A Engs.; Pump outlet tube; Pump code 1901; w/Pump marked R69946; w/Cast iron oil pan; From Ser. No. 46,656 to Ser. No. 61,565
2	O-Ring	FP-R71732		6619A, 6619T Engs.; Pump outlet tube; w/Pump marked R69946; To Ser. No. 46,655
1	O-Ring	FP-R495R		Ventilator tube; 6619A Engs.; Smooth
1	Oil Pump Intake Gasket	FP-R100569		w/Oil pump housing marked R62946; Oil pump pickup codes 1901, 1906
1	Oil Pump Intake Gasket	FP-R74464		6619T Engs.; Pick-up screen; w/Alum. oil pan
1	Rect. or Square Seal	FP-R43660		Filter to housing; w/housing marked R48349, R68157, R71485
1	Oil Pump to Block Gasket	FP-R69418		
1	Oil Pump Intake Elbow Gasket	FP-R71312		6619T Engs.; w/Alum. oil pan; Oil pan code 1916
1	Oil Press. Reg. Hsg. Gasket	FP-R49485		w/Housing marked R48349, R68157, R71485; w/one hole
1	Oil Filter Body Gasket	FP-R82943		Timing gear cover code 1299; Filter code 1201
1	Pick-Up Tube Gasket	FP-R70475		Oil pump code 1901; w/Cast iron oil pan; To Ser. No. 20,330
CYLINDER COMPONENTS				
QTY	LINERS	PART NO.	SIZE	DESCRIPTION
6	Liner w/o Sealing Ring	FP-R77640		From Ser. No. 49,060
6	Liner w/o Sealing Ring	FP-R65629		To Ser. No. 49,059
6	Liner w/Sealing Rings	FP-R77640WS		From Ser. No. 49,060

(continued on next page)



# John Deere Off Highway

Combine 6619A, 6619T Engs. Harvester 6619A, 6619T Engs. Scraper 6619A, 6619T Engs. **127**  
 Wheel Tractor 6619A, 6619T Engs. Windrower 6619A, 6619T Engs. Crawler Tractor 6619A, (cont.)  
 6619T Engs. Excavator 6619A, 6619T Engs. Dozer 6619A, 6619T Engs. Forage Harvester  
**6619A, 6619T Engs.**  
 10.1L 619 OHV Turbo-Diesel L6, 5.125" Bore

## CYLINDER COMPONENTS (cont.)

QTY	LINEARS (cont.)	PART NO.	SIZE	DESCRIPTION
6	Liner w/Sealing Rings	FP-R65629WS		To Ser. No. 49,059
6	Cylinder Kit Complete	FP-AR84089		w/Block marked R57424, R63199, R65628, R69312, R72130, R74123; w/Con. Rod marked R57484, R66925; To Ser. No. 33,814
6	Cylinder Kit Complete	FP-RE20291	STD	w/Block marked R57424, R63199, R65628, R69312, R72130, R74123; w/Con. Rod marked R63959; From Ser. No. 33,815 to Ser. No. 49,059
6	Cylinder Kit Complete	FP-RE40476		w/Block marked R75934, R87752, R88217; w/Con. Rod marked R63959; From Ser. No. 49,060
6	Cyl. Liner Sealing Ring Kit	FP-AR72351		
QTY	PISTONS	PART NO.	SIZE	DESCRIPTION
6	Piston Body w/o Pin	FP-RE42231		From Ser. No. 33,815
6	Piston Body w/o Pin	FP-AR69038		To Ser. No. 33,814
6	Piston Kit w/Pin & Retainers	FP-RE42231WP		From Ser. No. 33,815
6	Piston Kit w/Pin & Retainers	FP-AR69038WP		To Ser. No. 33,814
6	Pin	FP-R64451		
12	Piston Pin Retainer	FP-N51168		
6	Pin Bushing	FP-3819Y20		w/Con. Rod marked R63959; w/1.999" ID, w/2.187" OD, 2.0512 O.A.L.
6	Pin Bushing	FP-R69045		w/Con. Rod marked R63959; w/1.999" ID, w/2.187" OD, 2.0512" O.A.L.
6	Pin Bushing	FP-R60197		To Ser. No. 33,814; w/Con. Rod marked R57484, R66925; w/1.9987" ID, 2.1872" OD, 2.029" O.A.L.
QTY	CONNECTING RODS & BRGS.	PART NO.	SIZE	DESCRIPTION
12	Con. Rod Bolt	FP-R66453		w/Con. Rod marked R57484, R66925; To Ser. No. 33,814; Torque-To-Yield bolt; Replacement recommended
12	Con. Rod Bolt	FP-R66453		w/Con. Rod marked R63959; From Ser. No. 33,815; Torque-To-Yield bolt; Replacement recommended
6	Rod Pair	FP-AR101271	STD	w/o oil hole & groove
6	Rod Pair	FP-AR104130	.25MM	w/o oil hole & groove
6	Rod Pair	FP-AR104131	.50MM	w/o oil hole & groove
6	Rod Pair	FP-AR104132	.75MM	w/o oil hole & groove
6	Rod Pair	FP-AR53020	STD	w/oil hole; w/partial groove
6	Rod Pair	FP-AR57208	10	w/oil hole; w/partial groove
6	Rod Pair	FP-AR57209	20	w/oil hole; w/partial groove
6	Rod Pair	FP-AR57210	30	w/oil hole; w/partial groove
QTY	PISTON RINGS	PART NO.	SIZE	DESCRIPTION
6	Ring Set Single Cylinder	FP-AR82355	STD	
KITS				
QTY	OVERHAUL KIT	PART NO.	SIZE	DESCRIPTION
1	In-Frame Overhaul Kit	FP-619EIFK		w/Block marked R57424, R63199, R65628, R69312, R72130, R74123; w/Con. Rod marked R57484, R66925; To Ser. No. 33,814; Incl. Torque-To-Yield con. rod bolts
1	In-Frame Overhaul Kit	FP-619MIFK		w/Block marked R57424, R63199, R65628, R69312, R72130, R74123; w/Con. Rod marked R63959; From Ser. No. 33,815 to Ser. No. 49,059; Incl. Torque-To-Yield con. rod bolts
1	In-Frame Overhaul Kit	FP-619LIFK		w/Block marked R75934, R87752, R88217; w/Con. Rod marked R63959; From Ser. No. 49,060; Incl. Torque-To-Yield con. rod bolts
1	Complete Overhaul Kit	FP-619EOHK		w/Block marked R57424, R63199, R65628, R69312, R72130, R74123; w/Con. Rod marked R57484, R66925; To Ser. No. 33,814; Incl. Torque-To-Yield con. rod bolts
1	Complete Overhaul Kit	FP-619MOHK		w/Block marked R57424, R63199, R65628, R69312, R72130, R74123; w/Con. Rod marked R63959; From Ser. No. 33,815 to Ser. No. 49,059; Incl. Torque-To-Yield con. rod bolts
1	Complete Overhaul Kit	FP-619LOHK		w/Block marked R75934, R87752, R88217; w/Con. Rod marked R63959; From Ser. No. 49,060; Incl. Torque-To-Yield con. rod bolts

## 128 Wheel Tractor 6105A, 6105T Engs. Crawler Tractor 6105A, 6105T Engs. 10.5L 639.5 (10483cc) OHV Turbo-Diesel L6 (PowerTech), 127mm Bore

CYL. HEAD & PARTS				
QTY	VALVE	PART NO.	SIZE	DESCRIPTION
48	Keeper	FP-R91889		6105A Engs.
FUEL SYSTEM & PARTS				
QTY	TURBOCHARGER	PART NO.	SIZE	DESCRIPTION
1	Turbocharger Oil Drain Gasket	FP-R105346		6105A Engs.; w/Turbo oil line codes 6501, 6502, 6503, 6504, 6505, 6506
1	Turbocharger Mounting Gasket	FP-R49697		6105A Engs.
COOLING SYSTEM				
QTY	WATER PUMP	PART NO.	SIZE	DESCRIPTION
2	Ball Brg.	FP-JD10329		6105A Engs.; Fan hub shaft bearing; Code 2303
1	Ball Brg.	FP-JD10362		Front; 6105A Engs.; Water Pump bearing; Code 2001
1	Ball Brg.	FP-JD10363		Rear; 6105A Engs.; Water Pump bearing; Code 2001
1	Oil Seal	FP-RE39134		6105A Engs.; Water pump code 2001
1	Oil Seal	FP-RE39134		6105A Engs.; Rear water pump seal; Water pump code 2001
QTY	THERMOSTAT	PART NO.	SIZE	DESCRIPTION
1	Thermostat	FP-RE33705		Upper; 6105A Engs.; 180 Deg.
CRANKSHAFT/OIL PUMP				
QTY	SEALS - FRONT CRANK	PART NO.	SIZE	DESCRIPTION
1	Oil Seal	FP-RE20768		6105A Engs.; Fan hub shaft seal; w/Pump housing marked R129075
QTY	SEALS - REAR CRANK	PART NO.	SIZE	DESCRIPTION
1	Crankshaft Rear Housing Gskt.	FP-R35043		6105A Engs.
CYLINDER COMPONENTS				
QTY	LINERS	PART NO.	SIZE	DESCRIPTION
6	Cyl. Liner Sealing Ring Kit	FP-AR72351		Piston, Con. Rod, Cyl. liner codes 6105, 6125; w/Liner marked RE66125
QTY	PISTONS	PART NO.	SIZE	DESCRIPTION
6	Pin	FP-R64451		Piston, Con. Rod, Cyl. liner codes 6105, 6125
12	Piston Pin Retainer	FP-N51168		Piston, Con. Rod, Cyl. liner codes 6105, 6125
6	Pin Bushing	FP-R69045		w/1.999" ID, w/2.187" OD, 2.0512" O.A.L.
QTY	CONNECTING RODS & BRGS.	PART NO.	SIZE	DESCRIPTION
12	Con. Rod Bolt	FP-R66453		Piston, Con. Rod, Cyl. liner codes 6105, 6125; w/Rod marked R121174; Torque-To-Yield bolt; Replacement recommended

## 129 Wheel Tractor 6125T Eng. Crawler Tractor 6125T Eng. 12.5L 764.6 (12534cc) OHV Turbo-Diesel L6 (PowerTech), 127mm Bore

CYL. HEAD & PARTS				
QTY	VALVE	PART NO.	SIZE	DESCRIPTION
48	Keeper	FP-R91889		
CAMSHAFT GROUP				
QTY	TIMING	PART NO.	SIZE	DESCRIPTION
1	Idler Sprocket/Gear Bushing	FP-R533789		
FUEL SYSTEM & PARTS				
QTY	TURBOCHARGER	PART NO.	SIZE	DESCRIPTION
1	Turbocharger Oil Drain Gasket	FP-R105346		w/Turbo oil line codes 6501, 6502, 6503, 6504, 6505, 6506
1	Turbocharger Mounting Gasket	FP-R49697		
COOLING SYSTEM				
QTY	WATER PUMP	PART NO.	SIZE	DESCRIPTION
2	Ball Brg.	FP-JD10329		Fan hub shaft bearing code 2303
1	Ball Brg.	FP-JD10362		Front; Water Pump bearing code 2001
1	Ball Brg.	FP-JD10363		Rear; Water Pump bearing code 2001
1	Oil Seal	FP-RE39134		Rear water pump seal; Water pump code 2001
QTY	THERMOSTAT	PART NO.	SIZE	DESCRIPTION
1	Thermostat	FP-RE33705		Upper; 180 Deg.
CRANKSHAFT/OIL PUMP				
QTY	SEALS - FRONT CRANK	PART NO.	SIZE	DESCRIPTION
1	Oil Seal	FP-RE20768		Fan hub shaft seal; w/Pump housing marked R104709, R124059

(continued on next page)





# John Deere Off Highway

Wheel Tractor **6125T Eng.** Crawler Tractor **6125T Eng. 129**  
 12.5L 764.6 (12534cc) OHV Turbo-Diesel L6 (PowerTech), 127mm Bore (cont.)

## CRANKSHAFT/OIL PUMP (cont.)

QTY	SEALS - REAR CRANK	PART NO.	SIZE	DESCRIPTION
1	Crankshaft Rear Housing Gskt.	FP-R35043		
CYLINDER COMPONENTS				
QTY	LINERS	PART NO.	SIZE	DESCRIPTION
6	Cyl. Liner Sealing Ring Kit	FP-AR72351		Piston, Con. Rod, Cyl. liner code 4801
QTY	PISTONS	PART NO.	SIZE	DESCRIPTION
6	Pin	FP-R64451		Piston, Con. Rod, Cyl. liner code 4801
12	Piston Pin Retainer	FP-N51168		Piston, Con. Rod, Cyl. liner code 4801
6	Pin Bushing	FP-R69045		w/Con. Rod marked R121174; w/1.999" ID, w/2.187" OD, 2.0512" O.A.L.
QTY	CONNECTING RODS & BRGS.	PART NO.	SIZE	DESCRIPTION
12	Con. Rod Bolt	FP-R66453		Piston, Con. Rod, Cyl. liner code 4801; Rod marked R121174; Torque-To-Yield bolt; Replacement recommended
6	Rod Pair	FP-RE530787 *	STD	

Harvester **6950 Eng.** Forage Harvester **6950 Eng. 130**  
 14.0L 855 OHV Turbo-Diesel L6, 5.5" Bore (Cummins Eng.)

## CYL. HEAD & PARTS

QTY	GASKETS	PART NO.	SIZE	DESCRIPTION
3	Valve Cover Gasket	FP-3066311		
QTY	HEAD BOLTS	PART NO.	SIZE	DESCRIPTION
36	Head Bolt	FP-3071161		11/16-16 X 7 1/4"
1	Washer	FP-66292		Use w/FP-210884 pipe plug; 7/8" ID
QTY	MISCELLANEOUS	PART NO.	SIZE	DESCRIPTION
6	Dowel Pin	FP-68445		
10	Pipe Plug	FP-S911B		1/8" N.P.T.
12	Bolt	FP-70772		1/4" - 20 X 1/2" Fillister machine screw
QTY	FREEZE PLUGS	PART NO.	SIZE	DESCRIPTION
10	Pipe Plug	FP-S911B		1/8" N.P.T.
QTY	VALVE	PART NO.	SIZE	DESCRIPTION
12	Intake	FP-3084045		
12	Exhaust	FP-3069672		
12	Exhaust Valve Kit	FP-3803726		
12	Intake Valve Kit	FP-3803854		
24	Keeper	FP-3072369		Exh. & Int.
QTY	VALVE GUIDE	PART NO.	SIZE	DESCRIPTION
12	Guide	FP-3064312		Int.
QTY	VALVE SPRING	PART NO.	SIZE	DESCRIPTION
24	Spring	FP-3070460		Exh. & Int.
QTY	PUSH RODS	PART NO.	SIZE	DESCRIPTION
12	Push Rod	FP-3066291		
6	Push Rod	FP-3073499		Injector push rod
QTY	VALVE MISC.	PART NO.	SIZE	DESCRIPTION
6	Bushing	FP-3058462		Exh. & Int.; Rocker arm bushing
1	Oil Filler Cap	FP-107981		
QTY	VALVE SEAL	PART NO.	SIZE	DESCRIPTION
24	Valve Stem Seal	FP-3064281		Exh. & Int.
QTY	ROCKER PARTS	PART NO.	SIZE	DESCRIPTION
3	Rocker Shaft	FP-3074375		L.H. shaft
3	Rocker Shaft	FP-3074376		R.H. shaft
3	Expansion Plug	FP-3007634		Cyl. head; .755" Dia.
6	Expansion Plug	FP-3007635		Cyl. head; 1.00" Dia.
2	Expansion Plug	FP-3007636		Cyl. head; 1.255" Dia.
6	Expansion Plug	FP-203933		Plug, rocker shaft
5	O-Ring	FP-3050667		Rocker lever housing
12	Cam Follower Roller	FP-3865237		Exh. & Int.
6	Injector Cam Roller	FP-3161423		
12	Valve Roller Pin	FP-3166428		Cam follower
18	Dowel Pin	FP-3064309		
12	Lock Screw	FP-69736		Cam follower housing

(continued on next page)

# John Deere Off Highway



**130 Harvester 6950 Eng. Forage Harvester 6950 Eng.**  
 (cont.) 14.0L 855 OHV Turbo-Diesel L6, 5.5" Bore (Cummins Eng.)

INT & EXH MANIFOLDS				
QTY	INT. & EXH. MANIFOLDS	PART NO.	SIZE	DESCRIPTION
3	Exhaust Manifold Gasket	FP-3020943		
3	Intake Manifold Gasket	FP-3008591		
2	Pipe Plug	FP-3025458		Int. manifold
QTY	AIR INTAKE	PART NO.	SIZE	DESCRIPTION
1	O-Ring	FP-3037537		Int. manifold; 9/16" Dia. ID
CAMSHAFT GROUP				
QTY	TIMING	PART NO.	SIZE	DESCRIPTION
1	Idler Shaft	FP-3066328		
QTY	CAMSHAFT TIMING	PART NO.	SIZE	DESCRIPTION
1	Woodruff Key	FP-3021601		Cam gear; 3/4"
QTY	CAMSHAFT/LIFTER	PART NO.	SIZE	DESCRIPTION
1	Camshaft Thrust Washer	FP-215233		Big Cam
1	Camshaft Thrust Washer	FP-215233		N14 Engs.
1	Camshaft Thrust Washer	FP-92351		Small Cam
ACCESSORY DRIVE				
QTY	ACCESSORY DRIVE	PART NO.	SIZE	DESCRIPTION
1	Lock Nut	FP-3012526		Accessory drive pulley; 7/8 - 14 UNF
FUEL SYSTEM & PARTS				
QTY	FUEL INJECTION	PART NO.	SIZE	DESCRIPTION
1	Bolt	FP-3000173		Retains fuel pump coupling spider; 3/8" - 16 X 1" length
2	Washer	FP-S631		Fuel line tube brace; .250" ID
1	Washer	FP-170664		Use in fuel pump coupling spider; 3/8" ID
2	Fitting	FP-181213		Fuel line fitting; 90 Deg.
6	Fuel Injector Roller Pin	FP-3166388		Injector cam follower
2	Fuel Crossover Connection	FP-147100		
QTY	FUEL FILTERS & PUMP	PART NO.	SIZE	DESCRIPTION
1	Fuel Pump Filter	FP-146483		
2	Bolt	FP-S2286		Fuel pump nameplate
6	O-Ring	FP-3070137		Injector second seal; OEM Color code Brown
6	O-Ring	FP-3007759		Injector sleeve seal
6	O-Ring	FP-3070138		Injector third seal; OEM Color code Black w/White dot
6	O-Ring	FP-3070136		Injector top seal; OEM Color code Black
1	O-Ring	FP-213079		Filter housing to fuel pump head; Large; 0.941" OD, 0.810" ID
1	O-Ring	FP-151900		Filter housing to fuel pump head; Small; 0.621" OD, 0.494" ID
1	O-Ring	FP-3037537		Fuel pump coupling nipple seal; 9/16" Dia. ID
1	O-Ring	FP-139988		Fuel pump damper cover seal; Large; 1.752" OD, 1.489" ID
1	O-Ring	FP-100099		Fuel pump damper cover seal; Small; 1.627" OD, 1.364" ID
1	O-Ring	FP-129888		Fuel pump disc valve seal
1	Fuel Pump Gasket	FP-110855		Fuel pump cover to housing
1	Dowel Pin	FP-3034438		Accessory drive shaft
1	Fuel Pump Spider Jaw Coupling	FP-3046200		
1	Fuel Pump Check Valve	FP-3033740		
1	Fuel Pump Drive Coupling Hub	FP-3000175		Jaw coupling
QTY	TURBOCHARGER	PART NO.	SIZE	DESCRIPTION
1	Turbo Ring	FP-3751948		
1	Turbo Ring	FP-3521442		Turbo impeller
2	Turbo Ring	FP-3521441		Turbo shaft
4	Snap Ring	FP-3709510		Turbo shaft
4	Nut	FP-3056158		3/8 - 24 UNF Hex. flange
1	Turbocharger Oil Drain Gasket	FP-3202117		
1	Turbocharger Mounting Gasket	FP-3069177		
1	O-Ring	FP-3084848		For air crossover tube
2	O-Ring	FP-3037537		For flex hose elbow FP-3037535; 9/16" Dia. ID
1	O-Ring	FP-3037537		For turbo bearing housing; 9/16" Dia. ID
GOVERNOR				
QTY	GOVERNOR	PART NO.	SIZE	DESCRIPTION
1	O-Ring	FP-3046201		ECM position sensor seal; O-Ring for 3/4" plug
3	O-Ring	FP-3037537		ECM pressure and temperature sensor seals; 9/16" Dia. ID
COOLING SYSTEM				
QTY	WATER PUMP	PART NO.	SIZE	DESCRIPTION
1	Water Pump - Heavy Duty	FP-3803605		
1	Water Pump Shaft	FP-3064392		

(continued on next page)

Harvester 6950 Eng. Forage Harvester 6950 Eng. **130**  
14.0L 855 OHV Turbo-Diesel L6, 5.5" Bore (Cummins Eng.) (cont.)

COOLING SYSTEM (cont.)				
QTY	WATER PUMP (cont.)	PART NO.	SIZE	DESCRIPTION
1	Water Pump Impeller	FP-3064386		
1	Water Pump Repair/Rebuild Kit	FP-3801712WO		w/o Brg. & seal
1	Water Pump Repair/Rebuild Kit	FP-3801712		w/Brg. & seal
2	Water Pump Retainer Ring	FP-S16255		Water pump brg. and idler shaft
3	Ball Brg.	FP-3064406		Water pump brg. (2) and idler shaft (1)
1	Water Pump Gasket	FP-3002385		
1	Water Pump Gasket	FP-3076522		Pump housing to block
2	Oil Seal	FP-3074482		For rear pump brg. & rear idler shaft
1	Oil Seal	FP-3038998		Water pump bearing seal
1	O-Ring	FP-145551		Idler pulley cover seal
1	Pipe Plug	FP-S911B		Aftercooler flexible hose fitting; 1/8" N.P.T.
1	Pipe Plug	FP-3013786		Thermostat housing cover; 3/8" N.P.T.
2	Pipe Plug	FP-3013786		Use to block water supply when air comp. is not in use; 3/8" N.P.T.
3	Pipe Plug	FP-S911B		Water pump pipe plugs; 1/8" N.P.T.
1	Fan Hub Spacer Gasket	FP-3005592		
1	Dowel Pin	FP-70550		Water pump dowel pin; .312 Dia. X .500 Inch Length
1	Water Pump Spacer	FP-196844		Pump shaft
1	V Belt	FP-217638		Ribbed; Multi-Groove
1	Water Pump Connection Gasket	FP-3024960		Water inlet gskt.
QTY	SEALS - FAN HUB	PART NO.	SIZE	DESCRIPTION
1	Oil Seal	FP-200307		Fan drive bearing
QTY	THERMOSTAT	PART NO.	SIZE	DESCRIPTION
1	Thermostat Gasket	FP-3064313		Thermostat housing
1	Thermostat Cover Gasket	FP-3066285		Thermostat cover
4	O-Ring	FP-109080		Aftercooler thermostat housing
3	O-Ring	FP-3037537		Thermostat housing; 9/16" Dia. ID
1	Rect. or Square Seal	FP-186780		
ENGINE BLOCK & PARTS				
QTY	GASKETS	PART NO.	SIZE	DESCRIPTION
1	Oil Pan Gasket	FP-3349820		0.79mm / 0.031" Thick; One piece gskt.
1	Washer	FP-67946		Oil drain plug seal; 1.03125" ID
3	O-Ring	FP-3046201		O-Ring for 3/4" plug
4	O-Ring	FP-3037537		9/16" Dia. ID
QTY	CAM BEARINGS	PART NO.	SIZE	DESCRIPTION
1	Cam Set	FP-3007689S	STD	Big Cam 2.500" dia.; Engs. w/2.625" cam housing
1	Cam Set	FP-3801106	STD	Big Cam 2.500" dia.; Engs. w/2.687" cam housing
QTY	OIL COOLERS & FILTERS	PART NO.	SIZE	DESCRIPTION
1	Aftercooler Gasket	FP-3069098		
1	Washer	FP-193136		Accessory drive pulley; 1.750" OD
1	Washer	FP-213082		Idler shaft; .625" OD
4	O-Ring	FP-68910		Aftercooler oil cooler tube
2	O-Ring	FP-3050667		Aftercooler water transfer fittings
1	O-Ring	FP-43463A		Aftercooler water transfer tubes
2	O-Ring	FP-109080		Oil cooler
1	O-Ring	FP-3046201		Oil cooler plug seal; O-Ring for 3/4" plug
4	O-Ring	FP-3037537		Oil cooler water plug seal; 9/16" Dia. ID
1	O-Ring	FP-3073966		Oil cooler water transfer seal
1	Gasket	FP-3072341		Oil cooler; Thermostat to oil cooler support
1	Gasket	FP-3070478		Oil filter head gskt.
1	Oil Cooler Support Gasket	FP-3070477		
QTY	FREEZE PLUGS	PART NO.	SIZE	DESCRIPTION
2	Expansion Plug	FP-205401		Use on cam follower shaft ends
1	Expansion Plug	FP-3011952		Rear; 2.625" OD
1	Pipe Plug	FP-S911B		Fan pulley; 1/8" N.P.T.
3	Pipe Plug	FP-3013786		3/8" N.P.T.
QTY	DIPSTICK	PART NO.	SIZE	DESCRIPTION
1	Dipstick	FP-216484		90" Long; Blank Universal
QTY	MISCELLANEOUS	PART NO.	SIZE	DESCRIPTION
1	Pipe Plug	FP-S911B		Fan pulley; 1/8" N.P.T.
3	Pipe Plug	FP-3013786		3/8" N.P.T.
CRANKSHAFT/OIL PUMP				
QTY	CRANKSHAFT	PART NO.	SIZE	DESCRIPTION
1	Crankshaft	FP-3064291		

(continued on next page)

# John Deere Off Highway



**130 Harvester 6950 Eng. Forage Harvester 6950 Eng.**  
 (cont.) 14.0L 855 OHV Turbo-Diesel L6, 5.5" Bore (Cummins Eng.)

## CRANKSHAFT/OIL PUMP (cont.)

QTY	DESCRIPTION	PART NO.	SIZE	DESCRIPTION
1	CRANKSHAFT (cont.) Vibration Damper	FP-217323		13.55" Dia.; Snub Nose
1	SEALS - FRONT CRANK Oil Seal	FP-3006736		
1	SEALS - REAR CRANK Oil Seal	FP-3006737		6.00" Shaft
1	Rear Cover Gasket	FP-3067616		
1	MAIN BEARINGS Main Set	FP-3801260	STD	w/partial groove brgs.; Incl. thrust washer set; Incl. thrust washers
1	Main Set	FP-3801261	10	w/partial groove brgs.; Incl. thrust washer set; Incl. thrust washers
1	Main Set	FP-3801262	20	w/partial groove brgs.; Incl. thrust washer set; Incl. thrust washers
1	Main Set	FP-3801263	30	w/partial groove brgs.; Incl. thrust washer set; Incl. thrust washers
4	Thrust Washer	FP-3067568	STD	
6	Bolt	FP-204165		Vibration damper to crankshaft; 5/8" - 18 X 1 5/8"
2	OIL PUMP Bushing	FP-69521		Drive gear shaft bushing
2	Bushing	FP-68365		Driven gear shaft bushing
1	Oil Pump Spring	FP-3010146		Press. regulator
1	O-Ring	FP-215705		Front timing cover, cam support thrust
2	O-Ring	FP-145504		Oil pump pressure regulator seals
1	O-Ring	FP-3029847		Oil suction tube seal
1	O-Ring	FP-3037537		Plug seal, front timing cover; 9/16" Dia. ID
1	Oil Pump Cover Gasket	FP-3014778		
1	Oil Pump Gasket	FP-3067613		Oil pump body to block
1	Rect. or Square Seal	FP-3034986		Oil suction tube seal
1	Gasket	FP-3067618		Front timing cover to block
1	Oil Drain Plug	FP-3055069		1" - 18 UNS
1	Oil Suction Tube Gasket	FP-157551		Oil pan
<b>CYLINDER COMPONENTS</b>				
6	LINERS Liner w/o Sealing Ring	FP-3055099	STD	Std. Liners
6	Liner w/Sealing Rings	FP-3801826	STD	Incl. (1) FP215090 crevice seal, (2) FP3032874 (Blk., middle & lower) sealing rings. Std. size, Lower Press Fit design. Replaces O.E. Nos. 3055099 & 3801826 w/seals.
6	Cylinder Kit Complete	FP-3803742	STD	
6	Cyl. Liner Sealing Ring Kit	FP-3800174		Incl. (1) FP-215090, (2) FP-3032874
6	Flange Shim	FP-3054948	20	Ring, liner seal; .020" Thick, fits Std. & 10/20 sleeves
6	Flange Shim	FP-3054948B	20	Ring, liner seal; .020" Thick, fits Std. & 10/20 sleeves; Carton of 50
6	Flange Shim	FP-30549486	20	Ring, liner seal; .020" Thick, fits Std. & 10/20 sleeves; Carton of 6
6	Flange Shim	FP-3019959	31	Ring, liner seal; .031" thick
6	Flange Shim	FP-3019960	62	Ring, liner seal; .062" thick
6	PISTONS Piston Kit w/Pin & Retainers	FP-3803741	STD	
6	Pin	FP-3064304		
12	Piston Pin Retainer	FP-3064305		
6	Piston Cooling Nozzle	FP-4058947		
6	Pin Bushing	FP-3064295		
6	O-Ring	FP-4058941		Piston cooling nozzle
12	CONNECTING RODS & BRGS. Con. Rod Bolt	FP-3349806		
6	Rod Pair	FP-3055145PR	STD	From 1991
6	Rod Pair	FP-3055146PR	10	From 1991
12	Rod Bearing Half Upper/Lower	FP-3055145	STD	
12	Rod Bearing Half Upper/Lower	FP-3055146	10	
12	Rod Bearing Half Upper/Lower	FP-3055147	20	
12	Rod Bearing Half Upper/Lower	FP-3055148	30	
6	PISTON RINGS Ring Set Single Cylinder	FP-4089489	STD	
6	Compression Ring	FP-4058967		Top ring
6	Compression Ring	FP-4058968		2nd ring
6	Oil Ring	FP-4058969		Compression ring

(continued on next page)



Harvester 6950 Eng. Forage Harvester 6950 Eng. **130**  
14.0L 855 OHV Turbo-Diesel L6, 5.5" Bore (Cummins Eng.) (cont.)

## KITS

QTY	OVERHAUL KIT	PART NO.	SIZE	DESCRIPTION
1	In-Frame Overhaul Kit	FP-IFKN14AR		Select FP-3803742 Cyl. Kit

## John Deere Industrial

### Engine Finding Index

Engine	Line No.	Engine	Line No.
.9L 53.9 L-HEAD L2 3.25" Bore (Wisconsin Eng.)	1	6.8L 413.8 (6784cc) OHV Turbo-NG L6 106mm Bore (PowerTech 2V)	24
2.9L 179 OHV Diesel L3 4.1875" Bore (Standard)	2	6.8L 413.8 (6784cc) OHV Turbo-Diesel L6 106mm Bore (PowerTech 2V)	25
2.9L 179 OHV Turbo-Diesel L3 4.1875" Bore (Standard)	3	6.8L 414 OHV Diesel L6 4.1875" Bore (Standard)	26
2.9L 179.2 (2938cc) OHV Diesel L3 106mm Bore (Litre Engine)	4	6.8L 414 OHV Turbo-Diesel L6 4.1875" Bore (Standard)	27
2.9L 179.2 (2938cc) OHV Diesel L3 106mm Bore (PowerTech 2V)	5	7.6L 466 OHV Turbo-Diesel L6 4.5625" Bore (Standard)	28
2.9L 179.2 (2938cc) OHV Turbo-Diesel L3 106mm Bore (Litre Engine)	6	7.6L 465.9 (7638cc) OHV Diesel L6 115mm Bore (Litre Engine)	29
2.9L 179.2 (2938cc) OHV Turbo-Diesel L3 106mm Bore (PowerTech 2V)	7	7.6L 465.9 (7638cc) OHV Turbo-Diesel L6 115mm Bore (Litre Engine)	30
3.9L 239 OHV Diesel L4 4.1875" Bore (Standard)	8	8.1L 495.9 (8129cc) OHV Turbo-NG L6 116mm Bore (PowerTech 2V IC)	31
3.9L 239 OHV Turbo-Diesel L4 4.1875" Bore (Standard)	9	8.1L 495.9 (8129cc) OHV Turbo-Diesel L6 116mm Bore (PowerTech 2V IC)	32
3.9L 239 (3917cc) OHV Diesel L4 106mm Bore (Litre Engine)	10	8.1L 495.9 (8129cc) OHV Turbo-Diesel L6 116mm Bore (PowerTech 2V AC)	33
3.9L 239 (3917cc) OHV Turbo-Diesel L4 106mm Bore (Litre Engine)	11	8.1L 495.9 (8129cc) OHV Turbo-Diesel L6 116mm Bore (Litre Engine)	34
4.5L 275.8 (4522cc) OHV Turbo-Diesel L4 106mm Bore (PowerTech 2V IC)	12	8.1L 495.9 (8129cc) OHV Turbo-NG L6 116mm Bore (PowerTech 2V)	35
4.5L 275.8 (4522cc) OHV Turbo-Diesel L4 106mm Bore (PowerTech 4V IC)	13	8.1L 495.9 (8129cc) OHV Turbo-Diesel L6 116mm Bore (PowerTech 2V)	36
4.5L 275.8 (4522cc) OHV Diesel L4 106mm Bore (PowerTech 2V)	14	9.0L 549 (9000cc) OHV Turbo-Diesel L6 118.4mm Bore (PowerTech 4V IC)	37
4.5L 275.8 (4522cc) OHV Turbo-Diesel L4 106mm Bore (PowerTech 2V)	15	9.0L 549 (9000cc) OHV Turbo-Diesel L6 118.4mm Bore (PowerTech 4V AC)	38
4.5L 276 OHV Diesel L4 4.1875" Bore (Standard)	16	9.0L 549 (9000cc) OHV Turbo-Diesel L6 118.4mm Bore (PowerTech 4V)	39
4.5L 276 OHV Turbo-Diesel L4 4.1875" Bore (Standard)	17	10.1L 616.7 (10109cc) OHV Diesel L6 130mm Bore (Litre Engine)	40
6.8L 413.8 (6784cc) OHV Turbo-NG L6 106mm Bore (PowerTech 2V IC)	18	10.1L 616.7 (10109cc) OHV Turbo-Diesel L6 130mm Bore (Litre Engine)	41
6.8L 413.8 (6784cc) OHV Turbo-Diesel L6 106mm Bore (PowerTech 2V IC)	19	10.1L 619 OHV Turbo-Diesel L6 5.125" Bore	42
6.8L 413.8 (6784cc) OHV Turbo-Diesel L6 106mm Bore (PowerTech 4V IC)	20	10.5L 639.5 (10483cc) OHV Turbo-Diesel L6 127mm Bore (PowerTech)	43
6.8L 413.8 (6784cc) OHV Diesel L6 106mm Bore (Litre Engine)	21	12.5L 764.6 (12534cc) OHV Turbo-Diesel L6 127mm Bore (PowerTech)	44
6.8L 413.8 (6784cc) OHV Diesel L6 106mm Bore (PowerTech 2V)	22		
6.8L 413.8 (6784cc) OHV NG L6 106mm Bore (PowerTech 2V)	23		

### Engine Code Index

Engine Code	Engine Description	Line No.	Engine Code	Engine Description	Line No.
TF ... Industrial Applications	.9L 53.9 L-HEAD L2 3.25" Bore (Wisconsin Eng.)	1	3029D ... Industrial Applications	2.9L 179.2 (2938cc) OHV Diesel L3 106mm Bore (PowerTech 2V)	5
TFD ... Industrial Applications	.9L 53.9 L-HEAD L2 3.25" Bore (Wisconsin Eng.)	1	3029T ... Industrial Applications	2.9L 179 OHV Turbo-Diesel L3 4.1875" Bore (Standard)	3
TH ... Industrial Applications	.9L 53.9 L-HEAD L2 3.25" Bore (Wisconsin Eng.)	1	3029T ... Industrial Applications	2.9L 179.2 (2938cc) OHV Turbo-Diesel L3 106mm Bore (Litre Engine)	6
THD ... Industrial Applications	.9L 53.9 L-HEAD L2 3.25" Bore (Wisconsin Eng.)	1	3029T ... Industrial Applications	2.9L 179.2 (2938cc) OHV Turbo-Diesel L3 106mm Bore (PowerTech 2V)	7
TJD ... Industrial Applications	.9L 53.9 L-HEAD L2 3.25" Bore (Wisconsin Eng.)	1	3179D ... Industrial Applications	2.9L 179 OHV Diesel L3 4.1875" Bore (Standard)	2
3029D ... Industrial Applications	2.9L 179 OHV Diesel L3 4.1875" Bore (Standard)	2			
3029D ... Industrial Applications	2.9L 179.2 (2938cc) OHV Diesel L3 106mm Bore (Litre Engine)	4			

(continued on next page)

## Engine Code Index

Engine Code	Engine Description	Line No.	Engine Code	Engine Description	Line No.
3179T ... Industrial Applications.....	2.9L 179 OHV Turbo-Diesel L3 4.1875" Bore (Standard).....	3	6076A ... Industrial Applications.....	7.6L 466 OHV Turbo-Diesel L6 4.5625" Bore (Standard).....	28
4039D ... Industrial Applications.....	3.9L 239 (3917cc) OHV Diesel L4 106mm Bore (Litre Engine) .....	10	6076D ... Industrial Applications.....	7.6L 465.9 (7638cc) OHV Diesel L6 115mm Bore (Litre Engine) .....	29
4039T ... Industrial Applications.....	3.9L 239 (3917cc) OHV Turbo-Diesel L4 106mm Bore (Litre Engine) .....	11	6076H ... Industrial Applications.....	7.6L 465.9 (7638cc) OHV Turbo-Diesel L6 115mm Bore (Litre Engine) .....	30
4045D ... Industrial Applications.....	4.5L 276 OHV Diesel L4 4.1875" Bore (Standard).....	16	6076T ... Industrial Applications.....	7.6L 466 OHV Turbo-Diesel L6 4.5625" Bore (Standard).....	28
4045D ... Industrial Applications.....	4.5L 275.8 (4522cc) OHV Diesel L4 106mm Bore (PowerTech 2V) .....	14	6081A ... Industrial Applications.....	8.1L 495.9 (8129cc) OHV Turbo-Diesel L6 116mm Bore (PowerTech 2V AC).....	33
4045H ... Industrial Applications.....	4.5L 275.8 (4522cc) OHV Turbo-Diesel L4 106mm Bore (PowerTech 2V IC).....	12	6081H ... Industrial Applications.....	8.1L 495.9 (8129cc) OHV Turbo-Diesel L6 116mm Bore (PowerTech 2V IC).....	32
4045H ... Industrial Applications.....	4.5L 275.8 (4522cc) OHV Turbo-Diesel L4 106mm Bore (PowerTech 4V IC).....	13	6081HN ... Industrial Applications.....	8.1L 495.9 (8129cc) OHV Turbo-NG L6 116mm Bore (PowerTech 2V IC).....	31
4045T ... Industrial Applications.....	4.5L 276 OHV Turbo-Diesel L4 4.1875" Bore (Standard).....	17	6081T ... Industrial Applications.....	8.1L 495.9 (8129cc) OHV Turbo-Diesel L6 116mm Bore (Litre Engine) .....	34
4045T ... Industrial Applications.....	4.5L 275.8 (4522cc) OHV Turbo-Diesel L4 106mm Bore (PowerTech 2V).....	15	6081T ... Industrial Applications.....	8.1L 495.9 (8129cc) OHV Turbo-Diesel L6 116mm Bore (PowerTech 2V).....	36
4276D ... Industrial Applications.....	4.5L 276 OHV Diesel L4 4.1875" Bore (Standard).....	16	6081TN ... Industrial Applications.....	8.1L 495.9 (8129cc) OHV Turbo-NG L6 116mm Bore (PowerTech 2V) .	35
4276T ... Industrial Applications.....	4.5L 276 OHV Turbo-Diesel L4 4.1875" Bore (Standard).....	17	6090A ... Industrial Applications.....	9.0L 549 (9000cc) OHV Turbo-Diesel L6 118.4mm Bore (PowerTech 4V AC).....	38
6068D ... Industrial Applications.....	6.8L 414 OHV Diesel L6 4.1875" Bore (Standard).....	26	6090H ... Industrial Applications.....	9.0L 549 (9000cc) OHV Turbo-Diesel L6 118.4mm Bore (PowerTech 4V IC).....	37
6068D ... Industrial Applications.....	6.8L 413.8 (6784cc) OHV Diesel L6 106mm Bore (Litre Engine) .....	21	6090T ... Industrial Applications.....	9.0L 549 (9000cc) OHV Turbo-Diesel L6 118.4mm Bore (PowerTech 4V).....	39
6068D ... Industrial Applications.....	6.8L 413.8 (6784cc) OHV Diesel L6 106mm Bore (PowerTech 2V) .....	22	6101D ... Industrial Applications.....	10.1L 616.7 (10109cc) OHV Diesel L6 130mm Bore (Litre Engine) .....	40
6068H ... Industrial Applications.....	6.8L 413.8 (6784cc) OHV Turbo-Diesel L6 106mm Bore (PowerTech 2V IC).....	19	6101T ... Industrial Applications.....	10.1L 616.7 (10109cc) OHV Turbo-Diesel L6 130mm Bore (Litre Engine) .....	41
6068H ... Industrial Applications.....	6.8L 413.8 (6784cc) OHV Turbo-Diesel L6 106mm Bore (PowerTech 4V IC).....	20	6101T ... Industrial Applications.....	10.1L 619 OHV Turbo-Diesel L6 5.125" Bore.....	42
6068HN ... Industrial Applications.....	6.8L 413.8 (6784cc) OHV Turbo-NG L6 106mm Bore (PowerTech 2V IC).....	18	6105T ... Industrial Applications.....	10.5L 639.5 (10483cc) OHV Turbo-Diesel L6 127mm Bore (PowerTech) .....	43
6068N ... Industrial Applications.....	6.8L 413.8 (6784cc) OHV NG L6 106mm Bore (PowerTech 2V) .....	23	6125T ... Industrial Applications.....	12.5L 764.6 (12534cc) OHV Turbo-Diesel L6 127mm Bore (PowerTech) .....	44
6068T ... Industrial Applications.....	6.8L 414 OHV Turbo-Diesel L6 4.1875" Bore (Standard).....	27	6414D ... Industrial Applications.....	6.8L 414 OHV Diesel L6 4.1875" Bore (Standard).....	26
6068T ... Industrial Applications.....	6.8L 413.8 (6784cc) OHV Turbo-Diesel L6 106mm Bore (PowerTech 2V).....	25	6414T ... Industrial Applications.....	6.8L 414 OHV Turbo-Diesel L6 4.1875" Bore (Standard).....	27
6068TN ... Industrial Applications.....	6.8L 413.8 (6784cc) OHV Turbo-NG L6 106mm Bore (PowerTech 2V) .	24			

(continued on next page)



Engine Code Index					
Engine Code	Engine Description	Line No.	Engine Code	Engine Description	Line No.
6466A ... Industrial Applications.....	7.6L 466 OHV Turbo-Diesel L6 4.5625" Bore (Standard).....	28	6619A ... Industrial Applications.....	10.1L 619 OHV Turbo-Diesel L6 5.125" Bore.....	42
6466T ... Industrial Applications.....	7.6L 466 OHV Turbo-Diesel L6 4.5625" Bore (Standard).....	28	6619TA ... Industrial Applications.....	10.1L 619 OHV Turbo-Diesel L6 5.125" Bore.....	42

**Industrial Applications TF, TFD, TH, THD, TJD Eng. 1**  
.9L 53.9 L-HEAD L2, 3.25" Bore (Wisconsin Eng.)

**CYL. HEAD & PARTS**

QTY	VALVE	PART NO.	SIZE	DESCRIPTION
4	Intake	FP-V816		TF & TH Eng.; 1.3130" Head Dia., .3085" Stem Dia., 4.7660" O.A.L.
2	Intake	FP-V816		TFD & THD Eng.; 1.3130" Head Dia., .3085" Stem Dia., 4.7660" O.A.L.
4	Exhaust	FP-V1326X		Optional-H/D; TF & TH Eng.; 1.2500" Head Dia., .3085" Stem Dia., 4.7710" O.A.L.
2	Exhaust	FP-V1326X		TFD & THD Eng.; 1.2500" Head Dia., .3085" Stem Dia., 4.7710" O.A.L.
8	Keeper	FP-VK144		1 groove; Square cut key groove
8	Keeper	VK-115R		1 groove; Square cut key groove; Hardened
8	Keeper	VK-144R		1 groove; Square cut key groove; Hardened
8	Keeper, Bulk	FP-VK144B		1 groove; Square cut key groove; Carton of 1000
8	Keeper, Bulk	VK-115B		1 groove; Square cut key groove; Carton of 1000
QTY	VALVE SEAT	PART NO.	SIZE	DESCRIPTION
2	Exh.	FP-24513755		1.3795" OD, 1.1250" ID, .2636" Depth
QTY	VALVE GUIDE	PART NO.	SIZE	DESCRIPTION
4	Guide	FP-VG635		.3155" ID, 2.5000" O.A.L.
4	Guide	FP-VG681		.439" x 1.812"; .3133" ID, 1.8100" O.A.L.
QTY	VALVE SPRING	PART NO.	SIZE	DESCRIPTION
4	Spring	FP-VS793		Exh.; Use w/RC-45 rotocap; 1.9700" Free Height
4	Spring	FP-VS468		Exh. & Int.; TF & TH Eng.; 2.3120" Free Height
2	Spring	FP-VS468		Int.; TFD & THD Eng.; 2.3120" Free Height

**CAMSHAFT GROUP**

QTY	TIMING	PART NO.	SIZE	DESCRIPTION
1	Cam Gear	FP-2214108		TH & THD Eng.; 48 Teeth

**CYLINDER COMPONENTS**

QTY	LINERS	PART NO.	SIZE	DESCRIPTION
2	Repair Sleeve	FP-SL11M		3/32" wall, must be cut to correct length
QTY	PISTONS	PART NO.	SIZE	DESCRIPTION
2	Cast Piston	FP-1115CP	STD	Cast; 3-3/32", 1-3/16" Ring Groove, 1.500" CD, .7500" Pin Dia., Recessed Head .010" deep; Piston length 2.870"; Repl. 4 ring piston in sets only
2	Cast Piston	FP-1115CP20	20	Cast; 3-3/32", 1-3/16" Ring Groove, 1.500" CD, .7500" Pin Dia., Recessed Head .010" deep; Piston length 2.870"; Repl. 4 ring piston in sets only
2	Cast Piston	FP-1115CP30	30	Cast; 3-3/32", 1-3/16" Ring Groove, 1.500" CD, .7500" Pin Dia., Recessed Head .010" deep; Piston length 2.870"; Repl. 4 ring piston in sets only
2	Cast Piston	FP-1115CP40	40	Cast; 3-3/32", 1-3/16" Ring Groove, 1.500" CD, .7500" Pin Dia., Recessed Head .010" deep; Piston length 2.870"; Repl. 4 ring piston in sets only
2	Cast Piston	FP-1115CP60	60	Cast; 3-3/32", 1-3/16" Ring Groove, 1.500" CD, .7500" Pin Dia., Recessed Head .010" deep; Piston length 2.870"; Repl. 4 ring piston in sets only
2	Cast Piston - Individual	FP-W1115CP	STD	Cast; 3-3/32", 1-3/16" Ring Groove, 1.500" CD, .7500" Pin Dia., Recessed Head .010" deep; Piston length 2.870"; Repl. 4 ring piston in sets only
2	Cast Piston - Individual	FP-W1115CP20	20	Cast; 3-3/32", 1-3/16" Ring Groove, 1.500" CD, .7500" Pin Dia., Recessed Head .010" deep; Piston length 2.870"; Repl. 3 ring piston in sets only
2	Cast Piston - Individual	FP-W1115CP30	30	Cast; 3-3/32", 1-3/16" Ring Groove, 1.500" CD, .7500" Pin Dia., Recessed Head .010" deep; Piston length 2.870"; Repl. 3 ring piston in sets only

(continued on next page)

<b>1 Industrial Applications TF, TFD, TH, THD, TJD Engs.</b>				
<b>(cont.) .9L 53.9 L-HEAD L2, 3.25" Bore (Wisconsin Eng.)</b>				
<b>CYLINDER COMPONENTS (cont.)</b>				
<b>QTY</b>	<b>PISTONS (cont.)</b>	<b>PART NO.</b>	<b>SIZE</b>	<b>DESCRIPTION</b>
2	Cast Piston - Individual	<b>FP-W1115CP40</b>	40	Cast; 3-3/32", 1-3/16" Ring Groove, 1.500" CD, .7500" Pin Dia., Recessed Head .010" deep; Piston length 2.870"; Repl. 3 ring piston in sets only
2	Cast Piston - Individual	<b>FP-W1115CP60</b>	60	Cast; 3-3/32", 1-3/16" Ring Groove, 1.500" CD, .7500" Pin Dia., Recessed Head .010" deep; Piston length 2.870"; Repl. 3 ring piston in sets only
2	Pin Bushing	<b>FP-1394</b>		TF & TH Engs.; 1.000" max. length
2	Pin Bushing	<b>1394 +</b>		TF & TH Engs.; 1.000" max. length; When depleted use FP-1394
<b>QTY</b>	<b>CONNECTING RODS &amp; BRGS.</b>	<b>PART NO.</b>	<b>SIZE</b>	<b>DESCRIPTION</b>
2	Rod Pair	<b>FP-3520CP</b>		
2	Rod Pair	<b>FP-3520CP10</b>		
2	Rod Pair	<b>FP-3520CP20</b>		
2	Rod Pair	<b>FP-3645CP</b>		TJD Engs.
2	Rod Pair	<b>FP-3645CP10</b>		TJD Engs.
2	Rod Pair	<b>FP-3645CP20</b>		TJD Engs.
<b>QTY</b>	<b>PISTON RINGS</b>	<b>PART NO.</b>	<b>SIZE</b>	<b>DESCRIPTION</b>
1	Premium Set	<b>FP-5809KX</b>	STD	TF, TFD, TH & THD Engs.; 3-3/32, 1-3/16
1	Premium Set	<b>FP-5809KX20</b>	20	TF, TFD, TH & THD Engs.; 3-3/32, 1-3/16
1	Premium Set	<b>FP-5809KX40</b>	40	TF, TFD, TH & THD Engs.; 3-3/32, 1-3/16
1	Premium Set	<b>FP-5809KX60</b>	60	TF, TFD, TH & THD Engs.; 3-3/32, 1-3/16
1	Premium Set	<b>FP-9981KX</b>	STD	TJD Engs.; 2-5/64, 1-3/16
1	Standard Set	<b>FP-7079X</b>	STD	TF, TFD, TH & THD Engs.; 3-3/32, 1-3/16
1	Standard Set	<b>FP-7079X30</b>	30	TF, TFD, TH & THD Engs.; 3-3/32, 1-3/16
1	Standard Set	<b>FP-7079X40</b>	40	TF, TFD, TH & THD Engs.; 3-3/32, 1-3/16
2	Premium Single Cylinder Set	<b>W-5809KX</b> Std Only		TF, TFD, TH & THD Engs.; 3-3/32, 1-3/16
<b>2 Industrial Applications 3029D, 3179D Engs.</b>				
<b>2.9L 179 OHV Diesel L3 (Standard), 4.1875" Bore</b>				
<b>CYL. HEAD &amp; PARTS</b>				
<b>QTY</b>	<b>GASKETS</b>	<b>PART NO.</b>	<b>SIZE</b>	<b>DESCRIPTION</b>
1	Valve Cover Gasket	<b>FP-R75729</b>		Sheet metal cover; Rocker arm cover codes 1102, 1103; From Ser. No. 576,074
1	Head Gasket	<b>FP-R97356</b>		RePower Engs.; Cyl. head codes 5101, 5102
1	Head Set	<b>FP-RE38850</b>		RePower Engs.; Cyl. head codes 5101, 5102
1	Oil Filler Cap Gasket	<b>FP-R80135</b>		Oil filler neck code 1201; Use w/O.E. filler neck No. R80137; L.H. Auxiliary drive
1	Oil Filler Cap Gasket	<b>FP-R80135</b>		Oil filler neck code 1204; Use w/O.E. filler neck No. RE26917; L.H. Auxiliary drive
1	Oil Filler Cap Gasket	<b>FP-T20328</b>		Rocker arm cover code 1103; Oil filler neck code 1201; Use w/O.E. filler neck No. T23614
1	Oil Filler Cap Gasket	<b>FP-T20328</b>		Rocker arm cover code 1103; Oil filler neck code 1204; Use w/O.E. filler neck No. RE44200
1	Oil Filler Cap Gasket	<b>FP-T20328</b>		Rocker arm cover code 1103; Oil filler neck codes 1202, 1203, 1206
<b>QTY</b>	<b>VALVE</b>	<b>PART NO.</b>	<b>SIZE</b>	<b>DESCRIPTION</b>
3	Intake	<b>FP-R79623</b>	STD	2 groove; Chrome plated stem; 1.7720" Head Dia., .3720" Stem Dia., 5.1560" O.A.L.
3	Intake	<b>FP-R79628</b>	3	2 groove; Chrome plated stem; 1.7720" Head Dia., .3750" Stem Dia., 5.1560" O.A.L.
3	Intake	<b>FP-R79629</b>	15	2 groove; Chrome plated stem; 1.7720" Head Dia., .3870" Stem Dia., 5.1560" O.A.L.
3	Intake	<b>FP-R79630</b>	30	2 groove; Chrome plated stem; 1.7720" Head Dia., .4020" Stem Dia., 5.1560" O.A.L.
3	Exhaust	<b>FP-R79624</b>	STD	1 groove; Chrome plated stem; 1.5750" Head Dia., .3720" Stem Dia., 5.1560" O.A.L.
3	Exhaust	<b>FP-R79625</b>	3	1 groove; Chrome plated stem; 1.5750" Head Dia., .3750" Stem Dia., 5.1560" O.A.L.
3	Exhaust	<b>FP-R79626</b>	15	1 groove; Chrome plated stem; 1.5750" Head Dia., .3870" Stem Dia., 5.1560" O.A.L.
3	Exhaust	<b>FP-R79627</b>	30	1 groove; Chrome plated stem; 1.5750" Head Dia., .4020" Stem Dia., 5.1560" O.A.L.
12	Keeper	<b>FP-41339</b>		1 groove; Square cut key groove
12	Keeper	<b>FP-T20077</b>		1 groove; Square cut key groove; Hardened
12	Keeper, Bulk	<b>VK-138B</b>		1 groove; Square cut key groove; Carton of 1000
<b>QTY</b>	<b>VALVE SEAT</b>	<b>PART NO.</b>	<b>SIZE</b>	<b>DESCRIPTION</b>
3	Exh.	<b>FP-R51734</b>	STD	

(continued on next page)



**Industrial Applications 3029D, 3179D Engs. 2**  
2.9L 179 OHV Diesel L3 (Standard), 4.1875" Bore (cont.)

<b>CYL. HEAD &amp; PARTS (cont.)</b>				
QTY	VALVE SEAT (cont.)	PART NO.	SIZE	DESCRIPTION
3	Int.	FP-R73064	STD	
QTY	VALVE SPRING	PART NO.	SIZE	DESCRIPTION
6	Spring	FP-R26125		2.1200" Free Height
QTY	VALVE MISC.	PART NO.	SIZE	DESCRIPTION
6	Rotocap	FP-RE11410		Exh.
1	Bushing	FP-T26321		Lower
1	Bushing	FP-T20034		Upper
QTY	VALVE SEAL	PART NO.	SIZE	DESCRIPTION
6	Valve Stem Seal	FP-R87627		Exh. & Int.; O-Ring type
<b>INT &amp; EXH MANIFOLDS</b>				
QTY	INT. & EXH. MANIFOLDS	PART NO.	SIZE	DESCRIPTION
3	Exhaust Manifold Gasket	FP-R90658		
1	Air Intake Gasket	FP-R81275		
<b>CAMSHAFT GROUP</b>				
QTY	TIMING COVER	PART NO.	SIZE	DESCRIPTION
1	Timing Gear Cover Gasket	FP-T20273		Access cover
1	Timing Gear Cover Gasket	FP-R97454		Front cover
QTY	CAMSHAFT/LIFTER	PART NO.	SIZE	DESCRIPTION
6	Lifter	FP-T20073		
<b>FUEL SYSTEM &amp; PARTS</b>				
QTY	FUEL INJECTION	PART NO.	SIZE	DESCRIPTION
3	Fuel Injector Nozzle	FP-AR89564		
3	Fuel Injector Seal	FP-R79605		Fuel line connection; Nozzle marked 27333; 9.270MM X 13.600MM X 5.080MM
3	Fuel Injector Nut	FP-R79604		w/Injector marked 27333
2	Clamp	FP-R34766		Pump code 3707
6	Washer Type Seal	FP-R51936		Leak-off & return line seals; w/Nozzle marked 27333
QTY	FUEL FILTERS & PUMP	PART NO.	SIZE	DESCRIPTION
1	Fuel Transfer Pump Gasket	FP-R97350		
<b>COOLING SYSTEM</b>				
QTY	WATER PUMP	PART NO.	SIZE	DESCRIPTION
1	Water Pump Repair/Rebuild Kit	FP-944840979		w/Pump housing marked R52009
1	Water Pump Housing Gasket	FP-R55405		w/Pump housing marked R100812, R127918; Pump housing to back cover
1	Water Pump Housing Gasket	FP-R55406		w/Pump housing marked R55130; To Ser. No. 498,345; Pump housing to back cover
1	Water Pump Housing Gasket	FP-R55406		w/Pump housing marked R55164; From Ser. No. 498,346; Pump housing to back cover
1	Water Pump Housing Gasket	FP-R97455		w/Pump housing marked R73604, R91724, R91810; Pump housing to back cover
1	Water Pump Mounting Gasket	FP-T20243		w/Pump housing marked R55130, R73604, R91810, R100812, R122337, R127918; Pump to block
1	Shaft & Bearing Assembly	FP-JD9448		w/Cast pulley; w/Pump housing marked R55164
QTY	THERMOSTAT	PART NO.	SIZE	DESCRIPTION
1	Thermostat	FP-AR61538		Thermostat code 2208; 181 Deg.
1	Thermostat Gasket	FP-T20219		Thermostat housing codes 3901 marked R60256, T20218; Thermostat housing codes 3909, 3910; Thermostat cover codes 2101, 2104, 3914 marked R91165
1	Thermostat Cover Gasket	FP-T20215		Thermostat cover codes 2101, 2102; Thermostat housing codes 2101, 2204, 3914; w/housing marked R91165
<b>ENGINE BLOCK &amp; PARTS</b>				
QTY	GASKETS	PART NO.	SIZE	DESCRIPTION
1	Flywheel Housing Gasket	FP-R97351		R.H.; Use w/Flywheel housing SAE 4; w/2 hole mounting
1	Oil Pan Gasket	FP-R97341		Exc. Alum. oil pan
1	Block to End Plate Front Gskt	FP-R131794		Front plate codes 3601, 3602, 3695
QTY	GASKET SETS	PART NO.	SIZE	DESCRIPTION
1	Gasket Conversion Set	FP-PG219CS		Rubber one-piece rear main brg. seal incl.; Wear sleeve incl.
1	In-Frame Gasket Set	FP-PG164S		
1	Complete Overhaul Gasket Set	FP-RE50978		Crankshaft seals not incl.
1	Complete Overhaul Gasket Set	FP-RE50978WS		Incl. crankshaft seals

(continued on next page)

<b>2 Industrial Applications 3029D, 3179D Engs.</b>					
<b>(cont.) 2.9L 179 OHV Diesel L3 (Standard), 4.1875" Bore</b>					
<b>ENGINE BLOCK &amp; PARTS (cont.)</b>					
<b>QTY</b>	<b>CAM BEARINGS</b>	<b>PART NO.</b>	<b>SIZE</b>	<b>DESCRIPTION</b>	
1	Cam Brg.	FP-R119874			
<b>QTY</b>	<b>OIL COOLERS &amp; FILTERS</b>	<b>PART NO.</b>	<b>SIZE</b>	<b>DESCRIPTION</b>	
1	Washer	FP-R105714		Oil cooler; Modine Oil Cooler codes 5904, 5906	
1	Rect. or Square Seal	FP-R70956		Cooler housing w/relief valve; w/Behr cooler codes 5904, 5906; 2.700" X 3.000" X .180"	
<b>CRANKSHAFT/OIL PUMP</b>					
<b>QTY</b>	<b>CRANKSHAFT</b>	<b>PART NO.</b>	<b>SIZE</b>	<b>DESCRIPTION</b>	
1	Crankshaft	FP-AT18031		RePower Engs.; Crankshaft codes 4701, 4703, 4704, 4705; Incl. front & rear seals	
1	Oil Seal Kit	FP-SK67942			
<b>QTY</b>	<b>SEALS - FRONT CRANK</b>	<b>PART NO.</b>	<b>SIZE</b>	<b>DESCRIPTION</b>	
1	Crankshaft Front Seal	FP-AR67942		Crankshaft pulley; Pulley codes 1313, 1314, 1329; Crankshaft, Bearing codes 4701, 4702, 4704, 4705, 4710	
1	O-Ring	FP-H35244			
<b>QTY</b>	<b>SEALS - REAR CRANK</b>	<b>PART NO.</b>	<b>SIZE</b>	<b>DESCRIPTION</b>	
1	Crankshaft Rear Seal	FP-RE24959		RePower Engs.; Crankshaft codes 4701, 4702, 4710	
<b>QTY</b>	<b>MAIN BEARINGS</b>	<b>PART NO.</b>	<b>SIZE</b>	<b>DESCRIPTION</b>	
1	Main Set	FP-MBK3003	STD	w/Flanged thrust brg.	
1	Main Set	FP-MBK300310	10	w/Flanged thrust brg.	
1	Main Set	FP-MBK300320	20	w/Flanged thrust brg.	
1	Main Set	FP-MBK300330	30	w/Flanged thrust brg.	
3	Plain Main Brg.	FP-RE27352	STD	w/Flangeless thrust brg.	
3	Plain Main Brg.	FP-RE27353	10	w/Flangeless thrust brg.	
3	Plain Main Brg.	FP-RE27360	20	w/Flangeless thrust brg.	
3	Plain Main Brg.	FP-RE27368	30	w/Flangeless thrust brg.	
1	Flanged Main Brg.	FP-RE521350	STD	Use w/Flangeless thrust brg.	
1	Flanged Main Brg.	FP-RE526754	10		
1	Flanged Main Brg.	FP-RE527235	20		
1	Flanged Main Brg.	FP-RE527236	30		
3	Thrust Washer	FP-R78598	STD		
<b>QTY</b>	<b>OIL PUMP</b>	<b>PART NO.</b>	<b>SIZE</b>		<b>DESCRIPTION</b>
1	O-Ring	FP-R74354			Oil pump outlet tube; Pump code 5001; w/Pump housing marked R54615
1	Oil Filler Inlet Gasket	FP-R97352			Oil filler neck codes 1201, 1202, 1203, 1206, 1299
<b>CYLINDER COMPONENTS</b>					
<b>QTY</b>	<b>LINERS</b>	<b>PART NO.</b>	<b>SIZE</b>	<b>DESCRIPTION</b>	
3	Liner w/o Sealing Ring	FP-R116281		w/Con. Rod marked R51727, R80034	
3	Liner w/Sealing Rings	FP-RE500023			
3	Cylinder Kit Complete	FP-RE30250	STD		
3	Cyl. Liner Sealing Ring Kit	FP-AR65507			
3	Sealing Ring, Liner	FP-R48767			Rectangle; Top
3	Sealing Ring	FP-SLR2520			Round; Bottom
<b>QTY</b>	<b>PISTONS</b>	<b>PART NO.</b>	<b>SIZE</b>	<b>DESCRIPTION</b>	
3	Piston Body w/o Pin	FP-RE19282		1.38" pin dia. For 1.38" pin dia. w/Con. Rod marked R51727, R80034; 1.3765" ID, 1.500" OD, 1.570" O.A.L.	
3	Piston Kit w/Pin & Retainers	FP-RE19282WP			
3	Pin	FP-R125754			
6	Piston Pin Retainer	FP-M41029			
3	Pin Bushing	FP-R55647			
<b>QTY</b>	<b>CONNECTING RODS &amp; BRGS.</b>	<b>PART NO.</b>	<b>SIZE</b>	<b>DESCRIPTION</b>	
6	Con. Rod Bolt	FP-R80033		w/Con. Rod marked R51727, R80032, R80034, R81410, R105011, R113612; Torque-To-Yield bolt; Replacement recommended	
6	Con. Rod Bolt	FP-R74194		w/Con. Rod marked T20007, R51727, R58979; Torque-To-Yield bolt; Replacement recommended	
3	Rod Pair	FP-RE27348	STD		
3	Rod Pair	FP-RE27349	10		
3	Rod Pair	FP-RE27358	20		
3	Rod Pair	FP-RE27364	30		
<b>QTY</b>	<b>PISTON RINGS</b>	<b>PART NO.</b>	<b>SIZE</b>	<b>DESCRIPTION</b>	
3	Ring Set Single Cylinder	FP-RE507852	STD	1-1/8, 1-3/32, 1-.136 (1 cyl. set)	
3	Ring Set Single Cylinder	FP-RE66820	STD	1-1/8, 1-3/32, 1-.136 (1 cyl. set)	

(continued on next page)



**Industrial Applications 3029D, 3179D Engs. 2**  
2.9L 179 OHV Diesel L3 (Standard), 4.1875" Bore (cont.)

**KITS**

QTY	OVERHAUL KIT	PART NO.	SIZE	DESCRIPTION
1	In-Frame Overhaul Kit	FP-179DIFK		w/Con. Rod marked R51727, R80034; Crankshaft codes 4701, 4703, 4704, 4705; Incl. Torque-To-Yield con. rod bolts
1	Complete Overhaul Kit	FP-179DOHK		w/Con. Rod marked R51727, R80034; RePower Engs.; Crankshaft codes 4701, 4703, 4704, 4705; Incl. front & rear seals; Incl. Torque-To-Yield con. rod bolts

**Industrial Applications 3029T, 3179T Engs. 3**  
2.9L 179 OHV Turbo-Diesel L3 (Standard), 4.1875" Bore

**CYL. HEAD & PARTS**

QTY	GASKETS	PART NO.	SIZE	DESCRIPTION
1	Valve Cover Gasket	FP-R75729		Sheet metal cover; Rocker arm cover codes 1102, 1103; From Ser. No. 576,074
1	Head Gasket	FP-R97356		RePower Engs.; Cyl. head codes 5101, 5102
1	Head Set	FP-RE38850		RePower Engs.; Cyl. head codes 5101, 5102

QTY	VALVE	PART NO.	SIZE	DESCRIPTION
3	Intake	FP-R83071	STD	Stellite; 2 groove; Chrome plated stem; 1.8210" Head Dia., .3720" Stem Dia., 5.1660" O.A.L.
3	Intake	FP-R89223	3	Stellite; 2 groove; Chrome plated stem; 1.8210" Head Dia., .3750" Stem Dia., 5.1660" O.A.L.
3	Intake	FP-R89224	15	Stellite; 2 groove; Chrome plated stem; 1.8210" Head Dia., .3870" Stem Dia., 5.1660" O.A.L.
3	Intake	FP-R79623	STD	2 groove; Chrome plated stem; 1.7720" Head Dia., .3720" Stem Dia., 5.1560" O.A.L.
3	Intake	FP-R79628	3	2 groove; Chrome plated stem; 1.7720" Head Dia., .3750" Stem Dia., 5.1560" O.A.L.
3	Intake	FP-R79629	15	2 groove; Chrome plated stem; 1.7720" Head Dia., .3870" Stem Dia., 5.1560" O.A.L.
3	Intake	FP-R79630	30	2 groove; Chrome plated stem; 1.7720" Head Dia., .4020" Stem Dia., 5.1560" O.A.L.
3	Exhaust	FP-R79624	STD	1 groove; Chrome plated stem; 1.5750" Head Dia., .3720" Stem Dia., 5.1560" O.A.L.
3	Exhaust	FP-R79625	3	1 groove; Chrome plated stem; 1.5750" Head Dia., .3750" Stem Dia., 5.1560" O.A.L.
3	Exhaust	FP-R79626	15	1 groove; Chrome plated stem; 1.5750" Head Dia., .3870" Stem Dia., 5.1560" O.A.L.
3	Exhaust	FP-R79627	30	1 groove; Chrome plated stem; 1.5750" Head Dia., .4020" Stem Dia., 5.1560" O.A.L.
12	Keeper	FP-41339		1 groove; Square cut key groove
12	Keeper	FP-T20077		1 groove; Square cut key groove; Hardened
12	Keeper, Bulk	VK-138B		1 groove; Square cut key groove; Carton of 1000

QTY	VALVE SEAT	PART NO.	SIZE	DESCRIPTION
3	Exh.	FP-R51734	STD	
3	Int.	FP-R73064	STD	

QTY	VALVE SPRING	PART NO.	SIZE	DESCRIPTION
6	Spring	FP-R26125		2.1200" Free Height

QTY	VALVE MISC.	PART NO.	SIZE	DESCRIPTION
6	Rotocap	FP-RE11410		Exh.
1	Bushing	FP-T26321		Lower
1	Bushing	FP-T20034		Upper
1	Oil Filler Cap Gasket	FP-T20328		Rocker arm cover code 1103; Oil filler neck codes 1201, 1202, 1203, 1204, 1206

QTY	VALVE SEAL	PART NO.	SIZE	DESCRIPTION
6	Valve Stem Seal	FP-R87627		Exh. & Int.; O-Ring type

**ELECTRICAL**

QTY	ALTERNATOR	PART NO.	SIZE	DESCRIPTION
1	Ball Brg.	FP-JD9449		Front; Motorola components; Codes 3104, 3118; 12 Volt, 30 amp alternator
2	Ball Brg.	FP-JD9449		Front & Rear; 24 Volt, 45 amp alternator; 12 Volt, 65 amp alternator

**INT & EXH MANIFOLDS**

QTY	INT. & EXH. MANIFOLDS	PART NO.	SIZE	DESCRIPTION
3	Exhaust Manifold Gasket	FP-R90658		

(continued on next page)

<b>3 Industrial Applications 3029T, 3179T Engs.</b>				
<b>(cont.) 2.9L 179 OHV Turbo-Diesel L3 (Standard), 4.1875" Bore</b>				
<b>CAMSHAFT GROUP</b>				
<b>QTY</b>	<b>TIMING COVER</b>	<b>PART NO.</b>	<b>SIZE</b>	<b>DESCRIPTION</b>
1	Timing Gear Cover Gasket	FP-R97454		Front cover
<b>QTY</b>	<b>CAMSHAFT/LIFTER</b>	<b>PART NO.</b>	<b>SIZE</b>	<b>DESCRIPTION</b>
6	Lifter	FP-T20073		
<b>FUEL SYSTEM &amp; PARTS</b>				
<b>QTY</b>	<b>FUEL INJECTION</b>	<b>PART NO.</b>	<b>SIZE</b>	<b>DESCRIPTION</b>
3	Fuel Injector Seal	FP-R79605		Fuel line connection; Nozzle codes 1602, 1603; Nozzle marked 26992; 9.270MM X 13.600MM X 5.080MM
3	Fuel Injector Nut	FP-R79604		w/Injector marked 26992
2	Clamp	FP-R34766		Pump code 3707
6	Washer Type Seal	FP-R51936		Leak-off & return line seals; w/Nozzle codes 1602, 1632; w/Nozzle marked 26992
<b>QTY</b>	<b>FUEL FILTERS &amp; PUMP</b>	<b>PART NO.</b>	<b>SIZE</b>	<b>DESCRIPTION</b>
1	Fuel Transfer Pump Gasket	FP-R97350		
<b>COOLING SYSTEM</b>				
<b>QTY</b>	<b>WATER PUMP</b>	<b>PART NO.</b>	<b>SIZE</b>	<b>DESCRIPTION</b>
1	Water Pump Housing Gasket	FP-R55405		w/Pump housing marked R55130, R55164, R100812, R127912
1	Water Pump Housing Gasket	FP-R97455		w/Pump housing marked R73604, R91724
1	Water Pump Mounting Gasket	FP-T20243		w/Pump housing marked R55130, R73604, R91724, R91810, R100812, R122337, R127918
1	Shaft & Bearing Assembly	FP-JD9448		w/Cast pulley; w/Pump housing marked R55164
<b>QTY</b>	<b>THERMOSTAT</b>	<b>PART NO.</b>	<b>SIZE</b>	<b>DESCRIPTION</b>
1	Thermostat	FP-AR61538		Thermostat code 2208; 181 Deg.
1	Thermostat Gasket	FP-T20219		Thermostat housing codes 3901 marked R60256, T20218; Thermostat housing codes 3909, 3910; Thermostat cover codes 2101, 2104, 3914 marked R91165
1	Thermostat Cover Gasket	FP-T20215		Thermostat cover codes 2101, 2102; Thermostat housing codes 2101, 2204, 3914; w/housing marked R91165
<b>ENGINE BLOCK &amp; PARTS</b>				
<b>QTY</b>	<b>GASKETS</b>	<b>PART NO.</b>	<b>SIZE</b>	<b>DESCRIPTION</b>
1	Flywheel Housing Gasket	FP-R97351		R.H.; Use w/Flywheel housing SAE 4; w/2 hole mounting
1	Oil Pan Gasket	FP-R97341		Exc. Alum. oil pan
1	Block to End Plate Front Gskt	FP-R131794		Front plate codes 3601, 3602, 3695
<b>QTY</b>	<b>GASKET SETS</b>	<b>PART NO.</b>	<b>SIZE</b>	<b>DESCRIPTION</b>
1	Gasket Conversion Set	FP-PG219CS		Rubber one-piece rear main brg. seal incl.; Wear sleeve incl.
1	In-Frame Gasket Set	FP-PG164S		
1	Complete Overhaul Gasket Set	FP-RE50978		Crankshaft seals not incl.
1	Complete Overhaul Gasket Set	FP-RE50978WS		Incl. crankshaft seals
<b>QTY</b>	<b>CAM BEARINGS</b>	<b>PART NO.</b>	<b>SIZE</b>	<b>DESCRIPTION</b>
1	Cam Brg.	FP-R119874		
<b>QTY</b>	<b>OIL COOLERS &amp; FILTERS</b>	<b>PART NO.</b>	<b>SIZE</b>	<b>DESCRIPTION</b>
1	Oil Cooler	FP-RE61767		w/6 plates; Cooler codes 5904, 5906; From Ser. No. 794,194
1	Rect. or Square Seal	FP-R70956		Cooler housing w/relief valve; w/Behr cooler codes 5904, 5906; 2.700" X 3.000" X .180"
<b>CRANKSHAFT/OIL PUMP</b>				
<b>QTY</b>	<b>CRANKSHAFT</b>	<b>PART NO.</b>	<b>SIZE</b>	<b>DESCRIPTION</b>
1	Crankshaft	FP-AT18031		
1	Oil Seal Kit	FP-SK67942		RePower Engs.; Crankshaft codes 4701, 4702, 4703, 4705, 4710; Incl. front & rear seals
<b>QTY</b>	<b>SEALS - FRONT CRANK</b>	<b>PART NO.</b>	<b>SIZE</b>	<b>DESCRIPTION</b>
1	Crankshaft Front Seal	FP-AR67942		
1	O-Ring	FP-H35244		Crankshaft pulley; Pulley codes 1313, 1314, 1329; Crankshaft, Bearing codes 4701, 4702, 4704, 4705, 4710
<b>QTY</b>	<b>SEALS - REAR CRANK</b>	<b>PART NO.</b>	<b>SIZE</b>	<b>DESCRIPTION</b>
1	Crankshaft Rear Seal	FP-RE24959		RePower Engs.; Crankshaft codes 4701, 4702, 4710
<b>QTY</b>	<b>MAIN BEARINGS</b>	<b>PART NO.</b>	<b>SIZE</b>	<b>DESCRIPTION</b>
1	Main Set	FP-MBK3003	STD	w/Flanged thrust brg.
1	Main Set	FP-MBK300310	10	w/Flanged thrust brg.
1	Main Set	FP-MBK300320	20	w/Flanged thrust brg.
1	Main Set	FP-MBK300330	30	w/Flanged thrust brg.
3	Plain Main Brg.	FP-RE27352	STD	w/Flangeless thrust brg.
3	Plain Main Brg.	FP-RE27353	10	w/Flangeless thrust brg.
3	Plain Main Brg.	FP-RE27360	20	w/Flangeless thrust brg.

(continued on next page)



**Industrial Applications 3029T, 3179T Engs. 3**  
2.9L 179 OHV Turbo-Diesel L3 (Standard), 4.1875" Bore (cont.)

<b>CRANKSHAFT/OIL PUMP (cont.)</b>				
<b>QTY</b>	<b>MAIN BEARINGS (cont.)</b>	<b>PART NO.</b>	<b>SIZE</b>	<b>DESCRIPTION</b>
3	Plain Main Brg.	FP-RE27368	30	w/Flangeless thrust brg.
1	Flanged Main Brg.	FP-RE521350	STD	
1	Flanged Main Brg.	FP-RE526754	10	
1	Flanged Main Brg.	FP-RE527235	20	
1	Flanged Main Brg.	FP-RE527236	30	
3	Thrust Washer	FP-R78598	STD	Use w/Flangeless thrust brg.
<b>QTY</b>	<b>OIL PUMP</b>	<b>PART NO.</b>	<b>SIZE</b>	<b>DESCRIPTION</b>
1	O-Ring	FP-R74354		Oil pump outlet tube; Pump codes 5001, 5002; w/Pump housing marked R54615
1	Oil Filler Inlet Gasket	FP-R97352		Oil filler neck codes 1201, 1202, 1203, 1206, 1299

<b>CYLINDER COMPONENTS</b>				
<b>QTY</b>	<b>LINERS</b>	<b>PART NO.</b>	<b>SIZE</b>	<b>DESCRIPTION</b>
3	Liner w/o Sealing Ring	FP-R116281		
3	Liner w/Sealing Rings	FP-RE500023		
3	Cylinder Kit Complete	FP-RE33115		w/Con. Rod marked R58979, R80032, R113612
3	Cyl. Liner Sealing Ring Kit	FP-AR65507		
3	Sealing Ring, Liner	FP-R48767		Rectangle; Top
3	Sealing Ring	FP-SLR2520		Round; Bottom
<b>QTY</b>	<b>PISTONS</b>	<b>PART NO.</b>	<b>SIZE</b>	<b>DESCRIPTION</b>
3	Piston Body w/o Pin	FP-RE48368		
3	Piston Kit w/Pin & Retainers	FP-RE48368WP		
3	Pin	FP-R124230		1.62" pin dia.
6	Piston Pin Retainer	FP-R54114		For 1.62" pin dia.
3	Pin Bushing	FP-R57451		w/Con. Rod marked R56187, R58979, R80032, R113612; Pin dia. 1.62"; 1.621" ID, 1.813" OD, 1.370" O.A.L.
<b>QTY</b>	<b>CONNECTING RODS &amp; BRGS.</b>	<b>PART NO.</b>	<b>SIZE</b>	<b>DESCRIPTION</b>
6	Con. Rod Bolt	FP-R80033		w/Con. Rod marked R80032, R80034, R81410, R105011, R113612; Torque-To-Yield bolt; Replacement recommended
6	Con. Rod Bolt	FP-R74194		w/Con. Rod marked T20007, R51727, R58979; Torque-To-Yield bolt; Replacement recommended
3	Rod Pair	FP-RE27348	STD	
3	Rod Pair	FP-RE27349	10	
3	Rod Pair	FP-RE27358	20	
3	Rod Pair	FP-RE27364	30	
<b>QTY</b>	<b>PISTON RINGS</b>	<b>PART NO.</b>	<b>SIZE</b>	<b>DESCRIPTION</b>
3	Ring Set Single Cylinder	FP-RE507852	STD	1-1/8, 1-3/32, 1-.136 (1 cyl. set)
3	Ring Set Single Cylinder	FP-RE66820	STD	1-1/8, 1-3/32, 1-.136 (1 cyl. set)
<b>KITS</b>				
<b>QTY</b>	<b>OVERHAUL KIT</b>	<b>PART NO.</b>	<b>SIZE</b>	<b>DESCRIPTION</b>
1	In-Frame Overhaul Kit	FP-179TIFK		w/Con. Rod marked R80032, R113612; Crankshaft codes 4701, 4702, 4705, 4710; Incl. Torque-To-Yield con. rod bolts
1	Complete Overhaul Kit	FP-179TOHK		w/Con. Rod marked R58979, R80032, R80034, R81410, R10511, R113612; Pin dia. 1.62"; RePower Engs.; Crankshaft codes 4701, 4702, 4703, 4705; Incl. front & rear seals; Incl. Torque-To-Yield con. rod bolts

**Industrial Applications 3029D Eng. 4**  
2.9L 179.2 (2938cc) OHV Diesel L3 (Litre Engine), 106mm Bore

<b>CYL. HEAD &amp; PARTS</b>				
<b>QTY</b>	<b>GASKETS</b>	<b>PART NO.</b>	<b>SIZE</b>	<b>DESCRIPTION</b>
1	Head Gasket	FP-R97356		Cyl. head codes 5104, 5105, 5106
1	Head Set	FP-RE38850		
<b>QTY</b>	<b>VALVE</b>	<b>PART NO.</b>	<b>SIZE</b>	<b>DESCRIPTION</b>
3	Intake	FP-R98062	STD	1 groove; Chrome plated stem; 1.8350" Head Dia., .3100" Stem Dia., 5.2780" O.A.L.
3	Intake	FP-R97490	15	1 groove; Chrome plated stem; 1.8350" Head Dia., .3250" Stem Dia., 5.2780" O.A.L.
3	Exhaust	FP-R90692	STD	1 groove; Chrome plated stem; 1.6730" Head Dia., .3095" Stem Dia., 5.2550" O.A.L.
3	Exhaust	FP-R97492	15	1 groove; Chrome plated stem; 1.6730" Head Dia., .3245" Stem Dia., 5.2550" O.A.L.
12	Keeper	FP-R91889		

(continued on next page)

<b>4 Industrial Applications 3029D Eng.</b>				
<b>(cont.) 2.9L 179.2 (2938cc) OHV Diesel L3 (Litre Engine), 106mm Bore</b>				
<b>CYL. HEAD &amp; PARTS (cont.)</b>				
<b>QTY</b>	<b>VALVE SEAT</b>	<b>PART NO.</b>	<b>SIZE</b>	<b>DESCRIPTION</b>
3	Exh.	FP-R85687	STD	
3	Int.	FP-R98335		.020" Dia. O/S face width; 1.8575" OD, 1.5500" ID, .2580" Depth
3	Int.	FP-R98063	STD	1.8575" OD, 1.5500" ID, .2580" Depth
<b>QTY</b>	<b>VALVE SPRING</b>	<b>PART NO.</b>	<b>SIZE</b>	<b>DESCRIPTION</b>
6	Spring	FP-R26125		2.1200" Free Height
<b>QTY</b>	<b>VALVE MISC.</b>	<b>PART NO.</b>	<b>SIZE</b>	<b>DESCRIPTION</b>
6	Rotocap	FP-RE60005		Exh. & Int.
1	Oil Filler Cap Gasket	FP-T20328		Oil filler neck codes 1201, 1202, 1203, 1206
<b>QTY</b>	<b>VALVE SEAL</b>	<b>PART NO.</b>	<b>SIZE</b>	<b>DESCRIPTION</b>
6	Valve Stem Seal	FP-RE31617		Positive type
<b>QTY</b>	<b>ROCKER PARTS</b>	<b>PART NO.</b>	<b>SIZE</b>	<b>DESCRIPTION</b>
1	O-Ring	FP-R56463		Rocker cover breather tube; Breather tube codes 2902, 2911, 2999
<b>INT &amp; EXH MANIFOLDS</b>				
<b>QTY</b>	<b>INT. &amp; EXH. MANIFOLDS</b>	<b>PART NO.</b>	<b>SIZE</b>	<b>DESCRIPTION</b>
3	Exhaust Manifold Gasket	FP-R90658		
1	Air Intake Gasket	FP-R81275		
<b>CAMSHAFT GROUP</b>				
<b>QTY</b>	<b>TIMING COVER</b>	<b>PART NO.</b>	<b>SIZE</b>	<b>DESCRIPTION</b>
1	Timing Gear Cover Gasket	FP-R97454		Front cover
1	Timing Gear Cover Gasket	FP-R108654		Use w/R.H. side gear dr. timing gear cover
<b>FUEL SYSTEM &amp; PARTS</b>				
<b>QTY</b>	<b>FUEL INJECTION</b>	<b>PART NO.</b>	<b>SIZE</b>	<b>DESCRIPTION</b>
3	Fuel Injector Nozzle	FP-RE36935		w/Injector marked 28480
3	Fuel Injector Seal	FP-R79605		Fuel line connection; Nozzle marked 28480; 9.270MM X 13.600MM X 5.080MM
3	Fuel Injector Nut	FP-R79604		w/Injector marked 28484
6	Washer Type Seal	FP-R51936		Leak-off & return line seals; w/Nozzle marked 28480
3	Washer Type Seal	FP-R48000		Lower; w/Nozzle marked 28480, 28484
3	Washer Type Seal	FP-R60746		Upper; w/Nozzle marked 28480
<b>COOLING SYSTEM</b>				
<b>QTY</b>	<b>WATER PUMP</b>	<b>PART NO.</b>	<b>SIZE</b>	<b>DESCRIPTION</b>
1	Water Pump Repair/Rebuild Kit	FP-944840979		w/Pump housing marked R52009
1	Water Pump Repair/Rebuild Kit	FP-RE62658		w/Pump housing marked R73604, R91724; From Ser. No. 100,000
1	Water Pump Housing Gasket	FP-R97455		w/Pump housing marked R73604
1	Water Pump Mounting Gasket	FP-T20243		w/H/D Pump housing marked R100812, R127918
1	Water Pump Mounting Gasket	FP-T20243		w/Pump housing marked R48997, R55164, R73604, R110541
1	Shaft & Bearing Assembly	FP-JD9448		w/Cast pulley; w/Pump housing marked R55164
<b>QTY</b>	<b>THERMOSTAT</b>	<b>PART NO.</b>	<b>SIZE</b>	<b>DESCRIPTION</b>
1	Thermostat	FP-AR61538		Thermostat code 2208; 181 Deg.
1	Thermostat Cover Gasket	FP-T20215		Thermostat cover codes 2101, 2102
1	Therm. Hsg. - Water Mfld. Gsk	FP-R54641		Thermostat housing to cyl. head; To Ser. No. 205,211
<b>ENGINE BLOCK &amp; PARTS</b>				
<b>QTY</b>	<b>GASKETS</b>	<b>PART NO.</b>	<b>SIZE</b>	<b>DESCRIPTION</b>
1	Oil Pan Gasket	FP-R97341		Exc. Alum. oil pan
1	Oil Pan Gasket Set	FP-PG300PS		Exc. Alum. oil pan; Incl. O-rings
1	Block to End Plate Front Gskt	FP-R131794		Front plate code 3604; R.H. side gear drive
<b>QTY</b>	<b>GASKET SETS</b>	<b>PART NO.</b>	<b>SIZE</b>	<b>DESCRIPTION</b>
1	In-Frame Gasket Set	FP-PG164S		
1	Complete Overhaul Gasket Set	FP-RE50978		Crankshaft seals not incl.
1	Complete Overhaul Gasket Set	FP-RE50978WS		Incl. crankshaft seals
<b>QTY</b>	<b>CAM BEARINGS</b>	<b>PART NO.</b>	<b>SIZE</b>	<b>DESCRIPTION</b>
1	Cam Brg.	FP-R119874		R.H. Side gear drive; From Ser. No. 100,000
<b>QTY</b>	<b>OIL COOLERS &amp; FILTERS</b>	<b>PART NO.</b>	<b>SIZE</b>	<b>DESCRIPTION</b>
1	Oil Cooler	FP-RE61767		w/6 plates; Cooler codes 5904, 5906, 5908, 5914, 5916; From Ser. No. 185,224
1	Rect. or Square Seal	FP-R70956		Cooler housing w/relief valve; Oil cooler codes 5904, 5906, 5908, 5914, 5916; To Ser. No. 185,223; 2.700" X 3.000" X .180"

(continued on next page)



*Industrial Applications 3029D Eng. 4*  
2.9L 179.2 (2938cc) OHV Diesel L3 (Litre Engine), 106mm Bore (cont.)

<b>CRANKSHAFT/OIL PUMP</b>				
<b>QTY</b>	<b>CRANKSHAFT</b>	<b>PART NO.</b>	<b>SIZE</b>	<b>DESCRIPTION</b>
1	Oil Seal Kit	FP-SK67942		Incl. front & rear seals; Crankshaft codes 4702, 4704, 4705, 4710; From Ser. No. 100,000
<b>QTY</b>	<b>SEALS - FRONT CRANK</b>	<b>PART NO.</b>	<b>SIZE</b>	<b>DESCRIPTION</b>
1	Crankshaft Front Seal	FP-AR67942		
1	O-Ring	FP-H35244		Crankshaft pulley; Pulley codes 1313, 1314, 1329
<b>QTY</b>	<b>SEALS - REAR CRANK</b>	<b>PART NO.</b>	<b>SIZE</b>	<b>DESCRIPTION</b>
1	Crankshaft Rear Seal	FP-RE24959		Crankshaft codes 4702, 4704, 4705, 4710; From Ser. No. 100,000
<b>QTY</b>	<b>MAIN BEARINGS</b>	<b>PART NO.</b>	<b>SIZE</b>	<b>DESCRIPTION</b>
1	Main Set	FP-MBK3003	STD	w/Flanged thrust brg.
1	Main Set	FP-MBK300310	10	w/Flanged thrust brg.
1	Main Set	FP-MBK300320	20	w/Flanged thrust brg.
1	Main Set	FP-MBK300330	30	w/Flanged thrust brg.
3	Plain Main Brg.	FP-RE27352	STD	w/Flangeless thrust brg.
3	Plain Main Brg.	FP-RE27353	10	w/Flangeless thrust brg.
3	Plain Main Brg.	FP-RE27360	20	w/Flangeless thrust brg.
3	Plain Main Brg.	FP-RE27368	30	w/Flangeless thrust brg.
1	Flanged Main Brg.	FP-RE521350	STD	
1	Flanged Main Brg.	FP-RE526754	10	
1	Flanged Main Brg.	FP-RE527235	20	
1	Flanged Main Brg.	FP-RE527236	30	
3	Thrust Washer	FP-R78598	STD	Use w/Flangeless thrust brg.
<b>QTY</b>	<b>OIL PUMP</b>	<b>PART NO.</b>	<b>SIZE</b>	<b>DESCRIPTION</b>
1	O-Ring	FP-R61871		Oil pump inlet; Pump codes 5001, 5002, 5005, 5007, 5012, 5016
1	O-Ring	FP-R74354		Oil pump outlet tube; Pump codes 5001, 5002, 5005, 5007, 5008, 5009, 5010, 5011, 5012, 5013, 5014, 5015, 5016; w/Pump housing marked R54615
1	Oil Filler Inlet Gasket	FP-R97352		Oil filler neck codes 1201, 1203, 1299
<b>CYLINDER COMPONENTS</b>				
<b>QTY</b>	<b>LINERS</b>	<b>PART NO.</b>	<b>SIZE</b>	<b>DESCRIPTION</b>
3	Liner w/o Sealing Ring	FP-R116281		
3	Liner w/Sealing Rings	FP-RE500023		
3	Cylinder Kit Complete	FP-RE30250	STD	w/Con. Rod marked R51727, R80034
3	Cyl. Liner Sealing Ring Kit	FP-AR65507		
3	Sealing Ring, Liner	FP-R48767		Rectangle; Top
3	Sealing Ring	FP-SLR2520		Round; Bottom
<b>QTY</b>	<b>PISTONS</b>	<b>PART NO.</b>	<b>SIZE</b>	<b>DESCRIPTION</b>
3	Piston Body w/o Pin	FP-RE19282		
3	Piston Kit w/Pin & Retainers	FP-RE19282WP		
3	Pin	FP-R125754		1.38" pin dia.
6	Piston Pin Retainer	FP-M41029		For 1.38" pin dia.
3	Pin Bushing	FP-R55647		w/Con. Rod marked R51727, R80034; 1.3765" ID, 1.500" OD, 1.570" O.A.L.
<b>QTY</b>	<b>CONNECTING RODS &amp; BRGS.</b>	<b>PART NO.</b>	<b>SIZE</b>	<b>DESCRIPTION</b>
6	Con. Rod Bolt	FP-R80033		w/Con. Rod marked R51727, R80032, R80034, R81410, R105011, R113612; Torque-To-Yield bolt; Replacement recommended
3	Rod Pair	FP-RE27348	STD	
3	Rod Pair	FP-RE27349	10	
3	Rod Pair	FP-RE27358	20	
3	Rod Pair	FP-RE27364	30	
<b>QTY</b>	<b>PISTON RINGS</b>	<b>PART NO.</b>	<b>SIZE</b>	<b>DESCRIPTION</b>
3	Ring Set Single Cylinder	FP-RE507852	STD	1-1/8, 1-3/32, 1-.136 (1 cyl. set)
3	Ring Set Single Cylinder	FP-RE66820	STD	1-1/8, 1-3/32, 1-.136 (1 cyl. set)
<b>KITS</b>				
<b>QTY</b>	<b>OVERHAUL KIT</b>	<b>PART NO.</b>	<b>SIZE</b>	<b>DESCRIPTION</b>
1	In-Frame Overhaul Kit	FP-179DIFK		w/Con. Rod marked R51727, R80034; Crankshaft codes 4702, 4705, 4710; Incl. Torque-To-Yield con. rod bolts
1	Complete Overhaul Kit	FP-179DOHK		w/Con. Rod marked R51727, R80034; Crankshaft codes 4702, 4705, 4710; Incl. front & rear seals; From Ser. No. 100,000; Incl. Torque-To-Yield con. rod bolts

<b>5 Industrial Applications 3029D PowerTech Eng.</b>				
2.9L 179.2 (2938cc) OHV Diesel L3 (PowerTech 2V), 106mm Bore				
<b>CYL. HEAD &amp; PARTS</b>				
<b>QTY</b>	<b>GASKETS</b>	<b>PART NO.</b>	<b>SIZE</b>	<b>DESCRIPTION</b>
1	Head Gasket	FP-R97356		Cyl. head codes 5104, 5105, 5106
1	Head Set	FP-RE38850		
<b>QTY</b>	<b>VALVE</b>	<b>PART NO.</b>	<b>SIZE</b>	<b>DESCRIPTION</b>
3	Intake	FP-R98062	STD	1 groove; Chrome plated stem; 1.8350" Head Dia., .3100" Stem Dia., 5.2780" O.A.L.
3	Intake	FP-R97490	15	1 groove; Chrome plated stem; 1.8350" Head Dia., .3250" Stem Dia., 5.2780" O.A.L.
3	Exhaust	FP-R90692	STD	1 groove; Chrome plated stem; 1.6730" Head Dia., .3095" Stem Dia., 5.2550" O.A.L.
3	Exhaust	FP-R97492	15	1 groove; Chrome plated stem; 1.6730" Head Dia., .3245" Stem Dia., 5.2550" O.A.L.
12	Keeper	FP-R91889		Exh. & Int.
<b>QTY</b>	<b>VALVE SPRING</b>	<b>PART NO.</b>	<b>SIZE</b>	<b>DESCRIPTION</b>
6	Spring	FP-R26125		Exh. & Int.; 2.1200" Free Height
<b>QTY</b>	<b>VALVE MISC.</b>	<b>PART NO.</b>	<b>SIZE</b>	<b>DESCRIPTION</b>
6	Rotocap	FP-RE60005		Exh. & Int.
1	Oil Filler Cap Gasket	FP-T20328		Oil filler neck codes 1201, 1202, 1203, 1206
<b>QTY</b>	<b>VALVE SEAL</b>	<b>PART NO.</b>	<b>SIZE</b>	<b>DESCRIPTION</b>
6	Valve Stem Seal	FP-RE31617		Exh. & Int.; Positive type
<b>INT &amp; EXH MANIFOLDS</b>				
<b>QTY</b>	<b>INT. &amp; EXH. MANIFOLDS</b>	<b>PART NO.</b>	<b>SIZE</b>	<b>DESCRIPTION</b>
3	Exhaust Manifold Gasket	FP-R90658		
1	Air Intake Gasket	FP-R81275		
<b>CAMSHAFT GROUP</b>				
<b>QTY</b>	<b>TIMING COVER</b>	<b>PART NO.</b>	<b>SIZE</b>	<b>DESCRIPTION</b>
1	Timing Gear Cover Gasket	FP-R97454		Front cover
1	Timing Gear Cover Gasket	FP-R108654		Use w/R.H. side gear dr. timing gear cover
<b>QTY</b>	<b>CAMSHAFT/LIFTER</b>	<b>PART NO.</b>	<b>SIZE</b>	<b>DESCRIPTION</b>
6	Lifter	FP-T20073		
<b>FUEL SYSTEM &amp; PARTS</b>				
<b>QTY</b>	<b>FUEL INJECTION</b>	<b>PART NO.</b>	<b>SIZE</b>	<b>DESCRIPTION</b>
3	Fuel Injector Nozzle	FP-RE36935		w/Injector marked 28480
3	Fuel Injector Nut	FP-R79604		w/Injector marked 28480
3	FI Installation Kit	FP-RE65201		
6	Washer Type Seal	FP-R51936		Leak-off & return line seals; w/Nozzle marked 28480
3	Washer Type Seal	FP-R48000		Lower; w/Nozzle marked 28480, 28484
3	Washer Type Seal	FP-R60746		Upper; w/Nozzle marked 28480
<b>COOLING SYSTEM</b>				
<b>QTY</b>	<b>WATER PUMP</b>	<b>PART NO.</b>	<b>SIZE</b>	<b>DESCRIPTION</b>
1	Water Pump Repair/Rebuild Kit	FP-RE62658		Pump codes 2010, 2020, 2022, 2023; w/Pump housing marked R73604
1	Water Pump Housing Gasket	FP-R97455		w/Pump housing marked R73604
1	Water Pump Mounting Gasket	FP-T20243		w/H/D Pump housing marked R100812, R127918
1	Water Pump Mounting Gasket	FP-T20243		w/Pump housing marked R48997, R55164, R73604, R110541
<b>QTY</b>	<b>THERMOSTAT</b>	<b>PART NO.</b>	<b>SIZE</b>	<b>DESCRIPTION</b>
1	Thermostat Cover Gasket	FP-T20215		Thermostat cover codes 2101, 2102
1	Therm. Hsg. - Water Mfld. Gsk	FP-R54641		Thermostat housing to cyl. head; To Ser. No. 205,211
<b>ENGINE BLOCK &amp; PARTS</b>				
<b>QTY</b>	<b>GASKETS</b>	<b>PART NO.</b>	<b>SIZE</b>	<b>DESCRIPTION</b>
1	Oil Pan Gasket	FP-R97341		Exc. Alum. oil pan
1	Oil Pan Gasket Set	FP-PG300PS		Exc. Alum. oil pan; Incl. O-rings
1	Block to End Plate Front Gskt	FP-R131794		Front plate code 3604; R.H. side gear drive
<b>QTY</b>	<b>GASKET SETS</b>	<b>PART NO.</b>	<b>SIZE</b>	<b>DESCRIPTION</b>
1	In-Frame Gasket Set	FP-PG164S		
1	Complete Overhaul Gasket Set	FP-RE50978		Crankshaft seals not incl.
1	Complete Overhaul Gasket Set	FP-RE50978WS		Incl. crankshaft seals
<b>QTY</b>	<b>CAM BEARINGS</b>	<b>PART NO.</b>	<b>SIZE</b>	<b>DESCRIPTION</b>
1	Cam Brg.	FP-R119874		
<b>QTY</b>	<b>OIL COOLERS &amp; FILTERS</b>	<b>PART NO.</b>	<b>SIZE</b>	<b>DESCRIPTION</b>
1	Oil Cooler	FP-RE61767		Cooler codes 5904, 5906, 5908, 5914, 5920

(continued on next page)





**Industrial Applications 3029D PowerTech Eng. 5**  
2.9L 179.2 (2938cc) OHV Diesel L3 (PowerTech 2V), 106mm Bore (cont.)

<b>ENGINE BLOCK &amp; PARTS (cont.)</b>				
<b>OIL COOLERS &amp; FILTERS</b>				
<b>QTY</b>	<b>DESCRIPTION</b>	<b>PART NO.</b>	<b>SIZE</b>	<b>DESCRIPTION</b>
1	Rect. or Square Seal	FP-R70956		Cooler housing w/relief valve; Oil cooler codes 5904, 5906, 5908, 5914, 5916; To Ser. No. 185,223; 2.700" X 3.000" X .180"
<b>CRANKSHAFT/OIL PUMP</b>				
<b>QTY</b>	<b>DESCRIPTION</b>	<b>PART NO.</b>	<b>SIZE</b>	<b>DESCRIPTION</b>
1	Oil Seal Kit	FP-SK67942		RePower Engs.; Incl. front & rear seals; Crankshaft codes 4702, 4710
<b>QTY</b>	<b>DESCRIPTION</b>	<b>PART NO.</b>	<b>SIZE</b>	<b>DESCRIPTION</b>
1	Crankshaft Front Seal	FP-AR67942		
1	O-Ring	FP-H35244		Crankshaft pulley; Pulley codes 1313, 1314, 1329
<b>QTY</b>	<b>DESCRIPTION</b>	<b>PART NO.</b>	<b>SIZE</b>	<b>DESCRIPTION</b>
1	Crankshaft Rear Seal	FP-RE24959		Crankshaft codes 4702, 4710
<b>QTY</b>	<b>DESCRIPTION</b>	<b>PART NO.</b>	<b>SIZE</b>	<b>DESCRIPTION</b>
3	Plain Main Brg.	FP-RE27352	STD	w/Flangeless thrust brg.
3	Plain Main Brg.	FP-RE27353	10	w/Flangeless thrust brg.
3	Plain Main Brg.	FP-RE27360	20	w/Flangeless thrust brg.
3	Plain Main Brg.	FP-RE27368	30	w/Flangeless thrust brg.
1	Flanged Main Brg.	FP-RE521350	STD	
1	Flanged Main Brg.	FP-RE526754	10	
1	Flanged Main Brg.	FP-RE527235	20	
1	Flanged Main Brg.	FP-RE527236	30	
4	Thrust Washer	FP-R78598	STD	Use w/Flangeless thrust brg.
<b>QTY</b>	<b>DESCRIPTION</b>	<b>PART NO.</b>	<b>SIZE</b>	<b>DESCRIPTION</b>
1	Pump Repair Kit	FP-RE55343		w/Pump housing marked R54615
1	O-Ring	FP-R61871		Oil pump inlet; Pump codes 5001, 5002, 5005, 5007, 5012, 5016
1	O-Ring	FP-R74354		Oil pump outlet tube; Pump codes 5001, 5002, 5005, 5007, 5008, 5009, 5010, 5011, 5012, 5013, 5014, 5015, 5016; w/Pump housing marked R54615
1	Oil Filler Inlet Gasket	FP-R97352		Oil filler neck codes 1201, 1203, 1299
<b>CYLINDER COMPONENTS</b>				
<b>QTY</b>	<b>DESCRIPTION</b>	<b>PART NO.</b>	<b>SIZE</b>	<b>DESCRIPTION</b>
3	Liner w/o Sealing Ring	FP-R116281		
3	Liner w/Sealing Rings	FP-RE500023		
3	Cylinder Kit Complete	FP-RE66968 *	STD	From Ser. No. 252768; Piston numbers RE61467, RE500210
3	Cylinder Kit Complete	FP-RE48721 *	STD	To Ser. No. 252767
3	Cyl. Liner Sealing Ring Kit	FP-AR65507		
<b>QTY</b>	<b>DESCRIPTION</b>	<b>PART NO.</b>	<b>SIZE</b>	<b>DESCRIPTION</b>
3	Piston Kit w/Pin & Retainers	FP-RE61467WP *	STD	From Ser. No. 252768
<b>QTY</b>	<b>DESCRIPTION</b>	<b>PART NO.</b>	<b>SIZE</b>	<b>DESCRIPTION</b>
6	Con. Rod Bolt	FP-R80033		w/Con. Rod marked R121092; Torque-To-Yield bolt; Replacement recommended
3	Rod Pair	FP-RE27348	STD	w/Con. Rod marked R121092
3	Rod Pair	FP-RE27349	10	w/Con. Rod marked R121092
3	Rod Pair	FP-RE27358	20	w/Con. Rod marked R121092
3	Rod Pair	FP-RE27364	30	w/Con. Rod marked R121092
<b>QTY</b>	<b>DESCRIPTION</b>	<b>PART NO.</b>	<b>SIZE</b>	<b>DESCRIPTION</b>
3	Ring Set Single Cylinder	FP-RE66271	STD	From Ser. No. 252,768; Piston codes RE61467, RE61270
3	Ring Set Single Cylinder	FP-RE507852	STD	To Ser. No. 252,767; Piston codes RE45323, RE40557; 1-1/8, 1-3/32, 1-.136 (1 cyl. set)
3	Ring Set Single Cylinder	FP-RE66820	STD	To Ser. No. 252,767; Piston codes RE45323, RE40557; 1-1/8, 1-3/32, 1-.136 (1 cyl. set)
<b>Industrial Applications 3029T Eng. 6</b> 2.9L 179.2 (2938cc) OHV Turbo-Diesel L3 (Litre Engine), 106mm Bore				
<b>CYL. HEAD &amp; PARTS</b>				
<b>QTY</b>	<b>DESCRIPTION</b>	<b>PART NO.</b>	<b>SIZE</b>	<b>DESCRIPTION</b>
1	Head Gasket	FP-R97356		Cyl. head codes 5104, 5105, 5106
<b>QTY</b>	<b>DESCRIPTION</b>	<b>PART NO.</b>	<b>SIZE</b>	<b>DESCRIPTION</b>
3	Intake	FP-R98062	STD	1 groove; Chrome plated stem; 1.8350" Head Dia., .3100" Stem Dia., 5.2780" O.A.L.
3	Intake	FP-R97490	15	1 groove; Chrome plated stem; 1.8350" Head Dia., .3250" Stem Dia., 5.2780" O.A.L.

(continued on next page)

<b>6 Industrial Applications 3029T Eng.</b>				
<b>(cont.) 2.9L 179.2 (2938cc) OHV Turbo-Diesel L3 (Litre Engine), 106mm Bore</b>				
<b>CYL. HEAD &amp; PARTS (cont.)</b>				
<b>QTY</b>	<b>VALVE (cont.)</b>	<b>PART NO.</b>	<b>SIZE</b>	<b>DESCRIPTION</b>
3	Exhaust	FP-R90692	STD	1 groove; Chrome plated stem; 1.6730" Head Dia., .3095" Stem Dia., 5.2550" O.A.L.
3	Exhaust	FP-R97492	15	1 groove; Chrome plated stem; 1.6730" Head Dia., .3245" Stem Dia., 5.2550" O.A.L.
12	Keeper	FP-R91889		
<b>QTY</b>	<b>VALVE SEAT</b>	<b>PART NO.</b>	<b>SIZE</b>	<b>DESCRIPTION</b>
3	Exh.	FP-R85687	STD	
3	Int.	FP-R98335		.020" Dia. O/S face width; 1.8575" OD, 1.5500" ID, .2580" Depth
3	Int.	FP-R98063	STD	1.8575" OD, 1.5500" ID, .2580" Depth
<b>QTY</b>	<b>VALVE SPRING</b>	<b>PART NO.</b>	<b>SIZE</b>	<b>DESCRIPTION</b>
6	Spring	FP-R26125		2.1200" Free Height
<b>QTY</b>	<b>VALVE MISC.</b>	<b>PART NO.</b>	<b>SIZE</b>	<b>DESCRIPTION</b>
6	Rotocap	FP-RE60005		Exh. & Int.
<b>QTY</b>	<b>VALVE SEAL</b>	<b>PART NO.</b>	<b>SIZE</b>	<b>DESCRIPTION</b>
6	Valve Stem Seal	FP-RE31617		Positive type
<b>QTY</b>	<b>ROCKER PARTS</b>	<b>PART NO.</b>	<b>SIZE</b>	<b>DESCRIPTION</b>
1	O-Ring	FP-R56463		Rocker cover breather tube; Breather tube code 2901 R.H.; Codes 2902, 2903 L.H.; Codes 2905, 2909, 2911, 2915, 2999
<b>INT &amp; EXH MANIFOLDS</b>				
<b>QTY</b>	<b>INT. &amp; EXH. MANIFOLDS</b>	<b>PART NO.</b>	<b>SIZE</b>	<b>DESCRIPTION</b>
3	Exhaust Manifold Gasket	FP-R90658		
<b>CAMSHAFT GROUP</b>				
<b>QTY</b>	<b>TIMING COVER</b>	<b>PART NO.</b>	<b>SIZE</b>	<b>DESCRIPTION</b>
1	Timing Gear Cover Gasket	FP-R97454		Front cover
1	Timing Gear Cover Gasket	FP-R108654		Use w/R.H. side gear dr. timing gear cover
<b>FUEL SYSTEM &amp; PARTS</b>				
<b>QTY</b>	<b>FUEL INJECTION</b>	<b>PART NO.</b>	<b>SIZE</b>	<b>DESCRIPTION</b>
3	Fuel Injector Nozzle	FP-RE36939		w/Injector marked 28484
3	Fuel Injector Seal	FP-R79605		Fuel line connection; Nozzle marked 28484; 9.270MM X 13.600MM X 5.080MM
3	Fuel Injector Nut	FP-R79604		w/Injector marked 28484
3	FI Installation Kit	FP-RE65201		
6	Washer Type Seal	FP-R51936		Leak-off & return line seals; w/Nozzle marked 28484
<b>COOLING SYSTEM</b>				
<b>QTY</b>	<b>WATER PUMP</b>	<b>PART NO.</b>	<b>SIZE</b>	<b>DESCRIPTION</b>
1	Water Pump Repair/Rebuild Kit	FP-944840979		w/Pump housing marked R52009
1	Water Pump Repair/Rebuild Kit	FP-RE62658		w/Pump housing marked R73604, R91724; From Ser. No. 100,000
1	Water Pump Housing Gasket	FP-R97455		w/Pump housing marked R73604
1	Water Pump Mounting Gasket	FP-T20243		w/H/D Pump housing marked R100812, R127918
1	Water Pump Mounting Gasket	FP-T20243		w/Pump housing marked R55164, R73604, R91724, R110541
1	Shaft & Bearing Assembly	FP-JD9448		w/Cast pulley; w/Pump housing marked R55164
<b>QTY</b>	<b>THERMOSTAT</b>	<b>PART NO.</b>	<b>SIZE</b>	<b>DESCRIPTION</b>
1	Thermostat	FP-AR61538		Thermostat code 2208; 181 Deg.
<b>ENGINE BLOCK &amp; PARTS</b>				
<b>QTY</b>	<b>GASKETS</b>	<b>PART NO.</b>	<b>SIZE</b>	<b>DESCRIPTION</b>
1	Oil Pan Gasket	FP-R97341		Exc. Alum. oil pan
1	Oil Pan Gasket Set	FP-PG300PS		Exc. Alum. oil pan; Incl. O-rings
1	Block to End Plate Front Gskt	FP-R131794		Front plate code 3604; R.H. side gear drive
<b>QTY</b>	<b>GASKET SETS</b>	<b>PART NO.</b>	<b>SIZE</b>	<b>DESCRIPTION</b>
1	In-Frame Gasket Set	FP-PG164S		
1	Complete Overhaul Gasket Set	FP-RE50978		Crankshaft seals not incl.
1	Complete Overhaul Gasket Set	FP-RE50978WS		Incl. crankshaft seals
<b>QTY</b>	<b>CAM BEARINGS</b>	<b>PART NO.</b>	<b>SIZE</b>	<b>DESCRIPTION</b>
1	Cam Brg.	FP-R119874		R.H. Side gear drive; From Ser. No. 100,000
<b>QTY</b>	<b>OIL COOLERS &amp; FILTERS</b>	<b>PART NO.</b>	<b>SIZE</b>	<b>DESCRIPTION</b>
1	Oil Cooler	FP-RE61767		w/6 plates; Cooler codes 5904, 5906, 5908, 5914, 5916; From Ser. No. 185,224
1	Rect. or Square Seal	FP-R70956		Cooler housing w/relief valve; Oil cooler codes 5904, 5906, 5908, 5914, 5916; To Ser. No. 185,223; 2.700" X 3.000" X .180"

(continued on next page)



*Industrial Applications 3029T Eng. 6*  
2.9L 179.2 (2938cc) OHV Turbo-Diesel L3 (Litre Engine), 106mm Bore (cont.)

<b>CRANKSHAFT/OIL PUMP</b>				
<b>QTY</b>	<b>CRANKSHAFT</b>	<b>PART NO.</b>	<b>SIZE</b>	<b>DESCRIPTION</b>
1	Oil Seal Kit	FP-SK67942		Incl. front & rear seals; Crankshaft codes 4702, 4704, 4705, 4710; From Ser. No. 100,000
<b>QTY</b>	<b>SEALS - FRONT CRANK</b>	<b>PART NO.</b>	<b>SIZE</b>	<b>DESCRIPTION</b>
1	Crankshaft Front Seal	FP-AR67942		
1	O-Ring	FP-H35244		Crankshaft pulley; Pulley codes 1313, 1314, 1329
<b>QTY</b>	<b>SEALS - REAR CRANK</b>	<b>PART NO.</b>	<b>SIZE</b>	<b>DESCRIPTION</b>
1	Crankshaft Rear Seal	FP-RE24959		Crankshaft codes 4702, 4704, 4705, 4710; From Ser. No. 100,000
<b>QTY</b>	<b>MAIN BEARINGS</b>	<b>PART NO.</b>	<b>SIZE</b>	<b>DESCRIPTION</b>
1	Main Set	FP-MBK3003	STD	w/Flanged thrust brg.
1	Main Set	FP-MBK300310	10	w/Flanged thrust brg.
1	Main Set	FP-MBK300320	20	w/Flanged thrust brg.
1	Main Set	FP-MBK300330	30	w/Flanged thrust brg.
3	Plain Main Brg.	FP-RE27352	STD	w/Flangeless thrust brg.
3	Plain Main Brg.	FP-RE27353	10	w/Flangeless thrust brg.
3	Plain Main Brg.	FP-RE27360	20	w/Flangeless thrust brg.
3	Plain Main Brg.	FP-RE27368	30	w/Flangeless thrust brg.
1	Flanged Main Brg.	FP-RE521350	STD	
1	Flanged Main Brg.	FP-RE526754	10	
1	Flanged Main Brg.	FP-RE527235	20	
1	Flanged Main Brg.	FP-RE527236	30	
3	Thrust Washer	FP-R78598	STD	Use w/Flangeless thrust brg.
<b>QTY</b>	<b>OIL PUMP</b>	<b>PART NO.</b>	<b>SIZE</b>	<b>DESCRIPTION</b>
1	O-Ring	FP-R61871		Oil pump inlet; Pump codes 5001, 5002, 5005, 5007, 5012, 5016
1	O-Ring	FP-R74354		Oil pump outlet tube; Pump codes 5001, 5002, 5007, 5008, 5009, 5010, 5011, 5012, 5013, 5014, 5015, 5016; w/Pump housing marked R54615
1	Oil Filler Inlet Gasket	FP-R97352		Oil filler neck code 1299
<b>CYLINDER COMPONENTS</b>				
<b>QTY</b>	<b>LINERS</b>	<b>PART NO.</b>	<b>SIZE</b>	<b>DESCRIPTION</b>
3	Liner w/o Sealing Ring	FP-R116281		
3	Liner w/Sealing Rings	FP-RE500023		
3	Cylinder Kit Complete	FP-RE33115		w/Con. Rod marked R58979, R80032, R113612
3	Cyl. Liner Sealing Ring Kit	FP-AR65507		
3	Sealing Ring, Liner	FP-R48767		Rectangle; Top
3	Sealing Ring	FP-SLR2520		Round; Bottom
<b>QTY</b>	<b>PISTONS</b>	<b>PART NO.</b>	<b>SIZE</b>	<b>DESCRIPTION</b>
3	Piston Body w/o Pin	FP-RE48368		
3	Piston Kit w/Pin & Retainers	FP-RE48368WP		
3	Pin	FP-R124230		1.62" pin dia.
6	Piston Pin Retainer	FP-R54114		For 1.62" pin dia.
3	Pin Bushing	FP-R57451		w/Con. Rod marked R56187, R58979, R80032, R113612; Pin dia. 1.62"; 1.621" ID, 1.813" OD, 1.370" O.A.L.
<b>QTY</b>	<b>CONNECTING RODS &amp; BRGS.</b>	<b>PART NO.</b>	<b>SIZE</b>	<b>DESCRIPTION</b>
6	Con. Rod Bolt	FP-R80033		w/Con. Rod marked R80032, R80034, R81410, R105011, R113612; Torque-To-Yield bolt; Replacement recommended
3	Rod Pair	FP-RE27348	STD	
3	Rod Pair	FP-RE27349	10	
3	Rod Pair	FP-RE27358	20	
3	Rod Pair	FP-RE27364	30	
<b>QTY</b>	<b>PISTON RINGS</b>	<b>PART NO.</b>	<b>SIZE</b>	<b>DESCRIPTION</b>
3	Ring Set Single Cylinder	FP-RE507852	STD	1-1/8, 1-3/32, 1-.136 (1 cyl. set)
3	Ring Set Single Cylinder	FP-RE66820	STD	1-1/8, 1-3/32, 1-.136 (1 cyl. set)
<b>KITS</b>				
<b>QTY</b>	<b>OVERHAUL KIT</b>	<b>PART NO.</b>	<b>SIZE</b>	<b>DESCRIPTION</b>
1	In-Frame Overhaul Kit	FP-179TIFK		w/Con. Rod marked R80032, R113612; Crankshaft codes 4701, 4702, 4705, 4710; Incl. Torque-To-Yield con. rod bolts
1	Complete Overhaul Kit	FP-179TOHK		w/Con. Rod marked R80032, R113612; Pin dia. 1.62"; Crankshaft codes 4702, 4704, 4705, 4710; Incl. front & rear seals; From Ser. No. 100,000; Incl. Torque-To-Yield con. rod bolts

<b>7 Industrial Applications 3029T PowerTech Eng.</b>				
2.9L 179.2 (2938cc) OHV Turbo-Diesel L3 (PowerTech 2V), 106mm Bore				
<b>CYL. HEAD &amp; PARTS</b>				
<b>QTY</b>	<b>GASKETS</b>	<b>PART NO.</b>	<b>SIZE</b>	<b>DESCRIPTION</b>
1	Head Gasket	FP-R97356		Cyl. head codes 5104, 5105, 5106
1	Head Set	FP-RE38850		
<b>QTY</b>	<b>VALVE</b>	<b>PART NO.</b>	<b>SIZE</b>	<b>DESCRIPTION</b>
3	Intake	FP-R98062	STD	1 groove; Chrome plated stem; 1.8350" Head Dia., .3100" Stem Dia., 5.2780" O.A.L.
3	Intake	FP-R97490	15	1 groove; Chrome plated stem; 1.8350" Head Dia., .3250" Stem Dia., 5.2780" O.A.L.
3	Exhaust	FP-R90692	STD	1 groove; Chrome plated stem; 1.6730" Head Dia., .3095" Stem Dia., 5.2550" O.A.L.
3	Exhaust	FP-R97492	15	1 groove; Chrome plated stem; 1.6730" Head Dia., .3245" Stem Dia., 5.2550" O.A.L.
12	Keeper	FP-R91889		Exh. & Int.
<b>QTY</b>	<b>VALVE SPRING</b>	<b>PART NO.</b>	<b>SIZE</b>	<b>DESCRIPTION</b>
6	Spring	FP-R26125		Exh. & Int.; 2.1200" Free Height
<b>QTY</b>	<b>VALVE MISC.</b>	<b>PART NO.</b>	<b>SIZE</b>	<b>DESCRIPTION</b>
6	Rotocap	FP-RE60005		Exh. & Int.
1	Oil Filler Cap Gasket	FP-T20328		Oil filler neck codes 1201, 1202, 1203, 1206
<b>QTY</b>	<b>VALVE SEAL</b>	<b>PART NO.</b>	<b>SIZE</b>	<b>DESCRIPTION</b>
6	Valve Stem Seal	FP-RE31617		Exh. & Int.; Positive type
<b>INT &amp; EXH MANIFOLDS</b>				
<b>QTY</b>	<b>INT. &amp; EXH. MANIFOLDS</b>	<b>PART NO.</b>	<b>SIZE</b>	<b>DESCRIPTION</b>
3	Exhaust Manifold Gasket	FP-R90658		Air Intake Gasket
1	Air Intake Gasket	FP-R81275		
<b>CAMSHAFT GROUP</b>				
<b>QTY</b>	<b>TIMING COVER</b>	<b>PART NO.</b>	<b>SIZE</b>	<b>DESCRIPTION</b>
1	Timing Gear Cover Gasket	FP-R97454		Front cover
1	Timing Gear Cover Gasket	FP-R108654		Use w/R.H. side gear dr. timing gear cover
<b>QTY</b>	<b>CAMSHAFT/LIFTER</b>	<b>PART NO.</b>	<b>SIZE</b>	<b>DESCRIPTION</b>
6	Lifter	FP-T20073		
<b>FUEL SYSTEM &amp; PARTS</b>				
<b>QTY</b>	<b>FUEL INJECTION</b>	<b>PART NO.</b>	<b>SIZE</b>	<b>DESCRIPTION</b>
3	Fuel Injector Nozzle	FP-RE36935		w/Injector marked 28484
3	Fuel Injector Nozzle	FP-RE48786		w/Injector marked 29279
3	Fuel Injector Nut	FP-R79604		w/Injector marked 28484, 29279
3	F1 Installation Kit	FP-RE65201		
6	Washer Type Seal	FP-R51936		Leak-off & return line seals; w/Nozzle marked 28480, 28484, 29279
3	Washer Type Seal	FP-R48000		Lower; w/Nozzle marked 28480, 28484
3	Washer Type Seal	FP-R60746		Upper; w/Nozzle marked 28480
<b>COOLING SYSTEM</b>				
<b>QTY</b>	<b>WATER PUMP</b>	<b>PART NO.</b>	<b>SIZE</b>	<b>DESCRIPTION</b>
1	Water Pump Repair/Rebuild Kit	FP-RE62658		Pump codes 2010, 2020, 2022, 2023; w/Pump housing marked R73604
1	Water Pump Housing Gasket	FP-R97455		w/Pump housing marked R73604
1	Water Pump Mounting Gasket	FP-T20243		w/H/D Pump housing marked R100812, R127918
1	Water Pump Mounting Gasket	FP-T20243		w/Pump housing marked R48997, R55164, R73604, R110541
<b>QTY</b>	<b>THERMOSTAT</b>	<b>PART NO.</b>	<b>SIZE</b>	<b>DESCRIPTION</b>
1	Thermostat Cover Gasket	FP-T20215		Thermostat cover codes 2101, 2102
1	Therm. Hsg. - Water Mfld. Gsk	FP-R54641		Thermostat housing to cyl. head; To Ser. No. 205,211
<b>ENGINE BLOCK &amp; PARTS</b>				
<b>QTY</b>	<b>GASKETS</b>	<b>PART NO.</b>	<b>SIZE</b>	<b>DESCRIPTION</b>
1	Oil Pan Gasket	FP-R97341		Exc. Alum. oil pan
1	Oil Pan Gasket Set	FP-PG300PS		Exc. Alum. oil pan; Incl. O-rings
1	Block to End Plate Front Gskt	FP-R131794		Front plate code 3604; R.H. side gear drive
<b>QTY</b>	<b>GASKET SETS</b>	<b>PART NO.</b>	<b>SIZE</b>	<b>DESCRIPTION</b>
1	In-Frame Gasket Set	FP-PG164S		
1	Complete Overhaul Gasket Set	FP-RE50978		Crankshaft seals not incl.
1	Complete Overhaul Gasket Set	FP-RE50978WS		Incl. crankshaft seals
<b>QTY</b>	<b>CAM BEARINGS</b>	<b>PART NO.</b>	<b>SIZE</b>	<b>DESCRIPTION</b>
1	Cam Brg.	FP-R119874		

(continued on next page)



**Industrial Applications 3029T PowerTech Eng. 7**  
2.9L 179.2 (2938cc) OHV Turbo-Diesel L3 (PowerTech 2V), 106mm Bore (cont.)

**ENGINE BLOCK & PARTS (cont.)**

QTY	OIL COOLERS & FILTERS	PART NO.	SIZE	DESCRIPTION
1	Oil Cooler	FP-RE61767		Cooler codes 5904, 5906, 5908, 5914, 5920
1	Rect. or Square Seal	FP-R70956		Cooler housing w/relief valve; Oil cooler codes 5904, 5906, 5908, 5914, 5916; To Ser. No. 185,223; 2.700" X 3.000" X .180"

**CRANKSHAFT/OIL PUMP**

QTY	CRANKSHAFT	PART NO.	SIZE	DESCRIPTION
1	Oil Seal Kit	FP-SK67942		Incl. front & rear seals; Crankshaft codes 4702, 4704, 4705, 4710; From Ser. No. 100,000

QTY	SEALS - FRONT CRANK	PART NO.	SIZE	DESCRIPTION
1	Crankshaft Front Seal	FP-AR67942		
1	O-Ring	FP-H35244		Crankshaft pulley; Pulley codes 1313, 1314, 1329

QTY	SEALS - REAR CRANK	PART NO.	SIZE	DESCRIPTION
1	Crankshaft Rear Seal	FP-RE24959		Crankshaft codes 4702, 4704, 4705, 4710; From Ser. No. 100,000

QTY	MAIN BEARINGS	PART NO.	SIZE	DESCRIPTION
3	Plain Main Brg.	FP-RE27352	STD	w/Flangeless thrust brg.
3	Plain Main Brg.	FP-RE27353	10	w/Flangeless thrust brg.
3	Plain Main Brg.	FP-RE27360	20	w/Flangeless thrust brg.
3	Plain Main Brg.	FP-RE27368	30	w/Flangeless thrust brg.
1	Flanged Main Brg.	FP-RE521350	STD	
1	Flanged Main Brg.	FP-RE526754	10	
1	Flanged Main Brg.	FP-RE527235	20	
1	Flanged Main Brg.	FP-RE527236	30	
4	Thrust Washer	FP-R78598	STD	Use w/Flangeless thrust brg.

QTY	OIL PUMP	PART NO.	SIZE	DESCRIPTION
1	Pump Repair Kit	FP-RE55343		w/Pump housing marked R54615
1	O-Ring	FP-R61871		Oil pump inlet; Pump codes 5001, 5002, 5005, 5007, 5012, 5016
1	O-Ring	FP-R74354		Oil pump outlet tube; Pump codes 5001, 5002, 5005, 5007, 5008, 5009, 5010, 5011, 5012, 5013, 5014, 5015, 5016; w/Pump housing marked R54615
1	Oil Filler Inlet Gasket	FP-R97352		Oil filler neck codes 1201, 1203, 1299

**CYLINDER COMPONENTS**

QTY	LINERS	PART NO.	SIZE	DESCRIPTION
3	Liner w/o Sealing Ring	FP-R116281		
3	Liner w/Sealing Rings	FP-RE500023		
3	Cylinder Kit Complete	FP-RE67426 *	STD	From Ser. No. 258847
3	Cylinder Kit Complete	FP-RE48724 *	STD	To Ser. No. 258846
3	Cyl. Liner Sealing Ring Kit	FP-AR65507		

QTY	PISTONS	PART NO.	SIZE	DESCRIPTION
6	Piston Pin Retainer	FP-R54114		For 1.62" pin dia.

QTY	CONNECTING RODS & BRGS.	PART NO.	SIZE	DESCRIPTION
6	Con. Rod Bolt	FP-R80033		w/Con. Rod marked R105011; Torque-To-Yield bolt; Replacement recommended
3	Rod Pair	FP-RE27348	STD	w/Con. Rod marked R105011
3	Rod Pair	FP-RE27349	10	w/Con. Rod marked R105011
3	Rod Pair	FP-RE27358	20	w/Con. Rod marked R105011
3	Rod Pair	FP-RE27364	30	w/Con. Rod marked R105011

QTY	PISTON RINGS	PART NO.	SIZE	DESCRIPTION
3	Ring Set Single Cylinder	FP-RE66271	STD	From Ser. No. 258,847; Piston codes RE61467, RE61270
3	Ring Set Single Cylinder	FP-RE507852	STD	To Ser. No. 258,846; Piston codes RE45323, RE40557; Piston & Liner code 4808; 1-1/8, 1-3/32, 1-.136 (1 cyl. set)
3	Ring Set Single Cylinder	FP-RE66820	STD	To Ser. No. 258,846; Piston codes RE45323, RE40557; Piston & Liner code 4808; 1-1/8, 1-3/32, 1-.136 (1 cyl. set)

**Industrial Applications 4239D Eng. 8**  
3.9L 239 OHV Diesel L4 (Standard), 4.1875" Bore

**CYL. HEAD & PARTS**

QTY	GASKETS	PART NO.	SIZE	DESCRIPTION
1	Valve Cover Gasket	FP-R73521		w/Stamped Steel Cover; Rocker arm cover codes 1101, 1102, 1106; From Ser. No. 539,557
1	Head Gasket	FP-R125863		From Ser. No. 300,000
1	Head Set	FP-RE38851		From Ser. No. 300,000

(continued on next page)

**8 Industrial Applications 4239D Eng.**  
(cont.) 3.9L 239 OHV Diesel L4 (Standard), 4.1875" Bore

CYL. HEAD & PARTS (cont.)				
QTY	VALVE	PART NO.	SIZE	DESCRIPTION
4	Intake	FP-R79623	STD	2 groove; Chrome plated stem; 1.7720" Head Dia., .3720" Stem Dia., 5.1560" O.A.L.
4	Intake	FP-R79628	3	2 groove; Chrome plated stem; 1.7720" Head Dia., .3750" Stem Dia., 5.1560" O.A.L.
4	Intake	FP-R79629	15	2 groove; Chrome plated stem; 1.7720" Head Dia., .3870" Stem Dia., 5.1560" O.A.L.
4	Intake	FP-R79630	30	2 groove; Chrome plated stem; 1.7720" Head Dia., .4020" Stem Dia., 5.1560" O.A.L.
4	Exhaust	FP-R79624	STD	1 groove; Chrome plated stem; 1.5750" Head Dia., .3720" Stem Dia., 5.1560" O.A.L.
4	Exhaust	FP-R79625	3	1 groove; Chrome plated stem; 1.5750" Head Dia., .3750" Stem Dia., 5.1560" O.A.L.
4	Exhaust	FP-R79626	15	1 groove; Chrome plated stem; 1.5750" Head Dia., .3870" Stem Dia., 5.1560" O.A.L.
4	Exhaust	FP-R79627	30	1 groove; Chrome plated stem; 1.5750" Head Dia., .4020" Stem Dia., 5.1560" O.A.L.
4	Exhaust	FP-R90692	STD	1 groove; Chrome plated stem; 1.6730" Head Dia., .3095" Stem Dia., 5.2550" O.A.L.
16	Keeper	FP-T20077		Valve, seat, spring & retainer code 5101; 1 groove; Square cut key groove; Hardened
16	Keeper	FP-41339		1 groove; Square cut key groove
16	Keeper, Bulk	VK-138B		1 groove; Square cut key groove; Carton of 1000
QTY	VALVE SEAT	PART NO.	SIZE	DESCRIPTION
4	Exh.	FP-R51734	STD	
4	Int.	FP-R73064	STD	
QTY	VALVE SPRING	PART NO.	SIZE	DESCRIPTION
8	Spring	FP-R26125		2.1200" Free Height
QTY	VALVE MISC.	PART NO.	SIZE	DESCRIPTION
8	Rotocap	FP-RE11410		Exh. & Int.; Valve, seat, spring & retainer code 5101
1	Bushing	FP-T26321		Lower
1	Bushing	FP-T20034		Upper
1	Oil Filler Cap Gasket	FP-R80135		Oil filler neck code 1201; Use w/O.E. filler neck No. R80137; L.H. Auxiliary drive
1	Oil Filler Cap Gasket	FP-T20328		Oil filler neck code 1201; Use w/O.E. filler neck No. T23614; Rocker arm cover code 1101
1	Oil Filler Cap Gasket	FP-R80135		Oil filler neck codes 1202, 1203; L.H. Auxiliary drive
1	Oil Filler Cap Gasket	FP-T20328		Oil filler neck codes 1202, 1203, 1206; Rocker arm cover code 1101; Stamped steel
QTY	VALVE SEAL	PART NO.	SIZE	DESCRIPTION
8	Valve Stem Seal	FP-R87627		Exh. & Int.; O-Ring type
ELECTRICAL				
QTY	ELECTRICAL	PART NO.	SIZE	DESCRIPTION
1	Starter to Block Gasket	FP-R53108		3-Hole mount; Starting motor codes 3001, 3013, 3017, 3018
QTY	ALTERNATOR	PART NO.	SIZE	DESCRIPTION
1	Ball Brg.	FP-JD9449		Front; Motorola No. A12NJD604; Code 3102; 12 Volt, 35 amp alternator
1	Ball Brg.	FP-JD9449		Front; Motorola No. 70D44110C01; Code 3102; 12 Volt, 55 amp alternator
1	Ball Brg.	FP-JD9449		Front; Motorola No. 70D44120C01; Code 3101; 12 Volt, 35 amp alternator
1	Ball Brg.	FP-JD9449		Front; Motorola No. 8TA2009S; Code 3104; 12 Volt, 30 amp alternator
2	Ball Brg.	FP-JD9449		Front & Rear; Motorola No. 70D42076T02; Codes 3101, 3104, 3108, 3109, 3116, 3129, 3130; 12 Volt, 65 amp alternator
INT & EXH MANIFOLDS				
QTY	INT. & EXH. MANIFOLDS	PART NO.	SIZE	DESCRIPTION
4	Exhaust Manifold Gasket	FP-R90658		
1	Air Intake Gasket	FP-R81275		
CAMSHAFT GROUP				
QTY	TIMING COVER	PART NO.	SIZE	DESCRIPTION
1	Timing Gear Cover Gasket	FP-T20273		Access cover
1	Timing Gear Cover Gasket	FP-R97454		Front cover
QTY	CAMSHAFT/LIFTER	PART NO.	SIZE	DESCRIPTION
8	Lifter	FP-T20073		

(continued on next page)



*Industrial Applications 4239D Eng. 8*  
3.9L 239 OHV Diesel L4 (Standard), 4.1875" Bore (cont.)

<b>FUEL SYSTEM &amp; PARTS</b>				
<b>QTY</b>	<b>FUEL INJECTION</b>	<b>PART NO.</b>	<b>SIZE</b>	<b>DESCRIPTION</b>
1	Injector Pump Gasket	FP-R125066		Gear cover
4	Fuel Injector Nozzle	FP-AR89564		Injector nozzle code 1602, 1603
4	Fuel Injector Seal	FP-R79605		Fuel line connection; Nozzle codes 1602, 1603, 1617, 1623, 1641, 1645, 1646; Nozzle marked 27333; 9.270MM X 13.600MM X 5.080MM
12	Washer	FP-T20055		Pump code 1602
4	Fuel Injector Nut	FP-R79604		w/Injector marked 22043, 22203, 27333; From Ser. No. 410,664
2	Clamp	FP-R34766		Pump code 3701
8	Washer Type Seal	FP-R51936		Leak-off & return line seals; Nozzle codes 1602, 1603, 1617, 1619, 1623, 1624, 1641, 1645, 1646; w/Nozzle marked 22043, 27333
4	Washer Type Seal	FP-R48000		Lower; w/Nozzle codes 1602, 1603, 1617, 1623, 1641, 1645, 1646
4	Washer Type Seal	FP-R60746		Upper; Nozzle codes 1602, 1603, 1617, 1623, 1641, 1645, 1646
<b>QTY</b>	<b>FUEL FILTERS &amp; PUMP</b>	<b>PART NO.</b>	<b>SIZE</b>	<b>DESCRIPTION</b>
1	Mechanical Fuel Pump	FP-RE42211		Transfer pump
1	Injector Pump Mount Gasket	FP-R97354		w/Roto-Diesel fuel pump
1	Fuel Transfer Pump Gasket	FP-R97350		
<b>COOLING SYSTEM</b>				
<b>QTY</b>	<b>WATER PUMP</b>	<b>PART NO.</b>	<b>SIZE</b>	<b>DESCRIPTION</b>
1	Water Pump Impeller	FP-R47191		w/Pump housing marked R66420, R68733
1	Water Pump Impeller	FP-R94419		Pump codes 2004, 2021; w/Pump housing marked R73604, R100871, R111028
1	Water Pump Impeller	FP-R94419		Pump codes 2005, 2022; w/Pump housing marked R55164
1	Water Pump Repair/Rebuild Kit	FP-944840979		w/Pump housing marked R52009
1	Water Pump Repair/Rebuild Kit	FP-925740979		w/Pump housing marked R56787, R62902
1	Water Pump Repair/Rebuild Kit	FP-RE62661		w/Pump housing marked R66420, R68733
1	Water Pump Housing Gasket	FP-R55406		w/Pump housing marked R55130
1	Water Pump Housing Gasket	FP-R55405		w/Pump housing marked R55164; Pump housing to cover; Pump code 2005
1	Water Pump Housing Gasket	FP-R56809		w/Pump housing marked R55164; Pump to block; Pump code 2004
1	Water Pump Housing Gasket	FP-R97455		w/Pump housing marked R55758, R73604, R100871, R111028
1	Oil Seal Kit	FP-AR101549		Water Pump; w/Pump housing marked R100871, R111028, R55164, R55758, R73604
1	Water Pump Mounting Gasket	FP-T20243		w/Pump housing marked R55130, R55164, R55758, R73604, R100871, R111028
1	Shaft & Bearing Assembly	FP-JD9257		w/Pump housing marked R55164, R55758, R73604, R100871, R111028
<b>QTY</b>	<b>THERMOSTAT</b>	<b>PART NO.</b>	<b>SIZE</b>	<b>DESCRIPTION</b>
1	Thermostat	FP-RE33705		Thermostat code 2204; Housing code marked R60256; 180 Deg.
1	Thermostat Gasket	FP-T20219		Single thermostat cover codes 2101, 2102, 2204, 3901
1	Thermostat Cover Gasket	FP-T20215		Single thermostat cover codes 2101, 2102, 2204, 3901
2	O-Ring	FP-R56461		Thermostat housing tube seals
<b>ENGINE BLOCK &amp; PARTS</b>				
<b>QTY</b>	<b>GASKETS</b>	<b>PART NO.</b>	<b>SIZE</b>	<b>DESCRIPTION</b>
1	Flywheel Housing Gasket	FP-R97351		Flywheel housing codes 1404, 1405, 1410, 1418, 1421, 1423, 1425
1	Oil Pan Gasket	FP-R119360		w/Sheet metal pan; Oil pan codes 1901, 1902, 1903; w/Cast iron oil pan
1	Oil Pan Gasket	FP-R97342		Oil pan code 1908; Deep sump; w/Stamped Steel Pan
1	Block to End Plate Front Gskt	FP-R131794		Front plate codes 3601, 3602
<b>QTY</b>	<b>GASKET SETS</b>	<b>PART NO.</b>	<b>SIZE</b>	<b>DESCRIPTION</b>
1	In-Frame Gasket Set	FP-PG219S		Crankshaft seals not incl.
1	Complete Overhaul Gasket Set	FP-RE38857		Incl. crankshaft seals; Rear main brg. seal incl.; Wear sleeve not incl.
1	Complete Overhaul Gasket Set	FP-RE38857WS		Incl. crankshaft seals; Rear main brg. seal incl.; Wear sleeve not incl.
1	Kit Gasket Set	260-1392		Compl.; Rear main brg. seal incl.; Wear sleeve incl.
<b>QTY</b>	<b>CAM BEARINGS</b>	<b>PART NO.</b>	<b>SIZE</b>	<b>DESCRIPTION</b>
6	Cam Brg.	FP-R91708		Cyl. block codes 4601, 4602; 2.0MM O/S OD; Balance shaft bushing
<b>QTY</b>	<b>ENGINE BEARING MISC.</b>	<b>PART NO.</b>	<b>SIZE</b>	<b>DESCRIPTION</b>
1	Bal. Shaft Set	FP-R57160S		
6	Balance Shaft Bearing	FP-R57160		

(continued on next page)

<b>8 Industrial Applications 4239D Eng.</b>				
<b>(cont.) 3.9L 239 OHV Diesel L4 (Standard), 4.1875" Bore</b>				
<b>ENGINE BLOCK &amp; PARTS (cont.)</b>				
<b>QTY</b>	<b>OIL COOLERS &amp; FILTERS</b>	<b>PART NO.</b>	<b>SIZE</b>	<b>DESCRIPTION</b>
1	Washer	FP-R105714		Oil cooler; Modine Oil Cooler codes 5904, 5906, 5907; To Ser. No. 794,193
1	Rect. or Square Seal	FP-R70956		Cooler housing; Cooler code 5906; Water pump codes 2004, 2021; From Ser. No. 498,386 to Ser. No. 794,193; 2.700" X 3.000" X .180"
1	Rect. or Square Seal	FP-R70956		Cooler housing; Cooler codes 5904, 5906; Water pump codes 2004, 2021; From Ser. No. 794,194; 2.700" X 3.000" X .180"
1	Rect. or Square Seal	FP-R70956		Cooler housing; Cooler codes 5905, 5906; Water pump codes 2004, 2005; To Ser. No. 498,385; 2.700" X 3.000" X .180"
<b>CRANKSHAFT/OIL PUMP</b>				
<b>QTY</b>	<b>CRANKSHAFT</b>	<b>PART NO.</b>	<b>SIZE</b>	<b>DESCRIPTION</b>
1	Crankshaft	FP-RE20585		From Ser. No. 769,620
1	Crankshaft	FP-AT18030		To Ser. No. 769,619
1	Oil Seal Kit	FP-SK67942		Incl. front & rear seals; Crankshaft codes 4701, 4702; Crankshaft marked R81959; From Ser. No. 769,620
1	Oil Seal Kit	FP-SK67942		Incl. front & rear seals; Crankshaft codes 4701, 4702; Crankshaft marked T23517; To Ser. No. 769,619
<b>QTY</b>	<b>SEALS - FRONT CRANK</b>	<b>PART NO.</b>	<b>SIZE</b>	<b>DESCRIPTION</b>
1	Crankshaft Front Seal	FP-AR67942		
1	O-Ring	FP-H35244		Crankshaft pulley; Crankshaft, Bearing codes 4701, 4702
<b>QTY</b>	<b>SEALS - REAR CRANK</b>	<b>PART NO.</b>	<b>SIZE</b>	<b>DESCRIPTION</b>
1	Crankshaft Rear Seal	FP-RE24959		Crankshaft, Bearing codes 4701, 4702; Flywheel housing codes 1403, 1404, 1405, 1410, 1421, 1425, 1432
<b>QTY</b>	<b>MAIN BEARINGS</b>	<b>PART NO.</b>	<b>SIZE</b>	<b>DESCRIPTION</b>
1	Main Set	FP-MBK3004	STD	w/Flanged thrust brg.
1	Main Set	FP-MBK300410	10	w/Flanged thrust brg.
1	Main Set	FP-MBK300420	20	w/Flanged thrust brg.
1	Main Set	FP-MBK300430	30	w/Flanged thrust brg.
4	Plain Main Brg.	FP-RE27352	STD	w/Flangeless thrust brg.
4	Plain Main Brg.	FP-RE27353	10	w/Flangeless thrust brg.
4	Plain Main Brg.	FP-RE27360	20	w/Flangeless thrust brg.
4	Plain Main Brg.	FP-RE27368	30	w/Flangeless thrust brg.
1	Flanged Main Brg.	FP-RE521350	STD	
1	Flanged Main Brg.	FP-RE526754	10	
1	Flanged Main Brg.	FP-RE527235	20	
1	Flanged Main Brg.	FP-RE527236	30	
4	Thrust Washer	FP-R78598	STD	
<b>QTY</b>	<b>OIL PUMP</b>	<b>PART NO.</b>	<b>SIZE</b>	<b>DESCRIPTION</b>
1	Pump Repair Kit	FP-RE55343		Pump code 5001; w/Pump housing marked R54615
1	O-Ring	FP-R61871		Oil pump inlet; Pump codes 5001, 5002
1	O-Ring	FP-R74354		Oil pump outlet tube; Pump codes 5001, 5002
1	Oil Filler Inlet Gasket	FP-R97352		Oil filler neck codes 1200, 1299; No filler neck
1	Oil Filler Inlet Gasket	FP-R97352		Oil filler neck codes 1201, 1203
1	Oil Filler Inlet Gasket	FP-R97352		Oil filler neck codes 1202, 1206; To Ser. No. 703,963
<b>CYLINDER COMPONENTS</b>				
<b>QTY</b>	<b>LINERS</b>	<b>PART NO.</b>	<b>SIZE</b>	<b>DESCRIPTION</b>
4	Liner w/o Sealing Ring	FP-R116281		
4	Liner w/Sealing Rings	FP-RE500023		
4	Cylinder Kit Complete	FP-RE30250	STD	w/Con. Rod marked R51727, R80034
4	Cyl. Liner Sealing Ring Kit	FP-AR65507		
4	Sealing Ring, Liner	FP-R48767		Rectangle; Top
4	Sealing Ring	FP-SLR2520		Round; Bottom
<b>QTY</b>	<b>PISTONS</b>	<b>PART NO.</b>	<b>SIZE</b>	<b>DESCRIPTION</b>
4	Piston Body w/o Pin	FP-RE19282		
4	Piston Kit w/Pin & Retainers	FP-RE19282WP		
4	Pin	FP-R125754		1.38" pin dia.
8	Piston Pin Retainer	FP-M41029		For 1.38" pin dia.
4	Pin Bushing	FP-R55647		w/Con. Rod marked R51727, R80032, R80034; 1.3765" ID, 1.500" OD, 1.570" O.A.L.
<b>QTY</b>	<b>CONNECTING RODS &amp; BRGS.</b>	<b>PART NO.</b>	<b>SIZE</b>	<b>DESCRIPTION</b>
8	Con. Rod Bolt	FP-R80033		w/Con. Rod marked R80032, R80034, R81410, R105011, R113612; Torque-To-Yield bolt; Replacement recommended
8	Con. Rod Bolt	FP-R74194		w/Con. Rod marked T20007, R51727, R58979; Torque-To-Yield bolt; Replacement recommended
4	Rod Pair	FP-RE27348	STD	

(continued on next page)





**Industrial Applications 4239D Eng. 8**  
3.9L 239 OHV Diesel L4 (Standard), 4.1875" Bore (cont.)

<b>CYLINDER COMPONENTS (cont.)</b>				
<b>CONNECTING RODS &amp; BRGS. (cont.)</b>				
QTY		PART NO.	SIZE	DESCRIPTION
4	Rod Pair	FP-RE27349	10	
4	Rod Pair	FP-RE27358	20	
4	Rod Pair	FP-RE27364	30	
<b>PISTON RINGS</b>				
QTY		PART NO.	SIZE	DESCRIPTION
4	Ring Set Single Cylinder	FP-RE507852	STD	1-1/8, 1-3/32, 1-.136 (1 cyl. set)
4	Ring Set Single Cylinder	FP-RE66820	STD	1-1/8, 1-3/32, 1-.136 (1 cyl. set)
<b>KITS</b>				
QTY	OVERHAUL KIT	PART NO.	SIZE	DESCRIPTION
1	In-Frame Overhaul Kit	FP-239DIFK		w/Con. Rod marked R51727, R80034
1	Complete Overhaul Kit	FP-239DOHK		w/Con. Rod marked R51727, R80032, R80034; Incl. front & rear seals; Crankshaft codes 4701, 4702; Crankshaft marked R81959 from Ser. No. 769,620; Incl. Torque-To-Yield con. rod bolts
1	Complete Overhaul Kit	FP-239DOHK		w/Con. Rod marked R51727, R80032, R80034; Incl. front & rear seals; Crankshaft codes 4701, 4702; Crankshaft marked T23517 to Ser. No. 769,619; Incl. Torque-To-Yield con. rod bolts

**Industrial Applications 4239T Eng. 9**  
3.9L 239 OHV Turbo-Diesel L4 (Standard), 4.1875" Bore

<b>CYL. HEAD &amp; PARTS</b>				
<b>GASKETS</b>				
QTY		PART NO.	SIZE	DESCRIPTION
1	Valve Cover Gasket	FP-R73521		w/Stamped Steel Cover; Rocker arm cover codes 1101, 1102, 1106
1	Head Gasket	FP-R125863		
1	Head Set	FP-RE38851		
<b>VALVE</b>				
QTY		PART NO.	SIZE	DESCRIPTION
4	Intake	FP-R83071	STD	Stellite; 2 groove; Chrome plated stem; 1.8210" Head Dia., .3720" Stem Dia., 5.1660" O.A.L.
4	Intake	FP-R89223	3	Stellite; 2 groove; Chrome plated stem; 1.8210" Head Dia., .3750" Stem Dia., 5.1660" O.A.L.
4	Intake	FP-R89224	15	Stellite; 2 groove; Chrome plated stem; 1.8210" Head Dia., .3870" Stem Dia., 5.1660" O.A.L.
4	Intake	FP-R79623	STD	2 groove; Chrome plated stem; 1.7720" Head Dia., .3720" Stem Dia., 5.1560" O.A.L.
4	Intake	FP-R79628	3	2 groove; Chrome plated stem; 1.7720" Head Dia., .3750" Stem Dia., 5.1560" O.A.L.
4	Intake	FP-R79629	15	2 groove; Chrome plated stem; 1.7720" Head Dia., .3870" Stem Dia., 5.1560" O.A.L.
4	Intake	FP-R79630	30	2 groove; Chrome plated stem; 1.7720" Head Dia., .4020" Stem Dia., 5.1560" O.A.L.
4	Exhaust	FP-R79624	STD	1 groove; Chrome plated stem; 1.5750" Head Dia., .3720" Stem Dia., 5.1560" O.A.L.
4	Exhaust	FP-R79625	3	1 groove; Chrome plated stem; 1.5750" Head Dia., .3750" Stem Dia., 5.1560" O.A.L.
4	Exhaust	FP-R79626	15	1 groove; Chrome plated stem; 1.5750" Head Dia., .3870" Stem Dia., 5.1560" O.A.L.
4	Exhaust	FP-R79627	30	1 groove; Chrome plated stem; 1.5750" Head Dia., .4020" Stem Dia., 5.1560" O.A.L.
16	Keeper	FP-T20077		Valve, seat, spring & retainer code 5102; 1 groove; Square cut key groove; Hardened
16	Keeper	FP-41339		1 groove; Square cut key groove
16	Keeper, Bulk	VK-138B		1 groove; Square cut key groove; Carton of 1000
<b>VALVE SEAT</b>				
QTY		PART NO.	SIZE	DESCRIPTION
4	Exh.	FP-R51734	STD	
4	Int.	FP-R73064	STD	
<b>VALVE SPRING</b>				
QTY		PART NO.	SIZE	DESCRIPTION
8	Spring	FP-R26125		2.1200" Free Height
<b>VALVE MISC.</b>				
QTY		PART NO.	SIZE	DESCRIPTION
8	Rotocap	FP-RE11410		Exh. & Int.; Valve, seat, spring & retainer code 5102
1	Bushing	FP-T26321		Lower
1	Bushing	FP-T20034		Upper
1	Oil Filler Cap Gasket	FP-T20328		Oil filler neck code 1299; No filler neck
1	Oil Filler Cap Gasket	FP-T20328		Oil filler neck codes 1201, 1202, 1203, 1206
1	Oil Filler Cap Gasket	FP-T20328		Rocker arm cover codes 1102, 1104; Stamped steel

(continued on next page)

<b>9 Industrial Applications 4239T Eng.</b>				
<b>(cont.) 3.9L 239 OHV Turbo-Diesel L4 (Standard), 4.1875" Bore</b>				
<b>CYL. HEAD &amp; PARTS (cont.)</b>				
<b>QTY</b>	<b>VALVE SEAL</b>	<b>PART NO.</b>	<b>SIZE</b>	<b>DESCRIPTION</b>
8	Valve Stem Seal	FP-R87627		Exh. & Int.; O-Ring type
<b>ELECTRICAL</b>				
<b>QTY</b>	<b>ELECTRICAL</b>	<b>PART NO.</b>	<b>SIZE</b>	<b>DESCRIPTION</b>
1	Starter to Block Gasket	FP-R53108		3-Hole mount; Starting motor codes 3001, 3013, 3017, 3018
<b>QTY</b>	<b>ALTERNATOR</b>	<b>PART NO.</b>	<b>SIZE</b>	<b>DESCRIPTION</b>
1	Ball Brg.	FP-JD9449		Front; Motorola No. A12NJD453; Code 3102; 12 Volt, 35 amp alternator
1	Ball Brg.	FP-JD9449		Front; Motorola No. 70D44110C01; 12 Volt, 55 amp alternator
1	Ball Brg.	FP-JD9449		Front; Motorola No. 70D44120C01; Code 3101; 12 Volt, 35 amp alternator
1	Ball Brg.	FP-JD9449		Front; Motorola No. 8TA2009S; Code 3104; 12 Volt, 55 amp alternator
2	Ball Brg.	FP-JD9449		Front & Rear; Motorola No. 70D42076T02; Code 3104; 12 Volt, 65 amp alternator
2	Ball Brg.	FP-JD9449		Front & Rear; Motorola No. 70D42076T02; Codes 3101, 3108, 3109, 3116, 3129, 3130; 65 amp alternator
<b>INT &amp; EXH MANIFOLDS</b>				
<b>QTY</b>	<b>INT. &amp; EXH. MANIFOLDS</b>	<b>PART NO.</b>	<b>SIZE</b>	<b>DESCRIPTION</b>
4	Exhaust Manifold Gasket	FP-R90658		
1	Air Intake Gasket	FP-R81275		
<b>CAMSHAFT GROUP</b>				
<b>QTY</b>	<b>TIMING COVER</b>	<b>PART NO.</b>	<b>SIZE</b>	<b>DESCRIPTION</b>
1	Timing Gear Cover Gasket	FP-T20273		Access cover
1	Timing Gear Cover Gasket	FP-R97454		Front cover
<b>QTY</b>	<b>CAMSHAFT/LIFTER</b>	<b>PART NO.</b>	<b>SIZE</b>	<b>DESCRIPTION</b>
8	Lifter	FP-T20073		
<b>FUEL SYSTEM &amp; PARTS</b>				
<b>QTY</b>	<b>FUEL INJECTION</b>	<b>PART NO.</b>	<b>SIZE</b>	<b>DESCRIPTION</b>
1	Injector Pump Gasket	FP-R125066		Gear cover
4	Fuel Injector Seal	FP-R79605		Fuel line connection; Nozzle codes 1602, 1603, 1606, 1623, 1635, 1636, 1641, 1643, 1650, 1651; From Ser. No. 410,664; 9.270MM X 13.600MM X 5.080MM
4	Fuel Injector Seal	FP-R92352		Upper packing; w/Injector nozzle codes 1601, 1603
4	Fuel Injector Nut	FP-R79604		w/Injector marked 22265, 26992, 26993, 27337; From Ser. No. 410,664
2	Clamp	FP-R34766		Pump code 3701
8	Washer Type Seal	FP-R51936		Leak-off & return line seals; Nozzle codes 1602, 1603, 1606, 1619, 1623, 1624, 1635, 1636, 1641, 1643, 1650, 1651; w/Nozzle marked 26992, 27337
4	Washer Type Seal	FP-R48000		Lower; w/Nozzle codes 1602, 1603, 1606, 1623, 1635, 1636, 1641, 1643, 1650, 1651
4	Washer Type Seal	FP-R60746		Upper; Nozzle codes 1602, 1603, 1606, 1623, 1635, 1636, 1641, 1643, 1650, 1651
<b>QTY</b>	<b>FUEL FILTERS &amp; PUMP</b>	<b>PART NO.</b>	<b>SIZE</b>	<b>DESCRIPTION</b>
1	Mechanical Fuel Pump	FP-RE42211		Transfer pump
1	Injector Pump Mount Gasket	FP-R97354		w/Roto-Diesel fuel pump
1	Fuel Transfer Pump Gasket	FP-R97350		
<b>QTY</b>	<b>TURBOCHARGER</b>	<b>PART NO.</b>	<b>SIZE</b>	<b>DESCRIPTION</b>
1	Turbocharger Oil Drain Gasket	FP-R105346		
1	Turbocharger Mounting Gasket	FP-R89879		Exc. Low profile turbocharger
1	Turbocharger Oil Supply Gskt.	FP-R97348		Turbo code 6501
<b>COOLING SYSTEM</b>				
<b>QTY</b>	<b>WATER PUMP</b>	<b>PART NO.</b>	<b>SIZE</b>	<b>DESCRIPTION</b>
1	Water Pump Impeller	FP-R47191		w/Pump housing marked R66420, R68733
1	Water Pump Impeller	FP-R56812		w/Pump housing marked R70612, R90783, R90785
1	Water Pump Impeller	FP-R94419		Pump codes 2005, 2022; w/Pump housing marked R55164
1	Water Pump Impeller	FP-R94419		Pump codes 2021, 2026; w/Pump housing marked R73604, R100871, R111028
1	Water Pump Repair/Rebuild Kit	FP-864340979		w/Pump housing marked R51661, R73606, R73724, R79171
1	Water Pump Repair/Rebuild Kit	FP-944840979		w/Pump housing marked R52009
1	Water Pump Repair/Rebuild Kit	FP-925740979		w/Pump housing marked R56787, R62902
1	Water Pump Repair/Rebuild Kit	FP-RE62661		w/Pump housing marked R66420, R68733
1	Water Pump Housing Gasket	FP-R55406		w/Pump housing marked R55130; Pump cover to body

(continued on next page)



*Industrial Applications 4239T Eng. 9*  
3.9L 239 OHV Turbo-Diesel L4 (Standard), 4.1875" Bore (cont.)

<b>COOLING SYSTEM (cont.)</b>				
<b>QTY</b>	<b>WATER PUMP (cont.)</b>	<b>PART NO.</b>	<b>SIZE</b>	<b>DESCRIPTION</b>
1	Water Pump Housing Gasket	FP-R55405		w/Pump housing marked R55164; Pump cover to body
1	Water Pump Housing Gasket	FP-R56809		w/Pump housing marked R56070, R56813, R70612, R90783
1	Water Pump Housing Gasket	FP-R97455		w/Pump housing marked R73604, R100871, R111028
1	Water Pump Housing Gasket	FP-R56809		w/Pump housing marked R85023, R99251
1	Oil Seal Kit	FP-AR101549		Water Pump; w/Pump housing marked R55164, R90783
1	Water Pump Mounting Gasket	FP-T20243		w/Pump housing marked R55130, R55164, R56070, R56813, R70612, R73604, R85023, R90783, R90785, R99251, R100871, R111028
1	Shaft & Bearing Assembly	FP-JD9257		w/Pump housing marked R55164, R55758, R73604, R100871, R111028
1	Shaft & Bearing Assembly	FP-JD8643		w/Pump housing marked R70612, R90783, R90785
<b>QTY</b>	<b>THERMOSTAT</b>	<b>PART NO.</b>	<b>SIZE</b>	<b>DESCRIPTION</b>
2	Thermostat	FP-AR48675		Thermostat code 2204; Thermostat cover code 2102 Vertical, 2108 Horizontal; Housing code 3901; 180 Deg.
1	Thermostat	FP-RE33705		Thermostat code 2208; Housing marked R60256; 180 Deg.
1	Thermostat Gasket	FP-T20219		Single thermostat cover codes 2101, 2109, 2208, 3906
1	Thermostat Cover Gasket	FP-T20215		Single thermostat cover codes 2101, 2109, 2208, 3906; w/housing marked R60256, T20218
1	Therm. Hsg. - Water Mfld. Gsk	FP-R54641		Thermostat housing to cyl. head
2	O-Ring	FP-R56461		Thermostat housing tube seals; Housing code 3901
<b>QTY</b>	<b>MISCELLANEOUS</b>	<b>PART NO.</b>	<b>SIZE</b>	<b>DESCRIPTION</b>
2	Water Line Gasket	FP-R97346		
<b>ENGINE BLOCK &amp; PARTS</b>				
<b>QTY</b>	<b>GASKETS</b>	<b>PART NO.</b>	<b>SIZE</b>	<b>DESCRIPTION</b>
1	Flywheel Housing Gasket	FP-R97351		Flywheel housing codes 1404, 1405, 1410, 1418, 1421, 1423, 1425
1	Oil Pan Gasket	FP-R97342		w/Stamped Steel Pan
1	Block to End Plate Front Gskt	FP-R131794		Front plate codes 3601, 3602
<b>QTY</b>	<b>GASKET SETS</b>	<b>PART NO.</b>	<b>SIZE</b>	<b>DESCRIPTION</b>
1	Gasket Conversion Set	FP-PG219CS		Wear sleeve incl.
1	In-Frame Gasket Set	FP-PG219S		
1	Complete Overhaul Gasket Set	FP-RE38857		Crankshaft seals not incl.
1	Complete Overhaul Gasket Set	FP-RE38857WS		Incl. crankshaft seals; Rear main brg. seal incl.; Wear sleeve not incl.
1	Kit Gasket Set	260-1392		Compl.; Rear main brg. seal incl.; Wear sleeve incl.
<b>QTY</b>	<b>CAM BEARINGS</b>	<b>PART NO.</b>	<b>SIZE</b>	<b>DESCRIPTION</b>
6	Cam Brg.	FP-R91708		Cyl. block codes 4601, 4602; 2.0MM O/S OD; Balance shaft bushing
<b>QTY</b>	<b>ENGINE BEARING MISC.</b>	<b>PART NO.</b>	<b>SIZE</b>	<b>DESCRIPTION</b>
1	Bal. Shaft Set	FP-R57160S		
6	Balance Shaft Bearing	FP-R57160		
<b>QTY</b>	<b>OIL COOLERS &amp; FILTERS</b>	<b>PART NO.</b>	<b>SIZE</b>	<b>DESCRIPTION</b>
1	Aftercooler Gasket Set	FP-4039A		
1	Oil Cooler	FP-RE61767		RePower Engs. DD14964, DD14965; w/Cooler codes 5904, 5906, 5908, 5914, 5916, 5995; w/6 plates; From Ser. No. 185,224
1	Washer	FP-R105714		Oil cooler; w/10 plate cooler; To Ser. No. 795,106
1	Washer	FP-R105714		Oil cooler; Oil Cooler codes 5904, 5905, 5906, 5907; To Ser. No. 794,193
1	Rect. or Square Seal	FP-R70956		Cooler housing; Cooler code 5906; Water pump code 2026; From Ser. No. 794,194; 2.700" X 3.000" X .180"
1	Rect. or Square Seal	FP-R70956		Cooler housing; Cooler code 5907; Water pump codes 2004, 2023; 2.700" X 3.000" X .180"
1	Rect. or Square Seal	FP-R70956		Cooler housing; Cooler codes 5904, 5905, 5906; Water pump codes 2004, 2005; To Ser. No. 498,385; 2.700" X 3.000" X .180"
1	Rect. or Square Seal	FP-R70956		Cooler housing; Cooler codes 5904, 5906; Water pump codes 2023, 2026; From Ser. No. 498,386 Ser. No. to 794,193; 2.700" X 3.000" X .180"
<b>CRANKSHAFT/OIL PUMP</b>				
<b>QTY</b>	<b>CRANKSHAFT</b>	<b>PART NO.</b>	<b>SIZE</b>	<b>DESCRIPTION</b>
1	Crankshaft	FP-RE20585		From Ser. No. 769,620
1	Crankshaft	FP-AT18030		To Ser. No. 769,619
1	Oil Seal Kit	FP-SK67942		Incl. front & rear seals; Crankshaft codes 4701, 4702; Crankshaft marked R81959; From Ser. No. 769,620
1	Oil Seal Kit	FP-SK67942		Incl. front & rear seals; Crankshaft codes 4701, 4702; Crankshaft marked T23517; To Ser. No. 769,619

(continued on next page)

<b>9 Industrial Applications 4239T Eng.</b>				
<b>(cont.) 3.9L 239 OHV Turbo-Diesel L4 (Standard), 4.1875" Bore</b>				
<b>CRANKSHAFT/OIL PUMP (cont.)</b>				
<b>QTY</b>	<b>SEALS - FRONT CRANK</b>	<b>PART NO.</b>	<b>SIZE</b>	<b>DESCRIPTION</b>
1	Crankshaft Front Seal	FP-AR67942		
1	O-Ring	FP-H35244		Crankshaft pulley; Pulley codes 1301, 1307, 1315; Crankshaft, Bearing codes 4701, 4702
<b>QTY</b>	<b>SEALS - REAR CRANK</b>	<b>PART NO.</b>	<b>SIZE</b>	<b>DESCRIPTION</b>
1	Crankshaft Rear Seal	FP-RE24959		Crankshaft, Bearing codes 4701, 4702; Flywheel housing codes 1403, 1404, 1405, 1410, 1421, 1425, 1432
<b>QTY</b>	<b>MAIN BEARINGS</b>	<b>PART NO.</b>	<b>SIZE</b>	<b>DESCRIPTION</b>
1	Main Set	FP-MBK3004	STD	w/Flanged thrust brg.
1	Main Set	FP-MBK300410	10	w/Flanged thrust brg.
1	Main Set	FP-MBK300420	20	w/Flanged thrust brg.
1	Main Set	FP-MBK300430	30	w/Flanged thrust brg.
4	Plain Main Brg.	FP-RE27352	STD	w/Flangeless thrust brg.
4	Plain Main Brg.	FP-RE27353	10	w/Flangeless thrust brg.
4	Plain Main Brg.	FP-RE27360	20	w/Flangeless thrust brg.
4	Plain Main Brg.	FP-RE27368	30	w/Flangeless thrust brg.
1	Flanged Main Brg.	FP-RE521350	STD	
1	Flanged Main Brg.	FP-RE526754	10	
1	Flanged Main Brg.	FP-RE527235	20	
1	Flanged Main Brg.	FP-RE527236	30	
4	Thrust Washer	FP-R78598	STD	
<b>QTY</b>	<b>OIL PUMP</b>	<b>PART NO.</b>	<b>SIZE</b>	<b>DESCRIPTION</b>
1	O-Ring	FP-R61871		Oil pump inlet; Pump codes 5001, 5007; w/Pump housing marked R54615, R54629
1	O-Ring	FP-R74354		Oil pump outlet tube; Pump codes 5001, 5007; w/Pump housing marked R54615
1	Oil Filler Inlet Gasket	FP-R97352		Oil filler neck codes 1201, 1203, 1299
1	Oil Filler Inlet Gasket	FP-R97352		Oil filler neck codes 1202, 1206; To Ser. No. 703,963
1	Oil Pump Seal Ring	FP-R79563		Oil pump outlet adapter; Pump code 5001
<b>CYLINDER COMPONENTS</b>				
<b>QTY</b>	<b>LINERS</b>	<b>PART NO.</b>	<b>SIZE</b>	<b>DESCRIPTION</b>
4	Liner w/o Sealing Ring	FP-R116281		
4	Liner w/Sealing Rings	FP-RE500023		
4	Cylinder Kit Complete	FP-RE33115		w/Con. Rod marked R58979, R80032, R113612
4	Cyl. Liner Sealing Ring Kit	FP-AR65507		
4	Sealing Ring, Liner	FP-R48767		Rectangle; Top
4	Sealing Ring, Liner	FP-R26121		Round; Middle
4	Sealing Ring	FP-SLR2520		Round; Bottom
<b>QTY</b>	<b>PISTONS</b>	<b>PART NO.</b>	<b>SIZE</b>	<b>DESCRIPTION</b>
4	Piston Body w/o Pin	FP-RE48368		
4	Piston Kit w/Pin & Retainers	FP-RE48368WP		
4	Pin	FP-R124230		1.62" pin dia.
8	Piston Pin Retainer	FP-R54114		For 1.62" pin dia.
4	Pin Bushing	FP-R57451		w/Con. Rod marked R56187, R58979, R80032, R113612; Pin dia. 1.62"; 1.621" ID, 1.813" OD, 1.370" O.A.L.
<b>QTY</b>	<b>CONNECTING RODS &amp; BRGS.</b>	<b>PART NO.</b>	<b>SIZE</b>	<b>DESCRIPTION</b>
8	Con. Rod Bolt	FP-R80033		w/Con. Rod marked R80032, R113612; Torque-To-Yield bolt; Replacement recommended
8	Con. Rod Bolt	FP-R74194		w/Con. Rod marked T20007, R51727, R58979; Torque-To-Yield bolt; Replacement recommended
4	Rod Pair	FP-RE27348	STD	
4	Rod Pair	FP-RE27349	10	
4	Rod Pair	FP-RE27358	20	
4	Rod Pair	FP-RE27364	30	
<b>QTY</b>	<b>PISTON RINGS</b>	<b>PART NO.</b>	<b>SIZE</b>	<b>DESCRIPTION</b>
4	Ring Set Single Cylinder	FP-RE507852	STD	1-1/8, 1-3/32, 1-.136 (1 cyl. set)
4	Ring Set Single Cylinder	FP-RE66820	STD	1-1/8, 1-3/32, 1-.136 (1 cyl. set)
<b>KITS</b>				
<b>QTY</b>	<b>OVERHAUL KIT</b>	<b>PART NO.</b>	<b>SIZE</b>	<b>DESCRIPTION</b>
1	In-Frame Overhaul Kit	FP-239TIFK		w/Con. Rod marked R58979, R80032, R113612; Incl. Torque-To-Yield con. rod bolts
1	Complete Overhaul Kit	FP-239TOHK		w/Con. Rod marked R58979, R80032, R113612; Pin dia. 1.62"; Crankshaft codes 4701, 4702; Crankshaft marked R81959 from Ser. No. 769,620; Incl. front & rear seals; Incl. Torque-To-Yield con. rod bolts

(continued on next page)



**Industrial Applications 4239T Eng. 9**  
3.9L 239 OHV Turbo-Diesel L4 (Standard), 4.1875" Bore (cont.)

**KITS (cont.)**

QTY	OVERHAUL KIT (cont.)	PART NO.	SIZE	DESCRIPTION
1	Complete Overhaul Kit	FP-239TOHK		w/Con. Rod marked R58979, R80032, R113612; Pin dia. 1.62"; Crankshaft codes 4701, 4702; Crankshaft marked T23517 to Ser. No. 769,619; Incl. front & rear seals; Incl. Torque-To-Yield con. rod bolts

**Industrial Applications 4039D Eng. 10**  
3.9L 239 (3917cc) OHV Diesel L4 (Litre Engine), 106mm Bore

**CYL. HEAD & PARTS**

QTY	GASKETS	PART NO.	SIZE	DESCRIPTION
1	Valve Cover Gasket	FP-R73521		w/Stamped Steel Cover; Rocker arm cover codes 1101, 1102, 1106
1	Head Gasket	FP-R125863		From Ser. No. 300,000
1	Head Set	FP-RE38851		From Ser. No. 300,000
QTY	VALVE	PART NO.	SIZE	DESCRIPTION
4	Intake	FP-R98062	STD	1 groove; Chrome plated stem; 1.8350" Head Dia., .3100" Stem Dia., 5.2780" O.A.L.
4	Intake	FP-R97490	15	1 groove; Chrome plated stem; 1.8350" Head Dia., .3250" Stem Dia., 5.2780" O.A.L.
4	Exhaust	FP-R90692	STD	1 groove; Chrome plated stem; 1.6730" Head Dia., .3095" Stem Dia., 5.2550" O.A.L.
4	Exhaust	FP-R97492	15	1 groove; Chrome plated stem; 1.6730" Head Dia., .3245" Stem Dia., 5.2550" O.A.L.
16	Keeper	FP-R91889		Exh. & Int.
QTY	VALVE SEAT	PART NO.	SIZE	DESCRIPTION
4	Exh.	FP-R85687	STD	.020" Dia. O/S face width; 1.8575" OD, 1.5500" ID, .2580" Depth
4	Int.	FP-R98335		
4	Int.	FP-R98063	STD	
QTY	VALVE SPRING	PART NO.	SIZE	DESCRIPTION
8	Spring	FP-R26125		Exh. & Int.; 2.1200" Free Height
QTY	VALVE MISC.	PART NO.	SIZE	DESCRIPTION
8	Rotocap	FP-RE60005		Exh. & Int.
1	Oil Filler Cap Gasket	FP-T20328		Oil filler neck codes 1101, 1104, 1201, 1202, 1203, 1206
1	Oil Filler Cap Gasket	FP-R80135		Oil filler neck codes 1204, 1205, 1207; L.H. Auxiliary drive
QTY	VALVE SEAL	PART NO.	SIZE	DESCRIPTION
8	Valve Stem Seal	FP-RE31617		Exh. & Int.; From Ser. No. 300,000; Positive type
8	Valve Stem Seal	FP-R87627		Exh. & Int.; O-Ring type
QTY	ROCKER PARTS	PART NO.	SIZE	DESCRIPTION
1	O-Ring	FP-R56463		Rocker cover breather tube; Breather tube codes 2902, 2904, 2905, 2909, 2910, 2912, 2999

**ELECTRICAL**

QTY	ELECTRICAL	PART NO.	SIZE	DESCRIPTION
1	Starter to Block Gasket	FP-R53108		3-Hole mount; Starting motor codes 3001, 3002, 3007, 3015, 3017, 3019
QTY	ALTERNATOR	PART NO.	SIZE	DESCRIPTION
1	Ball Brg.	FP-JD9449		Front; Delco-Remy components; Codes 3114, 3115, 3116; 78 amp alternator
2	Ball Brg.	FP-JD9449		Front & Rear; Motorola components; Codes 3101, 3116, 3129; 12 Volt, 65 amp alternator
2	Ball Brg.	FP-JD9449		Front & Rear; Motorola components; Codes 3117, 3118, 3119, 3120; 24 Volt, 45 amp alternator
2	Ball Brg.	FP-JD9449		Front & Rear; Motorola No. 70D42076T02; Codes 3108, 3109, 3130; 65 amp alternator

**INT & EXH MANIFOLDS**

QTY	INT. & EXH. MANIFOLDS	PART NO.	SIZE	DESCRIPTION
4	Exhaust Manifold Gasket	FP-R90658		Exh. manifold codes 2801, 2802, 2803, 2822
1	Air Intake Gasket	FP-R81275		Int. manifold codes 1701, 1703, 1707, 1709

**CAMSHAFT GROUP**

QTY	TIMING COVER	PART NO.	SIZE	DESCRIPTION
1	Timing Gear Cover Gasket	FP-R97454		Front cover
QTY	CAMSHAFT/LIFTER	PART NO.	SIZE	DESCRIPTION
8	Lifter	FP-T20073		

(continued on next page)

**10 Industrial Applications 4039D Eng.**  
 (cont.) 3.9L 239 (3917cc) OHV Diesel L4 (Litre Engine), 106mm Bore

FUEL SYSTEM & PARTS				
QTY	FUEL INJECTION	PART NO.	SIZE	DESCRIPTION
1	Injector Pump Gasket	FP-R125066		Gear cover
4	Fuel Injector Nozzle	FP-RE36935		w/Injector marked 28480
4	Fuel Injector Seal	FP-R79605		Fuel line connection; Nozzle codes 1602, 1603, 1604, 1613, 1615, 1619, 1620, 1624; Nozzle marked 28480; 9.270MM X 13.600MM X 5.080MM
4	Fuel Injector Seal	FP-R79605		Fuel line connection; RePower Eng.s.; Nozzle code 1695; 9.270MM X 13.600MM X 5.080MM
4	Fuel Injector Nut	FP-R79604		w/Injector marked 28480
2	Clamp	FP-R34766		Pump codes 3701, 3702, 3707, 3712
8	Washer Type Seal	FP-R51936		Leak-off & return line seals; Nozzle codes 1601, 1602, 1603, 1604, 1609, 1613, 1615, 1619, 1620, 1621, 1624, 1646
8	Washer Type Seal	FP-R51936		RePower Eng.s.; Leak-off & return line seals; Nozzle code 1695
4	Washer Type Seal	FP-R48000		Lower; w/Oversize injector bore; w/Nozzle codes 1602, 1603, 1613, 1615, 1619, 1620, 1623, 1624
4	Washer Type Seal	FP-R60746		Upper; Nozzle codes 1602, 1603, 1604, 1613, 1615, 1619, 1620, 1624
QTY	FUEL FILTERS & PUMP	PART NO.	SIZE	DESCRIPTION
1	Mechanical Fuel Pump	FP-RE42211		Transfer pump
1	Injector Pump Mount Gasket	FP-R97354		w/Roto-Diesel fuel pump
1	O-Ring	FP-R26286		Fuel inj. pump codes 1602, 1603, 1609, 1614, 1618, 1623, 1624, 1643, 1646, 1664; Fuel inlet fitting seal
1	Fuel Transfer Pump Gasket	FP-R97350		Pump code 3799; Cover gskt.
COOLING SYSTEM				
QTY	WATER PUMP	PART NO.	SIZE	DESCRIPTION
1	Water Pump Impeller	FP-R47191		w/Pump housing marked R66420, R68733
1	Water Pump Impeller	FP-R56812		w/Pump housing marked R90783
1	Water Pump Impeller	FP-R94419		Pump code 2004; w/Pump housing marked R100871, R111028
1	Water Pump Impeller	FP-R94419		Pump code 2021; w/Pump housing marked R73604, R100871, R111028
1	Water Pump Impeller	FP-R94419		Pump code 2022; w/Pump housing marked R55164
1	Water Pump Repair/Rebuild Kit	FP-864340979		w/Pump housing marked R51661, R73606, R73724, R79171
1	Water Pump Repair/Rebuild Kit	FP-944840979		w/Pump housing marked R52009
1	Water Pump Repair/Rebuild Kit	FP-RE62658		w/Pump housing marked R55164, R73604
1	Water Pump Repair/Rebuild Kit	FP-925740979		w/Pump housing marked R56787, R62902
1	Water Pump Repair/Rebuild Kit	FP-RE62661		w/Pump housing marked R66420, R68733
1	Water Pump Housing Gasket	FP-R55405		w/Pump housing marked R55164
1	Water Pump Housing Gasket	FP-R97455		w/Pump housing marked R73604, R100871, R111028
1	Water Pump Housing Gasket	FP-R56809		w/Pump housing marked R90783
1	Oil Seal Kit	FP-AR101549		Water Pump; w/Pump housing marked R55164, R90783
1	Water Pump Mounting Gasket	FP-T20243		w/H/D Pump housing marked R100812, R127918
1	Water Pump Mounting Gasket	FP-T20243		w/Pump housing marked R55164, R67188, R73604, R90783, R90784, R100871, R104648, R111028
1	O-Ring	FP-U13639		Coolant heater codes 2601, 2602; Adapter seal; 1.475" X .118"
1	Shaft & Bearing Assembly	FP-JD9257		w/Pump housing marked R55164, R73604, R100871, R111028
1	Shaft & Bearing Assembly	FP-JD8643		w/Pump housing marked R90783
QTY	THERMOSTAT	PART NO.	SIZE	DESCRIPTION
2	Thermostat	FP-AR48675		Thermostat codes 2201, 2205, 2207; 180 Deg.
1	Thermostat	FP-RE33705		Thermostat housing codes 2101, 2102, 2204, 2207; Thermostat code 2208; 180 Deg.
2	Thermostat	FP-RE33705		Thermostat housing codes 2105, 2108, 3904; Thermostat code 2204; 180 Deg.
1	Thermostat Gasket	FP-T20219		
1	Thermostat Cover Gasket	FP-T20215		
1	Therm. Hsg. - Water Mfld. Gsk	FP-R54641		Thermostat housing to cyl. head
2	O-Ring	FP-R56461		Thermostat housing tube seals; Housing code 3905; Water pump codes 2004, 2023
ENGINE BLOCK & PARTS				
QTY	GASKETS	PART NO.	SIZE	DESCRIPTION
1	Flywheel Housing Gasket	FP-R97351		Flywheel housing codes 1403, 1404, 1405, 1406, 1407, 1410, 1411, 1421, 1422, 1425, 1432
1	Oil Pan Gasket	FP-R119360		w/Sheet metal pan; Oil pan code 1902; From Ser. No. 103,251; w/Cast iron oil pan
1	Oil Pan Gasket	FP-R119360		w/Sheet metal pan; Oil pan codes 1901, 1903, 1906; w/Cast iron oil pan
1	Oil Pan Gasket	FP-R97342		Oil pan codes 1904, 1905, 1910, 1913, 1919, 1932; w/Stamped Steel Pan
1	Block to End Plate Front Gskt	FP-R131794		Front plate codes 3601, 3602, 3604, 3695; R.H. side gear drive

(continued on next page)



*Industrial Applications 4039D Eng. 10*  
3.9L 239 (3917cc) OHV Diesel L4 (Litre Engine), 106mm Bore (cont.)

<b>ENGINE BLOCK &amp; PARTS (cont.)</b>				
<b>QTY</b>	<b>GASKET SETS</b>	<b>PART NO.</b>	<b>SIZE</b>	<b>DESCRIPTION</b>
1	In-Frame Gasket Set	FP-PG219S		
1	Complete Overhaul Gasket Set	FP-RE38857		Crankshaft seals not incl.
1	Complete Overhaul Gasket Set	FP-RE38857WS		Incl. crankshaft seals; Rear main brg. seal incl.; Wear sleeve not incl.
<b>QTY</b>	<b>CAM BEARINGS</b>	<b>PART NO.</b>	<b>SIZE</b>	<b>DESCRIPTION</b>
1	Cam Brg.	FP-R91708		Cyl. block codes 4601, 4602, 4623; 2.0MM O/S OD; Balance shaft bushing
1	Cam Brg.	FP-R119874		R.H. Side gear drive
<b>QTY</b>	<b>ENGINE BEARING MISC.</b>	<b>PART NO.</b>	<b>SIZE</b>	<b>DESCRIPTION</b>
1	Bal. Shaft Set	FP-R57160S		
6	Balance Shaft Bearing	FP-R57160		
<b>QTY</b>	<b>OIL COOLERS &amp; FILTERS</b>	<b>PART NO.</b>	<b>SIZE</b>	<b>DESCRIPTION</b>
1	Oil Cooler	FP-RE61767		RePower Engs. DD14964, DD14965; w/Cooler codes 5904, 5906, 5908, 5914, 5916, 5995; w/6 plates; From Ser. No. 185,224
1	Washer	FP-R105714		Oil cooler; Oil Cooler codes 5901, 5904, 5905, 5906, 5907
1	Rect. or Square Seal	FP-R70956		Cooler housing; w/Behr cooler codes 5904, 5906, 5908, 5914, 5916; To Ser. No. 185,223; 2.700" X 3.000" X .180"
1	Rect. or Square Seal	FP-R70956		Cooler housing; RePower Engs. DD14964, DD14965, DD14966, DD14967; Oil cooler code 5995; 2.700" X 3.000" X .180"
<b>CRANKSHAFT/OIL PUMP</b>				
<b>QTY</b>	<b>CRANKSHAFT</b>	<b>PART NO.</b>	<b>SIZE</b>	<b>DESCRIPTION</b>
1	Crankshaft	FP-RE20585		
1	Oil Seal Kit	FP-SK67942		RePower Engs. DD14964, DD14966; Crankshaft codes 4701, 4702, 4707, 4710; Incl. front & rear seals
<b>QTY</b>	<b>SEALS - FRONT CRANK</b>	<b>PART NO.</b>	<b>SIZE</b>	<b>DESCRIPTION</b>
1	Crankshaft Front Seal	FP-AR67942		
1	O-Ring	FP-H35244		Crankshaft pulley; Crankshaft, Bearing codes 4701, 4702, 4708, 4710
1	O-Ring	FP-H35244		Crankshaft pulley; RePower Engs. DD14965, DD14967; Crankshaft, Bearing codes 4701, 4702, 4708, 4710
<b>QTY</b>	<b>SEALS - REAR CRANK</b>	<b>PART NO.</b>	<b>SIZE</b>	<b>DESCRIPTION</b>
1	Crankshaft Rear Seal	FP-RE24959		Crankshaft, Bearing codes 4701, 4703; Flywheel housing codes 1403, 1404, 1405, 1406, 1407, 1410, 1411, 1421, 1422, 1425, 1432
<b>QTY</b>	<b>MAIN BEARINGS</b>	<b>PART NO.</b>	<b>SIZE</b>	<b>DESCRIPTION</b>
1	Main Set	FP-MBK3004	STD	w/Flanged thrust brg.
1	Main Set	FP-MBK300410	10	w/Flanged thrust brg.
1	Main Set	FP-MBK300420	20	w/Flanged thrust brg.
1	Main Set	FP-MBK300430	30	w/Flanged thrust brg.
4	Plain Main Brg.	FP-RE27352	STD	w/Flangeless thrust brg.
4	Plain Main Brg.	FP-RE27353	10	w/Flangeless thrust brg.
4	Plain Main Brg.	FP-RE27360	20	w/Flangeless thrust brg.
4	Plain Main Brg.	FP-RE27368	30	w/Flangeless thrust brg.
1	Flanged Main Brg.	FP-RE521350	STD	
1	Flanged Main Brg.	FP-RE526754	10	
1	Flanged Main Brg.	FP-RE527235	20	
1	Flanged Main Brg.	FP-RE527236	30	
3	Thrust Washer	FP-R78598	STD	w/Thrust washer; Crank marked R120009, R121018; Note: Applications may use three or four thrust washers
<b>QTY</b>	<b>OIL PUMP</b>	<b>PART NO.</b>	<b>SIZE</b>	<b>DESCRIPTION</b>
1	Pump Repair Kit	FP-RE55343		Pump codes 5001, 5004; w/Pump housing marked R54615; From Ser. No. 427,376
1	O-Ring	FP-R61871		Oil pump inlet; Pump codes 5001, 5002, 5005, 5006, 5007; w/Pump housing marked R54615; To Ser. No. 427,375
1	O-Ring	FP-R74354		Oil pump outlet tube; Pump codes 5001, 5002; w/Pump housing marked R54615
1	Oil Filler Inlet Gasket	FP-R97352		Oil filler neck codes 1101, 1104, 1200, 1201, 1203, 1297, 1299
<b>CYLINDER COMPONENTS</b>				
<b>QTY</b>	<b>LINERS</b>	<b>PART NO.</b>	<b>SIZE</b>	<b>DESCRIPTION</b>
4	Liner w/o Sealing Ring	FP-R116281		
4	Liner w/Sealing Rings	FP-RE500023		
4	Cylinder Kit Complete	FP-RE30250	STD	w/Con. Rod marked R51727, R80034
4	Cyl. Liner Sealing Ring Kit	FP-AR65507		
4	Sealing Ring, Liner	FP-R48767		Rectangle; Top

(continued on next page)

**10 Industrial Applications 4039D Eng.**  
(cont.) 3.9L 239 (3917cc) OHV Diesel L4 (Litre Engine), 106mm Bore

**CYLINDER COMPONENTS (cont.)**

QTY	LINERS (cont.)	PART NO.	SIZE	DESCRIPTION
4	Sealing Ring	FP-SLR2520		Round; Bottom
QTY	PISTONS	PART NO.	SIZE	DESCRIPTION
4	Piston Body w/o Pin	FP-RE19282		
4	Piston Kit w/Pin & Retainers	FP-RE19282WP		
4	Pin	FP-R125754		1.38" pin dia.
8	Piston Pin Retainer	FP-M41029		For 1.38" pin dia.
4	Pin Bushing	FP-R55647		w/Con. Rod marked R51727, R80034; 1.3765" ID, 1.500" OD, 1.570" O.A.L.
QTY	CONNECTING RODS & BRGS.	PART NO.	SIZE	DESCRIPTION
8	Con. Rod Bolt	FP-R80033		w/Con. Rod marked R80032, R80034, R81410, R105011, R113612; Torque-To-Yield bolt; Replacement recommended
4	Rod Pair	FP-AR97517	STD	w/Con. Rod marked R56187, R116851
4	Rod Pair	FP-AR97653	10	w/Con. Rod marked R56187, R116851
4	Rod Pair	FP-AR97654	20	w/Con. Rod marked R56187, R116851
4	Rod Pair	FP-AR97655	30	w/Con. Rod marked R56187, R116851
4	Rod Pair	FP-RE27348	STD	Crankshaft codes 4702, 4708, 4710; Con. Rod codes 4801, 4802
4	Rod Pair	FP-RE27349	10	Crankshaft codes 4702, 4708, 4710; Con. Rod codes 4801, 4802
4	Rod Pair	FP-RE27358	20	Crankshaft codes 4702, 4708, 4710; Con. Rod codes 4801, 4802
4	Rod Pair	FP-RE27364	30	Crankshaft codes 4702, 4708, 4710; Con. Rod codes 4801, 4802
4	Rod Pair	FP-RE27348	STD	RePower Eng. DD14964, DD14965; w/Con. Rod marked R80034
4	Rod Pair	FP-RE27349	10	RePower Eng. DD14964, DD14965; w/Con. Rod marked R80034
4	Rod Pair	FP-RE27358	20	RePower Eng. DD14964, DD14965; w/Con. Rod marked R80034
4	Rod Pair	FP-RE27364	30	RePower Eng. DD14964, DD14965; w/Con. Rod marked R80034
QTY	PISTON RINGS	PART NO.	SIZE	DESCRIPTION
4	Ring Set Single Cylinder	FP-RE507852	STD	1-1/8, 1-3/32, 1-.136 (1 cyl. set)
4	Ring Set Single Cylinder	FP-RE66820	STD	1-1/8, 1-3/32, 1-.136 (1 cyl. set)
KITS				
QTY	OVERHAUL KIT	PART NO.	SIZE	DESCRIPTION
1	In-Frame Overhaul Kit	FP-239DIFK		w/Con. Rod marked R80034; Incl. front & rear seals; Crankshaft codes 4702, 4708, 4710; Con. Rod codes 4801, 4802
1	Complete Overhaul Kit	FP-239DOHK		w/Con. Rod marked R80034; Incl. front & rear seals; Crankshaft codes 4702, 4708, 4710; Con. Rod codes 4801, 4802; Incl. Torque-To-Yield con. rod bolts

**11 Industrial Applications 4039T Eng.**  
3.9L 239 (3917cc) OHV Turbo-Diesel L4 (Litre Engine), 106mm Bore

**CYL. HEAD & PARTS**

QTY	GASKETS	PART NO.	SIZE	DESCRIPTION
1	Valve Cover Gasket	FP-R73521		w/Stamped Steel Cover; Rocker arm cover codes 1101, 1102, 1104, 1106, 1110, 1114
1	Head Gasket	FP-R125863		From Ser. No. 300,000
1	Head Set	FP-RE38851		From Ser. No. 300,000
QTY	VALVE	PART NO.	SIZE	DESCRIPTION
4	Intake	FP-R98062	STD	1 groove; Chrome plated stem; 1.8350" Head Dia., .3100" Stem Dia., 5.2780" O.A.L.
4	Intake	FP-R97490	15	1 groove; Chrome plated stem; 1.8350" Head Dia., .3250" Stem Dia., 5.2780" O.A.L.
4	Exhaust	FP-R90692	STD	1 groove; Chrome plated stem; 1.6730" Head Dia., .3095" Stem Dia., 5.2550" O.A.L.
4	Exhaust	FP-R97492	15	1 groove; Chrome plated stem; 1.6730" Head Dia., .3245" Stem Dia., 5.2550" O.A.L.
16	Keeper	FP-R91889		Exh. & Int.
QTY	VALVE SEAT	PART NO.	SIZE	DESCRIPTION
4	Exh.	FP-R85687	STD	
4	Int.	FP-R98335		.020" Dia. O/S face width; 1.8575" OD, 1.5500" ID, .2580" Depth
4	Int.	FP-R98063	STD	1.8575" OD, 1.5500" ID, .2580" Depth
QTY	VALVE SPRING	PART NO.	SIZE	DESCRIPTION
8	Spring	FP-R26125		Exh. & Int.; 2.1200" Free Height
QTY	VALVE MISC.	PART NO.	SIZE	DESCRIPTION
8	Rotocap	FP-RE60005		Exh. & Int.

(continued on next page)



*Industrial Applications 4039T Eng. 11*  
3.9L 239 (3917cc) OHV Turbo-Diesel L4 (Litre Engine), 106mm Bore (cont.)

<b>CYL. HEAD &amp; PARTS (cont.)</b>				
QTY	VALVE MISC. (cont.)	PART NO.	SIZE	DESCRIPTION
1	Oil Filler Cap Gasket	FP-T20328		Oil filler neck codes 1101, 1104, 1201, 1202, 1203, 1206
1	Oil Filler Cap Gasket	FP-R80135		Oil filler neck codes 1204, 1205, 1207; L.H. Auxiliary drive
QTY	VALVE SEAL	PART NO.	SIZE	DESCRIPTION
8	Valve Stem Seal	FP-RE31617		Exh. & Int.; From Ser. No. 300,000; Positive type
8	Valve Stem Seal	FP-R87627		Exh. & Int.; O-Ring type
QTY	ROCKER PARTS	PART NO.	SIZE	DESCRIPTION
1	O-Ring	FP-R56463		Rocker cover breather tube; Breather tube codes 2902, 2904, 2905, 2909, 2910, 2912, 2999
<b>ELECTRICAL</b>				
QTY	ELECTRICAL	PART NO.	SIZE	DESCRIPTION
1	Starter to Block Gasket	FP-R53108		3-Hole mount; Starting motor codes 3001, 3002, 3007, 3015, 3017, 3019
QTY	ALTERNATOR	PART NO.	SIZE	DESCRIPTION
1	Ball Brg.	FP-JD9449		Front; Delco-Remy components; Codes 3114, 3115, 3116; 78 amp alternator
2	Ball Brg.	FP-JD9449		Front & Rear; Motorola components; Codes 3101, 3116, 3129; 12 Volt, 65 amp alternator
2	Ball Brg.	FP-JD9449		Front & Rear; Motorola components; Codes 3117, 3118, 3119, 3120; 24 Volt, 45 amp alternator
2	Ball Brg.	FP-JD9449		Front & Rear; Motorola No. 70D42076T02; Codes 3108, 3109, 3130; 65 amp alternator
<b>INT &amp; EXH MANIFOLDS</b>				
QTY	INT. & EXH. MANIFOLDS	PART NO.	SIZE	DESCRIPTION
4	Exhaust Manifold Gasket	FP-R90658		Exh. manifold codes 2803, 2806, 2819, 2822
1	Air Intake Gasket	FP-R81275		Int. manifold codes 1713, 1714, 1718
<b>CAMSHAFT GROUP</b>				
QTY	TIMING COVER	PART NO.	SIZE	DESCRIPTION
1	Timing Gear Cover Gasket	FP-T20273		Access cover
1	Timing Gear Cover Gasket	FP-R97454		Front cover
QTY	CAMSHAFT/LIFTER	PART NO.	SIZE	DESCRIPTION
8	Lifter	FP-T20073		
<b>FUEL SYSTEM &amp; PARTS</b>				
QTY	FUEL INJECTION	PART NO.	SIZE	DESCRIPTION
1	Injector Pump Gasket	FP-R125066		Gear cover
4	Fuel Injector Nozzle	FP-RE36939		w/Injector marked 28484
4	Fuel Injector Seal	FP-R79605		Fuel line connection; Nozzle codes 1602, 1603, 1604, 1613, 1615, 1619; Nozzle marked 28484; 9.270MM X 13.600MM X 5.080MM
4	Fuel Injector Seal	FP-R79605		Fuel line connection; RePower Engs.; Nozzle code 1695; 9.270MM X 13.600MM X 5.080MM
4	Fuel Injector Nut	FP-R79604		w/Injector marked 28484
2	Clamp	FP-R34766		Pump codes 3701, 3702, 3707, 3712
8	Washer Type Seal	FP-R51936		Leak-off & return line seals; Nozzle codes 1601, 1602, 1603, 1604, 1609, 1613, 1615, 1619, 1620, 1621, 1651
8	Washer Type Seal	FP-R51936		RePower Engs.; Leak-off & return line seals; Nozzle code 1695
4	Washer Type Seal	FP-R48000		Lower; w/Nozzle code 1604
QTY	FUEL FILTERS & PUMP	PART NO.	SIZE	DESCRIPTION
1	Mechanical Fuel Pump	FP-RE42211		Pump codes 3703, 3704, 3706; Transfer pump
1	O-Ring	FP-R26286		Fuel inj. pump codes 1602, 1603, 1609, 1614, 1618, 1623, 1624, 1643, 1646, 1664; Fuel inlet fitting seal
1	Fuel Transfer Pump Gasket	FP-R97350		Pump code 3799; Cover gskt.
QTY	TURBOCHARGER	PART NO.	SIZE	DESCRIPTION
1	Turbocharger Oil Drain Gasket	FP-R105346		Turbo codes 6501, 6506, 6512, 6513
1	Turbocharger Mounting Gasket	FP-R89879		
1	Turbocharger Oil Supply Gskt.	FP-R97348		Turbo code 6501
<b>COOLING SYSTEM</b>				
QTY	WATER PUMP	PART NO.	SIZE	DESCRIPTION
1	Water Pump Impeller	FP-R47191		w/Pump housing marked R66420, R68733
1	Water Pump Impeller	FP-R56812		w/Pump housing marked R90783
1	Water Pump Impeller	FP-R94419		Pump code 2021; w/Pump housing marked R73604, R100871, R111028
1	Water Pump Impeller	FP-R94419		Pump code 2022; w/Pump housing marked R55164

(continued on next page)

**11 Industrial Applications 4039T Eng.**  
 (cont.) 3.9L 239 (3917cc) OHV Turbo-Diesel L4 (Litre Engine), 106mm Bore

<b>COOLING SYSTEM (cont.)</b>				
<b>QTY</b>	<b>WATER PUMP (cont.)</b>	<b>PART NO.</b>	<b>SIZE</b>	<b>DESCRIPTION</b>
1	Water Pump Impeller	FP-R94419		Pump code 2026; w/Pump housing marked R100871, R111028
1	Water Pump Repair/Rebuild Kit	FP-864340979		w/Pump housing marked R51661, R73606, R73724, R79171
1	Water Pump Repair/Rebuild Kit	FP-944840979		w/Pump housing marked R52009
1	Water Pump Repair/Rebuild Kit	FP-RE62658		w/Pump housing marked R55164, R73604
1	Water Pump Repair/Rebuild Kit	FP-925740979		w/Pump housing marked R56787, R62902
1	Water Pump Repair/Rebuild Kit	FP-RE62661		w/Pump housing marked R66420, R68733
1	Water Pump Housing Gasket	FP-R55405		w/Pump housing marked R55164
1	Water Pump Housing Gasket	FP-R97455		w/Pump housing marked R73604, R100871, R111028
1	Water Pump Housing Gasket	FP-R56809		w/Pump housing marked R90783
1	Oil Seal Kit	FP-AR101549		Water Pump; w/Pump housing marked R55164, R90783
1	Water Pump Mounting Gasket	FP-T20243		w/H/D Pump housing marked R100812, R127918
1	Water Pump Mounting Gasket	FP-T20243		w/Pump housing marked R55164, R73604, R90783, R90784, R100871, R104648, R111028; w/Cast iron impeller marked T30897
1	O-Ring	FP-U13639		Coolant heater codes 2601, 2602; Adapter seal; 1.475" X .118"
1	Shaft & Bearing Assembly	FP-JD9257		w/Pump housing marked R55164, R73604, R100871, R111028
1	Shaft & Bearing Assembly	FP-JD8643		w/Pump housing marked R90783
<b>QTY</b>	<b>THERMOSTAT</b>	<b>PART NO.</b>	<b>SIZE</b>	<b>DESCRIPTION</b>
1	Thermostat	FP-RE33705		Thermostat code 2208; Thermostat Housing codes 2204, 2207; 180 Deg.
2	Thermostat	FP-AR48675		Thermostat codes 2201, 2204, 2205, 2207; Thermostat Housing codes 3901, 3904; 180 Deg.
1	Thermostat Gasket	FP-T20219		Single thermostat cover codes 2101, 2102, 2204, 3901
1	Thermostat Cover Gasket	FP-T20215		
1	Thermostat Cover Gasket	FP-R54638		Thermostat housing codes 3901, 3904; Thermostat cover codes 2102, 2108; w/Two thermostats
1	Therm. Hsg. - Water Mfld. Gsk	FP-R54641		Thermostat housing to cyl. head
2	O-Ring	FP-R56461		Thermostat housing tube seals; Housing code 3901
<b>QTY</b>	<b>MISCELLANEOUS</b>	<b>PART NO.</b>	<b>SIZE</b>	<b>DESCRIPTION</b>
2	Water Line Gasket	FP-R97346		
<b>ENGINE BLOCK &amp; PARTS</b>				
<b>QTY</b>	<b>GASKETS</b>	<b>PART NO.</b>	<b>SIZE</b>	<b>DESCRIPTION</b>
1	Flywheel Housing Gasket	FP-R97351		Flywheel housing codes 1403, 1404, 1405, 1406, 1407, 1410, 1411, 1421, 1422, 1425, 1432
1	Oil Pan Gasket	FP-R119360		w/Sheet metal pan; Oil pan codes 1901, 1903, 1906; w/Cast iron oil pan
1	Oil Pan Gasket	FP-R97342		Oil pan codes 1904, 1905, 1908, 1910, 1913, 1919, 1932; w/Stamped Steel Pan
1	Block to End Plate Front Gskt	FP-R131794		Front plate codes 3601, 3602, 3604, 3695; R.H. side gear drive
<b>QTY</b>	<b>GASKET SETS</b>	<b>PART NO.</b>	<b>SIZE</b>	<b>DESCRIPTION</b>
1	In-Frame Gasket Set	FP-PG219S		Crankshaft seals not incl.
1	Complete Overhaul Gasket Set	FP-RE38857		Incl. crankshaft seals; Rear main brg. seal incl.; Wear sleeve not incl.
1	Complete Overhaul Gasket Set	FP-RE38857WS		
<b>QTY</b>	<b>CAM BEARINGS</b>	<b>PART NO.</b>	<b>SIZE</b>	<b>DESCRIPTION</b>
1	Cam Brg.	FP-R91708		Cyl. block codes 4601, 4602, 4623; 2.0MM O/S OD; Balance shaft bushing
1	Cam Brg.	FP-R119874		R.H. Side gear drive
<b>QTY</b>	<b>ENGINE BEARING MISC.</b>	<b>PART NO.</b>	<b>SIZE</b>	<b>DESCRIPTION</b>
1	Bal. Shaft Set	FP-R57160S		
6	Balance Shaft Bearing	FP-R57160		
<b>QTY</b>	<b>OIL COOLERS &amp; FILTERS</b>	<b>PART NO.</b>	<b>SIZE</b>	<b>DESCRIPTION</b>
1	Oil Cooler	FP-RE61767		RePower Engs. DD14964, DD14965; w/Cooler codes 5904, 5906, 5908, 5914, 5916, 5995; w/6 plates; From Ser. No. 185,224
1	Washer	FP-R105714		Oil cooler; Oil Cooler codes 5901, 5904, 5905, 5906, 5907
1	Rect. or Square Seal	FP-R70956		Cooler housing; w/Behr cooler codes 5904, 5906, 5908, 5914, 5916; To Ser. No. 185,223; 2.700" X 3.000" X .180"
1	Rect. or Square Seal	FP-R70956		Cooler housing; RePower Engs. DD14964, DD14965, DD14966, DD14967; Oil cooler code 5995; 2.700" X 3.000" X .180"
<b>CRANKSHAFT/OIL PUMP</b>				
<b>QTY</b>	<b>CRANKSHAFT</b>	<b>PART NO.</b>	<b>SIZE</b>	<b>DESCRIPTION</b>
1	Crankshaft	FP-RE20585		

(continued on next page)



*Industrial Applications 4039T Eng. 11*  
3.9L 239 (3917cc) OHV Turbo-Diesel L4 (Litre Engine), 106mm Bore (cont.)

<b>CRANKSHAFT/OIL PUMP (cont.)</b>				
<b>QTY</b>	<b>CRANKSHAFT (cont.)</b>	<b>PART NO.</b>	<b>SIZE</b>	<b>DESCRIPTION</b>
1	Oil Seal Kit	FP-SK67942		RePower Engs. DD14964, DD14965, DD14966, DD14967; Crankshaft codes 4701, 4702, 4703, 4707, 4708, 4710; Incl. front & rear seals
<b>QTY</b>	<b>SEALS - FRONT CRANK</b>	<b>PART NO.</b>	<b>SIZE</b>	<b>DESCRIPTION</b>
1	Crankshaft Front Seal	FP-AR67942		Crankshaft pulley; Pulley codes 1301, 1307, 1315; Crankshaft, Bearing codes 4701, 4702
1	O-Ring	FP-H35244		
1	O-Ring	FP-H35244		
<b>QTY</b>	<b>SEALS - REAR CRANK</b>	<b>PART NO.</b>	<b>SIZE</b>	<b>DESCRIPTION</b>
1	Crankshaft Rear Seal	FP-RE24959		Crankshaft, Bearing codes 4701, 4703; Flywheel housing codes 1403, 1404, 1405, 1406, 1407, 1410, 1411, 1421, 1422, 1425, 1432
<b>QTY</b>	<b>MAIN BEARINGS</b>	<b>PART NO.</b>	<b>SIZE</b>	<b>DESCRIPTION</b>
1	Main Set	FP-MBK3004	STD	w/Flanged thrust brg.
1	Main Set	FP-MBK300410	10	w/Flanged thrust brg.
1	Main Set	FP-MBK300420	20	w/Flanged thrust brg.
1	Main Set	FP-MBK300430	30	w/Flanged thrust brg.
4	Plain Main Brg.	FP-RE27352	STD	w/Flangeless thrust brg.
4	Plain Main Brg.	FP-RE27353	10	w/Flangeless thrust brg.
4	Plain Main Brg.	FP-RE27360	20	w/Flangeless thrust brg.
4	Plain Main Brg.	FP-RE27368	30	w/Flangeless thrust brg.
1	Flanged Main Brg.	FP-RE521350	STD	
1	Flanged Main Brg.	FP-RE526754	10	
1	Flanged Main Brg.	FP-RE527235	20	
1	Flanged Main Brg.	FP-RE527236	30	
3	Thrust Washer	FP-R78598	STD	w/Thrust washer; Crank marked R120009, R121018; Note: Applications may use three or four thrust washers
<b>QTY</b>	<b>OIL PUMP</b>	<b>PART NO.</b>	<b>SIZE</b>	<b>DESCRIPTION</b>
1	Pump Repair Kit	FP-RE55343		Pump codes 5001, 5004; w/Pump housing marked R54615; From Ser. No. 427,376
1	O-Ring	FP-R61871		Oil pump inlet; Pump codes 5001, 5005, 5006, 5007; w/Pump housing marked R54615
1	O-Ring	FP-R61871		Oil pump inlet; RePower Engs.; Pump codes 5002, 5008; w/Pump housing marked R54615
1	O-Ring	FP-R74354		Oil pump outlet tube; Pump codes 5001, 5002, 5005, 5006, 5007, 5008; w/Pump housing marked R54615
1	Oil Filler Inlet Gasket	FP-R97352		Oil filler neck codes 1101, 1104, 1200, 1201, 1203, 1297, 1299
<b>CYLINDER COMPONENTS</b>				
<b>QTY</b>	<b>LINERS</b>	<b>PART NO.</b>	<b>SIZE</b>	<b>DESCRIPTION</b>
4	Liner w/o Sealing Ring	FP-R116281		w/Con. Rod marked R58979, R80032, R113612
4	Liner w/Sealing Rings	FP-RE500023		
4	Cylinder Kit Complete	FP-RE33115		
4	Cyl. Liner Sealing Ring Kit	FP-AR65507		
4	Sealing Ring, Liner	FP-R48767		Rectangle; Top
4	Sealing Ring, Liner	FP-R26121		Round; Middle
4	Sealing Ring	FP-SLR2520		Round; Bottom
<b>QTY</b>	<b>PISTONS</b>	<b>PART NO.</b>	<b>SIZE</b>	<b>DESCRIPTION</b>
4	Piston Body w/o Pin	FP-RE48368		1.62" pin dia. For 1.62" pin dia. w/Con. Rod marked R80032, R113612, R122191; Rod, piston & liner codes 4039, 4802; 1.621" ID, 1.813" OD, 1.370" O.A.L.
4	Piston Kit w/Pin & Retainers	FP-RE48368WP		
4	Pin	FP-R124230		
8	Piston Pin Retainer	FP-R54114		
4	Pin Bushing	FP-R57451		
<b>QTY</b>	<b>CONNECTING RODS &amp; BRGS.</b>	<b>PART NO.</b>	<b>SIZE</b>	<b>DESCRIPTION</b>
8	Con. Rod Bolt	FP-R80033		w/Con. Rod marked R80032, R80034, R81410, R105011, R113612; Torque-To-Yield bolt; Replacement recommended
4	Rod Pair	FP-AR97517	STD	w/Con. Rod marked R56187, R116851
4	Rod Pair	FP-AR97653	10	w/Con. Rod marked R56187, R116851
4	Rod Pair	FP-AR97654	20	w/Con. Rod marked R56187, R116851
4	Rod Pair	FP-AR97655	30	w/Con. Rod marked R56187, R116851
4	Rod Pair	FP-RE27348	STD	Crankshaft code 4702; Con. Rod code 4803
4	Rod Pair	FP-RE27349	10	Crankshaft code 4702; Con. Rod code 4803
4	Rod Pair	FP-RE27358	20	Crankshaft code 4702; Con. Rod code 4803
4	Rod Pair	FP-RE27364	30	Crankshaft code 4702; Con. Rod code 4803

(continued on next page)

**11 Industrial Applications 4039T Eng.**  
(cont.) 3.9L 239 (3917cc) OHV Turbo-Diesel L4 (Litre Engine), 106mm Bore

**CYLINDER COMPONENTS (cont.)**

CONNECTING RODS & BRGS. (cont.)				
QTY		PART NO.	SIZE	DESCRIPTION
4	Rod Pair	FP-RE27348	STD	RePower Engs. DD14964, DD14965; w/Con. Rod marked R80032
4	Rod Pair	FP-RE27349	10	RePower Engs. DD14964, DD14965; w/Con. Rod marked R80032
4	Rod Pair	FP-RE27358	20	RePower Engs. DD14964, DD14965; w/Con. Rod marked R80032
4	Rod Pair	FP-RE27364	30	RePower Engs. DD14964, DD14965; w/Con. Rod marked R80032
PISTON RINGS				
QTY		PART NO.	SIZE	DESCRIPTION
4	Ring Set Single Cylinder	FP-RE507852	STD	1-1/8, 1-3/32, 1-.136 (1 cyl. set)
4	Ring Set Single Cylinder	FP-RE66820	STD	1-1/8, 1-3/32, 1-.136 (1 cyl. set)
KITS				
QTY	OVERHAUL KIT	PART NO.	SIZE	DESCRIPTION
1	In-Frame Overhaul Kit	FP-239TIFK		w/Con. Rod marked R80032, R80034, R113612, R58979; Incl. Torque-To-Yield con. rod bolts
1	Complete Overhaul Kit	FP-239TOHK		w/Con. Rod marked R56187, R58979, R80032, R80034, R113612, R56187; Incl. Torque-To-Yield con. rod bolts

**12 Industrial Applications 4045H PowerTech Eng. (2-Valve Cyl. Head)**  
4.5L 275.8 (4522cc) OHV Turbo-Diesel L4 (PowerTech 2V IC), 106mm Bore

**CYL. HEAD & PARTS**

QTY	GASKETS	PART NO.	SIZE	DESCRIPTION
1	Valve Cover Gasket	FP-R123542		
1	Head Gasket	FP-R116515		
1	Head Set	FP-RE66082		
QTY	VALVE	PART NO.	SIZE	DESCRIPTION
4	Intake	FP-R98062	STD	1 groove; Chrome plated stem; 1.8350" Head Dia., .3100" Stem Dia., 5.2780" O.A.L.
4	Intake	FP-R97490	15	1 groove; Chrome plated stem; 1.8350" Head Dia., .3250" Stem Dia., 5.2780" O.A.L.
4	Exhaust	FP-R90692	STD	1 groove; Chrome plated stem; 1.6730" Head Dia., .3095" Stem Dia., 5.2550" O.A.L.
4	Exhaust	FP-R97492	15	1 groove; Chrome plated stem; 1.6730" Head Dia., .3245" Stem Dia., 5.2550" O.A.L.
16	Keeper	FP-R91889		Exh. & Int.
QTY	VALVE SEAT	PART NO.	SIZE	DESCRIPTION
4	Exh.	FP-R85687	STD	
4	Int.	FP-R98335		.020" Dia. O/S face width; 1.8575" OD, 1.5500" ID, .2580" Depth
4	Int.	FP-R98063	STD	1.8575" OD, 1.5500" ID, .2580" Depth
QTY	VALVE SPRING	PART NO.	SIZE	DESCRIPTION
8	Spring	FP-R26125		Exh. & Int.; 2.1200" Free Height
QTY	VALVE MISC.	PART NO.	SIZE	DESCRIPTION
8	Rotocap	FP-RE60005		Exh. & Int.
QTY	VALVE SEAL	PART NO.	SIZE	DESCRIPTION
8	Valve Stem Seal	FP-RE31617		Positive type

**ELECTRICAL**

QTY	ELECTRICAL	PART NO.	SIZE	DESCRIPTION
1	Starter to Block Gasket	FP-R53108		3-Hole mount; Starting motor codes 3005, 3006, 3010, 3011, 3012

**FUEL SYSTEM & PARTS**

QTY	FUEL INJECTION	PART NO.	SIZE	DESCRIPTION
4	Fuel Injector Nozzle	FP-RE48786		Nozzle codes 16BF, 16CE, 16CM, 16GL, 16LP, 16LQ, 16NH, 16OR, 16OS, 1606, 1608, 1675, 1677, 1682, 1683, 1692, 1694, 1695
4	Fuel Injector Nozzle	FP-RE48786		4045H Engs.; Nozzle codes 160B, 160C, 1610, 1611, 1656, 1667
4	Fuel Injector Seal	FP-R92352		Upper packing; w/Injector nozzle codes 16BF, 16CE, 16CM, 16CV, 16GL, 16LP, 16LQ, 16NH, 16OR, 1605, 1606, 1608, 1656, 1667, 1675, 1677, 1682, 1683, 1692, 1694, 1695
4	Fuel Injector Seal	FP-R92352		4045H Engs.; Upper packing; w/Injector nozzle codes 160B, 160C, 1610, 1611
4	Fuel Injector Nut	FP-R79604		w/Injector nozzle codes 16HM, 16HN, 16HP, 16HQ, 16LK, 16LL
1	Washer Type Seal	FP-R51936		Aux. drive line; Line codes 5201, 5202, 5203, 5205, 5206
2	Washer Type Seal	FP-R51936		Fuel line; Aftercooled; Line codes 160B, 1611

(continued on next page)



**Industrial Applications 4045H PowerTech Eng. (2-Valve Cyl. Head) 12**  
4.5L 275.8 (4522cc) OHV Turbo-Diesel L4 (PowerTech 2V IC), 106mm Bore (cont.)

<b>FUEL SYSTEM &amp; PARTS (cont.)</b>				
<b>QTY</b>	<b>FUEL INJECTION (cont.)</b>	<b>PART NO.</b>	<b>SIZE</b>	<b>DESCRIPTION</b>
2	Washer Type Seal	FP-R51936		Fuel line; Line codes 16BF, 16CE, 16CM, 16CV, 16GL, 16LN, 16LP, 16LQ, 16NH, 16OR, 1605, 1671, 1677, 1682
<b>COOLING SYSTEM</b>				
<b>QTY</b>	<b>WATER PUMP</b>	<b>PART NO.</b>	<b>SIZE</b>	<b>DESCRIPTION</b>
1	Water Pump - Heavy Duty	FP-RE500737 *		Standard flow
1	Water Pump Filter	FP-R98527		w/Pump housing marked RE70683
<b>ENGINE BLOCK &amp; PARTS</b>				
<b>QTY</b>	<b>GASKETS</b>	<b>PART NO.</b>	<b>SIZE</b>	<b>DESCRIPTION</b>
1	Oil Pan Gasket	FP-R97342		Oil pan codes 1904, 1905; w/Stamped Steel Pan
2	O-Ring	FP-U13639		Block coolant drain plug seal; Coolant heater codes 2601, 2602; 1.475" X .118"
<b>QTY</b>	<b>CAM BEARINGS</b>	<b>PART NO.</b>	<b>SIZE</b>	<b>DESCRIPTION</b>
1	Cam Brg.	FP-R119874		
<b>QTY</b>	<b>ENGINE BEARING MISC.</b>	<b>PART NO.</b>	<b>SIZE</b>	<b>DESCRIPTION</b>
4	Balance Shaft Bearing	FP-R115299		4045H Engs.; Balance shaft code 4501
<b>CRANKSHAFT/OIL PUMP</b>				
<b>QTY</b>	<b>SEALS - REAR CRANK</b>	<b>PART NO.</b>	<b>SIZE</b>	<b>DESCRIPTION</b>
1	Crankshaft Rear Seal	FP-RE24959		
<b>QTY</b>	<b>MAIN BEARINGS</b>	<b>PART NO.</b>	<b>SIZE</b>	<b>DESCRIPTION</b>
4	Plain Main Brg.	FP-RE65165	STD	Crankshaft and Bearing code 4701
4	Plain Main Brg.	FP-RE65911	.25MM	Crankshaft and Bearing code 4701
1	Flanged Main Brg.	FP-RE65168	STD	Crankshaft and Bearing code 4701
1	Flanged Main Brg.	FP-RE65912	.25MM	Crankshaft and Bearing code 4701
<b>CYLINDER COMPONENTS</b>				
<b>QTY</b>	<b>LINERS</b>	<b>PART NO.</b>	<b>SIZE</b>	<b>DESCRIPTION</b>
4	Liner w/o Sealing Ring	FP-R121867	STD	
4	Liner w/Sealing Rings	FP-RE500024	STD	
4	Cylinder Kit Complete	FP-RE507920	STD	Piston, Con. Rod, Cyl. liner code 4803; To Ser. No. 825,562
4	Cylinder Kit Complete	FP-RE507850	STD	4045H Engs.; Piston, Con. Rod, Cyl. liner code 4809; w/Con. Rod marked R500335
<b>QTY</b>	<b>PISTONS</b>	<b>PART NO.</b>	<b>SIZE</b>	<b>DESCRIPTION</b>
4	Piston Body w/o Pin	FP-RE505100	STD	Piston, Con. Rod, Cyl. liner code 4803; To Ser. No. 825,562; w/Con. Rod marked R123959; Small Pin
4	Piston Body w/o Pin	FP-RE55512	STD	Piston, Con. Rod, Cyl. liner code 4809; Large Pin; w/Con. Rod marked R500335
4	Pin	FP-R123178		Piston, Con. Rod, Cyl. liner code 4803; To Ser. No. 825,562; w/Con. Rod marked R123959; Small Pin; 1.375" pin dia.
4	Pin	FP-R123177		4045H Engs.; Piston, Con. Rod, Cyl. liner code 4809; w/Con. Rod marked R500335; Large Pin; 1.62" pin dia.
8	Piston Pin Retainer	FP-M41029		w/Con. Rod marked R123959; Small Pin; For 1.38" pin dia.
8	Piston Pin Retainer	FP-R54114		4045H Engs.; w/Con. Rod marked R500335; Large Pin; For 1.62" pin dia.
4	Pin Bushing	FP-R123960		w/Con. Rod marked R123959; Small Pin; 1.375" pin dia.
4	Pin Bushing	FP-R114082		4045H Engs.; w/Con. Rod marked R500335; Large Pin
4	Piston Pin Kit	FP-RE63915		4045H Engs.; Piston, Con. Rod, Cyl. liner code 4809; w/Con. Rod marked R500335; Large Pin; Incl. Pin, Retainers & Bushing
<b>QTY</b>	<b>CONNECTING RODS &amp; BRGS.</b>	<b>PART NO.</b>	<b>SIZE</b>	<b>DESCRIPTION</b>
8	Con. Rod Bolt	FP-R114083		Cyl. Liner code 4803; w/Con. Rod marked R123959; To Ser. No. 793,991; Small Pin
8	Con. Rod Bolt	FP-R501124		Cyl. Liner code 4803, 4809; w/Con. Rod marked R123959, R500000; From Ser. No. 36,628
8	Con. Rod Bolt	FP-R114083		Cyl. Liner code 4809; w/Con. Rod marked R500335; To Ser. No. 793,991
8	Con. Rod Bolt	FP-R501124		4045H Engs.; Cyl. Liner code 4809; w/Con. Rod marked R500335; From Ser. No. 36,628
8	Con. Rod Bolt	FP-R114083		4045H Engs.; Cyl. Liner code 4809; w/Con. Rod marked R500335; To Ser. No. 793,991; Small Pin
4	Rod Pair	FP-RE65908	STD	Cyl. Liner codes 4801, 4803, 4809; w/Con. Rod marked R123959, R500000
4	Rod Pair	FP-RE65909	.25MM	Cyl. Liner codes 4801, 4803, 4809; w/Con. Rod marked R123959, R500000
<b>QTY</b>	<b>PISTON RINGS</b>	<b>PART NO.</b>	<b>SIZE</b>	<b>DESCRIPTION</b>
4	Ring Set Single Cylinder	FP-RE507852	STD	Use w/FP-RE55512 piston; 1-1/8, 1-3/32, 1-.136 (1 cyl. set)

(continued on next page)

\* New Item — Check For Availability

<b>12 Industrial Applications 4045H PowerTech Eng. (2-Valve Cyl. Head)</b> (cont.) 4.5L 275.8 (4522cc) OHV Turbo-Diesel L4 (PowerTech 2V IC), 106mm Bore				
<b>CYLINDER COMPONENTS (cont.)</b>				
<b>QTY</b>	<b>PISTON RINGS (cont.)</b>	<b>PART NO.</b>	<b>SIZE</b>	<b>DESCRIPTION</b>
4	Ring Set Single Cylinder	FP-RE66820	STD	Use w/FP-RE55512 piston; 1-1/8, 1-3/32, 1-.136 (1 cyl. set)
4	Ring Set Single Cylinder	FP-RE66271	STD	Use w/FP-RE59277 piston
<b>KITS</b>				
<b>QTY</b>	<b>OVERHAUL KIT</b>	<b>PART NO.</b>	<b>SIZE</b>	<b>DESCRIPTION</b>
1	In-Frame Overhaul Kit	FP-IFKPT4045T		Piston, Con. Rod, Cyl. liner code 4803; To Ser. No. 825,562
<b>13 Industrial Applications 4045H PowerTech Eng. (4-Valve Cyl. Head)</b> 4.5L 275.8 (4522cc) OHV Turbo-Diesel L4 (PowerTech 4V IC), 106mm Bore				
<b>CYL. HEAD &amp; PARTS</b>				
<b>QTY</b>	<b>GASKETS</b>	<b>PART NO.</b>	<b>SIZE</b>	<b>DESCRIPTION</b>
1	Valve Cover Gasket	FP-R123542		
1	Head Gasket	FP-R116515		
1	Head Set	FP-RE66082		
<b>ELECTRICAL</b>				
<b>QTY</b>	<b>ELECTRICAL</b>	<b>PART NO.</b>	<b>SIZE</b>	<b>DESCRIPTION</b>
1	Starter to Block Gasket	FP-R53108		3-Hole mount; Starting motor codes 3005, 3006, 3010, 3011, 3012
<b>COOLING SYSTEM</b>				
<b>QTY</b>	<b>WATER PUMP</b>	<b>PART NO.</b>	<b>SIZE</b>	<b>DESCRIPTION</b>
1	Water Pump - Heavy Duty	FP-RE500737 *		Standard flow
1	Water Pump Filter	FP-R98527		w/Pump housing marked RE70683
<b>ENGINE BLOCK &amp; PARTS</b>				
<b>QTY</b>	<b>GASKETS</b>	<b>PART NO.</b>	<b>SIZE</b>	<b>DESCRIPTION</b>
1	Oil Pan Gasket	FP-R97342		Oil pan codes 1904, 1905; w/Stamped Steel Pan
2	O-Ring	FP-U13639		Block coolant drain plug seal; Coolant heater codes 2601, 2602; 1.475" X .118"
<b>QTY</b>	<b>CAM BEARINGS</b>	<b>PART NO.</b>	<b>SIZE</b>	<b>DESCRIPTION</b>
1	Cam Brg.	FP-R119874		
<b>QTY</b>	<b>ENGINE BEARING MISC.</b>	<b>PART NO.</b>	<b>SIZE</b>	<b>DESCRIPTION</b>
4	Balance Shaft Bearing	FP-R115299		4045H Engs.; Balance shaft code 4501
<b>CRANKSHAFT/OIL PUMP</b>				
<b>QTY</b>	<b>SEALS - REAR CRANK</b>	<b>PART NO.</b>	<b>SIZE</b>	<b>DESCRIPTION</b>
1	Crankshaft Rear Seal	FP-RE24959		
<b>QTY</b>	<b>MAIN BEARINGS</b>	<b>PART NO.</b>	<b>SIZE</b>	<b>DESCRIPTION</b>
4	Plain Main Brg.	FP-RE65165	STD	Crankshaft and Bearing code 4701
4	Plain Main Brg.	FP-RE65911	.25MM	Crankshaft and Bearing code 4701
1	Flanged Main Brg.	FP-RE65168	STD	Crankshaft and Bearing code 4701
1	Flanged Main Brg.	FP-RE65912	.25MM	Crankshaft and Bearing code 4701
<b>CYLINDER COMPONENTS</b>				
<b>QTY</b>	<b>LINERS</b>	<b>PART NO.</b>	<b>SIZE</b>	<b>DESCRIPTION</b>
4	Liner w/o Sealing Ring	FP-R121867	STD	
4	Liner w/Sealing Rings	FP-RE500024	STD	
4	Cylinder Kit Complete	FP-RE507920	STD	Piston, Con. Rod, Cyl. liner code 4803; To Ser. No. 825,562
4	Cylinder Kit Complete	FP-RE507850	STD	Piston, Con. Rod, Cyl. liner code 4809; w/Con. Rod marked R500335
4	Cyl. Liner Sealing Ring Kit	FP-AR65507		
<b>QTY</b>	<b>PISTONS</b>	<b>PART NO.</b>	<b>SIZE</b>	<b>DESCRIPTION</b>
4	Piston Body w/o Pin	FP-RE505100	STD	Piston, Con. Rod, Cyl. liner code 4803; To Ser. No. 825,562; w/Con. Rod marked R123959; Small Pin
4	Piston Body w/o Pin	FP-RE55512	STD	Piston, Con. Rod, Cyl. liner code 4809; Large Pin; w/Con. Rod marked R500335
4	Pin	FP-R123178		Piston, Con. Rod, Cyl. liner code 4803; To Ser. No. 825,562; w/Con. Rod marked R123959; Small Pin; 1.375" pin dia.
4	Pin	FP-R123177		4045H Engs.; Piston, Con. Rod, Cyl. liner code 4809; w/Con. Rod marked R500335; Large Pin; 1.62" pin dia.
8	Piston Pin Retainer	FP-M41029		w/Con. Rod marked R123959; Small Pin; For 1.38" pin dia.
8	Piston Pin Retainer	FP-R54114		4045H Engs.; w/Con. Rod marked R500335; Large Pin; For 1.62" pin dia.
4	Pin Bushing	FP-R123960		w/Con. Rod marked R123959; Small Pin; 1.375" pin dia.
4	Pin Bushing	FP-R114082		4045H Engs.; w/Con. Rod marked R500335; Large Pin

(continued on next page)



**Industrial Applications 4045H PowerTech Eng. (4-Valve Cyl. Head) 13**  
4.5L 275.8 (4522cc) OHV Turbo-Diesel L4 (PowerTech 4V IC), 106mm Bore (cont.)

<b>CYLINDER COMPONENTS (cont.)</b>				
<b>QTY</b>	<b>PISTONS (cont.)</b>	<b>PART NO.</b>	<b>SIZE</b>	<b>DESCRIPTION</b>
4	Piston Pin Kit	FP-RE63915		4045H Engs.; Piston, Con. Rod, Cyl. liner code 4809; w/Con. Rod marked R500335; Large Pin; Incl. Pin, Retainers & Bushing
<b>QTY</b>	<b>CONNECTING RODS &amp; BRGS.</b>	<b>PART NO.</b>	<b>SIZE</b>	<b>DESCRIPTION</b>
8	Con. Rod Bolt	FP-R114083		Cyl. Liner code 4803; w/Con. Rod marked R123959; To Ser. No. 793,991; Small Pin
8	Con. Rod Bolt	FP-R501124		Cyl. Liner code 4803; w/Con. Rod marked R123959, R500000; From Ser. No. 36,628
8	Con. Rod Bolt	FP-R501124		Cyl. Liner code 4809; w/Con. Rod marked R500000; From Ser. No. 36,628
8	Con. Rod Bolt	FP-R114083		Cyl. Liner code 4809; w/Con. Rod marked R500335; To Ser. No. 793,991
8	Con. Rod Bolt	FP-R501124		4045H Engs.; Cyl. Liner code 4809; w/Con. Rod marked R500335; From Ser. No. 36,628
8	Con. Rod Bolt	FP-R114083		4045H Engs.; Cyl. Liner code 4809; w/Con. Rod marked R500335; To Ser. No. 793,991; Small Pin
4	Rod Pair	FP-RE65908	STD	Cyl. Liner codes 4801, 4803; w/Con. Rod marked R123959, R500000
4	Rod Pair	FP-RE65909	.25MM	Cyl. Liner codes 4801, 4803; w/Con. Rod marked R123959, R500000
4	Rod Pair	FP-RE65908	STD	4045H Engs.; Cyl. Liner code 4809; w/Con. Rod marked R500335
4	Rod Pair	FP-RE65909	.25MM	4045H Engs.; Cyl. Liner code 4809; w/Con. Rod marked R500335
<b>QTY</b>	<b>PISTON RINGS</b>	<b>PART NO.</b>	<b>SIZE</b>	<b>DESCRIPTION</b>
4	Ring Set Single Cylinder	FP-RE507852	STD	Use w/FP-RE55512 piston; 1-1/8, 1-3/32, 1-.136 (1 cyl. set)
4	Ring Set Single Cylinder	FP-RE66820	STD	Use w/FP-RE55512 piston; 1-1/8, 1-3/32, 1-.136 (1 cyl. set)
4	Ring Set Single Cylinder	FP-RE66271	STD	Use w/FP-RE59277 piston
<b>KITS</b>				
<b>QTY</b>	<b>OVERHAUL KIT</b>	<b>PART NO.</b>	<b>SIZE</b>	<b>DESCRIPTION</b>
1	In-Frame Overhaul Kit	FP-IFKPT4045T		Piston, Con. Rod, Cyl. liner code 4803; To Ser. No. 825,562
<b>Industrial Applications 4045D PowerTech Eng. 14</b> 4.5L 275.8 (4522cc) OHV Diesel L4 (PowerTech 2V), 106mm Bore				
<b>CYL. HEAD &amp; PARTS</b>				
<b>QTY</b>	<b>GASKETS</b>	<b>PART NO.</b>	<b>SIZE</b>	<b>DESCRIPTION</b>
1	Valve Cover Gasket	FP-R123542		
1	Head Gasket	FP-R116515		
1	Head Set	FP-RE66082		
<b>QTY</b>	<b>VALVE</b>	<b>PART NO.</b>	<b>SIZE</b>	<b>DESCRIPTION</b>
4	Intake	FP-R98062	STD	1 groove; Chrome plated stem; 1.8350" Head Dia., .3100" Stem Dia., 5.2780" O.A.L.
4	Intake	FP-R97490	15	1 groove; Chrome plated stem; 1.8350" Head Dia., .3250" Stem Dia., 5.2780" O.A.L.
4	Exhaust	FP-R90692	STD	1 groove; Chrome plated stem; 1.6730" Head Dia., .3095" Stem Dia., 5.2550" O.A.L.
4	Exhaust	FP-R97492	15	1 groove; Chrome plated stem; 1.6730" Head Dia., .3245" Stem Dia., 5.2550" O.A.L.
16	Keeper	FP-R91889		Exh. & Int.
<b>QTY</b>	<b>VALVE SEAT</b>	<b>PART NO.</b>	<b>SIZE</b>	<b>DESCRIPTION</b>
4	Exh.	FP-R85687	STD	
4	Int.	FP-R98335		.020" Dia. O/S face width; 1.8575" OD, 1.5500" ID, .2580" Depth
4	Int.	FP-R98063	STD	1.8575" OD, 1.5500" ID, .2580" Depth
<b>QTY</b>	<b>VALVE SPRING</b>	<b>PART NO.</b>	<b>SIZE</b>	<b>DESCRIPTION</b>
8	Spring	FP-R26125		Exh. & Int.; 2.1200" Free Height
<b>QTY</b>	<b>VALVE MISC.</b>	<b>PART NO.</b>	<b>SIZE</b>	<b>DESCRIPTION</b>
8	Rotocap	FP-RE60005		Exh. & Int.
<b>ELECTRICAL</b>				
<b>QTY</b>	<b>ELECTRICAL</b>	<b>PART NO.</b>	<b>SIZE</b>	<b>DESCRIPTION</b>
1	Starter to Block Gasket	FP-R53108		3-Hole mount; Starting motor codes 3006, 3010

(continued on next page)

<b>14 Industrial Applications 4045D PowerTech Eng.</b>				
<b>(cont.) 4.5L 275.8 (4522cc) OHV Diesel L4 (PowerTech 2V), 106mm Bore</b>				
<b>FUEL SYSTEM &amp; PARTS</b>				
QTY	FUEL INJECTION	PART NO.	SIZE	DESCRIPTION
4	Fuel Injector Seal	FP-R92352		Upper packing; w/Injector nozzle codes 16BG, 16BH, 16BJ, 16CL, 16DL, 16GB, 16GC, 16HJ, 16HK, 16HV, 16KE, 16LM, 16LN, 16O1, 16O2, 16O3, 1663, 1671, 1672, 1673, 1674, 1691
4	Fuel Injector Nut	FP-R79604		w/Injector nozzle codes 16HR, 16HS, 16HT, 16HU
1	Washer Type Seal	FP-R51936		Aux. drive line; Line codes 5201, 5202, 5205
2	Washer Type Seal	FP-R51936		Fuel line; Line codes 16BG, 16BJ, 16CL, 16DL, 16GB, 16GC, 16HJ, 16HK, 16HV, 16O1, 16O3, 1663, 1671, 1673, 1691
<b>COOLING SYSTEM</b>				
QTY	WATER PUMP	PART NO.	SIZE	DESCRIPTION
1	Water Pump - Heavy Duty	FP-RE500737 *		Standard flow
1	Water Pump Filter	FP-R98527		w/Pump housing marked RE70683
<b>ENGINE BLOCK &amp; PARTS</b>				
QTY	GASKETS	PART NO.	SIZE	DESCRIPTION
1	Oil Pan Gasket	FP-R97342		Oil pan codes 1904, 1905; w/Stamped Steel Pan
1	O-Ring	FP-U13639		Block coolant drain plug seal; Coolant heater codes 2601, 2602; 1.475" X .118"
QTY	CAM BEARINGS	PART NO.	SIZE	DESCRIPTION
1	Cam Brg.	FP-R119874		
QTY	ENGINE BEARING MISC.	PART NO.	SIZE	DESCRIPTION
4	Balance Shaft Bearing	FP-R115299		Balance shaft code 4502
<b>CRANKSHAFT/OIL PUMP</b>				
QTY	SEALS - REAR CRANK	PART NO.	SIZE	DESCRIPTION
1	Crankshaft Rear Seal	FP-RE24959		
QTY	MAIN BEARINGS	PART NO.	SIZE	DESCRIPTION
4	Plain Main Brg.	FP-RE65165	STD	Crankshaft and Bearing code 4701
4	Plain Main Brg.	FP-RE65911	.25MM	Crankshaft and Bearing code 4701
1	Flanged Main Brg.	FP-RE65168	STD	Crankshaft and Bearing code 4701
1	Flanged Main Brg.	FP-RE65912	.25MM	Crankshaft and Bearing code 4701
<b>CYLINDER COMPONENTS</b>				
QTY	LINERS	PART NO.	SIZE	DESCRIPTION
4	Liner w/o Sealing Ring	FP-R121867	STD	
4	Liner w/Sealing Rings	FP-RE500024	STD	
4	Cylinder Kit Complete	FP-RE65966	STD	Piston, Con. Rod, Cyl. liner code 4801
4	Cylinder Kit Complete	FP-RE507920	STD	Piston, Con. Rod, Cyl. liner code 4803; To Ser. No. 825,562; Use w/RE59277, RE505101 piston
4	Cyl. Liner Sealing Ring Kit	FP-AR65507		
QTY	PISTONS	PART NO.	SIZE	DESCRIPTION
4	Piston Body w/o Pin	FP-RE505101	STD	Piston, Con. Rod, Cyl. liner code 4801
4	Piston Body w/o Pin	FP-RE505100	STD	Piston, Con. Rod, Cyl. liner code 4803; To Ser. No. 825,562; w/Con. Rod marked R123959; Small Pin
4	Pin	FP-R123178		Piston, Con. Rod, Cyl. liner codes 4801, 4803; To Ser. No. 825,562; w/Con. Rod marked R123959; Small Pin; 1.375" pin dia.
8	Piston Pin Retainer	FP-M41029		w/Con. Rod marked R123959; Small Pin; For 1.38" pin dia.
4	Pin Bushing	FP-R123960		w/Con. Rod marked R123959; Small Pin; 1.375" pin dia.
QTY	CONNECTING RODS & BRGS.	PART NO.	SIZE	DESCRIPTION
8	Con. Rod Bolt	FP-R501124		Cyl. Liner code 4801, 4803; w/Con. Rod marked R123959, R500000; From Ser. No. 36,628
8	Con. Rod Bolt	FP-R114083		Cyl. Liner codes 4801, 4803; w/Con. Rod marked R123959; To Ser. No. 793,991; Small Pin
4	Rod Pair	FP-RE65908	STD	Cyl. Liner codes 4801, 4803; w/Con. Rod marked R123959, R500000
4	Rod Pair	FP-RE65909	.25MM	Cyl. Liner codes 4801, 4803; w/Con. Rod marked R123959, R500000
QTY	PISTON RINGS	PART NO.	SIZE	DESCRIPTION
4	Ring Set Single Cylinder	FP-RE66271	STD	Use w/RE59277, RE505101 piston
<b>KITS</b>				
QTY	OVERHAUL KIT	PART NO.	SIZE	DESCRIPTION
1	In-Frame Overhaul Kit	FP-IFKPT4045T		Piston, Con. Rod, Cyl. liner code 4803; Use w/RE59277, RE505100 piston; To Ser. No. 825,562



**Industrial Applications 4045T PowerTech Eng. 15**  
4.5L 275.8 (452cc) OHV Turbo-Diesel L4 (PowerTech 2V), 106mm Bore

<b>CYL. HEAD &amp; PARTS</b>				
QTY	GASKETS	PART NO.	SIZE	DESCRIPTION
1	Valve Cover Gasket	FP-R123542		
1	Head Gasket	FP-R116515		
1	Head Set	FP-RE66082		
QTY	VALVE	PART NO.	SIZE	DESCRIPTION
4	Intake	FP-R98062	STD	1 groove; Chrome plated stem; 1.8350" Head Dia., .3100" Stem Dia., 5.2780" O.A.L.
4	Intake	FP-R97490	15	1 groove; Chrome plated stem; 1.8350" Head Dia., .3250" Stem Dia., 5.2780" O.A.L.
4	Exhaust	FP-R90692	STD	1 groove; Chrome plated stem; 1.6730" Head Dia., .3095" Stem Dia., 5.2550" O.A.L.
4	Exhaust	FP-R97492	15	1 groove; Chrome plated stem; 1.6730" Head Dia., .3245" Stem Dia., 5.2550" O.A.L.
16	Keeper	FP-R91889		Exh. & Int.
QTY	VALVE SEAT	PART NO.	SIZE	DESCRIPTION
4	Exh.	FP-R85687	STD	
4	Int.	FP-R98335		.020" Dia. O/S face width; 1.8575" OD, 1.5500" ID, .2580" Depth
4	Int.	FP-R98063	STD	1.8575" OD, 1.5500" ID, .2580" Depth
QTY	VALVE SPRING	PART NO.	SIZE	DESCRIPTION
8	Spring	FP-R26125		Exh. & Int.; 2.1200" Free Height
QTY	VALVE MISC.	PART NO.	SIZE	DESCRIPTION
8	Rotocap	FP-RE60005		Exh. & Int.
<b>ELECTRICAL</b>				
QTY	ELECTRICAL	PART NO.	SIZE	DESCRIPTION
1	Starter to Block Gasket	FP-R53108		3-Hole mount; Starting motor codes 3005, 3006, 3010, 3011, 3012
<b>FUEL SYSTEM &amp; PARTS</b>				
QTY	FUEL INJECTION	PART NO.	SIZE	DESCRIPTION
4	Fuel Injector Nozzle	FP-RE48786		Nozzle codes 16BF, 16CE, 16CM, 16GL, 16LP, 16LQ, 16NH, 16OR, 16OS, 1606, 1608, 1675, 1677, 1682, 1683, 1692, 1694, 1695
4	Fuel Injector Seal	FP-R92352		Upper packing; w/Injector nozzle codes 16BF, 16CE, 16CM, 16CV, 16GL, 16LP, 16LQ, 16NH, 16OR, 1605, 1606, 1608, 1656, 1667, 1675, 1677, 1682, 1683, 1692, 1694, 1695
4	Fuel Injector Nut	FP-R79604		w/Injector nozzle codes 16HM, 16HN, 16HP, 16HQ, 16LK, 16LL
1	Washer Type Seal	FP-R51936		Aux. drive line; Line codes 5201, 5202, 5203, 5205, 5206
2	Washer Type Seal	FP-R51936		Fuel line; Aftercooled; Line codes 160B, 1611
2	Washer Type Seal	FP-R51936		Fuel line; Line codes 16BF, 16CE, 16CM, 16CV, 16GL, 16LN, 16LP, 16LQ, 16NH, 16OR, 1605, 1671, 1677, 1682
<b>COOLING SYSTEM</b>				
QTY	WATER PUMP	PART NO.	SIZE	DESCRIPTION
1	Water Pump - Heavy Duty	FP-RE500737 *		Standard flow
1	Water Pump Filter	FP-R98527		w/Pump housing marked RE70683
QTY	THERMOSTAT	PART NO.	SIZE	DESCRIPTION
1	Thermostat	FP-AR48675		w/Housing marked R54808, R59051, R89294, R100878; 180 Deg.
1	Thermostat	FP-RE33705		w/Housing marked T19651, T20218, R60256, R127777; 180 Deg.
<b>ENGINE BLOCK &amp; PARTS</b>				
QTY	GASKETS	PART NO.	SIZE	DESCRIPTION
1	Oil Pan Gasket	FP-R97342		Oil pan codes 1904, 1905; w/Stamped Steel Pan
2	O-Ring	FP-U13639		Block coolant drain plug seal; Coolant heater codes 2601, 2602; 1.475" X .118"
QTY	CAM BEARINGS	PART NO.	SIZE	DESCRIPTION
1	Cam Brg.	FP-R119874		
QTY	ENGINE BEARING MISC.	PART NO.	SIZE	DESCRIPTION
4	Balance Shaft Bearing	FP-R115299		Balance shaft code 4501
<b>CRANKSHAFT/OIL PUMP</b>				
QTY	SEALS - REAR CRANK	PART NO.	SIZE	DESCRIPTION
1	Crankshaft Rear Seal	FP-RE24959		
QTY	MAIN BEARINGS	PART NO.	SIZE	DESCRIPTION
4	Plain Main Brg.	FP-RE65165	STD	Crankshaft and Bearing code 4701
4	Plain Main Brg.	FP-RE65911	.25MM	Crankshaft and Bearing code 4701

(continued on next page)

\* New Item — Check For Availability

**15 Industrial Applications 4045T PowerTech Eng.**  
 (cont.) 4.5L 275.8 (4522cc) OHV Turbo-Diesel L4 (PowerTech 2V), 106mm Bore

**CRANKSHAFT/OIL PUMP (cont.)**

QTY	MAIN BEARINGS (cont.)	PART NO.	SIZE	DESCRIPTION
1	Flanged Main Brg.	FP-RE65168	STD	Crankshaft and Bearing code 4701
1	Flanged Main Brg.	FP-RE65912	.25MM	Crankshaft and Bearing code 4701

**CYLINDER COMPONENTS**

QTY	LINERS	PART NO.	SIZE	DESCRIPTION
4	Liner w/o Sealing Ring	FP-R121867	STD	
4	Cylinder Kit Complete	FP-RE507920	STD	Piston, Con. Rod, Cyl. liner code 4803; To Ser. No. 825,562
4	Cylinder Kit Complete	FP-RE507850	STD	Piston, Con. Rod, Cyl. liner code 4809; w/Con. Rod marked R500335
4	Cyl. Liner Sealing Ring Kit	FP-AR65507		

QTY	PISTONS	PART NO.	SIZE	DESCRIPTION
4	Piston Body w/o Pin	FP-RE505100	STD	Piston, Con. Rod, Cyl. liner code 4803; To Ser. No. 825,562; w/Con. Rod marked R123959; Small Pin
4	Piston Body w/o Pin	FP-RE55512	STD	Piston, Con. Rod, Cyl. liner code 4809; Large Pin; w/Con. Rod marked R500335
4	Pin	FP-R123178		Piston, Con. Rod, Cyl. liner code 4803; To Ser. No. 825,562; w/Con. Rod marked R123959; Small Pin; 1.375" pin dia.
4	Pin	FP-R123177		Piston, Con. Rod, Cyl. liner code 4809; w/Con. Rod marked R500335; Large Pin; 1.62" pin dia.
8	Piston Pin Retainer	FP-M41029		w/Con. Rod marked R123959; Small Pin; For 1.38" pin dia.
8	Piston Pin Retainer	FP-R54114		w/Con. Rod marked R500335; Large Pin; For 1.62" pin dia.
4	Pin Bushing	FP-R123960		w/Con. Rod marked R123959; Small Pin; 1.375" pin dia.
4	Pin Bushing	FP-R114082		w/Con. Rod marked R500335; Large Pin
4	Piston Pin Kit	FP-RE63915		Piston, Con. Rod, Cyl. liner code 4809; w/Con. Rod marked R500335; Large Pin; Incl. Pin, Retainers & Bushing

QTY	CONNECTING RODS & BRGS.	PART NO.	SIZE	DESCRIPTION
8	Con. Rod Bolt	FP-R114083		Cyl. Liner code 4803; w/Con. Rod marked R123959; To Ser. No. 793,991; Small Pin
8	Con. Rod Bolt	FP-R501124		Cyl. Liner code 4803; w/Con. Rod marked R123959, R500000; From Ser. No. 36,628
8	Con. Rod Bolt	FP-R501124		Cyl. Liner code 4809; w/Con. Rod marked R500000, R500335; From Ser. No. 36,628
8	Con. Rod Bolt	FP-R114083		Cyl. Liner code 4809; w/Con. Rod marked R500335; To Ser. No. 793,991; Small Pin
4	Rod Pair	FP-RE65908	STD	Cyl. Liner code 4809; w/Con. Rod marked R500335
4	Rod Pair	FP-RE65909	.25MM	Cyl. Liner code 4809; w/Con. Rod marked R500335
4	Rod Pair	FP-RE65908	STD	Cyl. Liner codes 4801, 4803; w/Con. Rod marked R123959, R500000
4	Rod Pair	FP-RE65909	.25MM	Cyl. Liner codes 4801, 4803; w/Con. Rod marked R123959, R500000

QTY	PISTON RINGS	PART NO.	SIZE	DESCRIPTION
4	Ring Set Single Cylinder	FP-RE66271	STD	Use w/RE505100, RE59277 piston
4	Ring Set Single Cylinder	FP-RE507852	STD	Use w/RE55512 piston; 1-1/8, 1-3/32, 1-.136 (1 cyl. set)
4	Ring Set Single Cylinder	FP-RE66820	STD	Use w/RE55512 piston; 1-1/8, 1-3/32, 1-.136 (1 cyl. set)

**KITS**

QTY	OVERHAUL KIT	PART NO.	SIZE	DESCRIPTION
1	In-Frame Overhaul Kit	FP-IFKPT4045T		Piston, Con. Rod, Cyl. liner code 4803; To Ser. No. 825,562

**16 Industrial Applications 4276D Eng.**  
 4.5L 276 OHV Diesel L4 (Standard), 4.1875" Bore

**CYL. HEAD & PARTS**

QTY	GASKETS	PART NO.	SIZE	DESCRIPTION
1	Valve Cover Gasket	FP-R73521		Rocker arm cover codes 1102, 1104, 1110
1	Valve Cover Gasket	FP-T20075		To Ser. No. 598,042
1	Head Gasket	FP-R125863		From Ser. No. 100,001; Manufactured after 1983
1	Head Gasket	FP-R125863		From Ser. No. 290,000 to Ser. No. 621,172; Manufactured 1974-83
1	Head Set	FP-RE38851		From Ser. No. 100,001; Manufactured after 1983
1	Head Set	FP-RE38851		From Ser. No. 290,000 to Ser. No. 621,172; Manufactured 1974-83

QTY	VALVE	PART NO.	SIZE	DESCRIPTION
4	Intake	FP-R79623	STD	2 groove; Chrome plated stem; 1.7720" Head Dia., .3720" Stem Dia., 5.1560" O.A.L.
4	Intake	FP-R79628	3	2 groove; Chrome plated stem; 1.7720" Head Dia., .3750" Stem Dia., 5.1560" O.A.L.

(continued on next page)

**Industrial Applications 4276D Eng. 16**  
4.5L 276 OHV Diesel L4 (Standard), 4.1875" Bore (cont.)

<b>CYL. HEAD &amp; PARTS (cont.)</b>				
<b>QTY</b>	<b>VALVE (cont.)</b>	<b>PART NO.</b>	<b>SIZE</b>	<b>DESCRIPTION</b>
4	Intake	FP-R79629	15	2 groove; Chrome plated stem; 1.7720" Head Dia., .3870" Stem Dia., 5.1560" O.A.L.
4	Intake	FP-R79630	30	2 groove; Chrome plated stem; 1.7720" Head Dia., .4020" Stem Dia., 5.1560" O.A.L.
4	Exhaust	FP-R79624	STD	1 groove; Chrome plated stem; 1.5750" Head Dia., .3720" Stem Dia., 5.1560" O.A.L.
4	Exhaust	FP-R79625	3	1 groove; Chrome plated stem; 1.5750" Head Dia., .3750" Stem Dia., 5.1560" O.A.L.
4	Exhaust	FP-R79626	15	1 groove; Chrome plated stem; 1.5750" Head Dia., .3870" Stem Dia., 5.1560" O.A.L.
4	Exhaust	FP-R79627	30	1 groove; Chrome plated stem; 1.5750" Head Dia., .4020" Stem Dia., 5.1560" O.A.L.
16	Keeper	FP-41339		1 groove; Square cut key groove
16	Keeper	FP-T20077		1 groove; Square cut key groove; Hardened
16	Keeper, Bulk	VK-138B		1 groove; Square cut key groove; Carton of 1000
<b>QTY</b>	<b>VALVE SEAT</b>	<b>PART NO.</b>	<b>SIZE</b>	<b>DESCRIPTION</b>
4	Exh.	FP-R73064	STD	
4	Int.	FP-R51734	STD	
<b>QTY</b>	<b>VALVE SPRING</b>	<b>PART NO.</b>	<b>SIZE</b>	<b>DESCRIPTION</b>
8	Spring	FP-R26125		2.1200" Free Height
<b>QTY</b>	<b>VALVE MISC.</b>	<b>PART NO.</b>	<b>SIZE</b>	<b>DESCRIPTION</b>
4	Rotocap	FP-RE11410		Exh.
1	Bushing	FP-T26321		Lower
1	Bushing	FP-T20034		Upper
1	Oil Filler Cap Gasket	FP-T20328		Rocker arm cover codes 1101, 1104; Oil filler neck codes 1201, 1202, 1203
<b>QTY</b>	<b>VALVE SEAL</b>	<b>PART NO.</b>	<b>SIZE</b>	<b>DESCRIPTION</b>
8	Valve Stem Seal	FP-R87627		Exh. & Int.; From Ser. No. 724,327; O-Ring type
<b>ELECTRICAL</b>				
<b>QTY</b>	<b>ELECTRICAL</b>	<b>PART NO.</b>	<b>SIZE</b>	<b>DESCRIPTION</b>
1	Starter to Block Gasket	FP-R53108		3-Hole mount; Starting motor codes 3001, 3017, 3018
<b>QTY</b>	<b>ALTERNATOR</b>	<b>PART NO.</b>	<b>SIZE</b>	<b>DESCRIPTION</b>
1	Ball Brg.	FP-JD9449		Front; Delco-Remy No. 1102936; 61 amp alternator
1	Ball Brg.	FP-JD9449		Front; Motorola No. A12NJD453; 35 amp alternator
1	Ball Brg.	FP-JD9449		Front; Motorola No. A12NJD604; 55 amp alternator
1	Ball Brg.	FP-JD9449		Front; Motorola No. 8TA2009ES; 30 amp alternator
1	Ball Brg.	FP-JD9449		Front; 12 Volt, 63 amp alternator; 72 amp alternator; 78 amp alternator
2	Ball Brg.	FP-JD9449		Front & Rear; Codes 3101, 3102, 3103, 3104, 3105, 3106, 3107, 3108, 3109, 3110, 3111, 3112, 3113, 3114, 3115, 3116, 3129; 65 amp alternator
<b>INT &amp; EXH MANIFOLDS</b>				
<b>QTY</b>	<b>INT. &amp; EXH. MANIFOLDS</b>	<b>PART NO.</b>	<b>SIZE</b>	<b>DESCRIPTION</b>
4	Exhaust Manifold Gasket	FP-R90658		
1	Air Intake Gasket	FP-R81275		
<b>CAMSHAFT GROUP</b>				
<b>QTY</b>	<b>TIMING COVER</b>	<b>PART NO.</b>	<b>SIZE</b>	<b>DESCRIPTION</b>
1	Timing Gear Cover Gasket	FP-T20273		Access cover
1	Timing Gear Cover Gasket	FP-R97454		Front cover
<b>QTY</b>	<b>CAMSHAFT/LIFTER</b>	<b>PART NO.</b>	<b>SIZE</b>	<b>DESCRIPTION</b>
8	Lifter	FP-T20073		
<b>FUEL SYSTEM &amp; PARTS</b>				
<b>QTY</b>	<b>FUEL INJECTION</b>	<b>PART NO.</b>	<b>SIZE</b>	<b>DESCRIPTION</b>
1	Injector Pump Gasket	FP-R125066		Gear cover
4	Fuel Injector Nozzle	FP-RE37503		Nozzle codes 1602, 1603, 1605; From Ser. No. 100,001; Manufactured after 1983
4	Fuel Injector Nozzle	FP-RE37503		Nozzle codes 1602, 1603, 1605; From Ser. No. 290,000 to Ser. No. 621,172; Manufactured 1974-83
4	Fuel Injector Seal	FP-R79605		Fuel line connection; Nozzle codes 1602, 1603, 1605; 9.270MM X 13.600MM X 5.080MM
4	Fuel Injector Seal	FP-R92352		Upper packing; w/Stanadyne® nozzle No. 26993
8	Washer	FP-T20055		Pump codes 1602, 1603
4	Fuel Injector Nut	FP-R79604		w/Injector marked 20291, 20504, 22205, 22264, 26993
8	Washer Type Seal	FP-R51936		Leak-off & return line seals; Nozzle codes 1602, 1603, 1613

(continued on next page)

<b>16 Industrial Applications 4276D Eng.</b>				
<b>(cont.) 4.5L 276 OHV Diesel L4 (Standard), 4.1875" Bore</b>				
<b>FUEL SYSTEM &amp; PARTS (cont.)</b>				
<b>QTY</b>	<b>FUEL INJECTION (cont.)</b>	<b>PART NO.</b>	<b>SIZE</b>	<b>DESCRIPTION</b>
4	Washer Type Seal	FP-R48000		Lower; w/Nozzle codes 1602, 1603, 1625; w/Nozzle marked 26993
4	Washer Type Seal	FP-R60746		Upper; Nozzle codes 1602, 1603, 1605; From Ser. No. 609,312
<b>QTY</b>	<b>FUEL FILTERS &amp; PUMP</b>	<b>PART NO.</b>	<b>SIZE</b>	<b>DESCRIPTION</b>
1	Mechanical Fuel Pump	FP-RE42211		Transfer pump
1	Fuel Transfer Pump Gasket	FP-R97350		
<b>COOLING SYSTEM</b>				
<b>QTY</b>	<b>WATER PUMP</b>	<b>PART NO.</b>	<b>SIZE</b>	<b>DESCRIPTION</b>
1	Water Pump Impeller	FP-R47191		w/Pump housing marked R66420, R68733
1	Water Pump Impeller	FP-R94419		Pump code 2001; w/Pump housing marked R54805, R59049
1	Water Pump Repair/Rebuild Kit	FP-925740979		w/Pump housing marked R56787, R62902
1	Water Pump Repair/Rebuild Kit	FP-RE62661		w/Pump housing marked R66420, R68733
1	Water Pump Housing Gasket	FP-R55405		w/Pump housing marked R54805, R59049
1	Oil Seal Kit	FP-AR101549		Water Pump; w/Pump housing marked R55164, R90783
1	Water Pump Mounting Gasket	FP-T20243		w/Pump housing marked R54805, R59049
1	Shaft & Bearing Assembly	FP-JD9257		w/Pump housing marked R54805, R59049
<b>QTY</b>	<b>THERMOSTAT</b>	<b>PART NO.</b>	<b>SIZE</b>	<b>DESCRIPTION</b>
2	Thermostat	FP-AR48675		Thermostat code 2204; Thermostat cover code 2102 Vertical, 2201 Horizontal; Housing marked R89294, From Ser. No. 366,183; 180 Deg.
2	Thermostat	FP-AR48675		Thermostat code 2204; Thermostat cover code 2102 Vertical, 2201 Horizontal; To Ser. No. 366,182; 180 Deg.
1	Thermostat Gasket	FP-T20219		Thermostat cover code 2101, 2102
1	Thermostat Cover Gasket	FP-T20215		Thermostat cover codes 2101, 2102
2	O-Ring	FP-R56461		Thermostat housing tube seals; Housing code 2204; To Ser. No. 366,182
<b>ENGINE BLOCK &amp; PARTS</b>				
<b>QTY</b>	<b>GASKETS</b>	<b>PART NO.</b>	<b>SIZE</b>	<b>DESCRIPTION</b>
1	Flywheel Housing Gasket	FP-R97351		Flywheel housing code 1425; From Ser. No. 100,001
1	Flywheel Housing Gasket	FP-R97351		Flywheel housing codes 1410, 1411, 1432
1	Oil Pan Gasket	FP-R119360		From Ser. No. 100,001; Manufactured after 1983; Oil pan codes 1901, 1902, 1903; w/Cast iron oil pan
1	Oil Pan Gasket	FP-R119360		From Ser. No. 290,000 to Ser. No. 621,172; Manufactured 1974-83; Oil pan codes 1901, 1903; w/Cast iron oil pan
1	Oil Pan Gasket	FP-R97342		Oil pan code 1904; w/Stamped Steel Pan
1	O-Ring	FP-U13639		Block coolant drain plug seal; 1.475" X .118"
1	Block to End Plate Front Gskt	FP-R131794		From Ser. No. 100,001; Manufactured after 1983
1	Block to End Plate Front Gskt	FP-R131794		From Ser. No. 290,000 to Ser. No. 621,172; Manufactured 1974-83
<b>QTY</b>	<b>GASKET SETS</b>	<b>PART NO.</b>	<b>SIZE</b>	<b>DESCRIPTION</b>
1	Gasket Conversion Set	FP-PG219CS		Wear sleeve incl.
1	In-Frame Gasket Set	FP-PG219S		
1	Complete Overhaul Gasket Set	FP-RE37715		Crankshaft seals not incl.
1	Complete Overhaul Gasket Set	FP-RE37715WS		Incl. crankshaft seals; Rear main brg. seal incl.; Wear sleeve not incl.
<b>QTY</b>	<b>ENGINE BEARING MISC.</b>	<b>PART NO.</b>	<b>SIZE</b>	<b>DESCRIPTION</b>
1	Bal. Shaft Set	FP-R57160S		
6	Balance Shaft Bearing	FP-R57160		
<b>QTY</b>	<b>OIL COOLERS &amp; FILTERS</b>	<b>PART NO.</b>	<b>SIZE</b>	<b>DESCRIPTION</b>
1	Oil Cooler Gasket	FP-R98486		From Ser. No. 100,001; Manufactured after 1983
1	Oil Cooler Gasket	FP-R98487		From Ser. No. 100,001; Manufactured after 1983; Lower oil cooler cover
1	Oil Cooler Gasket	FP-R98486		From Ser. No. 290,000 to Ser. No. 621,172; Manufactured 1974-83
1	Oil Cooler Gasket	FP-R98487		From Ser. No. 290,000 to Ser. No. 621,172; Manufactured 1974-83; Lower oil cooler cover
1	O-Ring	FP-A4730R		From Ser. No. 100,001; Manufactured after 1983; Oil cooler to block check valve seal
1	O-Ring	FP-A4730R		From Ser. No. 290,000 to Ser. No. 621,172; Manufactured 1974-83; Oil cooler to block check valve seal
1	O-Ring	FP-R56814		Oil cooler housing inner seal; From Ser. No. 100,001; Manufactured after 1983
1	O-Ring	FP-R56814		Oil cooler housing inner seal; From Ser. No. 290,000 to Ser. No. 621,172; Manufactured 1974-83
1	O-Ring	FP-R56815		Oil cooler housing inner seal; From Ser. No. 290,000 to Ser. No. 621,172; Manufactured 1974-83

(continued on next page)



*Industrial Applications 4276D Eng. 16*  
4.5L 276 OHV Diesel L4 (Standard), 4.1875" Bore (cont.)

<b>ENGINE BLOCK &amp; PARTS (cont.)</b>				
<b>OIL COOLERS &amp; FILTERS</b>				
<b>QTY</b>	<b>(cont.)</b>	<b>PART NO.</b>	<b>SIZE</b>	<b>DESCRIPTION</b>
1	O-Ring	FP-R56815		Oil cooler housing outer seal; From Ser. No. 100,001; Manufactured after 1983
<b>CRANKSHAFT/OIL PUMP</b>				
<b>QTY</b>	<b>CRANKSHAFT</b>	<b>PART NO.</b>	<b>SIZE</b>	<b>DESCRIPTION</b>
1	Crankshaft	FP-RE56792		Crankshaft marked R54501, R108657
1	Oil Seal Kit	FP-SK67942		Incl. front & rear seals; Crankshaft marked R120009
<b>QTY</b>	<b>SEALS - FRONT CRANK</b>	<b>PART NO.</b>	<b>SIZE</b>	<b>DESCRIPTION</b>
1	Crankshaft Front Seal	FP-AR67942		
1	O-Ring	FP-H35244		Crankshaft pulley; w/Crankshaft marked R12009
<b>QTY</b>	<b>SEALS - REAR CRANK</b>	<b>PART NO.</b>	<b>SIZE</b>	<b>DESCRIPTION</b>
1	Crankshaft Rear Seal	FP-RE24959		Crankshaft codes 1301, 1302; Flywheel housing codes 1403, 1404, 1405, 1421, 1425, 1432
<b>QTY</b>	<b>MAIN BEARINGS</b>	<b>PART NO.</b>	<b>SIZE</b>	<b>DESCRIPTION</b>
1	Main Set	FP-MBK3004	STD	w/Flanged thrust brg.
1	Main Set	FP-MBK300410	10	w/Flanged thrust brg.
1	Main Set	FP-MBK300420	20	w/Flanged thrust brg.
1	Main Set	FP-MBK300430	30	w/Flanged thrust brg.
4	Plain Main Brg.	FP-RE27352	STD	w/Flangeless thrust brg.
4	Plain Main Brg.	FP-RE27353	10	w/Flangeless thrust brg.
4	Plain Main Brg.	FP-RE27360	20	w/Flangeless thrust brg.
4	Plain Main Brg.	FP-RE27368	30	w/Flangeless thrust brg.
1	Flanged Main Brg.	FP-RE521350	STD	
1	Flanged Main Brg.	FP-RE526754	10	
1	Flanged Main Brg.	FP-RE527235	20	
1	Flanged Main Brg.	FP-RE527236	30	
4	Thrust Washer	FP-R78598	STD	
<b>QTY</b>	<b>OIL PUMP</b>	<b>PART NO.</b>	<b>SIZE</b>	<b>DESCRIPTION</b>
1	O-Ring	FP-R61871		Oil pump inlet; w/Pump housing marked R54629
1	O-Ring	FP-R80632		Oil Pump outlet tube
1	Oil Filler Inlet Gasket	FP-R97352		Oil filler neck codes 1201, 1202, 1203
1	Oil Filter Adapter Gasket	FP-R98488		w/Filter adapter marked R131238
1	Oil Pump Seal Ring	FP-R79563		Oil pump outlet adapter; w/Pump marked R54629; To Ser. No. 122,703
<b>CYLINDER COMPONENTS</b>				
<b>QTY</b>	<b>LINERS</b>	<b>PART NO.</b>	<b>SIZE</b>	<b>DESCRIPTION</b>
4	Liner w/o Sealing Ring	FP-R121867	STD	
4	Liner w/Sealing Rings	FP-RE500024	STD	1.38" pin dia.
4	Cylinder Kit Complete	FP-RE19831	STD	w/Con. Rod marked R54617; 1.38" pin dia.
4	Cylinder Kit Complete	FP-RE19833	STD	w/Con. Rod marked R56187, R116851; Pin dia. 1.62"
4	Cylinder Kit Complete	FP-RE28966	STD	1.62" pin dia.
4	Cyl. Liner Sealing Ring Kit	FP-AR65507		
4	Sealing Ring, Liner	FP-R48767		Rectangle; Top
4	Sealing Ring, Liner	FP-R26121		Round; Middle
4	Sealing Ring	FP-SLR2520		Round; Bottom
<b>QTY</b>	<b>PISTONS</b>	<b>PART NO.</b>	<b>SIZE</b>	<b>DESCRIPTION</b>
4	Piston Body w/o Pin	FP-AR63342	STD	1.38" pin dia.
4	Piston Body w/o Pin	FP-AR68188	STD	1.62" pin dia.
4	Piston Kit w/Pin & Retainers	FP-AR63342WP	STD	1.38" pin dia.
4	Piston Kit w/Pin & Retainers	FP-AR68188WP	STD	1.62" pin dia.
4	Pin	FP-R125754		1.38" pin dia.
4	Pin	FP-R124230		1.62" pin dia.
8	Piston Pin Retainer	FP-R54114		Large Pin; For 1.62" pin dia.
8	Piston Pin Retainer	FP-M41029		Small Pin; For 1.38" pin dia.
4	Pin Bushing	FP-R57450		w/Con. Rod marked R54617; Pin dia. 1.38"; w/1.38" pin dia.
4	Pin Bushing	FP-R57451		w/Con. Rod marked R56187, R116851; Pin dia. 1.62"; 1.621" ID, 1.813" OD, 1.370" O.A.L.
<b>QTY</b>	<b>CONNECTING RODS &amp; BRGS.</b>	<b>PART NO.</b>	<b>SIZE</b>	<b>DESCRIPTION</b>
8	Con. Rod Bolt	FP-R74195		w/Con. Rod marked R54617, R56187, R116851; Torque-To-Yield bolt; Replacement recommended
4	Rod Pair	FP-AR97517	STD	
4	Rod Pair	FP-AR97653	10	
4	Rod Pair	FP-AR97654	20	
4	Rod Pair	FP-AR97655	30	

(continued on next page)

**16 Industrial Applications 4276D Eng.**  
(cont.) 4.5L 276 OHV Diesel L4 (Standard), 4.1875" Bore

**CYLINDER COMPONENTS (cont.)**

QTY	PISTON RINGS	PART NO.	SIZE	DESCRIPTION
4	Ring Set Single Cylinder	FP-RE507852	STD	1-1/8, 1-3/32, 1-.136 (1 cyl. set)
4	Ring Set Single Cylinder	FP-RE66820	STD	1-1/8, 1-3/32, 1-.136 (1 cyl. set)

**KITS**

QTY	OVERHAUL KIT	PART NO.	SIZE	DESCRIPTION
1	In-Frame Overhaul Kit	FP-276DSPIFK		w/Con. Rod marked R54617; Pin dia. 1.38"; w/1.38" pin dia.
1	In-Frame Overhaul Kit	FP-276DLPIFK		w/Con. Rod marked R56187, R116851; Pin dia. 1.62"; w/1.62" pin dia.
1	Complete Overhaul Kit	FP-276DSPOHK		w/Con. Rod marked R54617; Pin dia. 1.38"; Incl. front & rear seals; Crankshaft marked R120009; w/1.38" pin dia.
1	Complete Overhaul Kit	FP-276DLPOHK		w/Con. Rod marked R56187, R116851; Pin dia. 1.62"; Incl. front & rear seals; Crankshaft marked R120009; w/1.62" pin dia.

**17 Industrial Applications 4276T Eng.**  
4.5L 276 OHV Turbo-Diesel L4 (Standard), 4.1875" Bore

**CYL. HEAD & PARTS**

QTY	GASKETS	PART NO.	SIZE	DESCRIPTION
1	Valve Cover Gasket	FP-R73521		Rocker arm cover codes 1101, 1102, 1104, 1110
1	Valve Cover Gasket	FP-T20075		To Ser. No. 598,042
1	Head Gasket	FP-R125863		From Ser. No. 100,001; Manufactured after 1983
1	Head Gasket	FP-R125863		From Ser. No. 290,000 to Ser. No. 621,172; Manufactured 1974-83
1	Head Set	FP-RE38851		From Ser. No. 100,001; Manufactured after 1983
1	Head Set	FP-RE38851		From Ser. No. 290,000 to Ser. No. 621,172; Manufactured 1974-83

QTY	VALVE	PART NO.	SIZE	DESCRIPTION
4	Intake	FP-R83071	STD	Stellite; 2 groove; Chrome plated stem; 1.8210" Head Dia., .3720" Stem Dia., 5.1660" O.A.L.
4	Intake	FP-R89223	3	Stellite; 2 groove; Chrome plated stem; 1.8210" Head Dia., .3750" Stem Dia., 5.1660" O.A.L.
4	Intake	FP-R89224	15	Stellite; 2 groove; Chrome plated stem; 1.8210" Head Dia., .3870" Stem Dia., 5.1660" O.A.L.
4	Intake	FP-R79623	STD	2 groove; Chrome plated stem; 1.7720" Head Dia., .3720" Stem Dia., 5.1560" O.A.L.
4	Intake	FP-R79628	3	2 groove; Chrome plated stem; 1.7720" Head Dia., .3750" Stem Dia., 5.1560" O.A.L.
4	Intake	FP-R79629	15	2 groove; Chrome plated stem; 1.7720" Head Dia., .3870" Stem Dia., 5.1560" O.A.L.
4	Intake	FP-R79630	30	2 groove; Chrome plated stem; 1.7720" Head Dia., .4020" Stem Dia., 5.1560" O.A.L.
4	Exhaust	FP-R79624	STD	1 groove; Chrome plated stem; 1.5750" Head Dia., .3720" Stem Dia., 5.1560" O.A.L.
4	Exhaust	FP-R79625	3	1 groove; Chrome plated stem; 1.5750" Head Dia., .3750" Stem Dia., 5.1560" O.A.L.
4	Exhaust	FP-R79626	15	1 groove; Chrome plated stem; 1.5750" Head Dia., .3870" Stem Dia., 5.1560" O.A.L.
4	Exhaust	FP-R79627	30	1 groove; Chrome plated stem; 1.5750" Head Dia., .4020" Stem Dia., 5.1560" O.A.L.
16	Keeper	FP-41339		1 groove; Square cut key groove
16	Keeper	FP-T20077		1 groove; Square cut key groove; Hardened
16	Keeper, Bulk	VK-138B		1 groove; Square cut key groove; Carton of 1000

QTY	VALVE SEAT	PART NO.	SIZE	DESCRIPTION
4	Exh.	FP-R51734	STD	
4	Int.	FP-R73064	STD	

QTY	VALVE SPRING	PART NO.	SIZE	DESCRIPTION
8	Spring	FP-R26125		2.1200" Free Height

QTY	VALVE MISC.	PART NO.	SIZE	DESCRIPTION
8	Rotocap	FP-RE11410		Exh. & Int.
1	Bushing	FP-T26321		Lower
1	Bushing	FP-T20034		Upper
1	Oil Filler Cap Gasket	FP-T20328		Rocker arm cover codes 1101, 1104; Oil filler neck codes 1201, 1202, 1203

QTY	VALVE SEAL	PART NO.	SIZE	DESCRIPTION
8	Valve Stem Seal	FP-R87627		O-Ring type

(continued on next page)



*Industrial Applications 4276T Eng. 17*  
4.5L 276 OHV Turbo-Diesel L4 (Standard), 4.1875" Bore (cont.)

<b>ELECTRICAL</b>				
<b>QTY</b>	<b>ELECTRICAL</b>	<b>PART NO.</b>	<b>SIZE</b>	<b>DESCRIPTION</b>
1	Starter to Block Gasket	FP-R53108		3-Hole mount; Starting motor codes 3001, 3017, 3018
<b>INT &amp; EXH MANIFOLDS</b>				
<b>QTY</b>	<b>INT. &amp; EXH. MANIFOLDS</b>	<b>PART NO.</b>	<b>SIZE</b>	<b>DESCRIPTION</b>
4	Exhaust Manifold Gasket	FP-R90658		
1	Air Intake Gasket	FP-R81275		
<b>CAMSHAFT GROUP</b>				
<b>QTY</b>	<b>TIMING COVER</b>	<b>PART NO.</b>	<b>SIZE</b>	<b>DESCRIPTION</b>
1	Timing Gear Cover Gasket	FP-T20273		Access cover
1	Timing Gear Cover Gasket	FP-R97454		Front cover
<b>QTY</b>	<b>CAMSHAFT/LIFTER</b>	<b>PART NO.</b>	<b>SIZE</b>	<b>DESCRIPTION</b>
8	Lifter	FP-T20073		
<b>FUEL SYSTEM &amp; PARTS</b>				
<b>QTY</b>	<b>FUEL INJECTION</b>	<b>PART NO.</b>	<b>SIZE</b>	<b>DESCRIPTION</b>
1	Injector Pump Gasket	FP-R125066		Gear cover
4	Fuel Injector Nozzle	FP-RE37503		Nozzle codes 1602, 1603, 1605; From Ser. No. 100,001; Manufactured after 1983
4	Fuel Injector Nozzle	FP-RE37503		Nozzle codes 1602, 1603, 1605; From Ser. No. 290,000 to Ser. No. 621,172; Manufactured 1974-83
4	Fuel Injector Seal	FP-R79605		Fuel line connection; Nozzle codes 1602, 1603, 1605; 9.270MM X 13.600MM X 5.080MM
4	Fuel Injector Seal	FP-R92352		Upper packing; w/Stanadyne® nozzle No. 26993
4	Fuel Injector Nut	FP-R79604		w/Injector marked 20291, 20504, 22205, 22264, 26993
1	Washer Type Seal	FP-R51936		Leak-off & return line seals; Nozzle codes 1602, 1603, 1605
1	Washer Type Seal	FP-R48000		Lower; w/Nozzle codes 1602, 1603, 1605; w/Nozzle marked 26993
1	Washer Type Seal	FP-R60746		Upper; Nozzle codes 1602, 1603, 1605; From Ser. No. 609,312
<b>QTY</b>	<b>FUEL FILTERS &amp; PUMP</b>	<b>PART NO.</b>	<b>SIZE</b>	<b>DESCRIPTION</b>
1	Mechanical Fuel Pump	FP-RE42211		Transfer pump
1	Fuel Transfer Pump Gasket	FP-R97350		
<b>QTY</b>	<b>TURBOCHARGER</b>	<b>PART NO.</b>	<b>SIZE</b>	<b>DESCRIPTION</b>
1	Turbocharger Oil Drain Gasket	FP-R105346		
1	Turbocharger Mounting Gasket	FP-R89879		From Ser. No. 100,001; Manufactured after 1983
1	Turbocharger Mounting Gasket	FP-R89879		From Ser. No. 290,000 to Ser. No. 621,172; Manufactured 1974-83
1	Turbocharger Oil Supply Gskt.	FP-R97348		To Ser. No. 148,514
<b>COOLING SYSTEM</b>				
<b>QTY</b>	<b>WATER PUMP</b>	<b>PART NO.</b>	<b>SIZE</b>	<b>DESCRIPTION</b>
1	Water Pump Impeller	FP-R47191		w/Pump housing marked R66420, R68733
1	Water Pump Impeller	FP-R56812		Pump code 2001
1	Water Pump Repair/Rebuild Kit	FP-864340979		w/Pump housing marked R51661, R73606, R73724, R79171
1	Water Pump Repair/Rebuild Kit	FP-RE62661		w/Pump housing marked R66420, R68733
1	Water Pump Housing Gasket	FP-R56809		w/Pump housing marked AR80116
1	Oil Seal Kit	FP-AR101549		Water Pump; w/Pump housing marked R55164, R90783
1	Water Pump Mounting Gasket	FP-T20243		w/Pump housing marked R54805, R59049
1	Shaft & Bearing Assembly	FP-JD8643		w/Pump housing marked AR80116
<b>QTY</b>	<b>THERMOSTAT</b>	<b>PART NO.</b>	<b>SIZE</b>	<b>DESCRIPTION</b>
2	Thermostat	FP-AR48675		Thermostat code 2204; 180 Deg.
1	Thermostat Gasket	FP-T20219		Thermostat housing code 3901
1	Thermostat Cover Gasket	FP-T20215		Thermostat cover codes 2101, 2102
2	O-Ring	FP-R56461		Thermostat housing tube seals; Housing code 3901
<b>ENGINE BLOCK &amp; PARTS</b>				
<b>QTY</b>	<b>GASKETS</b>	<b>PART NO.</b>	<b>SIZE</b>	<b>DESCRIPTION</b>
1	Flywheel Housing Gasket	FP-R97351		Use w/Flywheel housing marked R120034, R98778; Use w/thin profile flywheel housing
1	Oil Pan Gasket	FP-R97342		w/Stamped Steel Pan
1	O-Ring	FP-U13639		Block coolant drain plug seal; 1.475" X .118"
1	Block to End Plate Front Gskt	FP-R131794		From Ser. No. 100,001; Manufactured after 1983
1	Block to End Plate Front Gskt	FP-R131794		From Ser. No. 290,000 to Ser. No. 621,172; Manufactured 1974-83
<b>QTY</b>	<b>GASKET SETS</b>	<b>PART NO.</b>	<b>SIZE</b>	<b>DESCRIPTION</b>
1	Gasket Conversion Set	FP-PG219CS		Wear sleeve incl.
1	In-Frame Gasket Set	FP-PG219S		
1	Complete Overhaul Gasket Set	FP-RE37715		Crankshaft seals not incl.

(continued on next page)

## 17 Industrial Applications 4276T Eng. (cont.) 4.5L 276 OHV Turbo-Diesel L4 (Standard), 4.1875" Bore

ENGINE BLOCK & PARTS (cont.)				
QTY		PART NO.	SIZE	DESCRIPTION
1	<b>GASKET SETS</b> (cont.) Complete Overhaul Gasket Set	FP-RE37715WS		Incl. crankshaft seals; Rear main brg. seal incl.; Wear sleeve not incl.
1	<b>ENGINE BEARING MISC.</b> Bal. Shaft Set	FP-R57160S		
6	Balance Shaft Bearing	FP-R57160		
1	<b>OIL COOLERS &amp; FILTERS</b> Oil Cooler Gasket	FP-R98486		From Ser. No. 100,001; Manufactured after 1983
1	Oil Cooler Gasket	FP-R98487		From Ser. No. 100,001; Manufactured after 1983; Lower oil cooler cover
1	Oil Cooler Gasket	FP-R98486		From Ser. No. 290,000 to Ser. No. 621,172; Manufactured 1974-83
1	Oil Cooler Gasket	FP-R98487		From Ser. No. 290,000 to Ser. No. 621,172; Manufactured 1974-83; Lower oil cooler cover
1	O-Ring	FP-A4730R		From Ser. No. 100,001; Manufactured after 1983; Oil cooler to block check valve seal
1	O-Ring	FP-A4730R		From Ser. No. 290,000 to Ser. No. 621,172; Manufactured 1974-83; Oil cooler to block check valve seal
1	O-Ring	FP-R56815		Oil cooler housing outer seal; From Ser. No. 100,001; Manufactured after 1983
1	O-Ring	FP-R56815		Oil cooler housing outer seal; From Ser. No. 290,000 to Ser. No. 621,172; Manufactured 1974-83
CRANKSHAFT/OIL PUMP				
1	<b>CRANKSHAFT</b> Crankshaft	FP-RE56792		Crankshaft marked R54501, R108657
1	Oil Seal Kit	FP-SK67942		Incl. front & rear seals; Crankshaft codes 1301, 1302; Crankshaft marked R120009
1	<b>SEALS - FRONT CRANK</b> Crankshaft Front Seal	FP-AR67942		
1	O-Ring	FP-H35244		Crankshaft pulley; Crankshaft marked R12009
1	<b>SEALS - REAR CRANK</b> Crankshaft Rear Seal	FP-RE24959		
1	<b>MAIN BEARINGS</b> Main Set	FP-MBK3004	STD	w/Flanged thrust brg.
1	Main Set	FP-MBK300410	10	w/Flanged thrust brg.
1	Main Set	FP-MBK300420	20	w/Flanged thrust brg.
1	Main Set	FP-MBK300430	30	w/Flanged thrust brg.
4	Plain Main Brg.	FP-RE27352	STD	w/Flangeless thrust brg.
4	Plain Main Brg.	FP-RE27353	10	w/Flangeless thrust brg.
4	Plain Main Brg.	FP-RE27360	20	w/Flangeless thrust brg.
4	Plain Main Brg.	FP-RE27368	30	w/Flangeless thrust brg.
1	Flanged Main Brg.	FP-RE521350	STD	
1	Flanged Main Brg.	FP-RE526754	10	
1	Flanged Main Brg.	FP-RE527235	20	
1	Flanged Main Brg.	FP-RE527236	30	
4	Thrust Washer	FP-R78598	STD	
1	<b>OIL PUMP</b> O-Ring	FP-R61871		Oil pump inlet; w/Pump housing marked R54629
1	O-Ring	FP-R80632		Oil Pump outlet tube
1	Oil Filler Inlet Gasket	FP-R97352		Oil filler neck codes 1201, 1202, 1203
1	Oil Filter Adapter Gasket	FP-R98488		w/Filter adapter marked R131238
1	Oil Pump Seal Ring	FP-R79563		Oil pump outlet adapter; w/Pump marked R54629; To Ser. No. 122,703
CYLINDER COMPONENTS				
4	<b>LINERS</b> Liner w/o Sealing Ring	FP-R121867	STD	
4	Liner w/Sealing Rings	FP-RE500024	STD	Pin dia. 1.62"
4	Cylinder Kit Complete	FP-RE19832	STD	w/Con. Rod marked R56187; Pin dia. 1.62"
4	Cyl. Liner Sealing Ring Kit	FP-AR65507		
4	Sealing Ring, Liner	FP-R48767		Rectangle; Top
4	Sealing Ring, Liner	FP-R26121		Round; Middle
4	Sealing Ring	FP-SLR2520		Round; Bottom
4	<b>PISTONS</b> Piston Body w/o Pin	FP-AR96389		
4	Piston Kit w/Pin & Retainers	FP-AR96389WP		
4	Pin	FP-R124230		1.62" pin dia.

(continued on next page)





*Industrial Applications 4276T Eng. 17*  
4.5L 276 OHV Turbo-Diesel L4 (Standard), 4.1875" Bore (cont.)

<b>CYLINDER COMPONENTS (cont.)</b>				
<b>QTY</b>	<b>PISTONS (cont.)</b>	<b>PART NO.</b>	<b>SIZE</b>	<b>DESCRIPTION</b>
8	Piston Pin Retainer	FP-R54114		For 1.62" pin dia. w/Con. Rod marked R56187, R116851; Pin dia. 1.62"; 1.621" ID, 1.813" OD, 1.370" O.A.L.
4	Pin Bushing	FP-R57451		
<b>CONNECTING RODS &amp; BRGS.</b>				
<b>QTY</b>		<b>PART NO.</b>	<b>SIZE</b>	<b>DESCRIPTION</b>
8	Con. Rod Bolt	FP-R74195		w/Con. Rod marked R54617, R56187, R116851; Torque-To-Yield bolt; Replacement recommended
4	Rod Pair	FP-AR97517	STD	
4	Rod Pair	FP-AR97653	10	
4	Rod Pair	FP-AR97654	20	
4	Rod Pair	FP-AR97655	30	
<b>PISTON RINGS</b>				
<b>QTY</b>		<b>PART NO.</b>	<b>SIZE</b>	<b>DESCRIPTION</b>
4	Ring Set Single Cylinder	FP-RE507852	STD	1-1/8, 1-3/32, 1-.136 (1 cyl. set)
4	Ring Set Single Cylinder	FP-RE66820	STD	1-1/8, 1-3/32, 1-.136 (1 cyl. set)
<b>KITS</b>				
<b>QTY</b>	<b>OVERHAUL KIT</b>	<b>PART NO.</b>	<b>SIZE</b>	<b>DESCRIPTION</b>
1	In-Frame Overhaul Kit	FP-276TIFK		w/Con. Rod marked R56187, R116851; Pin dia. 1.62"; Incl. Torque-To-Yield con. rod bolts
1	Complete Overhaul Kit	FP-276TOHK		w/Con. Rod marked R56187, R116851; Pin dia. 1.62"; Incl. front & rear seals; Crankshaft codes 1301, 1302; Crankshaft marked R120009; Incl. Torque-To-Yield con. rod bolts

*Industrial Applications 6068HN PowerTech Eng. (Natural Gas) 18*  
6.8L 413.8 (6784cc) OHV Turbo-NG L6 (PowerTech 2V IC), 106mm Bore

<b>CYL. HEAD &amp; PARTS</b>				
<b>QTY</b>	<b>GASKETS</b>	<b>PART NO.</b>	<b>SIZE</b>	<b>DESCRIPTION</b>
1	Valve Cover Gasket	FP-R123543		Head & valve code 5113
1	Head Gasket	FP-R116516		
<b>QTY</b>	<b>VALVE</b>	<b>PART NO.</b>	<b>SIZE</b>	<b>DESCRIPTION</b>
24	Keeper	FP-R91889		Head & valve code 5113
<b>QTY</b>	<b>VALVE SPRING</b>	<b>PART NO.</b>	<b>SIZE</b>	<b>DESCRIPTION</b>
12	Spring	FP-R26125		Head & valve code 5113; 2.1200" Free Height
<b>QTY</b>	<b>VALVE MISC.</b>	<b>PART NO.</b>	<b>SIZE</b>	<b>DESCRIPTION</b>
12	Rotocap	FP-RE60005		Exh. & Int.; Head & valve code 5113
<b>INT &amp; EXH MANIFOLDS</b>				
<b>QTY</b>	<b>INT. &amp; EXH. MANIFOLDS</b>	<b>PART NO.</b>	<b>SIZE</b>	<b>DESCRIPTION</b>
6	Exhaust Manifold Gasket	FP-R90658		Exh. manifold, shield code 2817
<b>COOLING SYSTEM</b>				
<b>QTY</b>	<b>WATER PUMP</b>	<b>PART NO.</b>	<b>SIZE</b>	<b>DESCRIPTION</b>
1	Water Pump Filter	FP-R98527		Water pump code 4404; Pump marked R500401
<b>QTY</b>	<b>THERMOSTAT</b>	<b>PART NO.</b>	<b>SIZE</b>	<b>DESCRIPTION</b>
1	Thermostat	FP-AR72852		Thermostat code 2203; 192 Deg.
1	O-Ring	FP-R26286		Sensor seal; Thermostat codes 2108, 2203
<b>ENGINE BLOCK &amp; PARTS</b>				
<b>QTY</b>	<b>GASKETS</b>	<b>PART NO.</b>	<b>SIZE</b>	<b>DESCRIPTION</b>
1	Oil Pan Gasket	FP-R123354		Block coolant drain plug seal; Block code 4604; 1.475" X .118"
2	O-Ring	FP-U13639		
<b>QTY</b>	<b>CAM BEARINGS</b>	<b>PART NO.</b>	<b>SIZE</b>	<b>DESCRIPTION</b>
1	Cam Brg.	FP-R119874		Block code 4604
<b>CRANKSHAFT/OIL PUMP</b>				
<b>QTY</b>	<b>MAIN BEARINGS</b>	<b>PART NO.</b>	<b>SIZE</b>	<b>DESCRIPTION</b>
6	Plain Main Brg.	FP-RE65165	STD	Crankshaft and Bearing code 4702; w/Crankshaft marked R116076
6	Plain Main Brg.	FP-RE65911	.25MM	Crankshaft and Bearing code 4702; w/Crankshaft marked R116076
1	Flanged Main Brg.	FP-RE65168	STD	Crankshaft and Bearing code 4702; w/Crankshaft marked R116076
1	Flanged Main Brg.	FP-RE65912	.25MM	Crankshaft and Bearing code 4702; w/Crankshaft marked R116076

(continued on next page)

<b>18 Industrial Applications 6068HN PowerTech Eng. (Natural Gas)</b> (cont.) 6.8L 413.8 (6784cc) OHV Turbo-NG L6 (PowerTech 2V IC), 106mm Bore				
<b>CRANKSHAFT/OIL PUMP (cont.)</b>				
QTY	OIL PUMP	PART NO.	SIZE	DESCRIPTION
1	O-Ring	FP-R61871		Oil pump code 5001; Oil pump inlet seal
1	O-Ring	FP-R72328		Vent tube elbow seal; Rocker arm cover code 1104
<b>CYLINDER COMPONENTS</b>				
QTY	LINERS	PART NO.	SIZE	DESCRIPTION
6	Cyl. Liner Sealing Ring Kit	FP-AR65507		Piston & rod bearing code 4811
QTY	PISTONS	PART NO.	SIZE	DESCRIPTION
6	Pin	FP-R123177		Piston & rod bearing code 4811; 1.62" pin dia.
12	Piston Pin Retainer	FP-R54114		Piston & rod bearing code 4811; For 1.62" pin dia.
6	Pin Bushing	FP-R114082		Use w/Con. Rod marked R500335
6	Piston Pin Kit	FP-RE63915		Piston & rod bearing code 4811; Incl. Pin, Retainers & Bushing
QTY	CONNECTING RODS & BRGS.	PART NO.	SIZE	DESCRIPTION
12	Con. Rod Bolt	FP-R501124		Use w/Con. Rod marked R500335
6	Rod Pair	FP-RE65908	STD	Piston & rod bearing code 4811
6	Rod Pair	FP-RE65909	.25MM	Piston & Rod bearing code 4811
QTY	PISTON RINGS	PART NO.	SIZE	DESCRIPTION
6	Ring Set Single Cylinder	FP-RE507852	STD	Piston & rod bearing code 4811; 1-1/8, 1-3/32, 1-.136 (1 cyl. set)
6	Ring Set Single Cylinder	FP-RE66820	STD	Piston & rod bearing code 4811; 1-1/8, 1-3/32, 1-.136 (1 cyl. set)
<b>19 Industrial Applications 6068H PowerTech Eng. (2-Valve Cyl. Head)</b> 6.8L 413.8 (6784cc) OHV Turbo-Diesel L6 (PowerTech 2V IC), 106mm Bore				
<b>CYL. HEAD &amp; PARTS</b>				
QTY	GASKETS	PART NO.	SIZE	DESCRIPTION
1	Valve Cover Gasket	FP-R123543		
1	Head Gasket	FP-R116516		
1	Head Set	FP-RE66083		
QTY	VALVE	PART NO.	SIZE	DESCRIPTION
6	Intake	FP-R98062	STD	1 groove; Chrome plated stem; 1.8350" Head Dia., .3100" Stem Dia., 5.2780" O.A.L.
6	Intake	FP-R97490	15	1 groove; Chrome plated stem; 1.8350" Head Dia., .3250" Stem Dia., 5.2780" O.A.L.
6	Exhaust	FP-R90692	STD	1 groove; Chrome plated stem; 1.6730" Head Dia., .3095" Stem Dia., 5.2550" O.A.L.
6	Exhaust	FP-R97492	15	1 groove; Chrome plated stem; 1.6730" Head Dia., .3245" Stem Dia., 5.2550" O.A.L.
24	Keeper	FP-R91889		
QTY	VALVE SEAT	PART NO.	SIZE	DESCRIPTION
6	Exh.	FP-R85687	STD	
6	Int.	FP-R98335		.020" Dia. O/S face width; 1.8575" OD, 1.5500" ID, .2580" Depth
6	Int.	FP-R98063	STD	1.8575" OD, 1.5500" ID, .2580" Depth
QTY	VALVE SPRING	PART NO.	SIZE	DESCRIPTION
12	Spring	FP-R26125		2.1200" Free Height
QTY	VALVE MISC.	PART NO.	SIZE	DESCRIPTION
12	Rotocap	FP-RE60005		Exh. & Int.
QTY	VALVE SEAL	PART NO.	SIZE	DESCRIPTION
12	Valve Stem Seal	FP-RE31617		Exh. & Int.; From Ser. No. 300,000; Positive type
12	Valve Stem Seal	FP-R87627		Exh. & Int.; O-Ring type
<b>ELECTRICAL</b>				
QTY	ELECTRICAL	PART NO.	SIZE	DESCRIPTION
1	Starter to Block Gasket	FP-R53108		3-Hole mount; Starting motor codes 3003, 3006, 3010, 3011, 3013, 3025, 3026
<b>FUEL SYSTEM &amp; PARTS</b>				
QTY	FUEL INJECTION	PART NO.	SIZE	DESCRIPTION
6	Fuel Injector Nozzle	FP-RE48786		
6	Fuel Injector Seal	FP-R92352		Upper packing
6	Washer Type Seal	FP-R48000		Lower packing
12	Washer Type Seal	FP-R51936		Fuel line; Line codes 1613, 1614, 1615, 1619, 1621, 1622, 1623, 1668, 1678, 1680, 1681, 1685, 1686, 1688, 1697, 160D; To Ser. No. 715,739
12	Washer Type Seal	FP-R51936		Fuel line; Line codes 1619, 1681, 1685, 1686, 1696, 1697, 16CM, 16CN, 16CP, 16CW, 16CX, 16CY, 16DY, 16LS, 16LT, 16LU, 16MG, 16MH, 16ML, 16MM

(continued on next page)



*Industrial Applications* **6068H PowerTech Eng. (2-Valve Cyl. Head) 19**  
6.8L 413.8 (6784cc) OHV Turbo-Diesel L6 (PowerTech 2V IC), 106mm Bore (cont.)

<b>COOLING SYSTEM</b>				
<b>QTY</b>	<b>WATER PUMP</b>	<b>PART NO.</b>	<b>SIZE</b>	<b>DESCRIPTION</b>
1	Water Pump Filter	FP-R98527		w/Pump housing marked RE500734, RE70683, RE70985; High Flow
<b>ENGINE BLOCK &amp; PARTS</b>				
<b>QTY</b>	<b>GASKETS</b>	<b>PART NO.</b>	<b>SIZE</b>	<b>DESCRIPTION</b>
1	Oil Pan Gasket	FP-R123354		
2	O-Ring	FP-U13639		Block coolant drain plug seal; Coolant heater codes 2601, 2602; 1.475" X .118"
<b>QTY</b>	<b>CAM BEARINGS</b>	<b>PART NO.</b>	<b>SIZE</b>	<b>DESCRIPTION</b>
1	Cam Brg.	FP-R119874		
<b>CRANKSHAFT/OIL PUMP</b>				
<b>QTY</b>	<b>SEALS - REAR CRANK</b>	<b>PART NO.</b>	<b>SIZE</b>	<b>DESCRIPTION</b>
1	Crankshaft Rear Seal	FP-RE24959		
<b>QTY</b>	<b>MAIN BEARINGS</b>	<b>PART NO.</b>	<b>SIZE</b>	<b>DESCRIPTION</b>
6	Plain Main Brg.	FP-RE65165	STD	Crankshaft and Bearing codes 4702, 4703
6	Plain Main Brg.	FP-RE65911	.25MM	Crankshaft and Bearing codes 4702, 4703
1	Flanged Main Brg.	FP-RE65168	STD	Crankshaft and Bearing codes 4702, 4703
1	Flanged Main Brg.	FP-RE65912	.25MM	Crankshaft and Bearing codes 4702, 4703
<b>QTY</b>	<b>OIL PUMP</b>	<b>PART NO.</b>	<b>SIZE</b>	<b>DESCRIPTION</b>
1	O-Ring	FP-R61871		Oil tube from pump to block
<b>CYLINDER COMPONENTS</b>				
<b>QTY</b>	<b>LINERS</b>	<b>PART NO.</b>	<b>SIZE</b>	<b>DESCRIPTION</b>
6	Liner w/o Sealing Ring	FP-R121867	STD	
6	Liner w/Sealing Rings	FP-RE500024	STD	
6	Cylinder Kit Complete	FP-RE507850	STD	Con. Rod Bearing & Piston code 4810
6	Cylinder Kit Complete	FP-RE507920	STD	Con. Rod, Bearing & Piston codes 4807
6	Cyl. Liner Sealing Ring Kit	FP-AR65507		
<b>QTY</b>	<b>PISTONS</b>	<b>PART NO.</b>	<b>SIZE</b>	<b>DESCRIPTION</b>
6	Piston Body w/o Pin	FP-RE55512	STD	Con. Rod Bearing & Piston code 4810
6	Piston Body w/o Pin	FP-RE505100	STD	Con. Rod, Bearing & Piston codes 4807
6	Pin	FP-R123178		Con. Rod, Bearing & Piston code 4807; 1.375" pin dia.
6	Pin	FP-R123177		Con. Rod, Bearing & Piston codes 4810; 1.62" pin dia.
12	Piston Pin Retainer	FP-M41029		Con. Rod, Bearing & Piston codes 4805, 4807; For 1.38" pin dia.
12	Piston Pin Retainer	FP-R54114		Con. Rod, Bearing & Piston codes 4810; For 1.62" pin dia.
6	Pin Bushing	FP-R114082		Con. Rod, Bearing & Piston code 4810; w/Con. Rod marked R500335
6	Pin Bushing	FP-R123960		Con. Rod, Bearing & Piston codes 4807, 4810; 1.375" pin dia.
6	Piston Pin Kit	FP-RE63915		Con. Rod, Bearing & Piston codes 4810; Incl. Pin, Retainers & Bushing
<b>QTY</b>	<b>CONNECTING RODS &amp; BRGS.</b>	<b>PART NO.</b>	<b>SIZE</b>	<b>DESCRIPTION</b>
12	Con. Rod Bolt	FP-R114083		Cyl. Liner code 4807; w/Con. Rod marked R123959; To Ser. No. 794,054
12	Con. Rod Bolt	FP-R501124		Cyl. Liner code 4807; w/Con. Rod marked R500000; From Ser. No. 794,055
12	Con. Rod Bolt	FP-R114083		Cyl. Liner code 4810; w/Con. Rod marked R500335
12	Con. Rod Bolt	FP-R501124		Cyl. Liner code 4810; w/Con. Rod marked R500335
12	Con. Rod Bolt	FP-R501124		Cyl. Liner code 4810; w/Con. Rod marked R500335; From Ser. No. 794,055
12	Con. Rod Bolt	FP-R114083		Cyl. Liner codes 4807, 4810; w/Con. Rod marked R500000, R500335; From Ser. No. 794,055
6	Rod Pair	FP-RE65908	STD	Cyl. Liner codes 4807, 4810; w/Con. Rod marked R500000, R500335
6	Rod Pair	FP-RE65909	.25MM	Cyl. Liner codes 4807, 4810; w/Con. Rod marked R500000, R500335
<b>QTY</b>	<b>PISTON RINGS</b>	<b>PART NO.</b>	<b>SIZE</b>	<b>DESCRIPTION</b>
6	Ring Set Single Cylinder	FP-RE66271	STD	Piston & Liner code 4807
6	Ring Set Single Cylinder	FP-RE507852	STD	Piston & Liner code 4810; 1-1/8, 1-3/32, 1-.136 (1 cyl. set)
6	Ring Set Single Cylinder	FP-RE66820	STD	Piston & Liner code 4810; 1-1/8, 1-3/32, 1-.136 (1 cyl. set)
<b>KITS</b>				
<b>QTY</b>	<b>OVERHAUL KIT</b>	<b>PART NO.</b>	<b>SIZE</b>	<b>DESCRIPTION</b>
1	In-Frame Overhaul Kit	FP-IFKPT6068		Con. Rod, Bearing & Piston codes 4807

20 Industrial Applications 6068H PowerTech Eng. (4-Valve Cyl. Head) 6.8L 413.8 (6784cc) OHV Turbo-Diesel L6 (PowerTech 4V IC), 106mm Bore				
CYL. HEAD & PARTS				
QTY	GASKETS	PART NO.	SIZE	DESCRIPTION
1	Valve Cover Gasket	FP-R123543		
1	Head Gasket	FP-R116516		
1	Head Set	FP-RE66083		
QTY	VALVE	PART NO.	SIZE	DESCRIPTION
12	Intake	FP-R98062	STD	1 groove; Chrome plated stem; 1.8350" Head Dia., .3100" Stem Dia., 5.2780" O.A.L.
12	Intake	FP-R97490	15	1 groove; Chrome plated stem; 1.8350" Head Dia., .3250" Stem Dia., 5.2780" O.A.L.
12	Exhaust	FP-R90692	STD	1 groove; Chrome plated stem; 1.6730" Head Dia., .3095" Stem Dia., 5.2550" O.A.L.
12	Exhaust	FP-R97492	15	1 groove; Chrome plated stem; 1.6730" Head Dia., .3245" Stem Dia., 5.2550" O.A.L.
48	Keeper	FP-R91889		
QTY	VALVE SEAT	PART NO.	SIZE	DESCRIPTION
12	Exh.	FP-R85687	STD	
12	Int.	FP-R98335		.020" Dia. O/S face width; 1.8575" OD, 1.5500" ID, .2580" Depth
12	Int.	FP-R98063	STD	1.8575" OD, 1.5500" ID, .2580" Depth
QTY	VALVE SPRING	PART NO.	SIZE	DESCRIPTION
24	Spring	FP-R26125		Exh. & Int.; 2.1200" Free Height
QTY	VALVE MISC.	PART NO.	SIZE	DESCRIPTION
24	Rotocap	FP-RE60005		Exh. & Int.
QTY	VALVE SEAL	PART NO.	SIZE	DESCRIPTION
24	Valve Stem Seal	FP-RE31617		Exh. & Int.; Positive type
ELECTRICAL				
QTY	ELECTRICAL	PART NO.	SIZE	DESCRIPTION
1	Starter to Block Gasket	FP-R53108		3-Hole mount; Starting motor codes 3003, 3006, 3010, 3011, 3013, 3025, 3026
FUEL SYSTEM & PARTS				
QTY	FUEL INJECTION	PART NO.	SIZE	DESCRIPTION
6	Fuel Injector Nozzle	FP-RE48786		Do not use w/Stanadyne DE10 injector pump
6	Fuel Injector Seal	FP-R92352		Upper packing
6	Washer Type Seal	FP-R48000		Lower packing
COOLING SYSTEM				
QTY	WATER PUMP	PART NO.	SIZE	DESCRIPTION
1	Water Pump - Heavy Duty	FP-RE500737 *		Standard flow
1	Water Pump Filter	FP-R98527		w/Pump housing marked RE70683, RE70985
1	Water Pump Filter	FP-R98527		w/Pump housing marked R500734; High Flow
ENGINE BLOCK & PARTS				
QTY	GASKETS	PART NO.	SIZE	DESCRIPTION
1	Oil Pan Gasket	FP-R123354		
2	O-Ring	FP-U13639		Block coolant drain plug seal; Coolant heater codes 2601, 2602; 1.475" X .118"
QTY	GASKET SETS	PART NO.	SIZE	DESCRIPTION
1	In-Frame Gasket Set	FP-RE66085		
QTY	CAM BEARINGS	PART NO.	SIZE	DESCRIPTION
1	Cam Brg.	FP-R119874		
CRANKSHAFT/OIL PUMP				
QTY	SEALS - REAR CRANK	PART NO.	SIZE	DESCRIPTION
1	Crankshaft Rear Seal	FP-RE24959		
QTY	MAIN BEARINGS	PART NO.	SIZE	DESCRIPTION
6	Plain Main Brg.	FP-RE65165	STD	Crankshaft and Bearing codes 4702, 4703
6	Plain Main Brg.	FP-RE65911	.25MM	Crankshaft and Bearing codes 4702, 4703
1	Flanged Main Brg.	FP-RE65168	STD	Crankshaft and Bearing codes 4702, 4703
1	Flanged Main Brg.	FP-RE65912	.25MM	Crankshaft and Bearing codes 4702, 4703
QTY	OIL PUMP	PART NO.	SIZE	DESCRIPTION
1	O-Ring	FP-R61871		Oil tube from pump to block
CYLINDER COMPONENTS				
QTY	LINERS	PART NO.	SIZE	DESCRIPTION
6	Liner w/o Sealing Ring	FP-R121867	STD	
6	Liner w/Sealing Rings	FP-RE500024	STD	

(continued on next page)



**Industrial Applications 6068H PowerTech Eng. (4-Valve Cyl. Head) 20**  
6.8L 413.8 (6784cc) OHV Turbo-Diesel L6 (PowerTech 4V IC), 106mm Bore (cont.)

<b>CYLINDER COMPONENTS (cont.)</b>				
<b>QTY</b>	<b>LINERS (cont.)</b>	<b>PART NO.</b>	<b>SIZE</b>	<b>DESCRIPTION</b>
6	Cylinder Kit Complete	FP-RE507850	STD	
6	Cyl. Liner Sealing Ring Kit	FP-AR65507		
<b>QTY</b>	<b>PISTONS</b>	<b>PART NO.</b>	<b>SIZE</b>	<b>DESCRIPTION</b>
6	Piston Body w/o Pin	FP-RE55512	STD	
6	Pin	FP-R123177		Con. Rod, Bearing & Piston codes 4810; 1.62" pin dia.
12	Piston Pin Retainer	FP-R54114		Con. Rod, Bearing & Piston codes 4810; For 1.62" pin dia.
6	Pin Bushing	FP-R114082		Con. Rod, Bearing & Piston code 4810; w/Con. Rod marked R500335
6	Piston Pin Kit	FP-RE63915		Con. Rod, Bearing & Piston codes 4810; Incl. Pin, Retainers & Bushing
<b>QTY</b>	<b>CONNECTING RODS &amp; BRGS.</b>	<b>PART NO.</b>	<b>SIZE</b>	<b>DESCRIPTION</b>
12	Con. Rod Bolt	FP-R501124		Cyl. Liner code 4810; w/Con. Rod marked R500335; From Ser. No. 794,055; Fractured split rod
12	Con. Rod Bolt	FP-R114083		Machine split rod
6	Rod Pair	FP-RE65908	STD	Cyl. Liner codes 4807, 4810; w/Con. Rod marked R500000, R500335
6	Rod Pair	FP-RE65909	.25MM	Cyl. Liner codes 4807, 4810; w/Con. Rod marked R500000, R500335
<b>QTY</b>	<b>PISTON RINGS</b>	<b>PART NO.</b>	<b>SIZE</b>	<b>DESCRIPTION</b>
6	Ring Set Single Cylinder	FP-RE66820	STD	1-1/8, 1-3/32, 1-.136 (1 cyl. set)
<b>KITS</b>				
<b>QTY</b>	<b>OVERHAUL KIT</b>	<b>PART NO.</b>	<b>SIZE</b>	<b>DESCRIPTION</b>
1	In-Frame Overhaul Kit	FP-IFKPT6068		

**Industrial Applications 6068D Eng. 21**  
6.8L 413.8 (6784cc) OHV Diesel L6 (Litre Engine), 106mm Bore

<b>CYL. HEAD &amp; PARTS</b>				
<b>QTY</b>	<b>GASKETS</b>	<b>PART NO.</b>	<b>SIZE</b>	<b>DESCRIPTION</b>
1	Valve Cover Gasket	FP-R75728		Rocker cover codes 1102, 1103, 1104
1	Head Gasket	FP-R114157		Cyl. head code 5101
1	Head Set	FP-RE38852		Cyl. head code 5101
1	Oil Filler Cap Gasket	FP-T20328		Rocker arm cover codes 1103, 1104; Oil filler neck codes 1201, 1202, 1203
1	O-Ring	FP-R56463		Rocker cover breather tube; Breather tube codes 2902, 2905, 2909, 2912
<b>QTY</b>	<b>VALVE</b>	<b>PART NO.</b>	<b>SIZE</b>	<b>DESCRIPTION</b>
6	Intake	FP-R98062	STD	1 groove; Chrome plated stem; 1.8350" Head Dia., .3100" Stem Dia., 5.2780" O.A.L.
6	Intake	FP-R97490	15	1 groove; Chrome plated stem; 1.8350" Head Dia., .3250" Stem Dia., 5.2780" O.A.L.
6	Exhaust	FP-R90692	STD	1 groove; Chrome plated stem; 1.6730" Head Dia., .3095" Stem Dia., 5.2550" O.A.L.
6	Exhaust	FP-R97492	15	1 groove; Chrome plated stem; 1.6730" Head Dia., .3245" Stem Dia., 5.2550" O.A.L.
24	Keeper	FP-R91889		
<b>QTY</b>	<b>VALVE SEAT</b>	<b>PART NO.</b>	<b>SIZE</b>	<b>DESCRIPTION</b>
6	Exh.	FP-R85687	STD	
6	Int.	FP-R98335		.020" Dia. O/S face width; 1.8575" OD, 1.5500" ID, .2580" Depth
6	Int.	FP-R98063	STD	1.8575" OD, 1.5500" ID, .2580" Depth
<b>QTY</b>	<b>VALVE SPRING</b>	<b>PART NO.</b>	<b>SIZE</b>	<b>DESCRIPTION</b>
12	Spring	FP-R26125		2.1200" Free Height
<b>QTY</b>	<b>VALVE MISC.</b>	<b>PART NO.</b>	<b>SIZE</b>	<b>DESCRIPTION</b>
12	Rotocap	FP-RE60005		Exh. & Int.
<b>QTY</b>	<b>VALVE SEAL</b>	<b>PART NO.</b>	<b>SIZE</b>	<b>DESCRIPTION</b>
12	Valve Stem Seal	FP-RE31617		Exh. & Int.; From Ser. No. 300,000; Positive type
12	Valve Stem Seal	FP-R87627		Exh. & Int.; O-Ring type
<b>ELECTRICAL</b>				
<b>QTY</b>	<b>ELECTRICAL</b>	<b>PART NO.</b>	<b>SIZE</b>	<b>DESCRIPTION</b>
1	Starter to Block Gasket	FP-R53108		3-Hole mount; Starting motor codes 3002, 3007, 3011, 3013, 3015, 3016, 3017, 3018, 3019

(continued on next page)

<b>21 Industrial Applications 6068D Eng.</b>				
<b>(cont.) 6.8L 413.8 (6784cc) OHV Diesel L6 (Litre Engine), 106mm Bore</b>				
<b>INT &amp; EXH MANIFOLDS</b>				
QTY	INT. & EXH. MANIFOLDS	PART NO.	SIZE	DESCRIPTION
6	Exhaust Manifold Gasket	FP-R90658		
3	Air Intake Gasket	FP-R81275		
<b>CAMSHAFT GROUP</b>				
QTY	TIMING COVER	PART NO.	SIZE	DESCRIPTION
1	Timing Gear Cover Gasket	FP-R97454		Front cover
<b>FUEL SYSTEM &amp; PARTS</b>				
QTY	FUEL INJECTION	PART NO.	SIZE	DESCRIPTION
1	Injector Pump Gasket	FP-R125066		Gear cover
6	Fuel Injector Nozzle	FP-RE36939		w/Injector marked 28484
6	Fuel Injector Seal	FP-R79605		Fuel line connection; Nozzle codes 1622, 1623, 1642, 1643, 1654; Nozzle marked 28484; 9.270MM X 13.600MM X 5.080MM
6	Fuel Injector Nut	FP-R79604		w/Injector marked 28484
12	Washer Type Seal	FP-R51936		Leak-off & return line seals; Nozzle codes 1602, 1610, 1612, 1619
6	Washer Type Seal	FP-R48000		Lower; Use w/OEM nozzle RE38087
6	Washer Type Seal	FP-R60746		Upper; Use w/OEM nozzle RE38087
<b>COOLING SYSTEM</b>				
QTY	WATER PUMP	PART NO.	SIZE	DESCRIPTION
1	Water Pump Impeller	FP-R47191		w/Pump housing marked R66420, R68733
1	Water Pump Impeller	FP-R56812		w/Pump housing marked R80168, R90784, R104648, R120869
1	Water Pump Repair/Rebuild Kit	FP-RE19511		w/Pump housing marked R60601, R67741, R67748, R72644, R72748, R73322, R80168, R82787
1	Water Pump Repair/Rebuild Kit	FP-RE62661		w/Pump housing marked R66420, R68733
1	Water Pump Repair/Rebuild Kit	FP-RE70143		From Ser. No. 100,000 to Ser. No. 499,999; w/Cast iron impeller
2	Ball Brg.	FP-JD10329		Fan hub shaft bearing; w/Pump housing marked R120869, R80168
2	Ball Brg.	FP-JD7686		Front/Rear shaft bearing; Pump code 2025; w/Pump housing marked R80168, R120869; w/H/D water pump
1	Oil Seal Kit	FP-AR101549		Water Pump; w/Pump housing marked R80168, R90784, R120869
1	Water Pump Mounting Gasket	FP-T20243		w/Pump housing marked R80168, R90783, R90784, R120869
1	Oil Seal	FP-AR90860		Pump code 2025; w/H/D water pump; w/housing marked R80168, R120869
1	Shaft & Bearing Assembly	FP-JD8643		w/Pump housing marked R90784
QTY	THERMOSTAT	PART NO.	SIZE	DESCRIPTION
2	Thermostat	FP-AR48675		Thermostat codes 2204, 2209; Thermostat cover code 2102 Vertical, 2108 Horizontal; Housing code 3901; 180 Deg.
1	Thermostat Cover Gasket	FP-R54638		Thermostat cover codes 2102, 2104, 2108; Thermostat housing code 3901; w/Two thermostats
1	Therm. Hsg. - Water Mfld. Gsk	FP-R54641		Thermostat housing to cyl. head
2	O-Ring	FP-R56461		Thermostat housing tube seals; Housing codes 3901, 3905
<b>ENGINE BLOCK &amp; PARTS</b>				
QTY	GASKETS	PART NO.	SIZE	DESCRIPTION
1	Flywheel Housing Gasket	FP-R97351		
1	Oil Pan Gasket Set	FP-PG303PS		
2	O-Ring	FP-U13639		Block coolant drain plug seal; Coolant heater codes 2601, 2602; 1.475" X .118"
1	Block to End Plate Front Gskt	FP-R131794		Front plate codes 3601, 3602
QTY	GASKET SETS	PART NO.	SIZE	DESCRIPTION
1	In-Frame Gasket Set	FP-PG359S		
1	Complete Overhaul Gasket Set	FP-RE38555		Crankshaft seals not incl.
QTY	CAM BEARINGS	PART NO.	SIZE	DESCRIPTION
1	Cam Brg.	FP-R119874		From Ser. No. 100,000 to Ser. No. 499,999
QTY	OIL COOLERS & FILTERS	PART NO.	SIZE	DESCRIPTION
1	Oil Cooler Gasket	FP-R98485		Bottom cover; Cooler code 5911
1	Oil Cooler Gasket	FP-R27948		Oil cooler core
1	Oil Cooler Gasket	FP-R98484		Top cover; Cooler code 5911
1	Rect. or Square Seal	FP-R70956		Cooler housing; Cooler code 5904; Ten plates; 2.700" X 3.000" X .180"
1	Oil Cooler to Block Gasket	FP-R98489		
1	Oil Cooler Adapter Cover Gskt	FP-R114097		Filter adapter code 5904; From Ser. No. 100,000 to Ser. No. 499,999

(continued on next page)



*Industrial Applications 6068D Eng. 21*  
6.8L 413.8 (6784cc) OHV Diesel L6 (Litre Engine), 106mm Bore (cont.)

<b>CRANKSHAFT/OIL PUMP</b>					
<b>QTY</b>	<b>CRANKSHAFT</b>	<b>PART NO.</b>	<b>SIZE</b>	<b>DESCRIPTION</b>	
1	Crankshaft	FP-RE45517		Incl. front & rear seals; Crankshaft code 4701; Crankshaft marked R104523, R121027	
1	Oil Seal Kit	FP-SK67942			
<b>QTY</b>	<b>SEALS - FRONT CRANK</b>	<b>PART NO.</b>	<b>SIZE</b>	<b>DESCRIPTION</b>	
1	Crankshaft Front Seal	FP-AR67942		Crankshaft code 4701; Crankshaft marked R104523, R121027 Crankshaft pulley; Pulley codes 1303, 1308; Crankshaft, Bearing code 4701; Crankshaft marked R104523, R121027	
1	O-Ring	FP-H35244			
<b>QTY</b>	<b>SEALS - REAR CRANK</b>	<b>PART NO.</b>	<b>SIZE</b>	<b>DESCRIPTION</b>	
1	Crankshaft Rear Seal	FP-RE24959		Crankshaft code 4701; Crankshaft marked R104523, R121027	
<b>QTY</b>	<b>MAIN BEARINGS</b>	<b>PART NO.</b>	<b>SIZE</b>	<b>DESCRIPTION</b>	
1	Main Set	FP-MBK3006	STD	w/Flangeless thrust brg. w/Flangeless thrust brg. w/Flangeless thrust brg. w/Flangeless thrust brg. Use w/Flangeless thrust brg.	
1	Main Set	FP-MBK300610	10		
1	Main Set	FP-MBK300620	20		
1	Main Set	FP-MBK300630	30		
6	Plain Main Brg.	FP-RE27352	STD		
6	Plain Main Brg.	FP-RE27353	10		
6	Plain Main Brg.	FP-RE27360	20		
6	Plain Main Brg.	FP-RE27368	30		
1	Flanged Main Brg.	FP-RE521350	STD		
1	Flanged Main Brg.	FP-RE526754	10		
1	Flanged Main Brg.	FP-RE527235	20		
1	Flanged Main Brg.	FP-RE527236	30		
4	Thrust Washer	FP-R78598	STD		
<b>QTY</b>	<b>OIL PUMP</b>	<b>PART NO.</b>	<b>SIZE</b>		<b>DESCRIPTION</b>
1	O-Ring	FP-R61871			Oil pump inlet; H/D Pump code 5003
1	O-Ring	FP-R61871			Oil pump inlet; Pump codes 5001, 5002, 5005; w/Pump housing marked R54615; From Ser. No. 427,376
2	O-Ring	FP-R80632		Oil Pump outlet tube	
1	Oil Filler Inlet Gasket	FP-R97352		Oil filler neck codes 1201, 1202, 1203, 1299	
1	Oil Filter Adapter Gasket	FP-R98488		w/Filter adapter marked R56189, R91597, R113646, R131238	
1	Oil Pump Seal Ring	FP-R79563		Oil pump outlet adapter; Pump codes 5001, 5002, 5003, 5004; w/Pump marked R54629	
<b>CYLINDER COMPONENTS</b>					
<b>QTY</b>	<b>LINERS</b>	<b>PART NO.</b>	<b>SIZE</b>	<b>DESCRIPTION</b>	
6	Liner w/o Sealing Ring	FP-R121867	STD	1.62" pin dia.	
6	Liner w/Sealing Rings	FP-RE500024	STD		
6	Cylinder Kit Complete	FP-RE28966	STD		
6	Cyl. Liner Sealing Ring Kit	FP-AR65507			
6	Sealing Ring, Liner	FP-R48767			Hi-Ring; Rectangle; Top
6	Sealing Ring, Liner	FP-R26121			Round; Middle
6	Sealing Ring	FP-SLR2520		Round; Bottom	
<b>QTY</b>	<b>PISTONS</b>	<b>PART NO.</b>	<b>SIZE</b>	<b>DESCRIPTION</b>	
6	Piston Body w/o Pin	FP-RE28919	STD	Hi-Ring; 1.62" Pin dia.	
6	Piston Kit w/Pin & Retainers	FP-RE28919WP		Hi-Ring	
6	Pin	FP-R124230		Hi-Ring; 1.62" pin dia.	
12	Piston Pin Retainer	FP-R54114		Hi-Ring; For 1.62" pin dia.	
6	Pin Bushing	FP-R57451		w/Con. Rod marked R56187, R58979, R80032, R113612; Pin dia. 1.62"; 1.621" ID, 1.813" OD, 1.370" O.A.L.	
<b>QTY</b>	<b>CONNECTING RODS &amp; BRGS.</b>	<b>PART NO.</b>	<b>SIZE</b>	<b>DESCRIPTION</b>	
12	Con. Rod Bolt	FP-R74195		w/Con. Rod marked R54617, R56187, R116851; Torque-To-Yield bolt; Replacement recommended	
6	Rod Pair	FP-AR97517	STD		
6	Rod Pair	FP-AR97653	10		
6	Rod Pair	FP-AR97654	20		
6	Rod Pair	FP-AR97655	30		
<b>QTY</b>	<b>PISTON RINGS</b>	<b>PART NO.</b>	<b>SIZE</b>	<b>DESCRIPTION</b>	
6	Ring Set Single Cylinder	FP-RE507852	STD	Exc. Hi-Ring; 1-1/8, 1-3/32, 1-.136 (1 cyl. set)	
6	Ring Set Single Cylinder	FP-RE66820	STD	Exc. Hi-Ring; 1-1/8, 1-3/32, 1-.136 (1 cyl. set)	
<b>KITS</b>					
<b>QTY</b>	<b>OVERHAUL KIT</b>	<b>PART NO.</b>	<b>SIZE</b>	<b>DESCRIPTION</b>	
1	In-Frame Overhaul Kit	FP-6068DIFK		w/Con. Rod marked R54617, R56187, R116851; w/Flangeless thrust brg.; Incl. Torque-To-Yield con. rod bolts	

(continued on next page)

<b>21 Industrial Applications 6068D Eng.</b>				
(cont.) 6.8L 413.8 (6784cc) OHV Diesel L6 (Litre Engine), 106mm Bore				
<b>KITS (cont.)</b>				
QTY	OVERHAUL KIT (cont.)	PART NO.	SIZE	DESCRIPTION
1	Complete Overhaul Kit	FP-6068DOHK		From Ser. No. 100,000 to Ser. No. 499,999; w/Con. Rod marked R56187; Piston pin dia. 1.62"; w/Flangeless thrust brg.; Incl. front & rear seals; Crankshaft code 4701; Crankshaft marked R104523, R121027; Incl. Torque-To-Yield con. rod bolts
<b>22 Industrial Applications 6068D PowerTech Eng.</b>				
6.8L 413.8 (6784cc) OHV Diesel L6 (PowerTech 2V), 106mm Bore				
<b>CYL. HEAD &amp; PARTS</b>				
QTY	GASKETS	PART NO.	SIZE	DESCRIPTION
1	Valve Cover Gasket	FP-R123543		
1	Head Gasket	FP-R116516		
1	Head Set	FP-RE66083		
QTY	VALVE	PART NO.	SIZE	DESCRIPTION
6	Intake	FP-R98062	STD	1 groove; Chrome plated stem; 1.8350" Head Dia., .3100" Stem Dia., 5.2780" O.A.L.
6	Intake	FP-R97490	15	1 groove; Chrome plated stem; 1.8350" Head Dia., .3250" Stem Dia., 5.2780" O.A.L.
6	Exhaust	FP-R90692	STD	1 groove; Chrome plated stem; 1.6730" Head Dia., .3095" Stem Dia., 5.2550" O.A.L.
6	Exhaust	FP-R97492	15	1 groove; Chrome plated stem; 1.6730" Head Dia., .3245" Stem Dia., 5.2550" O.A.L.
24	Keeper	FP-R91889		
QTY	VALVE SEAT	PART NO.	SIZE	DESCRIPTION
6	Exh.	FP-R85687	STD	
6	Int.	FP-R98335		.020" Dia. O/S face width; 1.8575" OD, 1.5500" ID, .2580" Depth
6	Int.	FP-R98063	STD	1.8575" OD, 1.5500" ID, .2580" Depth
QTY	VALVE SPRING	PART NO.	SIZE	DESCRIPTION
12	Spring	FP-R26125		2.1200" Free Height
QTY	VALVE MISC.	PART NO.	SIZE	DESCRIPTION
12	Rotocap	FP-RE60005		Exh. & Int.
QTY	VALVE SEAL	PART NO.	SIZE	DESCRIPTION
12	Valve Stem Seal	FP-RE31617		Exh. & Int.; From Ser. No. 300,000; Positive type
12	Valve Stem Seal	FP-R87627		Exh. & Int.; O-Ring type
<b>ELECTRICAL</b>				
QTY	ELECTRICAL	PART NO.	SIZE	DESCRIPTION
1	Starter to Block Gasket	FP-R53108		3-Hole mount; Starting motor codes 3003, 3006, 3010, 3011, 3013, 3025, 3026
<b>FUEL SYSTEM &amp; PARTS</b>				
QTY	FUEL INJECTION	PART NO.	SIZE	DESCRIPTION
6	Fuel Injector Seal	FP-R92352		Upper packing
6	Washer Type Seal	FP-R48000		Lower packing
11	Washer Type Seal	FP-R51936		Fuel line; Line code 16LR; From Ser. No. 707,096
11	Washer Type Seal	FP-R51936		Fuel line; Line codes 1613, 1614, 1615, 1622, 1623, 1668, 1678, 1686, 1696
<b>COOLING SYSTEM</b>				
QTY	WATER PUMP	PART NO.	SIZE	DESCRIPTION
1	Water Pump - Heavy Duty	FP-RE500737 *		Standard flow
1	Water Pump Filter	FP-R98527		w/Pump housing marked RE70683, RE70985
QTY	THERMOSTAT	PART NO.	SIZE	DESCRIPTION
1	Thermostat	FP-RE33705		w/Housing marked T19651, T20218, R60256, R127777; 180 Deg.
<b>ENGINE BLOCK &amp; PARTS</b>				
QTY	GASKETS	PART NO.	SIZE	DESCRIPTION
1	Oil Pan Gasket	FP-R123354		
2	O-Ring	FP-U13639		Block coolant drain plug seal; Coolant heater codes 2601, 2602; 1.475" X .118"
QTY	CAM BEARINGS	PART NO.	SIZE	DESCRIPTION
1	Cam Brg.	FP-R119874		

(continued on next page)





*Industrial Applications 6068D PowerTech Eng. 22*  
6.8L 413.8 (6784cc) OHV Diesel L6 (PowerTech 2V), 106mm Bore (cont.)

<b>CRANKSHAFT/OIL PUMP</b>				
QTY	SEALS - REAR CRANK	PART NO.	SIZE	DESCRIPTION
1	Crankshaft Rear Seal	FP-RE24959		
QTY	MAIN BEARINGS	PART NO.	SIZE	DESCRIPTION
6	Plain Main Brg.	FP-RE65165	STD	Crankshaft and Bearing code 4702
6	Plain Main Brg.	FP-RE65911	.25MM	Crankshaft and Bearing code 4702
1	Flanged Main Brg.	FP-RE65168	STD	Crankshaft and Bearing code 4702
1	Flanged Main Brg.	FP-RE65912	.25MM	Crankshaft and Bearing code 4702
QTY	OIL PUMP	PART NO.	SIZE	DESCRIPTION
1	O-Ring	FP-R61871		Oil tube from pump to block
<b>CYLINDER COMPONENTS</b>				
QTY	LINERS	PART NO.	SIZE	DESCRIPTION
6	Liner w/o Sealing Ring	FP-R121867	STD	
6	Liner w/Sealing Rings	FP-RE500024	STD	
6	Cylinder Kit Complete	FP-RE65966	STD	
6	Cyl. Liner Sealing Ring Kit	FP-AR65507		
QTY	PISTONS	PART NO.	SIZE	DESCRIPTION
6	Piston Body w/o Pin	FP-RE505101	STD	Con. Rod, Bearing & Piston code 4805
6	Pin	FP-R123178		Con. Rod, Bearing & Piston code 4805; 1.375" pin dia.
12	Piston Pin Retainer	FP-M41029		Con. Rod, Bearing & Piston code 4805; For 1.38" pin dia.
6	Pin Bushing	FP-R123960		Con. Rod, Bearing & Piston code 4805; 1.375" pin dia.
6	Pin Bushing	FP-R114082		Con. Rod, Bearing & Piston code 4810; w/Con. Rod marked R500335
QTY	CONNECTING RODS & BRGS.	PART NO.	SIZE	DESCRIPTION
6	Rod Pair	FP-RE65908	STD	Con. Rod, Bearing & Piston code 4805; w/Con. Rod marked R123959, R500000
6	Rod Pair	FP-RE65909	.25MM	Con. Rod, Bearing & Piston code 4805; w/Con. Rod marked R123959, R500000
QTY	PISTON RINGS	PART NO.	SIZE	DESCRIPTION
6	Ring Set Single Cylinder	FP-RE66271	STD	
<b>KITS</b>				
QTY	OVERHAUL KIT	PART NO.	SIZE	DESCRIPTION
1	In-Frame Overhaul Kit	FP-IFKPT6068		
<i>Industrial Applications 6068N PowerTech Eng. (Natural Gas) 23</i> 6.8L 413.8 (6784cc) OHV NG L6 (PowerTech 2V), 106mm Bore				
<b>CYL. HEAD &amp; PARTS</b>				
QTY	GASKETS	PART NO.	SIZE	DESCRIPTION
1	Valve Cover Gasket	FP-R123543		
1	Head Gasket	FP-R116516		
QTY	VALVE	PART NO.	SIZE	DESCRIPTION
24	Keeper	FP-R91889		Head & valve code 5113
QTY	VALVE SPRING	PART NO.	SIZE	DESCRIPTION
12	Spring	FP-R26125		Head & valve code 5113; 2.1200" Free Height
QTY	VALVE MISC.	PART NO.	SIZE	DESCRIPTION
12	Rotocap	FP-RE60005		Exh. & Int.; Head & valve code 5113
<b>INT &amp; EXH MANIFOLDS</b>				
QTY	INT. & EXH. MANIFOLDS	PART NO.	SIZE	DESCRIPTION
6	Exhaust Manifold Gasket	FP-R90658		Exh. manifold, shield code 2817
<b>COOLING SYSTEM</b>				
QTY	WATER PUMP	PART NO.	SIZE	DESCRIPTION
1	Water Pump Filter	FP-R98527		Water pump code 4404; Pump marked R500401
QTY	THERMOSTAT	PART NO.	SIZE	DESCRIPTION
1	Thermostat	FP-AR72852		Thermostat code 2203; 192 Deg.
1	O-Ring	FP-R26286		Sensor seal; Thermostat codes 2108, 2203
<b>ENGINE BLOCK &amp; PARTS</b>				
QTY	GASKETS	PART NO.	SIZE	DESCRIPTION
2	O-Ring	FP-U13639		Block coolant drain plug seal; Block code 4604; 1.475" X .118"
QTY	CAM BEARINGS	PART NO.	SIZE	DESCRIPTION
1	Cam Brg.	FP-R119874		Block code 4604

(continued on next page)

<b>23 Industrial Applications 6068N PowerTech Eng. (Natural Gas)</b> (cont.) 6.8L 413.8 (6784cc) OHV NG L6 (PowerTech 2V), 106mm Bore				
<b>CRANKSHAFT/OIL PUMP</b>				
QTY	MAIN BEARINGS	PART NO.	SIZE	DESCRIPTION
6	Plain Main Brg.	FP-RE65165	STD	Crankshaft and Bearing code 4702; w/Crankshaft marked R116076
6	Plain Main Brg.	FP-RE65911	.25MM	Crankshaft and Bearing code 4702; w/Crankshaft marked R116076
1	Flanged Main Brg.	FP-RE65168	STD	Crankshaft and Bearing code 4702; w/Crankshaft marked R116076
1	Flanged Main Brg.	FP-RE65912	.25MM	Crankshaft and Bearing code 4702; w/Crankshaft marked R116076
QTY	OIL PUMP	PART NO.	SIZE	DESCRIPTION
1	O-Ring	FP-R61871		Oil pump code 5001; Oil pump inlet seal
1	O-Ring	FP-R72328		Vent tube elbow seal; Rocker arm cover code 1104
<b>CYLINDER COMPONENTS</b>				
QTY	LINERS	PART NO.	SIZE	DESCRIPTION
6	Cyl. Liner Sealing Ring Kit	FP-AR65507		Piston & rod bearing code 4811
QTY	PISTONS	PART NO.	SIZE	DESCRIPTION
6	Pin	FP-R123177		Piston & rod bearing code 4811; 1.62" pin dia.
12	Piston Pin Retainer	FP-R54114		Piston & rod bearing code 4811; For 1.62" pin dia.
6	Pin Bushing	FP-R114082		Use w/Con. Rod marked R500335
6	Piston Pin Kit	FP-RE63915		Piston & rod bearing code 4811; Incl. Pin, Retainers & Bushing
QTY	CONNECTING RODS & BRGS.	PART NO.	SIZE	DESCRIPTION
12	Con. Rod Bolt	FP-R501124		Use w/Con. Rod marked R500335
6	Rod Pair	FP-RE65908	STD	Piston & rod bearing code 4811
6	Rod Pair	FP-RE65909	.25MM	Piston & Rod bearing code 4811
QTY	PISTON RINGS	PART NO.	SIZE	DESCRIPTION
6	Ring Set Single Cylinder	FP-RE507852	STD	Piston & rod bearing code 4811; 1-1/8, 1-3/32, 1-.136 (1 cyl. set)
6	Ring Set Single Cylinder	FP-RE66820	STD	Piston & rod bearing code 4811; 1-1/8, 1-3/32, 1-.136 (1 cyl. set)
<b>24 Industrial Applications 6068TN PowerTech Eng. (Natural Gas)</b> 6.8L 413.8 (6784cc) OHV Turbo-NG L6 (PowerTech 2V), 106mm Bore				
<b>CYL. HEAD &amp; PARTS</b>				
QTY	GASKETS	PART NO.	SIZE	DESCRIPTION
1	Valve Cover Gasket	FP-R123543		
1	Head Gasket	FP-R116516		
QTY	VALVE	PART NO.	SIZE	DESCRIPTION
24	Keeper	FP-R91889		Head & valve code 5113
QTY	VALVE SPRING	PART NO.	SIZE	DESCRIPTION
12	Spring	FP-R26125		Head & valve code 5113; 2.1200" Free Height
QTY	VALVE MISC.	PART NO.	SIZE	DESCRIPTION
12	Rotocap	FP-RE60005		Exh. & Int.; Head & valve code 5113
<b>INT &amp; EXH MANIFOLDS</b>				
QTY	INT. & EXH. MANIFOLDS	PART NO.	SIZE	DESCRIPTION
6	Exhaust Manifold Gasket	FP-R90658		Exh. manifold, shield code 2817
<b>FUEL SYSTEM &amp; PARTS</b>				
QTY	TURBOCHARGER	PART NO.	SIZE	DESCRIPTION
1	O-Ring	FP-R80632		Turbo oil line code 6529; Oil inlet adapter seal
<b>COOLING SYSTEM</b>				
QTY	WATER PUMP	PART NO.	SIZE	DESCRIPTION
1	Water Pump Filter	FP-R98527		Water pump code 4404; Pump marked R500401
QTY	THERMOSTAT	PART NO.	SIZE	DESCRIPTION
1	Thermostat	FP-AR72852		Thermostat code 2203; 192 Deg.
1	O-Ring	FP-R26286		Sensor seal; Thermostat codes 2108, 2203
<b>ENGINE BLOCK &amp; PARTS</b>				
QTY	GASKETS	PART NO.	SIZE	DESCRIPTION
2	O-Ring	FP-U13639		Block coolant drain plug seal; Block code 4604; 1.475" X .118"
QTY	CAM BEARINGS	PART NO.	SIZE	DESCRIPTION
1	Cam Brg.	FP-R119874		Block code 4604

(continued on next page)



**Industrial Applications 6068TN PowerTech Eng. (Natural Gas) 24**  
6.8L 413.8 (6784cc) OHV Turbo-NG L6 (PowerTech 2V), 106mm Bore (cont.)

<b>CRANKSHAFT/OIL PUMP</b>				
<b>QTY</b>	<b>MAIN BEARINGS</b>	<b>PART NO.</b>	<b>SIZE</b>	<b>DESCRIPTION</b>
6	Plain Main Brg.	FP-RE65165	STD	Crankshaft and Bearing codes 4702, 4703; w/Crankshaft marked R116076
6	Plain Main Brg.	FP-RE65911	.25MM	Crankshaft and Bearing codes 4702, 4703; w/Crankshaft marked R116076
1	Flanged Main Brg.	FP-RE65168	STD	Crankshaft and Bearing codes 4702, 4703; w/Crankshaft marked R116076
1	Flanged Main Brg.	FP-RE65912	.25MM	Crankshaft and Bearing codes 4702, 4703; w/Crankshaft marked R116076
<b>QTY</b>	<b>OIL PUMP</b>	<b>PART NO.</b>	<b>SIZE</b>	<b>DESCRIPTION</b>
1	O-Ring	FP-R61871		Oil pump code 5001; Oil pump inlet seal
1	O-Ring	FP-R72328		Vent tube elbow seal; Rocker arm cover code 1104
<b>CYLINDER COMPONENTS</b>				
<b>QTY</b>	<b>LINERS</b>	<b>PART NO.</b>	<b>SIZE</b>	<b>DESCRIPTION</b>
6	Cyl. Liner Sealing Ring Kit	FP-AR65507		Piston & rod bearing code 4811
<b>QTY</b>	<b>PISTONS</b>	<b>PART NO.</b>	<b>SIZE</b>	<b>DESCRIPTION</b>
6	Pin	FP-R123177		Piston & rod bearing code 4811; 1.62" pin dia.
12	Piston Pin Retainer	FP-R54114		Piston & rod bearing code 4811; For 1.62" pin dia.
6	Pin Bushing	FP-R114082		Use w/Con. Rod marked R500335
6	Piston Pin Kit	FP-RE63915		Piston & rod bearing code 4811; Incl. Pin, Retainers & Bushing
<b>QTY</b>	<b>CONNECTING RODS &amp; BRGS.</b>	<b>PART NO.</b>	<b>SIZE</b>	<b>DESCRIPTION</b>
12	Con. Rod Bolt	FP-R501124		Use w/Con. Rod marked R500335
6	Rod Pair	FP-RE65908	STD	Piston & rod bearing code 4811
6	Rod Pair	FP-RE65909	.25MM	Piston & rod bearing code 4811
<b>QTY</b>	<b>PISTON RINGS</b>	<b>PART NO.</b>	<b>SIZE</b>	<b>DESCRIPTION</b>
6	Ring Set Single Cylinder	FP-RE507852	STD	Piston & rod bearing code 4811; 1-1/8, 1-3/32, 1-.136 (1 cyl. set)
6	Ring Set Single Cylinder	FP-RE66820	STD	Piston & rod bearing code 4811; 1-1/8, 1-3/32, 1-.136 (1 cyl. set)

**Industrial Applications 6068T PowerTech Eng. 25**  
6.8L 413.8 (6784cc) OHV Turbo-Diesel L6 (PowerTech 2V), 106mm Bore

<b>CYL. HEAD &amp; PARTS</b>				
<b>QTY</b>	<b>GASKETS</b>	<b>PART NO.</b>	<b>SIZE</b>	<b>DESCRIPTION</b>
1	Valve Cover Gasket	FP-R123543		
1	Head Gasket	FP-R116516		
1	Head Set	FP-RE66083		
<b>QTY</b>	<b>VALVE</b>	<b>PART NO.</b>	<b>SIZE</b>	<b>DESCRIPTION</b>
6	Intake	FP-R98062	STD	1 groove; Chrome plated stem; 1.8350" Head Dia., .3100" Stem Dia., 5.2780" O.A.L.
6	Intake	FP-R97490	15	1 groove; Chrome plated stem; 1.8350" Head Dia., .3250" Stem Dia., 5.2780" O.A.L.
6	Exhaust	FP-R90692	STD	1 groove; Chrome plated stem; 1.6730" Head Dia., .3095" Stem Dia., 5.2550" O.A.L.
6	Exhaust	FP-R97492	15	1 groove; Chrome plated stem; 1.6730" Head Dia., .3245" Stem Dia., 5.2550" O.A.L.
24	Keeper	FP-R91889		
<b>QTY</b>	<b>VALVE SEAT</b>	<b>PART NO.</b>	<b>SIZE</b>	<b>DESCRIPTION</b>
6	Exh.	FP-R85687	STD	
6	Int.	FP-R98335		.020" Dia. O/S face width; 1.8575" OD, 1.5500" ID, .2580" Depth
6	Int.	FP-R98063	STD	1.8575" OD, 1.5500" ID, .2580" Depth
<b>QTY</b>	<b>VALVE SPRING</b>	<b>PART NO.</b>	<b>SIZE</b>	<b>DESCRIPTION</b>
12	Spring	FP-R26125		2.1200" Free Height
<b>QTY</b>	<b>VALVE MISC.</b>	<b>PART NO.</b>	<b>SIZE</b>	<b>DESCRIPTION</b>
12	Rotocap	FP-RE60005		Exh. & Int.
<b>QTY</b>	<b>VALVE SEAL</b>	<b>PART NO.</b>	<b>SIZE</b>	<b>DESCRIPTION</b>
12	Valve Stem Seal	FP-RE31617		Exh. & Int.; From Ser. No. 300,000; Positive type
12	Valve Stem Seal	FP-R87627		Exh. & Int.; O-Ring type
<b>ELECTRICAL</b>				
<b>QTY</b>	<b>ELECTRICAL</b>	<b>PART NO.</b>	<b>SIZE</b>	<b>DESCRIPTION</b>
1	Starter to Block Gasket	FP-R53108		3-Hole mount; Starting motor codes 3003, 3006, 3010, 3011, 3013, 3025, 3026

(continued on next page)

**25 Industrial Applications 6068T PowerTech Eng.**  
 (cont.) 6.8L 413.8 (6784cc) OHV Turbo-Diesel L6 (PowerTech 2V), 106mm Bore

FUEL SYSTEM & PARTS				
QTY	FUEL INJECTION	PART NO.	SIZE	DESCRIPTION
6	Fuel Injector Nozzle	FP-RE48786		
6	Fuel Injector Seal	FP-R92352		Upper packing
6	Washer Type Seal	FP-R48000		Lower packing
12	Washer Type Seal	FP-R51936		Fuel line; Line codes 1613, 1614, 1615, 1619, 1621, 1622, 1623, 1668, 1678, 1680, 1681, 1685, 1686, 1688, 1697, 160D; To Ser. No. 715,739
12	Washer Type Seal	FP-R51936		Fuel line; Line codes 1619, 1681, 1685, 1686, 1696, 1697, 16CM, 16CN, 16CP, 16CW, 16CX, 16CY, 16DY, 16LS, 16LT, 16LU, 16MG, 16MH, 16ML, 16MM
COOLING SYSTEM				
QTY	WATER PUMP	PART NO.	SIZE	DESCRIPTION
1	Water Pump - Heavy Duty	FP-RE500737 *		Standard flow
1	Water Pump Filter	FP-R98527		w/Pump housing marked RE70683, RE70985
ENGINE BLOCK & PARTS				
QTY	GASKETS	PART NO.	SIZE	DESCRIPTION
2	O-Ring	FP-U13639		Block coolant drain plug seal; Coolant heater codes 2601, 2602; 1.475" X .118"
QTY	CAM BEARINGS	PART NO.	SIZE	DESCRIPTION
1	Cam Brg.	FP-R119874		
CRANKSHAFT/OIL PUMP				
QTY	SEALS - REAR CRANK	PART NO.	SIZE	DESCRIPTION
1	Crankshaft Rear Seal	FP-RE24959		
QTY	MAIN BEARINGS	PART NO.	SIZE	DESCRIPTION
6	Plain Main Brg.	FP-RE65165	STD	Crankshaft and Bearing codes 4702, 4703
6	Plain Main Brg.	FP-RE65911	.25MM	Crankshaft and Bearing codes 4702, 4703
1	Flanged Main Brg.	FP-RE65168	STD	Crankshaft and Bearing codes 4702, 4703
1	Flanged Main Brg.	FP-RE65912	.25MM	Crankshaft and Bearing codes 4702, 4703
QTY	OIL PUMP	PART NO.	SIZE	DESCRIPTION
1	O-Ring	FP-R61871		Oil tube from pump to block
CYLINDER COMPONENTS				
QTY	LINERS	PART NO.	SIZE	DESCRIPTION
6	Liner w/o Sealing Ring	FP-R121867	STD	
6	Liner w/Sealing Rings	FP-RE500024	STD	
6	Cylinder Kit Complete	FP-RE507850	STD	Con. Rod Bearing & Piston code 4810
6	Cylinder Kit Complete	FP-RE507920	STD	Con. Rod, Bearing & Piston codes 4807
6	Cyl. Liner Sealing Ring Kit	FP-AR65507		
QTY	PISTONS	PART NO.	SIZE	DESCRIPTION
6	Piston Body w/o Pin	FP-RE55512	STD	Con. Rod Bearing & Piston code 4810
6	Piston Body w/o Pin	FP-RE505100	STD	Con. Rod, Bearing & Piston codes 4807
6	Pin	FP-R123178		Con. Rod, Bearing & Piston code 4807; 1.375" pin dia.
6	Pin	FP-R123177		Con. Rod, Bearing & Piston codes 4810; 1.62" pin dia.
12	Piston Pin Retainer	FP-M41029		Con. Rod, Bearing & Piston codes 4805, 4807; For 1.38" pin dia.
12	Piston Pin Retainer	FP-R54114		Con. Rod, Bearing & Piston codes 4810; For 1.62" pin dia.
6	Pin Bushing	FP-R114082		Con. Rod, Bearing & Piston code 4810; w/Con. Rod marked R500335
6	Pin Bushing	FP-R123960		Con. Rod, Bearing & Piston codes 4807, 4810; w/Con. Rod marked R500000, R123959; 1.375" pin dia.
6	Piston Pin Kit	FP-RE63915		Con. Rod, Bearing & Piston codes 4810; Incl. Pin, Retainers & Bushing
QTY	CONNECTING RODS & BRGS.	PART NO.	SIZE	DESCRIPTION
12	Con. Rod Bolt	FP-R114083		Cyl. Liner code 4807; w/Con. Rod marked R123959; To Ser. No. 794,054
12	Con. Rod Bolt	FP-R501124		Cyl. Liner code 4807,4810; w/Con. Rod marked R500000, R500335; From Ser. No. 794,055
12	Con. Rod Bolt	FP-R114083		Cyl. Liner codes 4807, 4810; w/Con. Rod marked R500000, R500335; From Ser. No. 794,055
6	Rod Pair	FP-RE65908	STD	Cyl. Liner codes 4807, 4810; w/Con. Rod marked R500000, R500335
6	Rod Pair	FP-RE65909	.25MM	Cyl. Liner codes 4807, 4810; w/Con. Rod marked R500000, R500335
QTY	PISTON RINGS	PART NO.	SIZE	DESCRIPTION
6	Ring Set Single Cylinder	FP-RE66271	STD	Piston & Liner code 4807
6	Ring Set Single Cylinder	FP-RE507852	STD	Piston & Liner code 4810; 1-1/8, 1-3/32, 1-.136 (1 cyl. set)

(continued on next page)



*Industrial Applications 6068T PowerTech Eng. 25*  
6.8L 413.8 (6784cc) OHV Turbo-Diesel L6 (PowerTech 2V), 106mm Bore (cont.)

<b>CYLINDER COMPONENTS (cont.)</b>				
<b>QTY</b>	<b>PISTON RINGS (cont.)</b>	<b>PART NO.</b>	<b>SIZE</b>	<b>DESCRIPTION</b>
6	Ring Set Single Cylinder	FP-RE66820	STD	Piston & Liner code 4810; 1-1/8, 1-3/32, 1-.136 (1 cyl. set)
<b>KITS</b>				
<b>QTY</b>	<b>OVERHAUL KIT</b>	<b>PART NO.</b>	<b>SIZE</b>	<b>DESCRIPTION</b>
1	In-Frame Overhaul Kit	FP-IFKPT6068		Con. Rod, Bearing & Piston codes 4807

*Industrial Applications 6414D Eng. 26*  
6.8L 414 OHV Diesel L6 (Standard), 4.1875" Bore

<b>CYL. HEAD &amp; PARTS</b>				
<b>QTY</b>	<b>GASKETS</b>	<b>PART NO.</b>	<b>SIZE</b>	<b>DESCRIPTION</b>
1	Valve Cover Gasket	FP-R75728		Rocker cover codes 1102, 1103; From Ser. No. 608,511
1	Valve Cover Gasket	FP-T20467		To Ser. No. 103,088
1	Head Gasket	FP-R114157		From Ser. No. 100,001; Manufactured after 1983
1	Head Gasket	FP-R114157		From Ser. No. 290,001 to Ser. No. 621,172; Manufactured 1974-83
1	Head Set	FP-RE38852		From Ser. No. 100,001; Manufactured after 1983
1	Head Set	FP-RE38852		From Ser. No. 290,001 to Ser. No. 621,172; Manufactured 1974-83
<b>QTY</b>	<b>VALVE</b>	<b>PART NO.</b>	<b>SIZE</b>	<b>DESCRIPTION</b>
6	Intake	FP-R89219	STD	Optional Non-Stellite; 1 groove; Chrome plated stem; 1.8210" Head Dia., .3720" Stem Dia., 5.1560" O.A.L.
6	Intake	FP-R83071	STD	Stellite; 2 groove; Chrome plated stem; 1.8210" Head Dia., .3720" Stem Dia., 5.1660" O.A.L.
6	Intake	FP-R89223	3	Stellite; 2 groove; Chrome plated stem; 1.8210" Head Dia., .3750" Stem Dia., 5.1660" O.A.L.
6	Intake	FP-R89224	15	Stellite; 2 groove; Chrome plated stem; 1.8210" Head Dia., .3870" Stem Dia., 5.1660" O.A.L.
6	Intake	FP-R79623	STD	2 groove; Chrome plated stem; 1.7720" Head Dia., .3720" Stem Dia., 5.1560" O.A.L.
6	Intake	FP-R79628	3	2 groove; Chrome plated stem; 1.7720" Head Dia., .3750" Stem Dia., 5.1560" O.A.L.
6	Intake	FP-R79629	15	2 groove; Chrome plated stem; 1.7720" Head Dia., .3870" Stem Dia., 5.1560" O.A.L.
6	Intake	FP-R79630	30	2 groove; Chrome plated stem; 1.7720" Head Dia., .4020" Stem Dia., 5.1560" O.A.L.
6	Exhaust	FP-R79624	STD	1 groove; Chrome plated stem; 1.5750" Head Dia., .3720" Stem Dia., 5.1560" O.A.L.
6	Exhaust	FP-R79625	3	1 groove; Chrome plated stem; 1.5750" Head Dia., .3750" Stem Dia., 5.1560" O.A.L.
6	Exhaust	FP-R79626	15	1 groove; Chrome plated stem; 1.5750" Head Dia., .3870" Stem Dia., 5.1560" O.A.L.
6	Exhaust	FP-R79627	30	1 groove; Chrome plated stem; 1.5750" Head Dia., .4020" Stem Dia., 5.1560" O.A.L.
24	Keeper	FP-41339		1 groove; Square cut key groove
24	Keeper	FP-T20077		1 groove; Square cut key groove; Hardened
24	Keeper, Bulk	VK-138B		1 groove; Square cut key groove; Carton of 1000
<b>QTY</b>	<b>VALVE SEAT</b>	<b>PART NO.</b>	<b>SIZE</b>	<b>DESCRIPTION</b>
6	Exh.	FP-R51734	STD	
6	Int.	FP-R73064	STD	
<b>QTY</b>	<b>VALVE SPRING</b>	<b>PART NO.</b>	<b>SIZE</b>	<b>DESCRIPTION</b>
12	Spring	FP-R26125		2.1200" Free Height
<b>QTY</b>	<b>VALVE MISC.</b>	<b>PART NO.</b>	<b>SIZE</b>	<b>DESCRIPTION</b>
6	Rotocap	FP-RE11410		Exh.
1	Bushing	FP-T26321		Lower
1	Bushing	FP-T20034		Upper
1	Oil Filler Cap Gasket	FP-T20328		Rocker arm cover code 1103
<b>QTY</b>	<b>VALVE SEAL</b>	<b>PART NO.</b>	<b>SIZE</b>	<b>DESCRIPTION</b>
12	Valve Stem Seal	FP-R87627		Exh. & Int.; O-Ring type
<b>ELECTRICAL</b>				
<b>QTY</b>	<b>ELECTRICAL</b>	<b>PART NO.</b>	<b>SIZE</b>	<b>DESCRIPTION</b>
1	Starter to Block Gasket	FP-R53108		3-Hole mount; Starting motor codes 3002, 3011, 3013, 3016, 3017, 3018
<b>QTY</b>	<b>ALTERNATOR</b>	<b>PART NO.</b>	<b>SIZE</b>	<b>DESCRIPTION</b>
1	Ball Brg.	FP-JD9449		Front; w/24 Volt alternator conversion
1	Ball Brg.	FP-JD9449		Front; Delco-Remy No. 1102936; Code 3105; 12 Volt, 61 amp alternator

(continued on next page)

**26 Industrial Applications 6414D Eng.**  
(cont.) 6.8L 414 OHV Diesel L6 (Standard), 4.1875" Bore

<b>ELECTRICAL (cont.)</b>				
QTY	ALTERNATOR (cont.)	PART NO.	SIZE	DESCRIPTION
1	Ball Brg.	FP-JD9449		Front; Delco-Remy Nos. 1100490, 1102932, 1105174; Code 3103; 12 Volt, 72 amp alternator
1	Ball Brg.	FP-JD9449		Front; Delco-Remy Nos. 1100491, 1100580; Code 3102; 12 Volt, 55 amp alternator
1	Ball Brg.	FP-JD9449		Front; Motorola No. 8TA2009ES; Code 3104; 12 Volt, 30 amp alternator
2	Ball Brg.	FP-JD9449		Front & Rear; Motorola No. 70D42179T02; 24 Volt alternator
2	Ball Brg.	FP-JD9449		Front & Rear; Motorola Replacement Nos. 8EM2009NA, 8EM2009NB alternator
<b>INT &amp; EXH MANIFOLDS</b>				
QTY	INT. & EXH. MANIFOLDS	PART NO.	SIZE	DESCRIPTION
6	Exhaust Manifold Gasket	FP-R90658		
2	Air Intake Gasket	FP-R81275		
<b>CAMSHAFT GROUP</b>				
QTY	TIMING COVER	PART NO.	SIZE	DESCRIPTION
1	Timing Gear Cover Gasket	FP-T20273		Access cover
1	Timing Gear Cover Gasket	FP-R97454		Front cover
QTY	CAMSHAFT/LIFTER	PART NO.	SIZE	DESCRIPTION
12	Lifter	FP-T20073		
<b>FUEL SYSTEM &amp; PARTS</b>				
QTY	FUEL INJECTION	PART NO.	SIZE	DESCRIPTION
1	Injector Pump Gasket	FP-R125066		Gear cover
6	Fuel Injector Nozzle	FP-RE37503		Nozzle codes 1602, 1603; From Ser. No. 100,001; Manufactured after 1983
6	Fuel Injector Nozzle	FP-RE37503		Nozzle codes 1602, 1603, 1605; From Ser. No. 290,000 to Ser. No. 621,172; Manufactured 1974-83
6	Fuel Injector Seal	FP-R79605		Fuel line connection; Nozzle codes 1602, 1603; 9.270MM X 13.600MM X 5.080MM
6	Fuel Injector Seal	FP-R92352		Upper packing; w/Stanadyne® nozzle No. 26993
6	Fuel Injector Nut	FP-R79604		w/Injector marked 20291, 22205, 22264, 26993
12	Washer Type Seal	FP-R51936		Leak-off & return line seals; Nozzle codes 1602, 1603, 1607
6	Washer Type Seal	FP-R48000		Lower; w/Nozzle codes 1602, 1603
6	Washer Type Seal	FP-R60746		Upper; Nozzle codes 1602, 1603
QTY	FUEL FILTERS & PUMP	PART NO.	SIZE	DESCRIPTION
1	Mechanical Fuel Pump	FP-RE42211		Transfer pump
1	Fuel Transfer Pump Gasket	FP-R97350		
<b>COOLING SYSTEM</b>				
QTY	WATER PUMP	PART NO.	SIZE	DESCRIPTION
1	Water Pump Impeller	FP-R47191		w/Pump housing marked R66420, R68733
2	Water Pump Repair/Rebuild Kit	FP-RE62661		w/Pump housing marked R66420, R68733
1	Water Pump Housing Gasket	FP-R56809		w/Pump housing marked R56813, R90784, R104648
1	Oil Seal Kit	FP-AR101549		Water Pump; w/Pump housing marked R56813, R90784, R104648
1	Water Pump Mounting Gasket	FP-T20243		w/Pump housing marked R56813, R90784, R104648
QTY	THERMOSTAT	PART NO.	SIZE	DESCRIPTION
2	Thermostat	FP-AR48675		Thermostat code 2204; Thermostat cover code 2102 Vertical; Housing code 2108 Horizontal, 3901 Vertical; 180 Deg.
1	Therm. Hsg. - Water Mfld. Gsk	FP-R54641		Thermostat housing to cyl. head
2	O-Ring	FP-R56461		Thermostat housing tube seals; Housing code 3901
<b>ENGINE BLOCK &amp; PARTS</b>				
QTY	GASKETS	PART NO.	SIZE	DESCRIPTION
1	Flywheel Housing Gasket	FP-R97351		From Ser. No. 100,001; Manufactured after 1983
1	Flywheel Housing Gasket	FP-R97351		From Ser. No. 290,000 to Ser. No. 621,172
1	Oil Pan Gasket	FP-R97344		From Ser. No. 100,000; Manufactured after 1983
1	Oil Pan Gasket	FP-R97344		From Ser. No. 290,000 to Ser. No. 621,172; Manufactured 1974-83
1	Oil Pan Gasket Set	FP-PG303PS		From Ser. No. 100,000; Manufactured after 1983
1	Oil Pan Gasket Set	FP-PG303PS		From Ser. No. 290,000 to Ser. No. 621,172; Manufactured 1974-83
1	Block to End Plate Front Gskt	FP-R131794		From Ser. No. 100,001; Manufactured after 1983
1	Block to End Plate Front Gskt	FP-R131794		From Ser. No. 290,000 to Ser. No. 621,172; Manufactured 1974-83

(continued on next page)



*Industrial Applications 6414D Eng. 26*  
6.8L 414 OHV Diesel L6 (Standard), 4.1875" Bore (cont.)

<b>ENGINE BLOCK &amp; PARTS (cont.)</b>				
<b>QTY</b>	<b>GASKET SETS</b>	<b>PART NO.</b>	<b>SIZE</b>	<b>DESCRIPTION</b>
1	In-Frame Gasket Set	FP-PG359S		
1	Complete Overhaul Gasket Set	FP-RE38555		Crankshaft seals not incl.
1	Complete Overhaul Gasket Set	FP-RE38555WS		Incl. crankshaft seals; Rear main brg. seal incl.; Wear sleeve not incl.
<b>QTY</b>	<b>OIL COOLERS &amp; FILTERS</b>	<b>PART NO.</b>	<b>SIZE</b>	<b>DESCRIPTION</b>
1	O-Ring	FP-A4730R		From Ser. No. 100,001; Manufactured after 1983; Oil cooler to block check valve seal
1	O-Ring	FP-A4730R		From Ser. No. 290,000 to Ser. No. 621,172; Manufactured 1974-83; Oil cooler to block check valve seal
1	O-Ring	FP-R56814		Oil cooler housing inner seal; From Ser. No. 128,418
1	O-Ring	FP-R56192		Oil cooler housing inner seal; To Ser. No. 128,417
1	O-Ring	FP-R56193		Oil cooler housing outer seal; To Ser. No. 128,417
1	Oil Cooler to Block Gasket	FP-R98489		From Ser. No. 620,694
1	Oil Cooler to Head Gasket	FP-R98834		From Ser. No. 100,000; Manufactured after 1983
1	Oil Cooler to Head Gasket	FP-R98834		From Ser. No. 290,000 to Ser. No. 621,172; Manufactured 1974-83
<b>CRANKSHAFT/OIL PUMP</b>				
<b>QTY</b>	<b>CRANKSHAFT</b>	<b>PART NO.</b>	<b>SIZE</b>	<b>DESCRIPTION</b>
1	Crankshaft	FP-RE45517		
1	Oil Seal Kit	FP-SK67942		Incl. front & rear seals; Crankshaft codes 1302; Crankshaft marked R104523, R108679, R54619
<b>QTY</b>	<b>SEALS - FRONT CRANK</b>	<b>PART NO.</b>	<b>SIZE</b>	<b>DESCRIPTION</b>
1	Crankshaft Front Seal	FP-AR67942		
1	O-Ring	FP-H35244		Crankshaft pulley; Pulley codes 1302, 1308, 1314, 1338, 4101
<b>QTY</b>	<b>SEALS - REAR CRANK</b>	<b>PART NO.</b>	<b>SIZE</b>	<b>DESCRIPTION</b>
1	Crankshaft Rear Seal	FP-RE24959		Crankshaft codes 1303, 1308; Flywheel housing codes 1403, 1405, 1421, 1422, 1425
<b>QTY</b>	<b>MAIN BEARINGS</b>	<b>PART NO.</b>	<b>SIZE</b>	<b>DESCRIPTION</b>
1	Main Set	FP-MBK3006	STD	w/Flanged thrust brg.
1	Main Set	FP-MBK300610	10	w/Flanged thrust brg.
1	Main Set	FP-MBK300620	20	w/Flanged thrust brg.
1	Main Set	FP-MBK300630	30	w/Flanged thrust brg.
6	Plain Main Brg.	FP-RE27352	STD	w/Flangeless thrust brg.
6	Plain Main Brg.	FP-RE27353	10	w/Flangeless thrust brg.
6	Plain Main Brg.	FP-RE27360	20	w/Flangeless thrust brg.
6	Plain Main Brg.	FP-RE27368	30	w/Flangeless thrust brg.
1	Flanged Main Brg.	FP-RE521350	STD	
1	Flanged Main Brg.	FP-RE526754	10	
1	Flanged Main Brg.	FP-RE527235	20	
1	Flanged Main Brg.	FP-RE527236	30	
<b>QTY</b>	<b>OIL PUMP</b>	<b>PART NO.</b>	<b>SIZE</b>	<b>DESCRIPTION</b>
1	O-Ring	FP-R61871		Oil pump inlet; w/Pump housing marked R54629
2	O-Ring	FP-R80632		Oil Pump outlet tube
1	Oil Filler Inlet Gasket	FP-R97352		Oil filler neck code 1200
1	Oil Filter Adapter Gasket	FP-R98488		w/Filter adapter marked R91597, R131238; From Ser. No. 128,418
1	Oil Pump Seal Ring	FP-R79563		Oil pump outlet adapter; w/Pump marked R54629; To Ser. No. 122,430
<b>CYLINDER COMPONENTS</b>				
<b>QTY</b>	<b>LINERS</b>	<b>PART NO.</b>	<b>SIZE</b>	<b>DESCRIPTION</b>
6	Liner w/o Sealing Ring	FP-R121867	STD	
6	Liner w/Sealing Rings	FP-RE500024	STD	
6	Cylinder Kit Complete	FP-RE19833	STD	w/Con. Rod marked R56187
6	Cyl. Liner Sealing Ring Kit	FP-AR65507		
6	Sealing Ring, Liner	FP-R48767		Rectangle; Top
6	Sealing Ring, Liner	FP-R26121		Round; Middle
6	Sealing Ring	FP-SLR2520		Round; Bottom
<b>QTY</b>	<b>PISTONS</b>	<b>PART NO.</b>	<b>SIZE</b>	<b>DESCRIPTION</b>
6	Piston Body w/o Pin	FP-AR68188	STD	1.62" pin dia.
6	Piston Kit w/Pin & Retainers	FP-AR68188WP	STD	1.62" pin dia.
6	Pin	FP-R124230		1.62" pin dia.
12	Piston Pin Retainer	FP-R54114		For 1.62" pin dia.
6	Pin Bushing	FP-R57451		w/Con. Rod marked R56187, R58979; Pin dia. 1.62"; 1.621" ID, 1.813" OD, 1.370" O.A.L.

(continued on next page)

**26 Industrial Applications 6414D Eng.**  
(cont.) 6.8L 414 OHV Diesel L6 (Standard), 4.1875" Bore

**CYLINDER COMPONENTS (cont.)**

QTY	CONNECTING RODS & BRGS.	PART NO.	SIZE	DESCRIPTION
12	Con. Rod Bolt	FP-R74195		w/Con. Rod marked R54617, R56187, R116851; Torque-To-Yield bolt; Replacement recommended
6	Rod Pair	FP-AR97517	STD	
6	Rod Pair	FP-AR97653	10	
6	Rod Pair	FP-AR97654	20	
6	Rod Pair	FP-AR97655	30	
QTY	PISTON RINGS	PART NO.	SIZE	DESCRIPTION
6	Ring Set Single Cylinder	FP-RE507852	STD	1-1/8, 1-3/32, 1-.136 (1 cyl. set)
6	Ring Set Single Cylinder	FP-RE66820	STD	1-1/8, 1-3/32, 1-.136 (1 cyl. set)
KITS				
QTY	OVERHAUL KIT	PART NO.	SIZE	DESCRIPTION
1	In-Frame Overhaul Kit	FP-414DIFK		w/Con. Rod marked R56187, R116851; Incl. Torque-To-Yield con. rod bolts
1	Complete Overhaul Kit	FP-414DOHK		w/Con. Rod marked R56187, R116851; Pin dia. 1.62"; Incl. Torque-To-Yield con. rod bolts

**27 Industrial Applications 6414T Eng.**  
6.8L 414 OHV Turbo-Diesel L6 (Standard), 4.1875" Bore

**CYL. HEAD & PARTS**

QTY	GASKETS	PART NO.	SIZE	DESCRIPTION
1	Valve Cover Gasket	FP-R75728		Rocker cover codes 1102, 1103; From Ser. No. 608,511 To Ser. No. 608,510
1	Valve Cover Gasket	FP-T20467		From Ser. No. 100,001; Manufactured after 1983
1	Head Gasket	FP-R114157		From Ser. No. 290,001 to Ser. No. 621,172; Manufactured 1974-83
1	Head Gasket	FP-R114157		From Ser. No. 100,001; Manufactured after 1983
1	Head Set	FP-RE38852		From Ser. No. 290,001 to Ser. No. 621,172; Manufactured 1974-83
1	Head Set	FP-RE38852		
QTY	VALVE	PART NO.	SIZE	DESCRIPTION
6	Intake	FP-R89219	STD	Optional Non-Stellite; 1 groove; Chrome plated stem; 1.8210" Head Dia., .3720" Stem Dia., 5.1560" O.A.L.
6	Intake	FP-R83071	STD	Stellite; 2 groove; Chrome plated stem; 1.8210" Head Dia., .3720" Stem Dia., 5.1660" O.A.L.
6	Intake	FP-R89223	3	Stellite; 2 groove; Chrome plated stem; 1.8210" Head Dia., .3750" Stem Dia., 5.1660" O.A.L.
6	Intake	FP-R89224	15	Stellite; 2 groove; Chrome plated stem; 1.8210" Head Dia., .3870" Stem Dia., 5.1660" O.A.L.
6	Intake	FP-R79623	STD	2 groove; Chrome plated stem; 1.7720" Head Dia., .3720" Stem Dia., 5.1560" O.A.L.
6	Intake	FP-R79628	3	2 groove; Chrome plated stem; 1.7720" Head Dia., .3750" Stem Dia., 5.1560" O.A.L.
6	Intake	FP-R79629	15	2 groove; Chrome plated stem; 1.7720" Head Dia., .3870" Stem Dia., 5.1560" O.A.L.
6	Intake	FP-R79630	30	2 groove; Chrome plated stem; 1.7720" Head Dia., .4020" Stem Dia., 5.1560" O.A.L.
6	Exhaust	FP-R79624	STD	1 groove; Chrome plated stem; 1.5750" Head Dia., .3720" Stem Dia., 5.1560" O.A.L.
6	Exhaust	FP-R79625	3	1 groove; Chrome plated stem; 1.5750" Head Dia., .3750" Stem Dia., 5.1560" O.A.L.
6	Exhaust	FP-R79626	15	1 groove; Chrome plated stem; 1.5750" Head Dia., .3870" Stem Dia., 5.1560" O.A.L.
6	Exhaust	FP-R79627	30	1 groove; Chrome plated stem; 1.5750" Head Dia., .4020" Stem Dia., 5.1560" O.A.L.
24	Keeper	FP-41339		1 groove; Square cut key groove
24	Keeper	FP-T20077		1 groove; Square cut key groove; Hardened
24	Keeper, Bulk	VK-138B		1 groove; Square cut key groove; Carton of 1000
QTY	VALVE SEAT	PART NO.	SIZE	DESCRIPTION
6	Exh.	FP-R51734	STD	
6	Int.	FP-R73064	STD	
QTY	VALVE SPRING	PART NO.	SIZE	DESCRIPTION
12	Spring	FP-R26125		2.1200" Free Height
QTY	VALVE MISC.	PART NO.	SIZE	DESCRIPTION
12	Rotocap	FP-RE11410		Exh. & Int.
1	Bushing	FP-T26321		Lower
1	Bushing	FP-T20034		Upper

(continued on next page)





*Industrial Applications 6414T Eng. 27*  
6.8L 414 OHV Turbo-Diesel L6 (Standard), 4.1875" Bore (cont.)

<b>CYL. HEAD &amp; PARTS (cont.)</b>				
<b>QTY</b>	<b>VALVE MISC. (cont.)</b>	<b>PART NO.</b>	<b>SIZE</b>	<b>DESCRIPTION</b>
1	Oil Filler Cap Gasket	FP-T20328		Rocker arm cover code 1103
<b>QTY</b>	<b>VALVE SEAL</b>	<b>PART NO.</b>	<b>SIZE</b>	<b>DESCRIPTION</b>
12	Valve Stem Seal	FP-R87627		O-Ring type
<b>QTY</b>	<b>ROCKER PARTS</b>	<b>PART NO.</b>	<b>SIZE</b>	<b>DESCRIPTION</b>
1	O-Ring	FP-R56463		Rocker cover breather tube; Breather tube codes 2909, 2915
<b>ELECTRICAL</b>				
<b>QTY</b>	<b>ELECTRICAL</b>	<b>PART NO.</b>	<b>SIZE</b>	<b>DESCRIPTION</b>
1	Starter to Block Gasket	FP-R53108		3-Hole mount; Starting motor codes 3002, 3011, 3013, 3016, 3017, 3018
<b>QTY</b>	<b>ALTERNATOR</b>	<b>PART NO.</b>	<b>SIZE</b>	<b>DESCRIPTION</b>
1	Ball Brg.	FP-JD9449		Front; w/24 Volt alternator conversion
1	Ball Brg.	FP-JD9449		Front; Delco-Remy No. 1102936; Code 3105; 12 Volt, 61 amp alternator
1	Ball Brg.	FP-JD9449		Front; Delco-Remy Nos. 1100490, 1102932, 1105174; Code 3103; 12 Volt, 72 amp alternator
1	Ball Brg.	FP-JD9449		Front; Delco-Remy Nos. 1100491, 1100580; Code 3102
1	Ball Brg.	FP-JD9449		Front; Motorola No. 8TA2009ES; Code 3104; 12 Volt, 30 amp alternator
2	Ball Brg.	FP-JD9449		Front & Rear; Motorola No. 70D42179T02; 24 Volt alternator
2	Ball Brg.	FP-JD9449		Front & Rear; Motorola Replacement Nos. 8EM2009NA, 8EM2009NB alternator
<b>INT &amp; EXH MANIFOLDS</b>				
<b>QTY</b>	<b>INT. &amp; EXH. MANIFOLDS</b>	<b>PART NO.</b>	<b>SIZE</b>	<b>DESCRIPTION</b>
6	Exhaust Manifold Gasket	FP-R90658		
3	Air Intake Gasket	FP-R81275		
<b>CAMSHAFT GROUP</b>				
<b>QTY</b>	<b>TIMING COVER</b>	<b>PART NO.</b>	<b>SIZE</b>	<b>DESCRIPTION</b>
1	Timing Gear Cover Gasket	FP-T20273		Access cover
1	Timing Gear Cover Gasket	FP-R97454		Front cover
<b>QTY</b>	<b>CAMSHAFT/LIFTER</b>	<b>PART NO.</b>	<b>SIZE</b>	<b>DESCRIPTION</b>
12	Lifter	FP-T20073		
<b>FUEL SYSTEM &amp; PARTS</b>				
<b>QTY</b>	<b>FUEL INJECTION</b>	<b>PART NO.</b>	<b>SIZE</b>	<b>DESCRIPTION</b>
1	Injector Pump Gasket	FP-R125066		Gear cover
6	Fuel Injector Nozzle	FP-RE37503		Nozzle codes 1602, 1603; From Ser. No. 100,001; Manufactured after 1983
6	Fuel Injector Nozzle	FP-RE37503		Nozzle codes 1602, 1603; From Ser. No. 290,000 to Ser. No. 621,172; Manufactured 1974-83
6	Fuel Injector Seal	FP-R79605		Fuel line connection; Nozzle codes 1602, 1603; 9.270MM X 13.600MM X 5.080MM
6	Fuel Injector Seal	FP-R92352		Upper packing; w/Stanadyne® nozzle No. 26993
6	Fuel Injector Nut	FP-R79604		w/Injector marked 20291, 22205, 22264, 26993
12	Washer Type Seal	FP-R51936		Leak-off & return line seals; Nozzle codes 1602, 1603, 1609
6	Washer Type Seal	FP-R48000		Lower; w/Nozzle codes 1602, 1603; w/Nozzle marked 26933
6	Washer Type Seal	FP-R60746		Upper; Nozzle codes 1602, 1603
<b>QTY</b>	<b>FUEL FILTERS &amp; PUMP</b>	<b>PART NO.</b>	<b>SIZE</b>	<b>DESCRIPTION</b>
1	Mechanical Fuel Pump	FP-RE42211		Transfer pump
1	Fuel Transfer Pump Gasket	FP-R97350		
<b>QTY</b>	<b>TURBOCHARGER</b>	<b>PART NO.</b>	<b>SIZE</b>	<b>DESCRIPTION</b>
1	Turbocharger Oil Drain Gasket	FP-R105346		w/Turbo oil line codes 6504, 6530
1	Turbocharger Mounting Gasket	FP-R89879		
1	Turbocharger Oil Supply Gskt.	FP-R97348		From Ser. No. 100,001 to Ser. No. 148,514; Manufactured 1983-86
1	Turbocharger Oil Supply Gskt.	FP-R97348		From Ser. No. 290,000 to Ser. No. 621,172; Manufactured 1974-83
<b>COOLING SYSTEM</b>				
<b>QTY</b>	<b>WATER PUMP</b>	<b>PART NO.</b>	<b>SIZE</b>	<b>DESCRIPTION</b>
1	Water Pump Impeller	FP-R47191		w/Pump housing marked R66420, R68733
1	Water Pump Repair/Rebuild Kit	FP-RE62661		w/Pump housing marked R66420, R68733
1	Water Pump Housing Gasket	FP-R56809		
1	Water Pump Mounting Gasket	FP-T20243		w/Pump housing marked R56813, R90784, R104648

(continued on next page)

**27 Industrial Applications 6414T Eng.**  
(cont.) 6.8L 414 OHV Turbo-Diesel L6 (Standard), 4.1875" Bore

<b>COOLING SYSTEM (cont.)</b>				
QTY	THERMOSTAT	PART NO.	SIZE	DESCRIPTION
1	Therm. Hsg. - Water Mfld. Gsk	FP-R54641		Thermostat housing to cyl. head
2	O-Ring	FP-R56461		Thermostat housing tube seals; Housing code 3901
<b>ENGINE BLOCK &amp; PARTS</b>				
QTY	GASKETS	PART NO.	SIZE	DESCRIPTION
1	Flywheel Housing Gasket	FP-R97351		From Ser. No. 100,001; Manufactured after 1983
1	Flywheel Housing Gasket	FP-R97351		From Ser. No. 290,000 to Ser. No. 621,172
1	Oil Pan Gasket	FP-R97344		
1	Oil Pan Gasket Set	FP-PG303PS		From Ser. No. 100,000; Manufactured after 1983
1	Oil Pan Gasket Set	FP-PG303PS		From Ser. No. 290,000 to Ser. No. 621,172; Manufactured 1974-83
1	Oil Seal Kit	FP-AR101549		Water pump; w/Pump housing marked R56813, R90784, R104648
1	Block to End Plate Front Gskt	FP-R131794		From Ser. No. 100,001; Manufactured after 1983
1	Block to End Plate Front Gskt	FP-R131794		From Ser. No. 290,000 to Ser. No. 621,172; Manufactured 1974-83
QTY	GASKET SETS	PART NO.	SIZE	DESCRIPTION
1	In-Frame Gasket Set	FP-PG359S		
1	Complete Overhaul Gasket Set	FP-RE38555		Crankshaft seals not incl.
1	Complete Overhaul Gasket Set	FP-RE38555WS		Incl. crankshaft seals; Rear main brg. seal incl.; Wear sleeve not incl.
QTY	OIL COOLERS & FILTERS	PART NO.	SIZE	DESCRIPTION
1	O-Ring	FP-A4730R		From Ser. No. 100,001; Manufactured after 1983; Oil cooler to block check valve seal
1	O-Ring	FP-A4730R		From Ser. No. 290,000 to Ser. No. 621,172; Manufactured 1974-83; Oil cooler to block check valve seal
1	O-Ring	FP-R56814		Oil cooler housing inner seal; From Ser. No. 138,460
1	O-Ring	FP-R56192		Oil cooler housing inner seal; To Ser. No. 138,459
1	O-Ring	FP-R56193		Oil cooler housing outer seal; To Ser. No. 138,459
1	Oil Cooler Cover Gasket	FP-R98471		
1	Oil Cooler to Block Gasket	FP-R98489		From Ser. No. 620,694
1	Oil Cooler to Head Gasket	FP-R98834		From Ser. No. 100,001; Manufactured after 1983
1	Oil Cooler to Head Gasket	FP-R98834		From Ser. No. 290,000 to Ser. No. 621,172; Manufactured 1974-83
<b>CRANKSHAFT/OIL PUMP</b>				
QTY	CRANKSHAFT	PART NO.	SIZE	DESCRIPTION
1	Crankshaft	FP-RE45517		
1	Oil Seal Kit	FP-SK67942		Incl. front & rear seals; Crankshaft code 1302; Crankshaft marked R104523, R108679, R54619
QTY	SEALS - FRONT CRANK	PART NO.	SIZE	DESCRIPTION
1	Crankshaft Front Seal	FP-AR67942		
1	O-Ring	FP-H35244		Crankshaft pulley; Pulley codes 1302, 1308, 1314, 1338, 4101
QTY	SEALS - REAR CRANK	PART NO.	SIZE	DESCRIPTION
1	Crankshaft Rear Seal	FP-RE24959		Crankshaft codes 1302, 1308; Flywheel housing codes 1403, 1405, 1421, 1422, 1425
QTY	MAIN BEARINGS	PART NO.	SIZE	DESCRIPTION
1	Main Set	FP-MBK3006	STD	
1	Main Set	FP-MBK300610	10	
1	Main Set	FP-MBK300620	20	
1	Main Set	FP-MBK300630	30	
6	Plain Main Brg.	FP-RE27352	STD	w/Flangeless thrust brg.
6	Plain Main Brg.	FP-RE27353	10	w/Flangeless thrust brg.
6	Plain Main Brg.	FP-RE27360	20	w/Flangeless thrust brg.
6	Plain Main Brg.	FP-RE27368	30	w/Flangeless thrust brg.
1	Flanged Main Brg.	FP-RE521350	STD	
1	Flanged Main Brg.	FP-RE526754	10	
1	Flanged Main Brg.	FP-RE527235	20	
1	Flanged Main Brg.	FP-RE527236	30	
QTY	OIL PUMP	PART NO.	SIZE	DESCRIPTION
1	O-Ring	FP-R61871		Oil pump inlet; w/Pump housing marked R54629
2	O-Ring	FP-R80632		Oil Pump outlet tube
1	Oil Filler Inlet Gasket	FP-R97352		Oil filler neck code 1200
1	Oil Pump Seal Ring	FP-R79563		Oil pump outlet adapter; w/Pump marked R54629; To Ser. No. 122,430

(continued on next page)



*Industrial Applications 6414T Eng. 27*  
6.8L 414 OHV Turbo-Diesel L6 (Standard), 4.1875" Bore (cont.)

<b>CYLINDER COMPONENTS</b>				
<b>QTY</b>	<b>LINERS</b>	<b>PART NO.</b>	<b>SIZE</b>	<b>DESCRIPTION</b>
6	Liner w/o Sealing Ring	FP-R121867	STD	
6	Liner w/Sealing Rings	FP-RE500024	STD	
6	Cylinder Kit Complete	FP-RE19832	STD	w/Con. Rod marked R56187; Pin dia. 1.62"
6	Cyl. Liner Sealing Ring Kit	FP-AR65507		
6	Sealing Ring, Liner	FP-R48767		Rectangle; Top
6	Sealing Ring, Liner	FP-R26121		Round; Middle
6	Sealing Ring	FP-SLR2520		Round; Bottom
<b>QTY</b>	<b>PISTONS</b>	<b>PART NO.</b>	<b>SIZE</b>	<b>DESCRIPTION</b>
6	Piston Body w/o Pin	FP-AR96389		
6	Piston Kit w/Pin & Retainers	FP-AR96389WP		w/Con. Rod marked 56187
6	Pin	FP-R124230		1.62" pin dia.
12	Piston Pin Retainer	FP-R54114		For 1.62" pin dia.
6	Pin Bushing	FP-R57451		w/Con. Rod marked R56187, R58979; Pin dia. 1.62"; 1.621" ID, 1.813" OD, 1.370" O.A.L.
<b>QTY</b>	<b>CONNECTING RODS &amp; BRGS.</b>	<b>PART NO.</b>	<b>SIZE</b>	<b>DESCRIPTION</b>
12	Con. Rod Bolt	FP-R74195		w/Con. Rod marked R54617, R56187, R116851; Torque-To-Yield bolt; Replacement recommended
6	Rod Pair	FP-AR97517	STD	
6	Rod Pair	FP-AR97653	10	
6	Rod Pair	FP-AR97654	20	
6	Rod Pair	FP-AR97655	30	
<b>QTY</b>	<b>PISTON RINGS</b>	<b>PART NO.</b>	<b>SIZE</b>	<b>DESCRIPTION</b>
6	Ring Set Single Cylinder	FP-RE507852	STD	1-1/8, 1-3/32, 1-.136 (1 cyl. set)
6	Ring Set Single Cylinder	FP-RE66820	STD	1-1/8, 1-3/32, 1-.136 (1 cyl. set)
<b>KITS</b>				
<b>QTY</b>	<b>OVERHAUL KIT</b>	<b>PART NO.</b>	<b>SIZE</b>	<b>DESCRIPTION</b>
1	In-Frame Overhaul Kit	FP-414TIFK		w/Con. Rod marked R56187, R116851; Pin dia. 1.62"; Incl. Torque-To-Yield con. rod bolts
1	Complete Overhaul Kit	FP-414TOHK		w/Con. Rod marked R56187, R116851; Pin dia. 1.62"; Incl. Torque-To-Yield con. rod bolts
<i>Industrial Applications 6466A, 6466T Engs. 28</i> 7.6L 466 OHV Turbo-Diesel L6 (Standard), 4.5625" Bore				
<b>CYL. HEAD &amp; PARTS</b>				
<b>QTY</b>	<b>VALVE MISC.</b>	<b>PART NO.</b>	<b>SIZE</b>	<b>DESCRIPTION</b>
1	Oil Filler Cap Gasket	FP-T20328		6466A Engs.
<b>INT &amp; EXH MANIFOLDS</b>				
<b>QTY</b>	<b>AIR INTAKE</b>	<b>PART NO.</b>	<b>SIZE</b>	<b>DESCRIPTION</b>
1	O-Ring	FP-R50406		Manifold coupling; Aftercooled; Small end; Manifold codes 1705, 1707, 1719, 1726, 1730; To Ser. No. 67,684
1	O-Ring	FP-R50406		Manifold coupling; Small end; From Ser. No. 67,684
<b>CAMSHAFT GROUP</b>				
<b>QTY</b>	<b>CAMSHAFT/LIFTER</b>	<b>PART NO.</b>	<b>SIZE</b>	<b>DESCRIPTION</b>
1	Camshaft	FP-R71529		Cam marked R64086, R71529, R77259; From Ser. No. 67,685
12	Lifter	FP-R52773		
1	Prelube	55-400		4 oz. bottle; 1.5 oz. packet No. 55-403 also avail.
<b>QTY</b>	<b>CAMSHAFT KIT</b>	<b>PART NO.</b>	<b>SIZE</b>	<b>DESCRIPTION</b>
1	Cam/Lifter Kit	FP-AR100385		Cam marked R64086, R71529, R77259; From Ser. No. 67,685; Incl. (12) FP-R52773, (1) FP-R71529
<b>COOLING SYSTEM</b>				
<b>QTY</b>	<b>WATER PUMP</b>	<b>PART NO.</b>	<b>SIZE</b>	<b>DESCRIPTION</b>
1	Water Pump Shaft	FP-R82052		6466A Engs.; w/Pump housing marked R69945
1	Water Pump Shaft	FP-R70965		6466A Engs.; Water pump code 2014; w/Pump marked R71224, R83561; Gear driven pump
1	Water Pump Impeller	FP-R71225		w/Pump housing marked R71224, R83561
1	Water Pump Impeller	FP-R77388		6466A Engs.; w/Pump housing marked R61439; From Ser. No. 211,132
1	Water Pump Impeller	FP-R50411		6466T Engs.; w/Pump housing marked R50408
1	Water Pump Repair/Rebuild Kit	FP-RE69846		w/Pump housing marked R71224; Gear driven pump
1	Water Pump Repair/Rebuild Kit	FP-RE69847		w/Pump housing marked R83561; Gear driven pump
1	Water Pump Repair/Rebuild Kit	FP-AR103451		6466A Engs.; w/Pump housing marked R69945
1	Water Pump Repair/Rebuild Kit	FP-RE10967		6466A Engs.; Pump code 2001

(continued on next page)

**28 Industrial Applications 6466A, 6466T Engs.**  
 (cont.) 7.6L 466 OHV Turbo-Diesel L6 (Standard), 4.5625" Bore

<b>COOLING SYSTEM (cont.)</b>				
<b>QTY</b>	<b>WATER PUMP (cont.)</b>	<b>PART NO.</b>	<b>SIZE</b>	<b>DESCRIPTION</b>
1	Water Pump Repair/Rebuild Kit	FP-925750411		6466T Engs.; w/Pump housing marked R50408
1	Water Pump Repair/Rebuild Kit	FP-935550411		6466T Engs.; w/Pump housing marked R54955
2	Ball Brg.	FP-JD10329		Fan hub shaft bearing
1	Ball Brg.	FP-JD10171		Front bearing; 6466A Engs.; w/Pump housing marked R71224
1	Ball Brg.	FP-JD10363		Gear driven front bearing; Water pump code 2014; w/Pump housing marked R83561
1	Ball Brg.	FP-JD10362		Gear driven rear bearing; Water pump code 2014; w/Pump housing marked R83561
1	Ball Brg.	FP-JD10113		Rear bearing; 6466A Engs.; w/Pump housing marked R71224
1	Water Pump Housing Gasket	FP-R69944		6466A Engs.; w/Pump housing marked R69945
1	Water Pump Housing Gasket	FP-R61437		6466A Engs.; w/Water pump AR98552; To Ser. No. 211,131
1	Water Pump Housing Gasket	FP-R61437		6466A Engs.; w/Water pump RE10969; From Ser. No. 211,132
1	Water Pump Housing Gasket	FP-R50410		6466T Engs.; w/Pump housing marked R50408
1	Oil Seal Kit	FP-AR101549		Water Pump; w/Pump housing marked R50408
1	Water Pump Mounting Gasket	FP-R71315		w/Pump housing marked R71224, R83561; From Ser. No. 67,685
1	Water Pump Inlet Gasket	FP-R71361		w/Pump housing marked R71224, R83561; From Ser. No. 67,685
1	Water Pump Spacer Gasket	FP-R42406		w/Fan Hub bearing codes 2300, 2306, 2307, 2309, 2310, 2314
1	Oil Seal	FP-RE39134		Water pump code 2014; w/Pump housing marked R71224, R83561
1	O-Ring	FP-R72328		Water tube to thermostat housing seal; Turbo line codes 6501, 6502
1	O-Ring	FP-R71596		Pump cover; w/Pump housing marked R71224, R83561
1	O-Ring	FP-R47153		Water manifold; Water manifold codes 2107, 2108
2	O-Ring	FP-R47153		Water manifold; Water manifold codes 3904, 3905
2	O-Ring	FP-R47153		Water pump tube; Pump code 2014
1	Shaft & Bearing Assembly	FP-JD9257		w/Pump housing marked R58713; To Ser. No. 211,131
1	Shaft & Bearing Assembly	FP-JD10238		w/Pump housing marked R61439; From Ser. No. 211,132
1	Water Pump Hub	FP-JD10058		w/Fan Hub bearing codes 2300, 2306, 2307, 2309, 2310, 2314
1	Water Pump Filter	FP-R98527		w/Pump housing marked R71224, R83561
<b>QTY</b>	<b>THERMOSTAT</b>	<b>PART NO.</b>	<b>SIZE</b>	<b>DESCRIPTION</b>
2	Thermostat	FP-AR48675		Thermostat codes 2101, 2103, 2107, 2108, 2204; 180 Deg.
2	Thermostat	FP-AR72852		Thermostat codes 2102, 2103; Thermostat housing code 3905; 192 Deg.
1	Thermostat Cover Gasket	FP-R46479		Thermostat cover codes 2101, 2102, 2103, 2104, 2107, 2108; Two hole
1	Therm. Hsg. - Water Mfld. Gsk	FP-R86062		Thermostat housing to cyl. head
<b>QTY</b>	<b>MISCELLANEOUS</b>	<b>PART NO.</b>	<b>SIZE</b>	<b>DESCRIPTION</b>
1	Water Line Gasket	FP-R97346		w/Int. manifold R59747, R92644; From Ser. No. 67,685
2	Water Manifold Mounting Gskt.	FP-R88397		
1	Cyl. Block Water Hole Cvr Gsk	FP-R43595		Cyl. head water opening cover gskt.
<b>ENGINE BLOCK &amp; PARTS</b>				
<b>QTY</b>	<b>GASKETS</b>	<b>PART NO.</b>	<b>SIZE</b>	<b>DESCRIPTION</b>
1	Oil Pan Gasket	FP-R71918		
1	Oil Pan Gasket	FP-R49377		6466A Engs.; w/Alum. oil pan w/deep sump; Oil pan codes 1906, 1908, 1922
1	Oil Pan Gasket Set	FP-PG401PS		From Ser. No. 67,685; w/Cast iron oil pan
1	Oil Pan Gasket Set	FP-PG400PS		6466A Engs.; From Ser. No. 67,685; w/Cast iron oil pan
<b>QTY</b>	<b>OIL COOLERS &amp; FILTERS</b>	<b>PART NO.</b>	<b>SIZE</b>	<b>DESCRIPTION</b>
1	Aftercooler Gasket Set	FP-466A		6466A Engs.; From Ser. No. 67,685
2	Aftercooler Gasket	FP-R97347		6466A Engs.; From Ser. No. 67,685
2	O-Ring	FP-R52811		6466A Engs.; Intercooler inlet & outlet tube seals; Int. manifold codes 1705, 1707, 1719, 1726
4	O-Ring	FP-R47153		Cooler tube
1	Oil Cooler Bypass Gasket	FP-R65055		
1	Oil Cooler Cover Gasket	FP-R50419		
<b>CRANKSHAFT/OIL PUMP</b>				
<b>QTY</b>	<b>SEALS - FRONT CRANK</b>	<b>PART NO.</b>	<b>SIZE</b>	<b>DESCRIPTION</b>
1	Oil Seal Kit	FP-AR49025		
<b>QTY</b>	<b>SEALS - REAR CRANK</b>	<b>PART NO.</b>	<b>SIZE</b>	<b>DESCRIPTION</b>
1	Oil Seal	FP-RE22764		PTFE
<b>QTY</b>	<b>OIL PUMP</b>	<b>PART NO.</b>	<b>SIZE</b>	<b>DESCRIPTION</b>
1	O-Ring	FP-R50405		Intake coupling; 6466A Engs.; Large end; Int. manifold codes 1705, 1707, 1719, 1726, 1730
2	O-Ring	FP-R71732		Pump; Pump codes 1904, 1906, 1908, 1922; w/Pump marked R62946, R124328; From Ser. No. 169,337

(continued on next page)

**Industrial Applications 6466A, 6466T Engs. 28**  
7.6L 466 OHV Turbo-Diesel L6 (Standard), 4.5625" Bore (cont.)

<b>CRANKSHAFT/OIL PUMP (cont.)</b>				
<b>QTY</b>	<b>OIL PUMP (cont.)</b>	<b>PART NO.</b>	<b>SIZE</b>	<b>DESCRIPTION</b>
4	O-Ring	FP-R71732		Pump; Pump codes 1904, 1908; w/Pump marked R57556; To Ser. No. 169,336
2	O-Ring	FP-R71732		Pump; 6466A Engs.; Pump codes 1904, 1906, 1907, 1908, 1922; w/Pump marked R62946, R124328
1	O-Ring	FP-R71732		Pump to block; Block codes 4602, 4603; From Ser. No. 169,337
1	O-Ring	FP-R495R		Ventilator tube; 6466A Engs.; Smooth
1	Oil Pump Cover Gasket	FP-R52049		6466A Engs.; Oil pump codes 1904, 1907; From Ser. No. 169,337
1	Oil Pump Cover Gasket	FP-R52049		6466A Engs.; Oil pump codes 1904, 1908; To Ser. No. 169,336
1	Oil Pump Intake Gasket	FP-R100569		6466A Engs.; w/Oil pump housing marked R124328
1	Rect. or Square Seal	FP-R43660		Filter to housing; 6466A Engs.; Filter & body codes 1601, 1606, 1608; w/housing marked R54561, R59483, R62110, R67409, R71484, R84946
1	Oil Filter to Block Gasket	FP-R43774		6466A Engs.; w/Filter housing marked R67409, R71484, R84946
<b>CYLINDER COMPONENTS</b>				
<b>QTY</b>	<b>PISTONS</b>	<b>PART NO.</b>	<b>SIZE</b>	<b>DESCRIPTION</b>
6	Piston Body w/o Pin	FP-AR93629	STD	To Ser. No. 253,372
6	Piston Body w/o Pin	FP-AR100673	STD	6466A Engs.; Piston code 4806; From Ser. No. 233,593 to Ser. No. 317,858
6	Piston Body w/o Pin	FP-AR100616	STD	6466A Engs.; Piston Code 4807; From Ser. No. 317,859
6	Piston Body w/o Pin	FP-AR93629	STD	6466A Engs.; To Ser. No. 253,372
6	Piston Body w/o Pin	FP-AR100616	STD	6466T Engs.; From Ser. No. 67,685
6	Piston Kit w/Pin & Retainers	FP-AR100673WP	STD	6466A Engs.; Piston code 4806; From Ser. No. 233,593 to Ser. No. 317,858
6	Piston Kit w/Pin & Retainers	FP-AR100616WP	STD	6466A Engs.; Piston Code 4807; From Ser. No. 317,859
6	Piston Kit w/Pin & Retainers	FP-AR93629WP	STD	6466A Engs.; To Ser. No. 253,372
6	Piston Kit w/Pin & Retainers	FP-AR100616WP	STD	6466T Engs.; From Ser. No. 67,685
6	Piston Kit w/Pin & Retainers	FP-AR93629WP	STD	6466T Engs.; To Ser. No. 67,684
6	Pin	FP-R57771		
12	Piston Pin Retainer	FP-E1343FN		
6	Pin Bushing	FP-R60724		6466A Engs.; w/Con. Rod marked R67320; From Ser. No. 233,592; w/1.875" ID, 2.0622" OD, 1.657" O.A.L.
6	Pin Bushing	FP-R74008		6466A Engs.; w/Con. Rod marked R71074; From Ser. No. 67,685; 1.877" ID, 2.0622 OD, 1.8728" O.A.L.
6	Pin Bushing	FP-R60724		6466T Engs.; w/Con. Rod marked R57303, R67320; To Ser. No. 253,372; w/1.875" ID, 2.0622" OD, 1.657" O.A.L.
6	Pin Bushing	FP-R74008		6466T Engs.; w/Con. Rod marked R71074; From Ser. No. 253,373; 1.877" ID, 2.0622 OD, 1.8728" O.A.L.
<b>QTY</b>	<b>CONNECTING RODS &amp; BRGS.</b>	<b>PART NO.</b>	<b>SIZE</b>	<b>DESCRIPTION</b>
12	Con. Rod Bolt	FP-R66452		w/Con. Rod marked R57303, R67320, R71074; Torque-To-Yield bolt; Replacement recommended
<b>KITS</b>				
<b>QTY</b>	<b>OVERHAUL KIT</b>	<b>PART NO.</b>	<b>SIZE</b>	<b>DESCRIPTION</b>
1	In-Frame Overhaul Kit	FP-466AHPIFK		Incl. Torque-To-Yield con. rod bolts
1	In-Frame Overhaul Kit	FP-466TAEIFK		6466A Engs.; w/Con. Rod marked R67320; To Ser. No. 67,684; Incl. Torque-To-Yield con. rod bolts
1	In-Frame Overhaul Kit	FP-466TALIFK		6466A Engs.; Incl. Torque-To-Yield con. rod bolts
1	In-Frame Overhaul Kit	FP-466TAEIFK		6466T Engs.; w/Con. Rod marked R57303, R67320; To Ser. No. 253,372; Incl. Torque-To-Yield con. rod bolts
1	In-Frame Overhaul Kit	FP-466TALIFK		6466T Engs.; Incl. Torque-To-Yield con. rod bolts
1	Complete Overhaul Kit	FP-466TAEOHK		6466A Engs.; w/Con. Rod marked R67320; From Ser. No. 233,592; Incl. Torque-To-Yield con. rod bolts
1	Complete Overhaul Kit	FP-466TALOHK		6466A Engs.; w/Con. Rod marked R71074; From Ser. No. 67,685; Incl. Torque-To-Yield con. rod bolts
1	Complete Overhaul Kit	FP-466AHPOHK		6466A Engs.; Piston code 4806; w/Con. Rod marked R71074; From Ser. No. 233,593 to Ser. No. 317,858; Incl. Torque-To-Yield con. rod bolts
1	Complete Overhaul Kit	FP-466TAEOHK		6466T Engs.; w/Con. Rod marked R57303, R67320; To Ser. No. 253,372; Incl. Torque-To-Yield con. rod bolts
1	Complete Overhaul Kit	FP-466TALOHK		6466T Engs.; w/Con. Rod marked R71074; From Ser. No. 253,373; Incl. Torque-To-Yield con. rod bolts

## 29 Industrial Applications 6076D Eng. 7.6L 465.9 (7638cc) OHV Diesel L6 (Litre Engine), 115mm Bore

CYL. HEAD & PARTS				
QTY	GASKETS	PART NO.	SIZE	DESCRIPTION
1	Head Gasket	FP-RE47336		From Ser. No. 500,000
1	Head Set	FP-RG22248		From Ser. No. 500,000
QTY	HEAD BOLTS	PART NO.	SIZE	DESCRIPTION
11	Head Bolt	FP-R88043		To Ser. No. 499,999; 5.250" length
8	Head Bolt	FP-R88044		To Ser. No. 499,999; 6.250" length
7	Head Bolt	FP-R88045		To Ser. No. 499,999; 7.250" length
QTY	VALVE	PART NO.	SIZE	DESCRIPTION
6	Intake	FP-R84618	STD	1 groove; Chrome plated stem; 2.0080" Head Dia., .3730" Stem Dia., 6.0600" O.A.L.
6	Intake	FP-R93308	3	1 groove; Chrome plated stem; 2.0080" Head Dia., .3760" Stem Dia., 6.0600" O.A.L.
6	Exhaust	FP-R84619	STD	1 groove; Chrome plated stem; 1.8500" Head Dia., .3720" Stem Dia., 6.1780" O.A.L.
6	Exhaust	FP-R93311	3	1 groove; Chrome plated stem; 1.8500" Head Dia., .3750" Stem Dia., 6.1780" O.A.L.
12	Valve Stem Cap	FP-T20129		
QTY	VALVE SEAT	PART NO.	SIZE	DESCRIPTION
6	Exh.	FP-R84976	STD	
6	Exh.	FP-R93349	10	
6	Int.	FP-R84977	STD	
6	Int.	FP-R93350	10	
QTY	VALVE SPRING	PART NO.	SIZE	DESCRIPTION
12	Spring	FP-R91822		
QTY	VALVE MISC.	PART NO.	SIZE	DESCRIPTION
12	Rotocap	FP-RE11410		Exh. & Int.
1	Oil Filler Cap Gasket	FP-T20328		Rocker arm cover codes 1101, 1103, 2904, 2908; Oil filler neck codes 1208, 6209
ELECTRICAL				
QTY	ELECTRICAL	PART NO.	SIZE	DESCRIPTION
1	Starter to Block Gasket	FP-R53108		3-Hole mount; Starting motor codes 3004, 3005, 3011, 3016
QTY	ALTERNATOR	PART NO.	SIZE	DESCRIPTION
1	Ball Brg.	FP-JD9449		Front; Delco-Remy components; Code 3132; 24 Volt, 40 amp alternator
1	Ball Brg.	FP-JD9449		Front; Delco-Remy No. 1101345; Code 3114; 12 Volt, 78 amp alternator
1	Ball Brg.	FP-JD9449		Front; Nippondenso components; Code 3143; 12 Volt, 90 amp Poly-Vee alternator
1	Ball Brg.	FP-JD9449		Front; Nippondenso components; 12 Volt, 90 amp alternator
2	Ball Brg.	FP-JD9449		Front & Rear; Motorola No. 70D42179T02; Code 3106; 24 Volt, 45 amp alternator
METERS				
QTY	METERS	PART NO.	SIZE	DESCRIPTION
1	O-Ring	FP-R79915		Tach sensor seal to cover; Codes 4402, 4420
INT & EXH MANIFOLDS				
QTY	INT. & EXH. MANIFOLDS	PART NO.	SIZE	DESCRIPTION
3	Intake Manifold Gasket	FP-R130573		From Ser. No. 500,000; w/Int. manifolds R89790, R115393, R130718, R131473, R131651, R131657, R132290, R134429
3	Intake Manifold Gasket	FP-R130573		To Ser. No. 499,999; w/Int. manifolds R89790, R96518
CAMSHAFT GROUP				
QTY	TIMING COVER	PART NO.	SIZE	DESCRIPTION
1	Crankshaft Front Cover Gasket	FP-R26058		To Ser. No. 499,999
FUEL SYSTEM & PARTS				
QTY	FUEL INJECTION	PART NO.	SIZE	DESCRIPTION
1	Washer	FP-R53901		Control valve seal to housing; Pump housing codes 1601, 1604, 1637, 1688, 1689; Filter & line codes 3511, 3512
1	Washer	FP-R53899		Fuel filter codes 3511, 3512
6	Washer	FP-R84472		Injector nozzle; Fuel inj. nozzle & line codes 1604, 1610, 1616, 1650; .290" X .715" X .079"
6	Washer	FP-R84472		Injector nozzle; Nozzle codes 1610, 1626, 1637, 1640, 1650; To Ser. No. 586,899; .290" X .715" X .079"
6	Fuel Injector Nut	FP-R79604		Inj. pump; Line codes 1601, 1604, 1623, 1637, 1644, 1652, 1667, 1680, 1683, 1686, 1688; To Ser. No. 499,999

(continued on next page)



*Industrial Applications 6076D Eng. 29*  
7.6L 465.9 (7638cc) OHV Diesel L6 (Litre Engine), 115mm Bore (cont.)

<b>FUEL SYSTEM &amp; PARTS (cont.)</b>				
QTY	FUEL INJECTION (cont.)	PART NO.	SIZE	DESCRIPTION
13	Washer Type Seal	FP-R51936		Leak-off & return line seals; Nozzle codes 1604, 1610, 1616, 1637, 1650
13	Washer Type Seal	FP-R51936		L.H. & R.H.; Aux. drive line seals
QTY	FUEL FILTERS & PUMP	PART NO.	SIZE	DESCRIPTION
6	O-Ring	FP-R77551		Leak-off fitting to nozzle; Nozzle codes 1601, 1604, 1610, 1615, 1616, 1623, 1637, 1644, 1650; Viton®
QTY	TURBOCHARGER	PART NO.	SIZE	DESCRIPTION
1	O-Ring	FP-R86743		Outer coupling; Manifold code 1726
<b>COOLING SYSTEM</b>				
QTY	WATER PUMP	PART NO.	SIZE	DESCRIPTION
1	Water Pump Impeller	FP-R71225		Water pump code 2032; w/Pump housing marked R83561
2	Ball Brg.	FP-JD10329		Fan hub shaft bearing
1	Ball Brg.	FP-JD10363		Gear driven front bearing; Water pump code 2032; w/Pump housing marked R83561
1	Ball Brg.	FP-JD10362		Gear driven rear bearing; Water pump code 2032; w/Pump housing marked R83561
1	Water Pump Inlet Gasket	FP-R71361		w/Pump housing marked R83561; To Ser. No. 499,999
1	Oil Seal	FP-RE39134		Water pump code 2032; w/Pump housing marked R83561; To Ser. No. 499,999
3	O-Ring	FP-R72328		Water tube to thermostat housing seal; Water pump code 2030; Thermostat housing code 3905
3	O-Ring	FP-R72328		6076D Engs.; Water tube to thermostat housing seal; Water pump codes 2030, 2039; Thermostat housing codes 3905, 3909
1	O-Ring	FP-R101042		Housing to cover; Water pump code 2030; w/Gear driven pump
1	O-Ring	FP-R71596		Pump cover; w/Pump housing marked R83561; Water pump code 2032
2	O-Ring	FP-R47153		Water pump tube
1	Oil Seal	FP-RE20768		Fan hub shaft seal; For gear driven water pump
1	Water Pump Hub	FP-JD10058		w/Fan Hub bearing codes 2317, 2318, 2324, 2328, 2329, 2330, 2331, 2332, 2334, 2336, 2338, 2339
1	Water Pump Filter	FP-R98527		Water pump code 2032; w/Pump housing marked R83561; From Ser. No. 101,935
QTY	THERMOSTAT	PART NO.	SIZE	DESCRIPTION
2	Thermostat	FP-AR48675		Thermostat code 2204; 180 Deg.
1	Thermostat Cover Gasket	FP-R46479		Thermostat cover codes 2102, 2114, 2204, 3904, 3912; Two hole
2	O-Ring	FP-R47153		Thermostat; Water manifold codes 3904, 3912
QTY	MISCELLANEOUS	PART NO.	SIZE	DESCRIPTION
2	Water Manifold Mounting Gskt.	FP-R88397		
<b>ENGINE BLOCK &amp; PARTS</b>				
QTY	GASKETS	PART NO.	SIZE	DESCRIPTION
1	Front Cover Gasket	FP-R125670		Aux. drive L.H. rear cover gskt.
1	Oil Pan Gasket	FP-R71918		
1	Oil Pan Gasket	FP-R49377		w/Alum. pan; Oil pan codes 1906, 1916, 1922, 1953, 1954
1	Oil Pan Gasket Set	FP-PG400PS		To Ser. No. 499,999; w/Cast iron oil pan
2	O-Ring	FP-U13639		Block coolant drain plug seal; Coolant heater codes 2601, 2602; 1.475" X .118"
QTY	GASKET SETS	PART NO.	SIZE	DESCRIPTION
1	In-Frame Gasket Set	FP-PG6076LS		From Ser. No. 500,000
1	In-Frame Gasket Set	FP-PG6076ES		To Ser. No. 499,999
1	Complete Overhaul Gasket Set	FP-RE57187		From Ser. No. 500,000; Crankshaft seals not incl.
1	Complete Overhaul Gasket Set	FP-RE64206		From Ser. No. 500,000; Crankshaft seals not incl.
1	Complete Overhaul Gasket Set	FP-RE57187WS		From Ser. No. 500,000; Incl. Crankshaft seals
1	Complete Overhaul Gasket Set	FP-RE64206WS		From Ser. No. 500,000; Incl. Crankshaft seals
1	Complete Overhaul Gasket Set	FP-RE35647		To Ser. No. 499,999; Crankshaft seals not incl.
QTY	CAM BEARINGS	PART NO.	SIZE	DESCRIPTION
1	Cam Brg.	FP-R87561		
QTY	OIL COOLERS & FILTERS	PART NO.	SIZE	DESCRIPTION
4	O-Ring	FP-R47153		Cooler tube
<b>CRANKSHAFT/OIL PUMP</b>				
QTY	CRANKSHAFT	PART NO.	SIZE	DESCRIPTION
1	Crankshaft	FP-RE53422		Gears incl.; Short snout 3.000"
1	Crankshaft	FP-AR96189		Gears not incl.

(continued on next page)

<b>29 Industrial Applications 6076D Eng.</b>				
<b>(cont.) 7.6L 465.9 (7638cc) OHV Diesel L6 (Litre Engine), 115mm Bore</b>				
<b>CRANKSHAFT/OIL PUMP (cont.)</b>				
<b>QTY</b>	<b>SEALS - FRONT CRANK</b>	<b>PART NO.</b>	<b>SIZE</b>	<b>DESCRIPTION</b>
1	Oil Seal Kit	FP-AR49025		
<b>QTY</b>	<b>SEALS - REAR CRANK</b>	<b>PART NO.</b>	<b>SIZE</b>	<b>DESCRIPTION</b>
1	Oil Seal	FP-RE22764		PTFE
1	Oil Seal Kit	FP-SK49025		Incl. front & rear seals
<b>QTY</b>	<b>MAIN BEARINGS</b>	<b>PART NO.</b>	<b>SIZE</b>	<b>DESCRIPTION</b>
5	Plain Main Brg.	FP-AR74814	STD	
5	Plain Main Brg.	FP-AR74816	10	
5	Plain Main Brg.	FP-AR74817	20	
5	Plain Main Brg.	FP-AR74818	30	
1	Flanged Main Brg.	FP-AR77748	STD	
1	Flanged Main Brg.	FP-AR77750	10	
1	Flanged Main Brg.	FP-AR77751	20	
1	Flanged Main Brg.	FP-AR77752	30	
1	Thrust Washer Set	FP-AR77747	STD	
<b>QTY</b>	<b>OIL PUMP</b>	<b>PART NO.</b>	<b>SIZE</b>	<b>DESCRIPTION</b>
3	O-Ring	FP-U17409		Oil cooler relief valve plug seal; Filter & housing code 5919
4	O-Ring	FP-R71732		Pump by-pass tubes; Pump codes 5001, 5003, 5004; w/Pump marked R62946, R124328
1	Oil Pump Intake Gasket	FP-R100569		w/Oil pump housing marked R124328, R124746; Oil pump pickup codes 1904, 1906, 1908, 1916, 1922, 1953
1	Rect. or Square Seal	FP-R43660		Filter to housing; Filter & body code 5919; w/housing marked R120412
1	Oil Pump Intake Elbow Gasket	FP-R71312		w/Rear deep sump; Oil pump code 5003; Oil pan code 1906
1	Oil Filter to Block Gasket	FP-R43774		Filter housing code 5931
<b>CYLINDER COMPONENTS</b>				
<b>QTY</b>	<b>LINERS</b>	<b>PART NO.</b>	<b>SIZE</b>	<b>DESCRIPTION</b>
6	Liner w/o Sealing Ring	FP-R87858		
6	Liner w/Sealing Rings	FP-R87858WS		
6	Cylinder Kit Complete	FP-RE60294	STD	w/Con. Rod marked R71074; From Ser. No. 500,000
6	Cylinder Kit Complete	FP-RE48739	STD	w/Con. Rod marked R71074; To Ser. No. 499,999
6	Cyl. Liner Sealing Ring Kit	FP-AR98850		
<b>QTY</b>	<b>PISTONS</b>	<b>PART NO.</b>	<b>SIZE</b>	<b>DESCRIPTION</b>
6	Piston Body w/o Pin	FP-RE57512	STD	From Ser. No. 500,000
6	Piston Body w/o Pin	FP-RE50868	STD	To Ser. No. 499,999
6	Piston Kit w/Pin & Retainers	FP-RE57512WP	STD	From Ser. No. 500,000
6	Piston Kit w/Pin & Retainers	FP-RE50868WP	STD	To Ser. No. 499,999
6	Pin	FP-R57771		
12	Piston Pin Retainer	FP-E1343FN		
6	Pin Bushing	FP-R74008		w/Con. Rod marked R71074; 1.877" ID, 2.0622 OD, 1.8728" O.A.L.
<b>QTY</b>	<b>CONNECTING RODS &amp; BRGS.</b>	<b>PART NO.</b>	<b>SIZE</b>	<b>DESCRIPTION</b>
12	Con. Rod Bolt	FP-R66452		w/Con. Rod marked R71074; Torque-To-Yield bolt; Replacement recommended
6	Rod Pair	FP-AR73277	STD	
6	Rod Pair	FP-AR73279	10	
6	Rod Pair	FP-AR73280	20	
6	Rod Pair	FP-AR73281	30	
<b>QTY</b>	<b>PISTON RINGS</b>	<b>PART NO.</b>	<b>SIZE</b>	<b>DESCRIPTION</b>
6	Ring Set Single Cylinder	FP-RE57517	STD	From Ser. No. 500,000
<b>KITS</b>				
<b>QTY</b>	<b>OVERHAUL KIT</b>	<b>PART NO.</b>	<b>SIZE</b>	<b>DESCRIPTION</b>
1	In-Frame Overhaul Kit	FP-6076LIFK		w/Con. Rod marked R71074; From Ser. No. 500,000; Incl. Torque-To-Yield con. rod bolts
1	In-Frame Overhaul Kit	FP-6076EIFK		w/Con. Rod marked R71074; To Ser. No. 499,999; Incl. Torque-To-Yield con. rod bolts
1	Complete Overhaul Kit	FP-6076LOHK		w/Con. Rod marked R71074; From Ser. No. 500,000; Incl. Torque-To-Yield con. rod bolts
1	Complete Overhaul Kit	FP-6076EOHK		w/Con. Rod marked R71074; To Ser. No. 499,999; Incl. Torque-To-Yield con. rod bolts





*Industrial Applications 6076A, 6076H, 6076T Engs. 30*  
7.6L 465.9 (7638cc) OHV Turbo-Diesel L6 (Litre Engine), 115mm Bore

<b>CYL. HEAD &amp; PARTS</b>				
<b>QTY</b>	<b>GASKETS</b>	<b>PART NO.</b>	<b>SIZE</b>	<b>DESCRIPTION</b>
1	Head Gasket	FP-RE47336		From Ser. No. 500,000
1	Head Set	FP-RG22248		From Ser. No. 500,000
<b>QTY</b>	<b>HEAD BOLTS</b>	<b>PART NO.</b>	<b>SIZE</b>	<b>DESCRIPTION</b>
11	Head Bolt	FP-R88043		To Ser. No. 499,999; 5.250" length
8	Head Bolt	FP-R88044		To Ser. No. 499,999; 6.250" length
7	Head Bolt	FP-R88045		To Ser. No. 499,999; 7.250" length
<b>QTY</b>	<b>VALVE</b>	<b>PART NO.</b>	<b>SIZE</b>	<b>DESCRIPTION</b>
6	Intake	FP-R84618	STD	1 groove; Chrome plated stem; 2.0080" Head Dia., .3730" Stem Dia., 6.0600" O.A.L.
6	Intake	FP-R93308	3	1 groove; Chrome plated stem; 2.0080" Head Dia., .3760" Stem Dia., 6.0600" O.A.L.
6	Exhaust	FP-R84619	STD	1 groove; Chrome plated stem; 1.8500" Head Dia., .3720" Stem Dia., 6.1780" O.A.L.
6	Exhaust	FP-R93311	3	1 groove; Chrome plated stem; 1.8500" Head Dia., .3750" Stem Dia., 6.1780" O.A.L.
12	Valve Stem Cap	FP-T20129		
<b>QTY</b>	<b>VALVE SEAT</b>	<b>PART NO.</b>	<b>SIZE</b>	<b>DESCRIPTION</b>
6	Exh.	FP-R84976	STD	
6	Exh.	FP-R93349	10	
6	Int.	FP-R84977	STD	
6	Int.	FP-R93350	10	
<b>QTY</b>	<b>VALVE SPRING</b>	<b>PART NO.</b>	<b>SIZE</b>	<b>DESCRIPTION</b>
12	Spring	FP-R91822		
<b>QTY</b>	<b>VALVE MISC.</b>	<b>PART NO.</b>	<b>SIZE</b>	<b>DESCRIPTION</b>
12	Rotocap	FP-RE11410		Exh. & Int.
1	Oil Filler Cap Gasket	FP-T20328		Rocker arm cover codes 1101, 1103, 2904, 2908; Oil filler neck codes 1208, 6209
<b>ELECTRICAL</b>				
<b>QTY</b>	<b>ELECTRICAL</b>	<b>PART NO.</b>	<b>SIZE</b>	<b>DESCRIPTION</b>
1	Starter to Block Gasket	FP-R53108		3-Hole mount; Starting motor codes 3004, 3005, 3011, 3016
<b>QTY</b>	<b>ALTERNATOR</b>	<b>PART NO.</b>	<b>SIZE</b>	<b>DESCRIPTION</b>
1	Ball Brg.	FP-JD9449		Front; Delco-Remy components; Code 3132; 24 Volt, 40 amp alternator
1	Ball Brg.	FP-JD9449		Front; Nippondenso components; Code 3137; 12 Volt, 70 amp alternator
1	Ball Brg.	FP-JD9449		Front; Nippondenso components; Code 3143; 12 Volt, 90 amp Poly-Vee alternator
2	Ball Brg.	FP-JD9449		Front & Rear; Delco-Remy No. 1101345; Code 3114; 12 Volt, 78 amp alternator
2	Ball Brg.	FP-JD9449		Front & Rear; Motorola No. 70D42179T02; 24 Volt, 45 amp alternator
<b>METERS</b>				
<b>QTY</b>	<b>METERS</b>	<b>PART NO.</b>	<b>SIZE</b>	<b>DESCRIPTION</b>
1	O-Ring	FP-R79915		Tach sensor seal to cover; Codes 4402, 4420
<b>INT &amp; EXH MANIFOLDS</b>				
<b>QTY</b>	<b>INT. &amp; EXH. MANIFOLDS</b>	<b>PART NO.</b>	<b>SIZE</b>	<b>DESCRIPTION</b>
2	Exhaust Manifold Gasket	FP-R83021		One Exh. hole
2	Exhaust Manifold Gasket	FP-R83020		Two Exh. holes
3	Intake Manifold Gasket	FP-R130573		w/Int. manifolds R108608, R127872, R132293
3	Intake Manifold Gasket	FP-R130573		w/Int. manifolds R89791, R91466, R112707
3	Intake Manifold Gasket	FP-R130573		From Ser. No. 500,000; w/Int. manifolds R89790, R115393, R130718, R131473, R131651, R131657, R132290, R134429
3	Intake Manifold Gasket	FP-R130573		To Ser. No. 499,999; w/Int. manifold R89790
<b>CAMSHAFT GROUP</b>				
<b>QTY</b>	<b>TIMING COVER</b>	<b>PART NO.</b>	<b>SIZE</b>	<b>DESCRIPTION</b>
1	Crankshaft Front Cover Gasket	FP-R26058		
1	Timing Gear Cover Gasket	FP-R50390		Access cover
1	Timing Gear Cover Gasket	FP-R99464		From Ser. No. 500,000
1	Timing Gear Cover Gasket	FP-R71314		To Ser. No. 499,999
1	Timing Gear Cover Gasket	FP-R93346		To Ser. No. 499,999; Use w/cover R109662
<b>QTY</b>	<b>CAMSHAFT/LIFTER</b>	<b>PART NO.</b>	<b>SIZE</b>	<b>DESCRIPTION</b>
1	Camshaft Plug	FP-R82007		

(continued on next page)

**30 Industrial Applications 6076A, 6076H, 6076T Engs.**  
 (cont.) 7.6L 465.9 (7638cc) OHV Turbo-Diesel L6 (Litre Engine), 115mm Bore

<b>FUEL SYSTEM &amp; PARTS</b>				
<b>QTY</b>	<b>FUEL INJECTION</b>	<b>PART NO.</b>	<b>SIZE</b>	<b>DESCRIPTION</b>
1	Washer	FP-R53899		Control valve to pump housing seal; Pump housing codes 1610, 1616, 1626, 1640, 1641, 1650, 1654; Fuel filter codes 3502, 3503, 3511, 3513
1	Washer	FP-R53901		6076A Engs.; Control valve seal to housing; Pump housing codes 1601, 1637, 1650, 1688, 1689; Filter & line codes 3512, 3521
1	Washer	FP-R53901		6076T Engs.; Control valve seal to housing; Pump housing codes 1652, 1652, 1680; Filter & line codes 3512, 3521
6	Washer	FP-R84472		Injector nozzle; 6076A Engs.; Nozzle codes 1601, 1617, 1637, 1686, 1688, 1689; .290" X .715" X .079"
6	Washer	FP-R84472		Injector nozzle; 6076T Engs.; Nozzle codes 1652, 1683; .290" X .715" X .079"
6	Fuel Injector Nut	FP-R79604		6076A Engs.; Inj. pump; Line codes 1601, 1604, 1623, 1637, 1644, 1652, 1667, 1680, 1683, 1686, 1688
13	Washer Type Seal	FP-R51936		Electric fuel shut-off
13	Washer Type Seal	FP-R51936		Leak-off & return line seals; Nozzle codes 1601, 1604, 1611, 1612, 1613, 1615, 1616, 1617, 1622, 1623, 1625, 1626, 1637, 1640, 1641, 1644, 1650, 1652, 1654, 1655, 1656, 1657, 1667, 1676, 1678, 1680, 1683, 1686, 1688, 1689
13	Washer Type Seal	FP-R51936		L.H. & R.H.; Aux. drive line seals
<b>QTY</b>	<b>FUEL FILTERS &amp; PUMP</b>	<b>PART NO.</b>	<b>SIZE</b>	<b>DESCRIPTION</b>
6	O-Ring	FP-R77551		Leak-off fitting to nozzle; Nozzle codes 1601, 1610, 1611, 1612, 1613, 1615, 1616, 1617, 1626, 1637, 1640, 1641, 1644, 1650, 1654, 1667, 1676, 1678, 1684, 1686, 1688, 1689; Viton®
6	O-Ring	FP-R51603		Fuel nozzle; 6076A Engs.; Injector nozzle codes 1611, 1644, 1655; w/Bosch injector
<b>QTY</b>	<b>TURBOCHARGER</b>	<b>PART NO.</b>	<b>SIZE</b>	<b>DESCRIPTION</b>
1	Turbocharger Oil Drain Gasket	FP-R105346		w/Turbo oil line codes 6501, 6502, 6504, 6505, 6506, 6510
1	Turbocharger Mounting Gasket	FP-R89879		
1	O-Ring	FP-R57517		6076A Engs.; Manifold to turbo coupling seal; Int. manifold code 1707
1	O-Ring	FP-R86743		Inner coupling; Manifold code 1707
1	O-Ring	FP-R86743		Outer coupling; Manifold codes 1706, 1709, 1710, 1726, 1731, 1737, 1738
1	O-Ring	FP-R86743		Outer coupling; Manifold codes 1726, 1730; Rear mount turbo code 4307
1	Sealing Ring	FP-R100911		6076A Engs.; Cooler inlet/outlet gskt.
1	Turbo Exhaust Int. Cover Gskt	FP-R92097		6076T Engs.; Rear mounted turbocharger
<b>COOLING SYSTEM</b>				
<b>QTY</b>	<b>WATER PUMP</b>	<b>PART NO.</b>	<b>SIZE</b>	<b>DESCRIPTION</b>
1	Water Pump Shaft	FP-R70965		Water pump codes 2014, 2032; w/Pump marked R83561; Gear driven pump
1	Water Pump Impeller	FP-R71225		Pump codes 2014, 2032; w/Pump housing marked R83561
1	Water Pump Repair/Rebuild Kit	FP-RE69847		w/Pump housing marked R83561; Gear driven pump
2	Ball Brg.	FP-JD10329		Fan hub shaft bearing
1	Ball Brg.	FP-JD10363		Gear driven front bearing; Water pump codes 2014, 2032; w/Pump housing marked R83561
1	Ball Brg.	FP-JD10362		Gear driven rear bearing; Water pump codes 2014, 2032; w/Pump housing marked R83561
1	Water Pump Gasket	FP-R96616		w/Pump cover R96606, R133310; From Ser. No. 500,000
1	Water Pump Housing Gasket	FP-R100367		w/Pump housing marked RE39121, RE68230; w/Raised letter "X"; From Ser. No. 500,000
1	Water Pump Mounting Gasket	FP-R71315		w/Pump housing marked R83561; To Ser. No. 499,999
1	Water Pump Mounting Gasket	FP-R71315		w/Pump housing marked R85677
1	Water Pump Inlet Gasket	FP-R71361		w/Pump housing marked R83561; To Ser. No. 499,999
1	Oil Seal	FP-RE20768		Fan hub shaft seal; For gear driven water pump
1	Oil Seal	FP-RE39134		Water pump codes 2014, 2032; w/Pump housing marked R83561
3	O-Ring	FP-R72328		Water tube to thermostat housing seal; Water pump code 2030; Thermostat housing code 3905
1	O-Ring	FP-R101042		Housing to cover; Water pump codes 2030, 2039; w/Gear driven pump
1	O-Ring	FP-R71596		Pump cover; w/Pump housing marked R83561; Water pump code 2014
2	O-Ring	FP-R47153		Water pump tube
1	Water Pump Hub	FP-JD10058		w/Fan Hub bearing codes 2317, 2318, 2320, 2324, 2327, 2328, 2329, 2330, 2331, 2332, 2334, 2335, 2336, 2338, 2339, 2340
1	Water Pump Filter	FP-R98527		Water pump codes 2014, 2032; w/Pump housing marked R83561; From Ser. No. 101,935

(continued on next page)



*Industrial Applications 6076A, 6076H, 6076T Engs. 30*  
7.6L 465.9 (7638cc) OHV Turbo-Diesel L6 (Litre Engine), 115mm Bore (cont.)

<b>COOLING SYSTEM (cont.)</b>				
<b>QTY</b>	<b>THERMOSTAT</b>	<b>PART NO.</b>	<b>SIZE</b>	<b>DESCRIPTION</b>
2	Thermostat	FP-AR72852		Thermostat code 2202; 192 Deg.
2	Thermostat	FP-AR48675		Thermostat code 2204; 180 Deg.
1	Thermostat Cover Gasket	FP-R46479		Thermostat cover codes 2102, 2114, 2204, 3904, 3912; Two hole
1	Therm. Hsg. - Water Mfld. Gsk	FP-R86062		Thermostat housing to cyl. head
2	O-Ring	FP-R47153		Thermostat; Water manifold codes 3904, 3912
<b>QTY</b>	<b>MISCELLANEOUS</b>	<b>PART NO.</b>	<b>SIZE</b>	<b>DESCRIPTION</b>
1	Water Line Gasket	FP-R97346		To Ser. No. 100,770
2	Water Manifold Mounting Gskt.	FP-R88397		
<b>ENGINE BLOCK &amp; PARTS</b>				
<b>QTY</b>	<b>GASKETS</b>	<b>PART NO.</b>	<b>SIZE</b>	<b>DESCRIPTION</b>
1	Front Cover Gasket	FP-R125670		Aux. drive L.H. rear cover gskt.
1	Front Cover Gasket	FP-R104623		From Ser. No. 500,000
1	Front Cover Gasket	FP-R122143		Timing gear cover gskt.; To Ser. No. 499,999
1	Oil Pan Gasket	FP-R71918		
1	Oil Pan Gasket	FP-R49377		w/Alum. pan; Oil pan code 1909
1	Oil Pan Gasket	FP-R49377		6076A Engs.; w/Alum. pan; Oil pan codes 1906, 1908, 1916, 1922, 1953, 1954
1	Oil Pan Gasket Set	FP-PG400PS		6076A Engs.; To Ser. No. 499,999; w/Cast iron oil pan
1	Oil Pan Gasket Set	FP-PG401PS		6076T Engs.; From Ser. No. 180,071; w/Cast iron oil pan & rear sump
2	O-Ring	FP-U13639		Block coolant drain plug seal; Coolant heater codes 2601, 2602; 1.475" X .118"
<b>QTY</b>	<b>GASKET SETS</b>	<b>PART NO.</b>	<b>SIZE</b>	<b>DESCRIPTION</b>
1	In-Frame Gasket Set	FP-PG6076LS		From Ser. No. 500,000
1	In-Frame Gasket Set	FP-PG6076ES		To Ser. No. 499,999
1	Complete Overhaul Gasket Set	FP-RE64206		From Ser. No. 500,000; Crankshaft seals not incl.
1	Complete Overhaul Gasket Set	FP-RE64206WS		From Ser. No. 500,000; Incl. Crankshaft seals
1	Complete Overhaul Gasket Set	FP-RE35647		To Ser. No. 499,999; Crankshaft seals not incl.
1	Complete Overhaul Gasket Set	FP-RE35647WS		To Ser. No. 499,999; Incl. Crankshaft seals
<b>QTY</b>	<b>CAM BEARINGS</b>	<b>PART NO.</b>	<b>SIZE</b>	<b>DESCRIPTION</b>
1	Cam Brg.	FP-R87561		
<b>QTY</b>	<b>OIL COOLERS &amp; FILTERS</b>	<b>PART NO.</b>	<b>SIZE</b>	<b>DESCRIPTION</b>
1	Aftercooler Gasket Set	FP-6076A		6076A Engs.; To Ser. No. 100,770; w/housing No. R50398
1	Aftercooler Gasket Set	FP-6076ADP		6076A Engs.; Use w/housing Nos. R90995, R93918, R110232
2	Aftercooler Gasket	FP-R97347		6076A Engs.
2	Aftercooler Gasket	FP-R88993		6076A Engs.; From Ser. No. 100,177
1	O-Ring	FP-R52811		6076A Engs.; Intercooler inlet & outlet tube seals; Int. manifold code 1726; To Ser. No. 100,770
4	O-Ring	FP-R47153		Cooler tube
2	O-Ring	FP-R47153		Oil filter tube; Oil filter code 5931
1	Oil Cooler Bypass Gasket	FP-R65055		
1	Oil Cooler Cover Gasket	FP-R128558		From Ser. No. 500,000
1	Oil Cooler Cover Gasket	FP-R50419		To Ser. No. 499,999
1	Oil Cooler Housing Cover Gskt	FP-R128557		From Ser. No. 500,000
<b>CRANKSHAFT/OIL PUMP</b>				
<b>QTY</b>	<b>CRANKSHAFT</b>	<b>PART NO.</b>	<b>SIZE</b>	<b>DESCRIPTION</b>
1	Crankshaft	FP-RE53422		Gears incl.; Short snout 3.000"
1	Crankshaft	FP-AR96189		Gears not incl.
1	Oil Seal Kit	FP-SK49025		Incl. front & rear seals
<b>QTY</b>	<b>SEALS - FRONT CRANK</b>	<b>PART NO.</b>	<b>SIZE</b>	<b>DESCRIPTION</b>
1	Oil Seal Kit	FP-AR49025		
<b>QTY</b>	<b>SEALS - REAR CRANK</b>	<b>PART NO.</b>	<b>SIZE</b>	<b>DESCRIPTION</b>
1	Oil Seal	FP-RE22764		PTFE
<b>QTY</b>	<b>MAIN BEARINGS</b>	<b>PART NO.</b>	<b>SIZE</b>	<b>DESCRIPTION</b>
1	Main Set	FP-MBK400L4	STD	w/5 main brgs.
1	Main Set	FP-MBK400L410	10	w/5 main brgs.
1	Main Set	FP-MBK400L420	20	w/5 main brgs.
1	Main Set	FP-MBK400L6	STD	w/7 main brgs.
1	Main Set	FP-MBK400L610	10	w/7 main brgs.
1	Main Set	FP-MBK400L620	20	w/7 main brgs.
1	Main Set	FP-MBK400L630	30	w/7 main brgs.
5	Plain Main Brg.	FP-AR74814	STD	
5	Plain Main Brg.	FP-AR74816	10	
5	Plain Main Brg.	FP-AR74817	20	
5	Plain Main Brg.	FP-AR74818	30	

(continued on next page)

**30 Industrial Applications 6076A, 6076H, 6076T Engs.**  
 (cont.) 7.6L 465.9 (7638cc) OHV Turbo-Diesel L6 (Litre Engine), 115mm Bore

**CRANKSHAFT/OIL PUMP (cont.)**

QTY	MAIN BEARINGS (cont.)	PART NO.	SIZE	DESCRIPTION
1	Flanged Main Brg.	FP-AR77748	STD	
1	Flanged Main Brg.	FP-AR77750	10	
1	Flanged Main Brg.	FP-AR77751	20	
1	Flanged Main Brg.	FP-AR77752	30	
1	Thrust Washer Set	FP-AR77747	STD	

QTY	OIL PUMP	PART NO.	SIZE	DESCRIPTION
3	O-Ring	FP-U17409		Oil cooler relief valve plug seal; Filter & housing codes 5919, 5931
4	O-Ring	FP-R71732		Pump by-pass tubes; Pump codes 5001, 5003, 5004; w/Pump marked R62946, R124328
1	O-Ring	FP-R50405		Intake coupling; Large end; Int. manifold code 1735
1	Rect. or Square Seal	FP-R43660		Filter to housing; Filter & body code 5919; w/housing marked R120412
1	Oil Pump Intake Elbow Gasket	FP-R71312		w/Rear deep sump; Oil pump code 5003; Oil pan code 1906
1	Oil Filter to Block Gasket	FP-R43774		Filter housing code 5931

**CYLINDER COMPONENTS**

QTY	LINERS	PART NO.	SIZE	DESCRIPTION
6	Liner w/o Sealing Ring	FP-R87858		
6	Liner w/Sealing Rings	FP-R87858WS		
6	Cylinder Kit Complete	FP-RE60294	STD	w/Con. Rod marked R71074; From Ser. No. 500,000
6	Cylinder Kit Complete	FP-RE48739	STD	w/Con. Rod marked R71074; To Ser. No. 499,999
6	Cyl. Liner Sealing Ring Kit	FP-AR98850		

QTY	PISTONS	PART NO.	SIZE	DESCRIPTION
6	Piston Body w/o Pin	FP-RE57512	STD	From Ser. No. 500,000
6	Piston Body w/o Pin	FP-RE50868	STD	To Ser. No. 499,999
6	Piston Kit w/Pin & Retainers	FP-RE57512WP	STD	From Ser. No. 500,000
6	Piston Kit w/Pin & Retainers	FP-RE50868WP	STD	To Ser. No. 499,999
6	Pin	FP-R57771		
12	Piston Pin Retainer	FP-E1343FN		
6	Pin Bushing	FP-R74008		w/Con. Rod marked R71074; 1.877" ID, 2.0622 OD, 1.8728" O.A.L.

QTY	CONNECTING RODS & BRGS.	PART NO.	SIZE	DESCRIPTION
6	Rod Pair	FP-AR73277	STD	
6	Rod Pair	FP-AR73279	10	
6	Rod Pair	FP-AR73280	20	
6	Rod Pair	FP-AR73281	30	

QTY	PISTON RINGS	PART NO.	SIZE	DESCRIPTION
6	Ring Set Single Cylinder	FP-RE57517	STD	From Ser. No. 193,861
6	Ring Set Single Cylinder	FP-RE48380	STD	To Ser. No. 193,860; 2-5/32, 1-3/16 (1 cyl. set)

**KITS**

QTY	OVERHAUL KIT	PART NO.	SIZE	DESCRIPTION
1	In-Frame Overhaul Kit	FP-6076LIFK		w/Con. Rod marked R71074; From Ser. No. 500,000; Incl. Torque-To-Yield con. rod bolts
1	In-Frame Overhaul Kit	FP-6076EIFK		w/Con. Rod marked R71074; To Ser. No. 499,999; Incl. Torque-To-Yield con. rod bolts
1	Complete Overhaul Kit	FP-6076LOHK		w/Con. Rod marked R71074; From Ser. No. 500,000; Incl. Torque-To-Yield con. rod bolts
1	Complete Overhaul Kit	FP-6076EOHK		w/Con. Rod marked R71074; To Ser. No. 499,999; Incl. Torque-To-Yield con. rod bolts

**31 Industrial Applications 6081HN PowerTech Eng. (Natural Gas)**  
 8.1L 495.9 (8129cc) OHV Turbo-NG L6 (PowerTech 2V IC), 116mm Bore

**CYL. HEAD & PARTS**

QTY	GASKETS	PART NO.	SIZE	DESCRIPTION
1	Head Gasket	FP-RE55475		

QTY	VALVE	PART NO.	SIZE	DESCRIPTION
12	Valve Stem Cap	FP-T20129		Exh. & Int.
24	Keeper	FP-T20077		1 groove; Square cut key groove; Hardened

QTY	VALVE MISC.	PART NO.	SIZE	DESCRIPTION
12	Rotocap	FP-RE11410		Exh. & Int.
1	Oil Filler Cap Gasket	FP-R80135		Cover code 5205; L.H. Auxiliary drive
1	Oil Filler Cap Gasket	FP-T20328		Rocker arm cover codes 1105, 2912

(continued on next page)



**Industrial Applications 6081HN PowerTech Eng. (Natural Gas) 31**  
8.1L 495.9 (8129cc) OHV Turbo-NG L6 (PowerTech 2V IC), 116mm Bore (cont.)

<b>CAMSHAFT GROUP</b>				
<b>QTY</b>	<b>TIMING COVER</b>	<b>PART NO.</b>	<b>SIZE</b>	<b>DESCRIPTION</b>
1	Crankshaft Front Cover Gasket	FP-R26058		Rear
1	Timing Gear Cover Gasket	FP-R50390		Access cover
<b>FUEL SYSTEM &amp; PARTS</b>				
<b>QTY</b>	<b>TURBOCHARGER</b>	<b>PART NO.</b>	<b>SIZE</b>	<b>DESCRIPTION</b>
1	Turbocharger Oil Drain Gasket	FP-R105346		w/Turbo oil line codes 6501, 6502, 6504, 6505, 6506, 6507, 6508, 6510, 6511, 6512, 6513, 6529, 6530, 6531
1	Turbocharger Mounting Gasket	FP-R89879		
<b>COOLING SYSTEM</b>				
<b>QTY</b>	<b>WATER PUMP</b>	<b>PART NO.</b>	<b>SIZE</b>	<b>DESCRIPTION</b>
1	Water Pump Gasket	FP-R119383		Pump codes 2015, 5701; w/Pump housing marked R119795
1	Oil Seal	FP-RE39134		Water pump codes 2015, 5701; w/Pump housing marked R119795
1	Water Pump Filter	FP-R98527		w/Pump housing marked R119795
<b>QTY</b>	<b>THERMOSTAT</b>	<b>PART NO.</b>	<b>SIZE</b>	<b>DESCRIPTION</b>
2	Thermostat	FP-AR72852		Water manifold & thermostat codes 2114, 2202, 3901; 192 Deg.
1	Thermostat Gasket	FP-R124211		Water manifold & thermostat codes 2114, 2202, 3901
<b>QTY</b>	<b>MISCELLANEOUS</b>	<b>PART NO.</b>	<b>SIZE</b>	<b>DESCRIPTION</b>
2	Water Manifold Mounting Gskt.	FP-R88397		Water manifold & thermostat codes 2114, 2202, 3901
<b>ENGINE BLOCK &amp; PARTS</b>				
<b>QTY</b>	<b>GASKETS</b>	<b>PART NO.</b>	<b>SIZE</b>	<b>DESCRIPTION</b>
1	Front Cover Gasket	FP-R119384		Timing gear & front seal codes 6201, 7701
1	Oil Pan Gasket	FP-R49377		w/Alum. oil pan w/shallow sump; Oil pan code 1901
1	O-Ring	FP-U13639		Block coolant drain plug seal; Coolant heater code 2601; 1.475" X .118"
1	O-Ring	FP-R71596		Timing gear & front seal codes 6201, 7701; Plate seal
<b>QTY</b>	<b>GASKET SETS</b>	<b>PART NO.</b>	<b>SIZE</b>	<b>DESCRIPTION</b>
1	Complete Overhaul Gasket Set	FP-RE57187		Crankshaft seals not incl.
<b>QTY</b>	<b>CAM BEARINGS</b>	<b>PART NO.</b>	<b>SIZE</b>	<b>DESCRIPTION</b>
4	Cam Brg.	FP-R87561		
<b>QTY</b>	<b>OIL COOLERS &amp; FILTERS</b>	<b>PART NO.</b>	<b>SIZE</b>	<b>DESCRIPTION</b>
1	Oil Cooler	FP-AR55394		Oil cooler code 5901
1	Oil Cooler Bypass Gasket	FP-R109625		Adapter
1	Oil Cooler Housing Gasket	FP-AR58952		Oil cooler code 5901
2	Oil Cooler Adapter Gasket Set	FP-R50424		Oil cooler code 5901
<b>CRANKSHAFT/OIL PUMP</b>				
<b>QTY</b>	<b>CRANKSHAFT</b>	<b>PART NO.</b>	<b>SIZE</b>	<b>DESCRIPTION</b>
1	Oil Seal Kit	FP-SK49025		Incl. front & rear seals
<b>QTY</b>	<b>SEALS - FRONT CRANK</b>	<b>PART NO.</b>	<b>SIZE</b>	<b>DESCRIPTION</b>
1	Oil Seal Kit	FP-AR49025		Timing gear & front seal codes 6201, 7701
<b>QTY</b>	<b>SEALS - REAR CRANK</b>	<b>PART NO.</b>	<b>SIZE</b>	<b>DESCRIPTION</b>
1	Oil Seal	FP-RE22764		PTFE
<b>QTY</b>	<b>MAIN BEARINGS</b>	<b>PART NO.</b>	<b>SIZE</b>	<b>DESCRIPTION</b>
6	Plain Main Brg.	FP-RE529319	STD	
1	Flanged Main Brg.	FP-RE529320	STD	
<b>QTY</b>	<b>OIL PUMP</b>	<b>PART NO.</b>	<b>SIZE</b>	<b>DESCRIPTION</b>
4	O-Ring	FP-R71732		Oil cooler bypass tube seals
2	O-Ring	FP-U17409		Oil cooler relief valve plug seal; Filter & housing code 5901
1	O-Ring	FP-R72328		Rocker arm cover code 1110; Vent tube elbow seal
4	O-Ring	FP-R47153		Tube seal; Filter & housing code 5901
2	O-Ring	FP-R71732		Tube seal; Pump code 5002
1	Rect. or Square Seal	FP-R43660		Filter seal; Filter & housing code 5901
1	Oil Filter Seal Ring	FP-R26163		Turbocharger elbow seal
1	Oil Filter Base Gasket	FP-R119847		Filter & housing code 5901
<b>CYLINDER COMPONENTS</b>				
<b>QTY</b>	<b>LINERS</b>	<b>PART NO.</b>	<b>SIZE</b>	<b>DESCRIPTION</b>
6	Cyl. Liner Sealing Ring Kit	FP-AR98850		
<b>QTY</b>	<b>PISTONS</b>	<b>PART NO.</b>	<b>SIZE</b>	<b>DESCRIPTION</b>
6	Pin	FP-R57771		
12	Piston Pin Retainer	FP-E1343FN		
6	Pin Bushing	FP-R74008		1.877" ID, 2.0622 OD, 1.8728" O.A.L.

(continued on next page)

<b>31 Industrial Applications 6081HN PowerTech Eng. (Natural Gas)</b> (cont.) 8.1L 495.9 (8129cc) OHV Turbo-NG L6 (PowerTech 2V IC), 116mm Bore				
<b>CYLINDER COMPONENTS (cont.)</b>				
<b>QTY</b>	<b>CONNECTING RODS &amp; BRGS.</b>	<b>PART NO.</b>	<b>SIZE</b>	<b>DESCRIPTION</b>
12	Con. Rod Bolt	FP-R66452		w/Con. Rod marked R116340; Torque-To-Yield bolt; Replacement recommended
6	Rod Bearing Half Upper/Lower	FP-R525767	STD	
<b>32 Industrial Applications 6081H PowerTech Eng. (2-Valve Cyl. Head)</b> 8.1L 495.9 (8129cc) OHV Turbo-Diesel L6 (PowerTech 2V IC), 116mm Bore				
<b>CYL. HEAD &amp; PARTS</b>				
<b>QTY</b>	<b>GASKETS</b>	<b>PART NO.</b>	<b>SIZE</b>	<b>DESCRIPTION</b>
1	Valve Cover Gasket	FP-R49866		Rocker cover codes 1102, 1105, 2912
1	Head Gasket	FP-RE55475		
1	Head Set	FP-RE57186		
<b>QTY</b>	<b>VALVE</b>	<b>PART NO.</b>	<b>SIZE</b>	<b>DESCRIPTION</b>
6	Intake	FP-R84618	STD	1 groove; Chrome plated stem; 2.0080" Head Dia., .3730" Stem Dia., 6.0600" O.A.L.
6	Intake	FP-R93308	3	1 groove; Chrome plated stem; 2.0080" Head Dia., .3760" Stem Dia., 6.0600" O.A.L.
6	Exhaust	FP-R84619	STD	1 groove; Chrome plated stem; 1.8500" Head Dia., .3720" Stem Dia., 6.1780" O.A.L.
6	Exhaust	FP-R93311	3	1 groove; Chrome plated stem; 1.8500" Head Dia., .3750" Stem Dia., 6.1780" O.A.L.
12	Valve Stem Cap	FP-T20129		Exh. & Int.
24	Keeper	FP-T20077		Exh. & Int.; 1 groove; Square cut key groove; Hardened
<b>QTY</b>	<b>VALVE SEAT</b>	<b>PART NO.</b>	<b>SIZE</b>	<b>DESCRIPTION</b>
6	Exh.	FP-R119132	STD	
6	Exh.	FP-R93349	10	
6	Int.	FP-R121193	STD	
6	Int.	FP-R93350	10	
<b>QTY</b>	<b>VALVE SPRING</b>	<b>PART NO.</b>	<b>SIZE</b>	<b>DESCRIPTION</b>
12	Spring	FP-R91822		Exh. & Int.
<b>QTY</b>	<b>VALVE MISC.</b>	<b>PART NO.</b>	<b>SIZE</b>	<b>DESCRIPTION</b>
1	Oil Filler Cap Gasket	FP-T20328		Rocker arm cover codes 1105, 2912
<b>ELECTRICAL</b>				
<b>QTY</b>	<b>ALTERNATOR</b>	<b>PART NO.</b>	<b>SIZE</b>	<b>DESCRIPTION</b>
1	Ball Brg.	FP-JD9449		Front; Code 3143; 12 Volt, 90 amp alternator; Poly-Vee fan drive
<b>INT &amp; EXH MANIFOLDS</b>				
<b>QTY</b>	<b>INT. &amp; EXH. MANIFOLDS</b>	<b>PART NO.</b>	<b>SIZE</b>	<b>DESCRIPTION</b>
2	Exhaust Manifold Gasket	FP-R83020		Codes 2802, 3830; w/two holes; Two Exh. holes
2	Exhaust Manifold Gasket	FP-R83021		Codes 2802, 3830; One Exh. hole
3	Intake Manifold Gasket	FP-R130573		w/Int. manifolds R127427, R131652
<b>CAMSHAFT GROUP</b>				
<b>QTY</b>	<b>TIMING COVER</b>	<b>PART NO.</b>	<b>SIZE</b>	<b>DESCRIPTION</b>
1	Crankshaft Front Cover Gasket	FP-R26058		Housing to block gskt.
<b>FUEL SYSTEM &amp; PARTS</b>				
<b>QTY</b>	<b>FUEL INJECTION</b>	<b>PART NO.</b>	<b>SIZE</b>	<b>DESCRIPTION</b>
1	Washer	FP-R53899		Control valve to pump housing seal; Inj. pump housing connector codes 1616, 1621, 1632, 1633, 1634, 1635, 1636, 1641, 1655, 1657, 1658, 1659
2	Washer	FP-R53901		Fuel inj. pump connector seal; Filter & line codes 1603, 1604, 1605, 1607, 1608, 1609, 1610, 1611, 1612, 1613, 1615, 1617, 1618, 1619, 1620, 1622, 1623, 1624, 1640, 1656, 1676; w/Bosch pump
6	Washer	FP-R84472		Injector nozzle; Nozzle codes 1601, 1602, 1603, 1604, 1605, 1606, 1607, 1608, 1609, 1613, 1615, 1620, 1621, 1622, 1624, 1630, 1632, 1633, 1635, 1639, 1642, 1648, 1651, 1655, 1657, 1659, 1661, 1662, 1663, 1676; .290" X .715" X .079"
6	Fuel Injector Nut	FP-R79604		Injector line codes 1601, 1602
13	Washer Type Seal	FP-R51936		Fuel line; Line codes 1601, 1602, 1603, 1604, 1605, 1606, 1608, 1610, 1611, 1612, 1616, 1617, 1618, 1619, 1632, 1634, 1636, 1640, 1641, 1643, 1644, 1645, 1646, 1647, 1648, 1649, 1650, 1656, 1661, 1662, 1663, 1667

(continued on next page)

**Industrial Applications 6081H PowerTech Eng. (2-Valve Cyl. Head) 32**  
8.1L 495.9 (8129cc) OHV Turbo-Diesel L6 (PowerTech 2V IC), 116mm Bore (cont.)

<b>FUEL SYSTEM &amp; PARTS (cont.)</b>				
<b>QTY</b>	<b>TURBOCHARGER</b>	<b>PART NO.</b>	<b>SIZE</b>	<b>DESCRIPTION</b>
1	Turbocharger Oil Drain Gasket	FP-R105346		w/Turbo oil line codes 6501, 6503, 6504, 6505, 6506, 6507, 6508, 6510, 6511, 6512, 6513, 6529, 6530, 6531
1	Turbocharger Mounting Gasket	FP-R89879		
1	O-Ring	FP-R86743		Outer coupling
1	Turbo Exhaust Int. Cover Gskt	FP-R92097		Turbo code 6514
<b>COOLING SYSTEM</b>				
<b>QTY</b>	<b>WATER PUMP</b>	<b>PART NO.</b>	<b>SIZE</b>	<b>DESCRIPTION</b>
2	Ball Brg.	FP-JD10329		Fan hub shaft bearing
1	Water Pump Gasket	FP-R119383		w/Pump housing marked R119795; w/15 tooth gear; High flow
1	Water Pump Gasket	FP-R119383		w/Pump housing marked R119795; w/16 tooth gear; Low flow
1	Oil Seal	FP-RE39134		Water pump codes 2001, 2004; w/Pump housing marked R119795
1	Water Pump Hub	FP-JD10058		w/Fan Hub bearing codes 2305, 2306, 2335, 2336, 2337, 2338, 2339
1	Water Pump Filter	FP-R98527		w/Pump housing marked R119795
<b>QTY</b>	<b>THERMOSTAT</b>	<b>PART NO.</b>	<b>SIZE</b>	<b>DESCRIPTION</b>
2	Thermostat	FP-AR48675		Thermostat code 2204; 180 Deg.
1	Thermostat Gasket	FP-R124211		Thermostat housing to cyl. head
1	Thermostat Cover Gasket	FP-R46479		Thermostat cover codes 2102, 2114; Two hole
1	Therm. Hsg. - Water Mfld. Gsk	FP-R86062		Housing to cyl. head
<b>QTY</b>	<b>MISCELLANEOUS</b>	<b>PART NO.</b>	<b>SIZE</b>	<b>DESCRIPTION</b>
2	Water Manifold Mounting Gskt.	FP-R88397		
<b>ENGINE BLOCK &amp; PARTS</b>				
<b>QTY</b>	<b>GASKETS</b>	<b>PART NO.</b>	<b>SIZE</b>	<b>DESCRIPTION</b>
1	Front Cover Gasket	FP-R125670		Air compressor to timing cover; Midland or Holset
1	Front Cover Gasket	FP-R119384		Timing gear cover
1	Oil Pan Gasket	FP-R49377		w/Alum. pan; Oil pan codes 1906, 1909, 1914, 1916
1	Oil Pan Gasket	FP-R71918		w/Cast Iron pan
1	O-Ring	FP-U13639		Block coolant drain plug seal; Coolant heater codes 2601, 2602; 1.475" X .118"
<b>QTY</b>	<b>GASKET SETS</b>	<b>PART NO.</b>	<b>SIZE</b>	<b>DESCRIPTION</b>
1	Complete Overhaul Gasket Set	FP-RE57187		From Ser. No. 500,000; Crankshaft seals not incl.
<b>QTY</b>	<b>CAM BEARINGS</b>	<b>PART NO.</b>	<b>SIZE</b>	<b>DESCRIPTION</b>
4	Cam Brg.	FP-R87561		
<b>QTY</b>	<b>OIL COOLERS &amp; FILTERS</b>	<b>PART NO.</b>	<b>SIZE</b>	<b>DESCRIPTION</b>
1	Aftercooler Gasket	FP-R88993		w/Int. manifold codes 1703, 1738
2	Aftercooler Gasket	FP-R88993		w/Int. manifold codes 1705, 1737
1	Oil Cooler	FP-AR55394		
4	O-Ring	FP-R47153		Cooler tube; Cooler code 5901
4	O-Ring	FP-R47153		Oil filter tube; Filter code 5901
1	Oil Cooler Housing Gasket	FP-AR58952		
2	Oil Cooler Adapter Gasket Set	FP-R50424		
<b>CRANKSHAFT/OIL PUMP</b>				
<b>QTY</b>	<b>SEALS - FRONT CRANK</b>	<b>PART NO.</b>	<b>SIZE</b>	<b>DESCRIPTION</b>
1	Oil Seal Kit	FP-AR49025		
<b>QTY</b>	<b>SEALS - REAR CRANK</b>	<b>PART NO.</b>	<b>SIZE</b>	<b>DESCRIPTION</b>
1	Oil Seal	FP-RE22764		PTFE
<b>QTY</b>	<b>MAIN BEARINGS</b>	<b>PART NO.</b>	<b>SIZE</b>	<b>DESCRIPTION</b>
6	Plain Main Brg.	FP-RE529319	STD	
1	Flanged Main Brg.	FP-RE529320	STD	
<b>QTY</b>	<b>OIL PUMP</b>	<b>PART NO.</b>	<b>SIZE</b>	<b>DESCRIPTION</b>
2	O-Ring	FP-U17409		Oil cooler relief valve plug seal; Filter & housing code 5901
1	Oil Pump Intake Gasket	FP-R100569		Oil pump pickup codes 1906, 1909, 1916
1	Oil Filter Base Gasket	FP-R119847		Housing to block gskt.
<b>CYLINDER COMPONENTS</b>				
<b>QTY</b>	<b>LINERS</b>	<b>PART NO.</b>	<b>SIZE</b>	<b>DESCRIPTION</b>
6	Liner w/o Sealing Ring	FP-R520212	STD	
6	Cylinder Kit Complete	FP-RE508156 *	STD	For Low Compression Engines
6	Cylinder Kit Complete	FP-RE64509	STD	Use w/pistons marked RE64170, RE65289, RE70688; For High Compression Engines
6	Cyl. Liner Sealing Ring Kit	FP-AR98850		

(continued on next page)

<b>32 Industrial Applications 6081H PowerTech Eng. (2-Valve Cyl. Head)</b> (cont.) 8.1L 495.9 (8129cc) OHV Turbo-Diesel L6 (PowerTech 2V IC), 116mm Bore				
<b>CYLINDER COMPONENTS (cont.)</b>				
QTY	PISTONS	PART NO.	SIZE	DESCRIPTION
6	Piston Body w/o Pin	FP-RE516291 *	STD	For Low Compression Engines
6	Piston Body w/o Pin	FP-RE70688	STD	Used w/piston marked RE64170, RE65289, RE70088; For High Compression Engines
6	Pin	FP-R57771		
12	Piston Pin Retainer	FP-E1343FN		
6	Pin Bushing	FP-R74008		w/Con. Rod marked R11634, R501034; 1.877" ID, 2.0622 OD, 1.8728" O.A.L.
QTY	CONNECTING RODS & BRGS.	PART NO.	SIZE	DESCRIPTION
12	Con. Rod Bolt	FP-R66452		To Ser. No. 086,535; w/Con. Rod marked R116340; Torque-To-Yield bolt; Replacement recommended
6	Rod Bearing Half Upper/Lower	FP-R525767	STD	
QTY	PISTON RINGS	PART NO.	SIZE	DESCRIPTION
6	Ring Set Single Cylinder	FP-RE503528	STD	
<b>KITS</b>				
QTY	OVERHAUL KIT	PART NO.	SIZE	DESCRIPTION
1	In-Frame Overhaul Kit	FP-IFKPT6081		
1	Complete Overhaul Kit	FP-OHPT6081		
<b>33 Industrial Applications 6081A PowerTech Eng. (2-Valve Cyl. Head)</b> 8.1L 495.9 (8129cc) OHV Turbo-Diesel L6 (PowerTech 2V AC), 116mm Bore				
<b>CYL. HEAD &amp; PARTS</b>				
QTY	GASKETS	PART NO.	SIZE	DESCRIPTION
1	Valve Cover Gasket	FP-R49866		Rocker cover codes 1102, 1105, 2912
1	Head Gasket	FP-RE55475		
1	Head Set	FP-RE57186		
QTY	VALVE	PART NO.	SIZE	DESCRIPTION
6	Intake	FP-R84618	STD	1 groove; Chrome plated stem; 2.0080" Head Dia., .3730" Stem Dia., 6.0600" O.A.L.
6	Intake	FP-R93308	3	1 groove; Chrome plated stem; 2.0080" Head Dia., .3760" Stem Dia., 6.0600" O.A.L.
6	Exhaust	FP-R84619	STD	1 groove; Chrome plated stem; 1.8500" Head Dia., .3720" Stem Dia., 6.1780" O.A.L.
6	Exhaust	FP-R93311	3	1 groove; Chrome plated stem; 1.8500" Head Dia., .3750" Stem Dia., 6.1780" O.A.L.
12	Valve Stem Cap	FP-T20129		Exh. & Int.
24	Keeper	FP-T20077		Exh. & Int.; 1 groove; Square cut key groove; Hardened
QTY	VALVE SEAT	PART NO.	SIZE	DESCRIPTION
6	Exh.	FP-R119132	STD	
6	Exh.	FP-R93349	10	
6	Int.	FP-R121193	STD	
6	Int.	FP-R93350	10	
QTY	VALVE SPRING	PART NO.	SIZE	DESCRIPTION
12	Spring	FP-R91822		Exh. & Int.
QTY	VALVE MISC.	PART NO.	SIZE	DESCRIPTION
1	Oil Filler Cap Gasket	FP-T20328		Rocker arm cover codes 1105, 2912
<b>ELECTRICAL</b>				
QTY	ALTERNATOR	PART NO.	SIZE	DESCRIPTION
1	Ball Brg.	FP-JD9449		Front; Code 3143; 12 Volt, 90 amp alternator; Poly-Vee fan drive
<b>INT &amp; EXH MANIFOLDS</b>				
QTY	INT. & EXH. MANIFOLDS	PART NO.	SIZE	DESCRIPTION
2	Exhaust Manifold Gasket	FP-R83020		Codes 2802, 3830; w/two holes; Two Exh. holes
2	Exhaust Manifold Gasket	FP-R83021		Codes 2802, 3830; One Exh. hole
3	Intake Manifold Gasket	FP-R130573		w/Int. manifolds R127427, R131652
<b>CAMSHAFT GROUP</b>				
QTY	TIMING COVER	PART NO.	SIZE	DESCRIPTION
1	Crankshaft Front Cover Gasket	FP-R26058		Housing to block gskt.

(continued on next page)



**Industrial Applications 6081A PowerTech Eng. (2-Valve Cyl. Head) 33**  
8.1L 495.9 (8129cc) OHV Turbo-Diesel L6 (PowerTech 2V AC), 116mm Bore (cont.)

<b>FUEL SYSTEM &amp; PARTS</b>				
<b>QTY</b>	<b>FUEL INJECTION</b>	<b>PART NO.</b>	<b>SIZE</b>	<b>DESCRIPTION</b>
1	Washer	FP-R53899		Control valve to pump housing seal; Inj. pump housing connector codes 1616, 1621, 1632, 1633, 1634, 1635, 1636, 1641, 1655, 1657, 1658, 1659
2	Washer	FP-R53901		Fuel inj. pump connector seal; Filter & line codes 1603, 1604, 1605, 1607, 1608, 1609, 1610, 1611, 1612, 1613, 1615, 1617, 1618, 1619, 1620, 1622, 1623, 1624, 1640, 1656, 1676; w/Bosch pump
6	Washer	FP-R84472		Injector nozzle; Nozzle codes 1601, 1602, 1603, 1604, 1605, 1606, 1607, 1608, 1609, 1613, 1615, 1620, 1621, 1622, 1624, 1630, 1632, 1633, 1635, 1639, 1642, 1648, 1651, 1655, 1657, 1659, 1661, 1662, 1663, 1676; .290" X .715" X .079"
6	Fuel Injector Nut	FP-R79604		Injector line codes 1601, 1602
13	Washer Type Seal	FP-R51936		Fuel line; Line codes 1601, 1602, 1603, 1604, 1605, 1606, 1608, 1610, 1611, 1612, 1616, 1617, 1618, 1619, 1632, 1634, 1636, 1640, 1641, 1643, 1644, 1645, 1646, 1647, 1648, 1649, 1650, 1656, 1661, 1662, 1663, 1667
<b>TURBOCHARGER</b>				
<b>QTY</b>		<b>PART NO.</b>	<b>SIZE</b>	<b>DESCRIPTION</b>
1	Turbocharger Oil Drain Gasket	FP-R105346		w/Turbo oil line codes 6501, 6503, 6504, 6505, 6506, 6507, 6508, 6510, 6511, 6512, 6513, 6529, 6530, 6531
1	Turbocharger Mounting Gasket	FP-R89879		
1	O-Ring	FP-R86743		Outer coupling
1	Turbo Exhaust Int. Cover Gskt	FP-R92097		Turbo code 6514
<b>COOLING SYSTEM</b>				
<b>QTY</b>	<b>WATER PUMP</b>	<b>PART NO.</b>	<b>SIZE</b>	<b>DESCRIPTION</b>
2	Ball Brg.	FP-JD10329		Fan hub shaft bearing
1	Water Pump Gasket	FP-R119383		w/Pump housing marked R119795; w/15 tooth gear; High flow
1	Water Pump Gasket	FP-R119383		w/Pump housing marked R119795; w/16 tooth gear; Low flow
1	Oil Seal	FP-RE39134		Water pump codes 2001, 2004; w/Pump housing marked R119795
1	Water Pump Hub	FP-JD10058		w/Fan Hub bearing codes 2305, 2306, 2335, 2336, 2337, 2338, 2339
1	Water Pump Filter	FP-R98527		w/Pump housing marked R119795
<b>THERMOSTAT</b>				
<b>QTY</b>		<b>PART NO.</b>	<b>SIZE</b>	<b>DESCRIPTION</b>
2	Thermostat	FP-AR48675		Thermostat code 2204; 180 Deg.
1	Thermostat Gasket	FP-R124211		Thermostat housing to cyl. head
1	Thermostat Cover Gasket	FP-R46479		Thermostat cover codes 2102, 2114; Two hole
1	Therm. Hsg. - Water Mfld. Gsk	FP-R86062		Housing to cyl. head
<b>MISCELLANEOUS</b>				
<b>QTY</b>		<b>PART NO.</b>	<b>SIZE</b>	<b>DESCRIPTION</b>
2	Water Manifold Mounting Gskt.	FP-R88397		
<b>ENGINE BLOCK &amp; PARTS</b>				
<b>QTY</b>	<b>GASKETS</b>	<b>PART NO.</b>	<b>SIZE</b>	<b>DESCRIPTION</b>
1	Front Cover Gasket	FP-R125670		Air compressor to timing cover; Midland or Holset
1	Front Cover Gasket	FP-R119384		Timing gear cover
1	Oil Pan Gasket	FP-R49377		w/Alum. pan; Oil pan codes 1906, 1909, 1914, 1916
1	Oil Pan Gasket	FP-R71918		w/Cast Iron pan
1	O-Ring	FP-U13639		Block coolant drain plug seal; Coolant heater codes 2601, 2602; 1.475" X .118"
<b>GASKET SETS</b>				
<b>QTY</b>		<b>PART NO.</b>	<b>SIZE</b>	<b>DESCRIPTION</b>
1	Complete Overhaul Gasket Set	FP-RE57187		From Ser. No. 500,000; Crankshaft seals not incl.
<b>CAM BEARINGS</b>				
<b>QTY</b>		<b>PART NO.</b>	<b>SIZE</b>	<b>DESCRIPTION</b>
4	Cam Brg.	FP-R87561		
<b>OIL COOLERS &amp; FILTERS</b>				
<b>QTY</b>		<b>PART NO.</b>	<b>SIZE</b>	<b>DESCRIPTION</b>
1	Aftercooler Gasket	FP-R88993		w/Int. manifold codes 1703, 1738
2	Aftercooler Gasket	FP-R88993		w/Int. manifold codes 1705, 1737
1	Oil Cooler	FP-AR55394		
4	O-Ring	FP-R47153		Cooler tube; Cooler code 5901
4	O-Ring	FP-R47153		Oil filter tube; Filter code 5901
1	Oil Cooler Housing Gasket	FP-AR58952		
2	Oil Cooler Adapter Gasket Set	FP-R50424		
<b>CRANKSHAFT/OIL PUMP</b>				
<b>QTY</b>	<b>SEALS - FRONT CRANK</b>	<b>PART NO.</b>	<b>SIZE</b>	<b>DESCRIPTION</b>
1	Oil Seal Kit	FP-AR49025		
<b>QTY</b>	<b>SEALS - REAR CRANK</b>	<b>PART NO.</b>	<b>SIZE</b>	<b>DESCRIPTION</b>
1	Oil Seal	FP-RE22764		PTFE

(continued on next page)

<b>33 Industrial Applications 6081A PowerTech Eng. (2-Valve Cyl. Head)</b> (cont.) 8.1L 495.9 (8129cc) OHV Turbo-Diesel L6 (PowerTech 2V AC), 116mm Bore				
<b>CRANKSHAFT/OIL PUMP (cont.)</b>				
<b>QTY</b>	<b>MAIN BEARINGS</b>	<b>PART NO.</b>	<b>SIZE</b>	<b>DESCRIPTION</b>
6	Plain Main Brg.	FP-RE529319	STD	
1	Flanged Main Brg.	FP-RE529320	STD	
<b>QTY</b>	<b>OIL PUMP</b>	<b>PART NO.</b>	<b>SIZE</b>	<b>DESCRIPTION</b>
2	O-Ring	FP-U17409		Oil cooler relief valve plug seal; Filter & housing code 5901
1	Oil Pump Intake Gasket	FP-R100569		Oil pump pickup codes 1906, 1909, 1916
1	Oil Filter Base Gasket	FP-R119847		Housing to block gskt.
<b>CYLINDER COMPONENTS</b>				
<b>QTY</b>	<b>LINERS</b>	<b>PART NO.</b>	<b>SIZE</b>	<b>DESCRIPTION</b>
6	Liner w/o Sealing Ring	FP-R520212	STD	
6	Cylinder Kit Complete	FP-RE508156 *	STD	For Low Compression Engines
6	Cylinder Kit Complete	FP-RE64509	STD	Use w/pistons marked RE64170, RE65289, RE70688; For High Compression Engines
6	Cyl. Liner Sealing Ring Kit	FP-AR98850		
<b>QTY</b>	<b>PISTONS</b>	<b>PART NO.</b>	<b>SIZE</b>	<b>DESCRIPTION</b>
6	Piston Body w/o Pin	FP-RE516291 *	STD	For Low Compression Engines
6	Piston Body w/o Pin	FP-RE70688	STD	Used w/piston marked RE64170, RE65289, RE70688; For High Compression Engines
6	Pin	FP-R57771		
12	Piston Pin Retainer	FP-E1343FN		
6	Pin Bushing	FP-R74008		w/Con. Rod marked R11634, R501034; 1.877" ID, 2.0622 OD, 1.8728" O.A.L.
<b>QTY</b>	<b>CONNECTING RODS &amp; BRGS.</b>	<b>PART NO.</b>	<b>SIZE</b>	<b>DESCRIPTION</b>
12	Con. Rod Bolt	FP-R66452		To Ser. No. 086,535; w/Con. Rod marked R116340; Torque-To-Yield bolt; Replacement recommended
6	Rod Bearing Half Upper/Lower	FP-R525767	STD	
<b>QTY</b>	<b>PISTON RINGS</b>	<b>PART NO.</b>	<b>SIZE</b>	<b>DESCRIPTION</b>
6	Ring Set Single Cylinder	FP-RE503528	STD	
<b>KITS</b>				
<b>QTY</b>	<b>OVERHAUL KIT</b>	<b>PART NO.</b>	<b>SIZE</b>	<b>DESCRIPTION</b>
1	In-Frame Overhaul Kit	FP-IFKPT6081		
1	Complete Overhaul Kit	FP-OHPT6081		

**34 Industrial Applications 6081T Eng.**  
8.1L 495.9 (8129cc) OHV Turbo-Diesel L6 (Litre Engine), 116mm Bore

<b>CYL. HEAD &amp; PARTS</b>				
<b>QTY</b>	<b>GASKETS</b>	<b>PART NO.</b>	<b>SIZE</b>	<b>DESCRIPTION</b>
1	Valve Cover Gasket	FP-R49866		Rocker cover codes 1102, 1105, 2912
1	Head Gasket	FP-RE55475		
1	Head Set	FP-RE57186		
<b>QTY</b>	<b>VALVE</b>	<b>PART NO.</b>	<b>SIZE</b>	<b>DESCRIPTION</b>
6	Intake	FP-R84618	STD	1 groove; Chrome plated stem; 2.0080" Head Dia., .3730" Stem Dia., 6.0600" O.A.L.
6	Intake	FP-R93308	3	1 groove; Chrome plated stem; 2.0080" Head Dia., .3760" Stem Dia., 6.0600" O.A.L.
6	Exhaust	FP-R84619	STD	1 groove; Chrome plated stem; 1.8500" Head Dia., .3720" Stem Dia., 6.1780" O.A.L.
6	Exhaust	FP-R93311	3	1 groove; Chrome plated stem; 1.8500" Head Dia., .3750" Stem Dia., 6.1780" O.A.L.
12	Valve Stem Cap	FP-T20129		Exh. & Int.
24	Keeper	FP-T20077		Exh. & Int.; 1 groove; Square cut key groove; Hardened
<b>QTY</b>	<b>VALVE SEAT</b>	<b>PART NO.</b>	<b>SIZE</b>	<b>DESCRIPTION</b>
6	Exh.	FP-R119132	STD	
6	Exh.	FP-R93349	10	
6	Int.	FP-R121193	STD	
6	Int.	FP-R93350	10	
<b>QTY</b>	<b>VALVE SPRING</b>	<b>PART NO.</b>	<b>SIZE</b>	<b>DESCRIPTION</b>
12	Spring	FP-R91822		Exh. & Int.
<b>QTY</b>	<b>VALVE MISC.</b>	<b>PART NO.</b>	<b>SIZE</b>	<b>DESCRIPTION</b>
1	Oil Filler Cap Gasket	FP-T20328		Rocker arm cover codes 1105, 2912

(continued on next page)



*Industrial Applications 6081T Eng. 34*  
8.1L 495.9 (8129cc) OHV Turbo-Diesel L6 (Litre Engine), 116mm Bore (cont.)

<b>ELECTRICAL</b>				
<b>QTY</b>	<b>ALTERNATOR</b>	<b>PART NO.</b>	<b>SIZE</b>	<b>DESCRIPTION</b>
1	Ball Brg.	FP-JD9449		Front; Code 3143; 12 Volt, 90 amp alternator; Poly-Vee fan drive
<b>INT &amp; EXH MANIFOLDS</b>				
<b>QTY</b>	<b>INT. &amp; EXH. MANIFOLDS</b>	<b>PART NO.</b>	<b>SIZE</b>	<b>DESCRIPTION</b>
2	Exhaust Manifold Gasket	FP-R83020		Codes 2802, 3830; w/two holes; Two Exh. holes
2	Exhaust Manifold Gasket	FP-R83021		Codes 2802, 3830; One Exh. hole
3	Intake Manifold Gasket	FP-R130573		w/Int. manifolds R127427, R131652
<b>CAMSHAFT GROUP</b>				
<b>QTY</b>	<b>TIMING COVER</b>	<b>PART NO.</b>	<b>SIZE</b>	<b>DESCRIPTION</b>
1	Crankshaft Front Cover Gasket	FP-R26058		Housing to block gskt.
1	Timing Gear Cover Gasket	FP-R50390		Access cover
<b>FUEL SYSTEM &amp; PARTS</b>				
<b>QTY</b>	<b>FUEL INJECTION</b>	<b>PART NO.</b>	<b>SIZE</b>	<b>DESCRIPTION</b>
1	Washer	FP-R53899		Control valve to pump housing seal; Inj. pump housing connector codes 1616, 1621, 1632, 1633, 1634, 1635, 1636, 1641, 1655, 1657, 1658, 1659
2	Washer	FP-R53901		Fuel inj. pump connector seal; Filter & line codes 1603, 1604, 1605, 1607, 1608, 1609, 1610, 1611, 1612, 1613, 1615, 1617, 1618, 1619, 1620, 1622, 1623, 1624, 1640, 1656, 1676; w/Bosch pump
6	Washer	FP-R84472		Injector nozzle; Nozzle codes 1601, 1602, 1603, 1604, 1605, 1606, 1607, 1608, 1609, 1613, 1615, 1620, 1621, 1622, 1624, 1630, 1632, 1633, 1635, 1639, 1642, 1648, 1651, 1655, 1657, 1659, 1661, 1662, 1663, 1676; .290" X .715" X .079"
6	Fuel Injector Nut	FP-R79604		Injector line codes 1601, 1602
13	Washer Type Seal	FP-R51936		Fuel line; Line codes 1601, 1602, 1603, 1604, 1605, 1606, 1608, 1610, 1611, 1612, 1616, 1617, 1618, 1619, 1632, 1634, 1636, 1640, 1641, 1643, 1644, 1645, 1646, 1647, 1648, 1649, 1650, 1656, 1661, 1662, 1663, 1667
<b>QTY</b>	<b>TURBOCHARGER</b>	<b>PART NO.</b>	<b>SIZE</b>	<b>DESCRIPTION</b>
1	Turbocharger Oil Drain Gasket	FP-R105346		w/Turbo oil line codes 6501, 6503, 6504, 6505, 6506, 6507, 6508, 6510, 6511, 6512, 6513, 6529, 6530, 6531
1	Turbocharger Mounting Gasket	FP-R89879		
1	O-Ring	FP-R86743		Outer coupling
1	Turbo Exhaust Int. Cover Gskt	FP-R92097		Turbo code 6514
<b>COOLING SYSTEM</b>				
<b>QTY</b>	<b>WATER PUMP</b>	<b>PART NO.</b>	<b>SIZE</b>	<b>DESCRIPTION</b>
2	Ball Brg.	FP-JD10329		Fan hub shaft bearing
1	Water Pump Gasket	FP-R119383		w/Pump housing marked R119795; w/16 tooth gear; Low flow
1	Oil Seal	FP-RE39134		Water pump codes 2001, 2004; w/Pump housing marked R119795
1	Water Pump Hub	FP-JD10058		w/Fan Hub bearing codes 2305, 2306, 2335, 2336, 2337, 2338, 2339
1	Water Pump Filter	FP-R98527		w/Pump housing marked R119795
<b>QTY</b>	<b>THERMOSTAT</b>	<b>PART NO.</b>	<b>SIZE</b>	<b>DESCRIPTION</b>
2	Thermostat	FP-AR48675		Thermostat code 2204; 180 Deg.
1	Thermostat Gasket	FP-R124211		Thermostat housing to cyl. head
1	Thermostat Cover Gasket	FP-R46479		Thermostat cover codes 2102, 2114; Two hole
1	Therm. Hsg. - Water Mfld. Gsk	FP-R86062		Housing to cyl. head
<b>QTY</b>	<b>MISCELLANEOUS</b>	<b>PART NO.</b>	<b>SIZE</b>	<b>DESCRIPTION</b>
2	Water Manifold Mounting Gskt.	FP-R88397		
<b>ENGINE BLOCK &amp; PARTS</b>				
<b>QTY</b>	<b>GASKETS</b>	<b>PART NO.</b>	<b>SIZE</b>	<b>DESCRIPTION</b>
1	Front Cover Gasket	FP-R125670		Air compressor to timing cover; Midland or Holset
1	Front Cover Gasket	FP-R119384		Timing gear cover
1	Oil Pan Gasket	FP-R49377		w/Alum. pan; Oil pan codes 1906, 1909, 1914, 1916
1	Oil Pan Gasket	FP-R71918		w/Cast Iron pan
1	O-Ring	FP-U13639		Block coolant drain plug seal; Coolant heater codes 2601, 2602; 1.475" X .118"
<b>QTY</b>	<b>GASKET SETS</b>	<b>PART NO.</b>	<b>SIZE</b>	<b>DESCRIPTION</b>
1	In-Frame Gasket Set	FP-PG6081S		
1	Complete Overhaul Gasket Set	FP-RE57187		From Ser. No. 500,000; Crankshaft seals not incl.
<b>QTY</b>	<b>CAM BEARINGS</b>	<b>PART NO.</b>	<b>SIZE</b>	<b>DESCRIPTION</b>
4	Cam Brg.	FP-R87561		

(continued on next page)

## 34 Industrial Applications 6081T Eng. (cont.) 8.1L 495.9 (8129cc) OHV Turbo-Diesel L6 (Litre Engine), 116mm Bore

ENGINE BLOCK & PARTS (cont.)				
QTY	OIL COOLERS & FILTERS	PART NO.	SIZE	DESCRIPTION
1	Aftercooler Gasket	FP-R88993		
1	Oil Cooler	FP-AR55394		
4	O-Ring	FP-R47153		Cooler tube; Oil cooler & filter code 5901
4	O-Ring	FP-R47153		Oil filter tube; Oil cooler & filter code 5901
1	Oil Cooler Bypass Gasket	FP-R109625		Adapter
1	Oil Cooler Housing Gasket	FP-AR58952		
2	Oil Cooler Adapter Gasket Set	FP-R50424		
CRANKSHAFT/OIL PUMP				
QTY	SEALS - FRONT CRANK	PART NO.	SIZE	DESCRIPTION
1	Oil Seal Kit	FP-AR49025		
QTY	SEALS - REAR CRANK	PART NO.	SIZE	DESCRIPTION
1	Oil Seal	FP-RE22764		PTFE
QTY	OIL PUMP	PART NO.	SIZE	DESCRIPTION
2	O-Ring	FP-U17409		Oil cooler relief valve plug seal; Filter & housing code 5901
1	Oil Pump Intake Gasket	FP-R100569		Oil pump pickup codes 1906, 1909, 1916
1	Oil Filter Base Gasket	FP-R119847		Housing to block gskt.
CYLINDER COMPONENTS				
QTY	LINERS	PART NO.	SIZE	DESCRIPTION
6	Cyl. Liner Sealing Ring Kit	FP-AR98850		
QTY	PISTONS	PART NO.	SIZE	DESCRIPTION
6	Pin	FP-R57771		
12	Piston Pin Retainer	FP-E1343FN		
6	Pin Bushing	FP-R74008		w/Con. Rod marked R11634, R501034; 1.877" ID, 2.0622 OD, 1.8728" O.A.L.
QTY	CONNECTING RODS & BRGS.	PART NO.	SIZE	DESCRIPTION
12	Con. Rod Bolt	FP-R66452		To Ser. No. 086,535; w/Con. Rod marked R116340; Torque-To-Yield bolt; Replacement recommended
QTY	PISTON RINGS	PART NO.	SIZE	DESCRIPTION
6	Ring Set Single Cylinder	FP-RE503528	STD	
35 Industrial Applications 6081TN PowerTech Eng. (Natural Gas) 8.1L 495.9 (8129cc) OHV Turbo-NG L6 (PowerTech 2V), 116mm Bore				
CYL. HEAD & PARTS				
QTY	GASKETS	PART NO.	SIZE	DESCRIPTION
1	Head Gasket	FP-RE55475		
1	Head Set	FP-RE57186		
QTY	VALVE	PART NO.	SIZE	DESCRIPTION
12	Valve Stem Cap	FP-T20129		Exh. & Int.
24	Keeper	FP-T20077		1 groove; Square cut key groove; Hardened
QTY	VALVE MISC.	PART NO.	SIZE	DESCRIPTION
12	Rotocap	FP-RE11410		Exh. & Int.
1	Oil Filler Cap Gasket	FP-R80135		Cover code 5205; L.H. Auxiliary drive
CAMSHAFT GROUP				
QTY	TIMING COVER	PART NO.	SIZE	DESCRIPTION
1	Crankshaft Front Cover Gasket	FP-R26058		Rear
1	Timing Gear Cover Gasket	FP-R50390		Access cover
QTY	CAMSHAFT/LIFTER	PART NO.	SIZE	DESCRIPTION
1	Camshaft Plug	FP-R82007		
FUEL SYSTEM & PARTS				
QTY	TURBOCHARGER	PART NO.	SIZE	DESCRIPTION
1	Turbocharger Oil Drain Gasket	FP-R105346		
1	Turbocharger Mounting Gasket	FP-R89879		
COOLING SYSTEM				
QTY	WATER PUMP	PART NO.	SIZE	DESCRIPTION
1	Water Pump Gasket	FP-R119383		Pump codes 2015, 5701; w/Pump housing marked R119795
1	Oil Seal	FP-RE39134		Water pump codes 2015, 5701; w/Pump housing marked R119795
QTY	THERMOSTAT	PART NO.	SIZE	DESCRIPTION
2	Thermostat	FP-AR72852		Water manifold & thermostat codes 2114, 2202, 3901; 192 Deg.

(continued on next page)



**Industrial Applications 6081TN PowerTech Eng. (Natural Gas) 35**  
8.1L 495.9 (8129cc) OHV Turbo-NG L6 (PowerTech 2V), 116mm Bore (cont.)

<b>COOLING SYSTEM (cont.)</b>				
<b>QTY</b>	<b>THERMOSTAT</b> (cont.)	<b>PART NO.</b>	<b>SIZE</b>	<b>DESCRIPTION</b>
1	Thermostat Gasket	FP-R124211		Water manifold & thermostat codes 2114, 2202, 3901
<b>QTY</b>	<b>MISCELLANEOUS</b>	<b>PART NO.</b>	<b>SIZE</b>	<b>DESCRIPTION</b>
2	Water Manifold Mounting Gskt.	FP-R88397		Water manifold & thermostat codes 2114, 2202, 3901
<b>ENGINE BLOCK &amp; PARTS</b>				
<b>QTY</b>	<b>GASKETS</b>	<b>PART NO.</b>	<b>SIZE</b>	<b>DESCRIPTION</b>
1	Front Cover Gasket	FP-R119384		Timing gear & front seal codes 6201, 7701
1	Oil Pan Gasket	FP-R49377		w/Alum. oil pan w/shallow sump; Oil pan code 1901
1	O-Ring	FP-U13639		Block coolant drain plug seal; Coolant heater code 2601; 1.475" X .118"
1	O-Ring	FP-R71596		Timing gear & front seal codes 6201, 7701; Plate seal
<b>QTY</b>	<b>GASKET SETS</b>	<b>PART NO.</b>	<b>SIZE</b>	<b>DESCRIPTION</b>
1	Complete Overhaul Gasket Set	FP-RE57187		Crankshaft seals not incl.
<b>QTY</b>	<b>CAM BEARINGS</b>	<b>PART NO.</b>	<b>SIZE</b>	<b>DESCRIPTION</b>
4	Cam Brg.	FP-R87561		
<b>QTY</b>	<b>OIL COOLERS &amp; FILTERS</b>	<b>PART NO.</b>	<b>SIZE</b>	<b>DESCRIPTION</b>
1	Oil Cooler Bypass Gasket	FP-R109625		Adapter
1	Oil Cooler Housing Gasket	FP-AR58952		Oil cooler code 5901
2	Oil Cooler Adapter Gasket Set	FP-R50424		Oil cooler code 5901
<b>CRANKSHAFT/OIL PUMP</b>				
<b>QTY</b>	<b>SEALS - FRONT CRANK</b>	<b>PART NO.</b>	<b>SIZE</b>	<b>DESCRIPTION</b>
1	Oil Seal Kit	FP-AR49025		Timing gear & front seal codes 6201, 7701
<b>QTY</b>	<b>SEALS - REAR CRANK</b>	<b>PART NO.</b>	<b>SIZE</b>	<b>DESCRIPTION</b>
1	Oil Seal	FP-RE22764		PTFE
<b>QTY</b>	<b>MAIN BEARINGS</b>	<b>PART NO.</b>	<b>SIZE</b>	<b>DESCRIPTION</b>
6	Plain Main Brg.	FP-RE529319	STD	
1	Flanged Main Brg.	FP-RE529320	STD	
<b>QTY</b>	<b>OIL PUMP</b>	<b>PART NO.</b>	<b>SIZE</b>	<b>DESCRIPTION</b>
4	O-Ring	FP-R71732		Oil cooler bypass tube seals
2	O-Ring	FP-U17409		Oil cooler relief valve plug seal; Filter & housing code 5901
1	O-Ring	FP-R72328		Rocker arm cover code 1110; Vent tube elbow seal
4	O-Ring	FP-R47153		Tube seal; Filter & housing code 5901
2	O-Ring	FP-R71732		Tube seal; Pump code 5002
1	Rect. or Square Seal	FP-R43660		Filter seal; Filter & housing code 5901
1	Oil Filter Seal Ring	FP-R26163		Turbocharger elbow seal
1	Oil Filter Base Gasket	FP-R119847		Filter & housing code 5901
<b>CYLINDER COMPONENTS</b>				
<b>QTY</b>	<b>LINERS</b>	<b>PART NO.</b>	<b>SIZE</b>	<b>DESCRIPTION</b>
6	Cyl. Liner Sealing Ring Kit	FP-AR98850		
<b>QTY</b>	<b>PISTONS</b>	<b>PART NO.</b>	<b>SIZE</b>	<b>DESCRIPTION</b>
6	Pin	FP-R57771		
12	Piston Pin Retainer	FP-E1343FN		
6	Pin Bushing	FP-R74008		1.877" ID, 2.0622 OD, 1.8728" O.A.L.
<b>QTY</b>	<b>CONNECTING RODS &amp; BRGS.</b>	<b>PART NO.</b>	<b>SIZE</b>	<b>DESCRIPTION</b>
12	Con. Rod Bolt	FP-R66452		w/Con. Rod marked R116340; Torque-To-Yield bolt; Replacement recommended
6	Rod Bearing Half Upper/Lower	FP-R525767	STD	
<b>Industrial Applications 6081T PowerTech Eng. 36</b> 8.1L 495.9 (8129cc) OHV Turbo-Diesel L6 (PowerTech 2V), 116mm Bore				
<b>CYL. HEAD &amp; PARTS</b>				
<b>QTY</b>	<b>GASKETS</b>	<b>PART NO.</b>	<b>SIZE</b>	<b>DESCRIPTION</b>
1	Valve Cover Gasket	FP-R49866		Rocker cover codes 1102, 1105, 2912
1	Head Gasket	FP-RE55475		
1	Head Set	FP-RE57186		
<b>QTY</b>	<b>VALVE</b>	<b>PART NO.</b>	<b>SIZE</b>	<b>DESCRIPTION</b>
6	Intake	FP-R84618	STD	1 groove; Chrome plated stem; 2.0080" Head Dia., .3730" Stem Dia., 6.0600" O.A.L.
6	Intake	FP-R93308	3	1 groove; Chrome plated stem; 2.0080" Head Dia., .3760" Stem Dia., 6.0600" O.A.L.

(continued on next page)

<b>36 Industrial Applications 6081T PowerTech Eng.</b>				
<b>(cont.) 8.1L 495.9 (8129cc) OHV Turbo-Diesel L6 (PowerTech 2V), 116mm Bore</b>				
<b>CYL. HEAD &amp; PARTS (cont.)</b>				
<b>QTY</b>	<b>VALVE (cont.)</b>	<b>PART NO.</b>	<b>SIZE</b>	<b>DESCRIPTION</b>
6	Exhaust	FP-R84619	STD	1 groove; Chrome plated stem; 1.8500" Head Dia., .3720" Stem Dia., 6.1780" O.A.L.
6	Exhaust	FP-R93311	3	1 groove; Chrome plated stem; 1.8500" Head Dia., .3750" Stem Dia., 6.1780" O.A.L.
12	Valve Stem Cap	FP-T20129		Exh. & Int.
24	Keeper	FP-T20077		Exh. & Int.; 1 groove; Square cut key groove; Hardened
<b>QTY</b>	<b>VALVE SEAT</b>	<b>PART NO.</b>	<b>SIZE</b>	<b>DESCRIPTION</b>
6	Exh.	FP-R119132	STD	
6	Exh.	FP-R93349	10	
6	Int.	FP-R121193	STD	
6	Int.	FP-R93350	10	
<b>QTY</b>	<b>VALVE SPRING</b>	<b>PART NO.</b>	<b>SIZE</b>	<b>DESCRIPTION</b>
12	Spring	FP-R91822		Exh. & Int.
<b>QTY</b>	<b>VALVE MISC.</b>	<b>PART NO.</b>	<b>SIZE</b>	<b>DESCRIPTION</b>
1	Oil Filler Cap Gasket	FP-T20328		Rocker arm cover codes 1105, 2912
<b>ELECTRICAL</b>				
<b>QTY</b>	<b>ALTERNATOR</b>	<b>PART NO.</b>	<b>SIZE</b>	<b>DESCRIPTION</b>
1	Ball Brg.	FP-JD9449		Front; Code 3143; 12 Volt, 90 amp alternator; Poly-Vee fan drive
<b>INT &amp; EXH MANIFOLDS</b>				
<b>QTY</b>	<b>INT. &amp; EXH. MANIFOLDS</b>	<b>PART NO.</b>	<b>SIZE</b>	<b>DESCRIPTION</b>
2	Exhaust Manifold Gasket	FP-R83020		Codes 2802, 3830; w/two holes; Two Exh. holes
2	Exhaust Manifold Gasket	FP-R83021		Codes 2802, 3830; One Exh. hole
3	Intake Manifold Gasket	FP-R130573		w/Int. manifolds R127427, R131652
<b>CAMSHAFT GROUP</b>				
<b>QTY</b>	<b>TIMING COVER</b>	<b>PART NO.</b>	<b>SIZE</b>	<b>DESCRIPTION</b>
1	Crankshaft Front Cover Gasket	FP-R26058		Housing to block gskt.
<b>FUEL SYSTEM &amp; PARTS</b>				
<b>QTY</b>	<b>FUEL INJECTION</b>	<b>PART NO.</b>	<b>SIZE</b>	<b>DESCRIPTION</b>
1	Washer	FP-R53899		Control valve to pump housing seal; Inj. pump housing connector codes 1616, 1621, 1632, 1633, 1634, 1635, 1636, 1641, 1655, 1657, 1658, 1659
2	Washer	FP-R53901		Fuel inj. pump connector seal; Filter & line codes 1603, 1604, 1605, 1607, 1608, 1609, 1610, 1611, 1612, 1613, 1615, 1617, 1618, 1619, 1620, 1622, 1623, 1624, 1640, 1656, 1676; w/Bosch pump
6	Washer	FP-R84472		Injector nozzle; Nozzle codes 1601, 1602, 1603, 1604, 1605, 1606, 1607, 1608, 1609, 1613, 1615, 1620, 1621, 1622, 1624, 1630, 1632, 1633, 1635, 1639, 1642, 1648, 1651, 1655, 1657, 1659, 1661, 1662, 1663, 1676; .290" X .715" X .079"
6	Fuel Injector Nut	FP-R79604		Injector line codes 1601, 1602
13	Washer Type Seal	FP-R51936		Fuel line; Line codes 1601, 1602, 1603, 1604, 1605, 1606, 1608, 1610, 1611, 1612, 1616, 1617, 1618, 1619, 1632, 1634, 1636, 1640, 1641, 1643, 1644, 1645, 1646, 1647, 1648, 1649, 1650, 1656, 1661, 1662, 1663, 1667
<b>QTY</b>	<b>TURBOCHARGER</b>	<b>PART NO.</b>	<b>SIZE</b>	<b>DESCRIPTION</b>
1	Turbocharger Oil Drain Gasket	FP-R105346		w/Turbo oil line codes 6501, 6503, 6504, 6505, 6506, 6507, 6508, 6510, 6511, 6512, 6513, 6529, 6530, 6531
1	Turbocharger Mounting Gasket	FP-R89879		
1	O-Ring	FP-R86743		Outer coupling
1	Turbo Exhaust Int. Cover Gskt	FP-R92097		Turbo code 6514
<b>COOLING SYSTEM</b>				
<b>QTY</b>	<b>WATER PUMP</b>	<b>PART NO.</b>	<b>SIZE</b>	<b>DESCRIPTION</b>
2	Ball Brg.	FP-JD10329		Fan hub shaft bearing
1	Water Pump Gasket	FP-R119383		w/Pump housing marked R119795; w/15 tooth gear; High flow
1	Water Pump Gasket	FP-R119383		w/Pump housing marked R119795; w/16 tooth gear; Low flow
1	Oil Seal	FP-RE39134		Water pump codes 2001, 2004; w/Pump housing marked R119795
1	Water Pump Hub	FP-JD10058		w/Fan Hub bearing codes 2305, 2306, 2335, 2336, 2337, 2338, 2339
1	Water Pump Filter	FP-R98527		w/Pump housing marked R119795
<b>QTY</b>	<b>THERMOSTAT</b>	<b>PART NO.</b>	<b>SIZE</b>	<b>DESCRIPTION</b>
2	Thermostat	FP-AR48675		Thermostat code 2204; 180 Deg.
1	Thermostat Gasket	FP-R124211		Thermostat housing to cyl. head

(continued on next page)



*Industrial Applications 6081T PowerTech Eng. 36*  
8.1L 495.9 (8129cc) OHV Turbo-Diesel L6 (PowerTech 2V), 116mm Bore (cont.)

<b>COOLING SYSTEM (cont.)</b>				
<b>QTY</b>	<b>THERMOSTAT (cont.)</b>	<b>PART NO.</b>	<b>SIZE</b>	<b>DESCRIPTION</b>
1	Thermostat Cover Gasket	FP-R46479		Thermostat cover codes 2102, 2114; Two hole
1	Therm. Hsg. - Water Mfld. Gsk	FP-R86062		Housing to cyl. head
<b>QTY</b>	<b>MISCELLANEOUS</b>	<b>PART NO.</b>	<b>SIZE</b>	<b>DESCRIPTION</b>
2	Water Manifold Mounting Gskt.	FP-R88397		
<b>ENGINE BLOCK &amp; PARTS</b>				
<b>QTY</b>	<b>GASKETS</b>	<b>PART NO.</b>	<b>SIZE</b>	<b>DESCRIPTION</b>
1	Front Cover Gasket	FP-R125670		Air compressor to timing cover; Midland or Holset
1	Front Cover Gasket	FP-R119384		Timing gear cover
1	Oil Pan Gasket	FP-R49377		w/Alum. pan; Oil pan codes 1906, 1909, 1914, 1916
1	Oil Pan Gasket	FP-R71918		w/Cast Iron pan
1	O-Ring	FP-U13639		Block coolant drain plug seal; Coolant heater codes 2601, 2602; 1.475" X .118"
<b>QTY</b>	<b>GASKET SETS</b>	<b>PART NO.</b>	<b>SIZE</b>	<b>DESCRIPTION</b>
1	Complete Overhaul Gasket Set	FP-RE57187		From Ser. No. 500,000; Crankshaft seals not incl.
<b>QTY</b>	<b>CAM BEARINGS</b>	<b>PART NO.</b>	<b>SIZE</b>	<b>DESCRIPTION</b>
4	Cam Brg.	FP-R87561		
<b>QTY</b>	<b>OIL COOLERS &amp; FILTERS</b>	<b>PART NO.</b>	<b>SIZE</b>	<b>DESCRIPTION</b>
1	Aftercooler Gasket	FP-R88993		w/Int. manifold codes 1703, 1738
2	Aftercooler Gasket	FP-R88993		w/Int. manifold codes 1705, 1737
1	Oil Cooler	FP-AR55394		
4	O-Ring	FP-R47153		Cooler tube; Cooler code 5901
4	O-Ring	FP-R47153		Oil filter tube; Filter code 5901
1	Oil Cooler Housing Gasket	FP-AR58952		
2	Oil Cooler Adapter Gasket Set	FP-R50424		
<b>CRANKSHAFT/OIL PUMP</b>				
<b>QTY</b>	<b>SEALS - FRONT CRANK</b>	<b>PART NO.</b>	<b>SIZE</b>	<b>DESCRIPTION</b>
1	Oil Seal Kit	FP-AR49025		
<b>QTY</b>	<b>SEALS - REAR CRANK</b>	<b>PART NO.</b>	<b>SIZE</b>	<b>DESCRIPTION</b>
1	Oil Seal	FP-RE22764		PTFE
<b>QTY</b>	<b>MAIN BEARINGS</b>	<b>PART NO.</b>	<b>SIZE</b>	<b>DESCRIPTION</b>
6	Plain Main Brg.	FP-RE529319	STD	
1	Flanged Main Brg.	FP-RE529320	STD	
<b>QTY</b>	<b>OIL PUMP</b>	<b>PART NO.</b>	<b>SIZE</b>	<b>DESCRIPTION</b>
2	O-Ring	FP-U17409		Oil cooler relief valve plug seal; Filter & housing code 5901
1	Oil Pump Intake Gasket	FP-R100569		Oil pump pickup codes 1906, 1909, 1916
1	Oil Filter Base Gasket	FP-R119847		Housing to block gskt.
<b>CYLINDER COMPONENTS</b>				
<b>QTY</b>	<b>LINERS</b>	<b>PART NO.</b>	<b>SIZE</b>	<b>DESCRIPTION</b>
6	Liner w/o Sealing Ring	FP-R520212	STD	
6	Cylinder Kit Complete	FP-RE508156 *	STD	For Low Compression Engines
6	Cylinder Kit Complete	FP-RE64509	STD	Use w/pistons marked RE64170, RE65289, RE70688; For High Compression Engines
6	Cyl. Liner Sealing Ring Kit	FP-AR98850		
<b>QTY</b>	<b>PISTONS</b>	<b>PART NO.</b>	<b>SIZE</b>	<b>DESCRIPTION</b>
6	Piston Body w/o Pin	FP-RE516291 *	STD	For Low Compression Engines
6	Piston Body w/o Pin	FP-RE70688	STD	Used w/piston marked RE64170, RE65289, RE70688; For High Compression Engines
6	Pin	FP-R57771		
12	Piston Pin Retainer	FP-E1343FN		
6	Pin Bushing	FP-R74008		w/Con. Rod marked R11634, R501034; 1.877" ID, 2.0622 OD, 1.8728" O.A.L.
<b>QTY</b>	<b>CONNECTING RODS &amp; BRGS.</b>	<b>PART NO.</b>	<b>SIZE</b>	<b>DESCRIPTION</b>
12	Con. Rod Bolt	FP-R66452		To Ser. No. 086,535; w/Con. Rod marked R116340; Torque-To-Yield bolt; Replacement recommended
6	Rod Bearing Half Upper/Lower	FP-R525767	STD	
<b>QTY</b>	<b>PISTON RINGS</b>	<b>PART NO.</b>	<b>SIZE</b>	<b>DESCRIPTION</b>
6	Ring Set Single Cylinder	FP-RE503528	STD	
<b>KITS</b>				
<b>QTY</b>	<b>OVERHAUL KIT</b>	<b>PART NO.</b>	<b>SIZE</b>	<b>DESCRIPTION</b>
1	In-Frame Overhaul Kit	FP-IFKPT6081		

(continued on next page)

\* New Item — Check For Availability

<b>36 Industrial Applications 6081T PowerTech Eng.</b> (cont.) 8.1L 495.9 (8129cc) OHV Turbo-Diesel L6 (PowerTech 2V), 116mm Bore				
<b>KITS (cont.)</b>				
<b>QTY</b>	<b>OVERHAUL KIT</b> (cont.)	<b>PART NO.</b>	<b>SIZE</b>	<b>DESCRIPTION</b>
1	Complete Overhaul Kit	FP-OHPT6081		
<b>37 Industrial Applications 6090H Eng.</b> 9.0L 549 (9000cc) OHV Turbo-Diesel L6 (PowerTech 4V IC), 118.4mm Bore				
<b>CYL. HEAD &amp; PARTS</b>				
<b>QTY</b>	<b>VALVE</b>	<b>PART NO.</b>	<b>SIZE</b>	<b>DESCRIPTION</b>
12	Intake	FP-R520223	STD	1 groove; Chrome plated stem; 1.5748" Head Dia., .3142" Stem Dia., 6.4154" O.A.L.
12	Exhaust	FP-R520224	STD	1 groove; Inconel X-751; Chrome plated stem; 1.5748" Head Dia., .3142" Stem Dia., 6.4201" O.A.L.
<b>QTY</b>	<b>VALVE SEAT</b>	<b>PART NO.</b>	<b>SIZE</b>	<b>DESCRIPTION</b>
24	Exh. & Int.	FP-R527285 *	STD	
<b>QTY</b>	<b>VALVE GUIDE</b>	<b>PART NO.</b>	<b>SIZE</b>	<b>DESCRIPTION</b>
24	Guide	FP-R527286 *		
<b>QTY</b>	<b>VALVE SPRING</b>	<b>PART NO.</b>	<b>SIZE</b>	<b>DESCRIPTION</b>
24	Spring	FP-R504235		
<b>CAMSHAFT GROUP</b>				
<b>QTY</b>	<b>CAMSHAFT/LIFTER</b>	<b>PART NO.</b>	<b>SIZE</b>	<b>DESCRIPTION</b>
1	Camshaft Plug	FP-R82007		
<b>ENGINE BLOCK &amp; PARTS</b>				
<b>QTY</b>	<b>CAM BEARINGS</b>	<b>PART NO.</b>	<b>SIZE</b>	<b>DESCRIPTION</b>
6	Cam Brg.	FP-R527877 *	STD	
<b>CRANKSHAFT/OIL PUMP</b>				
<b>QTY</b>	<b>MAIN BEARINGS</b>	<b>PART NO.</b>	<b>SIZE</b>	<b>DESCRIPTION</b>
6	Plain Main Brg.	FP-RE529319	STD	
1	Flanged Main Brg.	FP-RE529320	STD	
<b>QTY</b>	<b>OIL PUMP</b>	<b>PART NO.</b>	<b>SIZE</b>	<b>DESCRIPTION</b>
1	Oil Pump Intake Gasket	FP-R100569		
<b>CYLINDER COMPONENTS</b>				
<b>QTY</b>	<b>LINERS</b>	<b>PART NO.</b>	<b>SIZE</b>	<b>DESCRIPTION</b>
6	Cyl. Liner Sealing Ring Kit	FP-AR98850		
<b>QTY</b>	<b>PISTONS</b>	<b>PART NO.</b>	<b>SIZE</b>	<b>DESCRIPTION</b>
6	Pin	FP-R517073 *	STD	
6	Pin Bushing	FP-R74008		1.877" ID, 2.0622 OD, 1.8728" O.A.L.
<b>QTY</b>	<b>CONNECTING RODS &amp; BRGS.</b>	<b>PART NO.</b>	<b>SIZE</b>	<b>DESCRIPTION</b>
12	Con. Rod Bolt	FP-R501035		Fractured split rod
6	Rod Pair	FP-RE529318 *	STD	
<b>QTY</b>	<b>PISTON RINGS</b>	<b>PART NO.</b>	<b>SIZE</b>	<b>DESCRIPTION</b>
6	Ring Set Single Cylinder	FP-RE531077 *	STD	
<b>38 Industrial Applications 6090A Eng.</b> 9.0L 549 (9000cc) OHV Turbo-Diesel L6 (PowerTech 4V AC), 118.4mm Bore				
<b>CYL. HEAD &amp; PARTS</b>				
<b>QTY</b>	<b>VALVE</b>	<b>PART NO.</b>	<b>SIZE</b>	<b>DESCRIPTION</b>
12	Intake	FP-R520223	STD	1 groove; Chrome plated stem; 1.5748" Head Dia., .3142" Stem Dia., 6.4154" O.A.L.
12	Exhaust	FP-R520224	STD	1 groove; Inconel X-751; Chrome plated stem; 1.5748" Head Dia., .3142" Stem Dia., 6.4201" O.A.L.
<b>QTY</b>	<b>VALVE SEAT</b>	<b>PART NO.</b>	<b>SIZE</b>	<b>DESCRIPTION</b>
24	Exh. & Int.	FP-R527285 *	STD	
<b>QTY</b>	<b>VALVE GUIDE</b>	<b>PART NO.</b>	<b>SIZE</b>	<b>DESCRIPTION</b>
24	Guide	FP-R527286 *		
<b>QTY</b>	<b>VALVE SPRING</b>	<b>PART NO.</b>	<b>SIZE</b>	<b>DESCRIPTION</b>
24	Spring	FP-R504235		
<b>CAMSHAFT GROUP</b>				
<b>QTY</b>	<b>CAMSHAFT/LIFTER</b>	<b>PART NO.</b>	<b>SIZE</b>	<b>DESCRIPTION</b>
1	Camshaft Plug	FP-R82007		

(continued on next page)





*Industrial Applications 6090A Eng. 38*  
9.0L 549 (9000cc) OHV Turbo-Diesel L6 (PowerTech 4V AC), 118.4mm Bore (cont.)

<b>ENGINE BLOCK &amp; PARTS</b>				
<b>QTY</b>	<b>CAM BEARINGS</b>	<b>PART NO.</b>	<b>SIZE</b>	<b>DESCRIPTION</b>
6	Cam Brg.	FP-R527877 *	STD	
<b>CRANKSHAFT/OIL PUMP</b>				
<b>QTY</b>	<b>MAIN BEARINGS</b>	<b>PART NO.</b>	<b>SIZE</b>	<b>DESCRIPTION</b>
6	Plain Main Brg.	FP-RE529319	STD	
1	Flanged Main Brg.	FP-RE529320	STD	
<b>QTY</b>	<b>OIL PUMP</b>	<b>PART NO.</b>	<b>SIZE</b>	<b>DESCRIPTION</b>
1	Oil Pump Intake Gasket	FP-R100569		
<b>CYLINDER COMPONENTS</b>				
<b>QTY</b>	<b>LINERS</b>	<b>PART NO.</b>	<b>SIZE</b>	<b>DESCRIPTION</b>
6	Cyl. Liner Sealing Ring Kit	FP-AR98850		
<b>QTY</b>	<b>PISTONS</b>	<b>PART NO.</b>	<b>SIZE</b>	<b>DESCRIPTION</b>
6	Pin	FP-R517073 *	STD	
6	Pin Bushing	FP-R74008		1.877" ID, 2.0622 OD, 1.8728" O.A.L.
<b>QTY</b>	<b>CONNECTING RODS &amp; BRGS.</b>	<b>PART NO.</b>	<b>SIZE</b>	<b>DESCRIPTION</b>
12	Con. Rod Bolt	FP-R501035		Fractured split rod
6	Rod Pair	FP-RE529318 *	STD	
<b>QTY</b>	<b>PISTON RINGS</b>	<b>PART NO.</b>	<b>SIZE</b>	<b>DESCRIPTION</b>
6	Ring Set Single Cylinder	FP-RE531077 *	STD	

*Industrial Applications 6090T Eng. 39*  
9.0L 549 (9000cc) OHV Turbo-Diesel L6 (PowerTech 4V), 118.4mm Bore

<b>CYL. HEAD &amp; PARTS</b>				
<b>QTY</b>	<b>VALVE</b>	<b>PART NO.</b>	<b>SIZE</b>	<b>DESCRIPTION</b>
12	Intake	FP-R520223	STD	1 groove; Chrome plated stem; 1.5748" Head Dia., .3142" Stem Dia., 6.4154" O.A.L.
12	Exhaust	FP-R520224	STD	1 groove; Inconel X-751; Chrome plated stem; 1.5748" Head Dia., .3142" Stem Dia., 6.4201" O.A.L.
<b>QTY</b>	<b>VALVE SEAT</b>	<b>PART NO.</b>	<b>SIZE</b>	<b>DESCRIPTION</b>
24	Exh. & Int.	FP-R527285 *	STD	
<b>QTY</b>	<b>VALVE GUIDE</b>	<b>PART NO.</b>	<b>SIZE</b>	<b>DESCRIPTION</b>
24	Guide	FP-R527286 *		
<b>QTY</b>	<b>VALVE SPRING</b>	<b>PART NO.</b>	<b>SIZE</b>	<b>DESCRIPTION</b>
24	Spring	FP-R504235		
<b>CAMSHAFT GROUP</b>				
<b>QTY</b>	<b>CAMSHAFT/LIFTER</b>	<b>PART NO.</b>	<b>SIZE</b>	<b>DESCRIPTION</b>
1	Camshaft Plug	FP-R82007		
<b>ENGINE BLOCK &amp; PARTS</b>				
<b>QTY</b>	<b>CAM BEARINGS</b>	<b>PART NO.</b>	<b>SIZE</b>	<b>DESCRIPTION</b>
6	Cam Brg.	FP-R527877 *	STD	
<b>CRANKSHAFT/OIL PUMP</b>				
<b>QTY</b>	<b>MAIN BEARINGS</b>	<b>PART NO.</b>	<b>SIZE</b>	<b>DESCRIPTION</b>
6	Plain Main Brg.	FP-RE529319	STD	
1	Flanged Main Brg.	FP-RE529320	STD	
<b>QTY</b>	<b>OIL PUMP</b>	<b>PART NO.</b>	<b>SIZE</b>	<b>DESCRIPTION</b>
1	Oil Pump Intake Gasket	FP-R100569		
<b>CYLINDER COMPONENTS</b>				
<b>QTY</b>	<b>LINERS</b>	<b>PART NO.</b>	<b>SIZE</b>	<b>DESCRIPTION</b>
6	Cyl. Liner Sealing Ring Kit	FP-AR98850		
<b>QTY</b>	<b>PISTONS</b>	<b>PART NO.</b>	<b>SIZE</b>	<b>DESCRIPTION</b>
6	Pin	FP-R517073 *	STD	
6	Pin Bushing	FP-R74008		1.877" ID, 2.0622 OD, 1.8728" O.A.L.
<b>QTY</b>	<b>CONNECTING RODS &amp; BRGS.</b>	<b>PART NO.</b>	<b>SIZE</b>	<b>DESCRIPTION</b>
12	Con. Rod Bolt	FP-R501035		Fractured split rod
6	Rod Pair	FP-RE529318 *	STD	

(continued on next page)

<b>39 Industrial Applications 6090T Eng.</b> (cont.) 9.0L 549 (9000cc) OHV Turbo-Diesel L6 (PowerTech 4V), 118.4mm Bore				
<b>CYLINDER COMPONENTS (cont.)</b>				
<b>QTY</b>	<b>PISTON RINGS</b>	<b>PART NO.</b>	<b>SIZE</b>	<b>DESCRIPTION</b>
6	Ring Set Single Cylinder	FP-RE531077 *	STD	
<b>40 Industrial Applications 6101D Eng.</b> 10.1L 616.7 (10109cc) OHV Diesel L6 (Litre Engine), 130mm Bore				
<b>CYL. HEAD &amp; PARTS</b>				
<b>QTY</b>	<b>GASKETS</b>	<b>PART NO.</b>	<b>SIZE</b>	<b>DESCRIPTION</b>
1	Valve Cover Gasket	FP-R74365		Rocker arm cover code 1104
<b>QTY</b>	<b>VALVE MISC.</b>	<b>PART NO.</b>	<b>SIZE</b>	<b>DESCRIPTION</b>
1	Oil Filler Cap Gasket	FP-T20328		Rocker arm cover code 1104
<b>INT &amp; EXH MANIFOLDS</b>				
<b>QTY</b>	<b>INT. &amp; EXH. MANIFOLDS</b>	<b>PART NO.</b>	<b>SIZE</b>	<b>DESCRIPTION</b>
2	Exhaust Manifold Gasket	FP-R80970		1 Hole
2	Exhaust Manifold Gasket	FP-R80969		2 Holes
<b>FUEL SYSTEM &amp; PARTS</b>				
<b>QTY</b>	<b>FUEL INJECTION</b>	<b>PART NO.</b>	<b>SIZE</b>	<b>DESCRIPTION</b>
1	Injector Pump Gasket	FP-R35349		Gear cover; w/Cover code 7701
6	Washer	FP-R84472		Injector nozzle; Nozzle codes 1601, 1602, 1610, 1611, 1613, 1614, 1632; .290" X .715" X .079"
6	Fuel Injector Nut	FP-R79604		Injection pump; Line codes 1601, 1602, 1610, 1611, 1612, 1613, 1614, 1632
2	Washer Type Seal	FP-R51936		Fuel pump lube line codes 1601, 1602, 1611, 1612, 1613, 1632
<b>QTY</b>	<b>FUEL FILTERS &amp; PUMP</b>	<b>PART NO.</b>	<b>SIZE</b>	<b>DESCRIPTION</b>
6	O-Ring	FP-R77551		6101T Eng.s.; Leak-off fitting to nozzle; Nozzle codes 1601, 1603, 1612, 1632; Viton®
6	O-Ring	FP-R51603		Fuel nozzle; w/Bosch injector
<b>QTY</b>	<b>TURBOCHARGER</b>	<b>PART NO.</b>	<b>SIZE</b>	<b>DESCRIPTION</b>
1	Turbocharger Oil Drain Gasket	FP-R105346		
<b>COOLING SYSTEM</b>				
<b>QTY</b>	<b>WATER PUMP</b>	<b>PART NO.</b>	<b>SIZE</b>	<b>DESCRIPTION</b>
1	Water Pump Shaft	FP-R82051		w/Pump housing marked R104709, R124059
1	Water Pump Impeller	FP-R82050		w/Pump housing marked R104709, R124059
2	Ball Brg.	FP-JD10329		w/Pump housing marked R104709, R124059
1	Water Pump Housing Gasket	FP-R99785		w/Pump housing marked R104709, R124059
2	Water Pump Mounting Gasket	FP-R49495		w/Pump housing marked R104709, R124059
1	O-Ring	FP-R72328		Water tube to thermostat housing seal; Turbo line codes 6501, 6502, 6503
1	Water Pump Filter	FP-R98527		w/Pump housing marked R104709, R124059
<b>QTY</b>	<b>THERMOSTAT</b>	<b>PART NO.</b>	<b>SIZE</b>	<b>DESCRIPTION</b>
3	Thermostat	FP-AR48675		180 Deg.
1	Thermostat Gasket	FP-R81274		w/3 thermostats
<b>ENGINE BLOCK &amp; PARTS</b>				
<b>QTY</b>	<b>GASKETS</b>	<b>PART NO.</b>	<b>SIZE</b>	<b>DESCRIPTION</b>
1	Front Cover Gasket	FP-R49483		
<b>QTY</b>	<b>OIL COOLERS &amp; FILTERS</b>	<b>PART NO.</b>	<b>SIZE</b>	<b>DESCRIPTION</b>
4	O-Ring	FP-R47153		Oil bypass valve housing
1	O-Ring	FP-R47153		Cooler tube
1	Oil Cooler Top Gasket	FP-R49491		Front gskt.
1	Oil Cooler Top Gasket	FP-R49490		Rear gskt.
<b>CRANKSHAFT/OIL PUMP</b>				
<b>QTY</b>	<b>SEALS - FRONT CRANK</b>	<b>PART NO.</b>	<b>SIZE</b>	<b>DESCRIPTION</b>
1	Oil Seal	FP-RE20768		Front pump bearing seal; w/Pump housing marked R74445, R86780, R104709
1	Oil Seal	FP-RE20767		Rear pump bearing seal; w/Pump housing marked R74445, R86780, R104709
<b>QTY</b>	<b>SEALS - REAR CRANK</b>	<b>PART NO.</b>	<b>SIZE</b>	<b>DESCRIPTION</b>
1	Oil Seal Kit	FP-SK13310		Incl. Seal & Wear sleeve
1	Crankshaft Rear Housing Gskt.	FP-R35043		
<b>QTY</b>	<b>OIL PUMP</b>	<b>PART NO.</b>	<b>SIZE</b>	<b>DESCRIPTION</b>
2	O-Ring	FP-R71732		Pump outlet tube; Pump codes 5001, 5002; w/Pump marked R62946
1	Oil Pump Intake Gasket	FP-R100569		w/Oil pump housing marked R62946, R124328

(continued on next page)

*Industrial Applications 6101D Eng. 40*  
10.1L 616.7 (10109cc) OHV Diesel L6 (Litre Engine), 130mm Bore (cont.)

### CRANKSHAFT/OIL PUMP (cont.)

QTY	OIL PUMP (cont.)	PART NO.	SIZE	DESCRIPTION
1	Oil Pump Intake Gasket	FP-R74464		Pick-up screen; w/Alum. oil pan; Early design
1	Oil Pump to Block Gasket	FP-R69418		
1	Oil Pump Intake Elbow Gasket	FP-R71312		Oil pump code 5002
1	Oil Press. Reg. Hsg. Gasket	FP-R49485		w/one hole
1	Oil Press. Reg. Hsg. Gasket	FP-R49484		w/two holes
1	Oil Filter Body Gasket	FP-R82943		

*Industrial Applications 6101T Eng. 41*  
10.1L 616.7 (10109cc) OHV Turbo-Diesel L6 (Litre Engine), 130mm Bore

### CYL. HEAD & PARTS

QTY	GASKETS	PART NO.	SIZE	DESCRIPTION
1	Valve Cover Gasket	FP-R74365		Rocker arm cover code 1104

QTY	VALVE MISC.	PART NO.	SIZE	DESCRIPTION
1	Oil Filler Cap Gasket	FP-T20328		Rocker arm cover code 1104

### INT & EXH MANIFOLDS

QTY	INT. & EXH. MANIFOLDS	PART NO.	SIZE	DESCRIPTION
2	Exhaust Manifold Gasket	FP-R80970		1 Hole
2	Exhaust Manifold Gasket	FP-R80969		2 Holes

### FUEL SYSTEM & PARTS

QTY	FUEL INJECTION	PART NO.	SIZE	DESCRIPTION
1	Injector Pump Gasket	FP-R35349		Gear cover; w/Cover code 7701
6	Washer	FP-R84472		Injector nozzle; Nozzle codes 1601, 1602, 1610, 1611, 1613, 1614, 1632; .290" X .715" X .079"
6	Fuel Injector Nut	FP-R79604		Injection pump; Line codes 1601, 1602, 1610, 1611, 1612, 1613, 1614, 1632
2	Washer Type Seal	FP-R51936		Fuel pump lube line codes 1601, 1602, 1611, 1612, 1613, 1632

QTY	FUEL FILTERS & PUMP	PART NO.	SIZE	DESCRIPTION
6	O-Ring	FP-R77551		6101T Engs.; Leak-off fitting to nozzle; Nozzle codes 1601, 1603, 1612, 1632; Viton®
6	O-Ring	FP-R51603		Fuel nozzle; w/Bosch injector

QTY	TURBOCHARGER	PART NO.	SIZE	DESCRIPTION
1	Turbocharger Oil Drain Gasket	FP-R105346		

### COOLING SYSTEM

QTY	WATER PUMP	PART NO.	SIZE	DESCRIPTION
1	Water Pump Shaft	FP-R82051		w/Pump housing marked R104709, R124059
1	Water Pump Impeller	FP-R82050		w/Pump housing marked R104709, R124059
2	Ball Brg.	FP-JD10329		w/Pump housing marked R104709, R124059
1	Water Pump Housing Gasket	FP-R99785		w/Pump housing marked R104709, R124059
2	Water Pump Mounting Gasket	FP-R49495		w/Pump housing marked R104709, R124059
1	O-Ring	FP-R72328		Water tube to thermostat housing seal; Turbo line codes 6501, 6502, 6503
1	Water Pump Filter	FP-R98527		w/Pump housing marked R104709, R124059

QTY	THERMOSTAT	PART NO.	SIZE	DESCRIPTION
3	Thermostat	FP-AR48675		180 Deg.
1	Thermostat Gasket	FP-R81274		w/3 thermostats

### ENGINE BLOCK & PARTS

QTY	GASKETS	PART NO.	SIZE	DESCRIPTION
1	Front Cover Gasket	FP-R49483		

QTY	OIL COOLERS & FILTERS	PART NO.	SIZE	DESCRIPTION
4	O-Ring	FP-R47153		Oil bypass valve housing
1	O-Ring	FP-R47153		Cooler tube
1	Oil Cooler Top Gasket	FP-R49491		Front gskt.
1	Oil Cooler Top Gasket	FP-R49490		Rear gskt.

### CRANKSHAFT/OIL PUMP

QTY	SEALS - FRONT CRANK	PART NO.	SIZE	DESCRIPTION
1	Oil Seal	FP-RE20768		Front pump bearing seal; w/Pump housing marked R74445, R86780, R104709
1	Oil Seal	FP-RE20767		Rear pump bearing seal; w/Pump housing marked R74445, R86780, R104709

QTY	SEALS - REAR CRANK	PART NO.	SIZE	DESCRIPTION
1	Oil Seal Kit	FP-SK13310		Incl. Seal & Wear sleeve

(continued on next page)

<b>41 Industrial Applications 6101T Eng.</b>				
<b>(cont.) 10.1L 616.7 (10109cc) OHV Turbo-Diesel L6 (Litre Engine), 130mm Bore</b>				
<b>CRANKSHAFT/OIL PUMP (cont.)</b>				
<b>QTY</b>	<b>SEALS - REAR CRANK (cont.)</b>	<b>PART NO.</b>	<b>SIZE</b>	<b>DESCRIPTION</b>
1	Crankshaft Rear Housing Gskt.	FP-R35043		
<b>QTY</b>	<b>OIL PUMP</b>	<b>PART NO.</b>	<b>SIZE</b>	<b>DESCRIPTION</b>
2	O-Ring	FP-R71732		Pump outlet tube; Pump codes 5001, 5002; w/Pump marked R62946
1	Oil Pump Intake Gasket	FP-R100569		w/Oil pump housing marked R62946, R124328
1	Oil Pump Intake Gasket	FP-R74464		Pick-up screen; w/Alum. oil pan; Early design
1	Oil Pump to Block Gasket	FP-R69418		
1	Oil Pump Intake Elbow Gasket	FP-R71312		Oil pump code 5002
1	Oil Press. Reg. Hsg. Gasket	FP-R49485		w/one hole
1	Oil Press. Reg. Hsg. Gasket	FP-R49484		w/two holes
1	Oil Filter Body Gasket	FP-R82943		
<b>42 Industrial Applications 6101T, 6619TA Eng.</b>				
<b>10.1L 619 OHV Turbo-Diesel L6, 5.125" Bore</b>				
<b>CYL. HEAD &amp; PARTS</b>				
<b>QTY</b>	<b>GASKETS</b>	<b>PART NO.</b>	<b>SIZE</b>	<b>DESCRIPTION</b>
1	Valve Cover Gasket	FP-R74365		6619A Eng.s.; Rocker arm cover codes 1102, 1104; To Ser. No. 50,465
1	Head Gasket	FP-RE34009		
1	Head Set	FP-RE37417		
1	Ventilator Housing Gasket	FP-R49492		
<b>QTY</b>	<b>VALVE</b>	<b>PART NO.</b>	<b>SIZE</b>	<b>DESCRIPTION</b>
6	Intake	FP-R75690		Chrome plated stem; 2.0310" Head Dia., .4341" Stem Dia., 6.6620" O.A.L.
6	Exhaust	FP-R63982		1.8750" Head Dia., .4341" Stem Dia., 6.6550" O.A.L.
12	Valve Stem Cap	FP-R40366		Exh. & Int.; From Ser. No. 21,562
24	Keeper	FP-R35431		Exh. & Int.
24	Keeper	VK-140		Exh. & Int.
<b>QTY</b>	<b>VALVE SEAT</b>	<b>PART NO.</b>	<b>SIZE</b>	<b>DESCRIPTION</b>
6	Exh.	FP-R60537	STD	
6	Int.	FP-R59894	STD	
<b>QTY</b>	<b>VALVE GUIDE</b>	<b>PART NO.</b>	<b>SIZE</b>	<b>DESCRIPTION</b>
12	Guide	FP-R53192		.4375" ID, 3.1880" O.A.L.
<b>QTY</b>	<b>VALVE SPRING</b>	<b>PART NO.</b>	<b>SIZE</b>	<b>DESCRIPTION</b>
6	Spring	FP-R49569		Inner
6	Spring	FP-R49571		Outer; 2.5200" Free Height
<b>QTY</b>	<b>VALVE MISC.</b>	<b>PART NO.</b>	<b>SIZE</b>	<b>DESCRIPTION</b>
12	Rotocap	FP-R81086		Exh. & Int.
1	Oil Filler Cap Gasket	FP-T20328		Rocker arm cover code 1104; Oil filler neck code 1201
<b>ELECTRICAL</b>				
<b>QTY</b>	<b>ALTERNATOR</b>	<b>PART NO.</b>	<b>SIZE</b>	<b>DESCRIPTION</b>
1	Ball Brg.	FP-JD9449		Front; 6619A Eng.s.; Delco-Remy No. 1105510; 24 Volt, 40 amp alternator
1	Ball Brg.	FP-JD9449		Front; 6619A Eng.s.; Delco-Remy Nos. 1101268, 1101345, 1102932, 1103128, 1105174; Code 3103; 12 Volt, 72 amp alternator
1	Ball Brg.	FP-JD9449		Front; 6619A Eng.s.; Motorola No. 70D42076T02; Code 3101; 12 Volt, 65 amp alternator
1	Ball Brg.	FP-JD9449		Front; 6619A Eng.s.; Motorola Remanufactured; Code 3102; 12 Volt, 51 amp alternator; 55 amp alternator
2	Ball Brg.	FP-JD9449		Front & Rear; 6619A Eng.s.; Motorola No. 70D42179T02; 24 Volt, 45 amp alternator; To Ser. No. 59,456
<b>METERS</b>				
<b>QTY</b>	<b>METERS</b>	<b>PART NO.</b>	<b>SIZE</b>	<b>DESCRIPTION</b>
1	Speed/Hour Meter Gasket	FP-R62410		Tach. drive codes 3300, 3303; From Ser. No. 46,656
1	Speed/Hour Meter Gasket	FP-R44853		Tach. drive codes 3300, 3303; To Ser. No. 46,655
<b>INT &amp; EXH MANIFOLDS</b>				
<b>QTY</b>	<b>INT. &amp; EXH. MANIFOLDS</b>	<b>PART NO.</b>	<b>SIZE</b>	<b>DESCRIPTION</b>
2	Exhaust Manifold Gasket	FP-R80970		To Ser. No. 60,152; 1 Hole
2	Exhaust Manifold Gasket	FP-R80969		To Ser. No. 60,152; 2 Holes
3	Intake Manifold Gasket	FP-R40088		Two Int. holes

(continued on next page)

**Industrial Applications 6101T, 6619TA Eng. 42**  
10.1L 619 OHV Turbo-Diesel L6, 5.125" Bore (cont.)

<b>FUEL SYSTEM &amp; PARTS</b>				
<b>QTY</b>	<b>FUEL INJECTION</b>	<b>PART NO.</b>	<b>SIZE</b>	<b>DESCRIPTION</b>
1	Injector Pump Gasket	FP-R35349		6619A Engs.; Gear cover
1	Injector Pump Gasket	FP-R35349		6619T Engs.; Gear cover; w/Cover marked R55506
12	Washer	FP-R48693		Inj. leak-off screw
6	Washer	FP-R64840		6619A Engs.; Injector nozzle; Nozzle codes 1601, 1606, 1608, 1610; From Ser. No. 50,465; Steel
6	Washer	FP-R64840		6619A Engs.; Injector nozzle; Nozzle codes 1601, 1606, 1637; To Ser. No. 27,969; Steel
6	Washer	FP-R64840		6619A Engs.; Injector nozzle; Nozzle codes 1606, 1608; From Ser. No. 27,970 to Ser. No. 50,464; Steel
6	Washer	FP-R64840		6619T Engs.; Steel
6	Fuel Injector Nut	FP-R79604		Injection pump; Line codes 1601, 1608, 1610, 1637
19	Clamp	FP-R34766		6619A Engs.; Pump codes 1601, 1606; To Ser. No. 27,969
6	Fuel Line Connector Gasket	FP-R59294		Leak-off connector washer; Aftercooled; w/Connector R59293, R77850, R83558; Alum.
12	Washer Type Seal	FP-R51936		6619A Engs.; Leak-off & return line seals; Injection pump codes 1601, 1606, 1608, 1610, 1637
12	Washer Type Seal	FP-R51936		6619T Engs.; Leak-off & return line seals
<b>QTY</b>	<b>FUEL FILTERS &amp; PUMP</b>	<b>PART NO.</b>	<b>SIZE</b>	<b>DESCRIPTION</b>
6	O-Ring	FP-R51603		Fuel nozzle; w/Bosch injector
1	O-Ring	FP-R375R		Fuel check valve seal
<b>QTY</b>	<b>TURBOCHARGER</b>	<b>PART NO.</b>	<b>SIZE</b>	<b>DESCRIPTION</b>
1	Turbocharger Oil Drain Gasket	FP-R75691		6619A Engs.; w/Turbo oil line codes 6501, 6502
1	Turbocharger Oil Drain Gasket	FP-R75691		6619T Engs.; w/Turbo oil line code 6503
1	Turbocharger Mounting Gasket	FP-R49697		
1	O-Ring	FP-R57517		6619A Engs.; Manifold to turbo coupling seal; Int. manifold codes 2802, 2803
1	O-Ring	FP-R57517		6619T Engs.; Manifold to turbo coupling seal
1	O-Ring	FP-R49424		Outer coupling; Manifold codes 2802, 2803
1	Turbocharger Oil Supply Gskt.	FP-R58222		6619A Engs.; Turbo codes 6501, 6502
1	Turbocharger Oil Supply Gskt.	FP-R58222		6619T Engs.; Turbo code 6503
<b>COOLING SYSTEM</b>				
<b>QTY</b>	<b>WATER PUMP</b>	<b>PART NO.</b>	<b>SIZE</b>	<b>DESCRIPTION</b>
1	Water Pump Shaft	FP-R82053		6619A Engs.; w/Pump housing marked R65237
1	Water Pump Shaft	FP-R82051		6619A Engs.; w/Pump housing marked R67350, R74445, R86780, R98303, R104709
1	Water Pump Shaft	FP-R82052		6619T Engs.; w/Pump housing marked R66661
1	Water Pump Impeller	FP-R135265		6619A Engs.; w/Pump housing marked R124057
1	Water Pump Impeller	FP-R82050		6619A Engs.; w/Pump housing marked R74445, R86780, R104709
1	Water Pump Impeller	FP-R84180		6619A Engs.; Pump code 2025; w/Pump housing marked R23992
1	Water Pump Repair/Rebuild Kit	FP-RE69842		w/Pump housing marked R65237
1	Water Pump Repair/Rebuild Kit	FP-RE69845		w/Pump housing marked R67350
1	Water Pump Repair/Rebuild Kit	FP-RE68319		Pump code 2025; w/Pump housing marked R74445, R86780, R104709
1	Water Pump Repair/Rebuild Kit	FP-RE69840		6619A Engs.; w/Pump housing marked R48818, R58705, R124257; From Ser. No. 35,958
1	Water Pump Repair/Rebuild Kit	FP-RE69927		6619A Engs.; w/Pump housing marked R74445, R86780, R104709
1	Water Pump Repair/Rebuild Kit	FP-RE69841		6619T Engs.; w/Pump housing marked R66661
1	Water Pump Housing Gasket	FP-R99785		6619A Engs.; w/H/D water pump; w/Pump housing marked R74445, R86780, R104709
1	Water Pump Housing Gasket	FP-R69415		6619A Engs.; w/Pump housing marked R58705
1	Water Pump Housing Gasket	FP-R66093		6619T Engs.; w/Pump marked R66661
1	Water Pump Mounting Gasket	FP-R49495		w/H/D water pump; w/Pump housing marked R74445, R86780, R104709
1	Water Pump Mounting Gasket	FP-R49495		w/Pump housing marked R58705, R124057
1	Oil Seal	FP-AR90860		6619A Engs.; Pump code 2003; w/H/D water pump
1	O-Ring	FP-R72328		6619A Engs.; Turbo line codes 6501, 6502, 6503
1	O-Ring	FP-R72328		6619T Engs.; Turbo line code 6503
1	Shaft & Bearing Assembly	FP-AU43144		6619A Engs.; w/Pump housing marked R124057
<b>QTY</b>	<b>THERMOSTAT</b>	<b>PART NO.</b>	<b>SIZE</b>	<b>DESCRIPTION</b>
3	Thermostat	FP-AR72852		6619A Engs.; Thermostat code 2204; Thermostat housing code 3903; Housing marked R57513;; 192 Deg.
3	Thermostat	FP-AR48675		6619A Engs.; Thermostat housing code 3903; Housing marked R57513; 180 Deg.
3	Thermostat	FP-AR48675		6619T Engs.; 180 Deg.
3	Thermostat	FP-AR72852		6619T Engs.; 192 Deg.

(continued on next page)

<b>42 Industrial Applications 6101T, 6619TA Engs.</b>				
<b>(cont.) 10.1L 619 OHV Turbo-Diesel L6, 5.125" Bore</b>				
<b>COOLING SYSTEM (cont.)</b>				
<b>QTY</b>	<b>THERMOSTAT (cont.)</b>	<b>PART NO.</b>	<b>SIZE</b>	<b>DESCRIPTION</b>
1	Thermostat Gasket	FP-R81274		w/3 thermostats
<b>QTY</b>	<b>MISCELLANEOUS</b>	<b>PART NO.</b>	<b>SIZE</b>	<b>DESCRIPTION</b>
2	Water Manifold Mounting Gskt.	FP-R88397		
<b>ENGINE BLOCK &amp; PARTS</b>				
<b>QTY</b>	<b>GASKETS</b>	<b>PART NO.</b>	<b>SIZE</b>	<b>DESCRIPTION</b>
1	Front Cover Gasket	FP-R49483		w/Timing gear cover marked R48835, R67342, R110147
1	Front Cover Gasket	FP-R49483		w/Timing gear cover marked R77301
1	Oil Pan Gasket	FP-R71919		6619A Engs.
1	Oil Pan Gasket Set	FP-PG501PS		6619T Engs.; w/Crankshaft driven oil pump; w/Cast Iron oil pan.; From Ser. No. 020,331
1	Oil Pan Gasket Set	FP-PG500PS		6619T Engs.; w/Crankshaft driven oil pump; w/Cast Iron oil pan.; Thin gskt.
<b>QTY</b>	<b>GASKET SETS</b>	<b>PART NO.</b>	<b>SIZE</b>	<b>DESCRIPTION</b>
1	In-Frame Gasket Set	FP-PG619S		6619T Engs.
1	Complete Overhaul Gasket Set	FP-RE37416		Crankshaft seals not incl.
1	Complete Overhaul Gasket Set	FP-RE37416WS		6619A Engs.; Crankshaft seals incl.
<b>QTY</b>	<b>CAM BEARINGS</b>	<b>PART NO.</b>	<b>SIZE</b>	<b>DESCRIPTION</b>
1	Cam Set	FP-4R46903	STD	
4	Cam Brg.	FP-R46903	STD	
<b>QTY</b>	<b>OIL COOLERS &amp; FILTERS</b>	<b>PART NO.</b>	<b>SIZE</b>	<b>DESCRIPTION</b>
1	Aftercooler Gasket Set	FP-500A		6619A Engs.
2	Aftercooler Housing Gasket	FP-R53081		6619A Engs.
1	O-Ring	FP-R47153		Cooler tube
2	O-Ring	FP-R47153		Water manifold; 6619A Engs.; Water manifold codes 2802, 2803
2	Oil Cooler Housing Gasket	FP-R57504		
1	Oil Cooler Top Gasket	FP-R49491		Oil cooler to regulator housing front
1	Oil Cooler Top Gasket	FP-R49490		Oil cooler to regulator housing rear
<b>CRANKSHAFT/OIL PUMP</b>				
<b>QTY</b>	<b>CRANKSHAFT</b>	<b>PART NO.</b>	<b>SIZE</b>	<b>DESCRIPTION</b>
1	Crankshaft	FP-AR92533		6619A Engs.; From Ser. No. 33,814; Crankshaft marked R63476, AR78403
<b>QTY</b>	<b>SEALS - FRONT CRANK</b>	<b>PART NO.</b>	<b>SIZE</b>	<b>DESCRIPTION</b>
1	Oil Seal	FP-RE20768		6619A Engs.; Front pump bearing seal; w/Pump housing marked R74445, R86780, R104709
1	Oil Seal	FP-RE20767		6619A Engs.; Rear pump bearing seal; w/Pump housing marked R74445, R86780, R104709
1	Oil Seal Kit	FP-AR49025		
1	Oil Seal Kit	FP-RE68318		6619A Engs.; w/Pump housing marked R74445, R86760, R104709, R124057; From Ser. No. 39,358
<b>QTY</b>	<b>SEALS - REAR CRANK</b>	<b>PART NO.</b>	<b>SIZE</b>	<b>DESCRIPTION</b>
1	Oil Seal	FP-RE13310		
1	Oil Seal Kit	FP-SK13310		Incl. Seal & Wear sleeve
1	Crankshaft Rear Housing Gskt.	FP-R35043		
<b>QTY</b>	<b>MAIN BEARINGS</b>	<b>PART NO.</b>	<b>SIZE</b>	<b>DESCRIPTION</b>
1	Main Set	FP-MBK531	STD	w/full groove lower brg.; Flanged No. 5 brg.
1	Main Set	FP-MBK53110	10	w/full groove lower brg.; Flanged No. 5 brg.
1	Main Set	FP-MBK53120	20	w/full groove lower brg.; Flanged No. 5 brg.
1	Main Set	FP-MBK53130	30	w/full groove lower brg.; Flanged No. 5 brg.
1	Main Set	FP-MBK619	STD	w/partial groove lower brg.
1	Main Set	FP-MBK61910	10	w/partial groove lower brg.
1	Main Set	FP-MBK61920	20	w/partial groove lower brg.
1	Main Set	FP-MBK61930	30	w/partial groove lower brg.
6	Plain Main Brg.	FP-AR101268	STD	
6	Plain Main Brg.	FP-AR104122	.25MM	
6	Plain Main Brg.	FP-AR104123	.50MM	
6	Plain Main Brg.	FP-AR104124	.75MM	
1	Plain Main Brg.	FP-AR101269	STD	Use w/Thrust Washer Set
1	Plain Main Brg.	FP-AR104126	.25MM	Use w/Thrust Washer Set
1	Plain Main Brg.	FP-AR104127	.50MM	Use w/Thrust Washer Set
1	Plain Main Brg.	FP-AR104128	.75MM	Use w/Thrust Washer Set
1	Thrust Washer Set	FP-AR89622	STD	
1	Thrust Washer Set	FP-AR89971	7	
<b>QTY</b>	<b>OIL PUMP</b>	<b>PART NO.</b>	<b>SIZE</b>	<b>DESCRIPTION</b>
2	O-Ring	FP-R71732		6619A Engs.; Pump outlet tube; w/Pump marked R69946; To Ser. No. 46,655

(continued on next page)



*Industrial Applications 6101T, 6619TA Engs. 42*  
10.1L 619 OHV Turbo-Diesel L6, 5.125" Bore (cont.)

<b>CRANKSHAFT/OIL PUMP (cont.)</b>				
<b>QTY</b>	<b>OIL PUMP (cont.)</b>	<b>PART NO.</b>	<b>SIZE</b>	<b>DESCRIPTION</b>
2	O-Ring	FP-R71732		6619A Engs.; Pump outlet tube; Pump code 1901; w/Pump marked R69946; w/Cast iron oil pan; From Ser. No. 46,656 to Ser. No. 61,565
1	O-Ring	FP-R495R		Ventilator tube; 6619A Engs.; Smooth
1	Oil Pump Intake Gasket	FP-R100569		w/Oil pump housing marked R62946; Oil pump pickup codes 1901, 1906
1	Oil Pump Intake Gasket	FP-R74464		6619T Engs.; Pick-up screen; w/Alum. oil pan
1	Rect. or Square Seal	FP-R43660		Filter to housing; w/housing marked R48349, R68157, R71485
1	Oil Pump to Block Gasket	FP-R69418		
1	Oil Pump Intake Elbow Gasket	FP-R71312		6619T Engs.; w/Alum. oil pan; Oil pan code 1916
1	Oil Press. Reg. Hsg. Gasket	FP-R49485		w/Housing marked R48349, R68157, R71485; w/one hole
1	Oil Filter Body Gasket	FP-R82943		Timing gear cover code 1299; Filter code 1201
1	Pick-Up Tube Gasket	FP-R70475		Oil pump code 1901; w/Cast iron oil pan; To Ser. No. 20,330
<b>CYLINDER COMPONENTS</b>				
<b>QTY</b>	<b>LINERS</b>	<b>PART NO.</b>	<b>SIZE</b>	<b>DESCRIPTION</b>
6	Liner w/o Sealing Ring	FP-R77640		From Ser. No. 49,060
6	Liner w/o Sealing Ring	FP-R65629		To Ser. No. 49,059
6	Liner w/Sealing Rings	FP-R77640WS		From Ser. No. 49,060
6	Liner w/Sealing Rings	FP-R65629WS		To Ser. No. 49,059
6	Cylinder Kit Complete	FP-AR84089		w/Block marked R57424, R63199, R65628, R69312, R72130, R74123; w/Con. Rod marked R57484, R66925; To Ser. No. 33,814
6	Cylinder Kit Complete	FP-RE20291	STD	w/Block marked R57424, R63199, R65628, R69312, R72130, R74123; w/Con. Rod marked R63959; From Ser. No. 33,815 to Ser. No. 49,059
6	Cylinder Kit Complete	FP-RE40476		w/Block marked R75934, R87752, R88217; w/Con. Rod marked R63959; From Ser. No. 49,060
6	Cyl. Liner Sealing Ring Kit	FP-AR72351		
<b>QTY</b>	<b>PISTONS</b>	<b>PART NO.</b>	<b>SIZE</b>	<b>DESCRIPTION</b>
6	Piston Body w/o Pin	FP-RE42231		From Ser. No. 33,815
6	Piston Body w/o Pin	FP-AR69038		To Ser. No. 33,814
6	Piston Kit w/Pin & Retainers	FP-RE42231WP		From Ser. No. 33,815
6	Piston Kit w/Pin & Retainers	FP-AR69038WP		To Ser. No. 33,814
6	Pin	FP-R64451		
12	Piston Pin Retainer	FP-N51168		
6	Pin Bushing	FP-3819Y20		w/Con. Rod marked R63959; w/1.999" ID, w/2.187" OD, 2.0512 O.A.L.
6	Pin Bushing	FP-R69045		w/Con. Rod marked R63959; w/1.999" ID, w/2.187" OD, 2.0512" O.A.L.
6	Pin Bushing	FP-R60197		6619A Engs.; To Ser. No. 33,814; w/Con. Rod marked R57484, R66925; w/1.9987" ID, 2.1872" OD, 2.029" O.A.L.
<b>QTY</b>	<b>CONNECTING RODS &amp; BRGS.</b>	<b>PART NO.</b>	<b>SIZE</b>	<b>DESCRIPTION</b>
12	Con. Rod Bolt	FP-R66453		w/Con. Rod marked R57484, R66925; To Ser. No. 33,814; Torque-To-Yield bolt; Replacement recommended
12	Con. Rod Bolt	FP-R66453		w/Con. Rod marked R63959; From Ser. No. 33,815; Torque-To-Yield bolt; Replacement recommended
6	Rod Pair	FP-AR101271	STD	w/o oil hole & groove
6	Rod Pair	FP-AR104130	.25MM	w/o oil hole & groove
6	Rod Pair	FP-AR104131	.50MM	w/o oil hole & groove
6	Rod Pair	FP-AR104132	.75MM	w/o oil hole & groove
6	Rod Pair	FP-AR53020	STD	w/oil hole; w/partial groove
6	Rod Pair	FP-AR57208	10	w/oil hole; w/partial groove
6	Rod Pair	FP-AR57209	20	w/oil hole; w/partial groove
6	Rod Pair	FP-AR57210	30	w/oil hole; w/partial groove
<b>QTY</b>	<b>PISTON RINGS</b>	<b>PART NO.</b>	<b>SIZE</b>	<b>DESCRIPTION</b>
6	Ring Set Single Cylinder	FP-AR82355	STD	
<b>KITS</b>				
<b>QTY</b>	<b>OVERHAUL KIT</b>	<b>PART NO.</b>	<b>SIZE</b>	<b>DESCRIPTION</b>
1	In-Frame Overhaul Kit	FP-619EIFK		w/Block marked R57424, R63199, R65628, R69312, R72130, R74123; w/Con. Rod marked R57484, R66925; To Ser. No. 33,814; Incl. Torque-To-Yield con. rod bolts
1	In-Frame Overhaul Kit	FP-619MIFK		w/Block marked R57424, R63199, R65628, R69312, R72130, R74123; w/Con. Rod marked R63959; From Ser. No. 33,815 to Ser. No. 49,059; Incl. Torque-To-Yield con. rod bolts

(continued on next page)

**42 Industrial Applications 6101T, 6619TA Eng.**  
(cont.) 10.1L 619 OHV Turbo-Diesel L6, 5.125" Bore

<b>KITS (cont.)</b>				
<b>QTY</b>	<b>OVERHAUL KIT (cont.)</b>	<b>PART NO.</b>	<b>SIZE</b>	<b>DESCRIPTION</b>
1	In-Frame Overhaul Kit	<b>FP-619LIFK</b>		w/Block marked R75934, R87752, R88217; w/Con. Rod marked R63959; From Ser. No. 49,060; Incl. Torque-To-Yield con. rod bolts
1	Complete Overhaul Kit	<b>FP-619EOHK</b>		w/Block marked R57424, R63199, R65628, R69312, R72130, R74123; w/Con. Rod marked R57484, R66925; To Ser. No. 33,814; Incl. Torque-To-Yield con. rod bolts
1	Complete Overhaul Kit	<b>FP-619MOHK</b>		w/Block marked R57424, R63199, R65628, R69312, R72130, R74123; w/Con. Rod marked R63959; From Ser. No. 33,815 to Ser. No. 49,059; Incl. Torque-To-Yield con. rod bolts
1	Complete Overhaul Kit	<b>FP-619LOHK</b>		w/Block marked R75934, R87752, R88217; w/Con. Rod marked R63959; From Ser. No. 49,060; Incl. Torque-To-Yield con. rod bolts

**43 Industrial Applications 6105A, 6105T Eng.**  
10.5L 639.5 (10483cc) OHV Turbo-Diesel L6 (PowerTech), 127mm Bore

<b>CYL. HEAD &amp; PARTS</b>				
<b>QTY</b>	<b>VALVE</b>	<b>PART NO.</b>	<b>SIZE</b>	<b>DESCRIPTION</b>
48	Keeper	<b>FP-R91889</b>		6105A Engs.
<b>FUEL SYSTEM &amp; PARTS</b>				
<b>QTY</b>	<b>TURBOCHARGER</b>	<b>PART NO.</b>	<b>SIZE</b>	<b>DESCRIPTION</b>
1	Turbocharger Oil Drain Gasket	<b>FP-R105346</b>		6105A Engs.; w/Turbo oil line codes 6501, 6502, 6503, 6504, 6505, 6506
1	Turbocharger Mounting Gasket	<b>FP-R49697</b>		6105A Engs.
<b>COOLING SYSTEM</b>				
<b>QTY</b>	<b>WATER PUMP</b>	<b>PART NO.</b>	<b>SIZE</b>	<b>DESCRIPTION</b>
2	Ball Brg.	<b>FP-JD10329</b>		6105A Engs.; Fan hub shaft bearing; Code 2303
1	Ball Brg.	<b>FP-JD10362</b>		Front; 6105A Engs.; Water Pump bearing; Code 2001
1	Ball Brg.	<b>FP-JD10363</b>		Rear; 6105A Engs.; Water Pump bearing; Code 2001
1	Oil Seal	<b>FP-RE39134</b>		6105A Engs.; Water pump code 2001
1	Oil Seal	<b>FP-RE39134</b>		6105A Engs.; Rear water pump seal; Water pump code 2001
<b>QTY</b>	<b>THERMOSTAT</b>	<b>PART NO.</b>	<b>SIZE</b>	<b>DESCRIPTION</b>
1	Thermostat	<b>FP-RE33705</b>		Upper; 6105A Engs.; 180 Deg.
<b>CRANKSHAFT/OIL PUMP</b>				
<b>QTY</b>	<b>SEALS - FRONT CRANK</b>	<b>PART NO.</b>	<b>SIZE</b>	<b>DESCRIPTION</b>
1	Oil Seal	<b>FP-RE20768</b>		6105A Engs.; Fan hub shaft seal; w/Pump housing marked R129075
<b>QTY</b>	<b>SEALS - REAR CRANK</b>	<b>PART NO.</b>	<b>SIZE</b>	<b>DESCRIPTION</b>
1	Crankshaft Rear Housing Gskt.	<b>FP-R35043</b>		6105A Engs.
<b>CYLINDER COMPONENTS</b>				
<b>QTY</b>	<b>LINERS</b>	<b>PART NO.</b>	<b>SIZE</b>	<b>DESCRIPTION</b>
6	Cyl. Liner Sealing Ring Kit	<b>FP-AR72351</b>		Piston, Con. Rod, Cyl. liner codes 6105, 6125; w/Liner marked RE66125
<b>QTY</b>	<b>PISTONS</b>	<b>PART NO.</b>	<b>SIZE</b>	<b>DESCRIPTION</b>
6	Pin	<b>FP-R64451</b>		Piston, Con. Rod, Cyl. liner codes 6105, 6125
12	Piston Pin Retainer	<b>FP-N51168</b>		Piston, Con. Rod, Cyl. liner codes 6105, 6125
<b>QTY</b>	<b>CONNECTING RODS &amp; BRGS.</b>	<b>PART NO.</b>	<b>SIZE</b>	<b>DESCRIPTION</b>
12	Con. Rod Bolt	<b>FP-R66453</b>		Piston, Con. Rod, Cyl. liner codes 6105, 6125; w/Rod marked R121174; Torque-To-Yield bolt; Replacement recommended

**44 Industrial Applications 6125T Eng.**  
12.5L 764.6 (12534cc) OHV Turbo-Diesel L6 (PowerTech), 127mm Bore

<b>CYL. HEAD &amp; PARTS</b>				
<b>QTY</b>	<b>VALVE</b>	<b>PART NO.</b>	<b>SIZE</b>	<b>DESCRIPTION</b>
48	Keeper	<b>FP-R91889</b>		
<b>CAMSHAFT GROUP</b>				
<b>QTY</b>	<b>TIMING</b>	<b>PART NO.</b>	<b>SIZE</b>	<b>DESCRIPTION</b>
1	Idler Sprocket/Gear Bushing	<b>FP-R533789</b>		

(continued on next page)





<i>Industrial Applications 6125T Eng. 44</i>				
12.5L 764.6 (12534cc) OHV Turbo-Diesel L6 (PowerTech), 127mm Bore (cont.)				
<b>FUEL SYSTEM &amp; PARTS</b>				
<b>QTY</b>	<b>TURBOCHARGER</b>	<b>PART NO.</b>	<b>SIZE</b>	<b>DESCRIPTION</b>
1	Turbocharger Oil Drain Gasket	FP-R105346		w/Turbo oil line codes 6501, 6502, 6503, 6504, 6505, 6506
1	Turbocharger Mounting Gasket	FP-R49697		
<b>COOLING SYSTEM</b>				
<b>QTY</b>	<b>WATER PUMP</b>	<b>PART NO.</b>	<b>SIZE</b>	<b>DESCRIPTION</b>
2	Ball Brg.	FP-JD10329		Fan hub shaft bearing code 2303
1	Ball Brg.	FP-JD10362		Front; Water Pump bearing code 2001
1	Ball Brg.	FP-JD10363		Rear; Water Pump bearing code 2001
1	Oil Seal	FP-RE39134		Rear water pump seal; Water pump code 2001
<b>QTY</b>	<b>THERMOSTAT</b>	<b>PART NO.</b>	<b>SIZE</b>	<b>DESCRIPTION</b>
1	Thermostat	FP-RE33705		Upper; 180 Deg.
<b>CRANKSHAFT/OIL PUMP</b>				
<b>QTY</b>	<b>SEALS - FRONT CRANK</b>	<b>PART NO.</b>	<b>SIZE</b>	<b>DESCRIPTION</b>
1	Oil Seal	FP-RE20768		Fan hub shaft seal; w/Pump housing marked R104709, R124059
<b>QTY</b>	<b>SEALS - REAR CRANK</b>	<b>PART NO.</b>	<b>SIZE</b>	<b>DESCRIPTION</b>
1	Crankshaft Rear Housing Gskt.	FP-R35043		
<b>CYLINDER COMPONENTS</b>				
<b>QTY</b>	<b>LINERS</b>	<b>PART NO.</b>	<b>SIZE</b>	<b>DESCRIPTION</b>
6	Cyl. Liner Sealing Ring Kit	FP-AR72351		Piston, Con. Rod, Cyl. liner code 4801
<b>QTY</b>	<b>PISTONS</b>	<b>PART NO.</b>	<b>SIZE</b>	<b>DESCRIPTION</b>
6	Pin	FP-R64451		Piston, Con. Rod, Cyl. liner code 4801
12	Piston Pin Retainer	FP-N51168		Piston, Con. Rod, Cyl. liner code 4801
6	Pin Bushing	FP-R69045		w/Con. Rod marked R121174; w/1.999" ID, w/2.187" OD, 2.0512" O.A.L.
<b>QTY</b>	<b>CONNECTING RODS &amp; BRGS.</b>	<b>PART NO.</b>	<b>SIZE</b>	<b>DESCRIPTION</b>
12	Con. Rod Bolt	FP-R66453		Piston, Con. Rod, Cyl. liner code 4801; Rod marked R121174; Torque-To-Yield bolt; Replacement recommended
6	Rod Pair	FP-RE530787 *	STD	

**John Deere Marine**

<b>Engine Finding Index</b>					
Engine	Line No.	Engine	Line No.		
4.5L 275.8 (4522cc) OHV Turbo-Diesel L4 106mm Bore (PowerTech 2V IC) .....	1	7.6L 465.9 (7638cc) OHV Turbo-Diesel L6 115mm Bore (Litre Engine).....	9		
4.5L 275.8 (4522cc) OHV Diesel L4 106mm Bore (PowerTech 2V) .....	2	8.1L 495.9 (8129cc) OHV Turbo-Diesel L6 116mm Bore (PowerTech 2V IC) .....	10		
4.5L 275.8 (4522cc) OHV Turbo-Diesel L4 106mm Bore (PowerTech 2V).....	3	8.1L 495.9 (8129cc) OHV Turbo-Diesel L6 116mm Bore (PowerTech 2V AC).....	11		
6.8L 413.8 (6784cc) OHV Turbo-Diesel L6 106mm Bore (PowerTech 2V IC) .....	4	8.1L 495.9 (8129cc) OHV Turbo-Diesel L6 116mm Bore (PowerTech 2V) .....	12		
6.8L 413.8 (6784cc) OHV Turbo-Diesel L6 106mm Bore (PowerTech 4V IC) .....	5	9.0L 549 (9000cc) OHV Turbo-Diesel L6 118.4mm Bore (PowerTech 4V IC) .....	13		
6.8L 413.8 (6784cc) OHV Diesel L6 106mm Bore (PowerTech 2V) .....	6	9.0L 549 (9000cc) OHV Turbo-Diesel L6 118.4mm Bore (PowerTech 4V AC).....	14		
6.8L 413.8 (6784cc) OHV Turbo-Diesel L6 106mm Bore (Litre Engine).....	7	9.0L 549 (9000cc) OHV Turbo-Diesel L6 118.4mm Bore (PowerTech 4V) .....	15		
6.8L 413.8 (6784cc) OHV Turbo-Diesel L6 106mm Bore (PowerTech 2V) .....	8	12.5L 764.6 (12534cc) OHV Turbo-Diesel L6 127mm Bore (PowerTech) .....	16		
<b>Engine Code Index</b>					
Engine Code	Engine Description	Line No.	Engine Code	Engine Description	Line No.
4045DFM ... Marine Applications.....	4.5L 275.8 (4522cc) OHV Diesel L4 106mm Bore (PowerTech 2V) .....	2	4045DFM70 ... Marine Applications.....	4.5L 275.8 (4522cc) OHV Diesel L4 106mm Bore (PowerTech 2V) .....	2
4045DFM50 ... Marine Applications.....	4.5L 275.8 (4522cc) OHV Diesel L4 106mm Bore (PowerTech 2V) .....	2	4045SFM ... Marine Applications.....	4.5L 275.8 (4522cc) OHV Turbo-Diesel L4 106mm Bore (PowerTech 2V IC) .....	1

(continued on next page)

\* New Item — Check For Availability

## Engine Code Index

Engine Code	Engine Description	Line No.	Engine Code	Engine Description	Line No.
4045TFM ... Marine Applications.....	4.5L 275.8 (4522cc) OHV Turbo-Diesel L4 106mm Bore (PowerTech 2V).....	3	6076TFM ... Marine Applications.....	7.6L 465.9 (7638cc) OHV Turbo-Diesel L6 115mm Bore (Litre Engine).....	9
6068DFM ... Marine Applications.....	6.8L 413.8 (6784cc) OHV Diesel L6 106mm Bore (PowerTech 2V).....	6	6081AFM ... Marine Applications.....	8.1L 495.9 (8129cc) OHV Turbo-Diesel L6 116mm Bore (PowerTech 2V AC).....	11
6068SFM ... Marine Applications.....	6.8L 413.8 (6784cc) OHV Turbo-Diesel L6 106mm Bore (PowerTech 2V IC).....	4	6081AFM01 ... Marine Applications.....	8.1L 495.9 (8129cc) OHV Turbo-Diesel L6 116mm Bore (PowerTech 2V AC).....	11
6068SFM ... Marine Applications.....	6.8L 413.8 (6784cc) OHV Turbo-Diesel L6 106mm Bore (PowerTech 4V IC).....	5	6081SFM ... Marine Applications.....	8.1L 495.9 (8129cc) OHV Turbo-Diesel L6 116mm Bore (PowerTech 2V IC).....	10
6068SFM75 ... Marine Applications.....	6.8L 413.8 (6784cc) OHV Turbo-Diesel L6 106mm Bore (PowerTech 2V IC).....	4	6081TFM ... Marine Applications.....	8.1L 495.9 (8129cc) OHV Turbo-Diesel L6 116mm Bore (PowerTech 2V).....	12
6068SFM75 ... Marine Applications.....	6.8L 413.8 (6784cc) OHV Turbo-Diesel L6 106mm Bore (PowerTech 4V IC).....	5	6090AFM75 ... Marine Applications.....	9.0L 549 (9000cc) OHV Turbo-Diesel L6 118.4mm Bore (PowerTech 4V AC).....	14
6068TFM ... Marine Applications.....	6.8L 413.8 (6784cc) OHV Turbo-Diesel L6 106mm Bore (Litre Engine).....	7	6125TFM ... Marine Applications.....	12.5L 764.6 (12534cc) OHV Turbo-Diesel L6 127mm Bore (PowerTech).....	16
6068TFM ... Marine Applications.....	6.8L 413.8 (6784cc) OHV Turbo-Diesel L6 106mm Bore (PowerTech 2V).....	8			

### 1 Marine Applications 4045H PowerTech Eng. (2-Valve Cyl. Head) 4.5L 275.8 (4522cc) OHV Turbo-Diesel L4 (PowerTech 2V IC), 106mm Bore

#### CYL. HEAD & PARTS

QTY	GASKETS	PART NO.	SIZE	DESCRIPTION
1	Valve Cover Gasket	FP-R123542		
1	Head Gasket	FP-R116515		
QTY	VALVE	PART NO.	SIZE	DESCRIPTION
4	Intake	FP-R98062	STD	1 groove; Chrome plated stem; 1.8350" Head Dia., .3100" Stem Dia., 5.2780" O.A.L.
4	Intake	FP-R97490	15	1 groove; Chrome plated stem; 1.8350" Head Dia., .3250" Stem Dia., 5.2780" O.A.L.
4	Exhaust	FP-R90692	STD	1 groove; Chrome plated stem; 1.6730" Head Dia., .3095" Stem Dia., 5.2550" O.A.L.
4	Exhaust	FP-R97492	15	1 groove; Chrome plated stem; 1.6730" Head Dia., .3245" Stem Dia., 5.2550" O.A.L.
16	Keeper	FP-R91889		Exh. & Int.
QTY	VALVE SPRING	PART NO.	SIZE	DESCRIPTION
8	Spring	FP-R26125		Exh. & Int.; 2.1200" Free Height
QTY	VALVE MISC.	PART NO.	SIZE	DESCRIPTION
8	Rotocap	FP-RE60005		Exh. & Int.
QTY	VALVE SEAL	PART NO.	SIZE	DESCRIPTION
8	Valve Stem Seal	FP-RE31617		Positive type
ELECTRICAL				
QTY	ELECTRICAL	PART NO.	SIZE	DESCRIPTION
1	Starter to Block Gasket	FP-R53108		3-Hole mount; Starting motor codes 3005, 3006, 3010, 3011, 3012
FUEL SYSTEM & PARTS				
QTY	FUEL INJECTION	PART NO.	SIZE	DESCRIPTION
4	Fuel Injector Nozzle	FP-RE48786		Nozzle codes 16BF, 16CE, 16CM, 16GL, 16LP, 16LQ, 16NH, 160R, 160S, 1606, 1608, 1675, 1677, 1682, 1683, 1692, 1694, 1695
4	Fuel Injector Nozzle	FP-RE48786		4045H Eng.; Nozzle codes 160B, 160C, 1610, 1611, 1656, 1667

(continued on next page)

**Marine Applications 4045H PowerTech Eng. (2-Valve Cyl. Head) 1**  
4.5L 275.8 (4522cc) OHV Turbo-Diesel L4 (PowerTech 2V IC), 106mm Bore (cont.)

<b>FUEL SYSTEM &amp; PARTS (cont.)</b>				
QTY	FUEL INJECTION (cont.)	PART NO.	SIZE	DESCRIPTION
4	Fuel Injector Seal	FP-R92352		Upper packing; w/Injector nozzle codes 16BF, 16CE, 16CM, 16CV, 16GL, 16LP, 16LQ, 16NH, 16OR, 1605, 1606, 1608, 1656, 1667, 1675, 1677, 1682, 1683, 1692, 1694, 1695
4	Fuel Injector Seal	FP-R92352		4045H Engs.; Upper packing; w/Injector nozzle codes 160B, 160C, 1610, 1611
4	Fuel Injector Nut	FP-R79604		w/Injector nozzle codes 16HM, 16HN, 16HP, 16HQ, 16LK, 16LL
1	Washer Type Seal	FP-R51936		Aux. drive line; Line codes 5201, 5202, 5203, 5205, 5206
2	Washer Type Seal	FP-R51936		Fuel line; Aftercooled; Line codes 160B, 1611
2	Washer Type Seal	FP-R51936		Fuel line; Line codes 16BF, 16CE, 16CM, 16CV, 16GL, 16LN, 16LP, 16LQ, 16NH, 16OR, 1605, 1671, 1677, 1682
<b>COOLING SYSTEM</b>				
QTY	WATER PUMP	PART NO.	SIZE	DESCRIPTION
1	Water Pump Filter	FP-R98527		w/Pump housing marked RE70683
<b>ENGINE BLOCK &amp; PARTS</b>				
QTY	GASKETS	PART NO.	SIZE	DESCRIPTION
1	Oil Pan Gasket	FP-R97342		Oil pan codes 1904, 1905; w/Stamped Steel Pan
2	O-Ring	FP-U13639		Block coolant drain plug seal; Coolant heater codes 2601, 2602; 1.475" X .118"
QTY	CAM BEARINGS	PART NO.	SIZE	DESCRIPTION
1	Cam Brg.	FP-R119874		
QTY	ENGINE BEARING MISC.	PART NO.	SIZE	DESCRIPTION
4	Balance Shaft Bearing	FP-R115299		Balance shaft code 4501
<b>CRANKSHAFT/OIL PUMP</b>				
QTY	SEALS - REAR CRANK	PART NO.	SIZE	DESCRIPTION
1	Crankshaft Rear Seal	FP-RE24959		
QTY	MAIN BEARINGS	PART NO.	SIZE	DESCRIPTION
4	Plain Main Brg.	FP-RE65165	STD	Crankshaft and Bearing code 4701
4	Plain Main Brg.	FP-RE65911	.25MM	Crankshaft and Bearing code 4701
1	Flanged Main Brg.	FP-RE65168	STD	Crankshaft and Bearing code 4701
1	Flanged Main Brg.	FP-RE65912	.25MM	Crankshaft and Bearing code 4701
<b>CYLINDER COMPONENTS</b>				
QTY	LINERS	PART NO.	SIZE	DESCRIPTION
4	Liner w/o Sealing Ring	FP-R121867	STD	
4	Cylinder Kit Complete	FP-RE507920	STD	Piston, Con. Rod, Cyl. liner code 4803; To Ser. No. 825,562
4	Cyl. Liner Sealing Ring Kit	FP-AR65507		
QTY	PISTONS	PART NO.	SIZE	DESCRIPTION
4	Piston Body w/o Pin	FP-RE505100	STD	Piston, Con. Rod, Cyl. liner code 4803; To Ser. No. 825,562; w/Con. Rod marked R123959; Small Pin
4	Piston Body w/o Pin	FP-RE55512	STD	Piston, Con. Rod, Cyl. liner code 4809; Large Pin; w/Con. Rod marked R500335
4	Pin	FP-R123178		Piston, Con. Rod, Cyl. liner code 4803; To Ser. No. 825,562; w/Con. Rod marked R123959; Small Pin; 1.375" pin dia.
4	Pin	FP-R123177		Piston, Con. Rod, Cyl. liner code 4809; w/Con. Rod marked R500335; Large Pin; 1.62" pin dia.
8	Piston Pin Retainer	FP-M41029		w/Con. Rod marked R123959; Small Pin; For 1.38" pin dia.
8	Piston Pin Retainer	FP-R54114		w/Con. Rod marked R500335; Large Pin; For 1.62" pin dia.
4	Pin Bushing	FP-R123960		w/Con. Rod marked R123959; Small Pin; 1.375" pin dia.
4	Pin Bushing	FP-R114082		w/Con. Rod marked R500335; Large Pin
4	Piston Pin Kit	FP-RE63915		4045H Engs.; Piston, Con. Rod, Cyl. liner code 4809; w/Con. Rod marked R500335; Large Pin; Incl. Pin, Retainers & Bushing
QTY	CONNECTING RODS & BRGS.	PART NO.	SIZE	DESCRIPTION
8	Con. Rod Bolt	FP-R114083		Cyl. Liner code 4803; w/Con. Rod marked R123959; To Ser. No. 793,991; Small Pin
8	Con. Rod Bolt	FP-R501124		Cyl. Liner code 4803; w/Con. Rod marked R123959, R500000; From Ser. No. 36,628
8	Con. Rod Bolt	FP-R501124		Cyl. Liner code 4809; w/Con. Rod marked R500000; From Ser. No. 36,628
8	Con. Rod Bolt	FP-R501124		Cyl. Liner code 4809; w/Con. Rod marked R500335; From Ser. No. 36,628
8	Con. Rod Bolt	FP-R114083		Cyl. Liner code 4809; w/Con. Rod marked R500335; To Ser. No. 793,991
8	Con. Rod Bolt	FP-R114083		Cyl. Liner code 4809; w/Con. Rod marked R500335; To Ser. No. 793,991; Small Pin

(continued on next page)

<b>1 Marine Applications 4045H PowerTech Eng. (2-Valve Cyl. Head)</b>				
(cont.) 4.5L 275.8 (4522cc) OHV Turbo-Diesel L4 (PowerTech 2V IC), 106mm Bore				
<b>CYLINDER COMPONENTS (cont.)</b>				
<b>CONNECTING RODS &amp; BRGS. (cont.)</b>				
QTY		PART NO.	SIZE	DESCRIPTION
4	Rod Pair	FP-RE65908	STD	Cyl. Liner code 4809; w/Con. Rod marked R500335
4	Rod Pair	FP-RE65909	.25MM	Cyl. Liner code 4809; w/Con. Rod marked R500335
4	Rod Pair	FP-RE65908	STD	Cyl. Liner codes 4801, 4803; w/Con. Rod marked R123959, R500000
4	Rod Pair	FP-RE65909	.25MM	Cyl. Liner codes 4801, 4803; w/Con. Rod marked R123959, R500000
<b>PISTON RINGS</b>				
QTY		PART NO.	SIZE	DESCRIPTION
4	Ring Set Single Cylinder	FP-RE66271	STD	Use w/piston marked RE520589
4	Ring Set Single Cylinder	FP-RE507852	STD	Use w/FP-RE55512 piston; 1-1/8, 1-3/32, 1-.136 (1 cyl. set)
4	Ring Set Single Cylinder	FP-RE66820	STD	Use w/FP-RE55512 piston; 1-1/8, 1-3/32, 1-.136 (1 cyl. set)
<b>KITS</b>				
QTY	OVERHAUL KIT	PART NO.	SIZE	DESCRIPTION
1	In-Frame Overhaul Kit	FP-IFKPT4045T		Piston, Con. Rod, Cyl. liner code 4803; To Ser. No. 825,562
<b>2 Marine Applications 4045D PowerTech Eng.</b>				
4.5L 275.8 (4522cc) OHV Diesel L4 (PowerTech 2V), 106mm Bore				
<b>CYL. HEAD &amp; PARTS</b>				
<b>GASKETS</b>				
QTY		PART NO.	SIZE	DESCRIPTION
1	Valve Cover Gasket	FP-R123542		
1	Head Gasket	FP-R116515		
<b>VALVE</b>				
QTY		PART NO.	SIZE	DESCRIPTION
4	Intake	FP-R98062	STD	1 groove; Chrome plated stem; 1.8350" Head Dia., .3100" Stem Dia., 5.2780" O.A.L.
4	Intake	FP-R97490	15	1 groove; Chrome plated stem; 1.8350" Head Dia., .3250" Stem Dia., 5.2780" O.A.L.
4	Exhaust	FP-R90692	STD	1 groove; Chrome plated stem; 1.6730" Head Dia., .3095" Stem Dia., 5.2550" O.A.L.
4	Exhaust	FP-R97492	15	1 groove; Chrome plated stem; 1.6730" Head Dia., .3245" Stem Dia., 5.2550" O.A.L.
16	Keeper	FP-R91889		Exh. & Int.
<b>VALVE SPRING</b>				
QTY		PART NO.	SIZE	DESCRIPTION
8	Spring	FP-R26125		Exh. & Int.; 2.1200" Free Height
<b>VALVE MISC.</b>				
QTY		PART NO.	SIZE	DESCRIPTION
8	Rotocap	FP-RE60005		Exh. & Int.
<b>VALVE SEAL</b>				
QTY		PART NO.	SIZE	DESCRIPTION
8	Valve Stem Seal	FP-RE31617		Exh. & Int.; Positive type
<b>ELECTRICAL</b>				
QTY	ELECTRICAL	PART NO.	SIZE	DESCRIPTION
1	Starter to Block Gasket	FP-R53108		3-Hole mount; Starting motor code 3012
<b>FUEL SYSTEM &amp; PARTS</b>				
<b>FUEL INJECTION</b>				
QTY		PART NO.	SIZE	DESCRIPTION
4	Fuel Injector Nozzle	FP-RE48786		Nozzle codes 16BG, 16BH, 1603
4	Fuel Injector Seal	FP-R92352		Upper packing; w/Injector nozzle codes 16HR, 16HS, 16HT, 16HU
4	Fuel Injector Nut	FP-R79604		w/Injector nozzle codes 16HR, 16HS, 16HT, 16HU
<b>ENGINE BLOCK &amp; PARTS</b>				
<b>CAM BEARINGS</b>				
QTY		PART NO.	SIZE	DESCRIPTION
1	Cam Brg.	FP-R119874		
<b>ENGINE BEARING MISC.</b>				
QTY		PART NO.	SIZE	DESCRIPTION
4	Balance Shaft Bearing	FP-R115299		Balance shaft code 4502
<b>CRANKSHAFT/OIL PUMP</b>				
<b>MAIN BEARINGS</b>				
QTY		PART NO.	SIZE	DESCRIPTION
4	Plain Main Brg.	FP-RE65165	STD	Crankshaft and Bearing code 4701; w/Crankshaft marked R113596
4	Plain Main Brg.	FP-RE65911	.25MM	Crankshaft and Bearing code 4701; w/Crankshaft marked R113596
1	Flanged Main Brg.	FP-RE65168	STD	Crankshaft and Bearing code 4701; w/Crankshaft marked R113596
1	Flanged Main Brg.	FP-RE65912	.25MM	Crankshaft and Bearing code 4701; w/Crankshaft marked R113596

(continued on next page)

**Marine Applications 4045D PowerTech Eng. 2**  
4.5L 275.8 (4522cc) OHV Diesel L4 (PowerTech 2V), 106mm Bore (cont.)

<b>CYLINDER COMPONENTS</b>				
<b>QTY</b>	<b>LINERS</b>	<b>PART NO.</b>	<b>SIZE</b>	<b>DESCRIPTION</b>
4	Liner w/o Sealing Ring	FP-R121867	STD	
4	Liner w/Sealing Rings	FP-RE500024	STD	
4	Cylinder Kit Complete	FP-RE65966	STD	Piston, Con. Rod, Cyl. liner code 4801
4	Cylinder Kit Complete	FP-RE507920	STD	Piston, Con. Rod, Cyl. liner code 4803; To Ser. No. 825,562
4	Cyl. Liner Sealing Ring Kit	FP-AR65507		
<b>QTY</b>	<b>PISTONS</b>	<b>PART NO.</b>	<b>SIZE</b>	<b>DESCRIPTION</b>
4	Piston Body w/o Pin	FP-RE505101	STD	Piston, Con. Rod, Cyl. liner code 4801
4	Piston Body w/o Pin	FP-RE505100	STD	Piston, Con. Rod, Cyl. liner code 4803; To Ser. No. 825,562; w/Con. Rod marked R123959; Small Pin
4	Pin	FP-R123178		Piston, Con. Rod, Cyl. liner code 4801; 1.375" pin dia.
8	Piston Pin Retainer	FP-M41029		Small Pin; For 1.38" pin dia.
4	Pin Bushing	FP-R123960		w/Con. Rod marked R123959; Small Pin; 1.375" pin dia.
<b>QTY</b>	<b>CONNECTING RODS &amp; BRGS.</b>	<b>PART NO.</b>	<b>SIZE</b>	<b>DESCRIPTION</b>
8	Con. Rod Bolt	FP-R501124		Cyl. Liner code 4801, 4803; w/Con. Rod marked R123959, R500000; From Ser. No. 36,628
8	Con. Rod Bolt	FP-R114083		Cyl. Liner codes 4801, 4803; w/Con. Rod marked R123959; To Ser. No. 793,991; Small Pin
4	Rod Pair	FP-RE65908	STD	Cyl. Liner code 4801; w/Con. Rod marked R123959
4	Rod Pair	FP-RE65909	.25MM	Cyl. Liner codes 4801, 4803; w/Con. Rod marked R123959, R500000
<b>QTY</b>	<b>PISTON RINGS</b>	<b>PART NO.</b>	<b>SIZE</b>	<b>DESCRIPTION</b>
4	Ring Set Single Cylinder	FP-RE66271	STD	Use w/FP-RE59277 piston
<b>KITS</b>				
<b>QTY</b>	<b>OVERHAUL KIT</b>	<b>PART NO.</b>	<b>SIZE</b>	<b>DESCRIPTION</b>
1	In-Frame Overhaul Kit	FP-IFKPT4045T		Piston, Con. Rod, Cyl. liner code 4803; Use w/RE59277, RE505100 piston; To Ser. No. 825,562

**Marine Applications 4045T PowerTech Eng. 3**  
4.5L 275.8 (4522cc) OHV Turbo-Diesel L4 (PowerTech 2V), 106mm Bore

<b>CYL. HEAD &amp; PARTS</b>				
<b>QTY</b>	<b>GASKETS</b>	<b>PART NO.</b>	<b>SIZE</b>	<b>DESCRIPTION</b>
1	Valve Cover Gasket	FP-R123542		
1	Head Gasket	FP-R116515		
<b>QTY</b>	<b>VALVE</b>	<b>PART NO.</b>	<b>SIZE</b>	<b>DESCRIPTION</b>
4	Intake	FP-R98062	STD	1 groove; Chrome plated stem; 1.8350" Head Dia., .3100" Stem Dia., 5.2780" O.A.L.
4	Intake	FP-R97490	15	1 groove; Chrome plated stem; 1.8350" Head Dia., .3250" Stem Dia., 5.2780" O.A.L.
4	Exhaust	FP-R90692	STD	1 groove; Chrome plated stem; 1.6730" Head Dia., .3095" Stem Dia., 5.2550" O.A.L.
4	Exhaust	FP-R97492	15	1 groove; Chrome plated stem; 1.6730" Head Dia., .3245" Stem Dia., 5.2550" O.A.L.
16	Keeper	FP-R91889		Exh. & Int.
<b>QTY</b>	<b>VALVE SPRING</b>	<b>PART NO.</b>	<b>SIZE</b>	<b>DESCRIPTION</b>
8	Spring	FP-R26125		Exh. & Int.; 2.1200" Free Height
<b>QTY</b>	<b>VALVE MISC.</b>	<b>PART NO.</b>	<b>SIZE</b>	<b>DESCRIPTION</b>
8	Rotocap	FP-RE60005		Exh. & Int.
<b>QTY</b>	<b>VALVE SEAL</b>	<b>PART NO.</b>	<b>SIZE</b>	<b>DESCRIPTION</b>
8	Valve Stem Seal	FP-RE31617		Exh. & Int.; Positive type
<b>ELECTRICAL</b>				
<b>QTY</b>	<b>ELECTRICAL</b>	<b>PART NO.</b>	<b>SIZE</b>	<b>DESCRIPTION</b>
1	Starter to Block Gasket	FP-R53108		3-Hole mount; Starting motor code 3012
<b>FUEL SYSTEM &amp; PARTS</b>				
<b>QTY</b>	<b>FUEL INJECTION</b>	<b>PART NO.</b>	<b>SIZE</b>	<b>DESCRIPTION</b>
4	Fuel Injector Nozzle	FP-RE48786		Nozzle codes 16HM, 16HN, 16HP, 16HQ, 16LK, 16LL
4	Fuel Injector Seal	FP-R92352		Upper packing; w/Injector nozzle codes 16HM, 16HN, 16HP, 16HQ, 16LK, 16LL
4	Fuel Injector Nut	FP-R79604		w/Injector nozzle codes 16HM, 16HN, 16HP, 16HQ, 16LK, 16LL
<b>QTY</b>	<b>TURBOCHARGER</b>	<b>PART NO.</b>	<b>SIZE</b>	<b>DESCRIPTION</b>
1	Turbo Exhaust Int. Cover Gskt	FP-R92097		

(continued on next page)

<b>3 Marine Applications 4045T PowerTech Eng.</b>				
(cont.) 4.5L 275.8 (4522cc) OHV Turbo-Diesel L4 (PowerTech 2V), 106mm Bore				
<b>ENGINE BLOCK &amp; PARTS</b>				
<b>QTY</b>	<b>CAM BEARINGS</b>	<b>PART NO.</b>	<b>SIZE</b>	<b>DESCRIPTION</b>
1	Cam Brg.	FP-R119874		
<b>QTY</b>	<b>ENGINE BEARING MISC.</b>	<b>PART NO.</b>	<b>SIZE</b>	<b>DESCRIPTION</b>
4	Balance Shaft Bearing	FP-R115299		Balance shaft codes 4501, 4502
<b>CRANKSHAFT/OIL PUMP</b>				
<b>QTY</b>	<b>MAIN BEARINGS</b>	<b>PART NO.</b>	<b>SIZE</b>	<b>DESCRIPTION</b>
4	Plain Main Brg.	FP-RE65165	STD	Crankshaft and Bearing code 4701; w/Crankshaft marked R113596
4	Plain Main Brg.	FP-RE65911	.25MM	Crankshaft and Bearing code 4701; w/Crankshaft marked R113596
1	Flanged Main Brg.	FP-RE65168	STD	Crankshaft and Bearing code 4701; w/Crankshaft marked R113596
1	Flanged Main Brg.	FP-RE65912	.25MM	Crankshaft and Bearing code 4701; w/Crankshaft marked R113596
<b>CYLINDER COMPONENTS</b>				
<b>QTY</b>	<b>LINERS</b>	<b>PART NO.</b>	<b>SIZE</b>	<b>DESCRIPTION</b>
4	Liner w/o Sealing Ring	FP-R121867	STD	
4	Liner w/Sealing Rings	FP-RE500024	STD	
4	Cylinder Kit Complete	FP-RE507920	STD	Piston, Con. Rod, Cyl. liner code 4803; To Ser. No. 825,562
4	Cyl. Liner Sealing Ring Kit	FP-AR65507		
<b>QTY</b>	<b>PISTONS</b>	<b>PART NO.</b>	<b>SIZE</b>	<b>DESCRIPTION</b>
4	Piston Body w/o Pin	FP-RE505100	STD	Piston, Con. Rod, Cyl. liner code 4803; To Ser. No. 825,562
4	Piston Body w/o Pin	FP-RE55512	STD	Piston, Con. Rod, Cyl. liner code 4809; Large Pin; w/Con. Rod marked R500335
4	Pin	FP-R123177		Piston, Con. Rod, Cyl. liner codes 4809, 4816; w/Con. Rod marked R500335; Large Pin; 1.62" pin dia.
8	Piston Pin Retainer	FP-R54114		w/Con. Rod marked R500335; Large Pin; For 1.62" pin dia.
4	Pin Bushing	FP-R123960		w/Con. Rod marked R123959; Small Pin; 1.375" pin dia.
4	Pin Bushing	FP-R114082		w/Con. Rod marked R500335; Large Pin
4	Piston Pin Kit	FP-RE63915		Piston, Con. Rod, Cyl. liner codes 4809, 4816; w/Con. Rod marked R500335; Large Pin; Incl. Pin, Retainers & Bushing
<b>QTY</b>	<b>CONNECTING RODS &amp; BRGS.</b>	<b>PART NO.</b>	<b>SIZE</b>	<b>DESCRIPTION</b>
8	Con. Rod Bolt	FP-R501124		Cyl. Liner code 4809; w/Con. Rod marked R500335
4	Rod Pair	FP-RE65908	STD	Cyl. Liner code 4809; w/Con. Rod marked R500335
4	Rod Pair	FP-RE65909	.25MM	Cyl. Liner code 4809; w/Con. Rod marked R500335
<b>QTY</b>	<b>PISTON RINGS</b>	<b>PART NO.</b>	<b>SIZE</b>	<b>DESCRIPTION</b>
4	Ring Set Single Cylinder	FP-RE507852	STD	Use w/FP-RE55512 piston; w/piston marked RE520589; 1-1/8, 1-3/32, 1-.136 (1 cyl. set)
4	Ring Set Single Cylinder	FP-RE66820	STD	Use w/FP-RE55512 piston; w/piston marked RE520589; 1-1/8, 1-3/32, 1-.136 (1 cyl. set)
<b>KITS</b>				
<b>QTY</b>	<b>OVERHAUL KIT</b>	<b>PART NO.</b>	<b>SIZE</b>	<b>DESCRIPTION</b>
1	In-Frame Overhaul Kit	FP-IFKPT4045T		Piston, Con. Rod, Cyl. liner code 4803; To Ser. No. 825,562
<b>4 Marine Applications 6068H PowerTech Eng. (2-Valve Cyl. Head)</b>				
6.8L 413.8 (6784cc) OHV Turbo-Diesel L6 (PowerTech 2V IC), 106mm Bore				
<b>CYL. HEAD &amp; PARTS</b>				
<b>QTY</b>	<b>GASKETS</b>	<b>PART NO.</b>	<b>SIZE</b>	<b>DESCRIPTION</b>
1	Valve Cover Gasket	FP-R123543		
1	Head Gasket	FP-R116516		
<b>QTY</b>	<b>VALVE</b>	<b>PART NO.</b>	<b>SIZE</b>	<b>DESCRIPTION</b>
6	Intake	FP-R98062	STD	1 groove; Chrome plated stem; 1.8350" Head Dia., .3100" Stem Dia., 5.2780" O.A.L.
6	Intake	FP-R97490	15	1 groove; Chrome plated stem; 1.8350" Head Dia., .3250" Stem Dia., 5.2780" O.A.L.
6	Exhaust	FP-R90692	STD	1 groove; Chrome plated stem; 1.6730" Head Dia., .3095" Stem Dia., 5.2550" O.A.L.
6	Exhaust	FP-R97492	15	1 groove; Chrome plated stem; 1.6730" Head Dia., .3245" Stem Dia., 5.2550" O.A.L.
24	Keeper	FP-R91889		
<b>QTY</b>	<b>VALVE SPRING</b>	<b>PART NO.</b>	<b>SIZE</b>	<b>DESCRIPTION</b>
12	Spring	FP-R26125		2.1200" Free Height

(continued on next page)

**Marine Applications 6068H PowerTech Eng. (2-Valve Cyl. Head) 4**  
6.8L 413.8 (6784cc) OHV Turbo-Diesel L6 (PowerTech 2V IC), 106mm Bore (cont.)

<b>CYL. HEAD &amp; PARTS (cont.)</b>				
<b>QTY</b>	<b>VALVE MISC.</b>	<b>PART NO.</b>	<b>SIZE</b>	<b>DESCRIPTION</b>
12	Rotocap	FP-RE60005		Exh. & Int.
<b>QTY</b>	<b>VALVE SEAL</b>	<b>PART NO.</b>	<b>SIZE</b>	<b>DESCRIPTION</b>
12	Valve Stem Seal	FP-RE31617		Exh. & Int.; From Ser. No. 300,000; Positive type
12	Valve Stem Seal	FP-R87627		Exh. & Int.; O-Ring type
<b>ELECTRICAL</b>				
<b>QTY</b>	<b>ELECTRICAL</b>	<b>PART NO.</b>	<b>SIZE</b>	<b>DESCRIPTION</b>
1	Starter to Block Gasket	FP-R53108		3-Hole mount; Starting motor codes 3003, 3006, 3010, 3011, 3013, 3025, 3026
<b>FUEL SYSTEM &amp; PARTS</b>				
<b>QTY</b>	<b>FUEL INJECTION</b>	<b>PART NO.</b>	<b>SIZE</b>	<b>DESCRIPTION</b>
6	Fuel Injector Nozzle	FP-RE48786		
6	Fuel Injector Seal	FP-R92352		Upper packing
6	Washer Type Seal	FP-R48000		Lower packing
12	Washer Type Seal	FP-R51936		Fuel line; Line codes 1613, 1614, 1615, 1619, 1621, 1622, 1623, 1668, 1678, 1680, 1681, 1685, 1686, 1688, 1697, 160D; To Ser. No. 715,739
12	Washer Type Seal	FP-R51936		Fuel line; Line codes 1619, 1681, 1685, 1686, 1696, 1697, 16CM, 16CN, 16CP, 16CW, 16CX, 16CY, 16DY, 16LS, 16LT, 16LU, 16MG, 16MH, 16ML, 16MM
<b>COOLING SYSTEM</b>				
<b>QTY</b>	<b>WATER PUMP</b>	<b>PART NO.</b>	<b>SIZE</b>	<b>DESCRIPTION</b>
1	Water Pump Filter	FP-R98527		w/Pump housing marked RE500734, RE70683, RE70985; High Flow
<b>ENGINE BLOCK &amp; PARTS</b>				
<b>QTY</b>	<b>GASKETS</b>	<b>PART NO.</b>	<b>SIZE</b>	<b>DESCRIPTION</b>
1	Oil Pan Gasket	FP-R123354		
2	O-Ring	FP-U13639		Block coolant drain plug seal; Coolant heater codes 2601, 2602; 1.475" X .118"
<b>QTY</b>	<b>CAM BEARINGS</b>	<b>PART NO.</b>	<b>SIZE</b>	<b>DESCRIPTION</b>
1	Cam Brg.	FP-R119874		
<b>CRANKSHAFT/OIL PUMP</b>				
<b>QTY</b>	<b>SEALS - REAR CRANK</b>	<b>PART NO.</b>	<b>SIZE</b>	<b>DESCRIPTION</b>
1	Crankshaft Rear Seal	FP-RE24959		
<b>QTY</b>	<b>MAIN BEARINGS</b>	<b>PART NO.</b>	<b>SIZE</b>	<b>DESCRIPTION</b>
6	Plain Main Brg.	FP-RE65165	STD	Crankshaft and Bearing codes 4702, 4703
6	Plain Main Brg.	FP-RE65911	.25MM	Crankshaft and Bearing codes 4702, 4703
1	Flanged Main Brg.	FP-RE65168	STD	Crankshaft and Bearing codes 4702, 4703
1	Flanged Main Brg.	FP-RE65912	.25MM	Crankshaft and Bearing codes 4702, 4703
<b>QTY</b>	<b>OIL PUMP</b>	<b>PART NO.</b>	<b>SIZE</b>	<b>DESCRIPTION</b>
1	O-Ring	FP-R61871		Oil tube from pump to block
<b>CYLINDER COMPONENTS</b>				
<b>QTY</b>	<b>LINERS</b>	<b>PART NO.</b>	<b>SIZE</b>	<b>DESCRIPTION</b>
6	Liner w/o Sealing Ring	FP-R121867	STD	
6	Liner w/Sealing Rings	FP-RE500024	STD	
6	Cylinder Kit Complete	FP-RE507920	STD	Con. Rod, Bearing & Piston codes 4807
6	Cyl. Liner Sealing Ring Kit	FP-AR65507		
<b>QTY</b>	<b>PISTONS</b>	<b>PART NO.</b>	<b>SIZE</b>	<b>DESCRIPTION</b>
6	Piston Body w/o Pin	FP-RE55512	STD	Con. Rod Bearing & Piston code 4810
6	Piston Body w/o Pin	FP-RE505100	STD	Con. Rod, Bearing & Piston codes 4807
6	Pin	FP-R123178		Con. Rod, Bearing & Piston code 4807; 1.375" pin dia.
6	Pin	FP-R123177		Con. Rod, Bearing & Piston codes 4810; 1.62" pin dia.
12	Piston Pin Retainer	FP-M41029		Con. Rod, Bearing & Piston codes 4805, 4807; For 1.38" pin dia.
12	Piston Pin Retainer	FP-R54114		Con. Rod, Bearing & Piston codes 4810; For 1.62" pin dia.
6	Pin Bushing	FP-R114082		Con. Rod, Bearing & Piston code 4810; w/Con. Rod marked R500335
6	Pin Bushing	FP-R123960		Con. Rod, Bearing & Piston codes 4807, 4810; 1.375" pin dia.
<b>QTY</b>	<b>CONNECTING RODS &amp; BRGS.</b>	<b>PART NO.</b>	<b>SIZE</b>	<b>DESCRIPTION</b>
12	Con. Rod Bolt	FP-R114083		Cyl. Liner code 4807; w/Con. Rod marked R123959; To Ser. No. 794,054

(continued on next page)

**4 Marine Applications 6068H PowerTech Eng. (2-Valve Cyl. Head)**  
 (cont.) 6.8L 413.8 (6784cc) OHV Turbo-Diesel L6 (PowerTech 2V IC), 106mm Bore

CYLINDER COMPONENTS (cont.)				
QTY	CONNECTING RODS & BRGS. (cont.)	PART NO.	SIZE	DESCRIPTION
12	Con. Rod Bolt	FP-R501124		Cyl. Liner code 4807; w/Con. Rod marked R500000; From Ser. No. 794,055
12	Con. Rod Bolt	FP-R114083		Cyl. Liner code 4810; w/Con. Rod marked R500335
12	Con. Rod Bolt	FP-R501124		Cyl. Liner code 4810; w/Con. Rod marked R500335
12	Con. Rod Bolt	FP-R501124		Cyl. Liner code 4810; w/Con. Rod marked R500335; From Ser. No. 794,055
12	Con. Rod Bolt	FP-R114083		Cyl. Liner codes 4807, 4810; w/Con. Rod marked R500000, R500335; From Ser. No. 794,055
6	Rod Pair	FP-RE65908	STD	Cyl. Liner codes 4807, 4810; w/Con. Rod marked R500000, R500335
6	Rod Pair	FP-RE65909	.25MM	Cyl. Liner codes 4807, 4810; w/Con. Rod marked R500000, R500335
QTY	PISTON RINGS	PART NO.	SIZE	DESCRIPTION
6	Ring Set Single Cylinder	FP-RE66271	STD	Piston & Liner code 4807
6	Ring Set Single Cylinder	FP-RE507852	STD	Piston & Liner code 4810; 1-1/8, 1-3/32, 1-.136 (1 cyl. set)
6	Ring Set Single Cylinder	FP-RE66820	STD	Piston & Liner code 4810; 1-1/8, 1-3/32, 1-.136 (1 cyl. set)

**5 Marine Applications 6068H PowerTech Eng. (4-Valve Cyl. Head)**  
 6.8L 413.8 (6784cc) OHV Turbo-Diesel L6 (PowerTech 4V IC), 106mm Bore

CYL. HEAD & PARTS				
QTY	GASKETS	PART NO.	SIZE	DESCRIPTION
1	Valve Cover Gasket	FP-R123543		
1	Head Gasket	FP-R116516		
QTY	VALVE	PART NO.	SIZE	DESCRIPTION
6	Intake	FP-R98062	STD	1 groove; Chrome plated stem; 1.8350" Head Dia., .3100" Stem Dia., 5.2780" O.A.L.
6	Intake	FP-R97490	15	1 groove; Chrome plated stem; 1.8350" Head Dia., .3250" Stem Dia., 5.2780" O.A.L.
6	Exhaust	FP-R90692	STD	1 groove; Chrome plated stem; 1.6730" Head Dia., .3095" Stem Dia., 5.2550" O.A.L.
6	Exhaust	FP-R97492	15	1 groove; Chrome plated stem; 1.6730" Head Dia., .3245" Stem Dia., 5.2550" O.A.L.
24	Keeper	FP-R91889		
QTY	VALVE SPRING	PART NO.	SIZE	DESCRIPTION
12	Spring	FP-R26125		2.1200" Free Height
QTY	VALVE MISC.	PART NO.	SIZE	DESCRIPTION
12	Rotocap	FP-RE60005		Exh. & Int.
QTY	VALVE SEAL	PART NO.	SIZE	DESCRIPTION
12	Valve Stem Seal	FP-RE31617		Exh. & Int.; From Ser. No. 300,000; Positive type
12	Valve Stem Seal	FP-R87627		Exh. & Int.; O-Ring type

ELECTRICAL				
QTY	ELECTRICAL	PART NO.	SIZE	DESCRIPTION
1	Starter to Block Gasket	FP-R53108		3-Hole mount; Starting motor codes 3003, 3006, 3010, 3011, 3013, 3025, 3026

FUEL SYSTEM & PARTS				
QTY	FUEL INJECTION	PART NO.	SIZE	DESCRIPTION
6	Fuel Injector Seal	FP-R92352		Upper packing
6	Washer Type Seal	FP-R48000		Lower packing
12	Washer Type Seal	FP-R51936		Fuel line; Line codes 1613, 1614, 1615, 1619, 1621, 1622, 1623, 1668, 1678, 1680, 1681, 1685, 1686, 1688, 1697, 160D; To Ser. No. 715,739
12	Washer Type Seal	FP-R51936		Fuel line; Line codes 1619, 1681, 1685, 1686, 1696, 1697, 16CM, 16CN, 16CP, 16CW, 16CX, 16CY, 16DY, 16LS, 16LT, 16LU, 16MG, 16MH, 16ML, 16MM

COOLING SYSTEM				
QTY	WATER PUMP	PART NO.	SIZE	DESCRIPTION
1	Water Pump Filter	FP-R98527		w/Pump housing marked RE70683, RE70985
1	Water Pump Filter	FP-R98527		w/Pump housing marked R500734; High Flow

ENGINE BLOCK & PARTS				
QTY	GASKETS	PART NO.	SIZE	DESCRIPTION
1	Oil Pan Gasket	FP-R123354		

(continued on next page)





**Marine Applications 6068H PowerTech Eng. (4-Valve Cyl. Head) 5**  
6.8L 413.8 (6784cc) OHV Turbo-Diesel L6 (PowerTech 4V IC), 106mm Bore (cont.)

<b>ENGINE BLOCK &amp; PARTS (cont.)</b>				
<b>QTY</b>	<b>GASKETS (cont.)</b>	<b>PART NO.</b>	<b>SIZE</b>	<b>DESCRIPTION</b>
2	O-Ring	FP-U13639		Block coolant drain plug seal; Coolant heater codes 2601, 2602; 1.475" X .118"
1	CAM BEARINGS Cam Brg.	FP-R119874		
<b>CRANKSHAFT/OIL PUMP</b>				
<b>QTY</b>	<b>SEALS - REAR CRANK</b>	<b>PART NO.</b>	<b>SIZE</b>	<b>DESCRIPTION</b>
1	Crankshaft Rear Seal	FP-RE24959		
<b>QTY</b>	<b>MAIN BEARINGS</b>	<b>PART NO.</b>	<b>SIZE</b>	<b>DESCRIPTION</b>
6	Plain Main Brg.	FP-RE65165	STD	Crankshaft and Bearing codes 4702, 4703
6	Plain Main Brg.	FP-RE65911	.25MM	Crankshaft and Bearing codes 4702, 4703
1	Flanged Main Brg.	FP-RE65168	STD	Crankshaft and Bearing codes 4702, 4703
1	Flanged Main Brg.	FP-RE65912	.25MM	Crankshaft and Bearing codes 4702, 4703
<b>QTY</b>	<b>OIL PUMP</b>	<b>PART NO.</b>	<b>SIZE</b>	<b>DESCRIPTION</b>
1	O-Ring	FP-R61871		Oil tube from pump to block
<b>CYLINDER COMPONENTS</b>				
<b>QTY</b>	<b>LINERS</b>	<b>PART NO.</b>	<b>SIZE</b>	<b>DESCRIPTION</b>
6	Liner w/o Sealing Ring	FP-R121867	STD	
6	Liner w/Sealing Rings	FP-RE500024	STD	
6	Cylinder Kit Complete	FP-RE507920	STD	Con. Rod, Bearing & Piston codes 4807
6	Cyl. Liner Sealing Ring Kit	FP-AR65507		
<b>QTY</b>	<b>PISTONS</b>	<b>PART NO.</b>	<b>SIZE</b>	<b>DESCRIPTION</b>
6	Piston Body w/o Pin	FP-RE55512	STD	Con. Rod Bearing & Piston code 4810
6	Piston Body w/o Pin	FP-RE505100	STD	Con. Rod, Bearing & Piston codes 4807
6	Pin	FP-R123178		Con. Rod, Bearing & Piston code 4807; 1.375" pin dia.
6	Pin	FP-R123177		Con. Rod, Bearing & Piston codes 4810; 1.62" pin dia.
12	Piston Pin Retainer	FP-M41029		Con. Rod, Bearing & Piston codes 4805, 4807; For 1.38" pin dia.
12	Piston Pin Retainer	FP-R54114		Con. Rod, Bearing & Piston codes 4810; For 1.62" pin dia.
6	Pin Bushing	FP-R114082		Con. Rod, Bearing & Piston code 4810; w/Con. Rod marked R500335
6	Pin Bushing	FP-R123960		Con. Rod, Bearing & Piston codes 4807, 4810; 1.375" pin dia.
6	Piston Pin Kit	FP-RE63915		Con. Rod, Bearing & Piston codes 4810; Incl. Pin, Retainers & Bushing
<b>QTY</b>	<b>CONNECTING RODS &amp; BRGS.</b>	<b>PART NO.</b>	<b>SIZE</b>	<b>DESCRIPTION</b>
12	Con. Rod Bolt	FP-R114083		Cyl. Liner code 4807; w/Con. Rod marked R123959; To Ser. No. 794,054
12	Con. Rod Bolt	FP-R501124		Cyl. Liner code 4807; w/Con. Rod marked R500000; From Ser. No. 794,055
12	Con. Rod Bolt	FP-R114083		Cyl. Liner code 4810; w/Con. Rod marked R500335
12	Con. Rod Bolt	FP-R501124		Cyl. Liner code 4810; w/Con. Rod marked R500335
12	Con. Rod Bolt	FP-R501124		Cyl. Liner code 4810; w/Con. Rod marked R500335; From Ser. No. 794,055
12	Con. Rod Bolt	FP-R114083		Cyl. Liner codes 4807, 4810; w/Con. Rod marked R500000, R500335; From Ser. No. 794,055
6	Rod Pair	FP-RE65908	STD	Cyl. Liner codes 4807, 4810; w/Con. Rod marked R500000, R500335
6	Rod Pair	FP-RE65909	.25MM	Cyl. Liner codes 4807, 4810; w/Con. Rod marked R500000, R500335
<b>QTY</b>	<b>PISTON RINGS</b>	<b>PART NO.</b>	<b>SIZE</b>	<b>DESCRIPTION</b>
6	Ring Set Single Cylinder	FP-RE66271	STD	Piston & Liner code 4807
6	Ring Set Single Cylinder	FP-RE507852	STD	Piston & Liner code 4810; 1-1/8, 1-3/32, 1-.136 (1 cyl. set)
6	Ring Set Single Cylinder	FP-RE66820	STD	Piston & Liner code 4810; 1-1/8, 1-3/32, 1-.136 (1 cyl. set)

**Marine Applications 6068D PowerTech Eng. 6**  
6.8L 413.8 (6784cc) OHV Diesel L6 (PowerTech 2V), 106mm Bore

<b>CYL. HEAD &amp; PARTS</b>				
<b>QTY</b>	<b>GASKETS</b>	<b>PART NO.</b>	<b>SIZE</b>	<b>DESCRIPTION</b>
1	Valve Cover Gasket	FP-R123543		
1	Head Gasket	FP-R116516		
<b>QTY</b>	<b>VALVE</b>	<b>PART NO.</b>	<b>SIZE</b>	<b>DESCRIPTION</b>
6	Intake	FP-R98062	STD	1 groove; Chrome plated stem; 1.8350" Head Dia., .3100" Stem Dia., 5.2780" O.A.L.
6	Exhaust	FP-R90692	STD	1 groove; Chrome plated stem; 1.6730" Head Dia., .3095" Stem Dia., 5.2550" O.A.L.

(continued on next page)

<b>6 Marine Applications 6068D PowerTech Eng.</b>				
<b>(cont.)</b> 6.8L 413.8 (6784cc) OHV Diesel L6 (PowerTech 2V), 106mm Bore				
<b>CYL. HEAD &amp; PARTS (cont.)</b>				
QTY	VALVE (cont.)	PART NO.	SIZE	DESCRIPTION
24	Keeper	FP-R91889		
QTY	VALVE SPRING	PART NO.	SIZE	DESCRIPTION
12	Spring	FP-R26125		2.1200" Free Height
QTY	VALVE SEAL	PART NO.	SIZE	DESCRIPTION
12	Valve Stem Seal	FP-RE31617		Exh. & Int.; Positive type
<b>ELECTRICAL</b>				
QTY	ELECTRICAL	PART NO.	SIZE	DESCRIPTION
1	Starter to Block Gasket	FP-R53108		3-Hole mount; Starting motor codes 3003, 3006, 3010, 3011, 3013, 3025, 3026
<b>INT &amp; EXH MANIFOLDS</b>				
QTY	INT. & EXH. MANIFOLDS	PART NO.	SIZE	DESCRIPTION
1	Air Intake Gasket	FP-R81275		Air intake tube to manifold gskt.
<b>FUEL SYSTEM &amp; PARTS</b>				
QTY	FUEL INJECTION	PART NO.	SIZE	DESCRIPTION
6	Fuel Injector Nozzle	FP-RE48786		Injector nozzle codes 16FA, 16FC, 16FD, 16FE, 16FF
6	Fuel Injector Seal	FP-R79605		Fuel line connection; 9.270MM X 13.600MM X 5.080MM
6	Fuel Injector Seal	FP-R92352		Upper packing
6	Fuel Injector Nut	FP-R79604		Use w/FP-RE48786 nozzle
<b>COOLING SYSTEM</b>				
QTY	THERMOSTAT	PART NO.	SIZE	DESCRIPTION
2	Thermostat	FP-AR48675		Thermostat code 2206; Thermostat cover code 2123; 180 Deg.
<b>ENGINE BLOCK &amp; PARTS</b>				
QTY	GASKETS	PART NO.	SIZE	DESCRIPTION
1	Oil Pan Gasket	FP-R123354		
2	O-Ring	FP-U13639		Adapter seal; Coolant heater codes 2601, 2602; 1.475" X .118"
2	O-Ring	FP-U13639		Block coolant drain plug seal; 1.475" X .118"
QTY	CAM BEARINGS	PART NO.	SIZE	DESCRIPTION
1	Cam Brg.	FP-R119874		
<b>CRANKSHAFT/OIL PUMP</b>				
QTY	MAIN BEARINGS	PART NO.	SIZE	DESCRIPTION
6	Plain Main Brg.	FP-RE65165	STD	Crankshaft and Bearing code 4703
6	Plain Main Brg.	FP-RE65911	.25MM	Crankshaft and Bearing code 4703
1	Flanged Main Brg.	FP-RE65168	STD	Crankshaft and Bearing code 4703
1	Flanged Main Brg.	FP-RE65912	.25MM	Crankshaft and Bearing code 4703
QTY	OIL PUMP	PART NO.	SIZE	DESCRIPTION
1	O-Ring	FP-R72328		Elbow seal; Ventilating code 2915
4	O-Ring	FP-R56462		Oil filter adapter tube Codes 8814, 8816; R.H. high mount
1	O-Ring	FP-R61871		Oil tube from pump to block
<b>CYLINDER COMPONENTS</b>				
QTY	LINERS	PART NO.	SIZE	DESCRIPTION
6	Liner w/o Sealing Ring	FP-R121867	STD	
6	Liner w/Sealing Rings	FP-RE500024	STD	
6	Cyl. Liner Sealing Ring Kit	FP-AR65507		
QTY	CONNECTING RODS & BRGS.	PART NO.	SIZE	DESCRIPTION
6	Rod Pair	FP-RE65908	STD	Con. Rod, Bearing & Piston code 4810; w/Con. Rod marked R500335
6	Rod Pair	FP-RE65909	.25MM	Con. Rod, Bearing & Piston code 4810; w/Con. Rod marked R500335
<b>7 Marine Applications 6068T Eng.</b>				
6.8L 413.8 (6784cc) OHV Turbo-Diesel L6 (Litre Engine), 106mm Bore				
<b>CYL. HEAD &amp; PARTS</b>				
QTY	GASKETS	PART NO.	SIZE	DESCRIPTION
1	Head Set	FP-RE29859		Cyl. head code 5101
QTY	VALVE	PART NO.	SIZE	DESCRIPTION
6	Intake	FP-R98062	STD	1 groove; Chrome plated stem; 1.8350" Head Dia., .3100" Stem Dia., 5.2780" O.A.L.

(continued on next page)



*Marine Applications 6068T Eng. 7*  
6.8L 413.8 (6784cc) OHV Turbo-Diesel L6 (Litre Engine), 106mm Bore (cont.)

<b>CYL. HEAD &amp; PARTS (cont.)</b>				
QTY	VALVE (cont.)	PART NO.	SIZE	DESCRIPTION
6	Intake	FP-R97490	15	1 groove; Chrome plated stem; 1.8350" Head Dia., .3250" Stem Dia., 5.2780" O.A.L.
6	Exhaust	FP-R90692	STD	1 groove; Chrome plated stem; 1.6730" Head Dia., .3095" Stem Dia., 5.2550" O.A.L.
6	Exhaust	FP-R97492	15	1 groove; Chrome plated stem; 1.6730" Head Dia., .3245" Stem Dia., 5.2550" O.A.L.
24	Keeper	FP-R91889		
QTY	VALVE SEAT	PART NO.	SIZE	DESCRIPTION
6	Exh.	FP-R85687	STD	
6	Int.	FP-R98335		.020" Dia. O/S face width; 1.8575" OD, 1.5500" ID, .2580" Depth
6	Int.	FP-R98063	STD	1.8575" OD, 1.5500" ID, .2580" Depth
QTY	VALVE SPRING	PART NO.	SIZE	DESCRIPTION
12	Spring	FP-R26125		2.1200" Free Height
QTY	VALVE MISC.	PART NO.	SIZE	DESCRIPTION
12	Rotocap	FP-RE60005		Exh. & Int.
QTY	VALVE SEAL	PART NO.	SIZE	DESCRIPTION
12	Valve Stem Seal	FP-RE31617		Exh. & Int.; From Ser. No. 300,000; Positive type
12	Valve Stem Seal	FP-R87627		Exh. & Int.; O-Ring type
<b>FUEL SYSTEM &amp; PARTS</b>				
QTY	FUEL INJECTION	PART NO.	SIZE	DESCRIPTION
6	Fuel Injector Nozzle	FP-RE36939		w/Injector marked 28484
6	Fuel Injector Nut	FP-R79604		w/Injector marked 28484
<b>COOLING SYSTEM</b>				
QTY	WATER PUMP	PART NO.	SIZE	DESCRIPTION
1	Water Pump Shaft	FP-R82052		w/Pump housing marked R80168
1	Water Pump Impeller	FP-R47191		w/Pump housing marked R66420, R68733
1	Water Pump Impeller	FP-R56812		w/Pump housing marked R80168, R90784, R104648, R120869
1	Water Pump Repair/Rebuild Kit	FP-RE19511		w/Pump housing marked R60601, R67741, R67748, R72644
1	Water Pump Repair/Rebuild Kit	FP-RE70143		From Ser. No. 100,000 to Ser. No. 499,999; w/Cast iron impeller
2	Ball Brg.	FP-JD7686		Front/Rear shaft bearing; Pump code 2025; w/Pump housing marked R80168, R120869; w/H/D water pump
2	Ball Brg.	FP-JD7686		Front/Rear shaft bearing; Pump code 2025; RePower Engs.; w/Pump housing marked R80168
2	Ball Brg.	FP-JD10329		Front & Rear; Fan hub shaft bearing; w/Pump housing marked R120869, R80168
1	Shaft & Bearing Assembly	FP-JD8643		w/Pump housing marked R90784, R104648
QTY	THERMOSTAT	PART NO.	SIZE	DESCRIPTION
2	Thermostat	FP-AR48675		Thermostat code 2204; Thermostat cover code 2102 Vertical, 2104 Horizontal; Housing code 3901; 180 Deg.
<b>ENGINE BLOCK &amp; PARTS</b>				
QTY	CAM BEARINGS	PART NO.	SIZE	DESCRIPTION
1	Cam Brg.	FP-R119874		From Ser. No. 100,000 to Ser. No. 499,999
<b>CRANKSHAFT/OIL PUMP</b>				
QTY	CRANKSHAFT	PART NO.	SIZE	DESCRIPTION
1	Crankshaft	FP-RE45517		
QTY	MAIN BEARINGS	PART NO.	SIZE	DESCRIPTION
6	Plain Main Brg.	FP-RE27352	STD	w/Flangeless thrust brg.
6	Plain Main Brg.	FP-RE27353	10	w/Flangeless thrust brg.
6	Plain Main Brg.	FP-RE27360	20	w/Flangeless thrust brg.
6	Plain Main Brg.	FP-RE27368	30	w/Flangeless thrust brg.
1	Flanged Main Brg.	FP-RE521350	STD	
1	Flanged Main Brg.	FP-RE526754	10	
1	Flanged Main Brg.	FP-RE527235	20	
1	Flanged Main Brg.	FP-RE527236	30	
<b>CYLINDER COMPONENTS</b>				
QTY	LINERS	PART NO.	SIZE	DESCRIPTION
6	Liner w/o Sealing Ring	FP-R121867	STD	
6	Liner w/Sealing Rings	FP-RE500024	STD	
6	Cylinder Kit Complete	FP-RE53073	STD	Hi-Ring
6	Cyl. Liner Sealing Ring Kit	FP-AR65507		
6	Sealing Ring, Liner	FP-R48767		Rectangle; Top
6	Sealing Ring, Liner	FP-R26121		Round; Middle

(continued on next page)

<b>7 Marine Applications 6068T Eng.</b>				
<b>(cont.) 6.8L 413.8 (6784cc) OHV Turbo-Diesel L6 (Litre Engine), 106mm Bore</b>				
<b>CYLINDER COMPONENTS (cont.)</b>				
<b>QTY</b>	<b>LINERS (cont.)</b>	<b>PART NO.</b>	<b>SIZE</b>	<b>DESCRIPTION</b>
6	Sealing Ring	FP-SLR2520		Round; Bottom
<b>QTY</b>	<b>PISTONS</b>	<b>PART NO.</b>	<b>SIZE</b>	<b>DESCRIPTION</b>
6	Pin Bushing	FP-R114082		Con. Rod, Bearing & Piston code 4810; w/Con. Rod marked R500335
<b>QTY</b>	<b>CONNECTING RODS &amp; BRGS.</b>	<b>PART NO.</b>	<b>SIZE</b>	<b>DESCRIPTION</b>
12	Con. Rod Bolt	FP-R74195		w/Con. Rod marked R54617, R56187, R116851; Torque-To-Yield bolt; Replacement recommended
6	Rod Pair	FP-AR97517	STD	
6	Rod Pair	FP-AR97653	10	
6	Rod Pair	FP-AR97654	20	
6	Rod Pair	FP-AR97655	30	
<b>QTY</b>	<b>PISTON RINGS</b>	<b>PART NO.</b>	<b>SIZE</b>	<b>DESCRIPTION</b>
6	Ring Set Single Cylinder	FP-RE507852	STD	1-1/8, 1-3/32, 1-.136 (1 cyl. set)
6	Ring Set Single Cylinder	FP-RE66820	STD	1-1/8, 1-3/32, 1-.136 (1 cyl. set)
<b>KITS</b>				
<b>QTY</b>	<b>OVERHAUL KIT</b>	<b>PART NO.</b>	<b>SIZE</b>	<b>DESCRIPTION</b>
1	In-Frame Overhaul Kit	FP-6068TIFK		w/Con. Rod marked R54617, R56187, R116851; w/Flangeless thrust brg.; Hi-Ring; Incl. Torque-To-Yield con. rod bolts
1	Complete Overhaul Kit	FP-6068TOHK		From Ser. No. 100,000 to Ser. No. 499,999; w/Con. Rod marked R54617, R56187, R116851; w/Flangeless thrust brg.; Hi-Ring; Incl. Torque-To-Yield con. rod bolts
<b>8 Marine Applications 6068T PowerTech Eng.</b>				
<b>6.8L 413.8 (6784cc) OHV Turbo-Diesel L6 (PowerTech 2V), 106mm Bore</b>				
<b>CYL. HEAD &amp; PARTS</b>				
<b>QTY</b>	<b>GASKETS</b>	<b>PART NO.</b>	<b>SIZE</b>	<b>DESCRIPTION</b>
1	Valve Cover Gasket	FP-R123543		
1	Head Gasket	FP-R116516		
<b>QTY</b>	<b>VALVE</b>	<b>PART NO.</b>	<b>SIZE</b>	<b>DESCRIPTION</b>
6	Intake	FP-R98062	STD	1 groove; Chrome plated stem; 1.8350" Head Dia., .3100" Stem Dia., 5.2780" O.A.L.
6	Exhaust	FP-R90692	STD	1 groove; Chrome plated stem; 1.6730" Head Dia., .3095" Stem Dia., 5.2550" O.A.L.
24	Keeper	FP-R91889		
<b>QTY</b>	<b>VALVE SPRING</b>	<b>PART NO.</b>	<b>SIZE</b>	<b>DESCRIPTION</b>
12	Spring	FP-R26125		2.1200" Free Height
<b>QTY</b>	<b>VALVE SEAL</b>	<b>PART NO.</b>	<b>SIZE</b>	<b>DESCRIPTION</b>
12	Valve Stem Seal	FP-RE31617		Exh. & Int.; Positive type
<b>ELECTRICAL</b>				
<b>QTY</b>	<b>ELECTRICAL</b>	<b>PART NO.</b>	<b>SIZE</b>	<b>DESCRIPTION</b>
1	Starter to Block Gasket	FP-R53108		3-Hole mount; Starting motor codes 3003, 3006, 3010, 3011, 3013, 3025, 3026
<b>INT &amp; EXH MANIFOLDS</b>				
<b>QTY</b>	<b>INT. &amp; EXH. MANIFOLDS</b>	<b>PART NO.</b>	<b>SIZE</b>	<b>DESCRIPTION</b>
1	Air Intake Gasket	FP-R81275		Air intake tube to manifold gskt.
<b>FUEL SYSTEM &amp; PARTS</b>				
<b>QTY</b>	<b>FUEL INJECTION</b>	<b>PART NO.</b>	<b>SIZE</b>	<b>DESCRIPTION</b>
6	Fuel Injector Nozzle	FP-RE48786		Injector nozzle codes 16FA, 16FC, 16FD, 16FE, 16FF
6	Fuel Injector Seal	FP-R79605		Fuel line connection; Nozzle codes 1622, 1623, 1642, 1643, 1654; Nozzle marked 28484; 9.270MM X 13.600MM X 5.080MM
6	Fuel Injector Seal	FP-R92352		Upper packing
6	Fuel Injector Nut	FP-R79604		Use w/FP-RE48786 nozzle
6	Washer Type Seal	FP-R48000		Lower packing
12	Washer Type Seal	FP-R51936		Fuel line; Line codes 16FA, 16FB, 16FC, 16FD, 16FE, 16FF
<b>COOLING SYSTEM</b>				
<b>QTY</b>	<b>THERMOSTAT</b>	<b>PART NO.</b>	<b>SIZE</b>	<b>DESCRIPTION</b>
2	Thermostat	FP-AR48675		Thermostat code 2206; Thermostat cover code 2123; 180 Deg.

(continued on next page)

**Marine Applications 6068T PowerTech Eng. 8**  
6.8L 413.8 (6784cc) OHV Turbo-Diesel L6 (PowerTech 2V), 106mm Bore (cont.)

ENGINE BLOCK & PARTS				
<b>QTY</b>	<b>GASKETS</b>	<b>PART NO.</b>	<b>SIZE</b>	<b>DESCRIPTION</b>
2	O-Ring	FP-U13639		Adapter seal; Coolant heater codes 2601, 2602; 1.475" X .118"
2	O-Ring	FP-U13639		Block coolant drain plug seal; 1.475" X .118"
<b>QTY</b>	<b>CAM BEARINGS</b>	<b>PART NO.</b>	<b>SIZE</b>	<b>DESCRIPTION</b>
1	Cam Brg.	FP-R119874		
CRANKSHAFT/OIL PUMP				
<b>QTY</b>	<b>MAIN BEARINGS</b>	<b>PART NO.</b>	<b>SIZE</b>	<b>DESCRIPTION</b>
6	Plain Main Brg.	FP-RE65165	STD	Crankshaft and Bearing codes 4702, 4703; w/Crankshaft marked R116076
6	Plain Main Brg.	FP-RE65911	.25MM	Crankshaft and Bearing codes 4702, 4703; w/Crankshaft marked R116076
1	Flanged Main Brg.	FP-RE65168	STD	Crankshaft and Bearing codes 4702, 4703; w/Crankshaft marked R116076
1	Flanged Main Brg.	FP-RE65912	.25MM	Crankshaft and Bearing codes 4702, 4703; w/Crankshaft marked R116076
<b>QTY</b>	<b>OIL PUMP</b>	<b>PART NO.</b>	<b>SIZE</b>	<b>DESCRIPTION</b>
1	O-Ring	FP-R72328		Elbow seal; Ventilating code 2915
4	O-Ring	FP-R56462		Oil filter adapter tube codes 8814, 8816; R.H. high mount
1	O-Ring	FP-R61871		Oil tube from pump to block
CYLINDER COMPONENTS				
<b>QTY</b>	<b>LINERS</b>	<b>PART NO.</b>	<b>SIZE</b>	<b>DESCRIPTION</b>
6	Liner w/o Sealing Ring	FP-R121867	STD	
6	Liner w/Sealing Rings	FP-RE500024	STD	
6	Cyl. Liner Sealing Ring Kit	FP-AR65507		
<b>QTY</b>	<b>PISTONS</b>	<b>PART NO.</b>	<b>SIZE</b>	<b>DESCRIPTION</b>
6	Pin	FP-R123177		Con. Rod, Bearing & Piston codes 4810; 1.62" pin dia.
12	Piston Pin Retainer	FP-R54114		Con. Rod, Bearing & Piston codes 4810; For 1.62" pin dia.
6	Pin Bushing	FP-R114082		w/Con. Rod code 4810; w/Con. Rod marked R500335
<b>QTY</b>	<b>CONNECTING RODS &amp; BRGS.</b>	<b>PART NO.</b>	<b>SIZE</b>	<b>DESCRIPTION</b>
12	Con. Rod Bolt	FP-R501124		Cyl. Liner code 4810; w/Con. Rod marked R500335
6	Rod Pair	FP-RE65908	STD	Cyl. Liner code 4810; w/Con. Rod marked R500335
6	Rod Pair	FP-RE65909	.25MM	Cyl. Liner code 4810; w/Con. Rod marked R500335
<b>QTY</b>	<b>PISTON RINGS</b>	<b>PART NO.</b>	<b>SIZE</b>	<b>DESCRIPTION</b>
6	Ring Set Single Cylinder	FP-RE507852	STD	Piston & Liner code 4810; 1-1/8, 1-3/32, 1-.136 (1 cyl. set)
6	Ring Set Single Cylinder	FP-RE66820	STD	Piston & Liner code 4810; 1-1/8, 1-3/32, 1-.136 (1 cyl. set)

**Marine Applications 6076TFM Eng. 9**  
7.6L 465.9 (7638cc) OHV Turbo-Diesel L6 (Litre Engine), 115mm Bore

CYL. HEAD & PARTS				
<b>QTY</b>	<b>GASKETS</b>	<b>PART NO.</b>	<b>SIZE</b>	<b>DESCRIPTION</b>
1	Head Gasket	FP-RE47336		Cyl. head code 5104
<b>QTY</b>	<b>VALVE</b>	<b>PART NO.</b>	<b>SIZE</b>	<b>DESCRIPTION</b>
6	Intake	FP-R84618	STD	Cyl. head code 5104; Marked R86427; 1 groove; Chrome plated stem; 2.0080" Head Dia., .3730" Stem Dia., 6.0600" O.A.L.
6	Intake	FP-R93308	3	Cyl. head code 5104; Marked R86427; 1 groove; Chrome plated stem; 2.0080" Head Dia., .3760" Stem Dia., 6.0600" O.A.L.
6	Exhaust	FP-R84619	STD	Cyl. head code 5104; Marked R86427; 1 groove; Chrome plated stem; 1.8500" Head Dia., .3720" Stem Dia., 6.1780" O.A.L.
6	Exhaust	FP-R93311	3	Cyl. head code 5104; Marked R86427; 1 groove; Chrome plated stem; 1.8500" Head Dia., .3750" Stem Dia., 6.1780" O.A.L.
12	Valve Stem Cap	FP-T20129		
<b>QTY</b>	<b>VALVE SEAT</b>	<b>PART NO.</b>	<b>SIZE</b>	<b>DESCRIPTION</b>
6	Exh.	FP-R84976	STD	Cyl. head code 5104; Marked R86427
6	Exh.	FP-R93349	10	Cyl. head code 5104; Marked R86427
6	Int.	FP-R84977	STD	Cyl. head code 5104; Marked R86427
6	Int.	FP-R93350	10	Cyl. head code 5104; Marked R86427
<b>QTY</b>	<b>VALVE SPRING</b>	<b>PART NO.</b>	<b>SIZE</b>	<b>DESCRIPTION</b>
12	Spring	FP-R91822		Cyl. head code 5104
<b>QTY</b>	<b>VALVE MISC.</b>	<b>PART NO.</b>	<b>SIZE</b>	<b>DESCRIPTION</b>
12	Rotocap	FP-RE11410		Exh. & Int.; Cyl. head code 5104
1	Oil Filler Cap Gasket	FP-T20328		

(continued on next page)

<b>9 Marine Applications 6076TFM Eng.</b>				
<b>(cont.) 7.6L 465.9 (7638cc) OHV Turbo-Diesel L6 (Litre Engine), 115mm Bore</b>				
<b>ELECTRICAL</b>				
QTY	ALTERNATOR	PART NO.	SIZE	DESCRIPTION
1	Ball Brg.	FP-JD9449		Front; Delco-Remy components; Code 3132; 24 Volt, 40 amp alternator
1	Ball Brg.	FP-JD9449		Front; Nippondenso components; Code 3137; 12 Volt, 70 amp alternator
1	Ball Brg.	FP-JD9449		Front; Nippondenso components; Code 3143; 12 Volt, 90 amp alternator; Poly-Vee fan drive
2	Ball Brg.	FP-JD9449		Front & Rear; Delco-Remy No. 1101345; Code 3114; 12 Volt, 78 amp alternator
2	Ball Brg.	FP-JD9449		Front & Rear; Motorola No. 70D42179T02; 24 Volt, 45 amp alternator
<b>INT &amp; EXH MANIFOLDS</b>				
QTY	INT. & EXH. MANIFOLDS	PART NO.	SIZE	DESCRIPTION
3	Intake Manifold Gasket	FP-R130573		w/Int. manifolds R108608, R127872, R132293
<b>FUEL SYSTEM &amp; PARTS</b>				
QTY	FUEL INJECTION	PART NO.	SIZE	DESCRIPTION
1	Washer	FP-R53901		Control valve seal to housing; Pump housing codes 1604, 1652, 1683; Filter & line codes 1601, 1604, 1606, 1611, 1622, 1623, 1637, 1644, 1650, 1652, 1656, 1667, 1687, 3512, 3513, 3521, 3528
1	Washer	FP-R53901		Control valve seal to housing; Pump housing codes 1610, 1640; Filter & line codes 1611, 1612, 1613, 1616, 1637, 1650, 1654, 1656, 1667, 1676, 1678, 1686; To Ser. No. 568,899
1	Washer	FP-R53901		Control valve seal to housing; Pump housing codes 1650, 1655, 3511; Filter & line codes 1611, 1612, 1613, 1616, 1637, 1650, 1654, 1656, 1667, 1676, 1678, 1686
1	Washer	FP-R53899		Control valve to pump housing seal; Fuel filter codes 3512, 3521; To Ser. No. 102,986
1	Washer	FP-R53899		Control valve to pump housing seal; Pump housing codes 1610, 1616, 1626, 1640, 1641, 1650, 1654; Fuel filter codes 3502, 3503, 3511, 3513
6	Washer	FP-R84472		Injector nozzle; Nozzle codes 1604, 1610, 1611, 1615, 1622, 1623, 1625, 1626, 1640, 1641, 1644, 1652, 1655, 1656, 1657, 1680, 1683, 1688, 1689; To Ser. No. 568,899; .290" X .715" X .079"
6	Washer	FP-R84472		Injector nozzle; Nozzle codes 1610, 1612, 1613, 1654, 1676; From Ser. No. 500,000; .290" X .715" X .079"
6	Fuel Injector Nut	FP-R79604		Inj. pump; Line codes 1601, 1604, 1623, 1637, 1644, 1652, 1667, 1680, 1683, 1686, 1688
13	Washer Type Seal	FP-R51936		Leak-off & return line seals; Nozzle codes 1618, 1619, 1643, 1668
<b>COOLING SYSTEM</b>				
QTY	WATER PUMP	PART NO.	SIZE	DESCRIPTION
1	Water Pump Shaft	FP-R70965		Water pump codes 2014, 2032; w/Pump marked R83561; Gear driven pump
1	Water Pump Impeller	FP-R71225		w/Pump housing marked R85677
1	Water Pump Repair/Rebuild Kit	FP-RE69847		w/Pump housing marked R83561; Gear driven pump
2	Ball Brg.	FP-JD10329		Fan hub shaft bearing
1	Ball Brg.	FP-JD10363		Gear driven front bearing; Water pump code 2037; w/Pump housing marked R85677
1	Ball Brg.	FP-JD10362		Gear driven rear bearing; Water pump code 2037; w/Pump housing marked R85677
1	Oil Seal	FP-RE39134		Water pump code 2037; w/Pump housing marked R85677
2	O-Ring	FP-R71732		Pump by-pass; Pump codes 8002, 8003
1	O-Ring	FP-R71596		Pump cover; Water pump code 2037; w/Pump housing marked R83561
1	Water Pump Hub	FP-JD10058		w/Fan Hub bearing codes 2317, 2318, 2320, 2324, 2327, 2328, 2329, 2330, 2331, 2332, 2334, 2335, 2336, 2338, 2339, 2340
1	Water Pump Filter	FP-R98527		w/Pump housing marked R85677
QTY	THERMOSTAT	PART NO.	SIZE	DESCRIPTION
2	O-Ring	FP-R47153		Thermostat; Water manifold codes 3904, 3912
<b>ENGINE BLOCK &amp; PARTS</b>				
QTY	GASKETS	PART NO.	SIZE	DESCRIPTION
1	Oil Pan Gasket	FP-R49377		w/Alum. pan; Oil pan code 1920
1	Oil Pan Gasket Set	FP-PG400PS		w/Cast iron oil pan

(continued on next page)



*Marine Applications 6076TFM Eng. 9*  
7.6L 465.9 (7638cc) OHV Turbo-Diesel L6 (Litre Engine), 115mm Bore (cont.)

<b>ENGINE BLOCK &amp; PARTS (cont.)</b>				
<b>QTY</b>	<b>CAM BEARINGS</b>	<b>PART NO.</b>	<b>SIZE</b>	<b>DESCRIPTION</b>
1	Cam Brg.	FP-R87561		
<b>QTY</b>	<b>OIL COOLERS &amp; FILTERS</b>	<b>PART NO.</b>	<b>SIZE</b>	<b>DESCRIPTION</b>
1	Aftercooler Gasket Set	FP-6076A		To Ser. No. 100,770; w/housing No. R50398
1	Aftercooler Gasket Set	FP-6076ADP		Use w/housing Nos. R90995, R93918, R110232
2	Aftercooler Gasket	FP-R88993		From Ser. No. 100,177
2	Aftercooler Gasket	FP-R97347		6076A Engs.
1	Oil Cooler	FP-AT25038		
1	O-Ring	FP-R52811		Intercooler inlet & outlet tube seals; Int. manifold code 1726; To Ser. No. 100,770
4	O-Ring	FP-R47153		Cooler tube
2	O-Ring	FP-R47153		Oil filter tube; Oil filter code 5931
1	Oil Cooler Bypass Gasket	FP-R65055		
1	Oil Cooler Cover Gasket	FP-R128558		From Ser. No. 500,000
1	Oil Cooler Cover Gasket	FP-R50419		To Ser. No. 499,999
1	Oil Cooler Housing Cover Gskt	FP-R128557		From Ser. No. 500,000
<b>CRANKSHAFT/OIL PUMP</b>				
<b>QTY</b>	<b>CRANKSHAFT</b>	<b>PART NO.</b>	<b>SIZE</b>	<b>DESCRIPTION</b>
1	Crankshaft	FP-RE53422		Gears incl.; Short snout 3.000"
1	Crankshaft	FP-AR96189		Gears not incl.
1	Oil Seal Kit	FP-SK49025		Incl. front & rear seals
<b>QTY</b>	<b>SEALS - FRONT CRANK</b>	<b>PART NO.</b>	<b>SIZE</b>	<b>DESCRIPTION</b>
1	Oil Seal Kit	FP-AR49025		
<b>QTY</b>	<b>SEALS - REAR CRANK</b>	<b>PART NO.</b>	<b>SIZE</b>	<b>DESCRIPTION</b>
1	Oil Seal	FP-RE22764		PTFE
<b>QTY</b>	<b>MAIN BEARINGS</b>	<b>PART NO.</b>	<b>SIZE</b>	<b>DESCRIPTION</b>
1	Main Set	FP-MBK400L4	STD	w/5 main brgs.
1	Main Set	FP-MBK400L410	10	w/5 main brgs.
1	Main Set	FP-MBK400L420	20	w/5 main brgs.
1	Main Set	FP-MBK400L6	STD	w/7 main brgs.
1	Main Set	FP-MBK400L610	10	w/7 main brgs.
1	Main Set	FP-MBK400L620	20	w/7 main brgs.
1	Main Set	FP-MBK400L630	30	w/7 main brgs.
5	Plain Main Brg.	FP-AR74814	STD	
5	Plain Main Brg.	FP-AR74816	10	
5	Plain Main Brg.	FP-AR74817	20	
5	Plain Main Brg.	FP-AR74818	30	
1	Flanged Main Brg.	FP-AR77748	STD	
1	Flanged Main Brg.	FP-AR77750	10	
1	Flanged Main Brg.	FP-AR77751	20	
1	Flanged Main Brg.	FP-AR77752	30	
1	Thrust Washer Set	FP-AR77747	STD	
<b>QTY</b>	<b>OIL PUMP</b>	<b>PART NO.</b>	<b>SIZE</b>	<b>DESCRIPTION</b>
3	O-Ring	FP-R71732		Pump by-pass tubes; Pump code 2702
1	O-Ring	FP-R50405		Intake coupling; Large end; Int. manifold codes 1706, 1709, 1710, 1726, 1731, 1737, 1738
1	Rect. or Square Seal	FP-R43660		Filter to housing; Filter & body code 5919; w/housing marked R120412
1	Oil Pump Intake Elbow Gasket	FP-R71312		w/Rear deep sump; Oil pump code 5003; Oil pan code 1906
1	Oil Filter to Block Gasket	FP-R43774		
<b>CYLINDER COMPONENTS</b>				
<b>QTY</b>	<b>LINERS</b>	<b>PART NO.</b>	<b>SIZE</b>	<b>DESCRIPTION</b>
6	Liner w/o Sealing Ring	FP-R87858		
6	Liner w/Sealing Rings	FP-R87858WS		
6	Cylinder Kit Complete	FP-RE60294	STD	w/Con. Rod marked R71074; From Ser. No. 193,861
6	Cylinder Kit Complete	FP-RE48739	STD	w/Con. Rod marked R71074; To Ser. No. 193,860
6	Cyl. Liner Sealing Ring Kit	FP-AR98850		
<b>QTY</b>	<b>PISTONS</b>	<b>PART NO.</b>	<b>SIZE</b>	<b>DESCRIPTION</b>
6	Piston Body w/o Pin	FP-RE57512	STD	From Ser. No. 500,000
6	Piston Body w/o Pin	FP-RE50868	STD	To Ser. No. 499,999
6	Piston Kit w/Pin & Retainers	FP-RE57512WP	STD	From Ser. No. 500,000
6	Piston Kit w/Pin & Retainers	FP-RE50868WP	STD	To Ser. No. 499,999
6	Pin	FP-R57771		Piston, Con. Rod, Cyl. liner codes 4802, 4803
12	Piston Pin Retainer	FP-E1343FN		

(continued on next page)

<b>9 Marine Applications 6076TFM Eng.</b>				
(cont.) 7.6L 465.9 (7638cc) OHV Turbo-Diesel L6 (Litre Engine), 115mm Bore				
<b>CYLINDER COMPONENTS (cont.)</b>				
<b>QTY</b>	<b>PISTONS (cont.)</b>	<b>PART NO.</b>	<b>SIZE</b>	<b>DESCRIPTION</b>
6	Pin Bushing	FP-R74008		Piston, Con. Rod, Cyl. liner codes 4802, 4803; w/Con. Rod marked R71074; From Ser. No. 253,373; 1.877" ID, 2.0622 OD, 1.8728" O.A.L.
<b>QTY</b>	<b>CONNECTING RODS &amp; BRGS.</b>	<b>PART NO.</b>	<b>SIZE</b>	<b>DESCRIPTION</b>
12	Con. Rod Bolt	FP-R66452		Piston, Con. Rod, Cyl. liner codes 4802, 4803; w/Con. Rod marked R71074; Torque-To-Yield bolt; Replacement recommended
6	Rod Pair	FP-AR73277	STD	Piston, Con. Rod, Cyl. liner codes 4802, 4803; w/Con. Rod marked R71074
6	Rod Pair	FP-AR73279	10	Piston, Con. Rod, Cyl. liner codes 4802, 4803; w/Con. Rod marked R71074
6	Rod Pair	FP-AR73280	20	Piston, Con. Rod, Cyl. liner codes 4802, 4803; w/Con. Rod marked R71074
6	Rod Pair	FP-AR73281	30	Piston, Con. Rod, Cyl. liner codes 4802, 4803; w/Con. Rod marked R71074
<b>QTY</b>	<b>PISTON RINGS</b>	<b>PART NO.</b>	<b>SIZE</b>	<b>DESCRIPTION</b>
6	Ring Set Single Cylinder	FP-RE57517	STD	From Ser. No. 193,861
6	Ring Set Single Cylinder	FP-RE48380	STD	To Ser. No. 193,860; 2-5/32, 1-3/16 (1 cyl. set)
<b>KITS</b>				
<b>QTY</b>	<b>OVERHAUL KIT</b>	<b>PART NO.</b>	<b>SIZE</b>	<b>DESCRIPTION</b>
1	In-Frame Overhaul Kit	FP-6076LIFK		w/Con. Rod marked R71074; From Ser. No. 193,861; Incl. Torque-To-Yield con. rod bolts
1	In-Frame Overhaul Kit	FP-6076EIFK		w/Con. Rod marked R71074; To Ser. No. 193,860; Incl. Torque-To-Yield con. rod bolts
1	Complete Overhaul Kit	FP-6076LOHK		w/Con. Rod marked R71074; From Ser. No. 193,861; Incl. Torque-To-Yield con. rod bolts
1	Complete Overhaul Kit	FP-6076EOHK		w/Con. Rod marked R71074; To Ser. No. 193,860; Incl. Torque-To-Yield con. rod bolts
<b>10 Marine Applications 6081H PowerTech Eng. (2-Valve Cyl. Head)</b>				
8.1L 495.9 (8129cc) OHV Turbo-Diesel L6 (PowerTech 2V IC), 116mm Bore				
<b>CYL. HEAD &amp; PARTS</b>				
<b>QTY</b>	<b>GASKETS</b>	<b>PART NO.</b>	<b>SIZE</b>	<b>DESCRIPTION</b>
1	Valve Cover Gasket	FP-R49866		Rocker cover codes 1102, 1105, 2912
1	Head Gasket	FP-RE55475		
1	Head Set	FP-RE57186		
<b>QTY</b>	<b>VALVE</b>	<b>PART NO.</b>	<b>SIZE</b>	<b>DESCRIPTION</b>
6	Intake	FP-R84618	STD	1 groove; Chrome plated stem; 2.0080" Head Dia., .3730" Stem Dia., 6.0600" O.A.L.
6	Intake	FP-R93308	3	1 groove; Chrome plated stem; 2.0080" Head Dia., .3760" Stem Dia., 6.0600" O.A.L.
6	Exhaust	FP-R84619	STD	1 groove; Chrome plated stem; 1.8500" Head Dia., .3720" Stem Dia., 6.1780" O.A.L.
6	Exhaust	FP-R93311	3	1 groove; Chrome plated stem; 1.8500" Head Dia., .3750" Stem Dia., 6.1780" O.A.L.
12	Valve Stem Cap	FP-T20129		Exh. & Int.
24	Keeper	FP-T20077		Exh. & Int.; 1 groove; Square cut key groove; Hardened
<b>QTY</b>	<b>VALVE SEAT</b>	<b>PART NO.</b>	<b>SIZE</b>	<b>DESCRIPTION</b>
6	Exh.	FP-R119132	STD	
6	Exh.	FP-R93349	10	
6	Int.	FP-R121193	STD	
6	Int.	FP-R93350	10	
<b>QTY</b>	<b>VALVE SPRING</b>	<b>PART NO.</b>	<b>SIZE</b>	<b>DESCRIPTION</b>
12	Spring	FP-R91822		Exh. & Int.
<b>QTY</b>	<b>VALVE MISC.</b>	<b>PART NO.</b>	<b>SIZE</b>	<b>DESCRIPTION</b>
1	Oil Filler Cap Gasket	FP-T20328		Rocker arm cover codes 1105, 2912
<b>ELECTRICAL</b>				
<b>QTY</b>	<b>ALTERNATOR</b>	<b>PART NO.</b>	<b>SIZE</b>	<b>DESCRIPTION</b>
1	Ball Brg.	FP-JD9449		Front; Code 3143; 12 Volt, 90 amp alternator; Poly-Vee fan drive
<b>INT &amp; EXH MANIFOLDS</b>				
<b>QTY</b>	<b>INT. &amp; EXH. MANIFOLDS</b>	<b>PART NO.</b>	<b>SIZE</b>	<b>DESCRIPTION</b>
2	Exhaust Manifold Gasket	FP-R83020		Codes 2802, 3830; w/two holes; Two Exh. holes
2	Exhaust Manifold Gasket	FP-R83021		Codes 2802, 3830; One Exh. hole

(continued on next page)



**Marine Applications 6081H PowerTech Eng. (2-Valve Cyl. Head) 10**  
 8.1L 495.9 (8129cc) OHV Turbo-Diesel L6 (PowerTech 2V IC), 116mm Bore (cont.)

<b>INT &amp; EXH MANIFOLDS (cont.)</b>				
<b>QTY</b>	<b>INT. &amp; EXH. MANIFOLDS (cont.)</b>	<b>PART NO.</b>	<b>SIZE</b>	<b>DESCRIPTION</b>
3	Intake Manifold Gasket	FP-R130573		w/Int. manifolds R127427, R131652
<b>CAMSHAFT GROUP</b>				
<b>QTY</b>	<b>TIMING COVER</b>	<b>PART NO.</b>	<b>SIZE</b>	<b>DESCRIPTION</b>
1	Crankshaft Front Cover Gasket	FP-R26058		Housing to block gskt.
<b>FUEL SYSTEM &amp; PARTS</b>				
<b>QTY</b>	<b>FUEL INJECTION</b>	<b>PART NO.</b>	<b>SIZE</b>	<b>DESCRIPTION</b>
1	Washer	FP-R53899		Control valve to pump housing seal; Inj. pump housing connector codes 1616, 1621, 1632, 1633, 1634, 1635, 1636, 1641, 1655, 1657, 1658, 1659
2	Washer	FP-R53901		Fuel inj. pump connector seal; Filter & line codes 1603, 1604, 1605, 1607, 1608, 1609, 1610, 1611, 1612, 1613, 1615, 1617, 1618, 1619, 1620, 1622, 1623, 1624, 1640, 1656, 1676; w/Bosch pump
6	Washer	FP-R84472		Injector nozzle; Nozzle codes 1601, 1602, 1603, 1604, 1605, 1606, 1607, 1608, 1609, 1613, 1615, 1620, 1621, 1622, 1624, 1630, 1632, 1633, 1635, 1639, 1642, 1648, 1651, 1655, 1657, 1659, 1661, 1662, 1663, 1676; .290" X .715" X .079"
6	Fuel Injector Nut	FP-R79604		Injector line codes 1601, 1602
13	Washer Type Seal	FP-R51936		Fuel line; Line codes 1601, 1602, 1603, 1604, 1605, 1606, 1608, 1610, 1611, 1612, 1616, 1617, 1618, 1619, 1632, 1634, 1636, 1640, 1641, 1643, 1644, 1645, 1646, 1647, 1648, 1649, 1650, 1656, 1661, 1662, 1663, 1667
<b>QTY</b>	<b>TURBOCHARGER</b>	<b>PART NO.</b>	<b>SIZE</b>	<b>DESCRIPTION</b>
1	Turbocharger Oil Drain Gasket	FP-R105346		w/Turbo oil line codes 6501, 6503, 6504, 6505, 6506, 6507, 6508, 6510, 6511, 6512, 6513, 6529, 6530, 6531
1	Turbocharger Mounting Gasket	FP-R89879		
1	O-Ring	FP-R86743		Outer coupling
1	Turbo Exhaust Int. Cover Gskt	FP-R92097		Turbo code 6514
<b>COOLING SYSTEM</b>				
<b>QTY</b>	<b>WATER PUMP</b>	<b>PART NO.</b>	<b>SIZE</b>	<b>DESCRIPTION</b>
2	Ball Brg.	FP-JD10329		Fan hub shaft bearing
1	Water Pump Gasket	FP-R119383		w/Pump housing marked R119795; w/15 tooth gear; High flow
1	Water Pump Gasket	FP-R119383		w/Pump housing marked R119795; w/16 tooth gear; Low flow
1	Oil Seal	FP-RE39134		Water pump codes 2001, 2004; w/Pump housing marked R119795
1	Water Pump Hub	FP-JD10058		w/Fan Hub bearing codes 2305, 2306, 2335, 2336, 2337, 2338, 2339
1	Water Pump Filter	FP-R98527		w/Pump housing marked R119795
<b>QTY</b>	<b>THERMOSTAT</b>	<b>PART NO.</b>	<b>SIZE</b>	<b>DESCRIPTION</b>
2	Thermostat	FP-AR48675		Thermostat code 2204; 180 Deg.
1	Thermostat Gasket	FP-R124211		Thermostat housing to cyl. head
1	Thermostat Cover Gasket	FP-R46479		Thermostat cover codes 2102, 2114; Two hole
1	Therm. Hsg. - Water Mfld. Gsk	FP-R86062		Housing to cyl. head
<b>QTY</b>	<b>MISCELLANEOUS</b>	<b>PART NO.</b>	<b>SIZE</b>	<b>DESCRIPTION</b>
2	Water Manifold Mounting Gskt.	FP-R88397		
<b>ENGINE BLOCK &amp; PARTS</b>				
<b>QTY</b>	<b>GASKETS</b>	<b>PART NO.</b>	<b>SIZE</b>	<b>DESCRIPTION</b>
1	Front Cover Gasket	FP-R125670		Air compressor to timing cover; Midland or Holset
1	Front Cover Gasket	FP-R119384		Timing gear cover
1	Oil Pan Gasket	FP-R49377		w/Alum. pan; Oil pan codes 1906, 1909, 1914, 1916
1	Oil Pan Gasket	FP-R71918		w/Cast Iron pan
1	O-Ring	FP-U13639		Block coolant drain plug seal; Coolant heater codes 2601, 2602; 1.475" X .118"
<b>QTY</b>	<b>GASKET SETS</b>	<b>PART NO.</b>	<b>SIZE</b>	<b>DESCRIPTION</b>
1	Complete Overhaul Gasket Set	FP-RE57187		From Ser. No. 500,000; Crankshaft seals not incl.
<b>QTY</b>	<b>CAM BEARINGS</b>	<b>PART NO.</b>	<b>SIZE</b>	<b>DESCRIPTION</b>
4	Cam Brg.	FP-R87561		
<b>QTY</b>	<b>OIL COOLERS &amp; FILTERS</b>	<b>PART NO.</b>	<b>SIZE</b>	<b>DESCRIPTION</b>
1	Aftercooler Gasket	FP-R88993		w/Int. manifold codes 1703, 1738
2	Aftercooler Gasket	FP-R88993		w/Int. manifold codes 1705, 1737
1	Oil Cooler	FP-AR55394		
4	O-Ring	FP-R47153		Cooler tube; Cooler code 5901
4	O-Ring	FP-R47153		Oil filter tube; Filter code 5901

(continued on next page)

<b>10 Marine Applications 6081H PowerTech Eng. (2-Valve Cyl. Head)</b> (cont.) 8.1L 495.9 (8129cc) OHV Turbo-Diesel L6 (PowerTech 2V IC), 116mm Bore				
<b>ENGINE BLOCK &amp; PARTS (cont.)</b>				
<b>OIL COOLERS &amp; FILTERS</b>				
<b>QTY</b>		<b>PART NO.</b>	<b>SIZE</b>	<b>DESCRIPTION</b>
(cont.)				
1	Oil Cooler Housing Gasket	FP-AR58952		
2	Oil Cooler Adapter Gasket Set	FP-R50424		
<b>CRANKSHAFT/OIL PUMP</b>				
<b>QTY</b>	<b>SEALS - FRONT CRANK</b>	<b>PART NO.</b>	<b>SIZE</b>	<b>DESCRIPTION</b>
1	Oil Seal Kit	FP-AR49025		
<b>QTY</b>	<b>SEALS - REAR CRANK</b>	<b>PART NO.</b>	<b>SIZE</b>	<b>DESCRIPTION</b>
1	Oil Seal	FP-RE22764		PTFE
<b>QTY</b>	<b>MAIN BEARINGS</b>	<b>PART NO.</b>	<b>SIZE</b>	<b>DESCRIPTION</b>
6	Plain Main Brg.	FP-RE529319	STD	
1	Flanged Main Brg.	FP-RE529320	STD	
<b>QTY</b>	<b>OIL PUMP</b>	<b>PART NO.</b>	<b>SIZE</b>	<b>DESCRIPTION</b>
2	O-Ring	FP-U17409		Oil cooler relief valve plug seal; Filter & housing code 5901
1	Oil Pump Intake Gasket	FP-R100569		Oil pump pickup codes 1906, 1909, 1916
1	Oil Filter Base Gasket	FP-R119847		Housing to block gskt.
<b>CYLINDER COMPONENTS</b>				
<b>QTY</b>	<b>LINERS</b>	<b>PART NO.</b>	<b>SIZE</b>	<b>DESCRIPTION</b>
6	Liner w/o Sealing Ring	FP-R520212	STD	
6	Cyl. Liner Sealing Ring Kit	FP-AR98850		
<b>QTY</b>	<b>PISTONS</b>	<b>PART NO.</b>	<b>SIZE</b>	<b>DESCRIPTION</b>
6	Pin	FP-R57771		
12	Piston Pin Retainer	FP-E1343FN		
6	Pin Bushing	FP-R74008		w/Con. Rod marked R11634, R501034; 1.877" ID, 2.0622 OD, 1.8728" O.A.L.
<b>QTY</b>	<b>CONNECTING RODS &amp; BRGS.</b>	<b>PART NO.</b>	<b>SIZE</b>	<b>DESCRIPTION</b>
12	Con. Rod Bolt	FP-R66452		To Ser. No. 086,535; w/Con. Rod marked R116340; Torque-To-Yield bolt; Replacement recommended
6	Rod Bearing Half Upper/Lower	FP-R525767	STD	
<b>QTY</b>	<b>PISTON RINGS</b>	<b>PART NO.</b>	<b>SIZE</b>	<b>DESCRIPTION</b>
6	Ring Set Single Cylinder	FP-RE503528	STD	
<b>11 Marine Applications 6081A PowerTech Eng. (2-Valve Cyl. Head)</b> 8.1L 495.9 (8129cc) OHV Turbo-Diesel L6 (PowerTech 2V AC), 116mm Bore				
<b>CYL. HEAD &amp; PARTS</b>				
<b>QTY</b>	<b>GASKETS</b>	<b>PART NO.</b>	<b>SIZE</b>	<b>DESCRIPTION</b>
1	Valve Cover Gasket	FP-R49866		Rocker cover codes 1102, 1105, 2912
1	Head Gasket	FP-RE55475		
1	Head Set	FP-RE57186		
<b>QTY</b>	<b>VALVE</b>	<b>PART NO.</b>	<b>SIZE</b>	<b>DESCRIPTION</b>
6	Intake	FP-R84618	STD	1 groove; Chrome plated stem; 2.0080" Head Dia., .3730" Stem Dia., 6.0600" O.A.L.
6	Intake	FP-R93308	3	1 groove; Chrome plated stem; 2.0080" Head Dia., .3760" Stem Dia., 6.0600" O.A.L.
6	Exhaust	FP-R84619	STD	1 groove; Chrome plated stem; 1.8500" Head Dia., .3720" Stem Dia., 6.1780" O.A.L.
6	Exhaust	FP-R93311	3	1 groove; Chrome plated stem; 1.8500" Head Dia., .3750" Stem Dia., 6.1780" O.A.L.
12	Valve Stem Cap	FP-T20129		Exh. & Int.
24	Keeper	FP-T20077		Exh. & Int.; 1 groove; Square cut key groove; Hardened
<b>QTY</b>	<b>VALVE SEAT</b>	<b>PART NO.</b>	<b>SIZE</b>	<b>DESCRIPTION</b>
6	Exh.	FP-R119132	STD	
6	Exh.	FP-R93349	10	
6	Int.	FP-R121193	STD	
6	Int.	FP-R93350	10	
<b>QTY</b>	<b>VALVE SPRING</b>	<b>PART NO.</b>	<b>SIZE</b>	<b>DESCRIPTION</b>
12	Spring	FP-R91822		Exh. & Int.
<b>QTY</b>	<b>VALVE MISC.</b>	<b>PART NO.</b>	<b>SIZE</b>	<b>DESCRIPTION</b>
1	Oil Filler Cap Gasket	FP-T20328		Rocker arm cover codes 1105, 2912

(continued on next page)

**Marine Applications 6081A PowerTech Eng. (2-Valve Cyl. Head) 11**  
8.1L 495.9 (8129cc) OHV Turbo-Diesel L6 (PowerTech 2V AC), 116mm Bore (cont.)

<b>ELECTRICAL</b>				
<b>QTY</b>	<b>ALTERNATOR</b>	<b>PART NO.</b>	<b>SIZE</b>	<b>DESCRIPTION</b>
1	Ball Brg.	FP-JD9449		Front; Code 3143; 12 Volt, 90 amp alternator; Poly-Vee fan drive
<b>INT &amp; EXH MANIFOLDS</b>				
<b>QTY</b>	<b>INT. &amp; EXH. MANIFOLDS</b>	<b>PART NO.</b>	<b>SIZE</b>	<b>DESCRIPTION</b>
2	Exhaust Manifold Gasket	FP-R83020		Codes 2802, 3830; w/two holes; Two Exh. holes
2	Exhaust Manifold Gasket	FP-R83021		Codes 2802, 3830; One Exh. hole
3	Intake Manifold Gasket	FP-R130573		w/Int. manifolds R127427, R131652
<b>CAMSHAFT GROUP</b>				
<b>QTY</b>	<b>TIMING COVER</b>	<b>PART NO.</b>	<b>SIZE</b>	<b>DESCRIPTION</b>
1	Crankshaft Front Cover Gasket	FP-R26058		Housing to block gskt.
<b>FUEL SYSTEM &amp; PARTS</b>				
<b>QTY</b>	<b>FUEL INJECTION</b>	<b>PART NO.</b>	<b>SIZE</b>	<b>DESCRIPTION</b>
1	Washer	FP-R53899		Control valve to pump housing seal; Inj. pump housing connector codes 1616, 1621, 1632, 1633, 1634, 1635, 1636, 1641, 1655, 1657, 1658, 1659
2	Washer	FP-R53901		Fuel inj. pump connector seal; Filter & line codes 1603, 1604, 1605, 1607, 1608, 1609, 1610, 1611, 1612, 1613, 1615, 1617, 1618, 1619, 1620, 1622, 1623, 1624, 1640, 1656, 1676; w/Bosch pump
6	Washer	FP-R84472		Injector nozzle; Nozzle codes 1601, 1602, 1603, 1604, 1605, 1606, 1607, 1608, 1609, 1613, 1615, 1620, 1621, 1622, 1624, 1630, 1632, 1633, 1635, 1639, 1642, 1648, 1651, 1655, 1657, 1659, 1661, 1662, 1663, 1676; .290" X .715" X .079"
6	Fuel Injector Nut	FP-R79604		Injector line codes 1601, 1602
13	Washer Type Seal	FP-R51936		Fuel line; Line codes 1601, 1602, 1603, 1604, 1605, 1606, 1608, 1610, 1611, 1612, 1616, 1617, 1618, 1619, 1632, 1634, 1636, 1640, 1641, 1643, 1644, 1645, 1646, 1647, 1648, 1649, 1650, 1656, 1661, 1662, 1663, 1667
<b>QTY</b>	<b>TURBOCHARGER</b>	<b>PART NO.</b>	<b>SIZE</b>	<b>DESCRIPTION</b>
1	Turbocharger Oil Drain Gasket	FP-R105346		w/Turbo oil line codes 6501, 6503, 6504, 6505, 6506, 6507, 6508, 6510, 6511, 6512, 6513, 6529, 6530, 6531
1	Turbocharger Mounting Gasket	FP-R89879		
1	O-Ring	FP-R86743		Outer coupling
1	Turbo Exhaust Int. Cover Gskt	FP-R92097		Turbo code 6514
<b>COOLING SYSTEM</b>				
<b>QTY</b>	<b>WATER PUMP</b>	<b>PART NO.</b>	<b>SIZE</b>	<b>DESCRIPTION</b>
2	Ball Brg.	FP-JD10329		Fan hub shaft bearing
1	Water Pump Gasket	FP-R119383		w/Pump housing marked R119795; w/15 tooth gear; High flow
1	Water Pump Gasket	FP-R119383		w/Pump housing marked R119795; w/16 tooth gear; Low flow
1	Oil Seal	FP-RE39134		Water pump codes 2001, 2004; w/Pump housing marked R119795
1	Water Pump Hub	FP-JD10058		w/Fan Hub bearing codes 2305, 2306, 2335, 2336, 2337, 2338, 2339
1	Water Pump Filter	FP-R98527		w/Pump housing marked R119795
<b>QTY</b>	<b>THERMOSTAT</b>	<b>PART NO.</b>	<b>SIZE</b>	<b>DESCRIPTION</b>
2	Thermostat	FP-AR48675		Thermostat code 2204; 180 Deg.
1	Thermostat Gasket	FP-R124211		Thermostat housing to cyl. head
1	Thermostat Cover Gasket	FP-R46479		Thermostat cover codes 2102, 2114; Two hole
1	Therm. Hsg. - Water Mfld. Gsk	FP-R86062		Housing to cyl. head
<b>QTY</b>	<b>MISCELLANEOUS</b>	<b>PART NO.</b>	<b>SIZE</b>	<b>DESCRIPTION</b>
2	Water Manifold Mounting Gskt.	FP-R88397		
<b>ENGINE BLOCK &amp; PARTS</b>				
<b>QTY</b>	<b>GASKETS</b>	<b>PART NO.</b>	<b>SIZE</b>	<b>DESCRIPTION</b>
1	Front Cover Gasket	FP-R125670		Air compressor to timing cover; Midland or Holset
1	Front Cover Gasket	FP-R119384		Timing gear cover
1	Oil Pan Gasket	FP-R49377		w/Alum. pan; Oil pan codes 1906, 1909, 1914, 1916
1	Oil Pan Gasket	FP-R71918		w/Cast Iron pan
1	O-Ring	FP-U13639		Block coolant drain plug seal; Coolant heater codes 2601, 2602; 1.475" X .118"
<b>QTY</b>	<b>GASKET SETS</b>	<b>PART NO.</b>	<b>SIZE</b>	<b>DESCRIPTION</b>
1	Complete Overhaul Gasket Set	FP-RE57187		From Ser. No. 500,000; Crankshaft seals not incl.
<b>QTY</b>	<b>CAM BEARINGS</b>	<b>PART NO.</b>	<b>SIZE</b>	<b>DESCRIPTION</b>
4	Cam Brg.	FP-R87561		

(continued on next page)

## 11 Marine Applications 6081A PowerTech Eng. (2-Valve Cyl. Head) (cont.) 8.1L 495.9 (8129cc) OHV Turbo-Diesel L6 (PowerTech 2V AC), 116mm Bore

ENGINE BLOCK & PARTS (cont.)				
QTY	OIL COOLERS & FILTERS	PART NO.	SIZE	DESCRIPTION
1	Aftercooler Gasket	FP-R88993		w/Int. manifold codes 1703, 1738
2	Aftercooler Gasket	FP-R88993		w/Int. manifold codes 1705, 1737
1	Oil Cooler	FP-AR55394		
4	O-Ring	FP-R47153		Cooler tube; Cooler code 5901
4	O-Ring	FP-R47153		Oil filter tube; Filter code 5901
1	Oil Cooler Housing Gasket	FP-AR58952		
2	Oil Cooler Adapter Gasket Set	FP-R50424		
CRANKSHAFT/OIL PUMP				
QTY	SEALS - FRONT CRANK	PART NO.	SIZE	DESCRIPTION
1	Oil Seal Kit	FP-AR49025		
QTY	SEALS - REAR CRANK	PART NO.	SIZE	DESCRIPTION
1	Oil Seal	FP-RE22764		PTFE
QTY	MAIN BEARINGS	PART NO.	SIZE	DESCRIPTION
6	Plain Main Brg.	FP-RE529319	STD	
1	Flanged Main Brg.	FP-RE529320	STD	
QTY	OIL PUMP	PART NO.	SIZE	DESCRIPTION
2	O-Ring	FP-U17409		Oil cooler relief valve plug seal; Filter & housing code 5901
1	Oil Pump Intake Gasket	FP-R100569		Oil pump pickup codes 1906, 1909, 1916
1	Oil Filter Base Gasket	FP-R119847		Housing to block gskt.
CYLINDER COMPONENTS				
QTY	LINERS	PART NO.	SIZE	DESCRIPTION
6	Liner w/o Sealing Ring	FP-R520212	STD	
6	Cylinder Kit Complete	FP-RE508156 *	STD	For Low Compression Engines
6	Cyl. Liner Sealing Ring Kit	FP-AR98850		
QTY	PISTONS	PART NO.	SIZE	DESCRIPTION
6	Piston Body w/o Pin	FP-RE516291 *	STD	For Low Compression Engines
6	Pin	FP-R57771		
12	Piston Pin Retainer	FP-E1343FN		
6	Pin Bushing	FP-R74008		w/Con. Rod marked R11634, R501034; 1.877" ID, 2.0622 OD, 1.8728" O.A.L.
QTY	CONNECTING RODS & BRGS.	PART NO.	SIZE	DESCRIPTION
12	Con. Rod Bolt	FP-R501035		w/Con. Rod marked R526592, R535555
12	Con. Rod Bolt	FP-R66452		To Ser. No. 086,535; w/Con. Rod marked R116340; Torque-To-Yield bolt; Replacement recommended
6	Rod Bearing Half Upper/Lower	FP-R525767	STD	
QTY	PISTON RINGS	PART NO.	SIZE	DESCRIPTION
6	Ring Set Single Cylinder	FP-RE503528	STD	

## 12 Marine Applications 6081T PowerTech Eng. 8.1L 495.9 (8129cc) OHV Turbo-Diesel L6 (PowerTech 2V), 116mm Bore

CYL. HEAD & PARTS				
QTY	GASKETS	PART NO.	SIZE	DESCRIPTION
1	Valve Cover Gasket	FP-R49866		
1	Head Gasket	FP-RE55475		Cyl. head code 5109
QTY	VALVE	PART NO.	SIZE	DESCRIPTION
6	Intake	FP-R84618	STD	Cyl. head code 5109; 1 groove; Chrome plated stem; 2.0080" Head Dia., .3730" Stem Dia., 6.0600" O.A.L.
6	Intake	FP-R93308	3	Cyl. head code 5109; 1 groove; Chrome plated stem; 2.0080" Head Dia., .3760" Stem Dia., 6.0600" O.A.L.
6	Exhaust	FP-R84619	STD	Cyl. head code 5109; 1 groove; Chrome plated stem; 1.8500" Head Dia., .3720" Stem Dia., 6.1780" O.A.L.
6	Exhaust	FP-R93311	3	Cyl. head code 5109; 1 groove; Chrome plated stem; 1.8500" Head Dia., .3750" Stem Dia., 6.1780" O.A.L.
12	Valve Stem Cap	FP-T20129		Cyl. head code 5109
24	Keeper	FP-T20077		Cyl. head code 5109; 1 groove; Square cut key groove; Hardened
QTY	VALVE SEAT	PART NO.	SIZE	DESCRIPTION
6	Exh.	FP-R119132	STD	Cyl. head code 5109
6	Exh.	FP-R93349	10	Cyl. head code 5109
6	Int.	FP-R121193	STD	Cyl. head code 5109
6	Int.	FP-R93350	10	Cyl. head code 5109

(continued on next page)

*Marine Applications 6081T PowerTech Eng. 12*  
8.1L 495.9 (8129cc) OHV Turbo-Diesel L6 (PowerTech 2V), 116mm Bore (cont.)

<b>CYL. HEAD &amp; PARTS (cont.)</b>				
QTY	VALVE SPRING	PART NO.	SIZE	DESCRIPTION
12	Spring	FP-R91822		Cyl. head code 5109
QTY	VALVE MISC.	PART NO.	SIZE	DESCRIPTION
1	Oil Filler Cap Gasket	FP-T20328		
<b>ELECTRICAL</b>				
QTY	ALTERNATOR	PART NO.	SIZE	DESCRIPTION
1	Ball Brg.	FP-JD9449		Front; Code 3143; 12 Volt, 90 amp alternator; Poly-Vee fan drive
<b>INT &amp; EXH MANIFOLDS</b>				
QTY	INT. & EXH. MANIFOLDS	PART NO.	SIZE	DESCRIPTION
3	Intake Manifold Gasket	FP-R130573		Int. manifold to head gskt.; Code 1701
<b>CAMSHAFT GROUP</b>				
QTY	TIMING COVER	PART NO.	SIZE	DESCRIPTION
1	Crankshaft Front Cover Gasket	FP-R26058		Flywheel housing inspection cover gskt.
QTY	CAMSHAFT/LIFTER	PART NO.	SIZE	DESCRIPTION
1	Camshaft Plug	FP-R82007		Cyl. block code 4601
<b>FUEL SYSTEM &amp; PARTS</b>				
QTY	FUEL INJECTION	PART NO.	SIZE	DESCRIPTION
1	Washer	FP-R53899		Fuel temp. sensor seal; Codes 1601, 1602
6	Washer	FP-R84472		Injector nozzle; Injector nozzle washer; Nozzle codes 1601, 1602; .290" X .715" X .079"
6	Fuel Injector Nut	FP-R79604		Fuel return connector; Codes 1601, 1602
13	Washer Type Seal	FP-R51936		Fuel supply line; Codes 1601, 1602
QTY	TURBOCHARGER	PART NO.	SIZE	DESCRIPTION
1	Turbocharger Oil Drain Gasket	FP-R105346		Oil cooler & filter code 5901; Oil return flange gskt.
1	Sealing Ring	FP-R100911		Code 1701; Aftercooler inlet/outlet gskt.
<b>COOLING SYSTEM</b>				
QTY	WATER PUMP	PART NO.	SIZE	DESCRIPTION
1	Water Pump Gasket	FP-R119383		Water pump code 2002; Pump marked R119795
1	Oil Seal	FP-RE39134		Water pump code 2002; Pump marked R119795; Pump bearing seal
2	O-Ring	FP-U13639		Coolant heater adapter seal; Codes 2601, 2602, 2605; Cyl. block code 4602; 1.475" X .118"
2	O-Ring	FP-R72328		Thermostat housing code 3901; Tube seal
1	O-Ring	FP-R71596		Water pump code 2002; w/Pump housing marked R119795
1	Water Pump Filter	FP-R98527		Water pump code 2002; Pump marked R119795
QTY	THERMOSTAT	PART NO.	SIZE	DESCRIPTION
2	Thermostat	FP-AR48675		Thermostat code 2204; 180 Deg.
1	Therm. Hsg. - Water Mfld. Gsk	FP-R86062		Thermostat housing code 3901; Housing to head gskt.
QTY	MISCELLANEOUS	PART NO.	SIZE	DESCRIPTION
2	Water Manifold Mounting Gskt.	FP-R88397		Thermostat housing code 3901
<b>ENGINE BLOCK &amp; PARTS</b>				
QTY	GASKETS	PART NO.	SIZE	DESCRIPTION
1	Front Cover Gasket	FP-R125670		Air compressor codes 7802, 7804, 7805; Compressor to front cover gskt.
1	Front Cover Gasket	FP-R119384		Front plate & timing gear cover code 7701
1	O-Ring	FP-R71732		Seawater & tube code 8001; Tube seal
QTY	CAM BEARINGS	PART NO.	SIZE	DESCRIPTION
4	Cam Brg.	FP-R87561		Cyl. block code 4602
QTY	OIL COOLERS & FILTERS	PART NO.	SIZE	DESCRIPTION
2	Aftercooler Gasket	FP-R88993		
1	Oil Cooler	FP-AR55394		Oil cooler & filter code 5901
1	O-Ring	FP-B2762R		Cyl. block code 4601; Aux. drive plug seal
2	O-Ring	FP-U17409		Oil cooler & filter code 5901; Check valve plug seals
8	O-Ring	FP-R47153		Oil cooler & filter code 5901; Tube seals
1	Rect. or Square Seal	FP-R43660		Oil cooler & filter code 5901; Oil filter seal
1	Oil Cooler Housing Gasket	FP-AR58952		Oil cooler & filter code 5901
2	Oil Cooler Adapter Gasket Set	FP-R50424		Oil cooler & filter code 5901
<b>CRANKSHAFT/OIL PUMP</b>				
QTY	SEALS - FRONT CRANK	PART NO.	SIZE	DESCRIPTION
1	Oil Seal Kit	FP-RE68318		Water pump code 2102; Pump marked R119795

(continued on next page)

<b>12 Marine Applications 6081T PowerTech Eng.</b>				
<b>(cont.) 8.1L 495.9 (8129cc) OHV Turbo-Diesel L6 (PowerTech 2V), 116mm Bore</b>				
<b>CRANKSHAFT/OIL PUMP (cont.)</b>				
<b>QTY</b>	<b>SEALS - FRONT CRANK</b>	<b>PART NO.</b>	<b>SIZE</b>	<b>DESCRIPTION</b>
1	Oil Seal Kit	FP-AR49025		Front plate & timing gear cover code 7701
<b>QTY</b>	<b>MAIN BEARINGS</b>	<b>PART NO.</b>	<b>SIZE</b>	<b>DESCRIPTION</b>
6	Plain Main Brg.	FP-RE529319	STD	
1	Flanged Main Brg.	FP-RE529320	STD	
<b>QTY</b>	<b>OIL PUMP</b>	<b>PART NO.</b>	<b>SIZE</b>	<b>DESCRIPTION</b>
1	O-Ring	FP-R71732		Oil pump code 5002; Tube to block seal
1	O-Ring	FP-R71732		Oil pump code 5002; Tube to pump seal
1	Oil Pump Intake Gasket	FP-R100569		Drain plug seal codes 1920, 1921, 1922, 1923, 1924
1	Oil Pump Intake Gasket	FP-R100569		Oil pump code 5002
1	Oil Filter Base Gasket	FP-R119847		Oil cooler & filter code 5901
<b>CYLINDER COMPONENTS</b>				
<b>QTY</b>	<b>LINERS</b>	<b>PART NO.</b>	<b>SIZE</b>	<b>DESCRIPTION</b>
6	Liner w/o Sealing Ring	FP-R520212	STD	
6	Cyl. Liner Sealing Ring Kit	FP-AR98850		Piston, Con. Rod, Cyl. liner codes 4802, 4803
<b>QTY</b>	<b>PISTONS</b>	<b>PART NO.</b>	<b>SIZE</b>	<b>DESCRIPTION</b>
6	Pin	FP-R57771		Piston, Con. Rod, Cyl. liner code 4802
12	Piston Pin Retainer	FP-E1343FN		Piston, Con. Rod, Cyl. liner codes 4802
6	Pin Bushing	FP-R74008		Piston, Con. Rod, Cyl. liner code 4802; 1.877" ID, 2.0622 OD, 1.8728" O.A.L.
<b>QTY</b>	<b>CONNECTING RODS &amp; BRGS.</b>	<b>PART NO.</b>	<b>SIZE</b>	<b>DESCRIPTION</b>
12	Con. Rod Bolt	FP-R66452		To Ser. No. 086,535; w/Con. Rod marked R116340; Torque-To-Yield bolt; Replacement recommended
6	Rod Bearing Half Upper/Lower	FP-R525767	STD	
<b>QTY</b>	<b>PISTON RINGS</b>	<b>PART NO.</b>	<b>SIZE</b>	<b>DESCRIPTION</b>
6	Ring Set Single Cylinder	FP-RE57517	STD	Piston, Con. Rod, Cyl. liner code 4802
<b>13 Marine Applications</b>				
<b>9.0L 549 (9000cc) OHV Turbo-Diesel L6 (PowerTech 4V IC), 118.4mm Bore</b>				
<b>CYL. HEAD &amp; PARTS</b>				
<b>QTY</b>	<b>VALVE</b>	<b>PART NO.</b>	<b>SIZE</b>	<b>DESCRIPTION</b>
12	Intake	FP-R520223	STD	1 groove; Chrome plated stem; 1.5748" Head Dia., .3142" Stem Dia., 6.4154" O.A.L.
12	Exhaust	FP-R520224	STD	1 groove; Inconel X-751; Chrome plated stem; 1.5748" Head Dia., .3142" Stem Dia., 6.4201" O.A.L.
<b>QTY</b>	<b>VALVE SEAT</b>	<b>PART NO.</b>	<b>SIZE</b>	<b>DESCRIPTION</b>
24	Exh. & Int.	FP-R527285 *	STD	
<b>QTY</b>	<b>VALVE GUIDE</b>	<b>PART NO.</b>	<b>SIZE</b>	<b>DESCRIPTION</b>
24	Guide	FP-R527286 *		
<b>QTY</b>	<b>VALVE SPRING</b>	<b>PART NO.</b>	<b>SIZE</b>	<b>DESCRIPTION</b>
24	Spring	FP-R504235		
<b>CAMSHAFT GROUP</b>				
<b>QTY</b>	<b>CAMSHAFT/LIFTER</b>	<b>PART NO.</b>	<b>SIZE</b>	<b>DESCRIPTION</b>
1	Camshaft Plug	FP-R82007		
<b>ENGINE BLOCK &amp; PARTS</b>				
<b>QTY</b>	<b>CAM BEARINGS</b>	<b>PART NO.</b>	<b>SIZE</b>	<b>DESCRIPTION</b>
6	Cam Brg.	FP-R527877 *	STD	
<b>CRANKSHAFT/OIL PUMP</b>				
<b>QTY</b>	<b>MAIN BEARINGS</b>	<b>PART NO.</b>	<b>SIZE</b>	<b>DESCRIPTION</b>
6	Plain Main Brg.	FP-RE529319	STD	
1	Flanged Main Brg.	FP-RE529320	STD	
<b>QTY</b>	<b>OIL PUMP</b>	<b>PART NO.</b>	<b>SIZE</b>	<b>DESCRIPTION</b>
1	Oil Pump Intake Gasket	FP-R100569		
<b>CYLINDER COMPONENTS</b>				
<b>QTY</b>	<b>LINERS</b>	<b>PART NO.</b>	<b>SIZE</b>	<b>DESCRIPTION</b>
6	Cyl. Liner Sealing Ring Kit	FP-AR98850		
<b>QTY</b>	<b>PISTONS</b>	<b>PART NO.</b>	<b>SIZE</b>	<b>DESCRIPTION</b>
6	Pin	FP-R517073 *	STD	

(continued on next page)

*Marine Applications* **13**  
9.0L 549 (9000cc) OHV Turbo-Diesel L6 (PowerTech 4V IC), 118.4mm Bore (cont.)

<b>CYLINDER COMPONENTS (cont.)</b>				
<b>QTY</b>	<b>PISTONS (cont.)</b>	<b>PART NO.</b>	<b>SIZE</b>	<b>DESCRIPTION</b>
6	Pin Bushing	FP-R74008		1.877" ID, 2.0622 OD, 1.8728" O.A.L.
<b>QTY</b>	<b>CONNECTING RODS &amp; BRGS.</b>	<b>PART NO.</b>	<b>SIZE</b>	<b>DESCRIPTION</b>
12	Con. Rod Bolt	FP-R501035		Fractured split rod
6	Rod Pair	FP-RE529318 *	STD	
<b>QTY</b>	<b>PISTON RINGS</b>	<b>PART NO.</b>	<b>SIZE</b>	<b>DESCRIPTION</b>
6	Ring Set Single Cylinder	FP-RE531077 *	STD	

*Marine Applications* **6090AFM75 Eng. 14**  
9.0L 549 (9000cc) OHV Turbo-Diesel L6 (PowerTech 4V AC), 118.4mm Bore

<b>CYL. HEAD &amp; PARTS</b>				
<b>QTY</b>	<b>VALVE</b>	<b>PART NO.</b>	<b>SIZE</b>	<b>DESCRIPTION</b>
12	Intake	FP-R520223	STD	1 groove; Chrome plated stem; 1.5748" Head Dia., .3142" Stem Dia., 6.4154" O.A.L.
12	Exhaust	FP-R520224	STD	1 groove; Inconel X-751; Chrome plated stem; 1.5748" Head Dia., .3142" Stem Dia., 6.4201" O.A.L.
<b>QTY</b>	<b>VALVE SEAT</b>	<b>PART NO.</b>	<b>SIZE</b>	<b>DESCRIPTION</b>
24	Exh. & Int.	FP-R527285 *	STD	
<b>QTY</b>	<b>VALVE GUIDE</b>	<b>PART NO.</b>	<b>SIZE</b>	<b>DESCRIPTION</b>
24	Guide	FP-R527286 *		
<b>QTY</b>	<b>VALVE SPRING</b>	<b>PART NO.</b>	<b>SIZE</b>	<b>DESCRIPTION</b>
24	Spring	FP-R504235		

<b>CAMSHAFT GROUP</b>				
<b>QTY</b>	<b>CAMSHAFT/LIFTER</b>	<b>PART NO.</b>	<b>SIZE</b>	<b>DESCRIPTION</b>
1	Camshaft Plug	FP-R82007		

<b>ENGINE BLOCK &amp; PARTS</b>				
<b>QTY</b>	<b>CAM BEARINGS</b>	<b>PART NO.</b>	<b>SIZE</b>	<b>DESCRIPTION</b>
6	Cam Brg.	FP-R527877 *	STD	

<b>CRANKSHAFT/OIL PUMP</b>				
<b>QTY</b>	<b>MAIN BEARINGS</b>	<b>PART NO.</b>	<b>SIZE</b>	<b>DESCRIPTION</b>
6	Plain Main Brg.	FP-RE529319	STD	
1	Flanged Main Brg.	FP-RE529320	STD	
<b>QTY</b>	<b>OIL PUMP</b>	<b>PART NO.</b>	<b>SIZE</b>	<b>DESCRIPTION</b>
1	Oil Pump Intake Gasket	FP-R100569		

<b>CYLINDER COMPONENTS</b>				
<b>QTY</b>	<b>LINERS</b>	<b>PART NO.</b>	<b>SIZE</b>	<b>DESCRIPTION</b>
6	Cyl. Liner Sealing Ring Kit	FP-AR98850		
<b>QTY</b>	<b>PISTONS</b>	<b>PART NO.</b>	<b>SIZE</b>	<b>DESCRIPTION</b>
6	Pin	FP-R517073 *	STD	
6	Pin Bushing	FP-R74008		1.877" ID, 2.0622 OD, 1.8728" O.A.L.
<b>QTY</b>	<b>CONNECTING RODS &amp; BRGS.</b>	<b>PART NO.</b>	<b>SIZE</b>	<b>DESCRIPTION</b>
12	Con. Rod Bolt	FP-R501035		Fractured split rod
6	Rod Pair	FP-RE529318 *	STD	
<b>QTY</b>	<b>PISTON RINGS</b>	<b>PART NO.</b>	<b>SIZE</b>	<b>DESCRIPTION</b>
6	Ring Set Single Cylinder	FP-RE531077 *	STD	

*Marine Applications* **15**  
9.0L 549 (9000cc) OHV Turbo-Diesel L6 (PowerTech 4V), 118.4mm Bore

<b>CYL. HEAD &amp; PARTS</b>				
<b>QTY</b>	<b>VALVE</b>	<b>PART NO.</b>	<b>SIZE</b>	<b>DESCRIPTION</b>
12	Intake	FP-R520223	STD	1 groove; Chrome plated stem; 1.5748" Head Dia., .3142" Stem Dia., 6.4154" O.A.L.
12	Exhaust	FP-R520224	STD	1 groove; Inconel X-751; Chrome plated stem; 1.5748" Head Dia., .3142" Stem Dia., 6.4201" O.A.L.
<b>QTY</b>	<b>VALVE SEAT</b>	<b>PART NO.</b>	<b>SIZE</b>	<b>DESCRIPTION</b>
24	Exh. & Int.	FP-R527285 *	STD	

(continued on next page)

<b>15 Marine Applications</b>				
<b>(cont.) 9.0L 549 (9000cc) OHV Turbo-Diesel L6 (PowerTech 4V), 118.4mm Bore</b>				
<b>CYL. HEAD &amp; PARTS (cont.)</b>				
<b>QTY</b>	<b>VALVE GUIDE</b>	<b>PART NO.</b>	<b>SIZE</b>	<b>DESCRIPTION</b>
24	Guide	FP-R527286 *		
<b>QTY</b>	<b>VALVE SPRING</b>	<b>PART NO.</b>	<b>SIZE</b>	<b>DESCRIPTION</b>
24	Spring	FP-R504235		
<b>CAMSHAFT GROUP</b>				
<b>QTY</b>	<b>CAMSHAFT/LIFTER</b>	<b>PART NO.</b>	<b>SIZE</b>	<b>DESCRIPTION</b>
1	Camshaft Plug	FP-R82007		
<b>ENGINE BLOCK &amp; PARTS</b>				
<b>QTY</b>	<b>CAM BEARINGS</b>	<b>PART NO.</b>	<b>SIZE</b>	<b>DESCRIPTION</b>
6	Cam Brg.	FP-R527877 *	STD	
<b>CRANKSHAFT/OIL PUMP</b>				
<b>QTY</b>	<b>MAIN BEARINGS</b>	<b>PART NO.</b>	<b>SIZE</b>	<b>DESCRIPTION</b>
6	Plain Main Brg.	FP-RE529319	STD	
1	Flanged Main Brg.	FP-RE529320	STD	
<b>QTY</b>	<b>OIL PUMP</b>	<b>PART NO.</b>	<b>SIZE</b>	<b>DESCRIPTION</b>
1	Oil Pump Intake Gasket	FP-R100569		
<b>CYLINDER COMPONENTS</b>				
<b>QTY</b>	<b>LINERS</b>	<b>PART NO.</b>	<b>SIZE</b>	<b>DESCRIPTION</b>
6	Cyl. Liner Sealing Ring Kit	FP-AR98850		
<b>QTY</b>	<b>PISTONS</b>	<b>PART NO.</b>	<b>SIZE</b>	<b>DESCRIPTION</b>
6	Pin	FP-R517073 *	STD	
6	Pin Bushing	FP-R74008		1.877" ID, 2.0622 OD, 1.8728" O.A.L.
<b>QTY</b>	<b>CONNECTING RODS &amp; BRGS.</b>	<b>PART NO.</b>	<b>SIZE</b>	<b>DESCRIPTION</b>
12	Con. Rod Bolt	FP-R501035		Fractured split rod
6	Rod Pair	FP-RE529318 *	STD	
<b>QTY</b>	<b>PISTON RINGS</b>	<b>PART NO.</b>	<b>SIZE</b>	<b>DESCRIPTION</b>
6	Ring Set Single Cylinder	FP-RE531077 *	STD	
<b>16 Marine Applications 6125TFM Eng.</b>				
<b>12.5L 764.6 (12534cc) OHV Turbo-Diesel L6 (PowerTech), 127mm Bore</b>				
<b>CYL. HEAD &amp; PARTS</b>				
<b>QTY</b>	<b>VALVE</b>	<b>PART NO.</b>	<b>SIZE</b>	<b>DESCRIPTION</b>
48	Keeper	FP-R91889		Cyl. head & camshaft codes 5102, 5103
<b>CAMSHAFT GROUP</b>				
<b>QTY</b>	<b>TIMING</b>	<b>PART NO.</b>	<b>SIZE</b>	<b>DESCRIPTION</b>
1	Idler Sprocket/Gear Bushing	FP-R533789		
<b>FUEL SYSTEM &amp; PARTS</b>				
<b>QTY</b>	<b>TURBOCHARGER</b>	<b>PART NO.</b>	<b>SIZE</b>	<b>DESCRIPTION</b>
1	Turbocharger Oil Drain Gasket	FP-R105346		Turbocharger, line & pipe code 6502
1	Turbocharger Mounting Gasket	FP-R49697		Turbocharger, lines & pipe code 6502
1	O-Ring	FP-R72328		Turbocharger, lines & pipe code 6502; Return oil tube adapter seal
<b>COOLING SYSTEM</b>				
<b>QTY</b>	<b>WATER PUMP</b>	<b>PART NO.</b>	<b>SIZE</b>	<b>DESCRIPTION</b>
1	Ball Brg.	FP-JD10362		Front; Water Pump bearing
1	Ball Brg.	FP-JD10363		Rear; Water Pump bearing
1	Oil Seal	FP-RE39134		Rear water pump seal
<b>QTY</b>	<b>THERMOSTAT</b>	<b>PART NO.</b>	<b>SIZE</b>	<b>DESCRIPTION</b>
1	Thermostat	FP-RE33705		Upper; Thermostat code 2207; 180 Deg.
<b>CRANKSHAFT/OIL PUMP</b>				
<b>QTY</b>	<b>SEALS - REAR CRANK</b>	<b>PART NO.</b>	<b>SIZE</b>	<b>DESCRIPTION</b>
1	Crankshaft Rear Housing Gskt.	FP-R35043		
<b>QTY</b>	<b>OIL PUMP</b>	<b>PART NO.</b>	<b>SIZE</b>	<b>DESCRIPTION</b>
1	O-Ring	FP-R56192		Aux. drive adapter, lines and cover code 5202; Flange-to-flange seal
1	O-Ring	FP-R72328		Elbow seal
3	O-Ring	FP-U17409		Oil cooler relief valve plug seal; Filter & housing code 5901

(continued on next page)





*Marine Applications 6125TFM Eng. 16*  
 12.5L 764.6 (12534cc) OHV Turbo-Diesel L6 (PowerTech), 127mm Bore (cont.)

<b>CYLINDER COMPONENTS</b>				
<b>QTY</b>	<b>LINERS</b>	<b>PART NO.</b>	<b>SIZE</b>	<b>DESCRIPTION</b>
6	Cyl. Liner Sealing Ring Kit	<b>FP-AR72351</b>		Piston, Con. Rod, Cyl. liner code 4801
<b>QTY</b>	<b>PISTONS</b>	<b>PART NO.</b>	<b>SIZE</b>	<b>DESCRIPTION</b>
6	Pin	<b>FP-R64451</b>		Piston, Con. Rod, Cyl. liner code 4801
12	Piston Pin Retainer	<b>FP-N51168</b>		Piston, Con. Rod, Cyl. liner code 4801
6	Pin Bushing	<b>FP-R69045</b>		Piston, Con. Rod, Cyl. liner code 4801; w/Con. Rod marked R121174, R501566; w/1.999" ID, w/2.187" OD, 2.0512" O.A.L.
<b>QTY</b>	<b>CONNECTING RODS &amp; BRGS.</b>	<b>PART NO.</b>	<b>SIZE</b>	<b>DESCRIPTION</b>
12	Con. Rod Bolt	<b>FP-R66453</b>		Piston, Con. Rod, Cyl. liner code 4801; To Ser. No. 010513; Rod marked R121174; Torque-To-Yield bolt; Replacement recommended
6	Rod Pair	<b>FP-RE530787 *</b>	<i>STD</i>	

\* New Item — Check For Availability























## Engine Kit Bill of Material

Qty.	Part No.	Description	Qty.	Part No.	Description	Qty.	Part No.	Description
<b>FP-671XHOH (cont'd.)</b>			<b>FP-6712VOH (cont'd.)</b>					
(6)	FP-23522493	Cylinder Kit Complete	(6)	FP-23511135	Connecting Rod Bearing Pair			
(6)	FP-23522507	Cylinder Kit Complete	(6)	FP-23511137	Connecting Rod Bearing Pair			
(6)	FP-235225075	Cylinder Kit Complete	(7)	FP-5192874	Main Bearing, Plain			
(6)	FP-23522509	Cylinder Kit Complete	(7)	FP-5192875	Main Bearing, Plain			
(6)	FP-23522511	Cylinder Kit Complete	(7)	FP-5192876	Main Bearing, Plain			
(6)	FP-23522513	Cylinder Kit Complete	(7)	FP-5192877	Main Bearing, Plain			
(6)	FP-23522515	Cylinder Kit Complete	(7)	FP-5192878	Main Bearing, Plain			
(6)	FP-23522521	Cylinder Kit Complete	(4)	FP-5159353	Thrust Washer			
(6)	FP-23522525	Cylinder Kit Complete	(1)	FP-23512676	Complete Overhaul Gasket Set			
(6)	FP-23522946	Cylinder Kit Complete	(1)	FP-5192923	Complete Overhaul Gasket Set			
(6)	FP-23522947	Cylinder Kit Complete	(1)	FP-5104019	Valve Cover Gasket			
(6)	FP-23522948	Cylinder Kit Complete	(1)	FP-5143407	Valve Cover Gasket			
(6)	FP-23522949	Cylinder Kit Complete						
(6)	FP-2352294930	Cylinder Kit Complete						
(6)	FP-235229495	Cylinder Kit Complete						
(6)	FP-23522950	Cylinder Kit Complete						
(6)	FP-23522951	Cylinder Kit Complete						
(6)	FP-23522952	Cylinder Kit Complete						
(6)	FP-23522953	Cylinder Kit Complete						
(6)	FP-23511129	Connecting Rod Bearing Pair						
(6)	FP-23511131	Connecting Rod Bearing Pair						
(6)	FP-23511133	Connecting Rod Bearing Pair						
(6)	FP-23511135	Connecting Rod Bearing Pair						
(6)	FP-23511137	Connecting Rod Bearing Pair						
(7)	FP-5192874	Main Bearing, Plain						
(7)	FP-5192875	Main Bearing, Plain						
(7)	FP-5192876	Main Bearing, Plain						
(7)	FP-5192877	Main Bearing, Plain						
(7)	FP-5192878	Main Bearing, Plain						
(4)	FP-5159353	Thrust Washer						
(1)	FP-23512676	Complete Overhaul Gasket Set						
(1)	FP-5104019	Valve Cover Gasket						
(1)	FP-5143407	Valve Cover Gasket						
<b>FP-6712V</b>								
(1)	FP-5150117	Oil Pan Gasket						
(6)	FP-23505308	Cylinder Kit Complete						
(6)	FP-23505309	Cylinder Kit Complete						
(6)	FP-235053091	Cylinder Kit Complete						
(6)	FP-2350530910	Cylinder Kit Complete						
(6)	FP-2350530920	Cylinder Kit Complete						
(6)	FP-2350530930	Cylinder Kit Complete						
(6)	FP-235053095	Cylinder Kit Complete						
(6)	FP-23511129	Connecting Rod Bearing Pair						
(6)	FP-23511131	Connecting Rod Bearing Pair						
(6)	FP-23511133	Connecting Rod Bearing Pair						
(6)	FP-23511135	Connecting Rod Bearing Pair						
(6)	FP-23511137	Connecting Rod Bearing Pair						
(7)	FP-5192874	Main Bearing, Plain						
(7)	FP-5192875	Main Bearing, Plain						
(7)	FP-5192876	Main Bearing, Plain						
(7)	FP-5192877	Main Bearing, Plain						
(7)	FP-5192878	Main Bearing, Plain						
(4)	FP-5159353	Thrust Washer						
(1)	FP-5192926	Head Gasket Set						
(1)	FP-5195742	Head Gasket Set						
(1)	FP-5104019	Valve Cover Gasket						
(1)	FP-5143407	Valve Cover Gasket						
<b>FP-6712VOH</b>								
(6)	FP-23505308	Cylinder Kit Complete						
(6)	FP-23505309	Cylinder Kit Complete						
(6)	FP-235053091	Cylinder Kit Complete						
(6)	FP-2350530910	Cylinder Kit Complete						
(6)	FP-2350530920	Cylinder Kit Complete						
(6)	FP-2350530930	Cylinder Kit Complete						
(6)	FP-235053095	Cylinder Kit Complete						
(6)	FP-23511129	Connecting Rod Bearing Pair						
(6)	FP-23511131	Connecting Rod Bearing Pair						
(6)	FP-23511133	Connecting Rod Bearing Pair						
		(cont'd. next column)						















# Numerical List



Part No.	Line No.	Part No.	Line No.	Part No.	Line No.
FP-V1629	JD 8, 13, 14, 39	FP-164LOHK	JD 23	FP-23504933	JD 70, 112
FP-V1634	JD 36, 46, 47, 71, 81, 82	FP-164MIFK	JD 23	FP-23504934	JD 70, 112
FP-V1635	JD 36, 46, 47, 71, 81, 82	FP-164MOHK	JD 23	FP-23504936	JD 70, 112
FP-V1676X	JD 19	FP-170664	JD 130	FP-23505305	JD 70, 112
FP-V1684	JD 21	FP-179DIFK	JD 27, JDI 2, 4	FP-23505306	JD 70, 112
FP-V1748	JD 21	FP-179DOHK	JD 27, JDI 2, 4	FP-2350530630	JD 70, 112
FP-V3922	JD 8, 13, 14, 39	FP-179TIFK	JD 28, JDI 3, 6	FP-235053065	JD 70, 112
FP-V4100	JD 59, 94	FP-179TOHK	JD 28, JDI 3, 6	FP-23505308	JD 70, 112
FP-V428	JD 1, 2, 6, 9	FP-180GEOHK	JD 31	FP-23505309	JD 70, 112
FP-V429	JD 1, 2, 6, 9	FP-180GLOHK	JD 31	FP-235053091	JD 70, 112
FP-V748	JD 43, 48	FP-181213	JD 130	FP-2350530910	JD 70, 112
FP-V800	JD 21	FP-186780	JD 130	FP-2350530920	JD 70, 112
FP-V816	JD 5, JDI 1	FP-1910CP	JD 75, 76	FP-2350530930	JD 70, 112
FP-V818	JD 19	FP-1910CP10	JD 75, 76	FP-235053095	JD 70, 112
FP-V954	JD 21	FP-1910CP20	JD 75, 76	FP-23505518	JD 70, 112
FP-V956	JD 43, 48	FP-193136	JD 130	FP-23507225	JD 70, 112
FP-W1102P	JD 21	FP-196844	JD 130	FP-23507238	JD 70, 112
FP-W1102P20	JD 21	FP-20011	JD 70, 112	FP-23507306	JD 70, 112
FP-W1102P30	JD 21	FP-20014	JD 70, 112	FP-23511129	JD 70, 112
FP-W1102P40	JD 21	FP-20022	JD 70, 112	FP-23511131	JD 70, 112
FP-W1102P60	JD 21	FP-200307	JD 130	FP-23511133	JD 70, 112
FP-W1115CP	JDI 1	FP-202EORLIFK	JD 38	FP-23511135	JD 70, 112
FP-W1115CP20	JDI 1	FP-202EORLOHK	JD 38	FP-23511137	JD 70, 112
FP-W1115CP30	JDI 1	FP-202LIFK	JD 38	FP-23512675	JD 70
FP-W1115CP40	JDI 1	FP-202LOHK	JD 38	FP-23512675WS	JD 70
FP-W1115CP60	JDI 1	FP-203933	JD 130	FP-23512676	JD 112
FP-W5589KX	JD 7, 46, 47, 81, 82	FP-204165	JD 130	FP-23512676WS	JD 112
FP-W628CP	JD 5	FP-205401	JD 130	FP-23514965	JD 70, 112
FP-W628CP20	JD 5	FP-213079	JD 130	FP-23514970	JD 70, 112
FP-W628CP30	JD 5	FP-213082	JD 130	FP-23516636	JD 4
FP-W628CP40	JD 5	FP-215233	JD 130	FP-23516871	JD 4
FP-W628CP60	JD 5	FP-2155SB	JD 93, 100, 111	FP-23517217*	JD 70, 112
FP-100099	JD 130	FP-215705	JD 130	FP-23517625	JD 4
FP-103319	JD 4, 70, 112	FP-216484	JD 130	FP-23517625WS	JD 4
FP-103320	JD 70, 112	FP-217323	JD 130	FP-23521992	JD 70, 112
FP-10366X	JD 5	FP-217638	JD 130	FP-23522026	JD 70, 112
FP-107981	JD 130	FP-2180CP	JD 16, 26, 34, 35	FP-23522070	JD 70, 112
FP-1090M	JD 33, 45, 69	FP-2180CP10	JD 16, 26, 34, 35	FP-23522475	JD 70, 112
FP-109080	JD 130	FP-2180CP20	JD 16, 26, 34, 35	FP-23522497	JD 70, 112
FP-1102P	JD 21	FP-219EORLIFK	JD 41	FP-23522521	JD 70, 112
FP-1102P20	JD 21	FP-219EORLOHK	JD 41	FP-23522525	JD 70, 112
FP-1102P30	JD 21	FP-219LIFK	JD 41, 42	FP-23522534	JD 70, 112
FP-1102P40	JD 21	FP-219LOHK	JD 41, 42	FP-23522535	JD 70, 112
FP-1102P60	JD 21	FP-219MIFK	JD 41	FP-23522947	JD 70, 112
FP-110855	JD 130	FP-219MOHK	JD 41	FP-23522949	JD 70, 112
FP-1115CP	JDI 1	FP-2204Y	JD 3, 7	FP-2352294930	JD 70, 112
FP-1115CP20	JDI 1	FP-2205CP	JD 3, 7	FP-235229495	JD 70, 112
FP-1115CP30	JDI 1	FP-2205CP10	JD 3, 7	FP-23522951	JD 70, 112
FP-1115CP40	JDI 1	FP-2205CP20	JD 3, 7	FP-23522954	JD 70, 112
FP-1115CP60	JDI 1	FP-2205CP30	JD 3, 7	FP-23522955	JD 70, 112
FP-112847	JD 46, 47, 54-56, 59, 60, 81, 82, 87, 94, 95, 98, 99	FP-2210SB	JD 3, 7	FP-239DIFK	JD 50, 52, JDI 8, 10
FP-1142M	JD 43, 48	FP-2210SB10	JD 3, 7	FP-239DOHK	JD 50, 52, JDI 8, 10
FP-1158M	JD 21	FP-2210SB20	JD 3, 7	FP-239TIFK	JD 51, 53, JDI 9, 11
FP-1251M	JD 8, 13-15, 20, 24, 25	FP-2210SB30	JD 3, 7	FP-239TOHK	JD 51, 53, JDI 9, 11
FP-129888	JD 130	FP-2210SB40	JD 3, 7	FP-2409Y	JD 70, 112
FP-135GEOHK	JD 10	FP-2212600	JD 21	FP-2425CP	JD 9
FP-135GLOHK	JD 10	FP-2212601	JD 21	FP-2425CP10	JD 9
FP-1394*	JD 5, 19, JDI 1	FP-2212603A	JD 21	FP-2425CP20	JD 9
FP-139988	JD 130	FP-2214108	JD 5, JDI 1	FP-2425CP30	JD 9
FP-1420CP	JD 33, 45, 69	FP-2241CP10	JD 43, 48, 69	FP-2451348E1N	JD 21
FP-1420CP10	JD 33, 45, 69	FP-2241CP20	JD 43, 48, 69	FP-24513753	JD 21
FP-1420CP20	JD 45, 69	FP-2241CP30	JD 43, 48, 69	FP-24513755	JD 5, JDI 1
FP-1420CP40	JD 33, 45, 69	FP-2242CP10	JD 69	FP-24518125	JD 3
FP-1424X	JD 33, 45, 69	FP-2242CP20	JD 69	FP-2454P	JD 47, 82
FP-1450SB	JD 1, 2, 6, 9	FP-2242CP30	JD 69	FP-253	JD 4
FP-1450SB10	JD 1, 2, 6, 9	FP-2243CP10	JD 43, 48, 69	FP-253OH	JD 4
FP-1450SB20	JD 1, 2, 6, 9	FP-2243CP20	JD 43, 48, 69	FP-2595A	JD 8, 10, 12-15, 20, 24, 25, 31, 37, 39, 40, 49, 57, 58
FP-1450SB30	JD 1, 2, 6, 9	FP-2243CP30	JD 43, 48, 69	FP-2595A10	JD 8, 10, 12-15, 20, 24, 25, 31, 37, 39, 40, 49, 57, 58
FP-145504	JD 130	FP-2244CP10	JD 43, 48, 69	FP-2595A20	JD 8, 10, 12-15, 20, 24, 25, 31, 37, 39, 40, 49, 57, 58
FP-145551	JD 130	FP-2244CP20	JD 43, 48, 69	FP-2595A30	JD 8, 10, 12-15, 20, 24, 25, 31, 37, 39, 40, 49, 57, 58
FP-146483	JD 130	FP-2244CP30	JD 43, 48, 69	FP-2599Y20	JD 8, 10, 12, 13, 15, 20, 25, 31, 39, 49, 57, 58
FP-147100	JD 130	FP-2244132	JD 21	FP-2601385	JD 10, 12
FP-1475M	JD 3, 7	FP-2244137	JD 21	FP-2601386	JD 31, 37
FP-151900	JD 130	FP-2279P	JD 46, 81	FP-2601399	JD 96
FP-152EORLIFK	JD 18	FP-23500480	JD 70, 112	FP-270EIFK	JD 60
FP-152EORLOHK	JD 18	FP-23500501	JD 70, 112	FP-270EOHK	JD 59, 60
FP-152LIFK	JD 18	FP-23500714	JD 70, 112	FP-270LIFK	JD 60
FP-152LOHK	JD 18	FP-23501687	JD 70, 112	FP-270LOHK	JD 60
FP-157551	JD 130	FP-23502020	JD 70, 112		
FP-164EORLIFK	JD 23	FP-23502021	JD 70, 112		
FP-164EORLOHK	JD 23	FP-23502022	JD 70, 112		
FP-164LIFK	JD 23	FP-23504931	JD 70, 112		
		FP-23504932	JD 70, 112		

Part		Part		Part	
No.	Line No.	No.	Line No.	No.	Line No.
FP-270RBIFK	JD 60	FP-3070137	JD 130	FP-404A	JD 98, 99
FP-270RBOHK	JD 60	FP-3070138	JD 130	FP-404DEIFK	JD 95
FP-2755CP	JD 34, 35	FP-3070460	JD 130	FP-404DEOHK	JD 94, 95
FP-276DLPIFK	JD 67, JDI 16	FP-3070477	JD 130	FP-404DLIFK	JD 95
FP-276DLPOHK	JD 67, JDI 16	FP-3070478	JD 130	FP-404DLOHK	JD 95, 96
FP-276DSPIFK	JD 67, JDI 16	FP-3071161	JD 130	FP-404DMIFK	JD 95
FP-276DSPOHK	JD 67, JDI 16	FP-3072341	JD 130	FP-404DMOHK	JD 95
FP-276TIFK	JD 68, JDI 17	FP-3072369	JD 130	FP-404DRBIFK	JD 95
FP-276TOHK	JD 68, JDI 17	FP-3073499	JD 130	FP-404DRBOHK	JD 95
FP-3K9619	JD 90-92	FP-3073966	JD 130	FP-404TAEIFK	JD 98, 99
FP-3R46903	JD 36, 46, 47, 54-56, 59, 60	FP-3074375	JD 130	FP-404TAEOHK	JD 98, 99
FP-3000173	JD 130	FP-3074376	JD 130	FP-404TALIFK	JD 98, 99
FP-3000175	JD 130	FP-3074482	JD 130	FP-404TALOHK	JD 98, 99
FP-3002385	JD 130	FP-3076522	JD 130	FP-4045DIFK	JD 63
FP-3005592	JD 130	FP-3084045	JD 130	FP-4045DOHK	JD 63
FP-3006736	JD 130	FP-3084848	JD 130	FP-4045TIFK	JD 65
FP-3006737	JD 130	FP-3129YA20	JD 36, 46, 47, 54-56, 59, 60, 71, 82, 87, 94, 96, 97	FP-4045TOHK	JD 65
FP-3007634	JD 130			FP-4058941	JD 130
FP-3007635	JD 130	FP-3161423	JD 130	FP-4058947	JD 130
FP-3007636	JD 130	FP-3166388	JD 130	FP-4058967	JD 130
FP-3007689S	JD 130	FP-3166428	JD 130	FP-4058968	JD 130
FP-3007759	JD 130	FP-3202117	JD 130	FP-4058969	JD 130
FP-3008591	JD 130	FP-3220CP	JD 19, 45	FP-4089489	JD 130
FP-3010146	JD 130	FP-3220CP10	JD 19, 45	FP-41339	JD 10, 12, 18, 23, 27, 28, 31, 37, 38, 41, 42, 50, 51, 54-56, 60, 67, 68, 72, 73, 77, 78, 85-87, 95, 96, 98, 99, 109, 110, 113, 114, JDI 2, 3, 8, 9, 16, 17, 26, 27
FP-3011952	JD 130	FP-3220CP20	JD 19, 45	FP-414DIFK	JD 109, JDI 26
FP-3012526	JD 130	FP-3220CP30	JD 19, 45	FP-414DOHK	JD 109, JDI 26
FP-3013786	JD 130	FP-3224CP	JD 19	FP-414TIFK	JD 110, JDI 27
FP-3014778	JD 130	FP-3224CP10	JD 19	FP-414TOHK	JD 110, JDI 27
FP-3019959	JD 130	FP-329EORLIFK	JD 78	FP-4144M	JD 8, 13
FP-3019960	JD 130	FP-329EORLOHK	JD 78	FP-4144M10	JD 8, 13
FP-3020943	JD 130	FP-329LIFK	JD 78	FP-4144M20	JD 8, 13
FP-3021601	JD 130	FP-329LOHK	JD 78	FP-4145M	JD 15, 20, 25
FP-3024960	JD 130	FP-329MIFK	JD 78	FP-4145M10	JD 15, 20, 25
FP-3025458	JD 130	FP-329MOHK	JD 78	FP-4145M20	JD 15, 20, 25
FP-3029847	JD 130	FP-3349806	JD 130	FP-4145M30	JD 15, 20, 25
FP-303EORLIFK	JD 73	FP-3349820	JD 130	FP-4344M	JD 8, 13, 14, 24
FP-303EORLOHK	JD 73	FP-3414Y20	JD 122	FP-4344M10	JD 8, 13, 14, 24
FP-303LIFK	JD 73	FP-3520CP	JD 5, JDI 1	FP-4344M20	JD 8, 13, 14, 24
FP-303LOHK	JD 73	FP-3520CP10	JD 5, JDI 1	FP-4345M	JD 15, 25
FP-3033740	JD 130	FP-3520CP20	JD 5, JDI 1	FP-4345M10	JD 15, 25
FP-3034438	JD 130	FP-3521441	JD 130	FP-4345M20	JD 15, 25
FP-3034986	JD 130	FP-3521442	JD 130	FP-43463A	JD 130
FP-3037537	JD 130	FP-359DIFK	JD 83, 85	FP-443603*	JD 4, 70, 112
FP-3038998	JD 130	FP-359DOHK	JD 83, 85	FP-466A	JD 114, JDI 28
FP-3046200	JD 130	FP-359TIFK	JD 84, 86	FP-466AHPIFK	JD 114, JDI 28
FP-3046201	JD 130	FP-359TOHK	JD 84, 86	FP-466AHPOHK	JD 114, JDI 28
FP-3050667	JD 130	FP-3605SB	JD 19	FP-466DIFK	JD 113
FP-3054948	JD 130	FP-3605SB10	JD 19	FP-466DOHK	JD 113
FP-3054948B	JD 130	FP-3605SB20	JD 19	FP-466TAEIFK	JD 114, JDI 28
FP-30549486	JD 130	FP-3645CP	JD 5, JDI 1	FP-466TAEOHK	JD 114, JDI 28
FP-3055069	JD 130	FP-3645CP10	JD 5, JDI 1	FP-466TALIFK	JD 114, JDI 28
FP-3055099	JD 130	FP-3645CP20	JD 5, JDI 1	FP-466TALOHK	JD 114, JDI 28
FP-3055145	JD 130	FP-3709510	JD 130	FP-471NA	JD 70
FP-3055145PR	JD 130	FP-3751948	JD 130	FP-471NAOH	JD 70
FP-3055146	JD 130	FP-3800174	JD 130	FP-471XH	JD 70
FP-3055146PR	JD 130	FP-3801106	JD 130	FP-471XHOH	JD 70
FP-3055147	JD 130	FP-3801260	JD 130	FP-4712V	JD 70
FP-3055148	JD 130	FP-3801261	JD 130	FP-4712VOH	JD 70
FP-3056158	JD 130	FP-3801262	JD 130	FP-500A	JD 123, 127, JDI 42
FP-3058462	JD 130	FP-3801263	JD 130	FP-5039KX	JD 21
FP-3064281	JD 130	FP-3801712	JD 130	FP-5051KX	JD 5
FP-3064291	JD 130	FP-3801712WO	JD 130	FP-5051KX20	JD 5
FP-3064295	JD 130	FP-3801826	JD 130	FP-5051KX40	JD 5
FP-3064304	JD 130	FP-3803605	JD 130	FP-5051KX60	JD 5
FP-3064305	JD 130	FP-3803726	JD 130	FP-5051X	JD 5
FP-3064309	JD 130	FP-3803741	JD 130	FP-5051X20	JD 5
FP-3064312	JD 130	FP-3803742	JD 130	FP-5051X30	JD 5
FP-3064313	JD 130	FP-3803854	JD 130	FP-5051X40	JD 5
FP-3064386	JD 130	FP-3819Y20	JD 127, JDI 42	FP-5051X60	JD 5
FP-3064392	JD 130	FP-3865237	JD 130	FP-5079X	JD 3
FP-3064406	JD 130	FP-4R46903	JD 71, 81, 82, 87, 94-99, 113, 114, 122, 123, 127, JDI 42	FP-5091KX	JD 19
FP-3066285	JD 130			FP-5091KX30	JD 19
FP-3066291	JD 130	FP-4003M	JD 3, 7	FP-5097C	JD 75, 76
FP-3066311	JD 130	FP-4003M10	JD 3, 7	FP-5101016	JD 4
FP-3066328	JD 130	FP-4003M20	JD 3, 7	FP-5101101	JD 70, 112
FP-3067568	JD 130	FP-4003M30	JD 3, 7	FP-5101120	JD 70, 112
FP-3067613	JD 130	FP-4004M	JD 21	FP-5102316	JD 70, 112
FP-3067616	JD 130	FP-4004M10	JD 21	FP-5102317	JD 70, 112
FP-3067618	JD 130	FP-4004M20	JD 21	FP-5102318	JD 70, 112
FP-3069098	JD 130	FP-4005M	JD 21		
FP-3069177	JD 130	FP-4005M10	JD 21		
FP-3069672	JD 130	FP-4005M20	JD 21		
FP-3070136	JD 130	FP-4039A	JD 51, JDI 9		

# Numerical List



Part No.	Line No.	Part No.	Line No.	Part No.	Line No.
FP-5102319	JD 70, 112	FP-5150291	JD 70, 112	FP-531TOHK	JD 123
FP-5102648	JD 70, 112	FP-5150292	JD 70, 112	FP-5362KX	JD 3
FP-5103903	JD 70, 112	FP-5150302	JD 4, 70, 112	FP-5362KX40	JD 3
FP-5104019	JD 112	FP-5150303	JD 4, 70, 112	FP-5444KX	JD 39
FP-5104081	JD 70	FP-5150314	JD 4, 70, 112	FP-5504KX	JD 13-15
FP-5104701	JD 4, 70, 112	FP-5150325	JD 70, 112	FP-5504X	JD 13-15
FP-5108918	JD 4	FP-5151601	JD 4, 70, 112	FP-5589KX	JD 7, 46, 47, 81, 82
FP-5108919	JD 4	FP-5154472	JD 70, 112	FP-5607KX	JD 21
FP-5109925	JD 4	FP-5157274	JD 70, 112	FP-5809KX	JDI 1
FP-5111337	JD 4, 70, 112	FP-5159353	JD 70, 112	FP-5809KX20	JDI 1
FP-5111339	JD 112	FP-5159353S	JD 70, 112	FP-5809KX40	JDI 1
FP-5111423	JD 70, 112	FP-5160542	JD 70, 112	FP-5809KX60	JDI 1
FP-5111424	JD 70	FP-5180250	JD 4, 70, 112	FP-5832KX	JD 25
FP-5111467	JD 70, 112	FP-5184484	JD 70, 112	FP-5834KX	JD 36, 71
FP-5114335	JD 70, 112	FP-5185325	JD 70, 112	FP-5835KX	JD 8
FP-5115454	JD 70, 112	FP-5185327	JD 70, 112	FP-58952	JD 95, 98, 113, 114
FP-5116072	JD 4	FP-5186858	JD 4, 70, 112	FP-5923KX	JD 13-15
FP-5116128	JD 4	FP-5188405	JD 70, 112	FP-6068DIFK	JDI 21
FP-5116137	JD 4	FP-5188406	JD 70, 112	FP-6068DOHK	JDI 21
FP-5116140	JD 4	FP-5189054	JD 70, 112	FP-6068TIFK	JD 106, JDM 7
FP-5116181	JD 4	FP-5192111	JD 70, 112	FP-6068TOHK	JD 106, JDM 7
FP-5116189	JD 4	FP-5192496	JD 70, 112	FP-6076A	JD 116, JDI 30, JDM 9
FP-5116196	JD 4	FP-5192717	JD 70, 112	FP-6076ADP	JD 116, JDI 30, JDM 9
FP-5116197	JD 4	FP-5192718	JD 70, 112	FP-6076EIFK	JD 115, 116, JDI 29, 30, JDM 9
FP-5116197S	JD 4	FP-5192874	JD 70, 112	FP-6076EOHK	JD 115, 116, JDI 29, 30, JDM 9
FP-5116198	JD 4	FP-5192875	JD 70, 112	FP-6076LIFK	JD 115, 116, JDI 29, 30, JDM 9
FP-5116224	JD 4	FP-5192876	JD 70, 112	FP-6076LOHK	JD 115, 116, JDI 29, 30, JDM 9
FP-5116229	JD 4	FP-5192877	JD 70, 112	FP-617X	JD 6, 9
FP-5116336	JD 4	FP-5192878	JD 70, 112	FP-619EIFK	JD 127, JDI 42
FP-5116341	JD 4	FP-5192922	JD 70	FP-619EOHK	JD 127, JDI 42
FP-5116354	JD 4	FP-5192923	JD 112	FP-619LIFK	JD 127, JDI 42
FP-5117562	JD 70, 112	FP-5193197	JD 70, 112	FP-619LOHK	JD 127, JDI 42
FP-5117563	JD 70, 112	FP-5193316	JD 70, 112	FP-619MIFK	JD 127, JDI 42
FP-5117564	JD 70, 112	FP-5193477	JD 70, 112	FP-619MOHK	JD 127, JDI 42
FP-51175646	JD 112	FP-5193666	JD 70, 112	FP-628CP	JD 5
FP-5117565	JD 70, 112	FP-5193732	JD 70, 112	FP-628CP20	JD 5
FP-5117629	JD 70, 112	FP-5193733	JD 70, 112	FP-628CP30	JD 5
FP-5120930	JD 70, 112	FP-5193734	JD 70, 112	FP-628CP40	JD 5
FP-5121071	JD 70, 112	FP-5193735	JD 70, 112	FP-628CP60	JD 5
FP-5121254	JD 4	FP-5193738	JD 70, 112	FP-644KX	JD 48
FP-5121256	JD 4	FP-5193739	JD 70, 112	FP-645KX	JD 69
FP-5123250	JD 4, 70, 112	FP-5193741	JD 70, 112	FP-66292	JD 130
FP-5123700	JD 70, 112	FP-5194073	JD 70, 112	FP-6632M	JD 21
FP-5124458	JD 70, 112	FP-5194163	JD 70, 112	FP-6632M10	JD 21
FP-5127821	JD 70, 112	FP-5194164	JD 70, 112	FP-6632M20	JD 21
FP-5128640	JD 4, 70, 112	FP-5194826	JD 70	FP-6632M30	JD 21
FP-5128917	JD 4	FP-5194827	JD 70	FP-671NA	JD 112
FP-5129101	JD 70, 112	FP-5195931	JD 4	FP-671NAOH	JD 112
FP-5129919	JD 4, 70, 112	FP-5195948	JD 4	FP-671XH	JD 112
FP-5130881	JD 70, 112	FP-5196022	JD 70, 112	FP-671XHOH	JD 112
FP-5131329	JD 70, 112	FP-5196026	JD 70, 112	FP-6712V	JD 112
FP-5131961	JD 4	FP-5196755	JD 4	FP-6712VOH	JD 112
FP-5132383	JD 70, 112	FP-5196756	JD 4	FP-67946	JD 130
FP-5132803	JD 4	FP-5196843	JD 70, 112	FP-68365	JD 130
FP-5132803WS	JD 4	FP-5196852	JD 4	FP-68445	JD 130
FP-5143108	JD 70, 112	FP-5196927	JD 70, 112	FP-68910	JD 130
FP-5143406	JD 70	FP-5197167	JD 70, 112	FP-69521	JD 130
FP-5143407	JD 112	FP-5197860	JD 70, 112	FP-69736	JD 130
FP-5144019	JD 4	FP-5198230	JD 70, 112	FP-70550	JD 130
FP-5144495	JD 70, 112	FP-5198431	JD 4	FP-70772	JD 130
FP-5144744	JD 70, 112	FP-5198468	JD 4	FP-7079X	JDI 1
FP-5144846	JD 70, 112	FP-5198469	JD 4	FP-7079X30	JDI 1
FP-5145172	JD 4	FP-5198502	JD 4	FP-7079X40	JDI 1
FP-5147347	JD 70, 112	FP-5198503	JD 4	FP-864340979	JD 51-53, 63, 68, 83-86, JDI 9-11, 17
FP-5147424	JD 4	FP-5198822	JD 4	FP-8921209	JD 4, 70, 112
FP-5148373	JD 70, 112	FP-5198877	JD 4	FP-8921501	JD 4
FP-5148399	JD 70, 112	FP-5198899	JD 4	FP-8922221	JD 70, 112
FP-5148440	JD 70, 112	FP-519889910	JD 4	FP-8922516	JD 70, 112
FP-5148472	JD 70, 112	FP-5198903	JD 4	FP-8923554	JD 4, 70, 112
FP-5148475	JD 70, 112	FP-519890310	JD 4	FP-8923814	JD 4, 70, 112
FP-5149234	JD 70, 112	FP-519890320	JD 4	FP-8924083	JD 70, 112
FP-5149261	JD 70, 112	FP-5198904	JD 4	FP-8924084	JD 70, 112
FP-5149263	JD 70, 112	FP-519890410	JD 4	FP-8924354*	JD 4, 70, 112
FP-5149264	JD 70, 112	FP-519890420	JD 4	FP-8924355	JD 4, 70, 112
FP-5149386	JD 70, 112	FP-5199809	JD 4	FP-8924357	JD 4
FP-5149393	JD 112	FP-5199871	JD 70, 112	FP-8924358	JD 4
FP-5149452	JD 4	FP-531AIFK	JD 123	FP-8924359	JD 4
FP-514945240	JD 4	FP-531AOHK	JD 123	FP-8924360	JD 4
FP-5149454	JD 4	FP-531DEIFK	JD 122	FP-8924361	JD 4
FP-5149455	JD 4	FP-531DEOHK	JD 122	FP-8924439	JD 4, 70, 112
FP-5149456	JD 4	FP-531DLIFK	JD 122	FP-8925981	JD 4, 70, 112
FP-5149944	JD 4	FP-531DLOHK	JD 122	FP-8926351	JD 70, 112
FP-5150289	JD 70, 112	FP-531TIFK	JD 123		

Part		Part		Part	
No.	Line No.	No.	Line No.	No.	Line No.
FP-8927920	JD 70, 112	W-5039KX	JD 21		
FP-920KX	JD 45	W-5051KX 20	JD 5		
FP-920X	JD 45	W-5051KX 30	JD 5		
FP-92351	JD 130	W-5051KX 60	JD 5		
FP-925740979	JD 18, 23, 31, 37, 38, 41, 50-53, 63, 65, 67, 83, 84, JDI 8-11, 16	W-5051X	JD 5		
		W-5051X 30	JD 5		
FP-925750411	JD 98, 99, 113, 114, JDI 28	W-5504KX	JD 13-15		
FP-9259KX	JD 25	W-5809KX	JDI 1		
FP-926KX	JD 21	W-5834KX	JD 36, 71		
FP-926X	JD 21	W-5835KX	JD 8		
FP-9320CP	JD 21	W-5923KX	JD 13-15		
FP-9320CPA	JD 21	W-644KX	JD 48		
FP-9320CPA10	JD 21	W-920KX	JD 45		
FP-9320CPA2	JD 21	W-920X	JD 45		
FP-9320CPA20	JD 21	W-9259KX	JD 25		
FP-9320CPA30	JD 21	W-934KX	JD 19		
FP-9320CPA40	JD 21	W-934X	JD 19		
FP-9320CP10	JD 21	W-9348KX+	JD 59, 60, 94-96, 98, 99		
FP-9320CP20	JD 21	1394+	JD 5, 19, JDI 1		
FP-9320CP30	JD 21	1454M	JD 44		
FP-9320CP40	JD 21	1473M	JD 44		
FP-9324X	JD 21	2134Y	JD 44		
FP-934KX	JD 19	222-495	JD 44		
FP-934KX20	JD 19	223-291	JD 44		
FP-934KX30	JD 19	224-4165C	JD 44		
FP-934KX60	JD 19	2375CP	JD 44		
FP-935550411	JD 98, 99, 114, JDI 28	244NP	JD 44		
FP-939840979	JD 10, 12, 41, 72, 73, 77, 78	245-1437-3	JD 21		
FP-944840979	JD 23, 27, 41, 50-53, JDI 2, 4, 6, 8-11	245-1437-3N	JD 21		
		245-1625-1	JD 21, 59, 94		
FP-9620CPA	JD 43, 48	245-1625-1N	JD 21		
FP-9620CPA10	JD 43, 48	259-103C	JD 44		
FP-9620CPA20	JD 43, 48	260-1004	JD 44		
FP-9620CPA30	JD 43, 48	260-1256	JD 112		
FP-9624CPA10	JD 43, 48	260-1355	JD 21		
FP-9624CPA20	JD 43, 48	260-1385	JD 10, 12		
FP-9624CPA30	JD 43, 48	260-1386	JD 31, 37		
FP-9624X	JD 43, 48	260-1387	JD 18		
FP-9759*	JD 34, 35, 75, 76, 111	260-1392	JD 41, 42, 50, 51, 67, 68, JDI 8, 9		
FP-9811BF	JD 21	260-1395+	JD 60		
FP-9811BFA	JD 21	260-1398	JD 98		
FP-9981KX	JDI 1	260-1399	JD 96		
KC-380	JD 44	260-1400	JD 113, 114		
MV-1771	JD 44	3160CP	JD 45		
MV-1771C	JD 44	3695RA	JD 44		
MV-1918	JD 44	39952	JD 51		
RP-3036	JD 44	4092M	JD 44		
SL-14M	JD 21	453A	JD 19		
SL-15M	JD 19	5070M	JD 44		
SL-22M	JD 3	6-2375CP	JD 44		
SL-22Y	JD 3	6-3695RA	JD 44		
ST-2001	JD 8, 13-15, 25, 39, 70	8649V	JD 21		
ST-2001BC	JD 8, 13-15, 25, 39, 70	8649V20	JD 21		
ST-2004	JD 46, 47, 59, 81, 82, 94	8649XA	JD 21		
ST-2004BC	JD 46, 47, 59, 81, 82, 94	8649XAS	JD 21		
ST-2007	JD 122	9759+	JD 34, 35, 75, 76, 111		
ST-2011	JD 60, 95				
ST-2011BC	JD 60, 95				
VG-5073	JD 44				
VG-855	JD 19				
VK-115	JD 19				
VK-115B	JD 19, 70, JDI 1				
VK-115R	JD 19, 70, JDI 1				
VK-138B	JD 10, 12, 18, 23, 27, 28, 31, 37, 38, 41, 42, 50, 51, 54-56, 60, 67, 68, 72, 73, 77, 78, 85-87, 95, 96, 98, 99, 109, 110, 113, 114, JDI 2, 3, 8, 9, 16, 17, 26, 27				
	JDI 42				
VK-140	JD 4, 19				
VK-144	JD 4, 5, 19, 21, 70, 112, JDI 1				
VK-144R	JD 44				
VK-174	JD 44				
VK-174R	JD 44				
VK-63	JD 8, 13-15, 25, 39, 70				
VK-66R	JD 3, 7, 34-36, 44, 46, 47, 59, 60, 81, 82, 94, 95				
VS-510	JD 44				
V-1434	JD 44				
WE-196K	JD 44				
WE-196X	JD 44				
WE-323KC	JD 21				
WE-323X	JD 21				
W244NP	JD 44				

# FIND ALL THE PARTS YOU NEED

## Look Up Any Part, Any Time. [www.FMe-cat.com](http://www.FMe-cat.com)

FMe-cat is the online solution that offers fast, easy access to virtual catalog pages covering thousands of FP Diesel® replacement engine parts for commercial vehicles. The interactive catalog simplifies the process of locating engine components for medium- and heavy-duty applications and enables users to easily navigate in a virtual catalog environment.

The user-friendly interface always features the most complete product offering and latest coverage data.

### A variety of lookup tools will help you, whatever information you may have:

**Application Lookup** – By make, engine code, engine

**Part Number Lookup** – By inputting the part number

**Interchange Lookup** – By inputting a competitor or OEM's part number

### This helpful online tool also provides:

- Personal Parts List
- Technical Tips and Product Bulletins
- Digital Catalogs
- New Number Announcements
- Newsletters

## Order All The Parts – With Just One Call!

Many FP Diesel® Engine Kits have several variations in components available, depending on the specific engine. Overhaul Kits are designed to contain all the parts necessary to rebuild a particular engine. To assure that the kit is correct and complete, reference the “How To Order Overhaul and In-frame Kits” guide found on page XII in the front section of this catalog.

This information enables your FP Diesel service representative to configure the Engine Kit to your particular requirements, ensuring that everything is properly accounted for. In cases where there are no variable components, we have pre-configured the kits to include all the necessary parts for that application.



**800.237.7425**

*HOURS: 8 am-6:30 pm EST, 7 am-5:30 pm CST,  
6 am-4:30 pm MST, 5 am-3:30 pm PST*



**FMe-cat.com**  
Your 24/7 FP Diesel®  
Resource

Available 24/7, the interactive e-Catalog features a highly intuitive interface and advanced functionality that enables distributors and repair professionals to access the latest and most complete product data and to quickly and easily find the right FP Diesel® components. The catalog's comprehensive interchange and numerical lookup tools help identify the correct part even when complete application information is not available.



Part Type	Part Number	Qty	Comments
Complete Overhaul Kit	<a href="#">FP-239D-OHK</a>	1	w/Con. Rod marked R80034; Incl. front & rear seals; Crankshaft codes 4702, 4708, 4710; Con. Rod codes 4801, 4802; Incl. Torque-To-Yield con. rod bolts
In-Frame Overhaul Kit	<a href="#">FP-239D-IFK</a>	1	w/Con. Rod marked R80034; Incl. front & rear seals; Crankshaft codes 4702, 4708, 4710; Con. Rod codes 4801, 4802



Flip through virtual paper catalogs

Download the latest new product announcements



Access new number bulletins

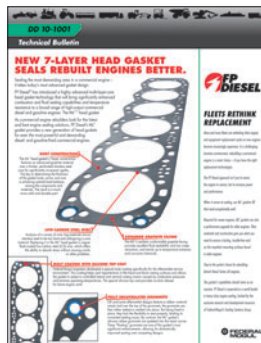

Get the latest technology bulletins



Get your copy of "The Source" newsletter

Visit **FMe-cat.com** and click on the **Commercial vehicle!**





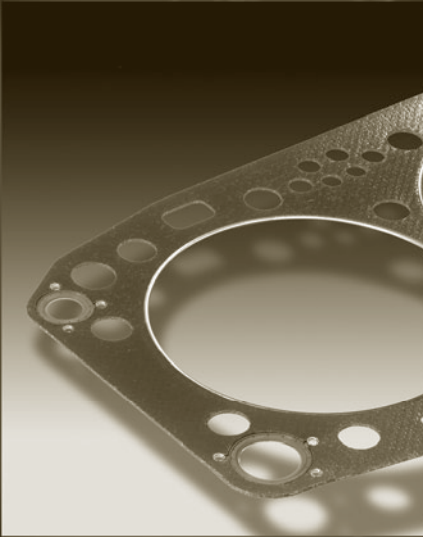

## FP Diesel ML<sup>7</sup>™ Head Gaskets

- Patented multi-layer design provides unprecedented strength
- Expanded graphite outer facings fills in minor voids in sealing surfaces
- Stainless steel armors provide robust, long lasting combustion seal
- Solid steel core provides enhanced lateral stability



## Valvetrain Components

- Manufactured to the highest quality standards
- OEM specification materials used with upgrades to super alloys such as stellite, nickel, nimonic and inconel where needed for problem applications
- Available parts include valves, springs, guides, keepers, rotocaps, rocker parts, lifters, seals, seats and more



Commercial, Ag  
and Industrial

## [www.FMe-cat.com](http://www.FMe-cat.com)

- Commercial vehicle electronic catalog – available at [www.FMe-cat.com](http://www.FMe-cat.com)
- User friendly interface features the most complete product offering and latest coverage data
- Online solution offers fast, easy access to virtual catalog pages covering the thousands of FP Diesel<sup>®</sup> components
- Eases locating components for heavy-duty applications and enables users to accurately navigate in a virtual catalog environment of commercial vehicles

**GLOBAL TECHNOLOGY** behind every part